

NEW
CE

OMRON

**Faster and more powerful
than anything in its class!**

F160-2

Vision Sensor

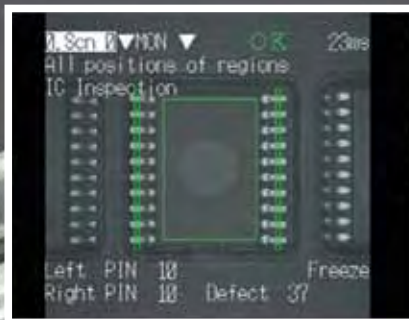

Great Performance from a Sensor with No Blind Spots



The development of the F160 represents the arrival of a remarkable vision sensor that answers the needs of today's inspection line. It has the processing speed required for ultra high-speed lines and, using memory cards, has the capacity required for multi-product lines. Choose from a comprehensive selection of cameras for just the right type of inspection, and customize screens and operations to ensure optimum on-site operability. Initial setup can be performed even by inexperienced operators thanks to user-friendly conversational menus, and inspection performance has been comprehensively improved using new algorithms.

All of OMRON's technology and know-how has come together to bring you the optimum vision sensor - the F160, a sensor you can use with confidence.

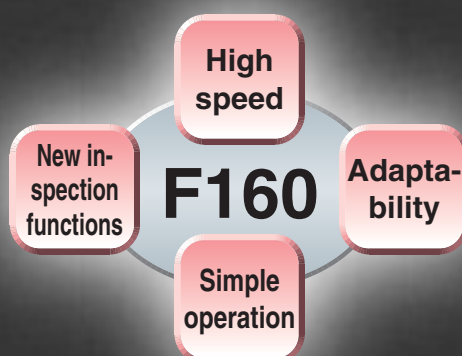

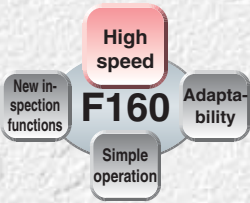

Creating New Possibilities with Incredible Speed

The F160 can be applied to ultra high-speed lines. It allows a greater range of inspections within the required tact time, contributing greatly to the improvement of inspection quality.

The newly-developed Double-speed Camera allows images to be captured up to 4 times faster than with previous cameras, and image processing can now be achieved 2 to 10 times faster than before. For example, gray search for the image shown in Picture 1 below can be performed for 5,000 items-a-minute inspection lines. Also, because each individual inspection is made at high speed, the total inspection time for complicated applications has been dramatically reduced. This creates extra time for inspections that were not possible before, leading to significant improvements in inspection quality.

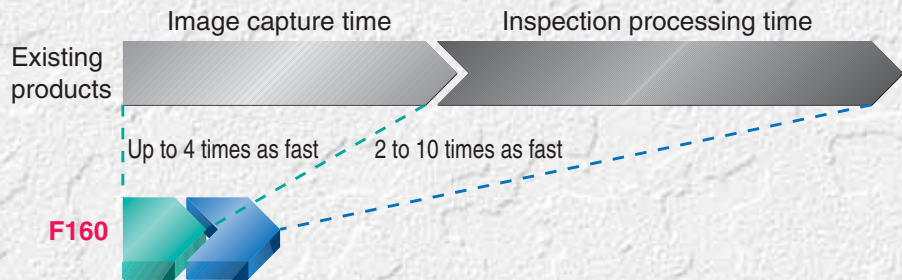

• Example: Gray Search Processing (Picture 1)



• Example: More than one inspection item

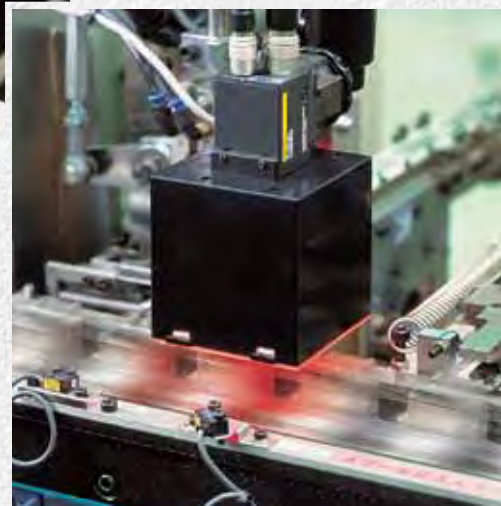
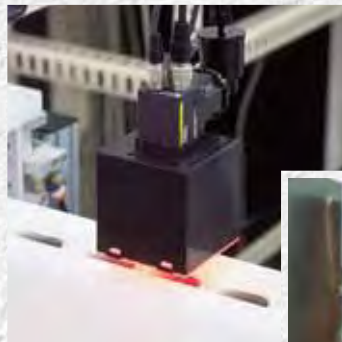

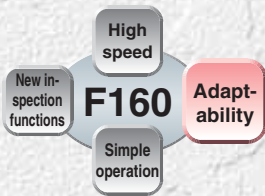

Use in a Wide Variety of Applications with a Greatly Reduced Installation Time

■ Data-handling Capacity Increased with Memory Cards

The F160 enables reductions in setup costs and allows a greater number of scenes to be used. The F160 is equipped with a memory card slot that allows the number of available scenes to be increased simply by inserting a card.

Note: The actual number of scenes that can be saved depends on the scene settings.

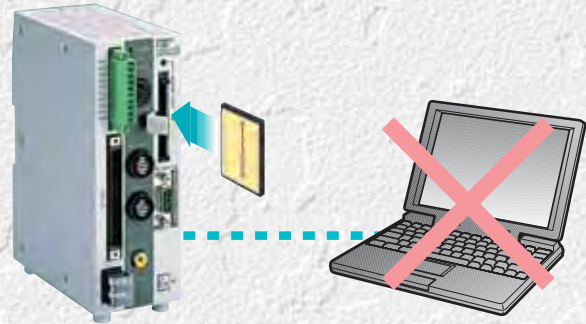

■ Increased Functionality for Storing Images

Up to 35 screens of measurement images and improper images (i.e. images of improper products) can be stored. Also, because the most recent improper image can be viewed while performing measurement, problems in the inspection line can be analyzed without stopping production.



■ I/O Monitor

The status of input and output terminals can be displayed on the screen. This function can be used for checking wiring when making adjustments to the system.



■ Screen Capture

Images of menu setting screens, measurement screens, and improper images can be captured and stored in the memory card. This feature is very useful for creating documentation.

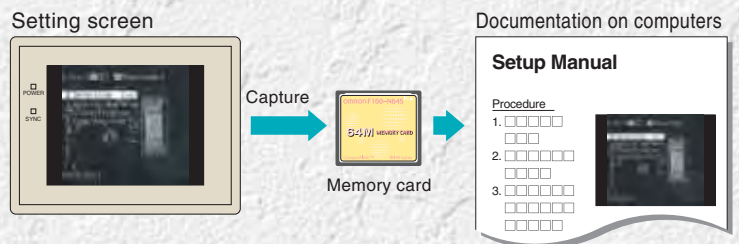

A Wide Variety of Cameras

OMRON's Double-speed Cameras, F150 Cameras, or F200/F300 Cameras can be connected. Use the Camera that meets your speed, cost, and lighting requirements.

● Double-speed Camera

F160-S1/S2/SLC20/SLC50



The shutter speed can be set to one of 8 settings from the Controller. Cameras with intelligent lighting are also included in the lineup.

● F150 Camera

F150-S1A/SLC20/SLC50/SL20A/SL50A



Compact and cost-effective. Models with intelligent lighting or compact LED lighting are available.

● F200/F300 Camera



Existing cameras can be used by just moving them from the F200/F300 to the F160.

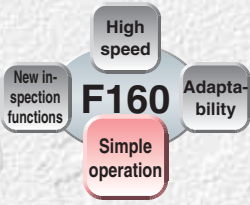

Customize Operations, Screens, and Output to Suit Your Requirements

Operations

■ Menu Masking

Incorrect operation can be prevented by masking menu items for settings that must not be changed. This function also simplifies the operations required to change menu settings and helps save time.

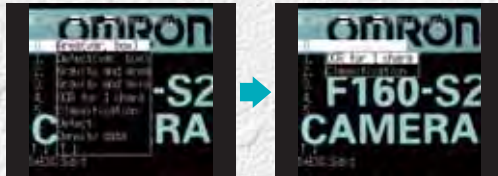

■ Password Setting

Passwords can be set to restrict the personnel allowed to operate the F160. This function helps to improve security and reduce incorrect operation.



■ Shortcut Keys

Frequently used operations can be allocated to specific console keys. Menus can be switched at the touch of a button.

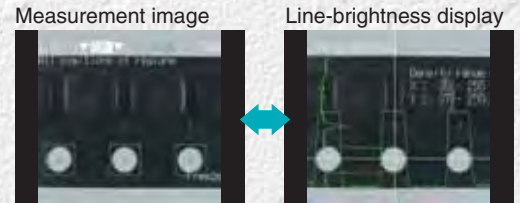

Screens

■ Screen Messages

Screen messages can be changed to suit the on-site environment and can be displayed in any desired position on the screen.



■ Drawing Figures

Figures such as lines, boxes, circles, and cross cursors can be drawn. It is also possible to draw these figures at measurement positions.



■ It is possible to select the character-size and the display can be black-white inverted.



■ Color Display

Messages and figures can be made easier to view by using different colors.



Output

■ RS-232C Format

The output format can be changed to suit system specifications.



■ Conversational Menus

The F160 also has menus designed in a conversational style so that even personnel with little experience can perform settings with ease.



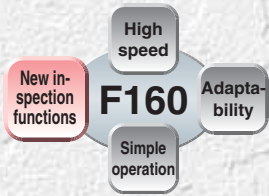

Inspection Revolutionized with New Algorithms

■ QUEST Character Recognition

The F160 uses OMRON's character recognition system - QUEST.

Features

- The user does not have to register characters.
- High-level of discrimination of similar characters.
- Adapts to fluctuations in shape and size.

Use for any type of character

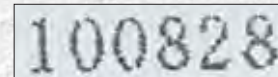
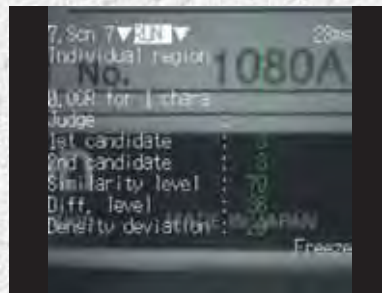

■ "Variable Box" Measurement for Defect Inspection

The measurement region can be set to change automatically when performing inspections for objects with varying sizes, such as electronic chip components. This feature ensures that the optimum measurement regions are always used for inspection.

Setting screen

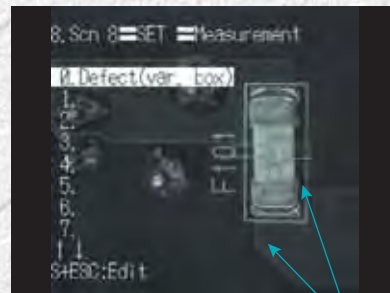

Set frames for adjusting the region size.

Measurement screen

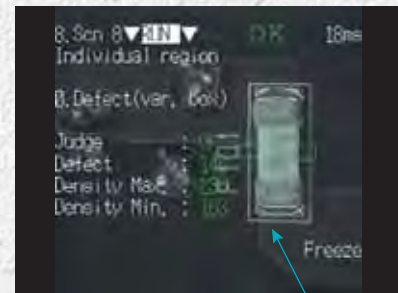

The inspection region automatically adapts to the object size.

■ Flexible Search

Using this method, matching is performed using more than one reference image and so the F160 can perform inspection for objects with varying shapes. This feature helps to reduce incorrect judgements.



Matching can be performed for products with varying shapes by using more than one reference image.

A Variety of Functions Accessible with Easy-to-Use Menus

■ Rotation Search

Using this method, search is performed while the image is rotated. Processing is performed 10 times faster than with existing models. Using angle interpolation, it is possible to detect angles with a high degree of precision.

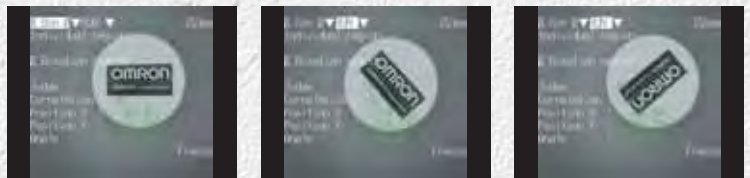

Example: Searching in a rotation range of 360° with a skipping angle of 5°.

■ Classification

A search is performed for more than one model, and the model number with the highest correlation is output. The flexible search function can be used for applications involving objects with different shapes.

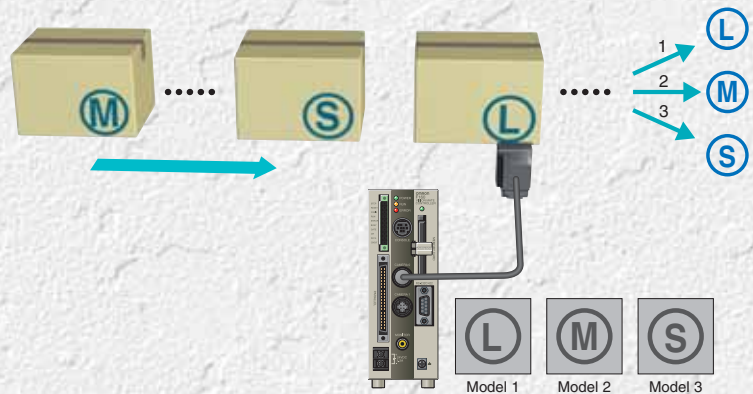

■ Edge Width

The positions of both edges of an object are detected with high accuracy, and from this the width of the object is calculated. It is not necessary to set expressions for calculating the width.



■ Labeling

The number of labels (i.e., objects) inside the measurement region is counted. After they have been sorted according to area or center of gravity, the measurement data for specified labels is output.



Counting gears



Inspecting the position and number of buttons

■ Position Displacement Compensation

With the F160, compensation using only the outline of the object, 2-stage position compensation, and setting priorities for the compensation direction are all possible.

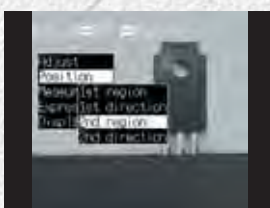

Compensation in the X direction followed by compensation in the Y direction.

■ Expressions

Judgement and data output based on a maximum of 32 expressions is possible. Up to 32 variables (representing other expressions) can be used, enabling more complex calculations.



System Configuration

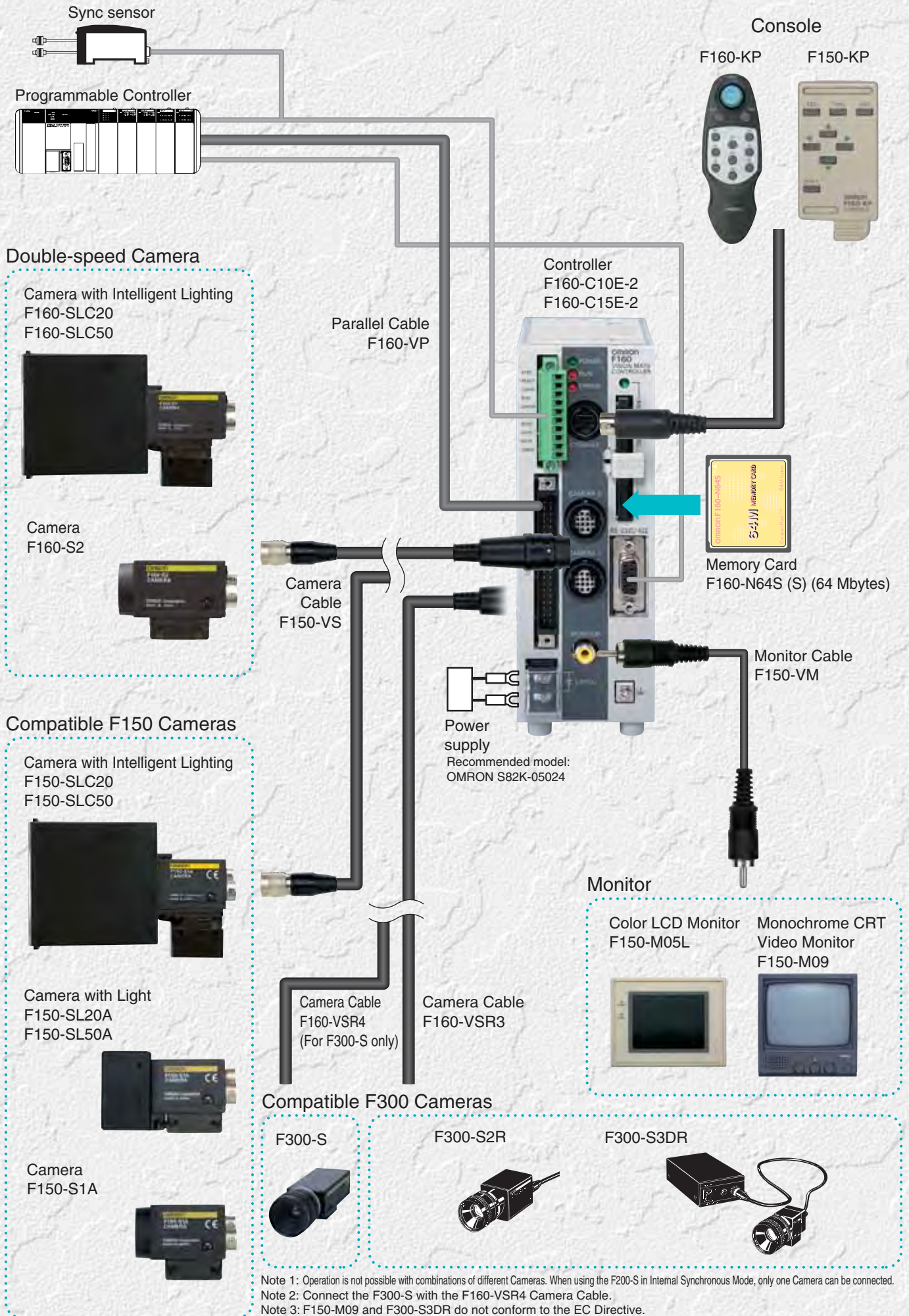

Standard Models

Name		Model number	Comments
Controller		F160-C10E-2	NPN input/output
		F160-C15E-2	PNP input/output
Double-speed Camera	Camera with Intelligent Lighting	F160-SLC20	
	Camera only	F160-S2	With partial function.
Compatible F150 Cameras	Camera with Intelligent Lighting	F150-SLC20	
		F150-SLC50	
	Camera with Light	F150-SL20A	
		F150-SL50A	
Camera only	F150-S1A		
Compatible F300 Cameras	Camera	F300-S	
	Shutter Camera	F300-S2R	
		F300-S3DR	With separable head.
Console		F160-KP	
		F150-KP	
Color LCD Monitor		F150-M05L	
Monochrome CRT Video Monitor		F150-M09	
Memory Card		F160-N64S (S)	Memory capacity: 64 Mbytes
Camera Cable		F150-VS	For Double-speed Camera and compatible F150 Cameras. Cable length: 3 m
		F160-VSR3	For compatible F200/F300 Cameras. Cable length: 3 m
		F160-VSR4	For F300-S only. Cable length: 3 m
Monitor Cable		F150-VM	Cable length: 2 m
Parallel Cable		F160-VP	Loose-wire cable for parallel I/O connectors. Cable length: 2 m

Specifications

■ Ratings/Functions

● Controller: F160-C10E-2/C15E-2

Item	Specifications	Conversational Menu Mode	Expert Menu Mode
Connectable Cameras		F150-S1A/SL20A/SL50A/SLC20/SLC50, F160-S2/SLC20/SLC50, F300-S/S2R/S3DR/S4R etc.	
Number of Cameras connectable		1	2
Number of pixels		512 x 484 (H x V)	
Number of scenes		32 (Expansion possible using Memory Card.)	
Image storage function		Maximum of 35 images stored	
Filtering		—	Smoothing (strong, weak), edge enhancement, edge extraction (horizontal, vertical, both horizontal and vertical), dilation, erosion, median, background suppression
Position displacement compensation	Set either automatically or manually Compensation directions: X, Y, and θ (360°) directions		Compensation directions: X, Y, and θ (360°) directions Detection methods: Binary center of gravity, axis angle, labeling, rotation search, gray search, edge position
Number of measurement regions		32 regions per scene	
Applications	7 types available (presence, orientation, dimensions, defects, conformity, position, chips and burs)		—
Measurement data	Automatically selected according to the application.		Gravity and area, gravity and axis, gray search, precise search, rotation search, flexible search, relative search, defect, area (variable box), defect (variable box), edge position, edge pitch, edge width, density average, labeling, OCR for 1 character, classification
Data operation functions (expressions)	—		Number : 32 expressions can be set for judgements, data, and variables used in other expressions Operations : Arithmetic operations, square root, absolute value, remainder, distance, angle, maximum, minimum, SIN, COS, ATAN, AND, OR, NOT
Results output	Overall judgements, judgements for each measurement region		Overall judgements, judgements for each measurement region, expression results, measurement/expression data
Functions for customizing operations	—		Menu masking, password setting, shortcut keys
Functions for customizing screens	—		Display items : Character strings (measurement values, judgement results, times, user-specified characters, measurement region names) Figures (lines, boxes, circles, cross cursors) Specified parameters : Display color, position, size
Number of slots for Memory Cards		1	
Monitor interface		1 channel (color, monochrome)	
Serial communications		RS-232C/422A, 1 channel	
Parallel I/O		13 inputs and 22 outputs including control I/O points	
	Input/ Output type	NPN	F160-C10E
		PNP	F160-C15E
Power supply voltage		20.4 to 26.4 VDC	
Current consumption		Approx. 1.6 A (with two F160-SLC50 Cameras connected)	
Ambient temperature		Operating: 0 to 50°C Storage: -25 to 65°C (with no icing or condensation)	
Ambient humidity		Operating and storage: 35% to 85% (with no condensation)	
External dimensions		56 x 160 x 110 (W x H x D) mm (not including connectors and other protruding parts)	
Weight		Approx. 570 g (Controller only)	

● Double-speed Camera: F160-S1/S2

Picture element	1/3" Interline CCD
Effective pixels	659 x 494 (H x V)
Scanning method	1/60-s non-interlace (frame) mode, 1/120-s 2:1 interlace (field) mode
Shutter	Electronic shutter; select from 8 shutter-speed settings (1/120 to 1/20,000 s) using menu.
Camera with Intelligent Lighting	F160-SLC20 (field of vision: 20 mm), F160-SLC50 (field of vision: 50 mm)
External dimensions	31 x 40 x 54.5 (W x H x D) mm (not including connectors and other protruding parts)
Weight	Approx. 85 g (Camera only)

● Monitor

Item	Name Model number	F150-M05L Color LCD Monitor	F150-M09 Monochrome CRT Video Monitor
Size		5.5 inches	9 inches
Type		Liquid crystal color TFT	CRT monochrome
Resolution		320 x 240 dots	800 TV lines min. (at center)
Input signals		NTSC composite video (1.0 V/75)	
Power supply voltage		20.4 to 26.4 VDC	100 to 240 VAC (-15%, +10%)
Current consumption		Approx. 700 mA	Approx. 400 mA
Ambient temperature		Operating: 0 to 50°C Storage: -25 to 65°C (with no icing or condensation)	Operating: -10 to 50°C Storage: -20 to 65°C (with no icing or condensation)
Ambient humidity		Operating or storage: 35% to 85% (with no condensation)	10% to 90% (with no condensation)
Weight (Monitor only)		Approx. 610 g	Approx. 4.5 kg
Accessories		Instruction manual and 4 mounting brackets	Instruction manual

Component Names and Functions

● F160-C10E-2/C15E-2

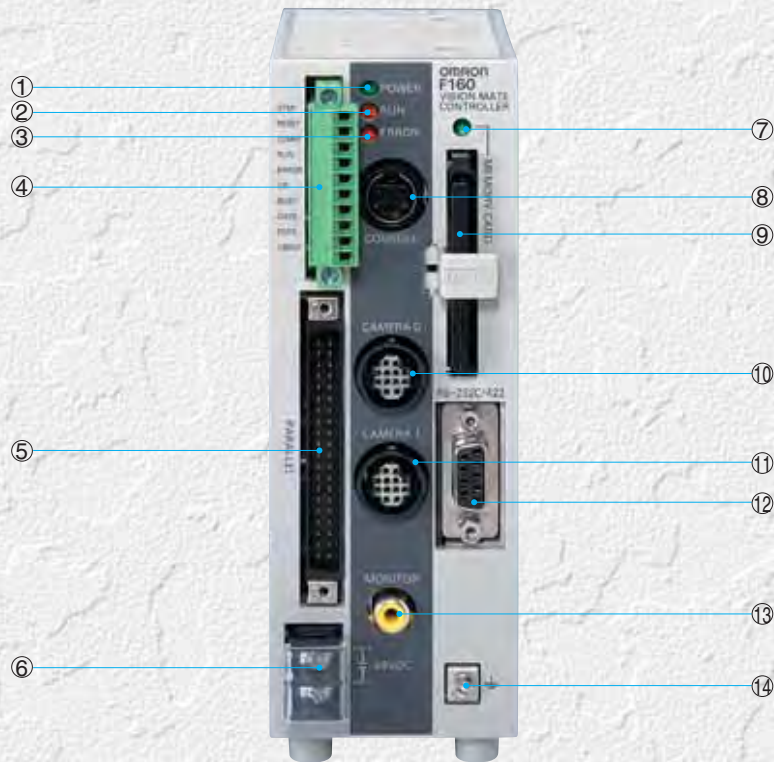

① **Power indicator**

Lit while power is ON.

② **RUN indicator**

Lit while the F160 is in Run Mode.

③ **ERROR indicator**

Lit when an error has occurred.

④ **I/O terminals (control lines)**

Connect the F160 to external devices such as sync sensors or PLCs.

⑤ **I/O connector (data lines)**

Connects the F160 to external devices such as sync sensors or PLCs.

⑥ **Power supply terminals**

Connect the power supply.

⑦ **Memory Card indicator**

Lit while power is supplied to the Memory Card.

⑧ **Console connector**

Connects the F160 to the Console.

⑨ **Memory Card slot**

Holds the Memory Card.

⑩ **Camera 0 connector**

Connects to Camera 0.

⑪ **Camera 1 connector**

Connects to Camera 1.

⑫ **RS-232C/422 connector**

Connects the F160 to an external device such as a computer or PLC.

⑬ **Monitor connector**

Connects to the Monitor.

⑭ **Ground terminal**

Connects to the ground wire

Menus

Menu Trees

Conversational Menu Mode

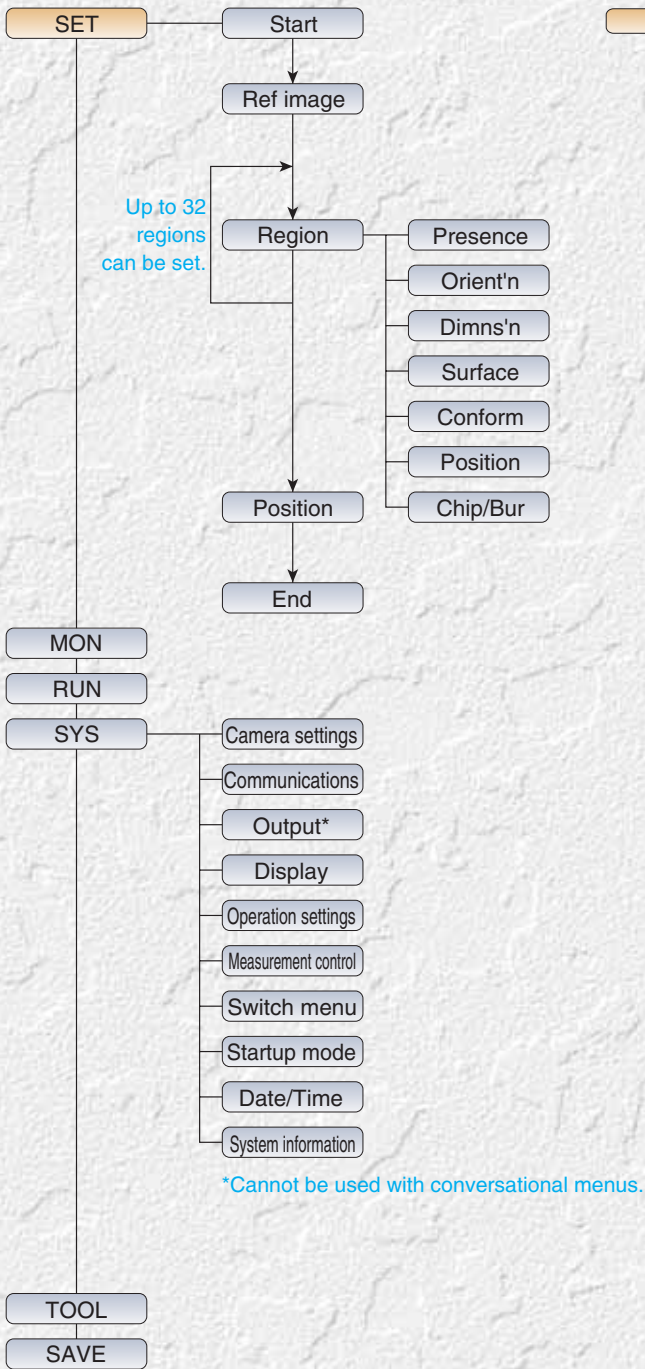

Expert Menu Mode

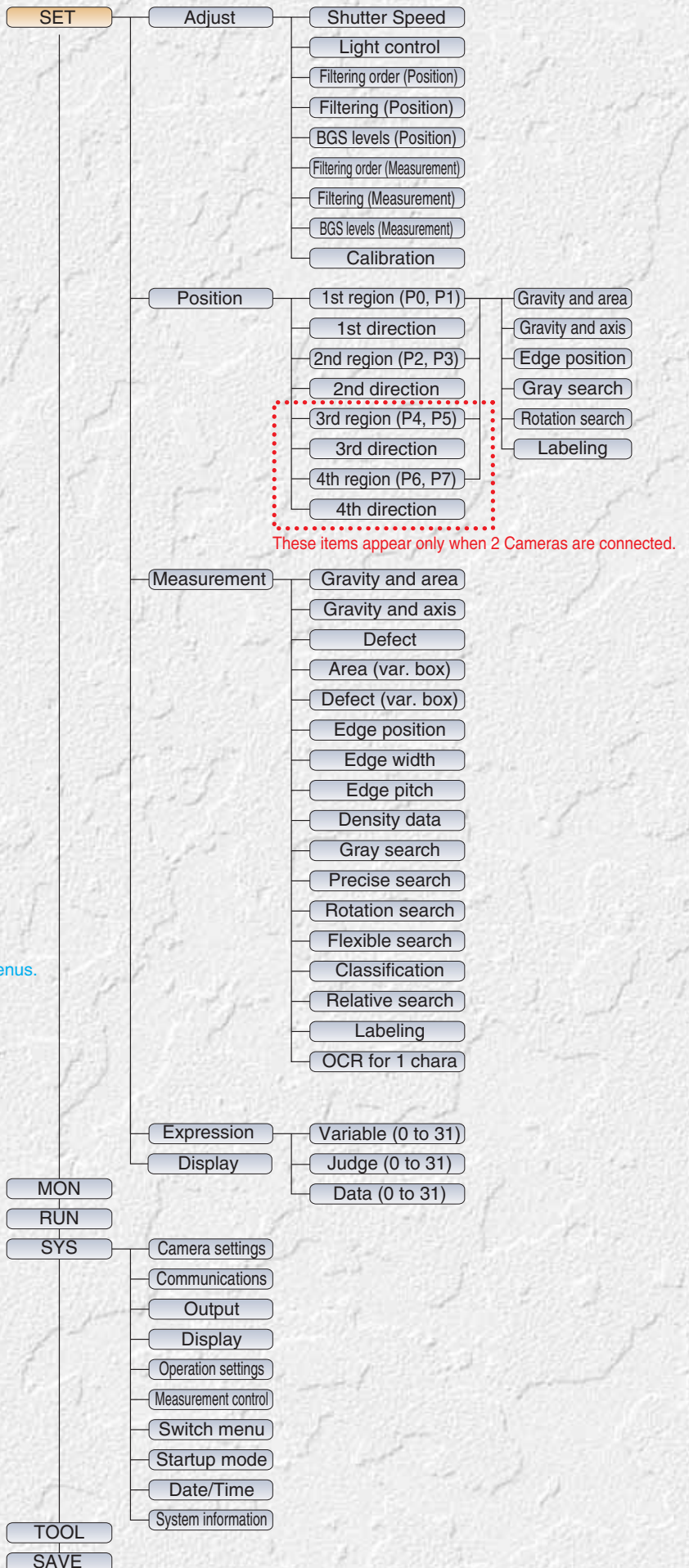

Dimensions (Unit: mm)

Controller

● F160-C10E-2/C15E-2

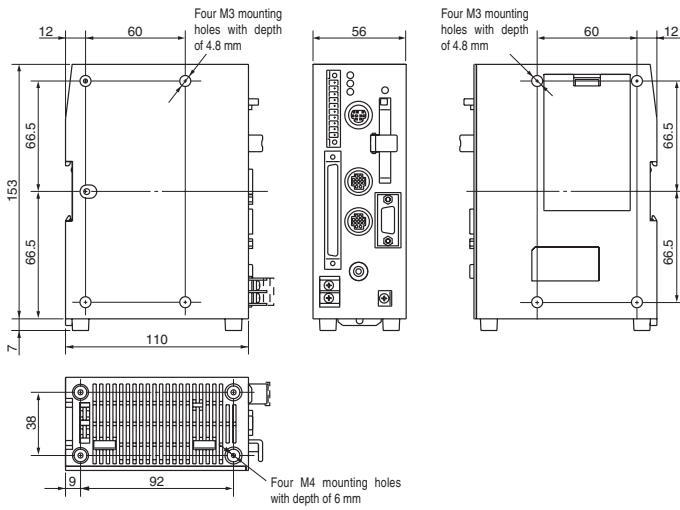

Console

● F160-KP

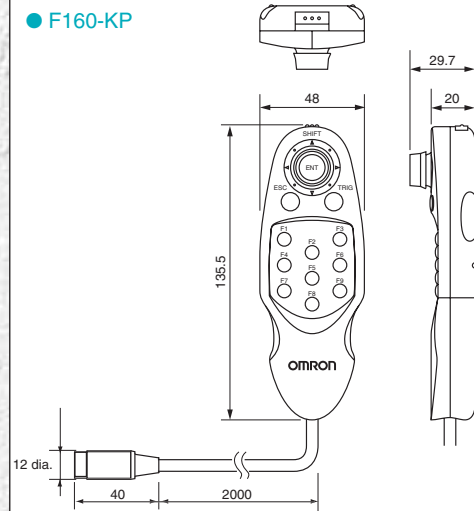

Double-speed Camera

● F160-S2

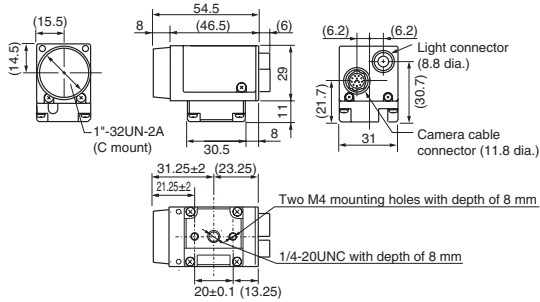

● F150-KP

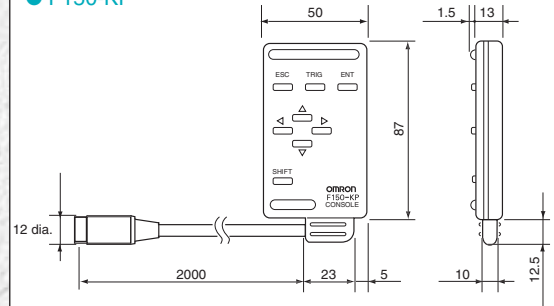

● F160-SLC20

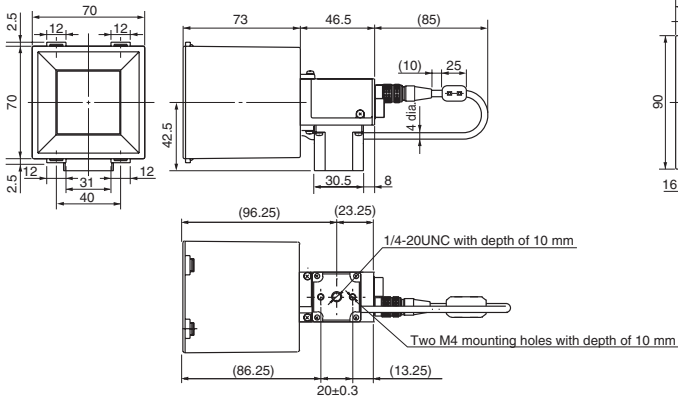

● F160-SLC50

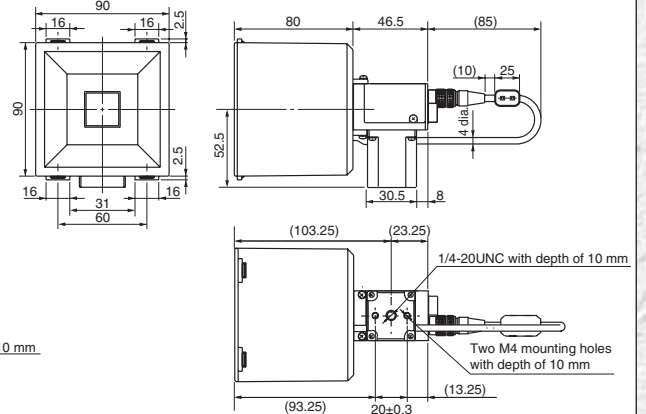

Liquid Crystal Monitor

● F150-M05L

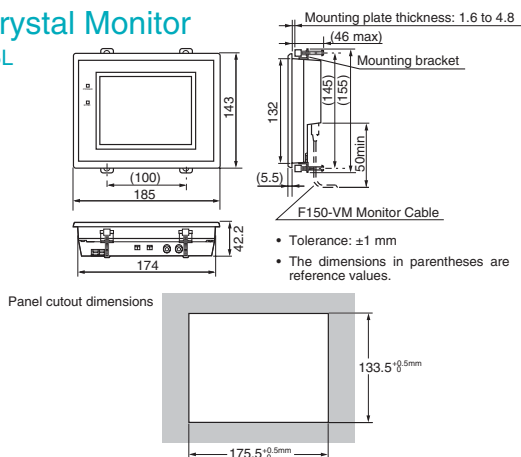

Video Monitor

● F150-M09

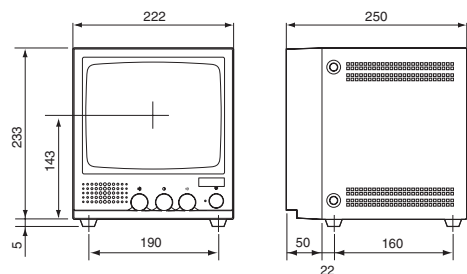

Lenses (for use with the F160-S1/S2 and F150-S1A only)

- With reference to the optical graph below, select the lens and combination of Extension Tubes that give the required field of vision and camera distance.

CCTV Lenses

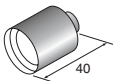
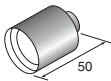
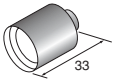
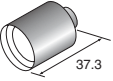
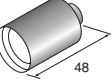
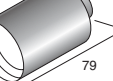
CCTV Lenses						
Model	3Z4S-LE C815B	3Z4S-LE B1214D-2	3Z4S-LE C1614A	3Z4S-LE B2514D	3Z4S-LE B5014A	3Z4S-LE B7514C
Dimensions	42 dia. 	42 dia. 	30 dia. 	30 dia. 	48 dia. 	62 dia. 
Locking mechanism	Focus locking mechanism					None

Extension Tubes

Model	Contents
3Z4S-LE EX-C6	A set of six Extension Tubes of thicknesses 40, 20, 10, 5, 1, and 0.5 mm respectively.

Meaning of Optical Graph

The X axis of the graph shows the field of vision L (mm), and the Y axis shows the camera distance A (mm). The curves on the graph indicate different lenses, and the "t" values indicate the lengths of the Extension Tubes.

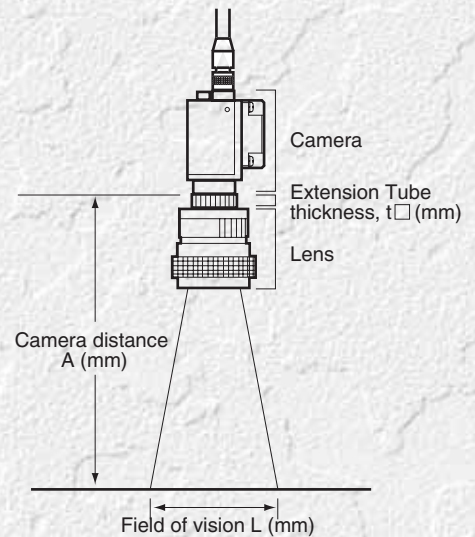

Optical Graph

- The values given in the optical graph are only approximate values. It is recommended that the camera distance is adjusted by sliding the Camera forward or backward to get the required field of vision for actual operation.

