

PCB-mounting Time Unit for High-frequency Applications

- Ideal for high-frequency applications with 1-ms reset time (including during operation) either for power resets or external resets.
- High repeat accuracy – $\pm 2\%$ including the initial value.
- Solid-state control output capability of up to 100 mA permits selection from a wide variety of output relays.
- Timer operation may also be controlled through an externally connected variable resistor.

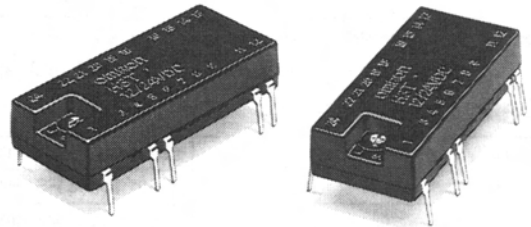

Ordering Information

| Operation/resetting system | Time-limit contact | Time ranges | Model |
|---|--------------------|-----------------------|-------|
| Time-limit operation/power-OFF resetting and external resetting Integrating operation/power-OFF resetting and external resetting OFF-delay operation by external signal/ Power-OFF resetting | Solid-state output | 1 s to 10 min (multi) | H3T-A |
| | | 6 s to 60 min (multi) | H3T-B |

- Note:**
1. Time specifications differ for H3T-A and H3T-B.
 2. The desired operation/resetting system is selected by short-circuiting and opening the specified terminals.
 3. A 24-pin IC socket can be used for mounting the time unit.
 4. The number of terminals differs from previous single time range units.

Specifications

Time Ranges

| Model | Max. scale time | Time setting range |
|---------------------|--------------------------------|--|
| H3T-A (4 multispec) | 1 s 10 s 1 min 10 min | 0.1 to 1 s 1 to 10 s 0.1 to 1 min 1 to 10 min |
| H3T-B (4 multispec) | 6 s 60 s 6 min 60 min | 0.6 to 6 s 6 to 60 s 0.6 to 6 min 6 to 60 min |

- Note:**
1. The above timing range applies to when the internal variable resistor of H3T is used.
 2. The external variable resistor may also be used by opening the terminals connected to the internal variable resistor.

■ Ratings

| | |
|--------------------------------|--|
| Rated supply voltage | 12 or 24 VDC, permissible ripple: 5% max. Switched by shorting and opening terminals. |
| Operating voltage range | 12 V: 90% to 110% of rated voltage 24 V: 80% to 110% of rated voltage |
| Power consumption | 12 V: Approx. 60 mW 24 V: Approx. 120 mW |
| Control output | Solid-state output: 100 mA Voltage drop: 1.2 V max. (see note 2) |

- Note:**
1. Residual voltage on reset input when shorted: 1.0 V.
 2. Contact output switching capacity: 100 mA, but rated coil current of relay loads must be 75 mA or less.

■ Characteristics

| | |
|-----------------------------------|--|
| Accuracy of operating time | ±2% max. (Percentage of FS value, including initial value) |
| Setting error | 0% to 100% FS (Percentage of FS value) |
| Reset time | 1 ms max. (including resets during operation) |
| Influence of voltage | ±2% max. (Percentage of FS value) |
| Influence of temperature | ±5% max. at -10°C to 70°C (Percentage of FS value) |
| Insulation resistance | 100 MΩ min. (at 250 VDC) |
| Dielectric strength | 500 VAC, 50/60 Hz for 1 min (between all terminals, knob and case) |
| Vibration resistance | Destruction: 10 to 55 Hz with 1.5-mm double amplitude Malfunction: 10 to 55 Hz with 1.5-mm double amplitude |
| Shock resistance | Destruction: 1,000 m/s ² (approx. 100G) Malfunction: 1,000 m/s ² (approx. 100G) |
| Ambient temperature | Operating: -10°C to 70°C (with no icing) Storage: -25°C to 80°C (with no icing) |
| Ambient humidity | Operating: 35% to 85% |
| Weight | Approx. 10 g |

Operation

■ Time Specifications and Terminals

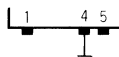
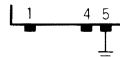
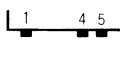
| Model | Terminals | | | |
|-------|---|---|--|---|
| |  |  |  |  |
| H3T-A | 1 s | 10 s | 1 min | 10 min |
| H3T-B | 6 s | 60 s | 6 min | 60 min |

- Note:**
1. Short terminals 21 and 22 when using the internal adjustment (variable resistor) in the H3T.
 2. An external resistor can be used by opening terminals 21 and 24. Connect the external resistor (2 M Ω for H3T-A and H3T-B) between terminals 21 and 24.

■ Timing Chart

Standard Operation

Outputs are produced when the set time is reached after power (S_4) is applied (to terminals 13 and 14 or terminals 13, 14, and 15). An external resistor can be connected between terminals 21 and 24; leave terminals 21 and 22 open (refer to following information on externally connected resistor and operation time). When performing an external reset, short-circuit terminals 1 and 13. The current will be approximately 1 mA, so any contacts that are controlled by the output must be highly reliable. When controlling a transistor, the I_{CEO} must be 0.1 mA and the $V_{CE(sat)}$ must be 1.0 V or less.

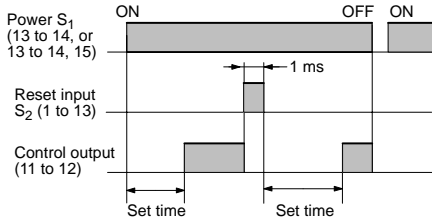

For 12 VDC, short-circuit the terminal section by the dotted line.

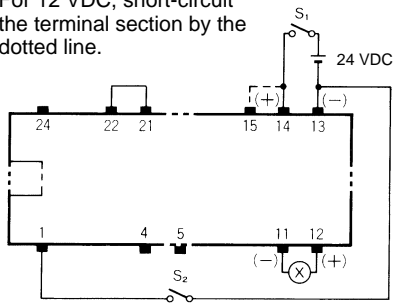

Note: Terminal 24 cannot be used.

When Connecting External Resistor

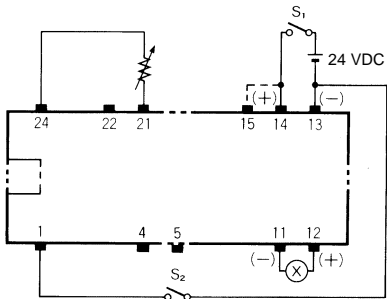

Note: Terminal 22 cannot be used.

Integration Operation

The variable resistor connection can be opened to interrupt the timer operation, thus enabling integration operation. Interrupt the timer operation by opening the connection between terminals 21 and 22 when using the interval variable resistor, or by opening the connection between terminals 21 and 24 when using an external resistor. Timer operation will continue when the connection is closed again.

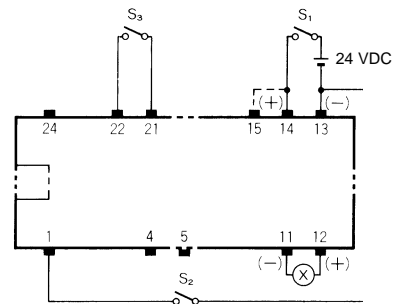
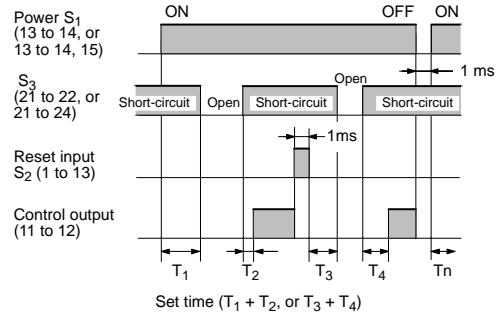

Note: Terminal 24 cannot be used.

When Connecting External Resistor

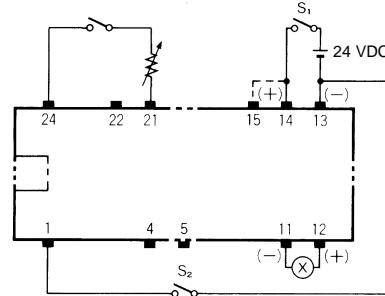

Note: Terminal 22 cannot be used.

OFF-delay Operation by External Signal

The Time Unit can be reset by applying a reset signal, enabling OFF-delay operation via an external signal. Short-circuit 1 and 13 and then open the connection to start the time-limit operation. An output will be made when the set time is reached. The current from terminal 1 to terminal 13 will be approximately 1 mA, so any contacts that are controlled by the output must be highly reliable. When controlling a transistor, the I_{CEO} must be 0.1 mA and the $V_{CE(sat)}$ must be 1.0 V or less.

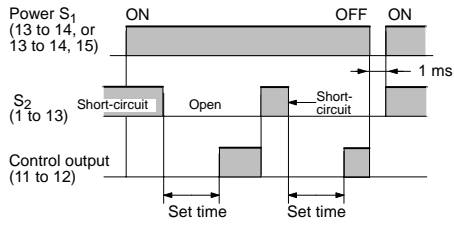

For 12 VDC, short-circuit the terminal section by the dotted line.

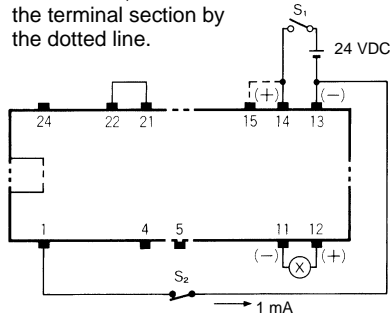

Note: Terminal 24 cannot be used.

When Controlling a Transistor

For 12 VDC, short-circuit the terminal section by the dotted line.

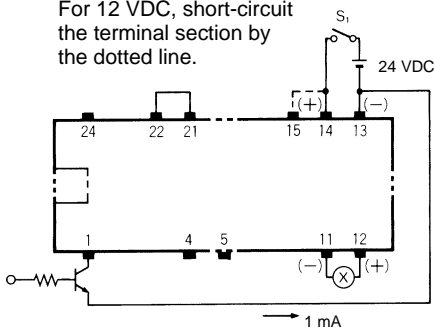

Note: Terminal 24 cannot be used.

External Resistor and Operate Time

When using an external resistor, refer to the characteristic diagrams shown below.

Use an external resistor rated at about 0.1 W/2 MΩ.

Pay attention to external noise and keep the lead length to less than 2 m.

Since the characteristic diagrams represent standard data, the operate time factory-setting may not always be uniform from one product to another.

Should higher timer precision be required, use of a variable resistor is recommended for time adjustment.

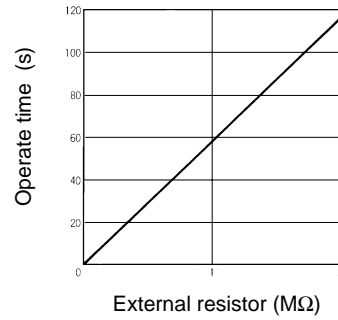

When Prolonging Reset Time

The time unit has a shorter reset time than conventional timers so that it can be used in combination with solid-state circuit. To prolong the reset time of the time unit while it is in operation to about 100 ms, connect a capacitor having the listed constant to the time unit as shown below.

| Rated voltage | Capacity of capacitor |
|---------------|-----------------------|
| 12 VDC | 10 μF, 25 V |
| 24 VDC | 4.7 μF, 50 V |

(Top View)

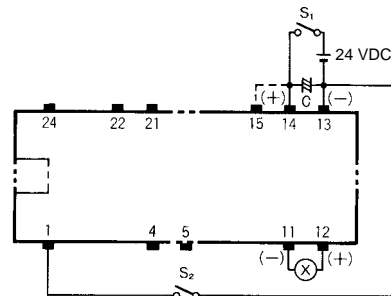

Note: For 12 VDC short-circuit the terminal section shown by the dotted line.

Dimensions

Note: All units are in millimeters unless otherwise indicated.

H3T

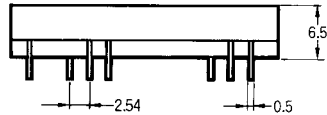
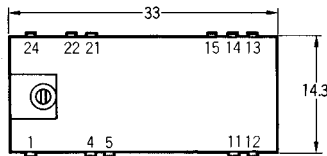
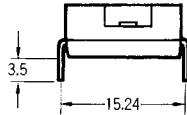
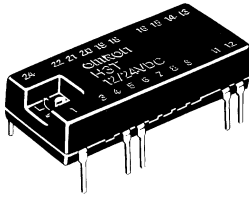

PCB Dimensions (Top View)

Applicable socket: XR2A-2401-N

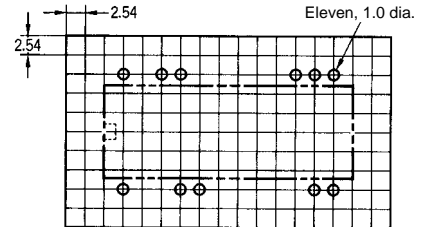

- Note:**
1. Terminal pitch: 2.54 mm
 2. Conventional models with only a single time range do not have terminals 4 and 5.

Installation

Internal Connections

When the input voltage is applied, the CR oscillator circuit in the timer receives current through the power circuits and begins oscillation. When the value set in the timing circuit is counted, an output signal is generated. This signal is amplified by a transistor to operate the load. The voltage created across the load is the input voltage minus the forward voltage drop of the transistor and diode.

(Top View)

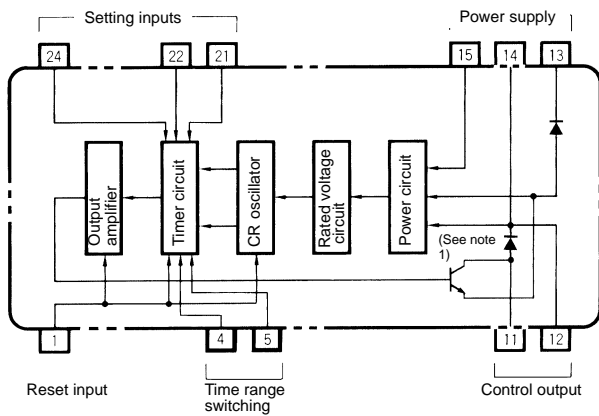

- Note:**
1. A diode is connected internally to adsorb surge voltage generated by the output relay.
 2. Terminals 12 and 14 are internally connected.
 3. There are no time range switching terminals as there were on previous models.

Precautions

Turn the time set knob gently. Forcing the knob can damage it. The life of the internal variable resistor is approximately 50 turns. Use an external variable resistor if frequent adjustment is necessary.

If greater accuracy is required in setting the operation time, measure the time in advance and adjust it with the knob.

Handle the lead terminals with care.

The operation time will vary with the set value as shown below.

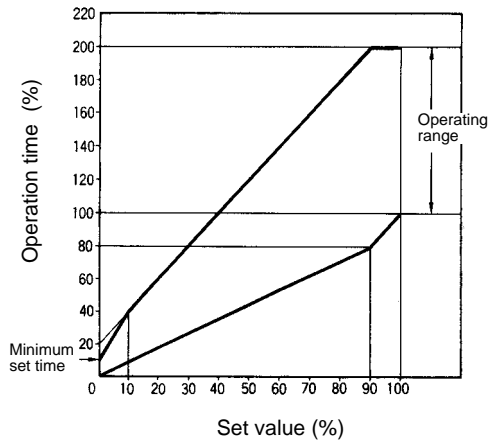

The short time range can be used to more easily set long set values.

Example 1: To set the H3T-A to 10 min, set the time range to 10 s, adjust the knob to 10 s, and then change the time range to 10 min.

Example 2: To set the H3T-B to 5 min, set the time range to 6 s, adjust the knob to 5 s, and then change the time range to 6 min.

The case is made of PBT, which has good resistance to chemicals and will not be affected if cleaned at room temperature for short durations of time. The structure of the Unit, however, does not allow for submersed cleaning.

Models with exposed internal variable resistors can malfunction if the moving parts come into direct contact with liquid.

Although leads are plated to allow for soldering temperatures, soldering must be performed within 10 s at $260 \pm 5^\circ\text{C}$. Solder by hand.

The Unit can be damaged if the terminal pins come into contact with static electricity on hands or objects during mounting or transport. Be sure to ground-out static electricity before handling the Unit.

ALL DIMENSIONS SHOWN ARE IN MILLIMETERS.

To convert millimeters into inches, multiply by 0.03937. To convert grams into ounces, multiply by 0.03527.

Cat. No. L37-E1-5 **In the interest of product improvement, specifications are subject to change without notice.**

OMRON Corporation

Systems Components Division
28th Fl., Crystal Tower Bldg.
1-2-27, Shiromi, Chuo-ku,
Osaka 540 Japan
Phone: 06-949-6012 Fax: 06-949-6021

Printed in Japan
0697-0.5C (0696)