

E5ZN

Temperature Controller

OPERATION MANUAL

OMRON

E5ZN Temperature Controller



Operation Manual

Revised April 2015

Notice:

OMRON products are manufactured for use according to proper procedures by a qualified operator and only for the purposes described in this manual.

The following conventions are used to indicate and classify precautions in this manual. Always heed the information provided with them. Failure to heed precautions can result in injury to people or damage to property.

-  **DANGER** Indicates an imminently hazardous situation which, if not avoided, will result in death or serious injury.
-  **WARNING** Indicates a potentially hazardous situation which, if not avoided, could result in death or serious injury.
-  **Caution** Indicates a potentially hazardous situation which, if not avoided, may result in minor or moderate injury, or property damage.

Visual Aids

The following headings appear in the left column of the manual to help you locate different types of information.

- Note** Indicates information of particular interest for efficient and convenient operation of the product.
- 1,2,3...** 1. Indicates lists of one sort or another, such as procedures, checklists, etc.

© OMRON, 2001

All rights reserved. No part of this publication may be reproduced, stored in a retrieval system, or transmitted, in any form, or by any means, mechanical, electronic, photocopying, recording, or otherwise, without the prior written permission of OMRON.

No patent liability is assumed with respect to the use of the information contained herein. Moreover, because OMRON is constantly striving to improve its high-quality products, the information contained in this manual is subject to change without notice. Every precaution has been taken in the preparation of this manual. Nevertheless, OMRON assumes no responsibility for errors or omissions. Neither is any liability assumed for damages resulting from the use of the information contained in this publication.

Abbreviations

The following table lists the main abbreviations used in parameters, diagrams, and in the text itself.

Abbreviation	Meaning
PV	Process value
SP	Set point
AT	Autotuning
EU	Engineering units (See note.)
ch	Channel

Note Scaled data is expressed in °C, m, g, and other engineering units. EU is used as the minimum unit for engineering units. For example, the smallest unit of 50.02 (m) is 0.01 (m) and 0.01 is thus one EU.

Parameter Notation

The following table shows the alphabet notation used for parameter abbreviations and settings displayed on the E5ZN-SDL Setting Display Unit.

<i>A</i>	<i>b</i>	<i>c</i>	<i>d</i>	<i>E</i>	<i>F</i>	<i>G</i>	<i>H</i>	<i>i</i>	<i>J</i>	<i>K</i>	<i>L</i>	<i>m</i>
A	B	C	D	E	F	G	H	I	J	K	L	M
<i>n</i>	<i>o</i>	<i>P</i>	<i>q</i>	<i>r</i>	<i>S</i>	<i>t</i>	<i>U</i>	<i>v</i>	<i>w</i>	<i>x</i>	<i>y</i>	<i>z</i>
N	O	P	Q	R	S	T	U	V	W	X	Y	Z

TABLE OF CONTENTS

PRECAUTIONS	xv
1 Intended Audience	xvi
2 General Precautions	xvi
3 Application Precautions	xvi
SECTION 1	
Outline	1
1-1 Name and Function of Parts	2
1-2 I/O Configuration and Main Functions	4
SECTION 2	
Preparations	7
2-1 Installation	8
2-2 Using the I/O Section	13
2-3 Installation Precautions	19
SECTION 3	
Temperature Control Settings	21
3-1 Setting the Input Type	22
3-2 Selecting Centigrade/Fahrenheit	23
3-3 Selecting PID Control or ON/OFF Control	24
3-4 Setting Output Specifications	25
3-5 Setting the SP	28
3-6 Executing ON/OFF Control	29
3-7 Determining PID Constants: Autotuning and Manual Setup	31
3-8 Alarm Outputs	33
3-9 Using Heater Burnout Alarm (HBA)	36
3-10 Starting and Stopping Control	38
3-11 Operating Precautions	39
SECTION 4	
Settings Used Only when Required	41
4-1 Shifting Input Values	42
4-2 Alarm Hysteresis	46
4-3 Setting Scaling Upper and Lower Limits (Analog Input)	48
4-4 Executing Heating and Cooling Control	49
4-5 Using the Event Input	50
4-6 Setting the SP Upper and Lower Limit Range	52
4-7 SP Ramp Function: Limiting SP Change Rate	53
4-8 Key Protection	54
4-9 Manual Mode	56
4-10 Reading Temperatures for Multiple E5ZN Units	58
4-11 Remote PV Mode	59
4-12 Using Transfer Output	60

TABLE OF CONTENTS

SECTION 5

Communications	63
5-1 Communication Protocols	64
5-2 Data Format Structure	65
5-3 Structure of Command/Response Text	67
5-4 Variable Area	68
5-5 Read from Variable Area	69
5-6 Write to Variable Area	70
5-7 Operation Commands	71
5-8 Setting Areas	73
5-9 Commands and Responses	74
5-10 Variable Area Map	90

SECTION 6

Using the E5ZN-SDL	107
6-1 Introduction	108
6-2 Names of Parts on the Front Panel	111
6-3 Setup Level Configuration and Front Panel Keys	114
6-4 Initial Setup Examples	116
6-5 Using Copy Mode	118
6-6 List of Parameters	122

SECTION 7

Parameters	125
7-1 Conventions Used in this Chapter	127
7-2 Protect Level	128
7-3 Operation Level	129
7-4 Adjustment Level	135
7-5 Initial Setting Level	143
7-6 Advanced Function Setting Level	154
7-7 Communications Setting Level	166

SECTION 8

Troubleshooting	169
8-1 Troubleshooting Procedure	170
8-2 Communications Errors	171
8-3 Temperature Sensing Errors	172
8-4 Temperature Control Errors	174
8-5 Output Errors	176
8-6 HB Alarm Errors	177
8-7 Key Operations Not Functioning	178
8-8 Error Displays	179

TABLE OF CONTENTS

Appendices

A	Specifications	181
B	Sensor Input Setting Ranges/Control Ranges	185
C	ASCII Table	193

Index.....	195
-------------------	------------

Revision History	199
-------------------------------	------------

About this Manual:

This manual describes how to use the E5ZN and includes the sections described below.

Before using your E5ZN, thoroughly read and understand this manual in order to ensure correct use.

Also, store this manual in a safe place so that it can be accessed whenever necessary.

In this manual, current output models (E5ZN-2C□F03□-FLK) are referred to as “analog output models,” and voltage output models (E5ZN-2Q□H03□-FLK) and transistor output models (E5ZN-2T□H03□-FLK) are referred to as “pulse output models.”

There are now pulse output models that support new functions. The new models are called “upgraded pulse output models” when describing the functions added to these models. (Contact your OMRON sales representative if you are not sure about the functions supported by your E5ZN Temperature Controller.)

The E5ZN Temperature Controller allows the user to perform the following:

- Control temperature for two channels with one Temperature Controller. The Temperature Controller can be expanded to control up to 32 channels.
- Use an E5ZN-SDL Setting Display Unit to set the Temperature Controller.
- Input infrared temperature sensors, analog voltages, thermocouples, or platinum-resistance thermometers.
- Select heating/cooling control in addition to standard control.
- Select autotuning as the tuning function.
- Use multi-SP and a RUN/STOP function with event inputs.
- Use a HBA (heater burnout alarm).
- Use communications.

The E5ZN conforms to UL/CSA/IEC safety standards and EMC standards.

Precautions provides general precautions for using the E5ZN.

Section 1 describes E5ZN features, part names, and main functions.

Section 2 describes mounting, wiring, and other preparatory work that must be done before the E5ZN can be used.

Section 3 describes the basic settings required by the E5ZN.

Section 4 describes scaling, SP ramp, and other functions to enable maximum use of the E5ZN functions.

Section 5 describes performing communications for the E5ZN.

Section 6 describes how to operate the E5ZN-SDL Setting Display Unit.

Section 7 describes the parameters used to control E5ZN operation.

Section 8 classifies problems by situation and describes the methods for checking any possible malfunctions.

 **WARNING** Failure to read and understand the information provided in this manual may result in personal injury or death, damage to the Temperature Controller, or product failure. Please read each section in its entirety and be sure you understand the information provided in the section and related sections before attempting any of the procedures or operations given.

Terms and Conditions Agreement

Warranty, Limitations of Liability

Warranties

● Exclusive Warranty

Omron's exclusive warranty is that the Products will be free from defects in materials and workmanship for a period of twelve months from the date of sale by Omron (or such other period expressed in writing by Omron). Omron disclaims all other warranties, express or implied.

● Limitations

OMRON MAKES NO WARRANTY OR REPRESENTATION, EXPRESS OR IMPLIED, ABOUT NON-INFRINGEMENT, MERCHANTABILITY OR FITNESS FOR A PARTICULAR PURPOSE OF THE PRODUCTS. BUYER ACKNOWLEDGES THAT IT ALONE HAS DETERMINED THAT THE PRODUCTS WILL SUITABLY MEET THE REQUIREMENTS OF THEIR INTENDED USE.

Omron further disclaims all warranties and responsibility of any type for claims or expenses based on infringement by the Products or otherwise of any intellectual property right.

● Buyer Remedy

Omron's sole obligation hereunder shall be, at Omron's election, to (i) replace (in the form originally shipped with Buyer responsible for labor charges for removal or replacement thereof) the non-complying Product, (ii) repair the non-complying Product, or (iii) repay or credit Buyer an amount equal to the purchase price of the non-complying Product; provided that in no event shall Omron be responsible for warranty, repair, indemnity or any other claims or expenses regarding the Products unless Omron's analysis confirms that the Products were properly handled, stored, installed and maintained and not subject to contamination, abuse, misuse or inappropriate modification. Return of any Products by Buyer must be approved in writing by Omron before shipment. Omron Companies shall not be liable for the suitability or unsuitability or the results from the use of Products in combination with any electrical or electronic components, circuits, system assemblies or any other materials or substances or environments. Any advice, recommendations or information given orally or in writing, are not to be construed as an amendment or addition to the above warranty.

See <http://www.omron.com/global/> or contact your Omron representative for published information.

Limitation on Liability; Etc

OMRON COMPANIES SHALL NOT BE LIABLE FOR SPECIAL, INDIRECT, INCIDENTAL, OR CONSEQUENTIAL DAMAGES, LOSS OF PROFITS OR PRODUCTION OR COMMERCIAL LOSS IN ANY WAY CONNECTED WITH THE PRODUCTS, WHETHER SUCH CLAIM IS BASED IN CONTRACT, WARRANTY, NEGLIGENCE OR STRICT LIABILITY.

Further, in no event shall liability of Omron Companies exceed the individual price of the Product on which liability is asserted.

Application Considerations

Suitability of Use

Omron Companies shall not be responsible for conformity with any standards, codes or regulations which apply to the combination of the Product in the Buyer's application or use of the Product. At Buyer's request, Omron will provide applicable third party certification documents identifying ratings and limitations of use which apply to the Product. This information by itself is not sufficient for a complete determination of the suitability of the Product in combination with the end product, machine, system, or other application or use. Buyer shall be solely responsible for determining appropriateness of the particular Product with respect to Buyer's application, product or system. Buyer shall take application responsibility in all cases.

NEVER USE THE PRODUCT FOR AN APPLICATION INVOLVING SERIOUS RISK TO LIFE OR PROPERTY WITHOUT ENSURING THAT THE SYSTEM AS A WHOLE HAS BEEN DESIGNED TO ADDRESS THE RISKS, AND THAT THE OMRON PRODUCT(S) IS PROPERLY RATED AND INSTALLED FOR THE INTENDED USE WITHIN THE OVERALL EQUIPMENT OR SYSTEM.

Programmable Products

Omron Companies shall not be responsible for the user's programming of a programmable Product, or any consequence thereof.

Disclaimers

Performance Data

Data presented in Omron Company websites, catalogs and other materials is provided as a guide for the user in determining suitability and does not constitute a warranty. It may represent the result of Omron's test conditions, and the user must correlate it to actual application requirements. Actual performance is subject to the Omron's Warranty and Limitations of Liability.

Change in Specifications

Product specifications and accessories may be changed at any time based on improvements and other reasons. It is our practice to change part numbers when published ratings or features are changed, or when significant construction changes are made. However, some specifications of the Product may be changed without any notice. When in doubt, special part numbers may be assigned to fix or establish key specifications for your application. Please consult with your Omron's representative at any time to confirm actual specifications of purchased Product.

Errors and Omissions

Information presented by Omron Companies has been checked and is believed to be accurate; however, no responsibility is assumed for clerical, typographical or proofreading errors or omissions.

PRECAUTIONS

This section provides general precautions for using the E5ZN Temperature Controller.

The information contained in this section is important for the safe and reliable application of the Temperature Controller. You must read this section and understand the information contained before attempting to set up or operate an Temperature Controller.

1	Intended Audience	xvi
2	General Precautions	xvi
3	Application Precautions	xvi

1 Intended Audience

This manual is intended for the following personnel, who must also have knowledge of electrical systems (an electrical engineer or the equivalent).

- Personnel in charge of installing automation systems.
- Personnel in charge of designing automation systems.
- Personnel in charge of managing automation systems and facilities.

2 General Precautions

The user must operate the Temperature Controller according to the performance specifications described in the operation manuals.

Before using the Temperature Controller under conditions which are not described in the manual or applying the Temperature Controller to nuclear control systems, railroad systems, aviation systems, vehicles, combustion systems, medical equipment, amusement machines, safety equipment, and other systems, machines, and equipment that may have a serious influence on lives and property if used improperly, consult your OMRON representative.

Make sure that the ratings and performance characteristics of the Temperature Controller are sufficient for the systems, machines, and equipment, and be sure to provide the systems, machines, and equipment with double safety mechanisms.

This manual provides information for installing and operating OMRON Temperature Controllers. Be sure to read this manual before operation and keep this manual close at hand for reference during operation.

 **WARNING** It is extremely important that a Temperature Controller be used for the specified purpose and under the specified conditions, especially in applications that can directly or indirectly affect human life. You must consult with your OMRON representative before applying a Temperature Controller to the above mentioned applications.

3 Application Precautions

 **WARNING** Do not touch the terminals while the power is ON. Doing so may cause an electric shock.

 **WARNING** It may be necessary to install a power supply breaker to turn OFF the power supply before working on the Temperature Controller. Not turning OFF the power supply may result in electrical shock.

 **WARNING** Do not allow metal fragments or lead wire scraps to fall inside this Temperature Controller. These may cause electric shock, fire, or malfunction.

 **WARNING** Do not use the Temperature Controller in flammable and explosive gas atmospheres. There is danger of explosion.

 **WARNING** Never disassemble, repair, or modify the Temperature Controller. Doing so may cause electric shock, fire or malfunction.

 **Caution** Set all settings according to the control target of the Temperature Controller. If the settings are not appropriate for the control target, the Temperature Controller may operate in an unexpected manner, resulting in damage to the Temperature Controller or resulting in accidents.

 **Caution** Tighten the terminal screws properly. Tighten them to a torque of 0.40 to 0.56 N·m.

 **WARNING** To maintain safety in the event of a Temperature Controller malfunction, always take appropriate safety measures, such as installing an alarm on a separate line to prevent excessive temperature rise. If a malfunction prevents proper control, a major accident may result.

Observe the following precautions when using the Temperature Controller.

- Use and store the Temperature Controller within the specified temperature and humidity ranges. If there is a possibility of the ambient temperature rising to a temperature above the specified temperature range, take steps, such as installing fans, to cool the E5ZN. If the Temperature Controller is installed incorrectly, heat will build up inside, shortening the life of the Temperature Controller. If heat buildup is a problem, use forced cooling, e.g., install a cooling fan.
- Do not touch the patterns or components on a board with your bare hands. Hold it by the case.
- To allow heat to escape, do not block the area around the Temperature Controller. (Ensure that enough space is left for the heat to escape.) Do not block the ventilation holes on the casing.
- Use the Temperature Controller within the specified power supply voltage and rated load ranges.
- Wire properly using the correct terminal polarity.
- Use the specified size of solderless terminals for wiring (M3, width 5.8 mm or less).
- Use the specified wire sizes for wiring. Power supply terminals: AWG22 to AWG14 (cross-sectional area of 0.326 to 2.081 mm²), Other terminals: AWG28 to AWG16 (cross-sectional area of 0.081 to 1.309 mm²), Length of exposed wire: 6 to 8 mm.
- Do not wire unused terminals.
- Make sure that the rated voltage is reached within 2 seconds after the power supply is turned ON.
- Allow a warmup period of 30 minutes.
- Attach a surge suppressor or noise filter to peripheral devices that generate noise (in particular, motors, transformers, solenoids, magnetic coils or other equipment that have an inductance component). When mounting a noise filter on the power supply, be sure to first check the filter's voltage and current capacity, and then mount the filter as close as possible to the E5CN. Allow as much space as possible between the Temperature Controller and devices that generate powerful high-frequency noise (e.g., high-frequency welders, high-frequency sewing machines) or surges.
- To reduce induction noise, separate the high-voltage or large-current power lines from other lines, and avoid parallel or common wiring with the power lines when you are wiring to the terminals. We recommend using separating pipes, ducts, or shielded lines.
- Install a switch or circuit breaker in a location easily accessible to the operator and label it appropriately.
- Do not use this Temperature Controller in the following places:
 - Places subject to dust or corrosive gases (in particular, sulfide gas and ammonia gas)
 - Places subject to high humidity, condensation or freezing
 - Places subject to direct sunlight

- Places subject to vibration and large shocks
- Places subject to splashing liquid or oily atmosphere
- Places directly subject to heat radiated from heating equipment
- Places subject to intense temperature changes
- Cleaning: Do not use paint thinner or the equivalent. Use standard grade alcohol to clean the Temperature Controller.
- Install DIN track vertically.
- When mounting the Terminal Unit to the Temperature Controller, make sure that the hooks on the Temperature Controller are inserted properly into the Terminal Unit.
- Remove the dust sticker from the Temperature Controller after completing wiring to enable heat radiation.
- When you draw out the internal mechanism from the housing, never touch electric components inside or subject the internal mechanism to shock.

SECTION 1

Outline

1-1	Name and Function of Parts	2
1-1-1	External Appearance.....	2
1-1-2	Front Panel Names	2
1-1-3	Display	3
1-1-4	Setting Switches	3
1-2	I/O Configuration and Main Functions.....	4
1-2-1	I/O Configuration	4
1-2-2	Main Functions.....	5

1-1 Name and Function of Parts

1-1-1 External Appearance

- The E5ZN Temperature Controller can be mounted inside another device.
- RS-485 communications is a standard feature with the E5ZN, allowing monitoring of PVs and reading/writing parameters from the host.
- The Terminal Unit and the Temperature Controller Module can be separated, making wiring and maintenance of the E5ZN easier.
- Space and wiring can be reduced by using an Expansion Terminal Unit when connecting two or more E5ZN Controllers to the same host.

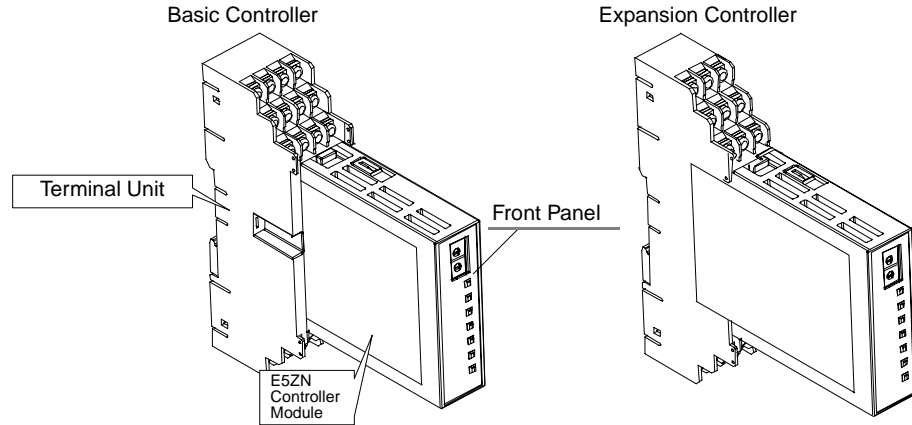

1-1-2 Front Panel Names

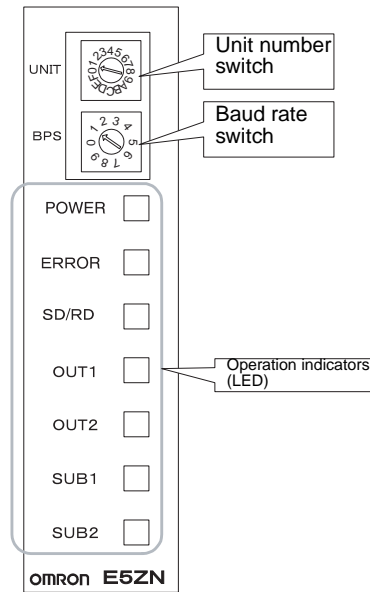

1-1-3 Display

Operation Display

- 1,2,3...
1. POWER
Lit when power is ON.
 2. ERROR
Flashes when a memory error or an input error to either channel has occurred.
 3. SD/RD (send data/receive data)
Flashes during communications with the host computer.
 4. OUT1, OUT2 (control output 1, control output 2)
Lit when control output 1 or 2 is ON.
 5. SUB1, SUB2 (auxiliary output 1, auxiliary output 2)
Lit when auxiliary outputs 1 or 2 is ON.

Note There is no display on the front panel for SUB3 and SUB4 (auxiliary output 3 and auxiliary output 4) of analog output models.

1-1-4 Setting Switches

Use the switches to change the communications conditions for communications with the host computer. Before using the E5ZN, match the settings to the host.

Operate the switches under the following conditions only.

- The power supply must be turned OFF. The settings will be enabled only when the power is turned ON again.
- To change the switch setting, use a flat-blade screwdriver and turn the switch to the required position.

Unit Number

A unit number is set for each Temperature Controller to identify the Temperature Controllers connected to the host and to an E5ZN-SDL Setting Display Unit.

The unit number is set in hexadecimal.

The switch settings are 0 to F, which correspond to unit numbers 00 to 15.

Setting	0	1	2	3	4	5	6	7	8	9	A	B	C	D	E	F
Unit No.	00	01	02	03	04	05	06	07	08	09	10	11	12	13	14	15

↑ Default

Set a different unit number for each Temperature Controller when more than one E5ZN Temperature Controller is connected for RS-485 communications. Communications cannot be performed if the same unit number is used more than once in one system.

Baud Rate

Match the E5ZN Temperature Controller baud rate to the host baud rate.

Setting	0	1	2	3	4	5	6	7	8	9
Baud rate (bit/s)	4800	9600	19200	38400	Do not use these settings.					

↑ Default

1-2 I/O Configuration and Main Functions

1-2-1 I/O Configuration

Pulse Output Models
E5ZN-2Q□H03□-FLK
E5ZN-2T□H03□-FLK

Analog Output Models
E5ZN-2C□F03□-FLK

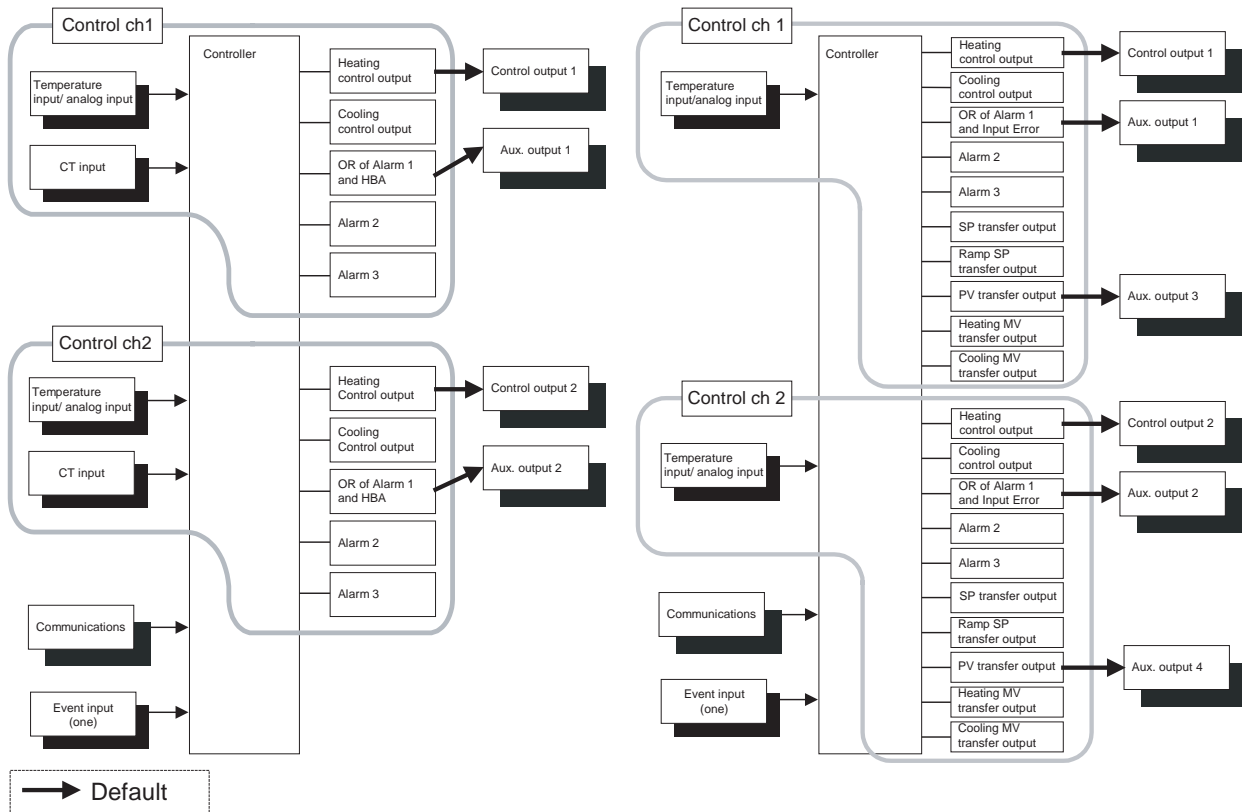

Note Refer to *Output Allocations* on page 26 for the combinations of functions that can be allocated to the control and auxiliary outputs.

1-2-2 Main Functions

Communications Functions	<p>Communications according to CompoWay/F (see note) are supported and are performed through the RS-485 interface.</p> <p>Up to 16 E5ZN Temperature Controllers can be operated from the host.</p> <p>Note CompoWay/F is a general-purpose serial communications-based unified communications protocol developed by OMRON. CompoWay/F uses commands compatible with the well-established FINS, together with a unified frame format on OMRON programmable Controllers to facilitate communications between personal computers and components.</p>
Number of Control Points	<p>One E5ZN Temperature Controller has two channels for controlling temperature.</p>
Input Sensor Types	<p>The following input sensors can be connected for temperature input. Both channels will use the same type of sensor.</p> <p>Thermocouple: K, J, T, E, L, U, N, R, S, B</p> <p>Infrared temperature sensor type: ES1A K (10 to 70°C), K (60 to 120°C), K (115 to 165°C), K (160 to 260°C)</p> <p>Platinum-resistance thermometer: Pt100, JPt100</p> <p>Analog input: 0 to 50 mV</p>
Control Output	<p>The control output depends on the model as follows:</p> <p>Voltage output models (E5ZN-2Q□H03□-FLK): Pulse voltage output</p> <p>Transistor output models (E5ZN-2T□H03□-FLK): Transistor output (open collector)</p> <p>Current output models (E5ZN-2C□F03□-FLK): Linear current output</p>
Alarms	<ul style="list-style-type: none"> • Set the alarm type and alarm value, or set upper- and lower-limit alarms. • If necessary, a more comprehensive alarm function can be achieved by setting the “standby sequence,” “alarm hysteresis,” and “close in alarm/open in alarm” parameters.
Control Adjustment	<p>Optimum PID constants can be set easily by autotuning.</p>
Event Input	<ul style="list-style-type: none"> • The following functions can be achieved using the event input (one input per Temperature Controller): SP selection (multi-SP, 2 points max.) and RUN/STOP. • The event input is used by both temperature control channels.
HBA	<p>A heater burnout alarm (HBA) is supported by pulse output models only.</p>

SECTION 2 Preparations

2-1	Installation	8
2-1-1	External Dimensions	8
2-1-2	Assembling Units	8
2-2	Using the I/O Section	13
2-2-1	Terminal Arrangement	13
2-2-2	Precautions when Wiring	13
2-2-3	Wiring	14
2-3	Installation Precautions	19
2-3-1	Ensuring Prolonged Use	19
2-3-2	Reducing the Influence of Noise	19
2-3-3	Ensuring Precise Measurements	19
2-3-4	Enclosure Ratings	20

2-1 Installation

2-1-1 External Dimensions

(Unit: mm)

The following diagrams show the E5ZN with a Terminal Unit attached.

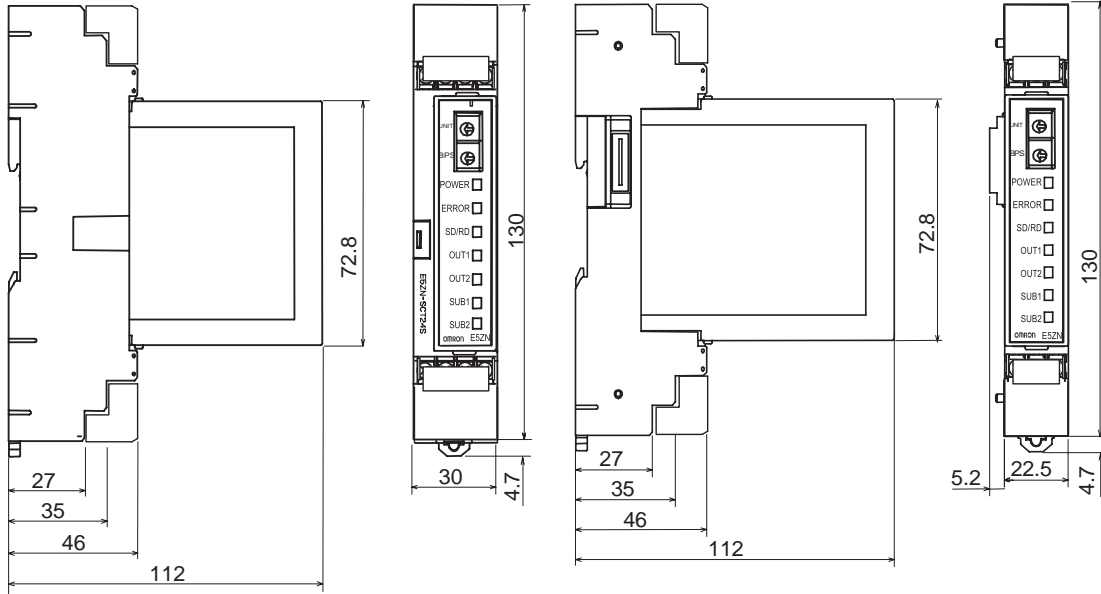

E5ZN-SCT24S-500 Terminal Unit
 Note: Always use this basic E5ZN-SCT24S-500 Terminal Unit if using only one E5ZN Unit.

E5ZN-SCT18S-500 Terminal Unit
 Note: Use the Expansion E5ZN-SCT18S-500 Terminal Unit for dense mounting with two or more Units. Use this Terminal Unit for all but the first Unit.

2-1-2 Assembling Units

Joining Terminal Units Together

Up to 15 Expansion E5ZN- SCT18S-500 Terminal Units can be connected to a basic E5ZN-SCT24S-500 Terminal Unit.

Two Terminal Units can be connected by joining the side connector on each Terminal Unit.

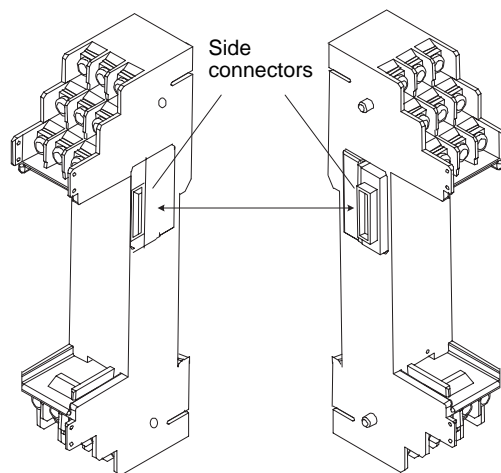

Attach a connector cover to the rightmost Terminal Unit.

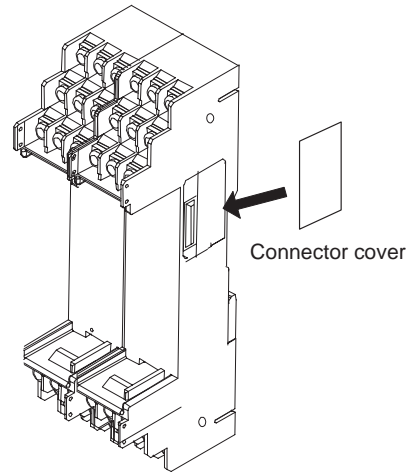

Mounting to DIN Track

Mounting the Unit

Pull the hook down on the bottom, latch the top hook onto the track, push the Unit until the hook locks onto the track, and then push the hook back up to lock the Unit in place.

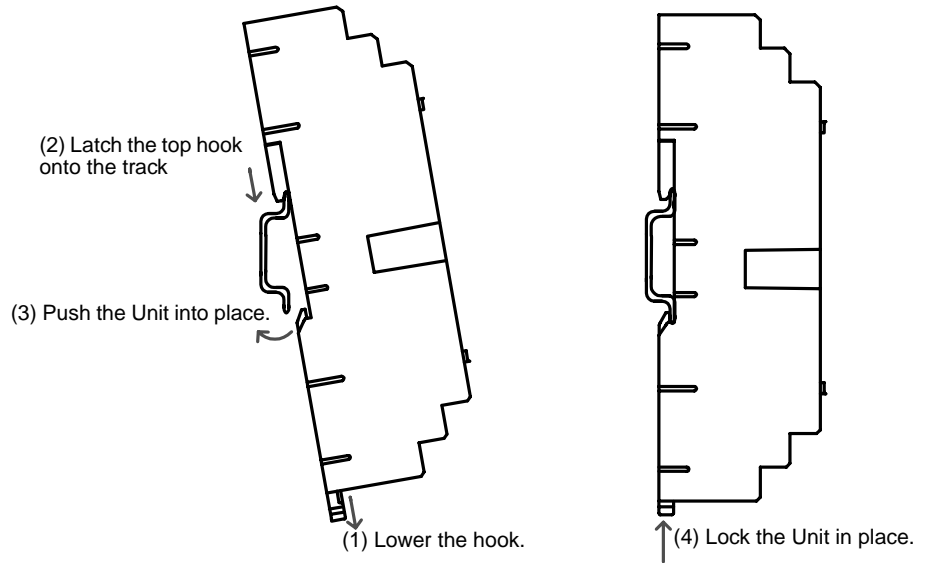

Removing the Unit

Use a flat-blade screwdriver to pull down the hook and lift the Unit from the bottom.

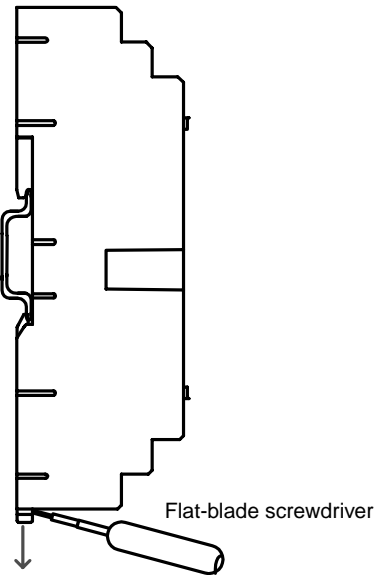

Mounting End Plates

Always mount end plates to both ends of the E5ZN Temperature Controllers.

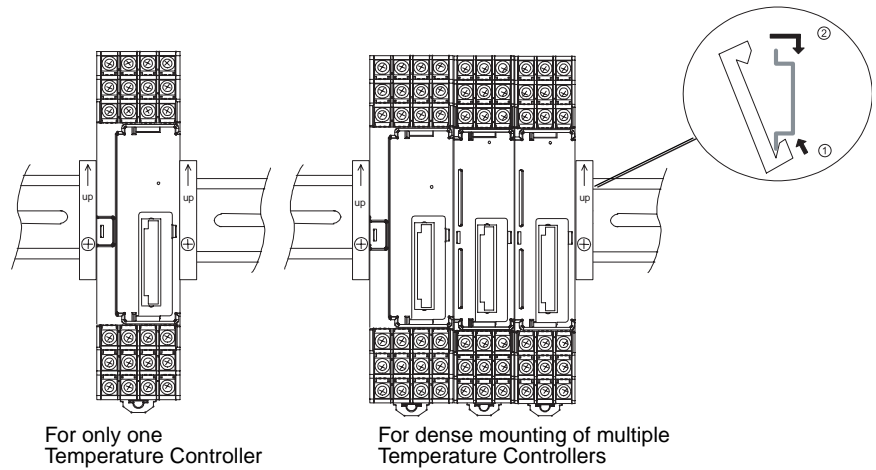

Mounting Bracket

Mount the E5ZN Temperature Controller to DIN track. Use screws to attach the DIN track to the control panel in at least three places.

- PFP-50N (50 cm)/PFP-100N (100 cm) DIN Track

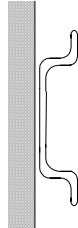
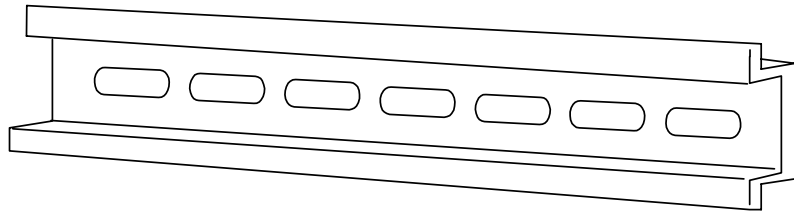

Vertical: OK

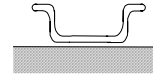

Horizontal: NG

Position the DIN track vertical to the ground.

Mounting the E5ZN Module

Mounting the Module

Line up the Module with the guides on the Terminal Unit and push firmly into place.

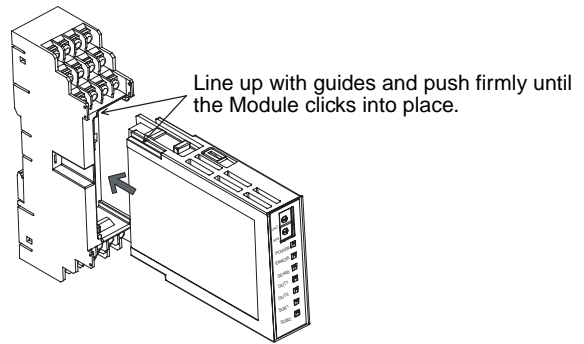

Removing the Module

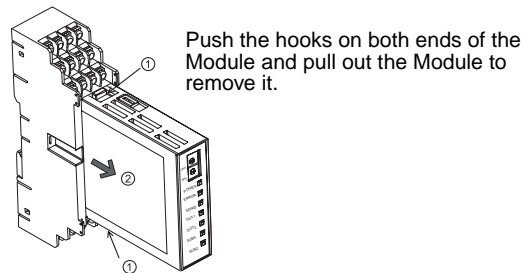

Covers

When wiring, open the E53-COV12 Terminal Cover attached to the E5ZN-SCT24S-500 Terminal Unit or the E53-COV13 Terminal Cover attached to the E5ZN-SCT18S-500 Terminal Unit. When wiring has been completed, close the cover until it clicks shut.

Both E5ZN-SCT24S-500 Terminal Units and E5ZN-SCT18S-500 Terminal Units have Terminal Covers.

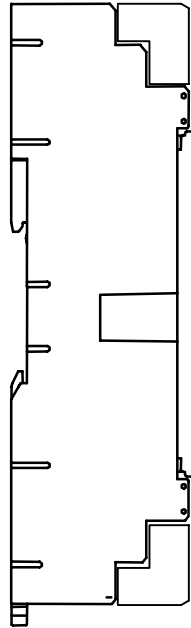

Terminals Covered

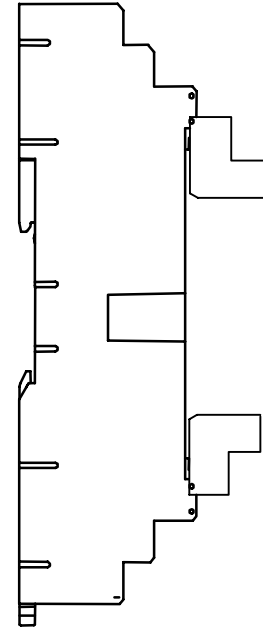

Terminals Exposed

2-2 Using the I/O Section

2-2-1 Terminal Arrangement

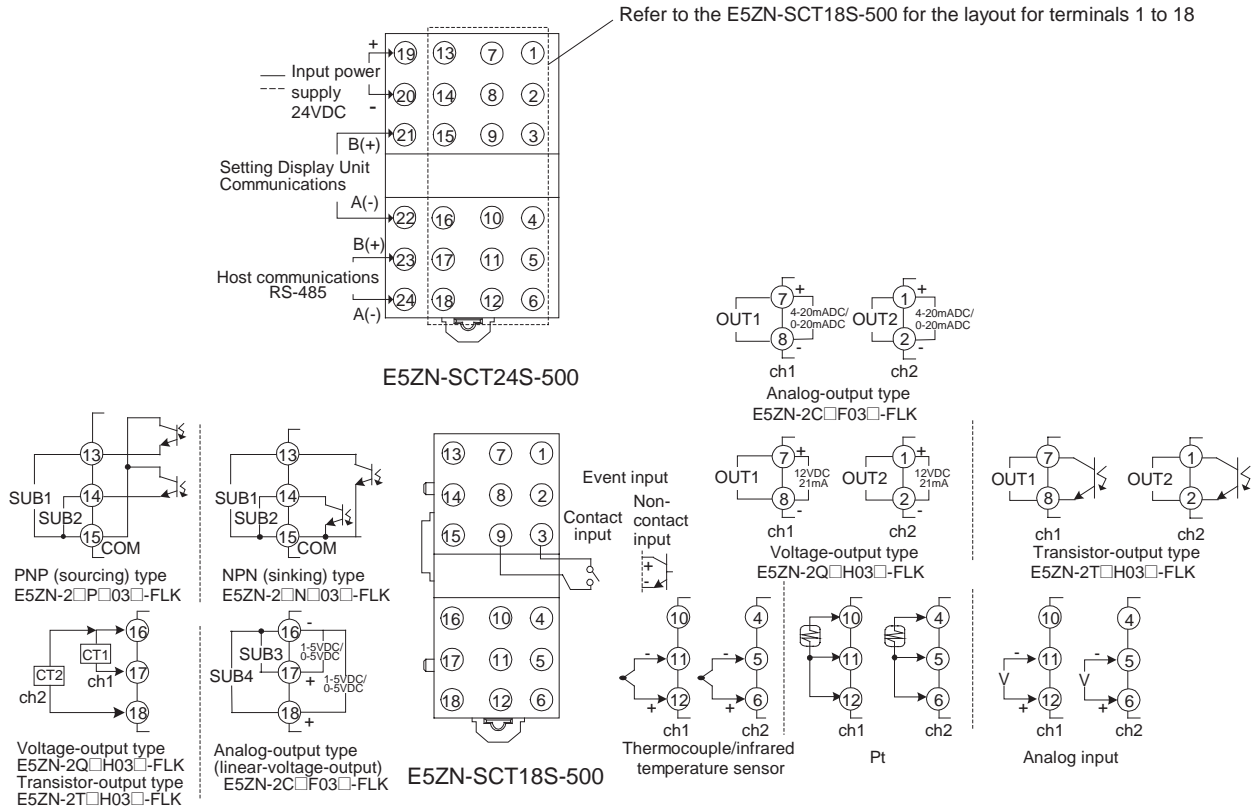

2-2-2 Precautions when Wiring

- Separate signal leads and power lines in order to protect the E5ZN and its lines from external noise.
- We recommend using solderless terminals when wiring the E5ZN.
- Tighten the terminal screws using a torque between 0.40 and 0.56 N·m.
- Use the following type of solderless terminals for M3 screws.

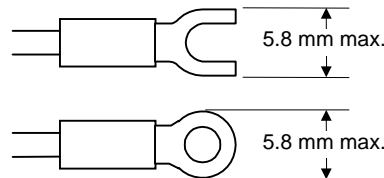

2-2-3 Wiring

The left sides of the terminal numbers in the following diagram are on the outside of the Unit and the right sides are on the inside of the Unit.

Power Supply

19	13	7	1
20	14	8	2
21	15	9	3
22	16	10	4
23	17	11	5
24	18	12	6

E5ZN-SCT24S-500

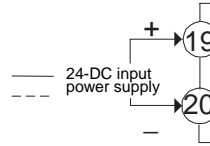

- Connect to terminals 19 and 20, as shown in the following diagram.

- When reinforced insulation is required, connect the I/O to a device without an exposed charged section or to a device with basic insulation suitable for the maximum usage voltage of the I/O section.
- UL/CSA/CE Safety Standards
Use a SELV power supply with an overcurrent protection function. A SELV power supply refers to a power supply with redundant I/O or with increased insulation and with an output voltage of 30 Vr.m.s and a 42.4-V peak or maximum 60 VDC.
Recommended power supply: S82K-05024 CD (OMRON) or S8VS-06024A (OMRON)
- To ensure the rating of Main terminal disturbance voltage for class A in EN61326, equip a noise filter (DENSEI-LAMBDA, MXB-1206-33 or equivalent one) to the DC power line as close to the temperature controller as possible.

Inputs

19	13	7	1
20	14	8	2
21	15	9	3
22	16	10	4
23	17	11	5
24	18	12	6

E5ZN-SCT24S-500

Connect channel 1 to terminals 10 to 12 and channel 2 to terminals 4 to 6 as follows, according to the input type:

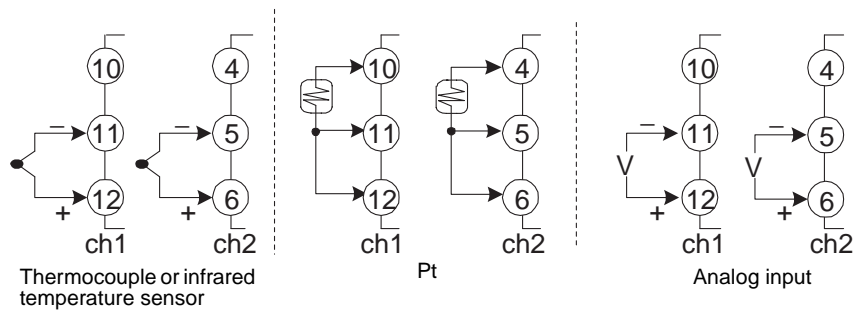

Note Connect the terminals or set the parameter according to the following instructions to prevent error indicators being lit for channels not being used.

- For upgraded pulse output models and analog output models:
With any type of sensor, the parameter “sensor error indicator used” (initial setting level) can be used to prevent error indicators being lit for channels not being used.
- For the previous pulse output models (not upgraded):
 - For thermocouple, infrared temperature sensor, or analog input:
Form a short-circuit between terminals 5 and 6 when channel 2 is not used, or between terminals 11 and 12 when channel 1 is not used.
 - For Pt:
Connect a resistance of 100 to 125 Ω between terminals 4 and 5 when channel 2 is not used, or between terminals 10 and 11 when channel 1 is not used.
Form a short-circuit between terminals 5 and 6 when channel 2 is not used and between terminals 11 and 12 when channel 1 is not used.

13	7	1
14	8	2
15	9	3
16	10	4
17	11	5
18	12	6

E5ZN-SCT18S-500

Control Output 1/2

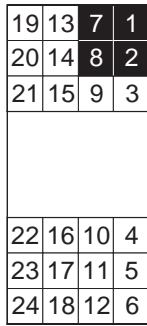

E5ZN-SCT24S-500

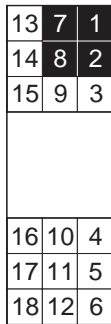

E5ZN-SCT18S-500

- Terminals 7 and 8 are for control output 1 (OUT1) and terminals 1 and 2 are for control output 2 (OUT2).

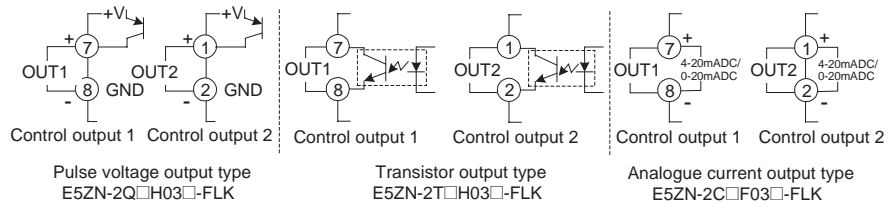

- The following table shows the specifications for each output.

Output	Specifications
Pulse voltage	12 VDC output voltage \pm 15% (PNP) Max. load current 21 mA, with short-circuit protection circuit
Transistor	Max. usage voltage 30 VDC, max. load current 100 mA. Max. residual voltage 1.5 V, max. leakage current 0.4 mA max.
Current	Current output range: 4 to 20 mA DC 0 to 20 mA DC Allowable load impedance: 350 Ω max. (See note.)

Note A G32A-EA Cycle Control Unit (made by OMRON; internal load impedance: 352 Ω) can be used.

- The pulse voltage output (control output) is not electrically insulated from the internal circuits.
When using grounded thermocouples, do not connect any of the control output terminals to the ground. If the terminals are connected to ground, unwanted current paths may result in incorrect temperature measurements.

Auxiliary Outputs 1/2



E5ZN-SCT24S-500



E5ZN-SCT18S-500

- Terminals 13 and 15 are for auxiliary output 1 (SUB1) and terminals 14 and 15 are for auxiliary output 2 (SUB2.)

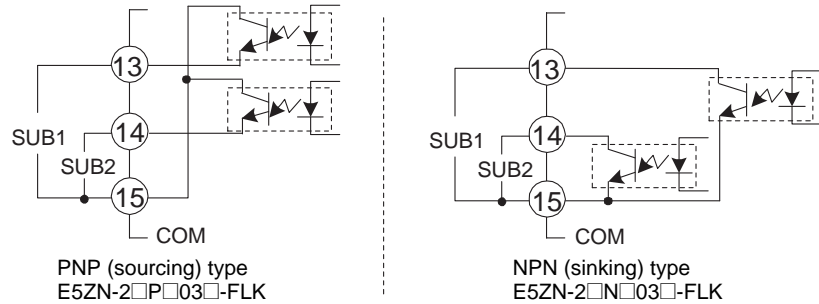

- The transistor output specifications are given below.
Maximum applicable voltage: 30 VDC, maximum load current: 50 mA.
Maximum residual voltage: 1.5 V, maximum leakage current: 0.4 mA.

CT Input

19	13	7	1	13	7	1
20	14	8	2	14	8	2
21	15	9	3	15	9	3
22	16	10	4	16	10	4
23	17	11	5	17	11	5
24	18	12	6	18	12	6

E5ZN-SCT24S/18S-500

- CT input can be used with pulse output models only.
- When the heater burnout alarm is used, connect a current transformer (CT) across terminals 16 and 17 for channel 1 and terminals 16 and 18 for channel 2 (no polarity).

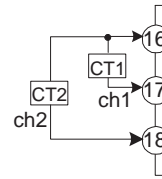

- Use E54-CT1 or E54-CT3 Current Transformers.

Linear Voltage Output

19	13	7	1	13	7	1
20	14	8	2	14	8	2
21	15	9	3	15	9	3
22	16	10	4	16	10	4
23	17	11	5	17	11	5
24	18	12	6	18	12	6

E5ZN-SCT24S/18S-500

- Linear voltage output is allocated to auxiliary outputs 3 and 4 and can be used with analog output models only.
- Terminals 16 and 17 are for auxiliary output 3 (SUB3) and terminals 16 and 18 are for auxiliary output 4 (SUB4).

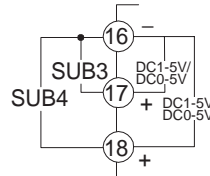

- Do not apply voltage to the linear voltage output terminals.

Output	Specifications
Linear voltage output	Voltage output range: 1 to 5 VDC 0 to 5 VDC Allowable load impedance: 10 kΩ min.

Event Input

19	13	7	1	13	7	1
20	14	8	2	14	8	2
21	15	9	3	15	9	3
22	16	10	4	16	10	4
23	17	11	5	17	11	5
24	18	12	6	18	12	6

E5ZN-SCT24S/18S-500

- When event input is used, connect to terminals 3 and 9.

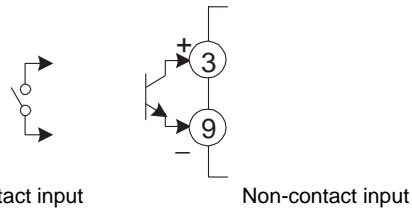

- Do not apply voltage to terminals 3 and 9.
- The inrush current that flows from E5ZN to the contact connected to terminals 3 and 9 is approx. 7 mA.
- Use event inputs under the following conditions:

Contact input	ON: 1 kΩ max., OFF: 100kΩ min.
No-contact input	ON: residual voltage of 1.5 V max., OFF: leakage current of 0.1 mA max.

Communications

19	13	7	1
20	14	8	2
21	15	9	3
22	16	10	4
23	17	11	5
24	18	12	6

E5ZN-SCT24S-500

- When communicating with a host, connect across terminals 23 and 24.

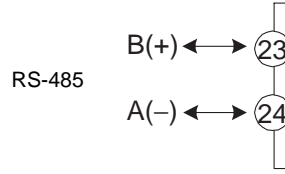

- The RS-485 connection can be either one-to-one to one-to-N. Up to 16 Temperature Controllers can be connected in one-to-N systems.
- Keep the total cable length to 500 m maximum.

Isolation

The E5ZN terminals are electrically isolated in the blocks shown below.

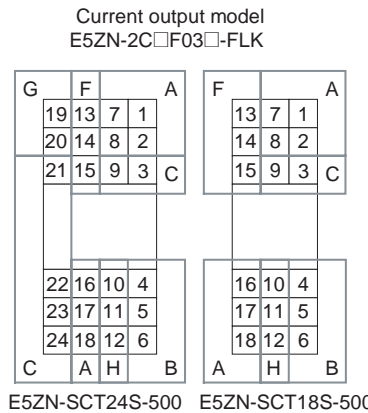
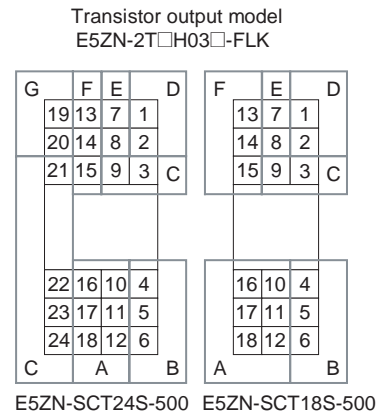
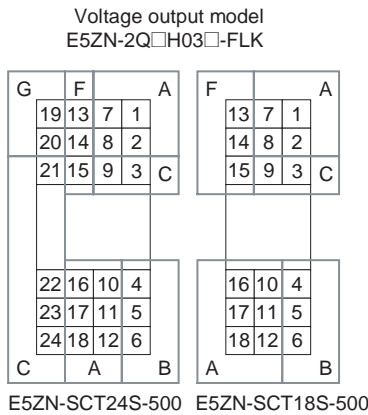

- Use shielded, twisted-pair cable (with wire sizes of AWG 28 or larger).

Cable

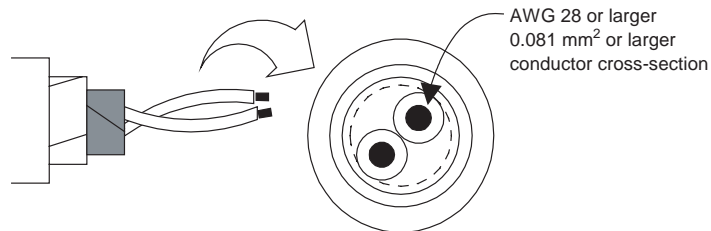

- Attach a terminator to both ends of the transmission path, including the host.
- The terminator specifications are as follows:

Terminator	100 to 125 Ω (1/2 W)
------------	----------------------

- Use an RS-232C/RS-485 Converter when connecting personal computers with an RS-232C port.
 Recommended Adapter: K32-23209 (OMRON)
 Recommend Interface Converter: K3SC (OMRON)
 (The K3SC is available in models with 100 VAC power supplies and models with 24 V, AC/DC power supplies. Specify the required type of power supply when ordering.)

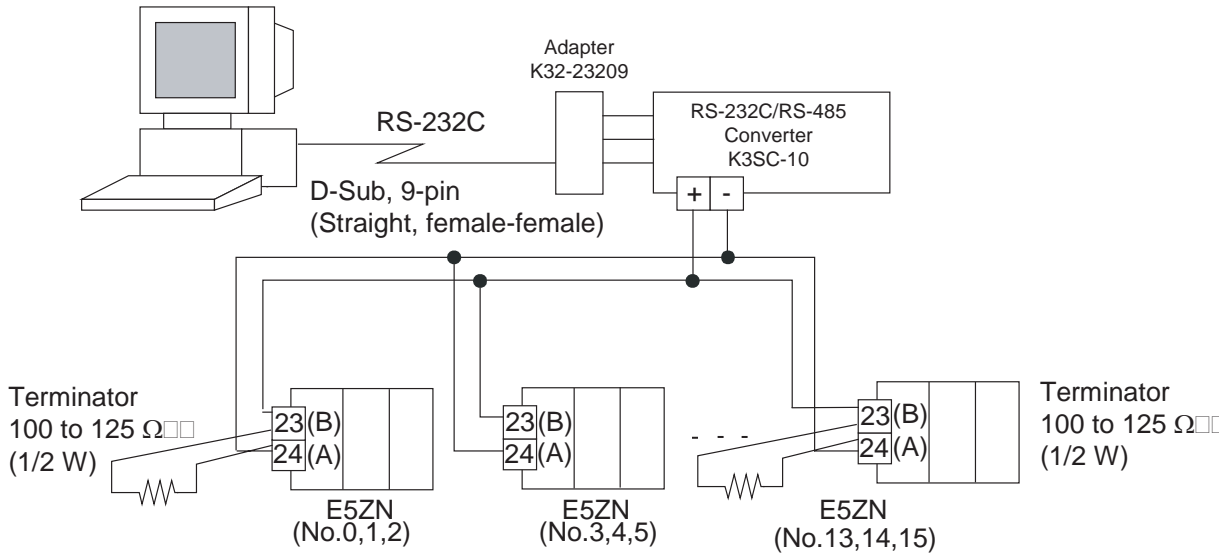

- When using an E5ZN-SDL Setting Display Unit, connect across terminals 21 and 22. Refer to Section 6 Using the E5ZN-SDL for information on how to use the Setting Display Unit.

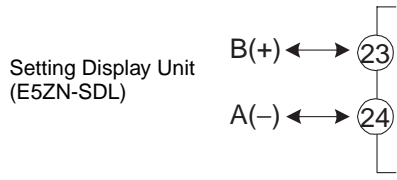

2-3 Installation Precautions

2-3-1 Ensuring Prolonged Use

Use the Temperature Controller in the following operating environment:

Temperature: -10 to $+55^{\circ}\text{C}$ (with no icing or condensation)

Humidity: 25% to 85%

When the Temperature Controller is incorporated in a control panel, make sure that the Controller's ambient temperature (not the panel's ambient temperature) does not exceed 55°C .

The life of electronic equipment like Temperature Controllers is influenced not only by the life determined by the relay switching count but also by the life of internal electronic components. The service life of components is dependent on the ambient temperature: The higher the ambient temperature becomes, the shorter the service life becomes, and vice versa. For this reason, the service life of the Temperature Controller can be extended by lowering its internal temperature.

Mounting Temperature Controllers in any way other than the specified mounting method may cause heat to build up inside the Temperature Controllers, which will shorten their service life. If there is a possibility of the ambient temperature rising to a temperature above the specified temperature range, take steps, such as installing fans, to cool the E5ZN.

Be sure that the cooling method is not cooling just the terminal block. If only the terminal block is cooled, measurement errors may occur.

2-3-2 Reducing the Influence of Noise

To reduce inductive noise, the leads on the Temperature Controller's terminal block must be wired separately from high-voltage/high-current power lines. Also, avoid wiring lines in parallel with or in the same wiring path as power lines. Other methods, such as separating conduits and wiring ducts or using shielded cables, are also effective.

Attach a surge absorber or noise filter to peripheral equipment that generates noise (in particular, motors, transformers, solenoids, or other equipment that has a magnetic coil or other inductance component).

When a noise filter is used at the power supply, first check the voltage or current, and attach the noise filter as close as possible to the Temperature Controller.

Also, install the Temperature Controller as far away as possible from equipment that generates strong, high frequencies (e.g., high-frequency welders or high-frequency sewing machines) or surges.

2-3-3 Ensuring Precise Measurements

When the thermocouple leads are extended, be sure to use a compensating lead wire matched to the type of thermocouple.

When the platinum resistance detector leads are extended, use a lead having the smallest resistance to equalize the resistance of the three leads.

Mount to DIN track that has been installed vertical to the ground.

If there is a large error in the measurement values, make sure that input compensation has been set correctly.

2-3-4 Enclosure Ratings

The enclosure ratings are shown in the following table. The E5ZN is not waterproof.

Temperature Controller Module	IP00
Terminal Units	IP00

SECTION 3

Temperature Control Settings

This section describes the basic functions of the E5ZN.

3-1	Setting the Input Type	22
3-1-1	Input Type	22
3-2	Selecting Centigrade/Fahrenheit	23
3-3	Selecting PID Control or ON/OFF Control	24
3-4	Setting Output Specifications	25
3-4-1	Control Period.	25
3-4-2	Direct (Cooling)/Reverse (Heating) Operation.	25
3-4-3	Output Allocations	26
3-5	Setting the SP	28
3-5-1	Changing the SP	28
3-6	Executing ON/OFF Control	29
3-6-1	ON/OFF Control.	29
3-6-2	Setup	30
3-7	Determining PID Constants: Autotuning and Manual Setup	31
3-7-1	Autotuning	31
3-7-2	Manual Setup	32
3-8	Alarm Outputs.	33
3-8-1	Alarm Type	33
3-8-2	Alarm Values	35
3-9	Using Heater Burnout Alarm (HBA)	36
3-9-1	HBA Detection	36
3-9-2	Operating Conditions	36
3-9-3	Calculating the Detection Current Value	37
3-10	Starting and Stopping Control.	38
3-10-1	Starting Control (RUN)/Stopping Control (STOP)	38
3-11	Operating Precautions	39

3-1 Setting the Input Type

Set the input type corresponding to the sensor used. The E5ZN specifications support two types of inputs, platinum resistance thermometers and thermocouples. Refer to the following tables and set the correct value for the temperature range and the sensor used.

3-1-1 Input Type

To set the input type to a K thermocouple from -20.0 to 500.0°C , use host communications or the E5ZN-SDL Setting Display Unit to set 1 as the set value for the input type.

List of Input Types

Type	Input type	Name	Set Value	Input Temperature Setup Range
Platinum resistance thermometer input	Platinum resistance thermometer	Pt100	0	-200 to 850°C or -300 to $1,500^{\circ}\text{F}$
			1	-199.9 to 500.0°C or -199.9 to 900.0°F
			2	0.0 to 100.0°C or 0.0 to 210.0°F
		JPt100	3	-199.9 to 500.0°C or -199.9 to 900.0°F
			4	0.0 to 100.0°C or 0.0 to 210.0°F

Type	Input type	Name	Set Value	Input Temperature Setup Range	
Thermocouple input	Thermocouple	K	0	-200 to $1,300^{\circ}\text{C}$ or -300 to $2,300^{\circ}\text{F}$	
			1	-20.0 to 500.0°C or 0.0 to 900.0°F	
		J	2	-100 to 850°C or -100 to 1500°F	
			3	-20 to 400.0°C or 0.0 to 750.0°F	
		T	4	-200 to 400°C or -300 to 700°F	
			17	-199.9 to 400.0°C or -199.9 to 700.0°F	
		E	5	0 to 600°C or 0 to $1,100^{\circ}\text{F}$	
		L	6	-100 to 850°C or -100 to $1,500^{\circ}\text{F}$	
		U	7	-200 to 400°C or -300 to 700°F	
			18	-199.9 to 400.0°C or -199.9 to 700.0°F	
		N	8	-200 to $1,300^{\circ}\text{C}$ or -300 to $2,300^{\circ}\text{F}$	
	R	9	0 to $1,700^{\circ}\text{C}$ or 0 to $3,000^{\circ}\text{F}$		
	S	10	0 to $1,700^{\circ}\text{C}$ or 0 to $3,000^{\circ}\text{F}$		
	B	11	100 to $1,800^{\circ}\text{C}$ or 300 to $3,200^{\circ}\text{F}$		
	Infrared temperature sensor ES1A	K10 to 70°C	K10 to 70°C	12	0 to 90°C or 0 to 190°F
			K60 to 120°C	13	0 to 120°C or 0 to 240°F
			K115 to 165°C	14	0 to 165°C or 0 to 320°F
(K160 to 260°C)			15	0 to 260°C or 0 to 500°F	
Analog input	0 to 50 mV	16	One of the following ranges depending on the results of scaling: $-1,999$ to $9,999$ or -199.9 to 999.9		

Note The ES1A for K160 to 260°C has been discontinued.

3-2 Selecting Centigrade/Fahrenheit

Select either °C or °F as the temperature unit.

Refer to the following table and select the value that corresponds to the desired temperature unit. The same temperature unit is used for both channel 1 and channel 2.

To use °C, use host communications and set 0 as the temperature unit or use the E5ZN-SDL Setting Display Unit and set 0.

Unit	Setting
°C	0
°F	1

Default is 0.

3-3 Selecting PID Control or ON/OFF Control

Either 2-PID control (PID control with two degrees of freedom) or ON/OFF control can be selected. The control method is selected by using host communications or the E5ZN-SDL Setting Display Unit to change the “PID/OnOff” parameter. Set the control method for channels 1 and 2 separately. Default is for PID control.

2-PID Control

For PID control, the “proportional band (P),” “integral time (I),” and “derivative time (D)” parameters must be set.

These PID constants can be set by autotuning or manual setup.

ON/OFF Control

In ON/OFF control, the control output is turned ON when the PV is lower than the current SP, and the control output is turned OFF when the PV is higher than the current SP (for reverse operation).

3-4 Setting Output Specifications

3-4-1 Control Period

- Set the output period (control period). Though a shorter period provides better control performance, we recommend setting the control period to 20 seconds or more when using a relay output for heater control (to increase the effective life of the relay). If necessary, readjust the control period according to the results of trial operation with the control period parameters set to their defaults.
- Use host communications or the E5ZN-SDL Setting Display Unit to set the “heating control period” and “cooling control period” parameters. Default is 2 s.
- The “cooling control period” parameter is used only in heating and cooling control.
- Set the control periods for channels 1 and 2 separately.

3-4-2 Direct (Cooling)/Reverse (Heating) Operation

- Direct operation refers to control where the manipulated variable (MV) is increased for an increase in the PV (e.g., cooling). Alternatively, reverse operation refers to control where the manipulated variable (MV) is decreased for an increase in the PV (e.g., heating).

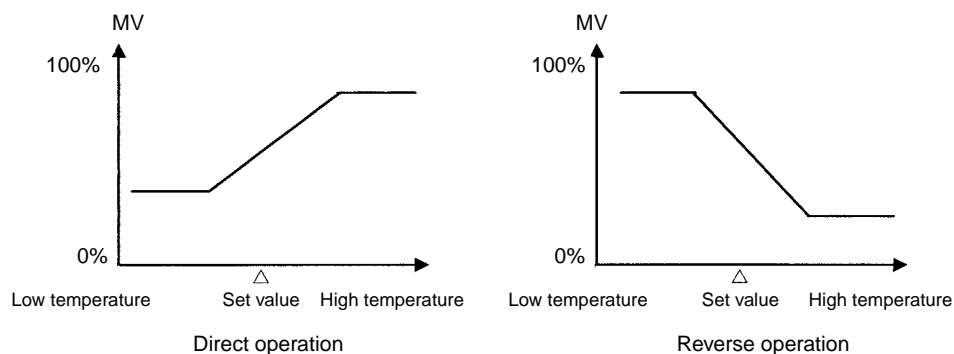

- For example, when the PV (temperature) is lower than the SP (temperature) in a heating control system, the manipulated variable (MV) increases by the difference between the PV and the set value. Reverse operation is thus used in a heating control system and direct operation is used in a cooling control system.
- Use host communications or the E5ZN-SDL Setting Display Unit to set “Direct/reverse operation” to “0: Reverse” or “1: Direct.” Default is for reverse operation (heating).
- Set the direct/reverse operation for channels 1 and 2 separately.

3-4-3 Output Allocations

- The E5ZN has four outputs. The following tables shows the default functions allocated to each output terminal.

Name	Set value	Function				
		Analog output models E5ZN-2C□F03□-FLK		Pulse output models E5ZN-2Q□H03□-FLK E5ZN-2T□H03□-FLK		
OUT1 (control output 1) Terminals 7 and 8	0	ch1	Heating control output	ch1	Heating control output	
	1		Cooling control output (See note.)		Cooling control output (See note.)	
	2		Alarm 1 and sensor error alarm OR output		Alarm 1 and sensor error alarm OR output	
	3		Alarm 2 output		Alarm 2 output	
	4		Alarm 3 output		Alarm 3 output	
	5	ch2	Heating control output	ch2	Heating control output	
	6		Cooling control output (See note.)		Cooling control output (See note.)	
	7		Alarm 1 and sensor error alarm OR output		Alarm 1 and HB alarm OR output	
	8		Alarm 2 output		Alarm 2 output	
	9		Alarm 3 output		Alarm 3 output	
	10	ch1	SP transfer output	/		
	11		Ramp SP transfer output			
	12		PV transfer output			
	13		Heating MV transfer output			
	14		Cooling MV transfer output			
	15	ch2	SP transfer output			
	16		Ramp SP transfer output			
	17		PV transfer output			
	18		Heating MV transfer output			
19	Cooling MV transfer output					
OUT2 (control output 2) Terminals 1 and 2	0 to 19 (9)	Same as above.			Same as above.	
	5	ch2	Heating control output		ch2	Heating control output
SUB1 (auxiliary output 1) Terminals 13 and 15	0	ch1	Heating control output		ch1	Heating control output
	1		Cooling control output (See note.)			Cooling control output (See note.)
	2		Alarm 1 and sensor error alarm OR output			Alarm 1 and HB alarm OR output
	3		Alarm 2 output			Alarm 2 output
	4		Alarm 3 output			Alarm 3 output
	5	ch2	Heating control output		ch2	Heating control output
	6		Cooling control output (See note.)			Cooling control output (See note.)
	7		Alarm 1 and sensor error alarm OR output	Alarm 1 and HB alarm OR output		
	8		Alarm 2 output	Alarm 2 output		
9	Alarm 3 output		Alarm 3 output			
SUB2 (auxiliary output 2) Terminals 14 and 15	0 to 9	Same as above.		Same as above.		
	7	ch2	Alarm 1 and sensor error alarm OR output	ch2	Alarm 1 and HB alarm OR output	

Note When “Cooling control output for ch 1” has been set for an output, ch 1 performs heating/cooling control. When “Cooling control output for ch 2” has been allocated to the output, ch 2 performs heating/cooling control.

Name	Set value	Function		
		Analog output models E5ZN-2C□F03□-FLK	Pulse output models E5ZN-2Q□H03□-FLK E5ZN-2T□H03□-FLK	
SUB3 (auxiliary output 3) Terminals 16 and 17	0	ch1	Heating control output	
	1		Cooling control output (See note.)	
	2		Alarm 1 and sensor error alarm OR output	
	3		Alarm 2 output	
	4		Alarm 3 output	
	5	ch2	Heating control output	
	6		Cooling control output (See note.)	
	7		Alarm 1 and sensor error alarm OR output	
	8		Alarm 2 output	
	9		Alarm 3 output	
	10	ch1	SP transfer output	
	11		Ramp SP transfer output	
	12		PV transfer output	
	13		Heating MV transfer output	
	14		Cooling MV transfer output	
	15	ch2	SP transfer output	
	16		Ramp SP transfer output	
	17		PV transfer output	
	18		Heating MV transfer output	
19	Cooling MV transfer output			
SUB4 (auxiliary output 4) Terminals 16 and 18	0 to 19	Same as above.		
	17	ch2	PV transfer output	

Note When “Cooling control output for ch 1” has been set for an output, ch 1 performs heating/cooling control. When “Cooling control output for ch 2” has been allocated to the output, ch 2 performs heating/cooling control.

- With analog output models (E5ZN-2C□F03□-FLK), if alarm output is allocated to OUT1 (control output 1), OUT2 (control output 2), SUB3 (auxiliary output 3), or SUB4 (auxiliary output 4), or if the control method is set to ON/OFF control, the ON output will be 100% output and the OFF output will be 0% output.

Allocating Alarm 2 Output for ch 1 to SUB2 Auxiliary Output 2

Use host communications or the E5ZN-SDL Setting Display Unit to set 3 as the auxiliary output 2 allocation.

Allocating PV Transfer Output for ch 2 to SUB3 Auxiliary Output 3

Use host communications or the E5ZN-SDL Setting Display Unit to set 17 as the auxiliary output 3 allocation.

3-5 Setting the SP

3-5-1 Changing the SP

Use host communications or the E5ZN-SDL Setting Display Unit to set the SP. Default is 0°C.

In this example, the SP will be changed from 0°C to 200°C.

- Use host communications to set the “SP” parameter to “000000C8H (200°C).”
- To use the Setting Display Unit to change the SP, select the channel to be changed and use the Up and Down Keys to set the SP to 200°C.
- To start control, an operation start (RUN) must be specified after changing the SP. Refer to *3-10 Starting and Stopping Control* for details.

3-6 Executing ON/OFF Control

In ON/OFF control, the control output turns OFF when the PV (temperature) reaches the preset SP. When the control output turns OFF, the temperature begins to fall and the control output turns ON again. This operation is repeated between certain points. How much the temperature must fall in relation to the SP before control output turns ON again is determined by the "heating hysteresis" parameter. Also, whether the manipulated variable (MV) must be increased or decreased in response in an increase or decrease in the PV is determined by the "direct/reverse operation" parameter.

3-6-1 ON/OFF Control

Either 2-PID control or ON/OFF control can be set using the "PID/OnOff" parameter. When this parameter is set to "PID," 2-PID control is used, and when set to "OnOff," ON/OFF control is used. The default is "PID."

Hysteresis

- In ON/OFF control, hysteresis is provided in the program when switching between ON and OFF to stabilize operation. The hysteresis width provided during ON/OFF control is simply referred to as "hysteresis." Heating control output and cooling control output functions are set in the "heating hysteresis" and "cooling hysteresis" parameters.
- In standard heating or cooling control, the hysteresis can only be set at the "heating hysteresis" parameter.
- The default is 1.0.

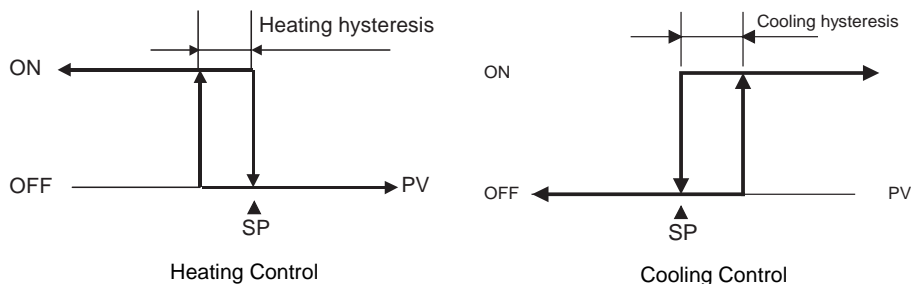

3-position Control

In heating and cooling control, a dead band (an area where both control outputs are 0) can be set between the heating and cooling sides, enabling 3-position control.

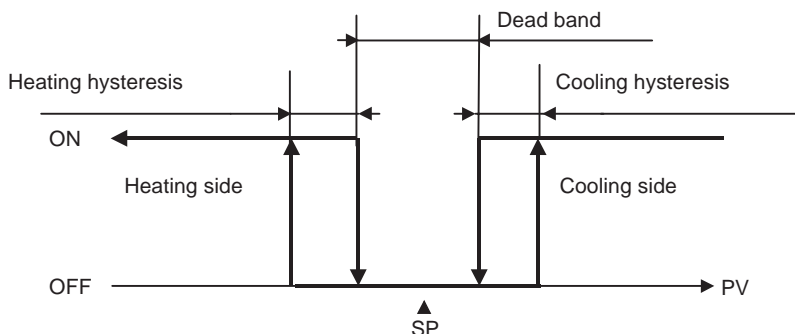

3-6-2 Setup

To execute ON/OFF control, set the SP, the PID/OnOff parameter, and the hysteresis.

Setting ch1 to ON/OFF Control with an SP of 200°C and Hysteresis of 2°C

Use host communications or the E5ZN-SDL Setting Display Unit to make the following settings.

- Set the PID/OnOff parameter for ch1 to "0: ON/OFF"
- Set the SP for ch1 to 200.
- Set the hysteresis for ch1 to 2.0.

3-7 Determining PID Constants: Autotuning and Manual Setup

3-7-1 Autotuning

- When executing autotuning, the optimum PID constants for the SP during program execution are automatically set by changing the manipulated variable (MV) to calculate the characteristics of the control target. This is called the limit cycle method.
- Autotuning cannot be executed while stopped or during manual mode or ON/OFF control.
- To start autotuning, use host communications operation commands or the E5ZN-SDL Setting Display Unit and set “AT execute/stop” to “execute.”
- To stop autotuning, use host communications operation commands or the E5ZN-SDL Setting Display Unit and set “AT execute/stop” to “stop.”
- During execution of autotuning, only “communications writing,” “RUN/STOP,” “AT execute/stop,” and “auto/manual” parameters can be changed. No other settings can be changed.
- If “RUN/STOP” is set to “STOP” during execution of autotuning, autotuning and operation will stop. Autotuning will not start again even if “RUN/STOP” is set to “RUN” again.

3-7-2 Manual Setup

To set PID parameters manually, use host communications or the E5ZN-SDL Setting Display Unit and set values for the “proportional band” (P), “integrated time” (I) and “derivative time” (D) parameters.

- Note**
1. When control characteristics are already known, the PID parameters can be set directly to adjust control. PID parameters are set in the “proportional band” (P), “integrated time” (I), and “derivative time” (D) parameters.
 2. When PID constants I (integral time) and D (derivative time) are set to 0, control is executed according to proportional operation. The default SP becomes the center value of the proportional band.

When P (Proportional Band) Is Changed

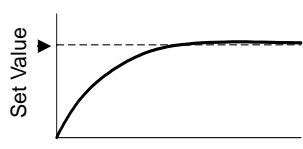
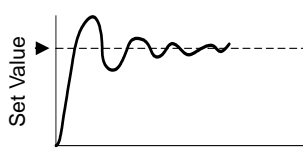
When P is increased		The curve rises gradually, and a long adjustment time is required, but there is no overshooting.
When P is decreased		Overshooting and hunting occur, but the SP is quickly reached after which the curve stabilizes.

When I (Integral Time) Is Changed

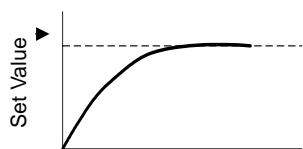
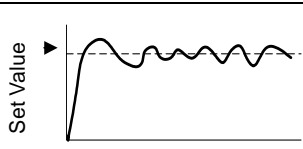
When I is increased		It takes a long time for the PV to reach the SP. It takes time to adjust, but there is little overshooting, undershooting, and hunting.
When I is decreased		Overshooting, undershooting, and hunting occur, but the curve rises quickly.

When D (Derivative Time) Is Adjusted

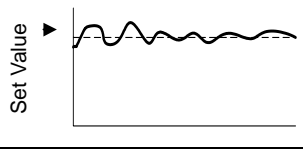
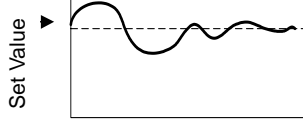
When D is increased		Overshooting, undershooting, and adjustment time are reduced, but fine hunting occurs on changes in the curve itself.
When D is decreased		Overshooting and undershooting increase, and it takes time for the PV to return to the SP.

3-8 Alarm Outputs

This section describes the “alarm type,” “alarm value,” “upper limit alarm,” and “lower limit alarm” parameters.

3-8-1 Alarm Type

Alarms 1 and 2

Set value	Alarm type	Alarm output operation	
		When alarm value X is positive	When alarm value X is negative
0	Alarm function OFF	Output OFF	
1 (See note 1.)	Upper and lower limit		See note 2.
2	Upper limit		
3	Lower limit		
4 (See note 1.)	Upper and lower limit range		See note 3.
5 (See notes 1, 6.)	Upper and lower limit alarm with standby sequence		See note 4.
		See note 5.	
6 (See note 6.)	Upper limit alarm with standby sequence		
7	Lower limit alarm with standby sequence		
8	Absolute-value upper limit		
9	Absolute-value lower limit		
10 (See note 6.)	Absolute-value upper limit with standby sequence		
11 (See note 6.)	Absolute-value lower limit with standby sequence		

Note 1. With set values 1, 4, and 5, the upper and lower limits can be set independently for each alarm point and are expressed as “L” and “H.”

2. Operation for set value 1 (upper and lower limit alarms) would be as follows:

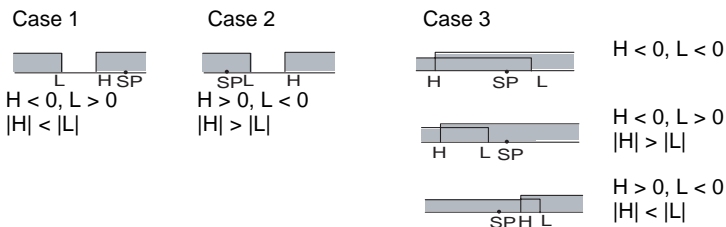

3. Operation for set value 4 (upper and lower limit ranges) would be as follows:

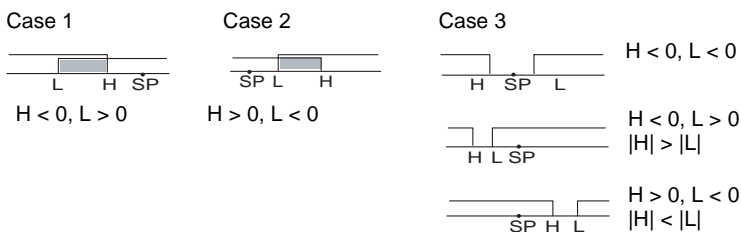

4. Set value 5 (upper and lower limit alarms with standby sequence):
For upper and lower limit alarm cases in the above diagram, hysteresis is always OFF for cases 1 and 2 if the upper and lower limits overlap. Hysteresis is always OFF for case 3.
5. Set value 5 (upper and lower limit alarms with standby sequence):
Hysteresis is always OFF if the upper and lower limits overlap.
6. Refer to 4-2 Alarm Hysteresis for information on standby sequences.

Alarm 3

Set value	Alarm type	Alarm output operation	
		When alarm value X is positive	When alarm value X is negative
0	Alarm function OFF	Output OFF	
1	upper and lower limit (deviation)		Always ON.
2	Upper limit (deviation)		
3	Lower limit (deviation)		
4	Upper and lower limit range (deviation)		Always OFF.
5	Upper and lower limit alarm with standby sequence (deviation)		Always OFF.
6	Upper limit alarm with standby sequence (deviation)		
7	Lower limit alarm with standby sequence (deviation)		

Set value	Alarm type	Alarm output operation	
		When alarm value X is positive	When alarm value X is negative
8	Absolute-value upper limit		
9	Absolute-value lower limit		
10	Absolute-value upper limit with standby sequence		
11	Absolute-value lower limit with standby sequence		

Use host communications or the E5ZN-SDL Setting Display Unit to set the alarm type separately for each alarm for alarms 1 to 3. Defaults are “2: Upper limit.” Set the alarms separately for each channel.

3-8-2 Alarm Values

Alarm values are indicated by “X” in the table in the above section. When the upper and lower limits are set independently, “H” is displayed for upper limits, and “L” is displayed for lower limits.

When upper and lower limit, upper and lower limit range, or upper and lower limit alarm with standby sequence have been selected as the alarm type, set the alarm upper limit and alarm lower limit parameters separately.

When other alarm types have been selected, set the alarm value parameter.

The upper and lower limits cannot be set independently for alarm 3.

3-9 Using Heater Burnout Alarm (HBA)

3-9-1 HBA Detection

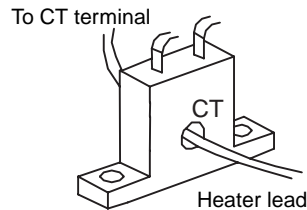

Heater burnout detection works as follows:

- 1,2,3...**
1. Pass the heater lead through the current transformer (CT) hole. For specifications, models, and external dimensions of current transformers that can be used on this Controller, refer to *Current Transformer (CT)* in *Appendix A*.
 2. When current flows through the lead, the current transformer generates AC current proportional to the current value. The E5ZN measures this AC current to calculate the current flowing to the heater.
 3. If the heater is burned out, the current measured at the current transformer will decrease. If this value becomes larger than the value set as the heater burnout set value, the output is turned ON to indicate a heater burnout alarm.
 - Set the heater burnout detection value in the “heater burnout detection” parameter. To monitor the current value of the current transformer, use the “heater current monitor” parameter.
 - When you are not using the HBA function, set the “heater burnout” parameter to “0: OFF.”
 - Make separate heater burnout settings for ch1 and ch2.

3-9-2 Operating Conditions

- Be sure to connect the CT to the E5ZN, and pass the heater lead through the CT hole.
- Turn ON the heater at the same time as or before turning the E5ZN. If the heater is turned ON after turning the E5ZN, the heater burnout alarm will activate.
- Control is continued even if the heater burnout alarm is turned ON. (That is, the E5ZN attempts to control heaters for which the heater burnout alarm has not occurred.)
- Heater burnout detection is performed when the control output is continuously ON for 190 ms or more.
- The rated current value may sometimes differ slightly from the actual current flowing to the heater. Check the current value in an actual operating state in the “heater current monitor” parameter.
- If there is little difference between the current in a normal state and the current in the burnout state, detection may be unstable. On a heater with a current 10.0 A or less, maintain a difference of 1.0 A or more. On a heater with a current 10.0 A or more, maintain a difference of 2.5 A or more.
- The HBA function cannot be used when the heater is controlled by a phase control system or cycle control system. Also, 3-phase heaters cannot be used.

Note To detect heater burnout for a 3-phase heater, use the K2CU-F□□A-□GS (with gate input terminal). For details, see the data sheet.

3-9-3 Calculating the Detection Current Value

- Calculate the set value by the following equation:

$$\text{Set value} = \frac{(\text{Normal current} + \text{Current at heater burnout})}{2}$$

- To set the value of the heater burnout when two or more heaters are connected through the CT, use the current value of the smallest heater connected. If all the heaters have the same current value, use the current value when one of the heaters burns out.
- Make sure that the following conditions are satisfied:
 Heater of current 10.0 A or less:
 Normal current – Current at heater burnout ≥ 1 A
 (When the resultant current is less than 1 A, detection is unstable.)
 Heater of current 10.0 A or more:
 Normal current –
 Current at heater burnout ≥ 2.5 A
 (When the resultant current is less than 2.5 A, detection is unstable.)
- The setting range is 0.1 to 49.9 A. Heater burnout is not detected if the set value is 0.0 or 50.0. If the set value is 0.0, the heater burnout alarm is turned OFF, and if the set value is 50.0, the heater burnout alarm is turned ON.
- Set the total current value at normal heater operation to 50 A or less.

Application Examples

Example 1 Using a 200 VAC, 1 kW Heater for OUT1

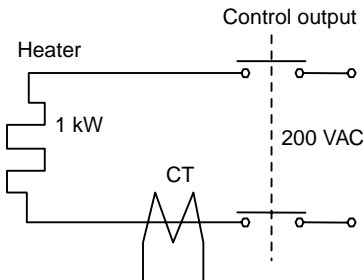

$$\text{Current during normal operation} = \frac{1000}{200} = 5 \text{ A } (< 10 \text{ A})$$

$$\text{Current at heater burnout} = 0 \text{ A}$$

$$\text{Set value} = \frac{5 + 0}{2} = 2.5 \text{ A}$$

$$(\text{Normal current} - \text{Current at heater burnout}) = 5 - 0 = 5 \text{ A } (\geq 1 \text{ A})$$

Example 2 Using Three 200 VAC, 1 kW Heaters for OUT2

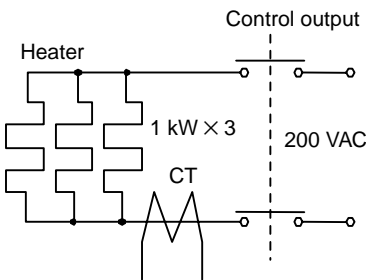

$$\text{Current during normal operation} = \frac{1000}{200} \times 3 = 15 \text{ A } (\geq 10 \text{ A})$$

$$\text{Current at burnout of one heater} = \frac{1000}{200} \times 2 = 10 \text{ A}$$

$$\text{Set value} = \frac{15 + 10}{2} = 12.5 \text{ A}$$

$$(\text{Normal current} - \text{Current at heater burnout}) = 15 - 10 = 5 \text{ A } (\geq 2.5 \text{ A})$$

3-10 Starting and Stopping Control

3-10-1 Starting Control (RUN)/Stopping Control (STOP)

Set the RUN/STOP operation command to RUN to start E5ZN control. To stop control, set the RUN/STOP operation command to STOP.

There are three ways to set the RUN/STOP operation command.

1,2,3...

1. Using host communications.
2. Using the E5ZN-SDL Setting Display Unit.
3. Using an external contact for an event input.

Operation after Turning ON the Power Supply

- Set the operation status after the power supply for the E5ZN has been turned ON. Choose one of the following two statuses.

Set value	Operation
Stop	Control will always stop when the power supply is turned ON.
Continue	Returns control to the status for the last time the power supply was turned OFF.

- The following table gives additional information for each of the operation settings.

Operation after power turned ON	Additional information
Stop	When the power is turned ON, the RUN/STOP setting will always be set to STOP and the E5ZN will start when the command is changed to RUN.
Continue	<ol style="list-style-type: none"> 1. If the E5ZN was in manual mode the last time the power was turned OFF, it will be in manual mode when the power is turned ON and the manual manipulated variable will be 0%. 2. When the setting for operation after the power is turned ON is changed from “stop” to “continue,” the “RUN/STOP” operation command will be set to “STOP.” This setting change will always be saved to internal non-volatile memory even if the E5ZN is in RAM write mode. 3. When the E5ZN is used in RAM write mode, change the “RUN/STOP” operation command from the host communications and then be sure to execute the RAM DATA SAVE operation command. If the power is turned OFF before the RAM DATA SAVE operation command is executed, the operation status will not be continued.

- Default is stop.
- This parameter setting is used by both channels.

3-11 Operating Precautions

- 1,2,3...**
1. About four seconds is required for outputs to turn ON after the power is turned ON. Take this into consideration when the Temperature Controller is incorporated into a sequence circuit.
 2. The Temperature Controller may be subject to the influence of radio interference if used near a radio, TV, or wireless equipment.

SECTION 4

Settings Used Only when Required

4-1	Shifting Input Values.	42
4-1-1	Shifting Input	42
4-1-2	Calculating Input Shift Values for Non-contact Sensors	43
4-2	Alarm Hysteresis.	46
4-2-1	Standby Sequence.	46
4-2-2	Alarm Latch	46
4-2-3	Close in Alarm/Open in Alarm.	47
4-3	Setting Scaling Upper and Lower Limits (Analog Input).	48
4-3-1	Analog Input.	48
4-4	Executing Heating and Cooling Control.	49
4-4-1	Heating and Cooling Control	49
4-5	Using the Event Input	50
4-5-1	Setting the Event Input	50
4-5-2	Using Control Start (RUN)/Control Stop (STOP)	50
4-5-3	Using the Multi-SP.	50
4-6	Setting the SP Upper and Lower Limit Range	52
4-6-1	SP Limits	52
4-7	SP Ramp Function: Limiting SP Change Rate	53
4-7-1	SP Ramp	53
4-8	Key Protection.	54
4-8-1	Key Protect Function	54
4-9	Manual Mode	56
4-9-1	Auto/Manual.	56
4-9-2	Manual Manipulated Variable.	57
4-10	Reading Temperatures for Multiple E5ZN Units	58
4-10-1	PV Hold	58
4-11	Remote PV Mode	59
4-11-1	Using Remote PV Mode.	59
4-12	Using Transfer Output.	60
4-12-1	Transfer Output Types	60
4-12-2	Transfer Output Scaling	60

4-1 Shifting Input Values

4-1-1 Shifting Input

- The measurement value calculated by the sensor is normally the same as the actual PV. An input shift can be applied if the measurement value requires shifting.
- Two types of input shift can be used. A one-point shift is used to simply shift the measurement value. For a two-point shift, the shift amount for the lower limit and upper limit are set separately and both the measurement values and the slope are shifted.

One-point Shift:

- With a one-point shift, the value set for the “Temperature input shift” parameter is applied to the entire temperature input range. For example, if the input shift value is set to 1.2°C and the measurement value is 200°C, the PV will be stored as 201.2°C after the input shift has been applied.

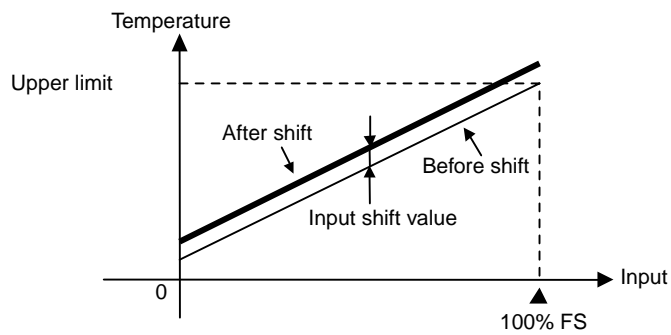

- Default for both ch1 and ch2 is 0.

Two-point Shift:

- The shift amount and slope can be shifted by setting different shift values for the upper and lower limits of the sensor range. Setting different shift values means that the slope of the line will change. For example, if the upper limit is set to “2°C” and the lower limit is set to “1°C,” the sensor range is shifted by 1.5°C at a 50% input.
- Set the upper limit in the “upper limit temperature input shift value” parameter and the lower limit in the “lower limit temperature input shift value” parameter.
- The default for the upper and lower limit temperature input shift values is 0 for both ch1 and ch2.
- A two-point shift is supported by the following models.

Upgraded pulse output models and analog output models:

Input type = Platinum-resistance thermometer, thermocouple, infrared temperature sensor

Previous pulse output models:

Input type = Infrared temperature sensor

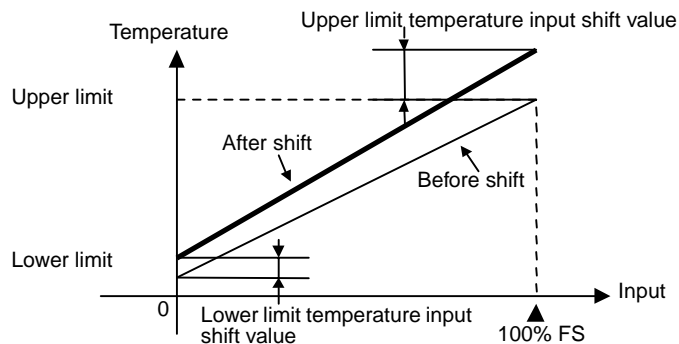

4-1-2 Calculating Input Shift Values for Non-contact Sensors

When an ES1A Infrared Temperature Sensor is connected to the E5ZN, an offset of several degrees to several tens of degrees can occur due to internal impedance. Furthermore, if the rate of heat radiation of the control target is not 0.9, errors may occur.

For this reason, offset the readout value using one-point or two-point shift as described in this section. This offset occurs because a bias current for detecting Controller sensor error flows to the output impedance of the infrared temperature sensor.

Preparations

- 1,2,3...
1. Set the temperature range matching the input specifications of the infrared temperature sensor.
 2. Prepare a thermometer capable of measuring the temperature of the control target as shown in *Figure 1* so that one-point shift or two-point shift can be performed.

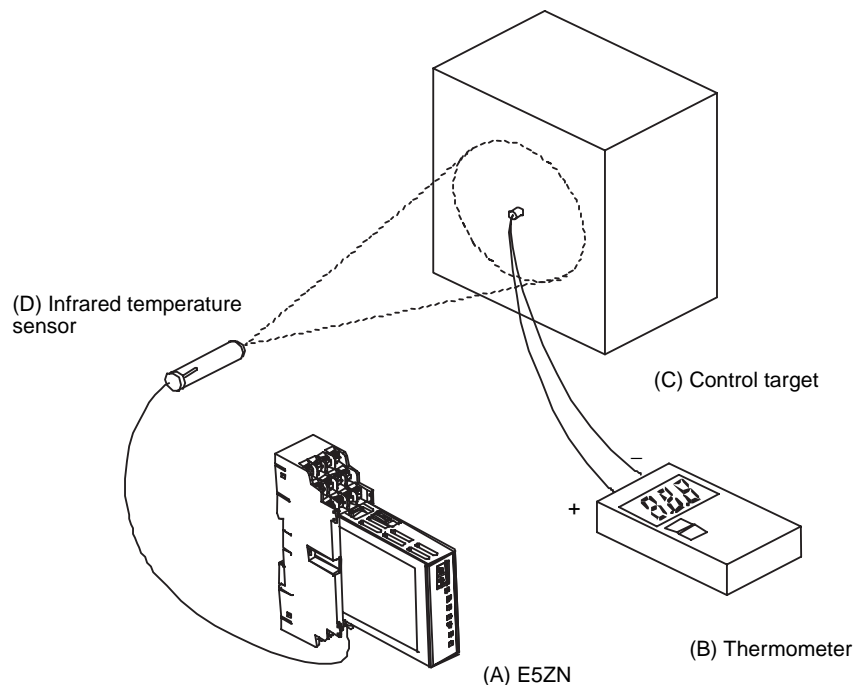

Figure 1 Configuration when Compensating an Infrared Temperature Sensor

One-point Shift

- 1,2,3...
1. In the configuration shown in *Figure 1*, bring the SP to near the value at which the temperature of the control target is to be controlled. Let's assume that the control target temperature (C) and the control target temperature (B) are the same.
 2. Check the control target temperature (B) and the Controller readout (A). Take the following value as the input shift value, and set the same numerical values for both the lower limit temperature input shift value and the upper limit temperature input shift value.

$$\text{Control target temperature (B) - Controller readout (A)}$$

Figure 2 shows the effect of one-point temperature input shift.

- After you have set the input shift values, check Controller readout (A) and control target temperature (B). If they are almost the same, the temperature input shift value is correct.

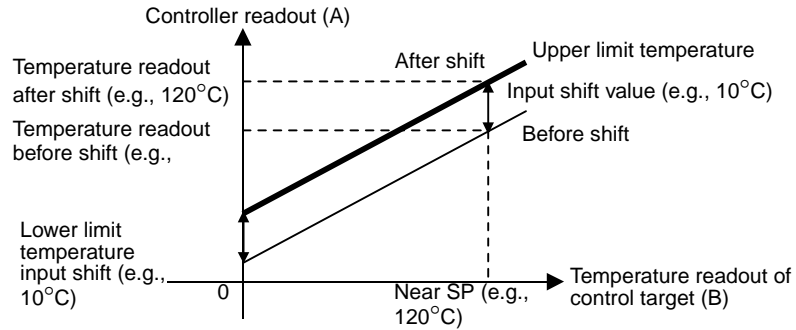

Figure 2 One-point Temperature Input Shift

Two-point Shift

Use two-point input shift if you want to increase the accuracy of the readout values across the range of the sensor.

1,2,3...

- The Controller readout will be shifted at two points, near room temperature and near the value at which the temperature of the control target is to be controlled. For this reason, bring the control target temperature to near room temperature and to near the SP, and check the control target temperature (B) and Controller readout (A) at both points.
- Using equations 1 and 2, calculate the upper and lower limit temperature input shift values from values obtained in step 1.

Figure 3 shows the effect of using two-point temperature input shift.

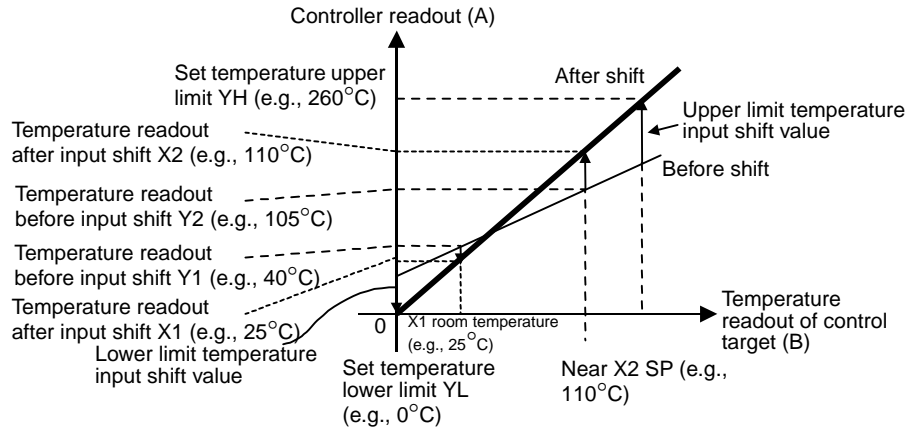

Figure 3 Two-point Temperature Input Shift

- Use the following equation to calculate the lower limit temperature input shift value.

$$\text{Equation 1 } \frac{Y_L - Y_1}{Y_2 - Y_1} \times \{(X_2 - Y_2) - (X_1 - Y_1)\} + (X_1 - Y_1)$$

- Use the following equation to calculate the upper limit temperature input shift value.

$$\text{Equation 2 } \frac{Y_H - Y_1}{Y_2 - Y_1} \times \{(X_2 - Y_2) - (X_1 - Y_1)\} + (X_1 - Y_1)$$

- After you have set the calculated values for the lower limit temperature input shift value and the upper limit temperature input shift value, check the Controller readout (A) and control target temperature (B) at both points.

4. Although the input shift was performed at two points, close to room temperature (ambient temperature) and near to the SP, select points close to each end of the sensor range to improve accuracy across the full range of sensor measurement.

Example of Two-point Temperature Input Shift

In this example, we use the ES1A K 160 to 260°C specification, where the input temperature setting range is 0 to 260°C.

In equations 1 and 2, the set temperature lower limit YL is 0°C and the set temperature upper limit YH is 260°C. Check the temperature of the control target.

We will assume that when the room temperature X1 is 25°C, the readout on the Controller Y1 is 40°C, and when the temperature near the SP X2 is 110°C, the readout on the Controller Y2 is 105°C.

Lower Limit Temperature Input Shift Value

$$\frac{0 - 25}{110 - 25} \times \{(110 - 105) - (25 - 40)\} + (25 - 40) = -20.9 \text{ (}^\circ\text{C)}$$

Upper Limit Temperature Input Shift Value

$$\frac{260 - 25}{110 - 25} \times \{(110 - 105) - (25 - 40)\} + (25 - 40) = 40.3 \text{ (}^\circ\text{C)}$$

4-2 Alarm Hysteresis

- The hysteresis of alarm outputs when alarms are switched ON and OFF can be set as follows:

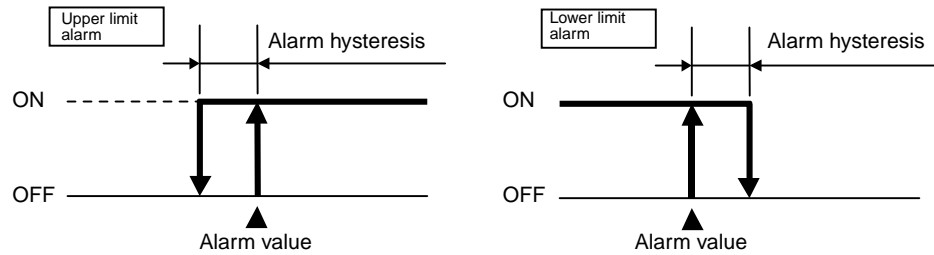

- Alarm hysteresis is set independently for each alarm in the “alarm hysteresis 1” to “alarm hysteresis 3” parameters.
- Default is 0.2 for both ch1 and ch2.

4-2-1 Standby Sequence

- The standby sequence allows alarm outputs to be temporarily disabled until the temperature leaves the alarm range (i.e., until an alarm condition does not exist). Once the alarm range has been left, the alarm output will then operate whenever the alarm range is entered.
- For example, in a standard heating application, if you use the standard “low alarm,” the alarm output would be turned ON when the Controller is turned ON. However, if the standby sequence is used, the alarm output is disabled during the warmup period until the temperature goes above the alarm SP. The alarm becomes active after the low alarm SP has been exceeded and the output is turned ON if the temperature falls below the alarm SP.

Restart

The standby sequence is ended when an alarm is output. It is, however, restarted (reset) later by the conditions specified in the “standby sequence restart” parameter.

4-2-2 Alarm Latch

- The alarm latch function holds the alarm output ON once it has been turned ON regardless of the temperature.
- The alarm latch can be canceled by turning OFF the power.
- The alarm latch can be canceled by executing operation commands using communications. This function is supported by upgraded pulse output models and analog output models only.
- Default is “0: OFF.”

4-2-3 Close in Alarm/Open in Alarm

- When the E5ZN is set to “close in alarm,” the status of the alarm output function is normally open. When set to “open in alarm,” the status of the alarm output standby is normally closed.
- The close in alarm/open in alarm status can be set independently for each alarm.
- The close in alarm/open in alarm settings are set in the “Alarm 1 to 3 open in alarm” parameters.
- Default is “0: Close in alarm.”
- When “alarm 1 open in alarm” is set, the heater burnout alarm and input error outputs are both open in alarm.

Setting	Alarm output function	Alarm output	Operation indicator (LED)
Close in alarm	ON	ON	Lit
	OFF	OFF	Not lit
Open in alarm	ON	OFF	Lit
	OFF	ON	Not lit

- The alarm output will turn OFF (open) for about four seconds when power is interrupted or after the power is turned ON regardless of the close in alarm/open in alarm setting.

Summary of Alarm Operations

The figure below visually summarizes the above description of alarm operations when a lower limit alarm with standby sequence and close in alarm are set.

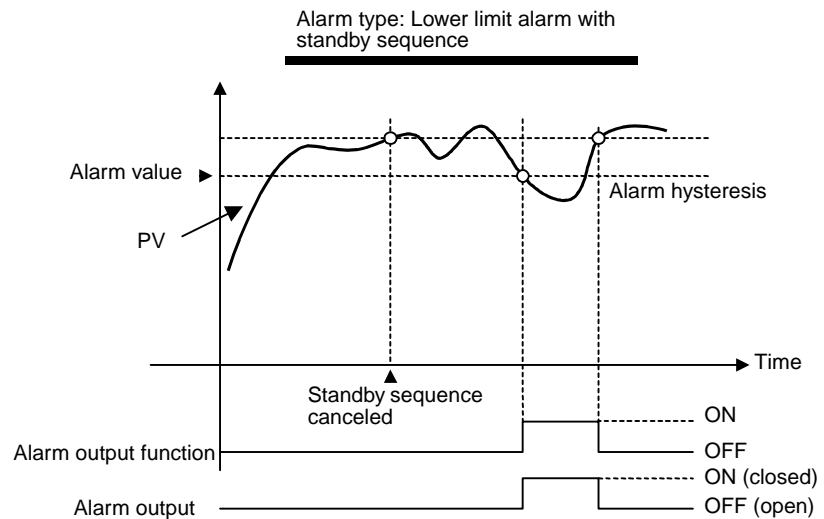

4-3 Setting Scaling Upper and Lower Limits (Analog Input)

4-3-1 Analog Input

- An analog voltage input can be scaled matched to the control application.
- Scaling is set in the “scaling upper limit,” “scaling lower limit,” and “decimal point” parameters. These parameters cannot be used when a temperature input is selected.
- The “scaling upper limit” parameter sets the physical quantity to be expressed by the upper limit of input, and the “scaling lower limit” parameter sets the physical quantity to be expressed by the lower limit of input. The “decimal point” parameter specifies the number of digits past the decimal point.
- The following figure shows a scaling example for an input of 0 to 50 mVDC for humidity. After scaling, the humidity(%) can be directly read.

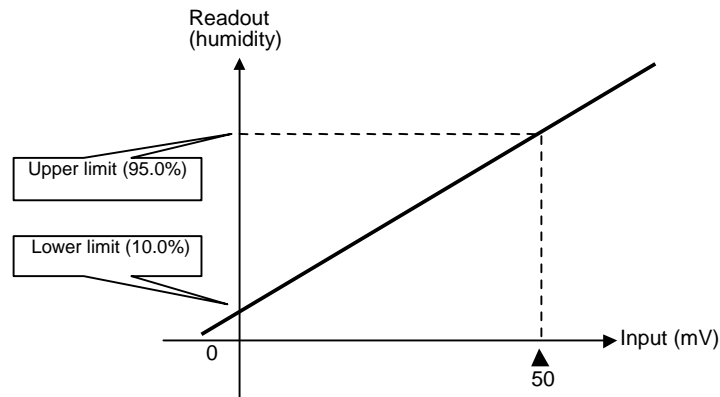

In this example, the scaling upper and lower limits are set so that inputs 0 to 50 mV are scaled to 10.0% to 95.0%.

Scaling upper limit: 950

Scaling lower limit: 100

Decimal point position: 1

4-4 Executing Heating and Cooling Control

4-4-1 Heating and Cooling Control

Heating and cooling control operates when a cooling control output has been allocated to one of the outputs. For example, to set heating and cooling control for ch1, allocate “cooling control output for ch1” to one of the outputs.

- When heating and cooling control is selected, the “dead band” and “cooling coefficient” parameters can be used.
- Refer to 3-4 *Setting Output Specifications* for allocation methods for heating and cooling control.
- The default allocation is “heating control output.”

Dead Band

The dead band is set with the SP as its center. The dead band width is set in the “dead band” parameter in the adjustment level. Setting a negative value produces an overlap band.

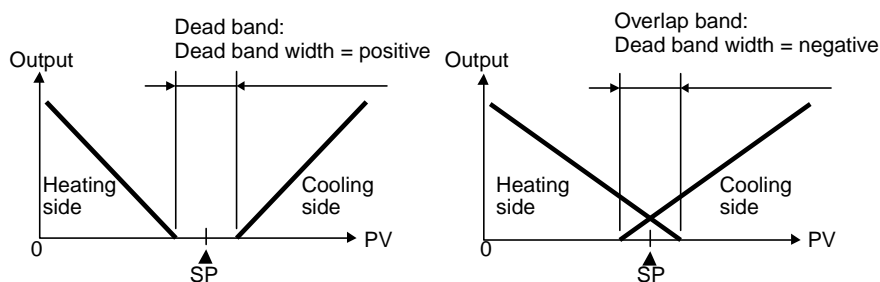

Default is “0.0 EU.”

Cooling Coefficient

If the heating and cooling characteristics of the control target differ enough to prevent satisfactory control characteristics from being obtained using the same PID constants, control between the heating and cooling sides can be balanced by adjusting the proportional band (P) at the cooling side control output using the cooling coefficient. In heating and cooling control, P at the heating or cooling control output sides is calculated using the following formula: Heating side P = P

$$\text{Cooling side P} = \text{Heating side P} \times \text{Cooling coefficient}$$

The cooling coefficient is applied to heating side P to obtain cooling side output control whose characteristics (i.e., the cooling side P) differ from those on the heating side control output.

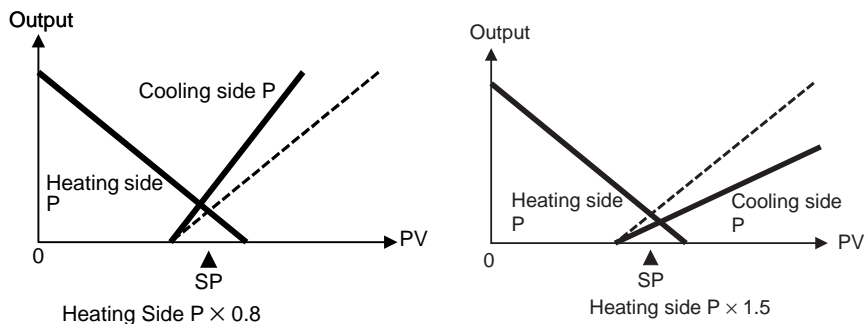

4-5 Using the Event Input

4-5-1 Setting the Event Input

The event input, which uses an external contact input, is set using the “No. of multi-SP uses” and “event input assignment” settings.

The multi-SP function is allocated for event input by setting the “No. of multi-SP uses” parameter. The RUN/STOP control function is set using the “event input allocation” parameter.

When the event input is not used as a multi-SP function, the multi-SP function can be used via host communications or the E5ZN-SDL Setting Display Unit by setting the “multi-SP use” parameter.

The following table shows the relationship between the three settings.

Event input use	Settings			Changing multi-SP via communications or Setting Display Unit
	Number of Multi-SP uses	Event input allocation	Multi-SP use	
None	0	None	ON	Possible
			OFF	Not possible
RUN/STOP		RUN/STOP	ON	Possible
			OFF	Not possible
Multi-SP	1			Not possible

The shaded areas indicate the default values for the “No. of multi-SP uses,” “event input allocation,” and “multi-SP use” parameters.

The three communications parameters given in the left columns of the above table are given priority in the following order: “No. of multi-SP uses,” “event input allocation,” and “multi-SP use.”

4-5-2 Using Control Start (RUN)/Control Stop (STOP)

When the “No. of Multi-SP uses” parameter is set to 0 and the event input allocation is set to “RUN/STOP,” the RUN/STOP function can be controlled using the event input. The following table shows the relationship between event input contact status and control status.

Event input contact	Control status
ON (closed)	RUN
OFF (open)	STOP

4-5-3 Using the Multi-SP

The multi-SP function is used to switch between two SPs. Different SPs are set in advance for SP 0 and SP 1 and the event input contact signals or E5ZN-SDL Setting Display Unit is used to switch them.

Using the Event Input

The SPs listed in the following table can be selected by turning ON and OFF the event input.

Event input contact	SP
OFF (open)	SP 0
ON (closed)	SP 1

Note

1. Switch event inputs while the power is ON.
ON/OFF is detected for inputs of 50 ms or more.
2. SPs for ch1 and ch2 are both switched at the same time using event input.

Using Communications The SP can be selected using the communications parameters shown in the following table.

Multi-SP	SP
0	SP 0
1	SP 1

Note The SP can be switched independently for ch 1 and ch2.

Using Key Operations The SP can be selected using the E5ZN-SDL Setting Display Unit.

4-6 Setting the SP Upper and Lower Limit Range

4-6-1 SP Limits

The upper and lower SP limits can be set within the input temperature setting range.

Once the input SP limit is set, the SP is automatically returned to the upper or lower SP limit if it goes outside the SP limit range.

For example, If the SP upper limit is changed to 150°C when the SP is 200°C, the SP upper limit was 300°C, and the SP lower limit is 100°C, the SP will have gone outside the existing SP limit range of 100°C to 150°C. In this situation the SP will be changed to 150°C (i.e., the new upper limit).

If the input type or temperature unit is changed, the SP upper and lower limits will be automatically reset to the upper and lower limits of the input temperature setting range.

Set the SP limit separately for ch1 and ch2.

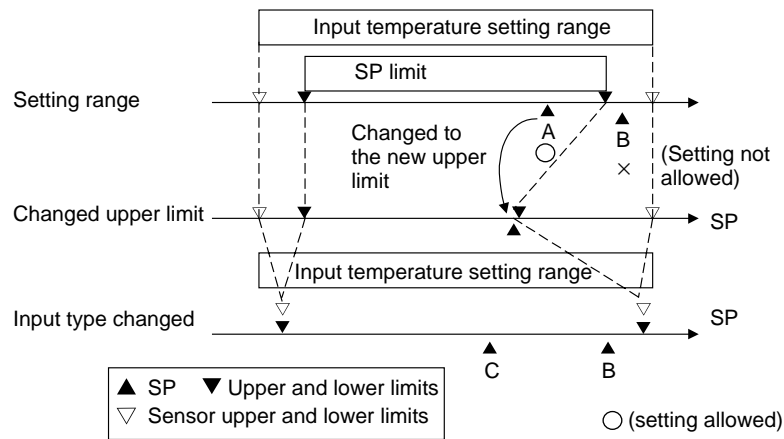

4-7 SP Ramp Function: Limiting SP Change Rate

4-7-1 SP Ramp

The SP ramp function controls the rate of change of the SP. If a change larger than the rate of change is specified when the SP ramp function has been enable, changes in the SP will be limited as shown below. Thus, when changes are made to the SP with the SP ramp function enabled, control is performed according to the rate of change rather than the target value.

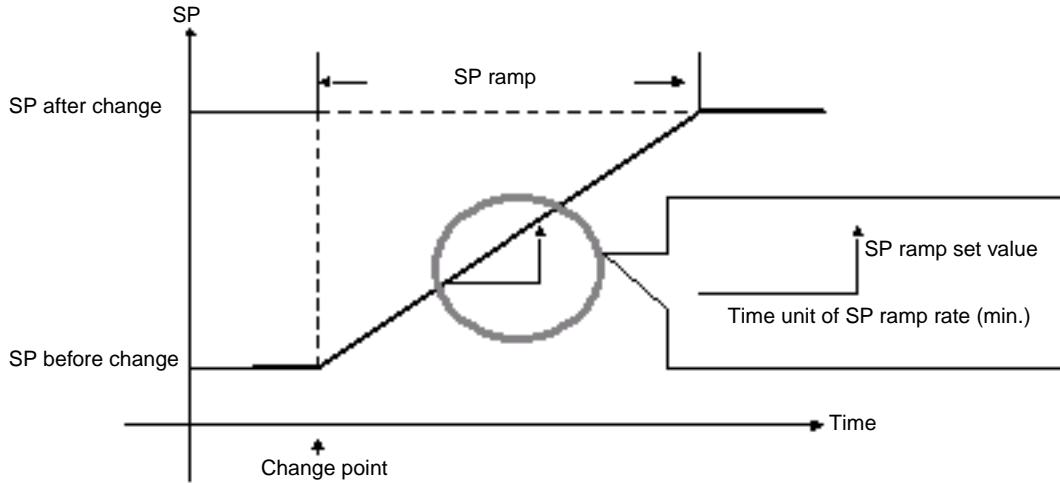

The change rate during SP ramp is specified in the “SP ramp set value” parameter. The “SP ramp set value” default is 0, i.e., the SP ramp function is disabled.

The SP ramp can be monitored in the “SP during SP ramp” parameter.

Operation at Start

When the power is turned ON, operation is performed with the PV treated as the SP before the change was made.

The direction of the SP ramp changes according to the relationship between the PV and the SP, as shown in the following diagram.

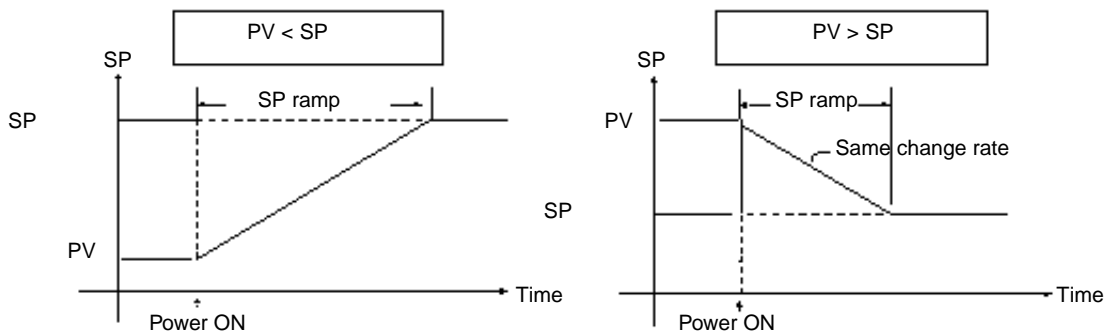

Restrictions during SP Ramp Operation

- Autotuning starts after the SP ramp function ends.
- When control is stopped or an error occurs, the SP ramp function is disabled.

4-8 Key Protection

4-8-1 Key Protect Function

The protect function limits the settings that can be changed to prevent inadvertently changing settings.

There are three protect mechanisms: “Communications writing” prohibits setting changes from host communications, while “operation/adjustment protection” and “initial setting/communications protection” limit settings from the E5ZN-SDL Setting Display Unit.

Communications Writing

If the ‘communications writing’ parameter is set to “0: Prohibited ($\bar{a}FF$),” changes to parameters other than “communications writing” are prohibited from host communications.

Default is “1: Not prohibited ($\bar{a}n$).”

Operation/Adjustment Protection

The following table shows the relationship between set values and the range of protection.

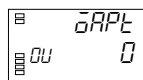

Level		Set value			
		0	1	2	3
Operation level	PV	○	○	○	○
	PV/SP	◆	◆	◆	○
	Other	◆	◆	×	×
Adjustment level		◆	×	×	×

- ◆: Can be displayed and changed
- : Can be displayed
- ×: Cannot be displayed and moving to other levels not possible
 - When this parameter is set to 0, parameters are not protected.
 - Default is 0.

Initial Setting/Communications Protection

This protect level restricts movement to the initial setting level, communications setting level, and advanced function setting level.

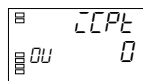

Set value	Initial setting level	Communications setting level	Advanced function setting level
0	○	○	○
1	○	○	×
2	×	×	×

- : Moving to other levels possible
 - ×: Moving to other levels not possible
- Default is 0.

Setting Change Protection

This protect level protects the setup from being changed by operating the keys on the front panel.

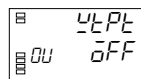

Set value	Description
OFF	Setup can be changed by key operation.
ON	Setup cannot be changed by key operation. (The protect level can be changed.)

Default is OFF.

4-9 Manual Mode

4-9-1 Auto/Manual

- If the “auto/manual” operation command is used by host communications to set “01: manual (ch1)” or “11: manual (ch2),” the E5ZN will operate in manual mode.
- If ON/OFF control is selected, operation cannot be switched to manual mode. Always switch to PID control before selecting manual mode. If manual mode has been selected and then operation is switched to ON/OFF control, the mode will automatically be changed to automatic mode.
- In manual mode, the standard control functions are stopped and the values set in the manual manipulated variable will be output.
- Make separate settings for ch1 and ch2 for auto/manual switching.
- To switch from manual to automatic mode, use the “auto/manual” operation command to set “00: auto (ch1)” and “10: auto (ch2).”
- Switching between automatic and manual modes and manual manipulated variable settings cannot be made from the E5ZN-SDL Setting Display Unit.
- To check whether the E5ZN is in automatic or manual mode, use host communications to read the “status” parameter.
- Even if the “operation after power turned ON” setting is on “continue” (continue operation status before power OFF), the manual manipulated variable before the power was turned OFF will not be saved. It will always change to 0%.

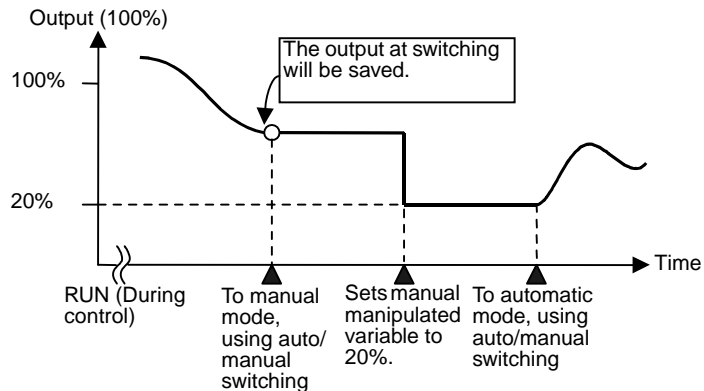

Relationship with RUN/STOP

- The E5ZN can switch between auto and manual modes during both RUN (control operating) and STOP (control stopped).
- Even if the manual manipulated variable is set to STOP during output in manual mode, the operation status will not change and the output of the manual manipulated variable will continue. (Refer to the following diagram.)

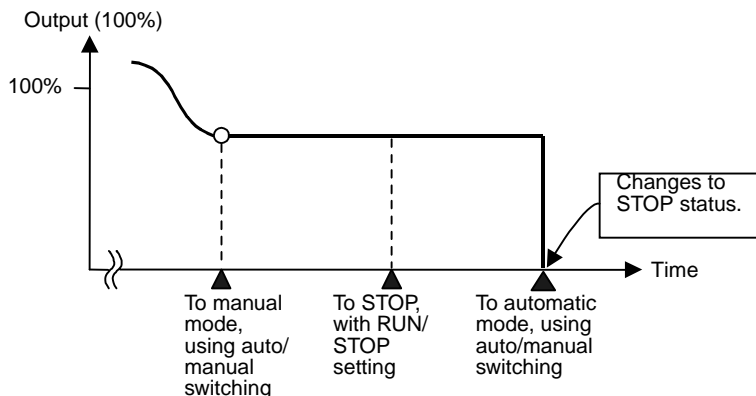

4-9-2 Manual Manipulated Variable

Use host communications to set the manual manipulated variable to output in manual mode.

The following table shows the relationship between the manual manipulated variable setting range and the actual output.

Standard Control

Manual manipulated variable setting	Analog output models E5ZN-2C□F03□-FLK	Pulse output models E5ZN-2Q□H03□-FLK E5ZN-2T□H03□-FLK
	Heating side control output	
100.0% to 105.0%	Outputs the value set to manual manipulated variable.	100.0%
0.1% to 99.9%		Outputs the value set to manual manipulated variable.
-5.0% to 0.0%		Outputs 0.0%

Heating/Cooling Control

Manual manipulated variable setting	Analog output models E5ZN-2C□F03□-FLK		Pulse output models E5ZN-2Q□H03□-FLK E5ZN-2T□H03□-FLK	
	Heating side control output	Cooling side control output	Heating side control output	Cooling side control output
100.0% to 105.0%	Outputs the value set to manual manipulated variable.	Outputs 0.0%	Outputs 100%	Outputs 0.0%
0.1% to 99.9%			Outputs the value set to manual manipulated variable.	
0.0%	Outputs 0.0%	Outputs the value set to manual manipulated variable.	Outputs 0.0%	Outputs the value set to manual manipulated variable.
-0.1% to -99.9%	Outputs 0.0%		Outputs 0.0%	
-100.0% to 105.0%				Outputs 100%

4-10 Reading Temperatures for Multiple E5ZN Units

If the present temperature was read from multiple Temperature Controllers using host communications, there are time differences in the process temperatures read from each Temperature Controller, making it difficult to obtain concurrent data.

The PV hold function can be used with the E5ZN to ensure that the data is concurrent to within 500 ms.

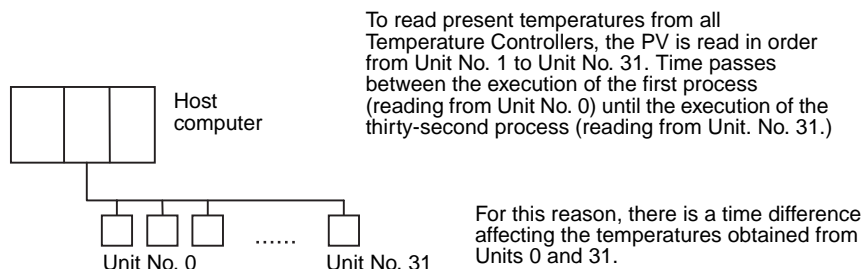

4-10-1 PV Hold

- The PV hold function temporarily stores the present temperature for that moment as the PV hold value, when the “PV hold” operation command sent by host communications is received.

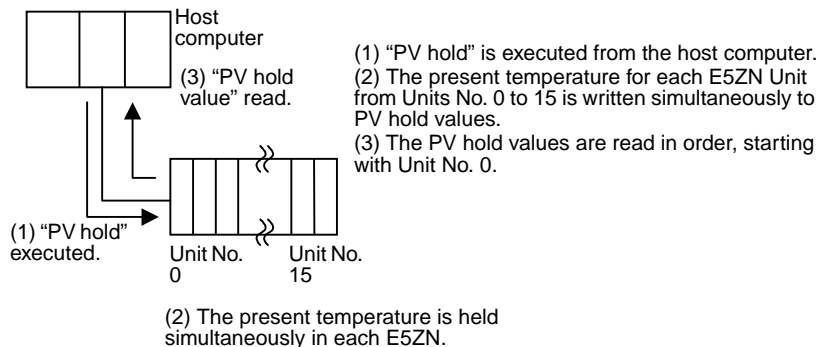

- When using multiple E5ZN Units, use host communications to execute the “PV hold” operation command simultaneously and then read the “PV hold value” for each E5ZN. This enables highly concurrent temperature logging.
- PV hold values are overwritten every time the “PV hold” operation command is executed. Once the PV hold values have been read for the channel that requires highly simultaneous reading of present temperatures, execute the next “PV hold” operation command.
- The “PV hold” operation command cannot be executed and the “PV hold value” cannot be read from the E5ZN-SDL Setting Display Unit.
- When the power is turned OFF, the PV hold values change to 0.

4-11 Remote PV Mode

Remote PV mode forces PID equation output using the input value from the external sensor with communications functions as the PV of the E5ZN, instead of using normal thermocouple or platinum-resistance thermometer sensor input.

This function is useful when using a remote external sensor with communications functions.

4-11-1 Using Remote PV Mode

- 1,2,3...
1. Connect the sensor input according to the following specifications.
 - For TC, Infrared Temperature Sensors, or Analog Input
Short between terminal numbers 5 and 6 and 11 and 12.
 - For Pt
Connect a resistance of 100 to 125 Ω between terminal numbers 4 and 5 and 10 and 11.
 - Short between terminal numbers 5 and 6 and 11 and 12.
 2. Set the cycle for communications data sent from the external sensor to “remote PV communications wait time.” This setting affects both channels. If the refresh cycle for data from the external sensor is longer than the “remote PV communications wait time,” the E5ZN will determine that the external sensor has been disconnected, and an input error will occur.
 3. To switch to remote PV mode, turn ON the “remote PV mode” parameter. This parameter setting is used for both channels.
 4. The PV from the external sensor is written to the remote PV.
 5. To switch from remote PV mode to normal mode, turn OFF the “remote PV mode” parameter.

Default Settings

The default settings are shown below.

- Remote PV mode: OFF (normal mode)
- Remote PV communications wait time: 2,000 ms

4-12 Using Transfer Output

- Transfer output is supported by analog output models only.
- The E5ZN has two systems of transfer output: Linear current output is for 4 to 20 mA DC or 0 to 20 mA DC, and linear voltage output is for 1 to 5 VDC/0 to 5 VDC.

4-12-1 Transfer Output Types

Ten types of data can be allocated for transfer output using the control output 1 allocation, control output 2 allocation, auxiliary output 3 allocation, and auxiliary output 4 allocation (initial setting level):

- SP transfer output for ch1
- Ramp SP transfer output for ch1
- PV transfer output for ch1
- Heating MV transfer output for ch1
- Cooling MV transfer output for ch1
- SP transfer output for ch2
- Ramp SP transfer output for ch2
- PV transfer output for ch2
- Heating MV transfer output for ch2
- Cooling MV transfer output for ch2

- Control output 1 and control output 2 use linear current output, and auxiliary output 3 and auxiliary output 4 use linear voltage output.

4-12-2 Transfer Output Scaling

- The range set by the transfer output upper limit and transfer output lower limit (initial setting level) can be scaled to the output range for the transfer output (4 to 20 mA DC or 0 to 20 mA DC for control output 1 and 2, and to 1 to 5 VDC or 0 to 5 VDC for auxiliary output 3 and 4).
- Values can be expanded by setting a small range between the transfer output upper and lower limits. Reverse scaling can be performed by setting the transfer output upper limit to a value smaller than the transfer output lower limit. The following figure shows a scaling example where the heating MV transfer output is scaled to 4 to 20 mA DC, and another example where it is scaled to 1 to 5 VDC.

Example of scaling for 4 to 20 mA DC

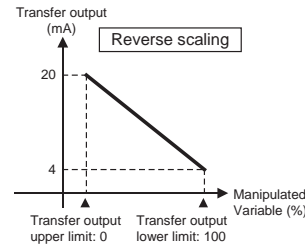
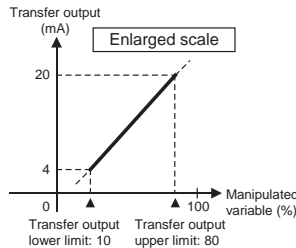

Example of scaling for 1 to 5 VDC

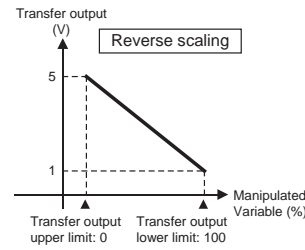
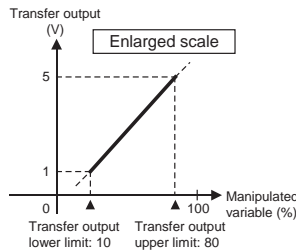

Application Example

Example 1: Recording ch1 Input between 0 and 200°C Using a Recorder

Temperature Controller: E5ZN-2C□F03TC-FLK (current output, thermocouple input)
 Recorder: E55A-F□
 Sensor: E52-CA15A D=3.2 NETU □M (K thermocouple, sheath, protective tubing dia. 3.2 mm, protective tubing length 150 mm, heat resistant)

Temperature Controller Settings:

Sensor input type (initial setting level):
 0 (thermocouple, -200°C to 1,300°C)
 Auxiliary output allocation 3 (initial setting level):
 12 (ch1 PV transfer output)
 SUB3 transfer output upper limit (initial setting level):
 200.0 (°C)
 SUB3 transfer output lower limit (initial setting level):
 0 (°C)
 Voltage output type (initial setting level):
 0 (1 to 5 VDC)

Recorder Settings:

Input voltage and span settings (setting mode: Scaling)

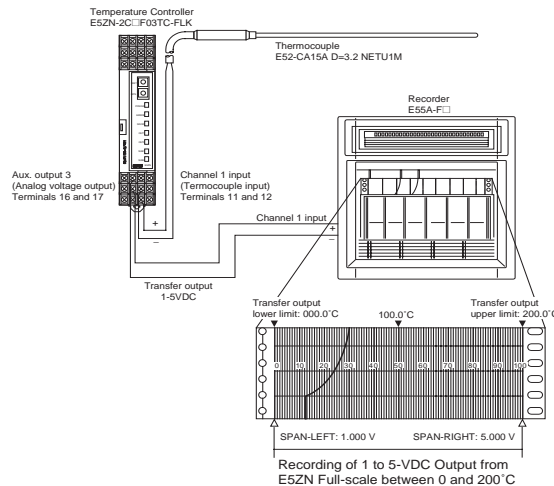
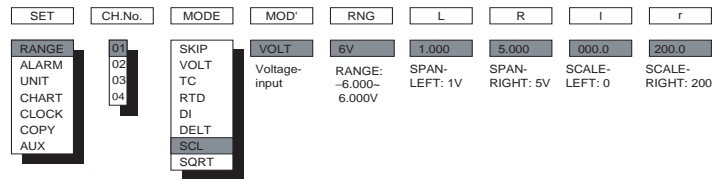

Example 2: Displaying the ch2 PVs on an External Meter Using Transfer Output

Temperature Controller: E5ZN-2C□F03P-FLK (current output, platinum-resistance thermometer input)
 Meter: K3MA-J 24 VAC/VDC (Process Meter)
 Sensor: E52-P20A D=3.2 □M (Pt100 platinum-resistance thermometer, sheath, protective tubing dia. 3.2 mm, protective tubing length 200 mm, general-purpose)

Temperature Controller Settings:

- Sensor input type (initial setting level):
2 (platinum-resistance thermometer, 0.0°C to 100.0 °C)
- Control output allocation 2 (initial setting level):
17 (PV transfer output for ch2)
- OUT2 transfer output upper limit (initial setting level):
100.0 (°C)
- OUT2 transfer output lower limit (initial setting level):
0 (°C)
- Current output type (initial setting level):
0 (4 to 20 mA DC)

Meter Setting Example:

- Inputs for 4 to 20 mA DC are scaled to 0.0 to 100.0°C.
- Input type (initial setting level: $\overline{cnp.t}$): 4 to 20 mA DC (4-20)
- Scaling input value 1 (initial setting level: $\overline{cnp.i}$): 4 mA (4.00)
- Scaling display value 1 (initial setting level: $\overline{dsp.i}$): 0 (00000)
- Scaling input value 2 (initial setting level: $\overline{cnp.2}$): 20 mA (20.00)
- Scaling display value 2 (initial setting level: $\overline{dsp.2}$): 100 (0 1000)
- Decimal point (initial setting level: \overline{dp}): One decimal place (0000.0)

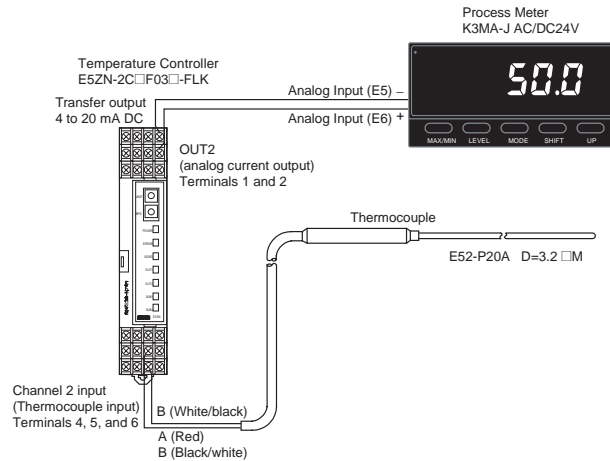

SECTION 5

Communications

5-1	Communication Protocols	64
5-1-1	CompoWay/F Communication Protocol	64
5-1-2	Communications Specification	64
5-1-3	Communications Procedure	64
5-2	Data Format Structure	65
5-2-1	Command Frame	65
5-2-2	Response Frame	66
5-3	Structure of Command/Response Text	67
5-4	Variable Area	68
5-5	Read from Variable Area	69
5-6	Write to Variable Area	70
5-7	Operation Commands	71
5-8	Setting Areas	73
5-9	Commands and Responses	74
5-9-1	Read Monitor Value	74
5-9-2	Read Setting Data	75
5-9-3	Multiple Reads of Monitor Values/Setting Data	76
5-9-4	Write Protect Level Setting Data	77
5-9-5	Write Setting Data	78
5-9-6	Multiple Writes of Setting Data	79
5-9-7	Communications Writing	80
5-9-8	Control Start (RUN)/Control Stop (STOP)	80
5-9-9	Multi-SP	81
5-9-10	AT Execute/Stop	81
5-9-11	Write Mode	82
5-9-12	RAM Data Save	83
5-9-13	Software Reset	83
5-9-14	Move to Setting Area 1	84
5-9-15	Move to Protect Level	84
5-9-16	Auto/Manual	85
5-9-17	PV Hold	85
5-9-18	Parameter Initialize	86
5-9-19	Alarm Latch Cancel	86
5-9-20	Read Controller Attribute	87
5-9-21	Read Controller Status	88
5-9-22	Echoback Test	89
5-10	Variable Area Map	90

5-1 Communication Protocols

5-1-1 CompoWay/F Communication Protocol

CompoWay/F is a standard OMRON communications protocol for general-purpose serial communications. It uses a standard frame format as well as FINS commands that have been proven in data exchange between OMRON's Programmable Controllers (PCs). The CompoWay/F format facilitates serial communications between components or a PC and components.

FINS (Factory Interface Network Service)

FINS is a protocol for message communications between Controllers in OMRON FA networks.

Note The program for communications is created on the host PC and E5ZN's parameters are monitored or set from the host PC. In this manual, descriptions of communications are given from the standpoint of the host PC.

5-1-2 Communications Specification

Transmission line connection:	Multipoint
Communications method:	RS-485 (Two-wire, half-duplex)
Synchronization method:	Start-stop synchronization
Baud rate:	4.8 k, <u>9.6 k</u> , 19.2 k, or 38.4 k bit/s
Communications code:	ASCII
Word length:	<u>7</u> or 8 bits
Stop bit length:	1 or <u>2</u> bits
Parity check:	Vertical parity - None, Odd, or <u>Even</u> BCC (block check character) Start-stop synchronization data composition
Flow control:	None
Interface:	RS-485
Retry function:	None

Note Default settings are underlined.

5-1-3 Communications Procedure

Communications between the Temperature Controller and the host PC are implemented on a frame-by-frame basis.

When the host PC sends a command frame to the Temperature Controller, the Temperature Controller returns to the host PC a response frame that corresponds to the command frame.

Command and response frames are transmitted as follows:

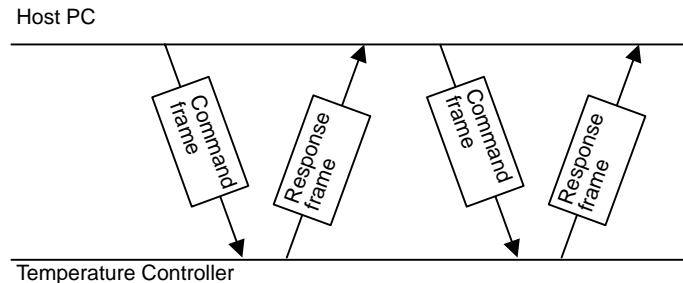

Allow a minimum wait time of 5 ms from when the host PC receives the response from the Temperature Controller until the host sends the next command.

Note Errors may occur in communications data due to ambient noise. To increase the reliability of the system, OMRON recommends executing retry processing to resend the command when an error response frame is detected.

5-2 Data Format Structure

Communications conforming to the CompoWay/F serial communications protocol involve transmission of blocks of data called **frames**. Those sent from the host PC are command frames and those sent from the Temperature Controller are response frames. The structure of these frames is shown below.

In the following frame description, the suffix H added to a numeric value, as in 02H, means the value is a hexadecimal number. And quotation marks around an alphanumeric value, as in "00," mean that the value is an ASCII character set. The number underneath each delimiter in a frame indicates the number of bytes.

5-2-1 Command Frame

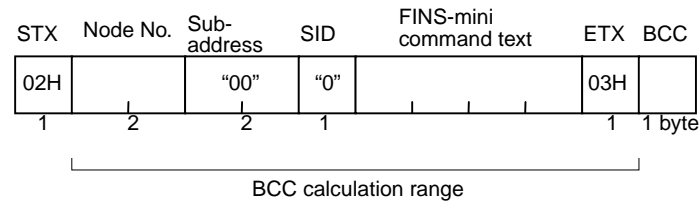

STX	Code indicating the start of a command frame (02H). Be sure to place this code in the first byte of a command frame.
Node No.	Node ID specifying the destination of a command frame. Set this No. to the unit number of the Temperature Controller. If you want to broadcast a command, set the node number to "XX." No response is given from the Temperature Controllers for broadcast commands.
Sub-address	Not used for E5ZN. Always set the sub-address to "00."
SID (Service ID)	Not used for E5ZN. Always set the SID to "0."
FINS-mini command text	Command text
ETX	Code indicating the end of text (03H)
BCC	Block Check Character The result of a block check on the BCC calculation range is stored in this field.

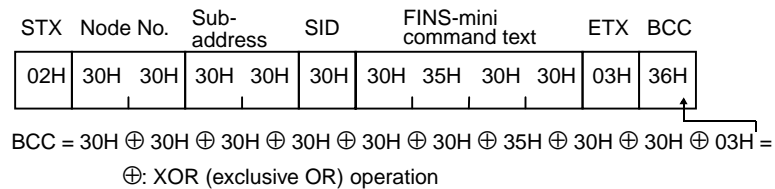

Note How to Determine the BCC:
 The BCC is determined by XOR operation on a byte-by-byte basis of the values within the range from the node number field to the ETX field. The result (36H in the example shown above) is placed in the BCC field.

5-2-2 Response Frame

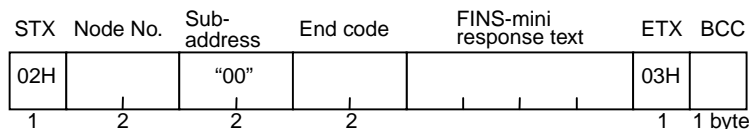

Note The Temperature Controller will not respond to any command frame that does not end in the ETX and BCC.

STX	Code indicating the start of a response frame (02H). Be sure to place this code in the first byte of the response frame.
Node No.	The node number is set to the value that was specified in the corresponding command frame. The unit number of the Temperature Controller that returns the response is set in this field.
Sub-address	Not used for E5ZN. This field is always set to "00."
End code	This field contains the result of execution of the corresponding command frame.
FINS-mini response text	Response text
ETX	Code indicating the end of text (03H)
BCC	Block Check Character The result of a block check on the BCC calculation range is stored in this field.

End Code

End code	Code name	Description	Error detection priority
"0F"	FINS command error	The specified FINS command could not be executed.	8
"10"	Parity error	The sum of the bits (received data (1)) does not match.	2
"11"	Framing error	The number of character stop bits for the command frame was 0.	1
"12"	Overrun error	A data transfer was attempted when the reception data buffer was already full.	3
"13"	BCC error	The received BCC was different from the calculated BCC	5
"14"	Format error	The command text contains characters other than "0" to "9" and "A" to "F". No SID and command text. MRC and SRC in the command text were not included in the command text.	7
"16"	Sub-address error	No sub-address, SID, and command text. This error is not covered by the echoback test. The size of the sub-address was less than two characters, and no SID and command text were found.	6
"18"	Frame length error	The size of the received frame exceeded the specified number of bytes.	4
"00"	Normal completion	The command was successfully executed.	None

5-3 Structure of Command/Response Text

The command/response text constitutes the main body of a command/response frame. The structure of the command/response text is described below.

Command Text

The command text consists of the MRC (Main Request Code) and the SRC (Sub Request Code), followed by the required data.

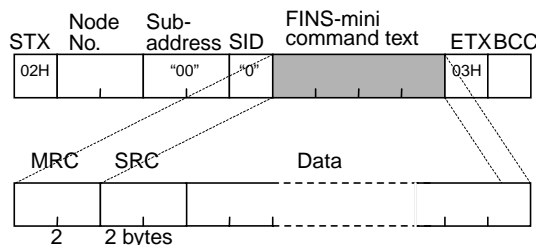

Response Text

The response text consists of the MRC and SRC, followed by the MRES (Main Response Code), the SRES (Sub Response Code), and the required data.

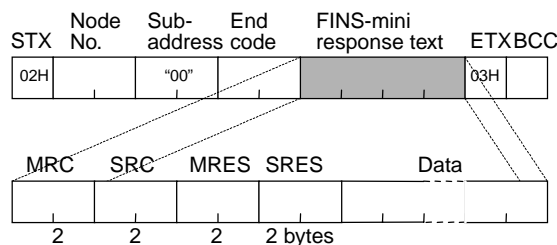

If the Temperature Controller fails to execute a specified command, it generates a response consisting of the MRC, SRC, MRES, and SRES only.

List of Services

MRC	SRC	Service name	Description
"01"	"01"	Read from Variable Area	This service reads from the variable area.
"01"	"02"	Write to Variable Area	This service writes to the variable area.
"01"	"04"	Read from Multiple Variable Area	This service performs non-consecutive multiple reads from the variable area.
"01"	"13"	Write to Multiple Variable Area	This service performs non-consecutive multiple writes to the variable area.
"05"	"03"	Read Controller Attribute	This service reads the model number and the communications buffer size.
"06"	"01"	Read Controller Status	This service reads the run status of the Controller.
"08"	"01"	Echoback Test	This service performs the echoback test.
"30"	"05"	Operation Commands	This service performs RUN/STOP, AT Execute/Cancel, Move for Setting Area 1, etc.

5-4 Variable Area

The section of memory in the Temperature Controller that holds the data to be transmitted via communications is called the **variable area**. The variable area is to read current PVs or read/write parameter settings.

The variable area is not used for operation commands or for reading Controller attributes.

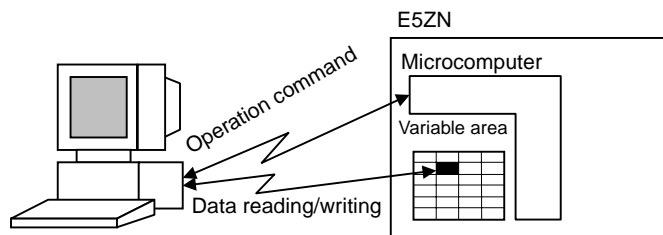

To specify the position of a variable in the variable area, use the **variable type** and **address**.

Variable type	Address 0000 0001 0002 0003				013D 013E 013F			
C0								
C1								
C3								
C5								
C7								

Variable

The address is a 4-digit hexadecimal code. Each variable contains an eight-digit value in hexadecimal. Negative values are expressed as the two's complement. When the current value of a variable is read as 105.0 on the main indicator of the Temperature Controller, for example, its hexadecimal notation is read in the form 0000041AH (the decimal point is ignored; 105.0 → 1050 → 0000041AH).

The variable area is mapped as shown below. The variable type is converted to a 2-byte ASCII code and loaded to the frame. Available variable types are shown in the following map.

	0000 0001 0002 0003	0006 0007	0019 001A	003E 003F	0100 0101 0102 0103	0106 0107	0119 011A	013E 013F
C0	ch1 PV etc.		Not used		ch2 PV etc.		Not used	
C1	ch1 SP etc.		Not used		ch2 SP etc.		Not used	
C3	ch1 input type etc.		Not used		ch2 input type etc.			
C5	ch1 remote PV		Not used		ch2 remote PV		Not used	
C7	ch1 remote PV mode		Not used		ch2 remote PV mode		Not used	

- Variable type C0: Read-only data for settings area 0 in double-word format
- Variable type C1: Read/write data for settings area 0 in double-word format
- Variable type C3: Read/write data for settings area 1 in double-word format
- Variable type C5: Read/write data for settings area 0 in double-word format
- Variable type C7: Read/write data for settings area 1 in double-word format

5-5 Read from Variable Area

This service reads data from the variable area.

Command

Command Text

MRC	SRC	Variable type	Read start address	Bit position	No. of elements
"01"	"01"			"00"	
2	2	2	4	2	4 bytes

Item	Description
MRC/SRC	Specify the FINS-mini command for reading a variable area.
Variable type	Set this item to "C0," "C1," "C3," "C5," or "C7."
Read start address	Specify the read start address.
Bit position	Not used for E5ZN. Always set this item to "00."
No. of elements	Set this item to the quantity of variables that are to be read (up to 6). Not required for multiple reads.

Response

Response Text

MRC	SRC	Response code (MRES/SRES)	Readout data
"01"	"01"		
2	2	4	No. of elements × 8 bytes (No. of

Item	Description
MRC/SRC	This field returns the FINS-mini command text.
Response code	This field contains the execution result of the command.
Readout data	This field returns the values of the variables that have been read out.

Response Codes

Response code	Code name	Description
"1001"	Command length over	The command is too long.
"1002"	Command length short	The command is too short.
"1101"	Area type error	The specified variable type is invalid.
"110B"	Response length over	The number of elements exceeds 6.
"1100"	Parameter error	The bit position is set to a value other than "00."
"2203"	Operation error	EEPROM error
"0000"	Normal completion	The command was successfully executed.

5-6 Write to Variable Area

This service writes data to the variable area.

Command

Command Text

MRC	SRC	Variable type	Write start address	Bit position	No. of elements	Writing data
"01"	"02"			"00"		
2	2	2	4	2	4 bytes	(No. of elements × 8) bytes

Item	Description
MRC/SRC	Specify the FINS-mini command for writing to a variable area.
Area type	Set this item to "C1," "C3," "C5," or "C7."
Write start address	Specify the write start address at this field.
Bit position	Not used for E5ZN. Always set this item to "00."
No. of elements	Set this item to the quantity of variables that are to be written (up to 6). Not required for multiple writes.
Data to be written	Place the desired data in this field.

Response

Response Text

MRC	SRC	Response code (MRES/SRES)
"01"	"02"	
2	2	4

Item	Description
MRC/SRC	This field contains the same value ("01"/"02") as specified in the command text.
Response code	This field contains the result of execution of the command.

Response Codes

Response code	Code name	Description
"1002"	Command length short	The command is too short.
"1101"	Area type error	The specified variable type is invalid.
"1003"	Data quantity mismatch error	A mismatch between the number of elements and the quantity of variables occurs.
"1100"	Parameter error	The bit position is set to a value other than "00." The value of data to be written is outside the valid range.
"3003"	Read only error	An attempt is made to write data to an address of variable type C0.
"2203"	Operation error	Communications writing is disabled. An attempt is made to write data from setting area 0 to setting area 1. An attempt is made to write setting data at a level other than protect level. Executing AT. An error occurs in EEPROM.
"0000"	Normal completion	The command was successfully executed.

5-7 Operation Commands

To send an operation command to the Temperature Controller, set the items in the command text as follows:

Command

Command Text

MRC	SRC	Command code	Related information
"30"	"05"		
2	2	2	2 bytes

Item	Description
MRC/SRC	Specify the FINS-mini operation command (operation command service).
Command code	Place a command code in this field.
Related information	Place information related to the operation command in this field.

E5ZN Command Codes

Command code	Command code	Related information
"00"	Communications writing	"00" or "10": OFF (disable) "01" or "11": ON (enable)
"01"	RUN/STOP	"00": Run ch1 "01": Stop ch1 "10": Run ch2 "11": Stop ch2 "F0": Run ch1, ch2 (See note 1.) "F1": Stop ch1, ch2 (See note 1.)
"02"	Multi-SP	"00": Select SP0 for ch1 "01": Select SP1 for ch1 "10": Select SP0 for ch2 "11": Select SP1 for ch2 "F0": Select SP0 for ch1, ch2 (See note 1.) "F1": Select SP1 for ch1, ch2 (See note 1.)
"03"	AT execute/cancel	"00": Stop ch1 AT "01": Execute ch1 AT "10": Stop ch2 AT "11": Execute ch2 AT "F0": Stop ch1, ch2 AT (See note 1.) "F1": Execute ch1, ch2 AT (See note 1.)
"04"	Write mode	"00" or "10": Backup "01" or "11": RAM
"05"	RAM data save	"00" or "10"
"06"	Software reset	"00" or "10"
"07"	Move to setting area 1	"00" or "10"
"08"	Move to protect level	"00" or "10"
"09"	Auto/manual	"00": Auto for ch1 "01": Manual for ch1 "10": Auto for ch2 "11": Manual for ch2 "F0": Auto for ch1, ch2 (See note 1.) "F1": Manual for ch1, ch2 (See note 1.)

Command code	Command code	Related information
"0A"	PV hold	"00" or "10"
"0B"	Parameter initialize	"00" or "10"
"0C"	Alarm latch cancel	"00": Cancel alarm latch 1 for ch1 (See note 1.)
		"01": Cancel alarm latch 2 for ch1 (See note 1.)
		"02": Cancel alarm latch 3 for ch1
		"0F": Cancel all alarm latches for ch1 (See note 1.)
		"10": Cancel alarm latch 1 for ch2 (See note 1.)
		"11": Cancel alarm latch 2 for ch2 (See note 1.)
		"12": Cancel alarm latch 3 for ch2 (See note 1.)
		"1F": Cancel all alarm latches for ch2 (See note 1.)
		"F0": Cancel alarm latch 1 for ch1, ch2 (See note 1.)
		"F1": Cancel alarm latch 2 for ch1, ch2 (See note 1.)
		"F2": Cancel alarm latch 3 for ch1, ch2 (See note 1.)
"FF": Cancel all alarm latches for ch1, ch2 (See note 1.)		

- Note**
1. These commands are supported by upgraded pulse output models and analog output models only.
 2. Command codes for which the related information is indicated as "00" or "10," or "01" or "11" use the same command for both ch1 and ch2. Either value in the related information can be used. (The result will be the same.)

Response

Response Text

MRC	SRC	Response code (MRES/SRES)
"30"	"05"	
2	2	4 bytes

Item	Description
MRC/SRC	This field contains the same value ("30"/"05") as specified in the command text.
Response code	This field contains the execution result of the command.

Response Codes

Response code	Code name	Description
"1001"	Command length over	The command is too long.
"1002"	Command length short	The command is too short.
"1100"	Parameter error	The command code or related information is invalid.
"2203"	Operation error	Communications writing is disabled. The specified operation cannot be executed. For details, refer to <i>5-9 Commands and Responses</i> . An error occurs in EEPROM.
"0000"	Normal completion	The command was successfully executed.

5-8 Setting Areas

E5ZN Temperature Controllers can be set to either **setting area 0** or **setting area 1**.

Control operation is executed in setting area 0. In this state, you can perform operations that are permitted only during control or those that cause no problems even if control is in progress. These operations include reading PVs, writing SPs, and change RUN/STOP status.

Setting area 0, however, prohibits operations affect control, including writing data at the initial setting level. (Reading setting data is always allowed.)

In setting area 1, control operation is stopped. In this state, you can perform operations that are not allowed in setting area 0. These operations include writing data at the initial setting level.

At power-ON, the Temperature Controller is set in setting area 0. To move to setting area 1, use the “move-to-setting area 1” command. To return to setting area 0, turn the power OFF and ON again, or use the “software reset” command.

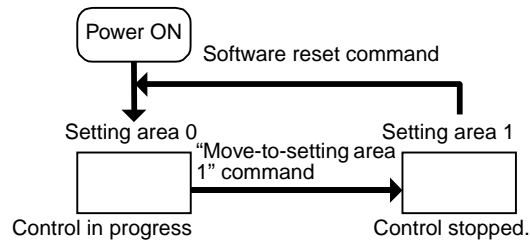

5-9 Commands and Responses

Various commands are provided for the application layer to implement services, such as variable area reading/writing and operation commands, supported by the CompoWay/F communications protocol.

This section describes the commands provided for the application layer.

5-9-1 Read Monitor Value

Command

MRC	SRC	Variable type	Address	Bit position	No. of elements
"01"	"01"	"C0"		"00"	"0001"

Address	Monitor value		Address	Monitor value	
	ch	Data name		ch	Data name
"0000"	1	PV	"0100"	2	PV
"0001"		Status	"0101"		Status
"0002"		Internal SP	"0102"		Internal SP
"0003"		Heater current value monitor	"0103"		Heater current value monitor
"0004"		MV monitor for heating	"0104"		MV monitor for heating
"0005"		MV monitor for cooling	"0105"		MV monitor for cooling
"0006"		PV hold value	"0106"		PV hold value

This command reads the current PV, status, or other monitor values. If the number of elements is set between "2" and "6", consecutive address monitor values can be read.

If the Temperature Controller is in setting area 1 when the command is received, it returns a response with the "unknown" data for all data except "status," which shows the operation status.

Response

MRC	SRC	Response code	Data
"01"	"01"	"0000"	Monitor value

Response code: The code shown above represents normal completion. For details on the response code, refer to 5-5 *Read from Variable Area*.

5-9-2 Read Setting Data

Command

MRC	SRC	Variable type	Address	Bit position	No. of elements
"01"	"01"			"00"	"0001"

Variable type	Address	Setting data	
		ch	Description
"C1"	"0000" to "0019"	1	Setting data for setting area 0
	"0100" to "0119"	2	
"C3"	"0000" to "003E"	1	Setting data for setting area 1
	"0100" to "013E"	2	
"C5"	"0000"	1	Setting data for setting area 0
	"0100"	2	
"C7"	"0000" to "0001"	1	Setting data for setting area 1
	"0100" to "0101"	2	

This command reads setting data. If the number of elements is set between "2" and "6", consecutive address setting data can be read.

Refer to *5-10 Variable Area Map* for information on specifying variable types and addresses.

This command can be used in either setting area 0 or 1.

Response

MRC	SRC	Response code	Data
"01"	"01"	"0000"	Status

Response code: The code shown above represents normal completion. For details on the response code, refer to *5-5 Read from Variable Area*.

5-9-3 Multiple Reads of Monitor Values/Setting Data

Command

MRC	SRC	Variable type	Address	Bit position	Variable type	Address	Bit position
"01"	"04"			"00"			"00"

Variable type	Address	Bit position
		"00"

Variable type	Address	Monitor value/setting data	
		ch	Description
"C0"	"0000" to "0006"	1	Monitor value
	"0100" to "0106"	2	
"C1"	"0000" to "0019"	1	Setting data for setting area 0
	"0100" to "0119"	2	
"C3"	"0000" to "003E"	1	Setting data for setting area 1
	"0100" to "013E"	2	
"C5"	"0000"	1	Setting data for setting area 0
	"0100"	2	
"C7"	"0000" to "0001"	1	Setting data for setting area 1
	"0100" to "0101"	2	

Multiple monitor values or setting data values can be read with the execution of one command. Up to 5 values can be read, even if the addresses are not consecutive.

Refer to 5-10 Variable Area Map for information on specifying variable types and addresses.

This command can be used in either setting area 0 or 1.

No data will be read if an area type error or parameter error occurs in any of the data.

Response

MRC	SRC	Response code	Variable type	Data
"01"	"04"	"0000"	Type	Monitor value/setting data

Variable type	Data
Type	Monitor value/setting data

Response code: The code shown above represents normal completion. For details on the response code, refer to 5-5 Read from Variable Area.

5-9-4 Write Protect Level Setting Data

Command

MRC	SRC	Variable type	Address	Bit position	No. of elements	Data
"01"	"02"	"C1"		"00"	"0001"	Protect level setting data

Address	Setting data
"0000"	Operation/adjustment protection
"0001"	Initial setting/communications protection
"0002"	Setting change protection
"0100"	Operation/adjustment protection
"0101"	Initial setting/communications protection
"0102"	Setting change protection

This command writes protect level setting data. For details on protect levels, refer to 6-3 *Setup Level Configuration and Front Panel Keys*.

This command can be used in setting area 0 only. If the Temperature Controller is in setting area 1 when the command is received, it returns an error.

Before executing the command, use operation commands to enable writing and to enter the protect level.

Response

MRC	SRC	Response code
"01"	"02"	"0000"

Response code: The code shown above represents normal completion. For details on the response code, refer to 5-6 *Write to Variable Area*.

5-9-5 Write Setting Data

Command

MRC	SRC	Variable type	Address	Bit position	No. of elements	Data
"01"	"02"			"00"	"0001"	Setting data (setting area 1)

Variable type	Address	Setting data	
		ch	Description
"C1"	"0000" to "0019"	1	Setting data for setting area 0
	"0100" to "0119"	2	
"C3"	"0000" to "003E"	1	Setting data for setting area 1
	"0100" to "013E"	2	
"C5"	"0000"	1	Setting data for setting area 0
	"0100"	2	
"C7"	"0000" to "0001"	1	Setting data for setting area 1
	"0100" to "0101"	2	

This command writes setting data. If the number of elements is set between "2" and "6", consecutive address setting data can be written.

For details on addressing, refer to 5-10 Variable Area Map.

This command can be used in setting area 1 only. If the Temperature Controller is in setting area 0 when the command is received, it returns an error.

Before executing the command, use operation commands to enable communications writing.

To save the operation/adjustment level setting data to internal non-volatile memory, use the "write mode" operation command to set the write mode to "backup." If it is not set to backup mode, the setting data will not be stored when the power is turned OFF. Refer to 6-3 Setup Level Configuration and Front Panel Keys for details on the operation/adjustment level.

Response

MRC	SRC	Response code
"01"	"02"	"0000"

Response code: The code shown above represents normal completion. For details on the response code, refer to 5-6 Write to Variable Area.

5-9-6 Multiple Writes of Setting Data

Command

MRC	SRC	Variable type	Address	Bit position	Data
"01"	"13"			"00"	Setting data
				"00"	Setting data

Variable type	Address	Setting data	
		ch	Description
"C1"	"0000" to "0019"	1	Setting data for setting area 0
	"0100" to "0119"	2	
"C3"	"0000" to "003E"	1	Setting data for setting area 1
	"0100" to "013E"	2	
"C5"	"0000"	1	Setting data for setting area 0
	"0100"	2	
"C7"	"0000" to "0001"	1	Setting data for setting area 1
	"0100" to "0101"	2	

Multiple setting data can be written with the execution of one command. Up to 3 values can be written, even if the addresses are not consecutive.

Refer to 5-10 Variable Area Map for information on specifying variable types and addresses.

Setting area 1 setting data can be written in setting area 1 only. An error will be returned if this command is executed for setting area 0.

Before executing the command, use an operation command to enable communications writing.

To save the operation/adjustment level setting data to internal non-volatile memory, use the "write mode" operation command to set the write mode to "backup." If it is not set to backup mode, the setting data will not be stored when the power is turned OFF. Refer to 6-3 Setup Level Configuration and Front Panel Keys for details on the operation/adjustment level.

Response

MRC	SRC	Response code
"01"	"13"	"0000"

Response code: The code shown above represents normal completion. For details on the response code, refer to 5-6 Write to Variable Area.

5-9-7 Communications Writing

Command

MRC	SRC	Command code	Related information
"30"	"05"		

Related information	Description
"00" or "10"	Communications writing prohibited
"01" or "11"	Communications writing not prohibited

This command enables/disables communications writing. It rewrites the setting for "communications writing."

If communications writing is disabled, operation commands for parameter rewriting, RUN/STOP, and other operations will be rejected.

Default is communications writing enabled.

This command can be used for setting area 0 or 1.

Response

MRC	SRC	Response code
"30"	"05"	"0000"

Response code: The code shown above represents normal completion. For details on the response code, refer to 5-7 *Operation Commands*.

5-9-8 Control Start (RUN)/Control Stop (STOP)

Command

MRC	SRC	Command code	Related information
"30"	"05"	"01"	

Related information	Contents	
	ch	Control
"00"	1	RUN
"01"		STOP
"10"	2	RUN
"11"		STOP
"F0"	1, 2	RUN (See note.)
"F1"		STOP (See note.)

This command starts and stops control (RUN/STOP).

This command can be used in either setting area 0 or 1.

Note These variations of the command are supported by upgraded pulse output models and analog output models only.

Response

MRC	SRC	Response code
"30"	"05"	"0000"

Response code: The code shown above represents normal completion. For details on the response code, refer to 5-7 *Operation Commands*.

5-9-9 Multi-SP

Command

MRC	SRC	Command code	Related information
"30"	"05"	"02"	

Related information	Contents	
	ch	Selected SP
"00"	1	SP 0
"01"		SP 1
"10"	2	SP 0
"11"		SP 1
"F0"	1, 2	SP 0 (See note.)
"F1"		SP 1 (See note.)

This command switches between SPs that have been set in advance for SP 0 and SP1.

"No. of multi-SP uses" must be set to 0 and "Use multi-SP" must be set to ON.

This command can be used for either setting area 0 or 1.

Note These variations of the command are supported by upgraded pulse output models and analog output models only.

Response

MRC	SRC	Response code
"30"	"05"	"0000"

Response code: The code shown above represents normal completion. For details on the response code, refer to *5-7 Operation Commands*.

5-9-10 AT Execute/Stop

Command

MRC	SRC	Command code	Related information
"30"	"05"	"03"	

Related information	Contents	
	ch	Instruction details
"00"	1	Stop
"01"		Execute
"10"	2	Stop
"11"		Execute
"F0"	1, 2	Stop (See note.)
"F1"		Execute (See note.)

This command executes or stopped autotuning.

This command can be used in setting area 0 only. If it is used in setting area 1, an operation error will be returned. An operation error will also be returned in the following cases.

- When the "RUN/STOP" parameter for the specified channel is set to "STOP."
- When ON/OFF control is being used.

Before executing the command, use an operation command to enable communications writing.

Note These variations of the command are supported by upgraded pulse output models and analog output models only.

Response

MRC	SRC	Response code
"30"	"05"	"0000"

Response code: The code shown above represents normal completion. For details on the response code, refer to *5-7 Operation Commands*.

5-9-11 Write Mode

Command

MRC	SRC	CommandRelated code	information
"30"	"05"	"04"	

Related information	Contents
"00" or "10"	Backup mode
"01" or "11"	RAM write mode

This command selects backup mode and RAM write mode.

Default is RAM write mode.

This command can be used in either setting area 0 or 1.

Before executing the command, use an operation command to enable communications writing.

Write mode	Description
Backup mode	When operation/adjustment level setting data write has been performed via communications, the data is written to internal non-volatile memory. Refer to <i>6-3 Setup Level Configuration and Front Panel Keys</i> for information on operation/adjustment level.
RAM write mode	When operation/adjustment level setting data write has been performed via communications, the data is not written to internal non-volatile memory. However, if the data is changed using the E5ZN-SDL Setting Display Unit key operations, it is written to internal non-volatile memory. Refer to <i>6-3 Setup Level Configuration and Front Panel Keys</i> for information on operation/adjustment level.

When switching from RAM write mode to backup mode, the operation/adjustment level setting data is written to internal non-volatile memory. Refer to *6-3 Setup Level Configuration and Front Panel Keys* for information on operation/adjustment level.

Response

MRC	SRC	Response code
"30"	"05"	"0000"

Response code: The code shown above represents normal completion. For details on the response code, refer to *5-7 Operation Commands*.

5-9-12 RAM Data Save

Command

MRC	SRC	Command code	Related information
"30"	"05"	"05"	"00" or "10"

This command writes operation/adjustment level setting data to internal non-volatile memory. Refer to 6.3 6-3 *Setup Level Configuration and Front Panel Keys* for information on operation/adjustment level.

This command can be used for either setting area 0 or 1.

Before executing the command, use an operation command to enable communications writing.

Response

MRC	SRC	Response code
"30"	"05"	"0000"

Response code: The code shown above represents normal completion. For details on the response code, refer to 5-7 *Operation Commands*.

5-9-13 Software Reset

Command

MRC	SRC	Command code	Related information
"30"	"05"	"06"	"00" or "10"

This command triggers a software reset, which returns the Temperature Controller to its initial state when it was turned ON.

This command can be used in either setting area 0 or 1.

Before executing the command, use an operation command to enable communications writing.

Response

The Temperature Controller does not return a response to this command.

5-9-14 Move to Setting Area 1

Command

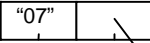
MRC	SRC	Command code	Related information
"30"	"05"	"07"	

"00" or "10"

Use this command to move to setting area 1.

Use this command in setting area 0. If the Temperature Controller is in setting area 1 when the command is received, the command is ignored.

If the set value of the "initial setting/communications protection" parameter is 2 (indicating that moving to initial setting or communications setting level is disabled) when the Temperature Controller receives the command, the Temperature Controller returns an error.

Before executing this command, use an operation command to enable communications writing.

Response

MRC	SRC	Response code
"30"	"05"	"0000"

Response code: The code shown above represents normal completion. For details on the response code, refer to *5-7 Operation Commands*.

5-9-15 Move to Protect Level

Command

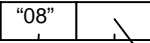
MRC	SRC	Command code	Related information
"30"	"05"	"08"	

"00" or "10"

This command moves the Temperature Controller to the protect level. Refer to *6-3 Setup Level Configuration and Front Panel Keys* for information on protect level.

This command can be used in setting area 0 only. If the Temperature Controller is in setting area 1 when the command is received, it returns an error.

Before executing the command, use an operation command to enable communications writing.

Response

MRC	SRC	Response code
"30"	"05"	"0000"

Response code: The code shown above represents normal completion. For details on the response code, refer to *5-7 Operation Commands*.

5-9-16 Auto/Manual

Command

MRC	SRC	Command code	Related information
"30"	"05"	"09"	

Related information	Contents	
	ch	Operation mode
"00"	1	Auto
"01"		Manual
"10"	2	Auto
"11"		Manual
"F0"	1, 2	Auto (See note.)
"F1"		Manual (See note.)

This command selects automatic/manual operation. It can be used when the "PID/OnOff" parameter is set to PID.

This command can be used in either setting area 0 or 1.

Before executing the command, use an operation command to enable communications writing.

Note These variations of the command are supported by upgraded pulse output models and analog output models only.

Response

MRC	SRC	Response code
"30"	"05"	"0000"

Response code: The code shown above represents normal completion. For details on the response code, refer to *5-7 Operation Commands*.

5-9-17 PV Hold

Command

MRC	SRC	Command code	Related information
"30"	"05"	"0A"	

"00" or "10"

This command saves the PV when the command was executed in the variable area.

This command can be used for setting area 0. If it is used in setting area 1, an operation error will be returned.

Before executing the command, use an operation command to enable communications writing.

Response

MRC	SRC	Response code
"30"	"05"	"0000"

Response code: The code shown above represents normal completion. For details on the response code, refer to *5-7 Operation Commands*.

5-9-18 Parameter Initialize

Command

MRC	SRC	Command code	Related information		
"30"	"05"	"0B"	<table border="1"> <tr> <td style="width: 20px; height: 20px;"></td> <td style="width: 20px; height: 20px;"></td> </tr> </table> "00" or "10"		

This command returns all settings to the default values.
 This command can be used for setting area 0. If it is used in setting area 1, an operation error will be returned.
 Before executing the command, use an operation command to enable communications writing.

Response

MRC	SRC	Response code
"30"	"05"	"0000"

Response code: The code shown above represents normal completion. For details on the response code, refer to *5-7 Operation Commands*.

5-9-19 Alarm Latch Cancel

Command

MRC	SRC	Command code	Related information		
"30"	"05"	"0C"	<table border="1"> <tr> <td style="width: 20px; height: 20px;"></td> <td style="width: 20px; height: 20px;"></td> </tr> </table>		

Related information	Contents	
	ch	Operation mode (See note.)
"00"	1	Cancel alarm latch 1 for ch1
"01"		Cancel alarm latch 2 for ch1
"02"		Cancel alarm latch 3 for ch1
"0F"		Cancel all alarm latches for ch1
"10"	2	Cancel alarm latch 1 for ch2
"11"		Cancel alarm latch 2 for ch2
"12"		Cancel alarm latch 3 for ch2
"1F"		Cancel all alarm latches for ch2
"F0"	1, 2	Cancel alarm latch 1 for ch1, ch2
"F1"		Cancel alarm latch 2 for ch1, ch2
"F2"		Cancel alarm latch 3 for ch1, ch2
"FF"		Cancel all alarm latches for ch1, ch2

This command cancels the alarm latch. The command can be used in setting area 0 or 1. The corresponding alarm output latch status will be cancelled when latch cancel is specified.

Note This command is supported by upgraded pulse output models and analog output models only.

Response

MRC	SRC	Response code
"30"	"05"	"0000"

Response code: The code shown above represents normal completion. For details on the response code, refer to *5-7 Operation Commands*.

5-9-20 Read Controller Attribute

Command

MRC	SRC
"05"	"03"

This command reads the model name and communication buffer size of the Temperature Controller.

The command can be used regardless of what state the Temperature Controller is in.

Response

MRC	SRC	Response code	Model name	Buffer size
"05"	"03"	"0000"		"0048"

Model name	No. of control points	Control output	Auxiliary output 1, 2	Auxiliary output 3, 4	Heater burnout alarm
E5ZN-2QNH0	2	Pulse voltage output	Transistor output (sinking)		Supported
E5ZN-2QPH0	2	Pulse voltage output	Transistor output (sourcing)		Supported
E5ZN-2TNH0	2	Transistor output	Transistor output (sinking)		Supported
E5ZN-2TPH0	2	Transistor output	Transistor output (sourcing)		Supported
E5ZN-2CNF0	2	Linear current output	Transistor output (sinking)	Linear voltage output	Not supported
E5ZN-2CPF0	2	Linear voltage output	Transistor output (sourcing)	Linear voltage output	Not supported

The model name is expressed in 10-byte ASCII.

A fixed value of "0048H" (72 bytes) for the buffer size is returned.

Response Code

Response code	Error name	Description
"1001"	Command length over	The command is too long.
"2203"	Operation error	An error occurs in EEPROM.
"0000"	Normal completion	The command is successfully executed.

5-9-21 Read Controller Status

Command

MRC	SRC
"06"	"01"

This command reads the operation status of the Temperature Controller. The command can be used regardless of what state the Temperature Controller is in.

Response

MRC	SRC	Response code	Operation status	Related information
"06"	"01"	"0000"		

Operation status	Description
"00"	Control operating for all channels (No errors in setting area 0, executing RUN.)
"01"	Control has stopped for one channel (Errors other than errors in setting area 0, not executing RUN.)

Related Information

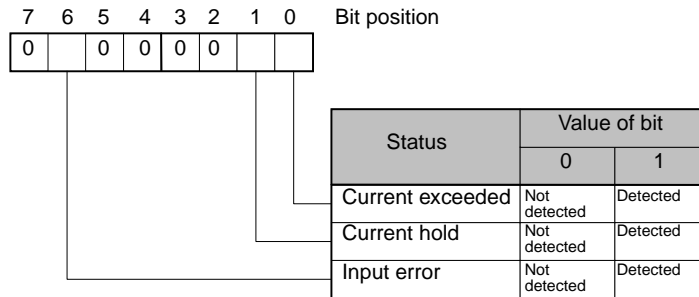

If the Temperature Controller is in setting area 1 when the command is received, it returns a response with "unknown" related information.

Response Code

Response code	Error name	Description
"1001"	Command length over	The command is too long.
"2203"	Operation error	An error occurs in EEPROM.
"0000"	Normal completion	The command is successfully executed.

5-9-22 Echoback Test

Command

MRC	SRC	Data to be tested
"08"	"01"	0 to 23 bytes

This command performs an echoback test.

The command can be used regardless of the state of the Temperature Controller.

Data to be checked must not exceed the communications data length.

Communication data length	Description
7 bits	20H to 7EH converted to ASCII code
8 bits	20H to 7EH or A1H to FEH converted to ASCII code

Response

MRC	SRC	Response code	Data to be tested
"08"	"01"	"0000"	0 to 23 bytes

Response Code

Response code	Error name	Description
"1001"	Command length over	The command is too long.
"2203"	Operation error	An error occurs in EEPROM.
"0000"	Normal completion	The command is successfully executed.

5-10 Variable Area Map

The variable area of the Temperature Controller is mapped in terms of variable types and addresses as described below.

Variable type C0: Read-only data for setting area 0, including PVs and status

Variable type C1: Setting data for setting area 0

Variable type C3: Setting data for setting area 1

Variable type C5: Setting data for setting area 0

Variable type C7: Setting data for setting area 1

Allocations for each variable are listed below.

A dash (-) in the “ch” column indicates data that is used by both channels.

Note

1. This data is used by pulse output models only.
2. This data is used by analog output models only.
3. This data is used by upgraded pulse output models and analog output models only.

Variable type	Address	ch	Monitor value	Description	
C0	0000	1	PV	Temperature: According to specified range for each sensor.	
				Analog: Scaling lower limit – 5% FS to scaling upper limit + 5% FS	
	0001		Status	Refer to page 91.	
	0002		Internal SP	Lower limit of SP to upper limit of SP	
	0003		Heater current value monitor	00000000H to 00000226H (0.0 to 55.0) (See note 1.)	
	0004		MV monitor for heating	Standard: FFFFFFFCEH to 0000041AH (-5.0 to 105.0)	
				Heating/cooling: 00000000H to 0000041AH (0.0 to 105.0)	
	0005		MV monitor for cooling	00000000H to 0000041AH (0.0 to 105.0)	
	0006		PV hold value	Temperature: According to specified range for each sensor	
				Analog: Scaling lower limit – 5% FS to scaling upper limit + 5% FS	
				Value stored in internal non-volatile memory (RAM) when the “PV hold” operation command was executed.	
	0100		2	PV	Temperature: According to specified range for each sensor
					Analog: Scaling lower limit – 5% FS to scaling upper limit 5% + FS
				0101	Status
0102		Internal SP		Lower limit of SP to upper limit of SP	
0103		Heater current value monitor		00000000H to 00000226H (0.0 to 55.0) (See note 1.)	
0104		MV monitor for heating		Standard: FFFFFFFCEH to 0000041AH (-5.0 to 105.0)	
				Heating/cooling: 00000000H to 0000041AH (0.0 to 105.0)	
0105		MV monitor for cooling		00000000H to 0000041AH (0.0 to 105.0)	
0106	PV hold value	Temperature: According to specified range for each sensor			
		Analog: Scaling lower limit – 5% FS to scaling upper limit + 5% FS			
		Value stored in internal non-volatile memory (RAM) when the “PV hold” operation command was executed.			

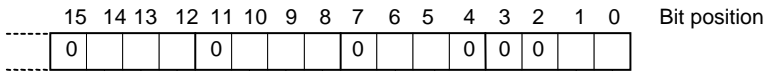

Status	Value of bit	
	0	1
Current exceeded	Not detected	Detected
Current hold	Refresh	Hold
Indicate range exceeded.	Not detected	Detected
Input error	Not detected	Detected
Heating output (See note.)	OFF	ON
Cooling output (See note.)	OFF	ON
HB output	OFF	ON
Alarm output 1	OFF	ON
Alarm output 2	OFF	ON
Alarm output 3	OFF	ON

Note: For pulse output models, the status of these bits shows the status of the corresponding operation indicators. For analog output modes, the status of these bits is undefined (i.e., the bits will not necessarily show the status of the indicators).

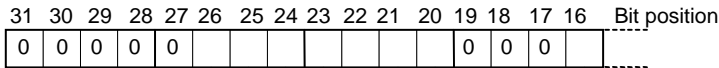

Status	Value of bit	
	0	1
Event input	OFF	ON
Write mode	Backup	RAM write
EEPROM (See note.)	RAM = EEPROM	RAM ≠
Setting area	Setting area 0	Setting area 1
AT execute/cancel	AT canceled	AT executing
RUN/STOP	RUN	STOP
Data writing	Disable	Enable
Auto/manual	Automatic	Manual

Note: EEPROM is the internal non-volatile memory.

Variable type	Address	ch	Setting data name	Description
C1	0000	-	Operation/adjustment protection	00000000H (0): No restriction at the operation/adjustment levels 00000001H (1): Moving to adjustment level is disabled. 00000002H (2): Only "PV" and "PV/SP" display and change enabled. 00000003H (3): Only "PV" and "PV/SP" display enabled.
	0001		Initial setting/communications protection	00000000H (0): Moving to initial level/communications setting level enabled and moving to advanced function setting level displayed. 00000001H (1): Moving to initial level/communications setting level enabled and moving to advanced function setting level not displayed. 00000002H (2): Moving to initial setting/communications setting levels is disabled.
	0002		Setting change protection	00000000H (0): OFF (Setting changes using the E5ZN-SDL enabled.) 00000001H (1): ON (Setting changes using the E5ZN-SDL disabled.)
0003	1	SP	Lower limit of SP to upper limit of SP	
0004		Alarm value 1	FFFFF831H to 0000270FH (-1,999 to 9,999 or -199.9 to 999.9)	
0005		Alarm upper limit value 1	FFFFF831H to 0000270FH (-1,999 to 9,999 or -199.9 to 999.9)	
0006		Alarm lower limit value 1	FFFFF831H to 0000270FH (-1,999 to 9,999 or -199.9 to 999.9)	
0007		Alarm value 2	FFFFF831H to 0000270FH (-1,999 to 9,999 or -199.9 to 999.9)	
0008		Alarm upper limit value 2	FFFFF831H to 0000270FH (-1,999 to 9,999 or -199.9 to 999.9)	
0009		Alarm lower limit value 2	FFFFF831H to 0000270FH (-1,999 to 9,999 or -199.9 to 999.9)	
000A		Alarm value 3	FFFFF831H to 0000270FH (-1,999 to 9,999 or -199.9 to 999.9)	
000B		Manual manipulated value	Standard: FFFFFFFCEH to 0000041AH (-5.0 to 105.0) Heating/cooling: FFFFFBE6H to 0000041AH (-105.0 to 105.0)	
000C		Heater burnout detection	00000000H to 000001F4H (0.0 to 50.0) (See note 1.)	
000D		SP 0	Lower limit of SP to upper limit of SP	
000E		SP 1	Lower limit of SP to upper limit of SP	
000F		Temperature input offset value	FFFFF831H to 0000270FH (-199.9 to 999.9)	
0010		Upper limit temperature input offset value	FFFFF831H to 0000270FH (-199.9 to 999.9)	
0011		Lower limit temperature input offset value	FFFFF831H to 0000270FH (-199.9 to 999.9)	
0012		Proportional band	00000001H to 0000270FH (0.1 to 999.9)	
0013		Integral time	00000000H to 00000F9FH (0 to 3999)	
0014		Derivative time	00000000H to 00000F9FH (0 to 3999)	
0015		Cooling coefficient	00000001H to 0000270FH (0.01 to 99.99)	
0016		Dead band	FFFFF831H to 0000270FH (-199.9 to 999.9)	
0017		Manual reset value	00000000H to 000003E8H (0.0 to 100.0)	
0018		Heating hysteresis	00000000H to 0000270FH (0.1 to 999.9)	
0019		Cooling hysteresis	00000000H to 0000270FH (0.1 to 999.9)	

Variable type	Address	ch	Setting data name	Description
C1	0100	-	Operation/adjustment protection	00000000H (0): No restriction at the operation/adjustment levels 00000001H (1): Moving to adjustment level is disabled. 00000002H (2): Only "PV" and "PV/SP" display and change enabled. 00000003H (3): Only "PV" and "PV/SP" display enabled.
	0101		Initial setting/communications protection	00000000H (0): Moving to initial level/communications setting level enabled and moving to advanced function setting level displayed. 00000001H (1): Moving to initial level/communications setting level enabled and moving to advanced function setting level not displayed. 00000002H (2): Moving to initial setting/communication setting levels is disabled.
	0102		Setting change protection	00000000H (0): OFF (Setting changes using E5ZN-SDL enabled.) 00000001H (1): ON (Setting changes using E5ZN-SDL disabled.)
	0103	2	SP	Lower limit of SP to upper limit of SP
	0104		Alarm value 1	FFFFF831H to 0000270FH (-1,999 to 9,999 or -199.9 to 999.9)
	0105		Upper limit alarm value 1	FFFFF831H to 0000270FH (-1,999 to 9,999 or -199.9 to 999.9)
	0106		Lower limit alarm value 1	FFFFF831H to 0000270FH (-1,999 to 9,999 or -199.9 to 999.9)
	0107		Alarm value 2	FFFFF831H to 0000270FH (-1,999 to 9,999 or -199.9 to 999.9)
	0108		Upper limit alarm value 2	FFFFF831H to 0000270FH (-1,999 to 9,999 or -199.9 to 999.9)
	0109		Lower limit alarm value 2	FFFFF831H to 0000270FH (-1,999 to 9,999 or -199.9 to 999.9)
	010A		Alarm value 3	FFFFF831H to 0000270FH (-1,999 to 9,999 or -199.9 to 999.9)
	010B		Manual manipulated variable	Standard: FFFFFFFCEH to 0000041AH (-5.0 to 105.0) Heating/cooling: FFFFFBE6H to 0000041AH (-105.0 to 105.0)
	010C		Heater burnout detection	00000000H to 000001F4H (0.0 to 50.0) (See note 1.)
	010D		SP 0	Lower limit of SP to upper limit of SP
	010E		SP 1	Lower limit of SP to upper limit of SP
	010F		Temperature input offset value	FFFFF831H to 0000270FH (-199.9 to 999.9)
	0110		Upper limit temperature input offset value	FFFFF831H to 0000270FH (-199.9 to 999.9)
	0111		Lower limit temperature input offset value	FFFFF831H to 0000270FH (-199.9 to 999.9)
	0112		Proportional band	00000001H to 0000270FH (0.1 to 999.9)
	0113		Integral time	00000000H to 00000F9FH (0 to 3999)
	0114		Derivative time	00000000H to 00000F9FH (0 to 3999)
	0115		Cooling coefficient	00000001H to 0000270FH (0.01 to 99.99)
	0116		Dead band	FFFFF831H to 0000270FH (-199.9 to 999.9)
	0117		Manual reset value	00000000H to 000003E8H (0.0 to 100.0)
	0118		Heating hysteresis	00000001H to 0000270FH (0.1 to 999.9)
	0119		Cooling hysteresis	00000001H to 0000270FH (0.1 to 999.9)

Variable type	Address	ch	Setting data name	Description
C3	0000	-	Input type	Platinum-resistance thermometer input type: 00000000H (0): Pt (-200 to 850°C or -300 to 1,500°F) 00000001H (1): Pt (-199.9 to 500.0°C or -199.9 to 900.0°F) 00000002H (2): Pt (0.0 to 100°C or 0.0 to 210.0°F) 00000003H (3): JPt (-199.9 to 500.0°C or -199.9 to 900.0°F) 00000004H (4): JPt (0.0 to 100.0°C or 0.0 to 210.0°F) Thermocouple input type: 00000000H (0): K (-200 to 1,300°C or -300 to 2,300°F) 00000001H (1): K (-20.0 to 500.0°C or 0.0 to 900.0°F) 00000002H (2): J (-100 to 850°C or -100 to 1,500°F) 00000003H (3): J (-20.0 to 400.0°C or 0.0 to 750.0°F) 00000004H (4): T (-200 to 400°C or -300 to 700°F) 00000005H (5): E (0 to 600°C or 0 to 1,100°F) 00000006H (6): L (-100 to 850°C or -100 to 1,500°F) 00000007H (7): U (-200 to 400°C or -300 to 700°F) 00000008H (8): N (-200 to 1,300°C or -300 to 2,300°F) 00000009H (9): R (0 to 1,700°C or 0 to 3,000°F) 0000000AH (10): S (0 to 1,700°C or 0 to 3,000°F) 0000000BH (11): B (100 to 1,800°C or 300 to 3,200°F) 0000000CH (12): Infrared temperature sensor (K10 to 70°C) 0000000DH (13): Infrared temperature sensor (K60 to 120°C) 0000000EH (14): Infrared temperature sensor (K115 to 165°C) 0000000FH (15): Infrared temperature sensor (K160 to 260°C) 00000010H (16): 0 to 50 mV 00000011H (17): T (-199.9 to 400.0°C or -199.9 to 700.0°F) 00000012H (18): U (-199.9 to 400.0°C or -199.9 to 700.0°F)
	0001	1	Scaling upper limit	Scaling lower limit + 1 to 0000270FH (scaling lower limit + 1 to 9,999)
	0002		Scaling lower limit	FFFFF831H to scaling upper limit - 1 (-1,999 to scaling upper limit - 1)
	0003		Decimal point position	00000000H to 00000001H (0 to 1)
	0004	-	Temperature units	00000000H (0): °C 00000001H (1): °F
	0005	1	SP upper limit	Temperature: SP lower limit + 1 to input range upper limit
				Analog: SP lower limit + 1 to scaling upper limit
	0006		SP lower limit	Temperature: Input range lower limit to SP upper limit - 1
				Analog: Scaling lower limit to SP upper limit - 1
	0007		PID/OnOff	00000000H (0): ON/OFF 00000001H (1): 2-PID control
	0008		Heating control period	00000001H to 00000063H (1 to 99)
	0009		Cooling control period	00000001H to 00000063H (1 to 99)
	000A		Direct/reverse operation	00000000H (0): Reverse operation 00000001H (1): Direct operation

Variable type	Address	ch	Setting data name	Description
C3	000B	1	Alarm 1 type	00000000H (0): No alarm function 00000001H (1): Upper and lower limit alarm 00000002H (2): Upper limit alarm 00000003H (3): Lower limit alarm 00000004H (4): Upper and lower limit range alarm 00000005H (5): Upper and lower limit alarm with standby sequence 00000006H (6): Upper limit alarm with standby sequence 00000007H (7): Lower limit alarm with standby sequence 00000008H (8): Absolute value upper limit alarm 00000009H (9): Absolute value lower limit alarm 0000000AH (10): Absolute value upper limit alarm with standby sequence 0000000BH (11): Absolute value lower limit alarm with standby sequence
	000C		Alarm 2 type	Same as for alarm 1 type
	000D		Alarm 3 type	Same as for alarm 1 type
	000E	-	Control output 1 allocation	00000000H (0): Heating control output for ch1 00000001H (1): Cooling control output for heating/cooling control for ch1 00000002H (2): Alarm 1 and HB alarm OR output for ch1 (See note 1.) Alarm 1 and sensor error alarm OR output for ch1 (See note 2.) 00000003H (3): Alarm 2 output for ch1 00000004H (4): Alarm 3 output for ch1 00000005H (5): Heating control output for ch2 00000006H (6): Cooling control output for heating/cooling control for ch2 00000007H (7): Alarm 1 and HB alarm OR output for ch2 (See note 1.) Alarm 1 and sensor error alarm OR output for ch2 (See note 2.) 00000008H (8): Alarm 2 output for ch2 00000009H (9): Alarm 3 output for ch2 ----- 0000000AH (10): SP transfer output for ch1 (See note 2.) 0000000BH (11): Ramp SP transfer output for ch1 (See note 2.) 0000000CH (12): PV transfer output for ch1 (See note 2.) 0000000DH (13): Heating MV transfer output for ch1 (See note 2.) 0000000EH (14): Cooling MV transfer output for ch1 (See note 2.) 0000000FH (15): SP transfer output for ch2 (See note 2.) 00000010H (16): Ramp SP transfer output for ch2 (See note 2.) 00000011H (17): PV transfer output for ch2 (See note 2.) 00000012H (18): Heating MV transfer output for ch2 (See note 2.) 00000013H (19): Cooling MV transfer output for ch2 (See note 2.)
000F		Control output 2 allocation	Same as for control output 1 allocation	

Variable type	Address	ch	Setting data name	Description
C3	0010	-	Auxiliary output 1 allocation	00000000H (0): Heating control output for ch1 00000001H (1): Cooling control output for heating/cooling control for ch1 00000002H (2): Alarm 1 and HB alarm OR output for ch1 (See note 1.) Alarm 1 and sensor error alarm OR output for ch1 (See note 2.) 00000003H (3): Alarm 2 output for ch1 00000004H (4): Alarm 3 output for ch1 00000005H (5): Heating control output for ch2 00000006H (6): Cooling control output for heating/cooling control for ch2 00000007H (7): Alarm 1 and HB alarm OR output for ch2 (See note 1.) Alarm 1 and sensor error alarm OR output for ch2 (See note 2.) 00000008H (8): Alarm 2 output for ch2 00000009H (9): Alarm 3 output for ch2
	0011		Auxiliary output 2 allocation	Same as for control output 1 allocation
	0012		Operation after power ON	00000000H (0): Stop 00000001H (1): Continue (Continues the operation status from before the power supply was stopped.)
	0013		Communications data length	00000007H (7): 7 00000008H (8): 8
	0014		Communications stop bit	00000001H (1): 1 00000002H (2): 2
	0015		Communications parity	00000000H (0): None 00000001H (1): Even 00000002H (2): Odd
	0016		Communications response transmission wait time	00000000H to 0000270FH (0 to 9,999)
	0017		No. of multi-SP uses	00000000H (0): No multi-SP 00000001H (1): Switch between SP0/1
	0018		Event input function	00000000H (0): Non 00000001H (1): RUN/STOP
	0019		Use multi-SP	00000000H (0): OFF 00000001H (1): ON
	001A	1	SP ramp setting	00000000H (0): OFF 00000001H to 0000270FH (1 to 9,999)
	001B	-	Standby sequence restart	00000000H (0): Condition A 00000001H (1): Condition B
	001C	1	Alarm 1 open in alarm	00000000H (0): Closed 00000001H (1): Open
	001D		Alarm 1 hysteresis	00000001H to 0000270FH (0.1 to 999.9)
001E	1	Alarm 2 open in alarm	00000000H (0): Closed 00000001H (1): Open	
001F		Alarm 2 hysteresis	00000001H to 0000270FH (0.1 to 999.9)	
0020		Alarm 3 open in alarm	00000000H (0): Closed 00000001H (1): Open	
0021		Alarm 3 hysteresis	00000001H to 00002702FH (0.1 to 999.9)	

Variable type	Address	ch	Setting data name	Description
C3	0022	-	Use heater burnout (See note 1.)	00000000H (0): OFF 00000001H (1): ON (See note 1.)
	0023	-	Heater burnout latch (See note 1.)	00000000H (0): OFF 00000001H (1): ON (See note 1.)
	0024	1	Heater burnout hysteresis	00000001H to 000001F4H (0.1 to 50.0) (See note 1.)
	0025	-	α	00000000H to 00000064H (0.00 to 1.00)
	0026	1	MV upper limit	Standard: Manipulated variable lower limit + 0.1 to 0000041AH (manipulated variable lower limit + 0.1 to 105.0) Heating/cooling: 00000000H to 0000041AH (0.0 to 105.0)
	0027	1	MV lower limit	Standard: FFFFFFFCEH to manipulated variable upper limit - 0.1 (-5.0 to manipulated variable upper limit - 0.1) Heating/cooling: FFFFFBE6H to 00000000H (105.0 to 0.0)
	0028	1	Input digital filter	00000000H to 0000270FH (0.0 to 999.9)
	0029	-	Additional PV display	00000000H (0): OFF 00000001H (1): ON
	002A	-	Temperature input offset display add	00000000H (0): OFF 00000001H (1): ON
	002B	1	Alarm 1 latch	00000000H (0): OFF 00000001H (1): ON
	002C	1	Alarm 2 latch	00000000H (0): OFF 00000001H (1): ON
	002D	1	Alarm 3 latch	00000000H (0): OFF 00000001H (1): ON
	002E	-	Cold junction compensation method	00000000H (0): OFF 00000001H (1): ON

Variable type	Address	ch	Setting data name	Description
C3	002F	-	Auxiliary output 3 allocation (See note 2.)	00000000H (0): Heating control output for ch1
				00000001H (1): Cooling control output for heating/cooling control for ch1
				00000002H (2): Alarm 1 and sensor error alarm OR output for ch1
				00000003H (3): Alarm 2 output for ch1
				00000004H (4): Alarm 3 output for ch1
				00000005H (5): Heating control output for ch2
				00000006H (6): Cooling control output for heating/cooling control for ch2
				00000007H (7): Alarm 1 and sensor error alarm OR output for ch2
				00000008H (8): Alarm 2 output for ch2
				00000009H (9): Alarm 3 output for ch2
				0000000AH (10): SP transfer output for ch1
				0000000BH (11): Ramp SP transfer output for ch1
				0000000CH (12): PV transfer output for ch1
				0000000DH (13): Heating MV transfer output for ch1
0000000EH (14): Cooling MV transfer output for ch1				
0000000FH (15): SP transfer output for ch2				
00000010H (16): Ramp SP transfer output for ch2				
00000011H (17): PV transfer output for ch2				
00000012H (18): Heating MV transfer output for ch2				
00000013H (19): Cooling MV transfer output for ch2				
0030			Auxiliary output 4 allocation (See note 2.)	Same as for auxiliary output 3 allocation.
0031			OUT1 transfer output upper limit (See note 2.)	FFFFF831H to 0000270FH (-1,999 to 9,999 or -199.9 to 999.9)
0032			OUT1 transfer output lower limit (See note 2.)	FFFFF831H to 0000270FH (-1,999 to 9,999 or -199.9 to 999.9)
0033			OUT2 transfer output upper limit (See note 2.)	FFFFF831H to 0000270FH (-1,999 to 9,999 or -199.9 to 999.9)
0034			OUT2 transfer output lower limit (See note 2.)	FFFFF831H to 0000270FH (-1,999 to 9,999 or -199.9 to 999.9)
0035			SUB3 transfer output upper limit (See note 2.)	FFFFF831H to 0000270FH (-1,999 to 9,999 or -199.9 to 999.9)
0036			SUB3 transfer output lower limit (See note 2.)	FFFFF831H to 0000270FH (-1,999 to 9,999 or -199.9 to 999.9)
0037			SUB4 transfer output upper limit (See note 2.)	FFFFF831H to 0000270FH (-1,999 to 9,999 or -199.9 to 999.9)
0038			SUB4 transfer output lower limit (See note 2.)	FFFFF831H to 0000270FH (-1,999 to 9,999 or -199.9 to 999.9)
0039			Current output type (See note 2.)	00000000H(0): 4 to 20 mA DC 00000001H(1): 0 to 20 mA DC
003A			Voltage output type (See note 2.)	00000000H(0): 1 to 5 VDC 00000001H(1): 0 to 5 VDC

Variable type	Address	ch	Setting data name	Description
C3	003B	-	Sensor error indicator (See note 2.)	00000000H(0): Indicators always not lit 00000001H(1): Sensor error indicator lit (ch1 only) 00000002H(2): Sensor error indicator lit (ch2 only) 00000003H(3): Sensor error indicator lit (ch1 or ch2)
	003C		Remote-local logic (See note 2.)	00000000H(0): Reverse logic 00000001H(1): Normal
	003D		Input error output (See note 2.)	00000000H(0): OFF 00000001H(1): ON
	003E		Input shift type (See note 2.)	00000000H(0): One-point temperature input shift 00000001H(1): Two-point temperature input shift

Variable type	Address	ch	Setting data name	Description
C3	0100	-	Input type	Platinum-resistance thermometer input type: 00000000H (0): Pt (–200 to 850°C or –300 to 1,500°F) 00000001H (1): Pt (–199.9 to 500.0°C or –199.9 to 900.0°F) 00000002H (2): Pt (0.0 to 100°C or 0.0 to 210.0°F) 00000003H (3): JPt (–199.9 to 500.0°C or –199.9 to 900.0°F) 00000004H (4): JPt (0.0 to 100.0°C or 0.0 to 210.0°F)
				Thermocouple input type: 00000000H (0): K (–200 to 1,300°C or –300 to 2,300°F) 00000001H (1): K (–20.0 to 500.0°C or 0.0 to 900.0°F) 00000002H (2): J (–100 to 850°C or –100 to 1,500°F) 00000003H (3): J (–20.0 to 400.0°C or 0.0 to 750.0°F) 00000004H (4): T (–200 to 400°C or –300 to 700°F) 00000005H (5): E (0 to 600°C or 0 to 1,100°F) 00000006H (6): L (–100 to 850°C or –100 to 1,500°F) 00000007H (7): U (–200 to 400°C or –300 to 700°F) 00000008H (8): N (–200 to 1,300°C or –300 to 2,300°F) 00000009H (9): R (0 to 1,700°C or 0 to 3,000°F) 0000000AH (10): S (0 to 1,700°C or 0 to 3,000°F) 0000000BH (11): B (100 to 1,800°C or 300 to 3,200°F) 0000000CH (12): Infrared temperature sensor (K10 to 70°C) 0000000DH (13): Infrared temperature sensor (K60 to 120°C) 0000000EH (14): Infrared temperature sensor (K115 to 165°C) 0000000FH (15): Infrared temperature sensor (K160 to 260°C) 00000010H (16): 0 to 50 mV 00000011H (17): T (–199.9 to 400.0°C or –199.9 to 700.0°F) 00000012H (18): U (–199.9 to 400.0°C or –199.9 to 700.0°F)
	0101	2	Scaling upper limit	Scaling lower limit + 1 to 0000270FH (scaling lower limit + 1 to 9,999)
	0102		Scaling lower limit	FFFFF831H to scaling upper limit – 1 (–1,999 to scaling upper limit – 1)
	0103		Decimal point position	00000000H to 00000001H (0 to 1)
	0104	-	Temperature units	00000000H (0): °C 00000001H (1): °F
	0105	2	SP upper limit	Temperature: SP lower limit + 1 to input range upper limit
				Analog: SP lower limit + 1 to scaling upper limit
	0106	2	SP lower limit	Temperature: Input range lower limit to SP upper limit – 1
				Analog: Scaling lower limit to SP upper limit – 1
	0107		PID/ OnOff	00000000H (0): ON/OFF 00000001H (1): 2-PID control
	0108		Heating control period	00000001H to 00000063H (1 to 99)
	0109		Cooling control period	00000001H to 00000063H (1 to 99)
010A		Direct/reverse operation	00000000H (0): Reverse operation 00000001H (1): Direct operation	

Variable type	Address	ch	Setting data name	Description
C3	010B	2	Alarm 1 type	00000000H (0): No alarm function 00000001H (1): Upper and lower limit alarm 00000002H (2): Upper limit alarm 00000003H (3): Lower limit alarm 00000004H (4): Upper and lower limit range alarm 00000005H (5): Upper and lower limit alarm with standby sequence 00000006H (6): Upper limit alarm with standby sequence 00000007H (7): Lower limit alarm with standby sequence 00000008H (8): Absolute value upper limit alarm 00000009H (9): Absolute value lower limit alarm 0000000AH (10): Absolute value upper limit alarm with standby sequence 0000000BH (11): Absolute value lower limit alarm with standby sequence
	010C		Alarm 2 type	Same as for alarm 1 type
	010D		Alarm 3 type	Same as for alarm 1 type
	010E	-	Control output 1 allocation	00000000H (0): Heating control output for ch1 00000001H (1): Cooling control output for heating/cooling control for ch1 00000002H (2): Alarm 1 and HB alarm OR output for ch1 (See note 1.) Alarm 1 and sensor error alarm OR output for ch1(See note 2.) 00000003H (3): Alarm 2 output for ch1 00000004H (4): Alarm 3 output for ch1 00000005H (5): Heating control output for ch2 00000006H (6): Cooling control output for heating/cooling control for ch2 00000007H (7): Alarm 1 and HB alarm OR output for ch2 (See note 1.) Alarm 1 and sensor error alarm OR output for ch2 (See note 2.) 00000008H (8): Alarm 2 output for ch2 00000009H (9): Alarm 3 output for ch2 0000000AH (10): SP transfer output for ch1 (See note 2.) 0000000BH (11): Ramp SP transfer output for ch1 (See note 2.) 0000000CH (12): PV transfer output for ch1 (See note 2.) 0000000DH (13): Heating MV transfer output for ch1 (See note 2.) 0000000EH (14): Cooling MV transfer output for ch1 (See note 2.) 0000000FH (15): SP transfer output for ch2 (See note 2.) 00000010H (16): Ramp SP transfer output for ch2 (See note 2.) 00000011H (17): PV transfer output for ch2 (See note 2.) 00000012H (18): Heating MV transfer output for ch2 (See note 2.) 00000013H (19): Cooling MV transfer output for ch2 (See note 2.)
	010F		Control output 2 allocation	Same as for control output 1 allocation

Variable type	Address	ch	Setting data name	Description
C3	0110	-	Auxiliary output 1 allocation	00000000H (0): Heating control output for ch1 00000001H (1): Cooling control output for heating/cooling control for ch1 00000002H (2): Alarm 1 and HB alarm OR output for ch1 (See note 1.) Alarm 1 and sensor error alarm OR output for ch1(See note 2.) 00000003H (3): Alarm 2 output for ch1 00000004H (4): Alarm 3 output for ch1 00000005H (5): Heating control output for ch2 00000006H (6): Cooling control output for heating/cooling control for ch2 00000007H (7): Alarm 1 and HB alarm OR output for ch2 (See note 1.) Alarm 1 and sensor error alarm OR output for ch2 (See note 2.) 00000008H (8): Alarm 2 output for ch2 00000009H (9): Alarm 3 output for ch2
	0111		Auxiliary output 2 allocation	Same as for auxiliary output 1 allocation
	0112		Operation after power ON	00000000H (0): Stop 00000001H (1): Continue (Continues the operation status from before the power supply was stopped.)
	0113		Communications data length	00000007H (7): 7 00000008H (8): 8
	0114		Communications stop bit	00000001H (1): 1 00000002H (2): 2
	0115		Communications parity	00000000H (0): None 00000001H (1): Even 00000002H (2): Odd
	0116		Communications response transmission wait time	00000000H to 0000270FH (0 to 9,999)
	0117		No. of multi-SP uses	00000000H (0): No multi-SP 00000001H (1): Switch between SP0/1
	0118		Event input allocation	00000000H (0): None 00000001H (1): RUN/STOP
	0119		Use multi-SP	00000000H (0): OFF 00000001H (1): ON

Variable type	Address	ch	Setting data name	Description
C3	011A	2	SP ramp setting	00000000H (0): OFF 00000001H to 0000270FH (1 to 9,999)
	011B	-	Standby sequence restart	00000000H (0): Condition A 00000001H (1): Condition B
	011C	2	Alarm 1 open in alarm	00000000H (0): Closed 00000001H (1): Open
	011D		Alarm 1 hysteresis	00000001H to 0000270FH (0.1 to 999.9)
	011E		Alarm 2 open in alarm	00000000H (0): Closed 00000001H (1): Open
	011F		Alarm 2 hysteresis	00000001H to 0000270FH (0.1 to 999.9)
	0120		Alarm 3 open in alarm	00000000H (0): Closed 00000001H (1): Open
	0121		Alarm 3 hysteresis	00000001H to 0000270FH (0.1 to 999.9)
	0122		-	Use heater burnout (See note 1.)
	0123	Heater burnout latch (See note 1.)		00000000H (0): OFF 00000001H (1): ON
	0124	2	Heater burnout hysteresis (See note 1.)	00000001H to 000001F4H (0.1 to 50.0)
	0125	-	α	00000000H to 00000064H (0.00 to 1.00)
	0126	2	MV upper limit	Standard: Manipulated variable lower limit + 0.1 to 0000041AH (manipulated variable lower limit + 0.1 to 105.0) Heating/cooling: 00000000H to 0000041AH (0.0 to 105.0)
	0127		MV lower limit	Standard: FFFFFFFCEH to manipulated variable upper limit - 0.1 (-5.0 to manipulated variable upper limit - 0.1) Heating/cooling: FFFFFBE6H to 00000000H (105.0 to 0.0)
	0128		Input digital filter	00000000H to 0000270FH (0.0 to 999.9)
	0129	-	Additional PV display	00000000H (0): OFF 00000001H (1): ON
	012A		Temperature input offset display add	00000000H (0): OFF 00000001H (1): ON
	012B	2	Alarm 1 latch	00000000H (0): OFF 00000001H (1): ON
	012C		Alarm 2 latch	00000000H (0): OFF 00000001H (1): ON
	012D		Alarm 3 latch	00000000H (0): OFF 00000001H (1): ON
012E	-	Cold junction compensation method	00000000H (0): OFF 00000001H (1): ON	

Variable type	Address	ch	Setting data name	Description	
C3	012F	-	Auxiliary output 3 allocation (See note 2.)	00000000H (0): Heating control output for ch1 00000001H (1): Cooling control output for heating/cooling control for ch1 00000002H (2): Alarm 1 and sensor error alarm OR output for ch1 00000003H (3): Alarm 2 output for ch1 00000004H (4): Alarm 3 output for ch1 00000005H (5): Heating control output for ch2 00000006H (6): Cooling control output for heating/cooling control for ch2 00000007H (7): Alarm 1 and sensor error alarm OR output for ch2 00000008H (8): Alarm 2 output for ch2 00000009H (9): Alarm 3 output for ch2 0000000AH (10): SP transfer output for ch1 0000000BH (11): Ramp SP transfer output for ch1 0000000CH (12): PV transfer output for ch1 0000000DH (13): Heating MV transfer output for ch1 0000000EH (14): Cooling MV transfer output for ch1 0000000FH (15): SP transfer output for ch2 00000010H (16): Ramp SP transfer output for ch2 00000011H (17): PV transfer output for ch2 00000012H (18): Heating MV transfer output for ch2 00000013H (19): Cooling MV transfer output for ch2	
			0130	Auxiliary output 4 allocation (See note 2.)	Same as for auxiliary output 3 allocation
			0131	OUT1 transfer output upper limit (See note 2.)	FFFFF831H to 0000270FH (–1,999 to 9,999 or –199.9 to 999.9)
			0132	OUT1 transfer output lower limit (See note 2.)	FFFFF831H to 0000270FH (–1,999 to 9,999 or –199.9 to 999.9)
			0133	OUT2 transfer output upper limit (See note 2.)	FFFFF831H to 0000270FH (–1,999 to 9,999 or –199.9 to 999.9)
			0134	OUT2 transfer output lower limit (See note 2.)	FFFFF831H to 0000270FH (–1,999 to 9,999 or –199.9 to 999.9)
			0135	SUB3 transfer output upper limit (See note 2.)	FFFFF831H to 0000270FH (–1,999 to 9,999 or –199.9 to 999.9)
			0136	SUB3 transfer output lower limit (See note 2.)	FFFFF831H to 0000270FH (–1,999 to 9,999 or –199.9 to 999.9)
			0137	SUB4 transfer output upper limit (See note 2.)	FFFFF831H to 0000270FH (–1,999 to 9,999 or –199.9 to 999.9)
			0138	SUB4 transfer output lower limit (See note 2.)	FFFFF831H to 0000270FH (–1,999 to 9,999 or –199.9 to 999.9)
			0139	Current output type (See note 2.)	00000000H(0): 4 to 20 mA DC 00000001H(1): 0 to 20 mA DC
			013A	Voltage output type (See note 2.)	00000000H(0): 1 to 5 VDC 00000001H(1): 0 to 5 VDC
			013B	Sensor error indicator used (See note 3.)	00000000H(0): Indicators always not lit. 00000001H(1): Sensor error indicator lit (ch1 only) 00000002H(2): Sensor error indicator lit (ch2 only) 00000003H(3): Sensor error indicator lit (ch1 or ch2)
			013D	Input error output (See note 3.)	00000000H(0): OFF 00000001H(1): ON
			013E	Input shift type (See note 3.)	00000000H(0): One-point temperature input shift 00000001H(1): Two-point temperature input shift

Variable type	Address	ch	Setting data name	Description
C5	0000	1	Remote PV	Temperature: According to specified range for each sensor
				Analog: Scaling lower limit – 5% FS to scaling upper limit + 5% FS
	0100	2	Remote PV	Temperature: According to specified range for each sensor
				Analog: Scaling lower limit – 5% FS to scaling upper limit + 5% FS
C7	0000	-	Remote PV mode	00000000H (0): OFF (normal mode) 00000001H (1): ON (remote PV mode)
	0001	-	Remote PV communications wait time	00000000H to 0000270F (0 to 9,999) ms
	0100	-	Remote PV mode	00000000H (0): OFF (normal mode) 00000001H (1): ON (remote PV mode)
	0101	-	Remote PV communications wait time	00000000H to 0000270F (0 to 9,999) ms

SECTION 6

Using the E5ZN-SDL

6-1	Introduction	108
6-1-1	Outline	108
6-1-2	Dimension	108
6-1-3	Preparation	109
6-1-4	System Configuration	109
6-2	Names of Parts on the Front Panel	111
6-2-1	Front Panel	111
6-2-2	Display	111
6-2-3	Using the Keys	112
6-2-4	Main Functions	112
6-3	Setup Level Configuration and Front Panel Keys	114
6-4	Initial Setup Examples	116
6-5	Using Copy Mode	118
6-5-1	Parameter Copy Operations	118
6-5-2	Copying Parameters from Master to Slaves	119
6-6	List of Parameters	122

6-1 Introduction

6-1-1 Outline

The E5ZN-SDL Setting Display Unit is used to set and display parameters for E5ZN Temperature Controllers. Using the E5ZN-SDL simplifies the initial settings and maintenance of the E5ZN.

6-1-2 Dimension

E5ZN-SDL

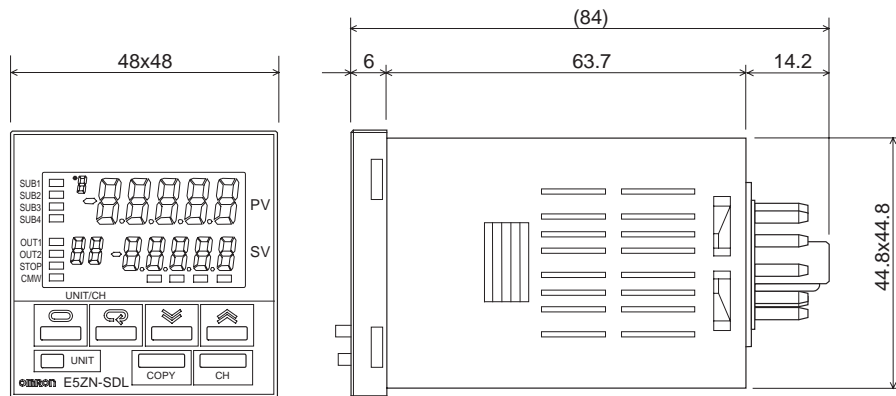

P2CF-11

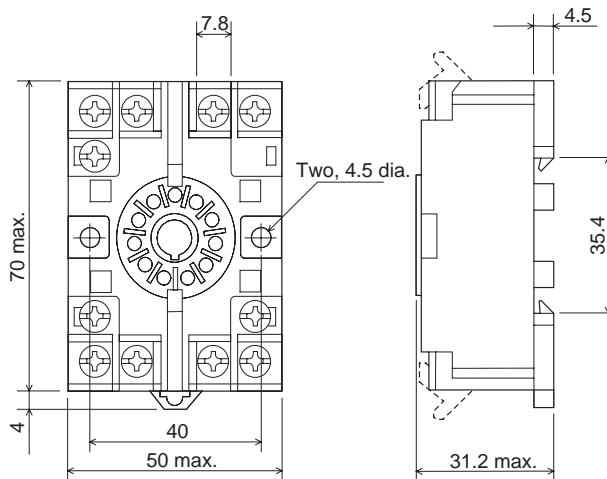

Note Purchase the P2CF-11 Front-connecting Socket separately. (The P3GA-11 Back-connecting Socket can also be used.)

6-1-3 Preparation

The E5ZN-SDL uses serial communications to display the settings for the E5ZN Temperature Controller.
 Connect the E5ZN-SDL to the E5ZN-SCT24S-500. There is no connection terminal on the E5ZN-SCT18S-500.

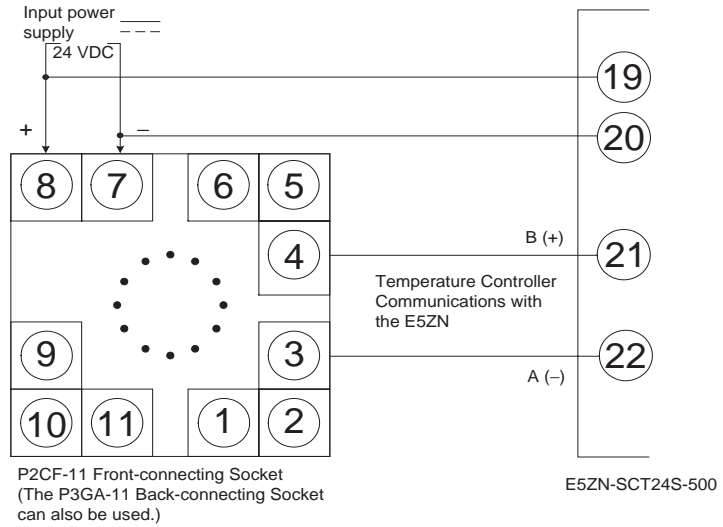

- Note**
1. Connections between terminals 4 and 9, 7 and 11, and 8 and 10 are made inside the E5ZN-SDL. Refer to the following connection diagram.
 2. Do not connect anything to terminals 1, 2, 5, or 6.

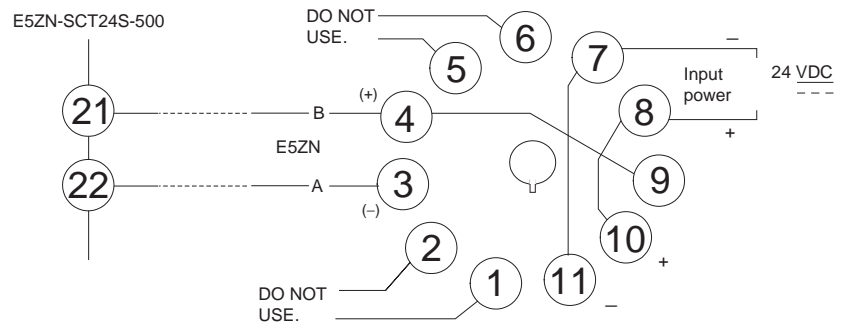

6-1-4 System Configuration

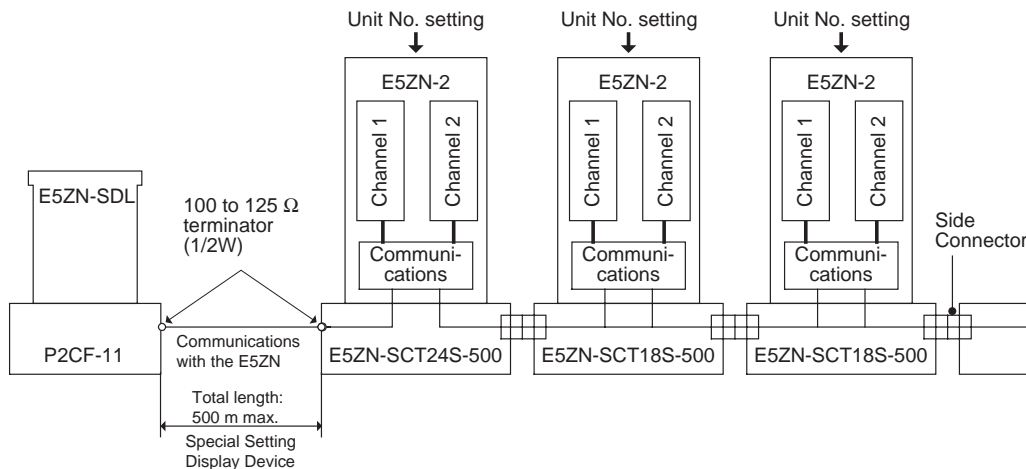

- The RS-485 connection can be either one-to-one to one-to-N. Up to 16 units can be connected in one-to-N systems
- Keep the total cable length to 500 m maximum.
- Attach a terminator to both ends of the transmission path.

Note Communications with the E5ZN-SDL will be cut if the E5ZN-2 connection to the E5ZN-SCT24S-500 is broken

The E5ZN Temperature Controller and the E5ZN-SDL are connected by serial communications. When connecting multiple E5ZN Temperature Controllers, set a different unit number for each one.

The E5ZN-SDL recognizes the E5ZN Temperature Controllers by the unit numbers. Use the UNIT Key on the E5ZN-SDL to set the unit number of the E5ZN Temperature Controller to be set and displayed on the E5ZN-SDL.

The E5ZN-2 Temperature Controller has two channel input channels.

Use the CH Key to set the E5ZN-SDL channel number to be displayed.

6-2 Names of Parts on the Front Panel

6-2-1 Front Panel

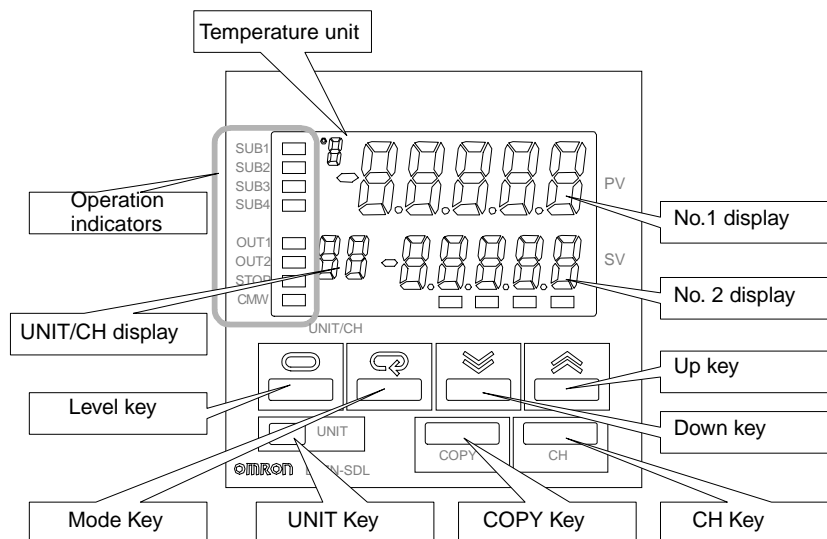

6-2-2 Display

No.1 Display

Displays the type of PV or parameter for the E5ZN Temperature Controller.

No. 2 Display

Displays the PV, read value for the parameter, and the input value when settings are changed for the E5ZN Temperature Controller.

Temperature Unit

The temperature unit is displayed when the display unit parameter for the E5ZN Temperature Controller is set to a temperature. Indication is determined by the current set value of the "temperature unit" parameter. When this parameter is set to °C, "C" is displayed, and when set to °F, "F" is displayed.

Operation Indicators

1,2,3...

1. **SUB1 (auxiliary output 1)**
Lit when the auxiliary output 1 function is ON.
- SUB2 (auxiliary output 2)**
Lit when the auxiliary output 2 function is ON.
- SUB3 (auxiliary output 3)**
Pulse output models: Always not lit.
Analog output models: Not lit when the auxiliary output drops to 0% or lower.
Lit when the auxiliary output is above 0%.
- SUB4 (auxiliary output 4)**
Pulse output models: Always not lit.
Analog output models: Not lit when the auxiliary output drops to 0% or lower.
Lit when the auxiliary output is above 0%.
2. **OUT1 (control output 1)**
Pulse output models: Lit when the control output 1 function is ON.
Analog output models: Not lit when the control output drops to 0% or lower.
Lit when the control output is above 0%.

OUT2 (control output 2)

Pulse output models: Lit when the control output 2 function is ON.

Analog output models: Not lit when the control output drops to 0% or lower.

Lit when the control output is above 0%.

3. **STOP (stop)**

Lit when operation for the selected channel is stopped. Lit when the “RUN/STOP” parameter is set to STOP. Not lit at all other times.

4. **CMW (Communications writing control)**

Lit when communications writing is enabled and not lit when writing is disabled.

5. **UNIT/CH display**

Displays the E5ZN Temperature Indicator unit number and channel number that will be set and displayed on the E5ZN-SDL.

When facing the front panel, the unit number (0 to F) is displayed on the left and the channel number (1 to 2, U) is displayed on the right.

When the channel number is “U,” the setting and display is used by both channels.

6-2-3 Using the Keys**Level Key**

Press this key to select the setting levels.

Mode Key

Press this key to select parameters within each level.

Up Key

Each press of this key increments values displayed on the No. 2 display. Holding down this key continuously increments values.

Alternatively, the display moves to the next setting item.

Down Key

Each press of this key decrements values displayed on the No. 2 display. Holding down this key continuously decrements values.

Alternatively, the display moves back one setting item.

Level Key + Mode Key

This key combination sets the E5ZN to the “protect level.” For details on the protect level, refer to *6-3 Setup Level Configuration and Front Panel Keys*.

UNIT Key

Each press of this key increments the unit number.

Select the E5ZN Temperature Controller unit number to set for the E5ZN-SDL.

CH Key

Each press of this key changes the channel number.

The channel number cannot be selected when the channel number display for the E5ZN Temperature Controller is “U” because the setting is used by both channels.

COPY Key

Press this key to read all E5ZN Temperature Controller set values to the E5ZN-SDL or to write all set values to the E5ZN from the E5ZN-SDL.

6-2-4 Main Functions**Display**

The PV and set values for the E5ZN Temperature Controller as well as other data and control outputs, auxiliary outputs, and other status information can be displayed.

Settings

The parameters and control operations for the E5ZN Temperature Controller can be changed.

Copy

All settings for the E5ZN Temperature Controller can be read and saved to the E5ZN-SDL. Also, all the settings for the E5ZN Temperature Controller that were saved in the E5ZN-SDL can be written to the E5ZN Temperature Controller.

6-3 Setup Level Configuration and Front Panel Keys

Parameters are divided into groups called levels. Each of the set values (setup items) in these levels are called a parameter. The parameters on the E5ZN are divided into the following seven levels:

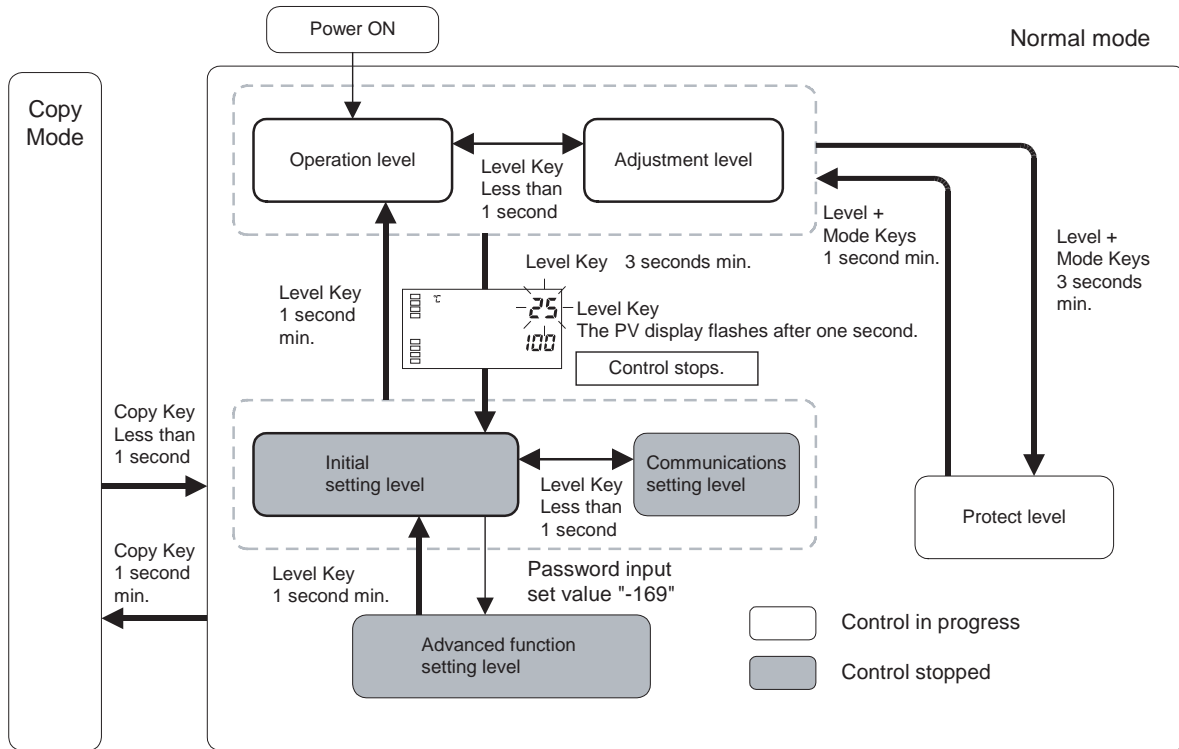

Mode/Level		Control in progress	Control stopped
Normal mode	Protect level	OK	-
	Operation level	OK	-
	Adjustment level	OK	-
	Initial setting level	-	OK
	Advanced function setting level	-	OK
	Communications setting level	-	OK
Copy mode		-	OK

OK: Indicates items that can be set.

Note To move to the advanced function setting level, set the “initial setting/communications protection” parameter in the “protect level” to “0.”

Of these levels in normal mode, the initial setting level, communications setting level, and advanced function setting level can be used only when control has stopped. Controller outputs are stopped when any of these four levels are selected.

It is possible to enter copy mode while Controller outputs are being made, but copy operations (e.g., upload, download) can be used only when control has stopped.

- Protect Level** To move the mode to this level, simultaneously press the Level and Mode Keys for at least three seconds in the operation level or adjustment level. This level is for preventing unwanted or accidental modification of parameters. Protected levels will not be displayed, and so the parameters in that level cannot be modified.
- Operation Level**
- This level is initially displayed when you turn ON the power to the E5ZN. You can move to the protect level, initial setting level, and adjustment level from this level.
 - During operation, the PV, SP, and manipulated variable can be monitored, and the SP, alarm value and upper and lower limit alarms can be monitored and modified.
- Adjustment Level**
- To move the mode to this level, press the Level Key for less than one second.
 - This level is for entering set values and offset values for control. This level contains parameters for setting the autotuning, communications writing enable/disable, hysteresis, multi-SP, input shift values, heater burnout alarm (HBA) settings, PID constants, etc. You can move to the top parameter of the initial setting level and operation level from here.
- Initial Setting Level** To move the mode to this level, press the Level Key for at least three seconds in the operation level or adjustment level. The first display flashes after one second. This level is for specifying the input type, selecting the control method, control period, setting direct/reverse action and alarm type. You can move to the advanced function setting level or communications setting level from this level. To return to the operation level, press the Level Key for at least one second. To move to the communications setup level, press the Level Key for less than one second.
The display will be blank “----” when you move from the initial setting level to the operation level.
- Advanced Function Setting Level**
- To enter this level, you must enter the password “-169” in the initial setting level.
 - You can move to the initial setting level only from this level.
 - This level is for setting the MV limits, event input assignment, standby sequence, alarm hysteresis, and other parameters.
- Communications Setting Level** To move to this level, press the Level Key for less than one second in the initial setting level. When the communications settings are to be used, set the communications conditions in this level. Communicating with a personal computer (host computer) allows SPs to be read and written, and manipulated variables to be monitored.

6-4 Initial Setup Examples

On previous Controllers, the sensor input type, alarm type, and control period were set on DIP switches. These hardware settings are now set using the setup menus of the E5ZN-SDL. The Level and Mode Keys are used to switch between setup menus, and the amount of time that you hold the keys down determines which setup menu you move to.

Typical Usage Example

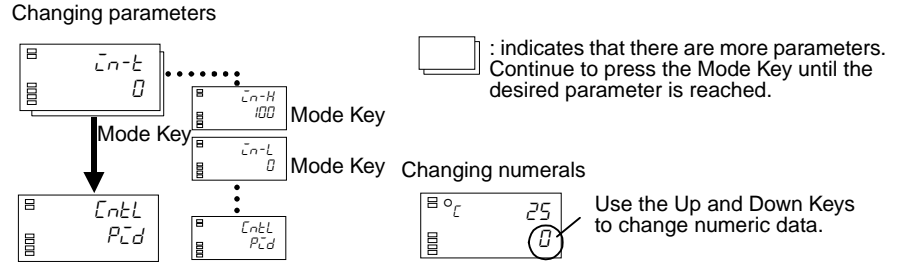

Typical Example 1

- Input type: 0 (K thermocouple -200 to 1,300°C)
- Control method: ON/OFF control
- Alarm type: 2 (upper limit)
- Alarm value 1: 20°C
- SP: 100°C

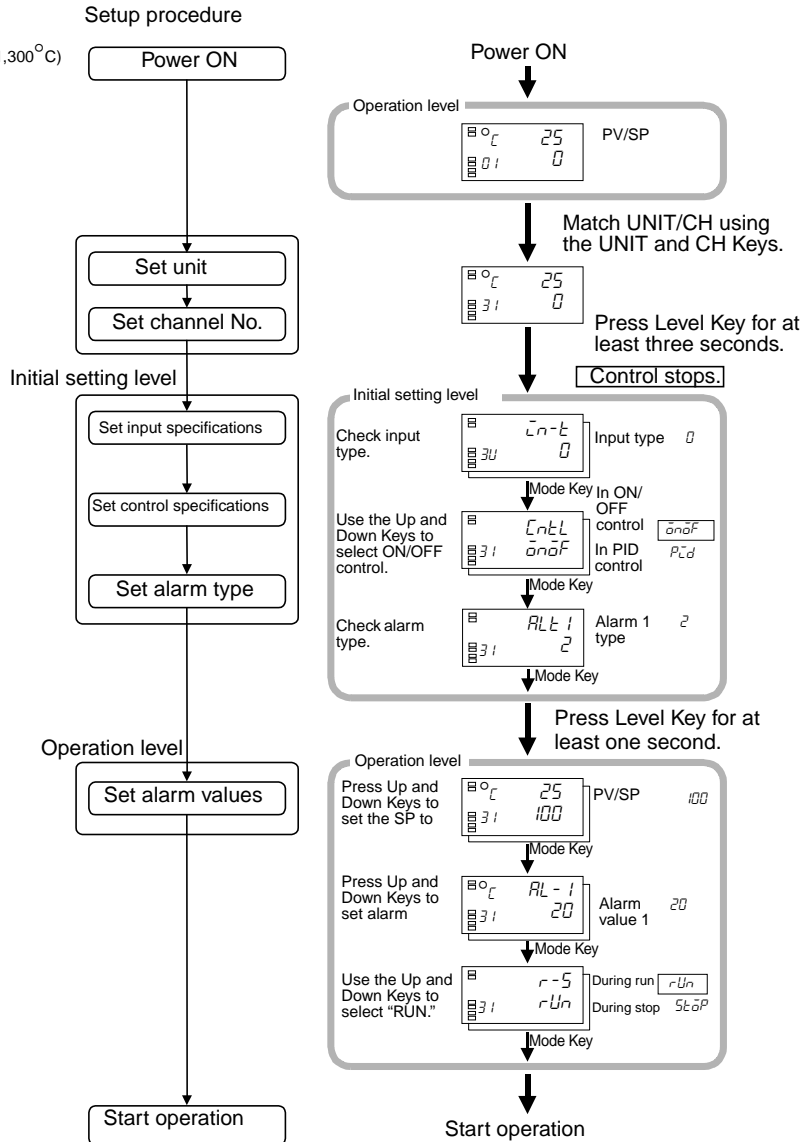

Typical Example 2

Input type: 4 (T thermocouple -200 to 400°C) E5ZN unit number: 1
 Control method: PID control Channel: 2
 Calculate PID constants by autotuning.
 Alarm type: 2 (upper limit)
 Alarm value 1: 30°C

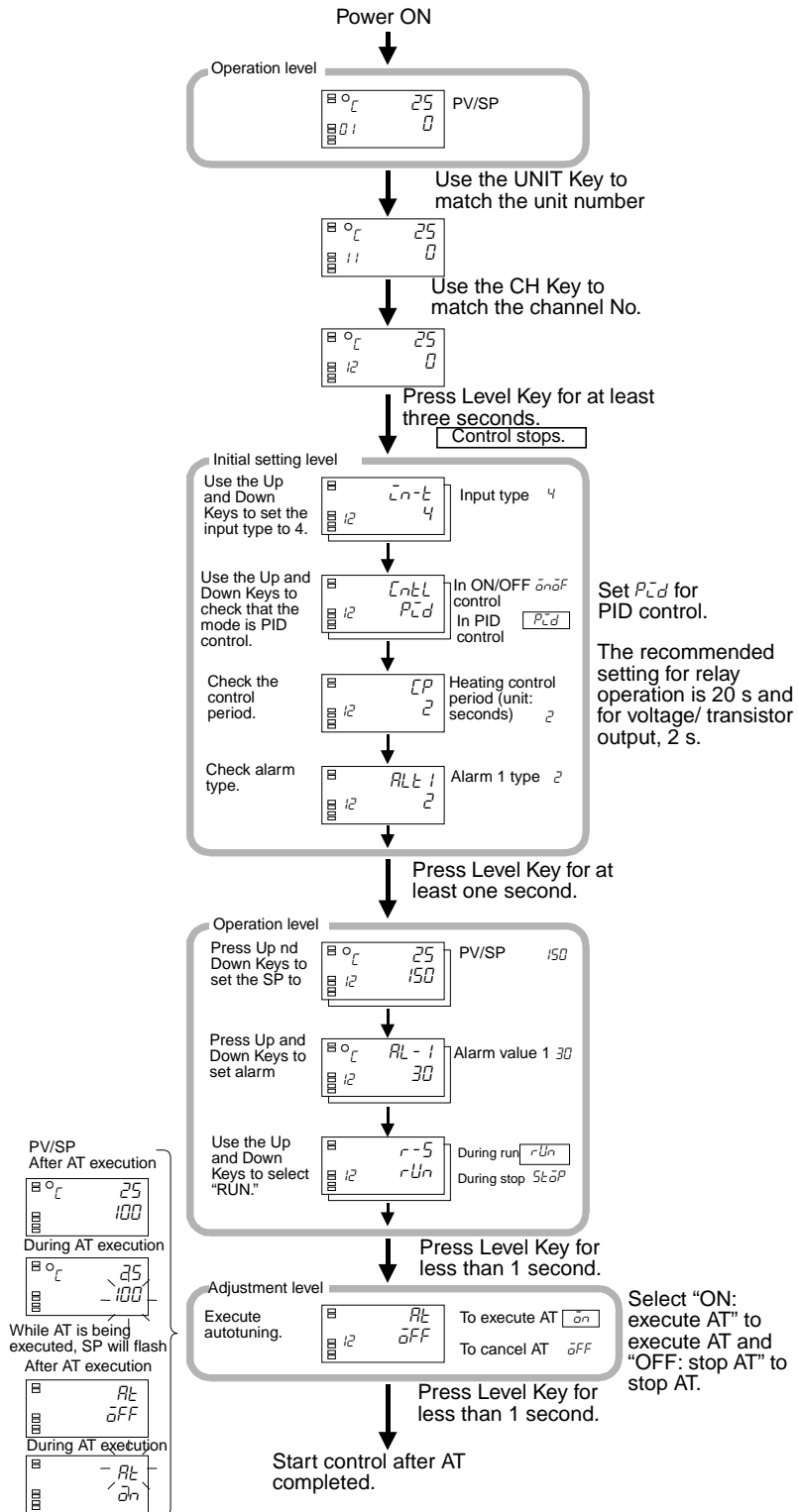
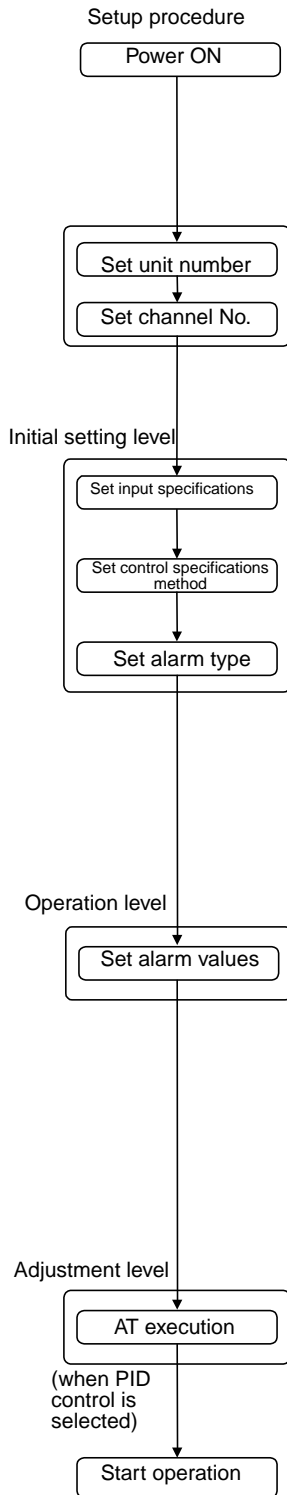

6-5 Using Copy Mode

6-5-1 Parameter Copy Operations

Upload (Temperature Controller to Setting Display Unit)

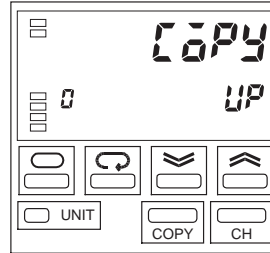

- 1,2,3...
1. Press the **COPY** Key for at least one second to move to the copy mode.
 2. Use the **Up** and **Down** Keys to select "UP" on the No. 2 display. Press the **UNIT** Key to select the unit number for the upload. Any unit number from 0 to F and "-" (All units) can be selected.
 3. Press the **Level** Key for at least one second to start the upload.
- Note** a) "Up" will flash on the No. 2 display during the upload.
 b) The mode will return automatically to the operation level when the upload has been completed.

Download (Setting Display Unit to Temperature Controller)

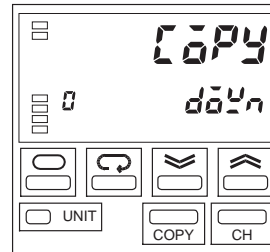

- 1,2,3...
1. Press the **COPY** Key for at least one second to move to the copy mode.
 2. Use the **Up** and **Down** Keys to select "DOWN." The possible selections are "UP" and "DOWN."
 3. Press the **UNIT** Key to select the unit number for the download. Any unit number from 0 to F can be selected. However, the unit number for any units without uploaded data will not be displayed. Also, the selection operation will not be possible if the uploaded information was uploaded from all units. The UNIT display will be "-".
- Note** For example, to download setting data from unit number 1 to unit number 2, change the unit number of unit number 2 from 2 to 1, and change the number of unit number 1 to another unit number or disconnect the socket connected to unit number 1. Be sure that there is only one Unit with the same Unit number on the network at any one time.
4. Press the **Level** Key for at least one second to start the download.
- Note** a) Control must be stopped to download data. The copy operation will not be possible in RUN mode.
 b) "Down" will flash on the No. 2 display during the download.
 c) The mode will return automatically to the operation level when the download has been completed.
 d) To download to all Temperature Controllers, use the same configuration as when the data was uploaded. Downloading is not possible in the fol-

lowing circumstances. “Down” will not be displayed when download is not possible.

- When a E5ZN has been added or deleted since the upload.
- When the same number of units are connected as when the upload was executed, but when the unit numbers are different.
- When the platinum resistance thermometer/thermocouple type configuration is different.

6-5-2 Copying Parameters from Master to Slaves

This section describes how to copy parameters from a Master to Slaves, as shown in the following diagram, in which unit number 1 is the Master, and unit numbers 2 and 3 are the Slaves.

System Configuration

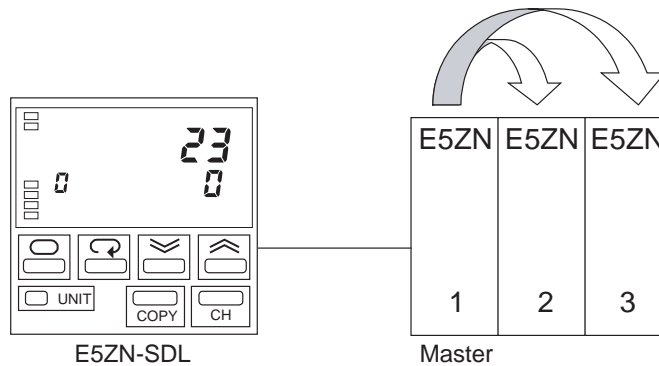

Data uploaded to the E5ZN-SDL can be downloaded only to a Unit whose unit number has been uploaded. Therefore, after copying the Master parameters, change the unit number of the Unit where the data is to be downloaded to the uploaded unit number (Master’s unit number), and then download the parameter data.

1,2,3...

1. Press the **COPY** Key for at least one second to move to copy mode.

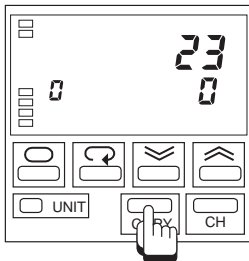

2. Press the **UNIT** Key to select the unit number of the Master. In this example, the Master is unit number 1, so select “1.”

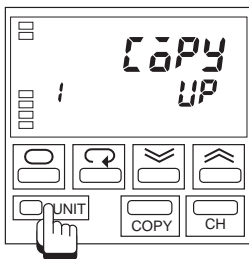

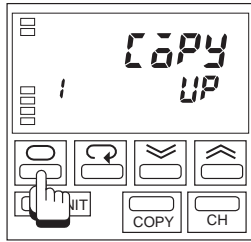

- Upload all the parameters from the Master.
 In this example, all the parameters from unit number 1 will be uploaded to the E5ZN-SDL.
 Press the **Level** Key for at least one second to start the upload.
 "UP" will flash on the display during the upload. The mode will return automatically to operating mode when the upload has been completed.

- The unit number of the Unit to which the data is to be downloaded will change to the uploaded unit number. When uploading has been completed, turn OFF the power and disconnect the Unit (unit number 1) that has been uploaded from the socket or change the unit number to avoid using the same unit number twice during the download.
 In this example, change the Master unit number from 1 to 5, and change the unit number of the Unit to which the data is to be downloaded from number 2 to number 1. The system configuration will change to the configuration shown in the following diagram.

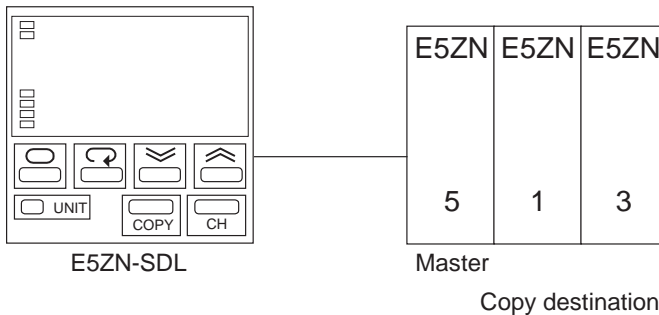

- Turn ON the power and press the **COPY** Key for at least one second to move to copy mode.

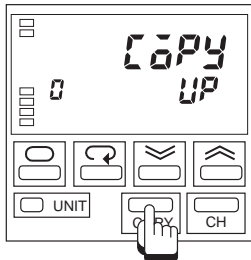

- Use the **Up** and **Down** Keys to select "DOWN" on the No. 2 display. Press the **UNIT** Key to select unit number 1 for the download where data is to be copied to.
 (The lowest unit number that is being uploaded will be displayed in the download unit number display. At initialization, no upload data exists, so the unit number display is blank.)

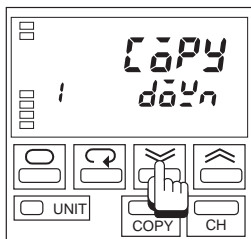

- Press the **Level** Key for at least one second to start the download. "DOWN" will flash on the display during the download. The mode will return automatically to operating mode when the download has been completed.

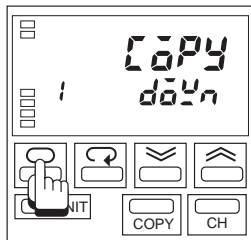

- Repeat steps 4 to 7 to continue copying the data. The following example shows copying data to unit number 3. Turn OFF the power and change unit number 1 back to unit number 2. Change unit number 3, where the data is to be downloaded, to unit number 1. The system configuration is shown in the following diagram. Turn ON the power and follow steps 4 to 7 to copy data to unit number 3.

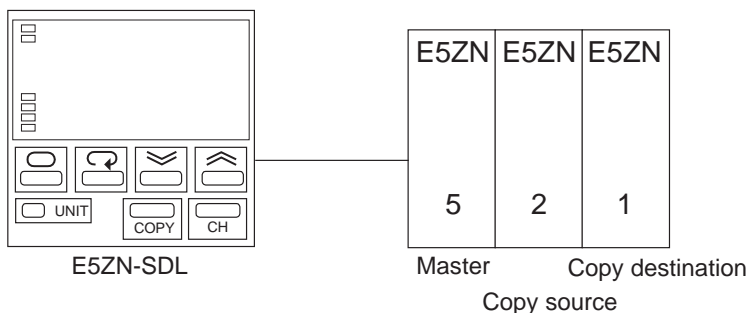

- After copying is completed, turn OFF the power and change the unit numbers. In this example, turn OFF the power and change unit number 5 to unit number 1, and change unit number 1 to unit number 3.

6-6 List of Parameters

The following diagram shows the parameters that can be set from the E5ZN-SDL Setting Display Unit. Some data is not displayed as it is protected or is subject to usage conditions. A password must be entered for access to the advanced function setting level.

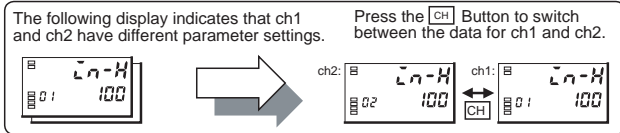

- Note 1.** Indicates parameters that are displayed for pulse output models only.
- Note 2.** Indicates parameters that are displayed for analog output models only.

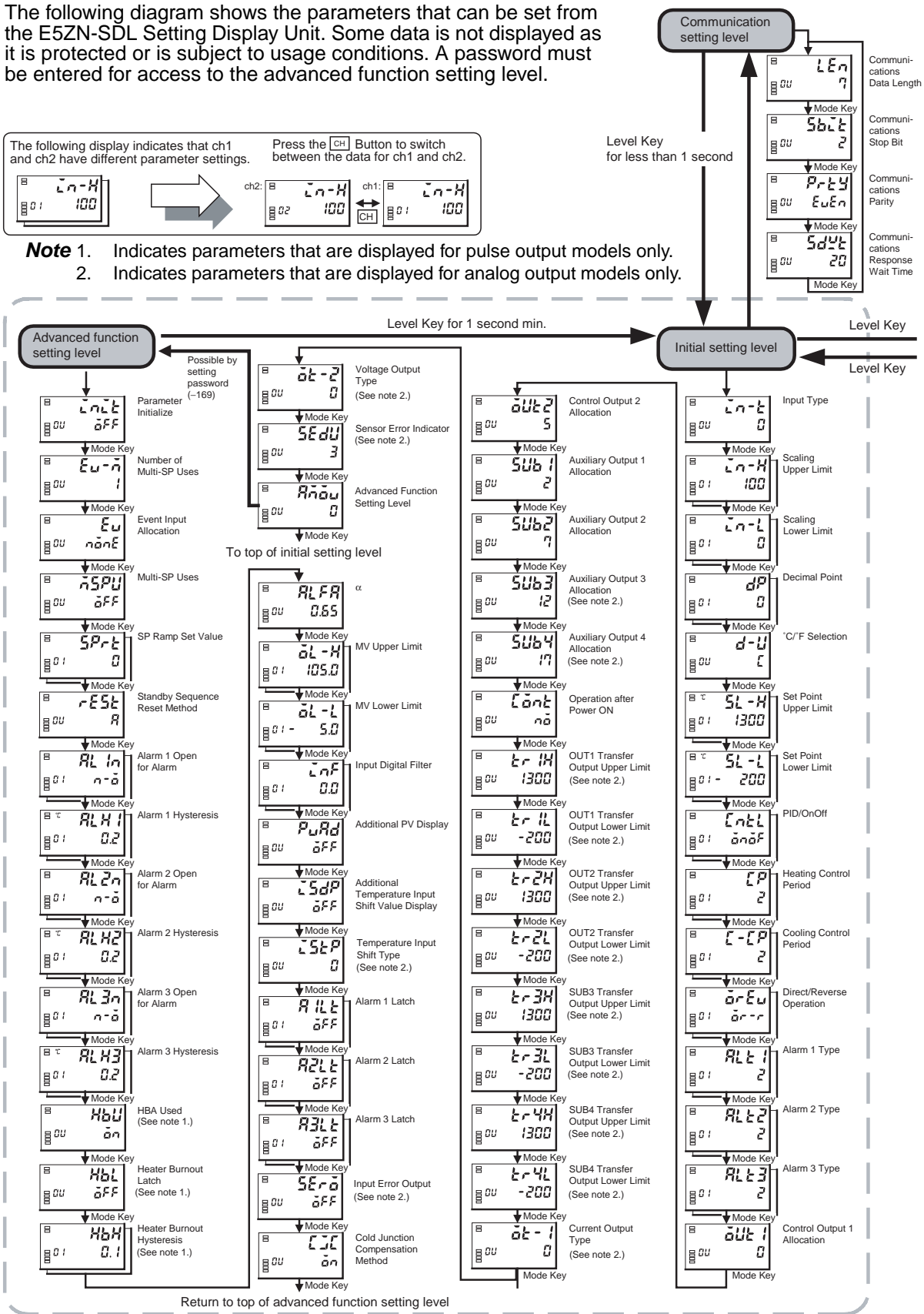

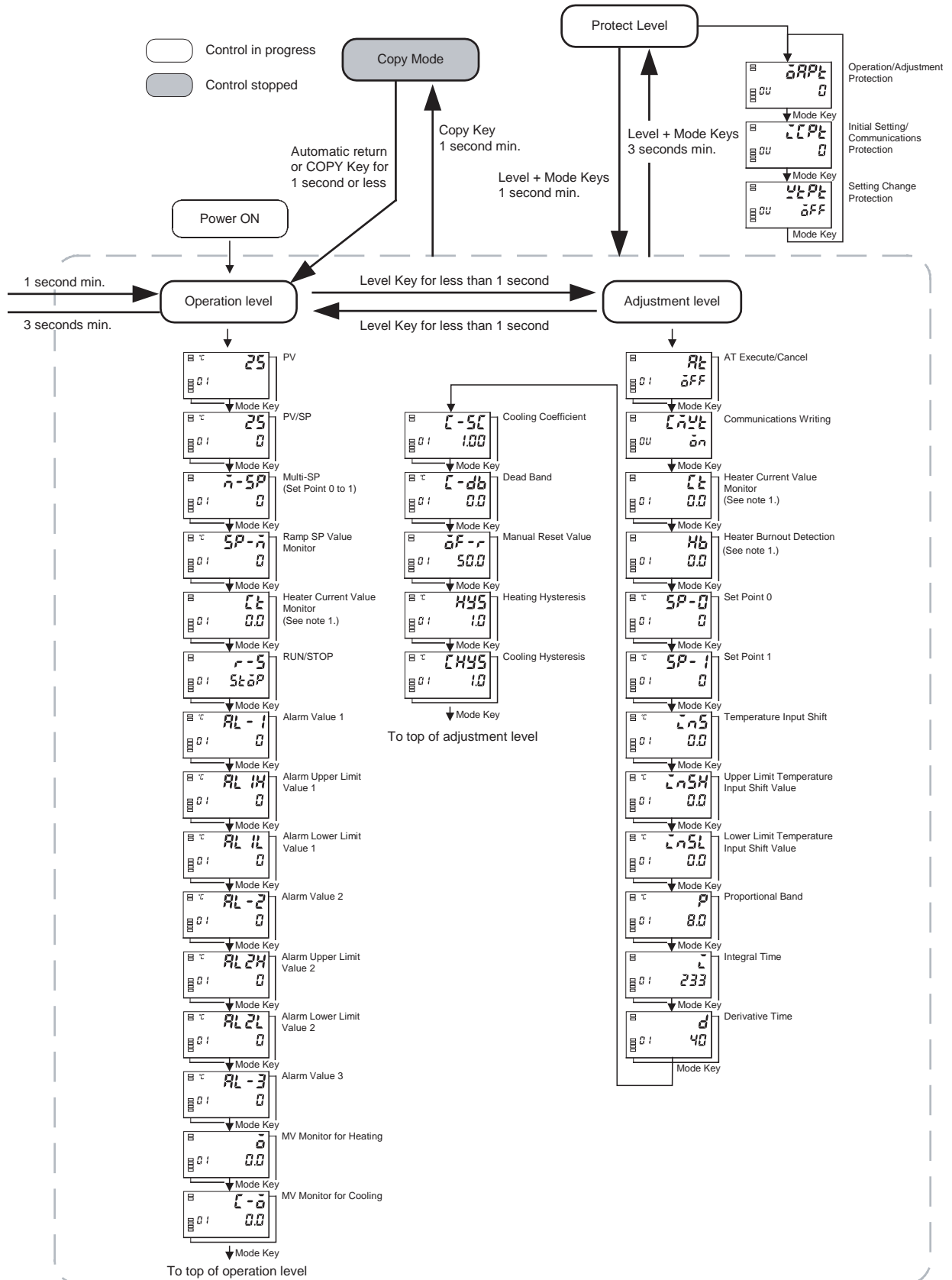

Note Indicates parameters that are displayed for pulse output models only.

SECTION 7

Parameters

7-1	Conventions Used in this Chapter	127
7-2	Protect Level	128
7-2-1	Operation/Adjustment Protection ($\bar{\alpha}RPt$) Initial Setting/ Communications Protection ($\bar{c}LPt$) Setting Change Protection ($\bar{u}tPt$)	128
7-3	Operation Level	129
7-3-1	PV	129
7-3-2	PV/SP	129
7-3-3	Multi-SP (SP 0 to 1) ($\bar{n}-5P$)	130
7-3-4	Ramp SP Value Monitor ($5P-\bar{n}$)	130
7-3-5	Heater Current Value Monitor ($\bar{c}t$)	130
7-3-6	RUN/STOP ($r-5$)	131
7-3-7	Alarm Value 1 ($Rt-1$) Alarm Value 2 ($Rt-2$) Alarm Value 3 ($Rt-3$)	131
7-3-8	Alarm Upper Limit Value 1 ($Rt-H$) Alarm Lower Limit Value 1 ($Rt-L$)	132
7-3-9	Alarm Upper Limit Value 2 ($Rt2H$) Alarm Lower Limit Alarm Value 2 ($Rt2L$)	133
7-3-10	MV Monitor for Heating ($\bar{\alpha}$)	133
7-3-11	MV Monitor for Cooling ($\bar{c}-\bar{\alpha}$)	134
7-4	Adjustment Level	135
7-4-1	AT Execute/Cancel (Rt)	135
7-4-2	Communications Writing ($\bar{c}\bar{n}t$)	135
7-4-3	Heater Current Value Monitor ($\bar{c}t$)	135
7-4-4	Heater Burnout Detection (Hb)	136
7-4-5	SP 0 ($5P-0$) SP 1 ($5P-1$)	137
7-4-6	Temperature Input Shift ($\bar{c}n5$)	137
7-4-7	Upper Limit Temperature Input Shift Value ($\bar{c}n5H$) Lower Limit Temperature Input Shift Value ($\bar{c}n5L$)	138
7-4-8	Proportional Band (P) Integral Time (\bar{c}) Derivative Time (d)	139
7-4-9	Cooling Coefficient ($\bar{c}-5\bar{c}$)	140
7-4-10	Dead Band ($\bar{c}-db$)	141
7-4-11	Manual Reset Value ($\bar{\alpha}F-r$)	141
7-4-12	Heating Hysteresis (HYS) Cooling Hysteresis ($\bar{c}HYS$)	142
7-5	Initial Setting Level	143
7-5-1	Input Type ($\bar{c}n-t$)	143
7-5-2	Scaling Upper Limit ($\bar{c}n-H$) Scaling Lower Limit ($\bar{c}n-L$) Decimal Point (dP)	144
7-5-3	°C/°F Selection ($d-U$)	144
7-5-4	SP Upper Limit ($5L-H$) SP Lower Limit ($5L-L$)	145
7-5-5	PID/OnOff ($\bar{c}ntL$)	145
7-5-6	Heating Control Period ($\bar{c}P$) Cooling Control Period ($\bar{c}-\bar{c}P$)	146
7-5-7	Direct/Reverse Operation ($\bar{\alpha}r-Eu$)	146
7-5-8	Alarm 1 Type ($Rt-t1$) Alarm 2 Type ($Rt-t2$) Alarm 3 Type ($Rt-t3$) .	147
7-5-9	Control Output 1 Allocation ($\bar{\alpha}Ut-t$)	147
7-5-10	Control Output 2 Allocation ($\bar{\alpha}Ut-t2$)	148
7-5-11	Auxiliary Output 1 Allocation ($5Ub-t$)	148
7-5-12	Auxiliary Output 2 Allocation ($5Ubt2$)	149
7-5-13	Auxiliary Output 3 Allocation ($5Ubt3$)	149
7-5-14	Auxiliary Output 4 Allocation ($5Ubt4$)	150
7-5-15	Operation after Power ON ($\bar{c}\bar{\alpha}nt$)	150

7-5-16	Transfer Output Upper Limit (E _{r1H})/(E _{r2H})/(E _{r3H})/(E _{r4H}) Transfer Output Lower Limit (E _{r1L})/(E _{r2L})/(E _{r3L})/(E _{r4L})	151
7-5-17	Current Output Type (o _{t-1}) Voltage Output Type (o _{t-2})	152
7-5-18	Sensor Error Indicator Used (SE _{dI})	153
7-6	Advanced Function Setting Level	154
7-6-1	Parameter Initialize (i _{nc})	154
7-6-2	Number of Multi-SP Uses (E _{u-n})	154
7-6-3	Event Input Allocation (E _u)	154
7-6-4	Multi-SP Uses (n _{SPU})	155
7-6-5	SP Ramp Set Value (SP _{r-t})	155
7-6-6	Standby Sequence Reset Method (r _{ES})	156
7-6-7	Alarm 1 Open in Alarm (AL _{1n}) Alarm 2 Open in Alarm (AL _{2n}) Alarm 3 Open in Alarm (AL _{3n})	157
7-6-8	Alarm 1 Hysteresis (AL _{1H}) Alarm 2 Hysteresis (AL _{2H}) Alarm 3 Hysteresis (AL _{3H})	158
7-6-9	HBA Used (H _{bU})	159
7-6-10	Heater Burnout Latch (H _{bL})	159
7-6-11	Heater Burnout Hysteresis (H _{bH})	159
7-6-12	α (AL _{FR})	160
7-6-13	MV Upper Limit (o _{L-H}) MV Lower Limit (o _{L-L})	160
7-6-14	Input Digital Filter (i _{nf})	161
7-6-15	Additional PV Display (P _{uAd})	162
7-6-16	Additional Temperature Input Shift Value Display (i _{SDP})	162
7-6-17	Temperature Input Shift Type (i _{STP})	162
7-6-18	Alarm 1 Latch (AL _{1L}) Alarm 2 Latch (AL _{2L}) Alarm 3 Latch (AL _{3L})	163
7-6-19	Input Error Output (SE _{r-o})	164
7-6-20	Cold Junction Compensation Method (i _{CC})	164
7-7	Communications Setting Level	166
7-7-1	Communications Data Length (L _{En})	166
7-7-2	Communications Stop Bit (S _b)	166
7-7-3	Communications Parity (P _{rty})	166
7-7-4	Communications Response Wait Time (S _{dWT})	167

7-1 Conventions Used in this Chapter

Headings

Function	Describes the functions of the parameter.
Communications	Describes the variable type and address specified in communications commands.
Settings	Describes the setting range and defaults of the parameter.
Monitoring	Describes the monitor values.
Example of Use	Describes procedures for the E5ZN-SDL Setting Display Unit.
See Also	Describes related parameters and items.

Display Conditions for Related Parameters

The parameters are displayed in the display section of the E5ZN-SDL Setting Display Unit only when the condition for use shown at the top of the section describing the parameter are met. Protected parameters are not be displayed regardless, although the parameters themselves will be enabled.

Order for Parameter Display

The parameters are displayed by level.

7-2 Protect Level

7-2-1 Operation/Adjustment Protection (OPPL) Initial Setting/Communications Protection (ICPL) Setting Change Protection (ULPL)

Function These parameters specify the range of parameters to be protected. The shaded areas indicate the defaults.

Settings

Operation/Adjustment Protection

The following table shows the relationship between set values and the range of protection.

Level		Set value			
		0	1	2	3
Operation level	PV	○	○	○	○
	PV/SP	◆	◆	◆	○
	Other	◆	◆	×	×
Adjustment level		◆	×	×	×

◆: Can be displayed and changed

○: Can be displayed

×: Cannot be displayed and move to other levels not possible

Parameter items are not protected when the set value is set to 0.

Initial Setting/Communications Protection

Moving to the “initial setting level,” “communications setting level” and “advanced function setting level” can be prohibited.

Set value	Initial setting level	Communications setting level	Advanced function setting level
0	○	○	○
1	○	○	×
2	×	×	×

○: Moving to other levels possible

×: Moving to other levels not possible

Setting Change Protection

Changes to setups by key operation can be prohibited.

Set value	Description
OFF	Setup can be changed by key operation.
ON	Setup cannot be changed by key operation. (The protect level can be changed.)

Communications

Setting	Variable type	Address
Operation/adjustment protection	C1	0000 or 0100
Initial setting/communications protection	C1	0001 or 0101
Setting change protection	C1	0002 or 0102

7-3 Operation Level

7-3-1 PV

Condition: The “additional PV display” parameter must be set to ON.

Function

The PV is displayed on the No.1 display, and nothing is displayed (blank) on the No. 2 display.

Communications

ch	Variable type	Address
1	C0	0000
2	C0	0100

Monitoring

	Monitoring range	Unit
PV	Input range lower limit –10% FS to input range upper limit +10%FS Scaling lower limit –10% FS to scaling upper limit +10%FS	EU

The decimal point position is dependent on the selected sensor.

See Also

- Related Parameters
 “Input type” (page 143)
 “SP upper limit” “SP lower limit” (page 145)

7-3-2 PV/SP

Function

The PV is displayed on the No.1 display, and the SP is displayed on the No. 2 display.

	Monitoring range	Unit
PV	Input range lower limit –10%FS to input range upper limit +10%FS Scaling lower limit –10%FS to scaling upper limit +10%FS	EU

	Monitoring range	Unit
SP	SP lower limit to SP upper limit	EU

Communications

Monitor value/parameter	ch	Variable type	Address
PV	1	C0	0000
	2	C0	0100
SP	1	C1	0003
	2	C1	0103

See Also

Refer to the PV parameter.

7-3-3 Multi-SP (SP 0 to 1) (\bar{n} -SP)

Condition: The “multi-SP uses” parameter must be set to ON.

Function

Multi-SP allows you to set up to two SPs (SP0 to 1) in the adjustment level. These can be switched between by operating the keys on the front panel or by external input signals (event input allocation).

In the parameter, enter SPs 0 to 1. Default is 0.

Communications

Use the multi-SP operation commands. Refer to page 81 for information.

See Also

- If multi-SP cannot be selected using the event input, set the “No. of multi-SP uses” parameter to 0 and the “multi-SP uses” parameter to ON. This will enable SP selection.
- SP can be selected using the communications function also.

7-3-4 Ramp SP Value Monitor ($SP-\bar{n}$)

Condition: The “SP ramp set value” parameter must not be set to 0.

Function

This parameter monitors the SP while the ramp function is being used. The ramp function restricts the rate of change in the width of the SP. The set value is displayed when “SP ramp set value” parameter is set. When the SP is out of the preset ramp, the SP is matched to the SP set in the “PV/SP” parameter.

Communications

ch	Variable type	Address
1	C0	0002
2	C0	0102

Monitoring

Monitoring range	Unit
SP: SP lower limit to SP upper limit	EU

See Also

- Related Parameters
 “PV/SP” (operation level) (page 129)
 “SP ramp set value” (advanced function setting level) (page 155)
 “SP upper limit” “SP lower limit” (initial setting level) (page 145)

7-3-5 Heater Current Value Monitor (I_t)

Condition: Pulse output models only, and the “HBA used” parameter must be set to “ON.”

This parameter measures the heater current value from the CT input used for detecting heater burnout.

Function

Measures and displays the heater current value.

Communications

ch	Variable type	Address
1	C0	0003
2	C0	0103

Monitoring

Monitoring range	Unit
00000000H to 00000226 H (0.0 to 55.0)	A

When the current exceeds 55.0A in the E5ZN-SDL Setting Display Unit, “FFFF” is displayed.

See Also

- Related Parameters
 “Heater burnout detection” (adjustment level) (page 136)
 “Heater burnout use” (advanced function setting level) (page 159)

7-3-6 RUN/STOP (r-5)

Condition: The RUN/STOP function must not be set for the event input.

Function

This parameter starts and stops operation.
 Default is “STOP”

Communications

Use the “RUN/STOP” operation command. Refer to page 80 for information.

Example of Use

When *rUn* is selected, control is executed. When *StōP* is selected, control is stopped. When control is stopped, the STOP indicator will be lit.

- This parameter is not displayed when the RUN/STOP function is set to the event input.

See Also

- Related Parameters
 “Event input allocation” (advanced function setting level) (page 154)

**7-3-7 Alarm Value 1 (AL-1)
 Alarm Value 2 (AL-2)
 Alarm Value 3 (AL-3)**

Condition: The alarm type must not be set to no alarm or upper and lower limit alarm (alarms 1 and 2 only).

These parameters set the input value “X” in the alarm.

Function

- These parameters are used to set the alarm values for alarm outputs 1 to 3.
- During temperature input, the decimal point position is dependent on the currently selected sensor, and during analog input it is dependent on the “decimal point” parameter setting.

Communications

Setting	ch	Variable type	Address
Alarm value 1	1	C1	0004
	2	C1	0104
Alarm value 2	1	C1	0007
	2	C1	0107
Alarm value 3	1	C1	000A
	2	C1	010A

Settings

Setting range	Unit	Default
FFFFFF831H to 00000270FH (-1999 to 9999)	EU	0

The alarm type must be set to other than no alarm or upper and lower limit alarm (alarms 1 and 2 only).

See Also

- Related Parameters
 - “Input type” (initial setting level) (page 143)
 - “Scaling upper limit” “Scaling lower limit” “Decimal point” (initial setting level) (page 144)
 - “Alarm 1 type” “Alarm 2 type” “Alarm 3 type” (initial setting level) (page 147)
 - “Alarm 1 open in alarm” “Alarm 2 open in alarm” “Alarm 3 open in alarm” (advanced function setting level) (page 157)
 - “Alarm 1 hysteresis” “Alarm 2 hysteresis” “Alarm 3 hysteresis” (advanced function setting level) (page 158)
 - “Standby sequence reset method” (advanced function setting level) (page 156)

**7-3-8 Alarm Upper Limit Value 1 (AL IH)
Alarm Lower Limit Value 1 (AL IL)**

Condition: Alarm 1 type must be set to upper and lower limits, upper and lower limit range, or upper and lower limit with standby sequence.

These parameters independently set the upper and lower limit alarm values when the mode for setting the upper and lower limits is selected for alarm 1 type.

Function

- These parameters set the upper and lower limits of alarm 1.
- During temperature input, the decimal point position is dependent on the currently selected sensor, and during analog input it is dependent on the “decimal point” parameter setting.

Communications

Setting	ch	Variable type	Address
Alarm upper limit value 1	1	C1	0005
	2	C1	0105
Alarm lower limit alarm value 1	1	C1	0006
	2	C1	0106

Settings

Setting range	Unit	Default
FFFFFF831H to 00000270FH (-1999 to 9999)	EU	0

See Also

- Related Parameters
 - “Alarm 1 type” (initial setting level) (page 147)
 - “Standby sequence reset method” (advanced function setting level) (page 156)
 - “Alarm 1 open in alarm” (advanced function setting level) (page 157)
 - “Alarm 1 hysteresis” (advanced function setting level) (page 158)

7-3-9 Alarm Upper Limit Value 2 (AL2H) Alarm Lower Limit Alarm Value 2 (AL2L)

Condition: Alarm 2 type must be set to upper and lower limits, upper and lower limit range, or upper and lower limit alarm with standby sequence.

These parameters independently set the upper and lower limit alarm values when the mode for setting the upper and lower limits is selected for alarm 2 type.

Function

- These parameters set the upper and lower limits of alarm 2.
- The decimal point position is dependent on the currently selected sensor. For analog input, it is dependent on the “decimal point position” setting.

Communications

Setting	ch	Variable type	Address
Alarm upper limit value 2	1	C1	0008
	2	C1	0108
Alarm lower limit value 2	1	C1	0009
	2	C1	0109

Settings

Setting range	Unit	Default
FFFFF831H to 00000270FH (-1999 to 9999)	EU	0

See Also

- Related Parameters
 “Input type” “Alarm 2 type” (initial setting level) (page 147)
 “Standby sequence reset method” (advanced function setting level) (page 156)
 “Alarm 2 open in alarm” (advanced function setting level) (page 157)
 “Alarm 2 hysteresis” (advanced function setting level) (page 158)

7-3-10 MV Monitor for Heating (̄)

Function

During standard control, the MV is monitored, and during heating/cooling control, the MV on the heating side is monitored.

Communications

ch	Variable type	Address
1	C0	0004
2	C0	0104

Monitoring

Control	Monitoring range	Unit
Standard	FFFFFCEH to 0000041AH (-5.0 to 105.0)	%
Heating and cooling	00000000H to 0000041AH (0.0 to 105.0)	%

7-3-11 MV Monitor for Cooling ([-̄])

The control must be heating and cooling control.

This parameter is for monitoring the MV on the cooling side during operation.

Function

During heating and cooling control, the MV on the cooling side is monitored.

Communications

ch	Variable type	Address
1	C0	0005
2	C0	0105

Monitoring

Control	Monitoring range	Unit
Heating and cooling	00000000H to 0000041AH (0.0 to 105.0)	%

See Also

- Related Parameters
 “Control output 1 allocation,” “Control output 2 allocation” (initial setting level) (page 147) “Auxiliary output 1 allocation,” “Auxiliary output 2 allocation” (initial setting level) (page 148)

7-4 Adjustment Level

7-4-1 AT Execute/Cancel (\overline{AT})

Condition: Operation in automatic mode with 2-PID control.

This parameter executes autotuning.

Function

When you execute AT, the optimum PID parameters “proportional band,” “integral time,” and “derivative time” for the SP during program execution are automatically set by changing the MV to calculate the characteristics of the control target.

Communications

Use the “AT execute/cancel” operation command. Refer to page 81 for information.

Example of Use

- Normally, this parameter is set to “ \overline{OFF} ”. When you press the Up Key, the parameter is turned ON and AT is executed. AT cannot be executed when control has stopped or during ON/OFF control.
- When AT execution ends, the parameter setting automatically returns to “ \overline{OFF} .”
- The SP flashes if “PV/SP” is monitored during AT.
- Channel settings cannot be changed during AT.

See Also

- Related Parameters
 “Proportional band” “Integral time” “Derivative time” (adjustment level) (page 139)
 “PID/OnOff” (initial setting level) (page 145)

7-4-2 Communications Writing (\overline{CWT})

Function

This parameter enables/disables writing of parameters to the E5ZN from the host (e.g., personal computer) by communications.

Communications

Use the “communications writing” operation command. Refer to page 80 for information.

Example of Use

Set this parameter to “ \overline{ON} ” to enable writing and to “ \overline{OFF} ” to disable writing.

See Also

- Related Parameters
 “Communication unit No.” “Baud rate” (setting switch) (page 3)
 “Data bit” “Stop bit” (communications setting level) (page 166) “Parity”
 “Communications response wait time” (communications setting level) (page 167)

7-4-3 Heater Current Value Monitor (\overline{HCV})

Condition: The “HBA used” parameter for pulse output models must be set to “ON”.

This parameter measures the current value of the heater from current transformer (CT) input to detect heater burnout.

Function

This parameter measures and displays the current value of the heater.

Communications

ch	Variable type	Address
1	C0	0003
2	C0	0103

Monitoring

Monitoring range	Unit
00000000H to 00000226 H (0.0 to 55.0)	A

“FFFF” is displayed when 55.0 A is exceeded in the E5ZN-SDL Setting Display Unit.

See Also

- Related Parameters
 “Heater burnout detection” (adjustment level) (page 136)
 “HBA used” (advanced function setting level) (page 159)

7-4-4 Heater Burnout Detection (*H_b*)

Condition: The “HBA used” parameter for pulse output models must be set to “ON”.

This parameter sets the current value for the heater burnout alarm output to become active.

Function

- This parameter outputs the heater burnout alarm when the heater current value falls below this parameter setting.
- When the set value is 0.0, the heater burnout alarm will be OFF. When the set value is 50.0, the heater burnout alarm will be ON.

Communications

ch	Variable type	Address
1	C1	000C
2	C1	010C

Settings

Setting range	Unit	Default
00000000H to 000001F4H (0.0 to 50.0)	A	0.0

See Also

- Related Parameters
 “HBA used” (advanced function setting level) (page 159)
 “Heater current value monitor” (operation or adjustment level) (page 135)
 “Heater burnout latch” (advanced function setting level) (page 159)
 “Heater burnout hysteresis” (advanced function setting level) (page 159)

7-4-5 SP 0 (SP-0) SP 1 (SP-1)

Condition: The “number of multi-SP uses” parameter must be set to either 1 or 2, and the “multi-SP uses” parameter must be set to ON.

These parameters set the SPs when the multi-SP function is used.

Function

The values set in these parameters can be selected.

- When the SP has been changed, the set value of these parameters currently set by multi-SP is linked and changed.
- The decimal point position is dependent on the selected sensor.

During analog input, the decimal point position is dependent on the setting of the “decimal point position” parameter.

Communications

Setting	ch	Variable type	Address
SP 0	1	C1	000D
	2	C1	010D
SP 1	1	C1	000E
	2	C1	010E

Settings

Setting range	Unit	Default
Lower SP limit to upper SP limit	EU	0

See Also

- Related Parameters
 - “Number of multi-SP uses” (advanced function setting level) (page 154)
 - “Event input allocation” “Multi-SP uses” (advanced function setting level) (page 154)
 - “PV/SP” (operation level) (page 129)
 - “Input type” (initial setting level) (page 143)

7-4-6 Temperature Input Shift (Tn5)

Condition: Refer to the following table for details.

Sometimes an error between the SP and the actual temperature occurs. To offset this, a value obtained by adding an input shift value to the input is displayed as the measurement value and used for control.

Conditions of Use

Setting	Temperature input shift value	
	Analog output models E5ZN-2C□F03□-FLK	Pulse output models E5ZN-2Q□H03□-FLK E5ZN-2T□H03□-FLK
Temperature input shift value	ON	ON
Input type	Platinum-resistance thermometer or thermocouple (analog input and infrared temperature sensors not included)	
Temperature input shift type	One-point shift	-

Function

The entire input range is shifted by a fixed rate (one-point shift). If the input shift value is set to -1.0°C , the SP is controlled to a value obtained by subtracting 1.0°C from the actual temperature.

Communications

ch	Variable type	Address
1	C1	000F
2	C1	010F

Settings

Setting range	Unit	Default
FFFFFF831H to 0000270FH (-199.9 to 999.9)	$^{\circ}\text{C}$ or $^{\circ}\text{F}$	0.0

See Also

- Related Parameter
"Input type" (initial setting level) (page 143)

7-4-7 Upper Limit Temperature Input Shift Value ($\bar{L}nSH$) Lower Limit Temperature Input Shift Value ($\bar{L}nSL$)

Condition: Refer to the following table for details.

These parameters allow the input range to be shifted both at the upper and lower limits (two-point shift) (as opposed to the "temperature input shift" parameter, where the entire input range is shifted by a fixed rate (one-point shift)). A two-point shift enables more accurate offset of the input range compared with a one-point shift when the input shift values at the upper and lower limits differ.

Conditions of Use

Setting	Upper limit temperature input shift value/ Lower limit temperature input shift value	
Additional temperature input shift value display	ON	
Input type	Infrared temperature sensor	Platinum-resistance thermometer, thermocouple (See note.)
Temperature input shift type	-	Two-point shift

Note Two-point shift can be used with platinum-resistance thermometers and thermocouples for upgraded pulse output models and analog output models only.

Function

This parameter sets input shift values for each of the upper and lower limits (two-point shift) of the input range.

Communications

Setting	ch	Variable type	Address
Upper limit temperature input shift value	1	C1	0010
	2	C1	0110
Lower limit temperature input shift value	1	C1	0011
	2	C1	0111

Settings

Setting range	Unit	Default
FFFFFF831H to 0000270FH (-199.9 to 999.9)	°C or °F	0.0

See Also

Related Parameter
 “Input type” (initial setting level) (page 143)

7-4-8 Proportional Band (P) Integral Time (I) Derivative Time (D)

Condition: The control must be 2-PID control.

These parameters set the PID constants for control. The PID can be automatically set by executing autotuning.

Function

Proportional action: P refers to control in which the MV is proportional to the deviation.

Integral action: I gives a control action that is proportional to the time integral of the control error. With proportional control, there is normally an offset (control error). So, proportional action is used in combination with integral action. As time passes, this control error disappears, and the SP comes to agree with the control temperature (PV).

Derivative action: D gives a control action that is proportional to the time derivative of the control error. As proportional control and integral control correct for errors in the control result, the control system will be late in responding to sudden changes in temperature. Derivative action enables control that is proportional to a predicted process output to correct for future error.

Communications

Setting	ch	Variable type	Address
Proportional band	1	C1	0012
	2	C1	0112
Integral time	1	C1	0013
	2	C1	0113
Derivative time	1	C1	0014
	2	C1	0114

Settings

Setting	Setting range	Unit	Default
Proportional band	00000001H to 0000270FH (0.1 to 999.9)	EU	8.0
Integral time	00000000H to 00000F9FH (0 to 3999)	Second	233
Derivative time	00000000H to 00000F9FH (0 to 3999)	Second	40

See Also

- Related Parameters
 “AT execute/cancel” (adjustment level) (page 135)
 “PID/OnOff” (initial setting level) (page 145)

7-4-9 Cooling Coefficient (C-5C)

Condition: The control must be either heating and cooling control or 2-PID control.

If the heating and cooling characteristics of the control target differ enough to prevent satisfactory control characteristics from being obtained by the same PID parameters, adjust the proportional band (P) on the cooling side by adding the cooling coefficient to control cooling.

Function

In heating and cooling control, cooling side P is calculated by the following formula to set the cooling coefficient:

$$\text{Cooling side P} = \text{Cooling coefficient} \times \text{P (proportional operation)}$$

Communications

ch	Variable type	Address
1	C1	0015
2	C1	0115

Settings

Setting range	Unit	Default
00000001H to 0000270FH (0.01 to 99.99)	None	1.00

See Also

- Related Parameter
"Proportional band" (adjustment level) (page 139)

7-4-10 Dead Band ($\bar{C}-db$)

Condition: The control system must be heating and cooling control.

This parameter sets the output dead band width in a heating and cooling control system. A negative setting sets an overlap band.

Function

This parameter sets an area in which the control output is 0 centering around the SP in a heating and cooling control system.

Communications

ch	Variable type	Address
1	C1	0016
2	C1	0116

Settings

Setting range	Unit	Default
FFFFFF831H to 0000270FH (-199.9 to 999.9)	EU	0.0

7-4-11 Manual Reset Value ($\bar{O}F-r$)

Condition: The control must be standard control or 2-PID control. The “integral time” parameter must be set to 0.

Function

This parameter sets the required manipulated variable to remove offset during stabilization of P or PD control.

Communications

ch	Variable type	Address
1	C1	0017
2	C1	0117

Settings

Monitoring range	Unit	Default
00000000H to 000003E8H (0.0 to 100.0)	%	50.0

See Also

- Related Parameters
 - “PID/OnOff” (initial setting level) (page 145)
 - “Integral time” (adjustment level) (page 139)

7-4-12 Heating Hysteresis (*HYS*) Cooling Hysteresis (*CHYS*)

Condition: The control must be ON/OFF control.

These parameters set the hysteresis for ensuring stable operation at ON/OFF switching.

Function

- In a standard control, use the “heating hysteresis” parameter. The “cooling hysteresis” parameter cannot be used.
- In a heating and cooling control, the hysteresis can be set independently for heating and cooling. Use the “heating hysteresis” parameter to set the heating side hysteresis, and use the “cooling hysteresis” parameter to set the cooling side hysteresis.

Communications

Setting	ch	Variable type	Address
heating hysteresis	1	C1	0018
	2	C1	0118
Cooling hysteresis	1	C1	0019
	2	C1	0119

Settings

Setting range	Unit	Default
00000001H to 0000270FH (0.1 to 999.9)	EU	1.0

See Also

- Related Parameter
“PID/OnOff” (initial setting level) (page 145)

7-5 Initial Setting Level

7-5-1 Input Type (Ln-t)

Function

- This parameter sets the sensor type using a corresponding code.
- When this parameter is changed, the SP limiter is changed to the default. If the SP limits must be changed, set the “SP upper limit” and “SP lower limit” parameters.

Communications

ch	Variable type	Address
Shared	C3	0000 or 0100

Settings

Set the code according to the following table. Shaded ranges indicate default settings.

Sensor	Input type	Name	Set value	Input temperature range	
Platinum resistance thermometer	Platinum resistance thermometer	Pt100	00000000H (0)	-200 to 850 (°C) to -300 to 1,500 (°F)	
			00000001H (1)	-199.9 to 500.0 (°C) to -199.9 to 900.0 (°F)	
			00000002H (2)	0.0 to 100.0 (°C) to 0.0 to 210.0 (°F)	
		JPt100	00000003H (3)	-199.9 to 500.0 (°C) to -199.9 to 900.0 (°F)	
00000004H (4)	0.0 to 100.0 (°C) to 0.0 to 210.0 (°F)				
Thermocouple input type	Thermocouple	K	00000000H (0)	-200 to 1,300 (°C) to -300 to 2,300 (°F)	
			00000001H (1)	-20.0 to 500.0 (°C) to 0.0 to 900.0 (°F)	
		J	00000002H (2)	-100 to 850 (°C) to -100 to 1,500 (°F)	
			00000003H (3)	-20.0 to 400.0 (°C) to 0.0 to 750.0 (°F)	
		T	00000004H (4)	-200 to 400 (°C) to -300 to 700 (°F)	
			00000011H (17)	-199.9 to 400.0 (°C) to -199.9 to 700.0 (°F)	
		E	00000005H (5)	0 to 600 (°C) to 0 to 1100 (°F)	
		L	00000006H (6)	-100 to 850 (°C) to -100 to 1,500 (°F)	
		U	00000007H (7)	-200 to 400 (°C) to -300 to 700 (°F)	
			00000012H (18)	-199.9 to 400.0 (°C) to -199.9 to 700.0 (°F)	
		N	00000008H (8)	-200 to 1,300 (°C) to -300 to 2,300 (°F)	
		R	00000009H (9)	0 to 1,700 (°C) to 0 to 3,000 (°F)	
	S	0000000AH (10)	0 to 1,700 (°C) to 0 to 3,000 (°F)		
	B	0000000BH (11)	100 to 1,800 (°C) to 300 to 3,200 (°F)		
	Infrared temperature sensor ES1A	Infrared temperature sensor ES1A	K10 to 70°C	0000000CH (12)	0 to 90 (°C) to 0 to 190 (°F)
			K60 to 120°C	0000000DH (13)	0 to 120 (°C) to 0 to 240 (°F)
K115 to 165°C			0000000EH (14)	0 to 165 (°C) to 0 to 320 (°F)	
K160 to 260°C			0000000FH (15)	0 to 260 (°C) to 0 to 500 (°F)	
Analog input	0 to 50 mV	00000010H (16)	One of following ranges depending on the results of scaling: -1,999 to 9,999 or -199.9 to 999.9,		

See Also

- Related Parameters
“°C/°F selection” (initial setting level) (page 144) “SP upper limit” “SP lower limit” (initial setting level) (page 145)

7-5-2 Scaling Upper Limit (\bar{L}_n-H) Scaling Lower Limit (\bar{L}_n-L) Decimal Point (d^P)

Condition: The input type must be set to analog input.

Function

- These parameters can be used when a voltage input is selected as the input type.
- When a voltage input is selected as the input type, scaling is performed. Set the upper limit in the “scaling upper limit” parameter and the lower limit in the “scaling lower limit” parameter.
- The “decimal point” parameter specifies the decimal point position of parameters (e.g., SP) whose unit is set to EU.

Communications

Setting	ch	Variable type	Address
Scaling upper limit	1	C3	0001
	2	C3	0101
Scaling lower limit	1	C3	0002
	2	C3	0102
Decimal point position	1	C3	0003
	2	C3	0103

Settings

Setting	Settings range	Unit	Default
Scaling upper limit	Scaling lower limit +1 to 00000270FH (Scaling lower limit +1 to 9,999)	-	100
Scaling lower limit	FFFFFF831H to scaling upper limit -1 (-1999 to scaling upper limit -1)	-	0
Decimal point position	00000000H to 00000001H (0 to 1)	-	0

See Also

- Related Parameter
“Input type” (initial setting level) (page 143)

7-5-3 °C/°F Selection ($d-U$)

Condition: The input type must be set to temperature input.

Function

- Set the temperature input unit to either °C or °F.
- The temperature input unit must be the same for both ch1 and ch2.

Communications

ch	Variable type	Address
Shared	C3	0004 or 0104

Settings

Setting range	Unit	Default
00000000H to 00000001H 0: °C (E) 1: °F (F)	-	0: °C

See Also

- Related Parameter
“Input type” (initial setting level) (page 143)

7-5-4 SP Upper Limit ($SL-H$) SP Lower Limit ($SL-L$)

Function

- These parameters set the upper and lower limits for the SP setting. The SP can be set within the range defined by the upper and lower limit set values in the “SP upper limit” and “SP lower limit” parameters. If existing SP settings are out of the range, they will be changed to either the upper or lower limits (which-ever is closest).
- When the temperature input type and temperature unit are changed, the SP upper limit and SP lower limit will be changed to the upper and lower limits of the sensor.
- During temperature input, the decimal point position is dependent on the currently selected sensor. During analog input, it is dependent on the “decimal point” parameter setting.

Communications

Setting	ch	Variable type	Address
SP upper limit	1	C3	0005
	2	C3	0105
SP lower limit	1	C3	0006
	2	C3	0106

Settings

Setting	Settings range	Unit	Default
SP upper limit	Temperature: SP lower limit +1 to sensor range upper limit	Depends on °C/°F selection	Input range upper limit
	Analog: SP lower limit + 1 to scaling upper limit	EU	Scaling upper limit
SP lower limit	Temperature: Sensor range lower limit to SP upper limit –1	Depends on °C/°F selection	Input range lower limit
	Analog: Scaling lower limit to SP upper limit – 1	EU	Scaling lower limit

See Also

- Related Parameters
“Input type” (initial setting level) (page 143) “°C/°F selection” (initial setting level) (page 144)

7-5-5 PID/OnOff ($ENTL$)

Function

- This parameter selects 2-PID control or ON/OFF control as the control system.
- The AT tuning function can be used in 2-PID control.

Communications

ch	Variable type	Address
1	C3	0007
2	C3	0107

Settings

Settings range	Unit	Default
00000000H to 00000001H 0: ON/OFF ($\bar{o}n\bar{o}f$) 1: 2-PID ($P\bar{c}d$)	-	1: 2-PID

See Also

- Related Parameters
“Manual reset” “Heating hysteresis” “Cooling hysteresis” (adjustment level) (page 141)

7-5-6 Heating Control Period ($\bar{c}P$) Cooling Control Period ($\bar{c}-\bar{c}P$)

Condition: The control must be set to 2-PID control when the cooling side control period is cooling/heating control.

Function

- These parameters set the control periods. Set the control periods taking the control characteristics and the electrical life expectancy of the relay into consideration.
- In a standard control system, use the “heating control period” parameter.
- In a heating and cooling control system, the control period can be set independently for heating and cooling.

Communications

Setting	ch	Variable type	Address
Heating control period	1	C3	0008
	2	C3	0108
Cooling control period	1	C3	0009
	2	C3	0109

Settings

Setting	Settings range	Unit	Default
Heating control period	00000001H to 00000063H (1 to 99)	Second	2
Cooling control period	00000001H to 00000063H (1 to 99)	Second	2

See Also

- Related Parameter
“PID/OnOff” (initial setting level) (page 145)

7-5-7 Direct/Reverse Operation ($\bar{o}r\bar{E}u$)

Function

Direct operation increases the MV when the PV increases. Alternatively, reverse operation increases the manipulated variable when the PV decreases.

Communications

ch	Variable type	Address
1	C3	000A
2	C3	010A

Settings

Settings range	Unit	Default
00000000H to 00000001H 0: Reverse operation ($\bar{a}r-r$) 1: Direct operation ($\bar{a}r-d$)	-	0: Reverse operation

See Also

3-4 Setting Output Specifications (page 25)

7-5-8 Alarm 1 Type ($AL1$) Alarm 2 Type ($AL2$) Alarm 3 Type ($AL3$)

Function

These parameters select alarm type for alarms 1, 2, or 3

Communications

Setting	ch	Variable type	Address
Alarm 1 type	1	C3	000B
	2	C3	010B
Alarm 2 type	1	C3	000C
	2	C3	010C
Alarm 3 type	1	C3	000D
	2	C3	010D

Settings

Setting	Settings range	Unit	Default
Alarm 1 type Alarm 2 type Alarm 3 type	00000000H (0): No alarm function 00000001H (1): Upper and lower limit alarm 00000002H (2): Upper limit alarm 00000003H (3): Lower limit alarm 00000004H (4): Upper and lower limit range alarm 00000005H (5): Upper and lower limit alarm with standby sequence 00000006H (6): Upper limit alarm with standby sequence 00000007H (7): Lower limit alarm with standby sequence 00000008H (8): Absolute value upper limit alarm 00000009H (9): Absolute value lower limit alarm 0000000AH (10): Absolute value upper limit alarm with standby sequence 0000000BH (11): Absolute value lower limit alarm with standby sequence	-	2: Upper limit alarm

See Also

- Related Parameters
 - “Alarm 1 to 3 value” (operation level) (page 131)
 - “Upper limit alarm value 1” “Lower limit alarm value 1” (operation level) (page 132) “Upper limit alarm value 2” “Lower limit alarm value 2” (operation level) (page 133)
 - “Standby sequence reset” (advanced function setting level) (page 156)
 - “Alarm 1 to 3 open in alarm” (advanced function setting level) (page 157)
 - “Alarm 1 to 3 hysteresis” (advanced function setting level) (page 158)
 - “Alarm 1 to 3 latch” (advanced function setting level) (page 163)

7-5-9 Control Output 1 Allocation ($OUT1$)

Function

This function assigns the data to be output to the control output 1 terminals (terminals 7 and 8.)

Communications

ch	Variable type	Address
Shared	C3	000E or 010E

Settings

	Settings range				Default
	Analog output models E5ZN-2C□F03□-FLK		Pulse output models E5ZN-2Q□H03□-FLK E5ZN-2T□H03□-FLK		
00000000H (0)	ch1	Heating control output	ch1	Heating control output	0: Heating control output for ch1
00000001H (1)		Cooling control output		Cooling control output	
00000002H (2)		Alarm 1 and sensor error alarm OR output		Alarm 1 and HB alarm OR output	
00000003H (3)		Alarm 2 output		Alarm 2 output	
00000004H (4)		Alarm 3 output		Alarm 3 output	
00000005H (5)	ch2	Heating control output	ch2	Heating control output	
00000006H (6)		Cooling control output		Cooling control output	
00000007H (7)		Alarm 1 and sensor error alarm OR output		Alarm 1 and HB alarm OR output	
00000008H (8)		Alarm 2 output		Alarm 2 output	
00000009H (9)		Alarm 3 output		Alarm 3 output	
0000000AH (10)	ch1	SP transfer output	/		
0000000BH (11)		Ramp SP transfer output			
0000000CH (12)		PV transfer output			
0000000DH (13)		Heating MV transfer output			
0000000EH (14)		Cooling MV transfer output			
0000000FH (15)	ch2	SP transfer output			
00000010H (16)		Ramp SP transfer output			
00000011H (17)		PV transfer output			
00000012H (18)		Heating MV transfer output			
00000013H (19)		Cooling MV transfer output			

7-5-10 Control Output 2 Allocation (Output 2)

Function

This parameter allocates the data to be output to the control output 2 terminals (terminals 1 and 2.)

Communications

ch	Variable type	Address
Shared	C3	000F or 010F

Settings

Settings range	Unit	Default
Refer to the table of setting ranges for control output 1 allocation.	-	5: ch2 heating control output

7-5-11 Auxiliary Output 1 Allocation (Sub 1)

Function

This parameter allocates the data to be output to the auxiliary output 1 terminals (terminals 13 and 15.)

Communications

ch	Variable type	Address
Shared	C3	0010 or 0110

Settings

	Settings range				Default	
	Analog output models E5ZN-2C□F03□-FLK		Pulse output models E5ZN-2Q□H03□-FLK E5ZN-2T□H03□-FLK			
00000000H (0)	ch1	Heating control output	ch1	Heating control output	Analog output models: 2: Alarm 1 and sensor error alarm OR output for ch1	
00000001H (1)		Cooling control output		Cooling control output		
00000002H (2)		Alarm 1 and sensor error alarm OR output		Alarm 1 and HB alarm OR output		
00000003H (3)		Alarm 2 output		Alarm 2 output		
00000004H (4)	Alarm 3 output	Alarm 3 output				
00000005H (5)	ch2	Heating control output	ch2	Heating control output		Pulse output models: 2: Alarm 1 and HB alarm OR output for ch1
00000006H (6)		Cooling control output		Cooling control output		
00000007H (7)		Alarm 1 and sensor error alarm OR output		Alarm 1 and HB alarm OR output		
00000008H (8)		Alarm 2 output		Alarm 2 output		
00000009H (9)		Alarm 3 output		Alarm 3 output		

7-5-12 Auxiliary Output 2 Allocation (*Sub2*)

Function

This parameter allocates the data to be output to the auxiliary output 2 terminals (terminals 14 and 15.)

Communications

ch	Variable type	Address
Shared	C3	0011 or 0111

Settings

Setting range	Default
Refer to the table of setting ranges for auxiliary output 1 allocation.	Analog output models: 7: Alarm 1 and sensor error alarm OR output for ch2 Pulse output models: 7: Alarm 1 and HB alarm OR output for ch2

7-5-13 Auxiliary Output 3 Allocation (*Sub3*)

Condition: Analog output models only

Function

This parameter allocates the data to be output to the auxiliary output 3 terminals (terminals 16 and 17.)

Communications

ch	Variable type	Address
Shared	C3	002F or 012F

Settings

	Settings range		Default
00000000H (0)	ch1	Heating control output	12: PV transfer output for ch1
00000001H (1)		Cooling control output	
00000002H (2)		Alarm 1 and sensor error alarm OR output	
00000003H (3)		Alarm 2 output	
00000004H (4)		Alarm 3 output	
00000005H (5)	ch2	Heating control output	
00000006H (6)		Cooling control output	
00000007H (7)		Alarm 1 and sensor error alarm OR output	
00000008H (8)		Alarm 2 output	
00000009H (9)		Alarm 3 output	
0000000AH (10)	ch1	SP transfer output	
0000000BH (11)		Ramp SP transfer output	
0000000CH (12)		PV transfer output	
0000000DH (13)		Heating MV transfer output	
0000000EH (14)		Cooling MV transfer output	
0000000FH (15)	ch2	SP transfer output	
00000010H (16)		Ramp SP transfer output	
00000011H (17)		PV transfer output	
00000012H (18)		Heating MV transfer output	
00000013H (19)		Cooling MV transfer output	

7-5-14 Auxiliary Output 4 Allocation (*SUB4*)

Condition: Analog output models only

Function

This parameter allocates the data to be output to the auxiliary output 4 terminals (terminals 16 and 18.)

Communications

ch	Variable type	Address
Shared	C3	0030 or 0130

Settings

Setting range	Default
Refer to the table of setting ranges for auxiliary output 3 allocation.	17: PV transfer output for ch2

7-5-15 Operation after Power ON (*Cont*)

Function

- This parameter selects either “stop” or “continue” for the E5ZN operation after the power has been turned ON.
- The operation after a software reset or when moving from initial setting level to operation level depends on the “stop” or “continue” selection made using this parameter.

Communications

ch	Variable type	Address
Shared	C3	0012 or 0112

Settings

Setting range	Unit	Default
00000000H to 00000001H 0: Stop ($\overline{r\bar{a}}$) 1: Continue ($\overline{yE5}$)	-	0: Stop

See Also

3-10 Starting and Stopping Control (page 38)

7-5-16 Transfer Output Upper Limit ($\overline{t_r 1H}$)/($\overline{t_r 2H}$)/($\overline{t_r 3H}$)/($\overline{t_r 4H}$) Transfer Output Lower Limit ($\overline{t_r 1L}$)/($\overline{t_r 2L}$)/($\overline{t_r 3L}$)/($\overline{t_r 4L}$)

Condition: The transfer output must be allocated in the control outputs or auxiliary outputs for an analog output model.

Function

- This parameter sets the transfer output upper and lower limits used for scaling when transfer output is allocated for control and auxiliary output.
- When SP transfer output, ramp SP transfer output, or PV transfer output are allocated, the following parameters can be changed to force the transfer output upper and lower limits to change to the limits determined for each parameter.
Input type, scaling upper limit, scaling lower limit, SP upper limit, SP lower limit, temperature unit, and decimal point
- When cooling control output is not allocated for output, and cooling MV transfer output is allocated, the output will always be 0%.
- When transfer output is not allocated, the settings can still be changed and read.

Communications

Parameter	Display	ch	Variable type	Address
OUT1 transfer output upper limit	$\overline{t_r 1H}$	Shared	C3	0031 or 0131
OUT1 transfer output lower limit	$\overline{t_r 1L}$	Shared	C3	0032 or 0132
OUT2 transfer output upper limit	$\overline{t_r 2H}$	Shared	C3	0033 or 0133
OUT2 transfer output lower limit	$\overline{t_r 2L}$	Shared	C3	0034 or 0134
SUB3 transfer output upper limit	$\overline{t_r 3H}$	Shared	C3	0035 or 0135
SUB3 transfer output lower limit	$\overline{t_r 3L}$	Shared	C3	0036 or 0136
SUB4 transfer output upper limit	$\overline{t_r 4H}$	Shared	C3	0037 or 0137
SUB4 transfer output lower limit	$\overline{t_r 4L}$	Shared	C3	0038 or 0138

Settings

Setting range	Unit	Default
FFFFF831H to 0000270FH SP transfer output, ramp SP transfer output, and PV transfer output: -1999 to 9999 or -199.9 to 999.9 Heating MV transfer output, cooling MV transfer output: -1999 to 9999	-	-

See Also

- Related Parameters
 - “Input type” (initial setting level) (page 143)
 - “Control output 1 allocation,” “Control output 2 allocation” (initial setting level) (page 148)
 - “Auxiliary output 3 allocation,” “Auxiliary output 4 allocation” (initial setting level) (page 149)

■ **Setting Example 1: SP Transfer Output**

Change the input type from the default to 1 (thermocouple: K, -20 to 500°C) to automatically change the transfer output upper limit to 500.0, and the transfer output lower limit to -20.0. By setting the SP limit to 0.0 to 100.0°C, the transfer output upper limit will change to 100.0 and the transfer output lower limit will change to 0.0.

■ **Setting Example 2: PV Transfer Output**

The sensor input temperature range will be set to the default transfer output upper and lower limits. For example, if the input type is set to 0 (thermocouple: K, -200 to 1300°C), the transfer output upper limit will be set to 1,300 and the transfer output lower limit will be set to -200.

7-5-17 Current Output Type ($\bar{a}t-i$) Voltage Output Type ($\bar{a}t-c$)

Condition: Analog output models only

Function

This parameter sets current output as the output type for control output 1 and control output 2, and sets voltage output as the output type for auxiliary output 3 and auxiliary output 4.

Communications

Parameter	ch	Variable type	Address
Current output type	Shared	C3	0039 or 0139
Voltage output type	Shared	C3	003A or 013A

Settings

Parameter	Data range	Default
Current output type	00000000H(0): 4 to 20 mA 00000001H(1): 0 to 20 mA	0: 4 to 20 mA
Voltage output type	00000000H(0): 1 to 5 V 00000001H(1): 0 to 5 V	0: 1 to 5 V

7-5-18 Sensor Error Indicator Used (*SEdU*)

Condition:

Upgraded pulse output models and analog output models only

Function

- This parameter sets whether the error indicator (ERROR) on the front panel of the E5ZN will light or not light when a sensor error is detected.
- For the initial setting, when an input channel sensor is not connected during operation, a sensor error is detected and the ERROR indicator will light. The parameter can be set to always not light, so that the ERROR indicator will not light when a sensor error is detected.
- This parameter is supported by upgraded pulse output models and analog output models only.

Communications

ch	Variable type	Address
Shared	C3	003B or 013B

Settings

Setting range	Default
00000000H(0): Indicator always not lit.	3: Sensor error indicator lit (ch1 or ch2)
00000001H(1): Sensor error indicator lit (ch1 only)	
00000002H(2): Sensor error indicator lit (ch2 only)	
00000003H(3): Sensor error indicator lit (ch1 or ch2)	

7-6 Advanced Function Setting Level

7-6-1 Parameter Initialize ($\bar{L}n\bar{L}t$)

Function	This parameter initializes all settings to their defaults.
Communications	Use the “parameter initialize” operation command. Refer to page 86 for information.
Example of Use	ON ($\bar{o}n$): Initializes all parameters. OFF ($\bar{o}FF$): Turns OFF the E5ZN after returning parameter settings to their defaults.

7-6-2 Number of Multi-SP Uses ($E_{L-\bar{n}}$)

Function	<ul style="list-style-type: none"> This parameter sets the multi-SP SPs that are used for the event input. When the number of multi-SP uses setting has been changed, the setting must be enabled by executing a software reset or by turning ON the power again.
Communications	

ch	Variable type	Address
Shared	C3	0017 or 0117

Settings

Setting range	Unit	Default
00000000H to 00000001H 0: No multi-SP 1: SP0/1	-	0: No multi-SP

7-6-3 Event Input Allocation (E_{L})

Condition: The number of multi-SP uses must be set to “0.”

Function	<ul style="list-style-type: none"> By selecting this parameter to “RUN/STOP,” an external signal can be used to control RUN/STOP status. Settings are not possible when the “number of multi-SP uses” parameter is set to 1 (2: multi-SP). Setting changes to event input allocations must be enabled by executing a software reset or turning ON the power again.
Communications	

ch	Variable type	Address
Shared	C3	0018 or 0118

Settings

Setting range	Unit	Default
00000000H to 00000001H 0: None (None) 1: RUN/STOP (RUN/STOP)	-	0: None

Note The relationship with the external signal when RUN/STOP has been selected is shown below.

External signal OFF: STOP (operation stop)
 ON: RUN (operation)

See Also

- Related Parameter
“Number of Multi-SP uses” (advanced function setting level) (page 154)

7-6-4 Multi-SP Uses (Multi-SP)

Condition: The “number of multi-SP uses” parameter must be set to 0.

Function

- When set to ON, this parameter enables switching between SP0 and SP1 by using communications command or E5ZN-SDL Setting Display Unit key operations.
- Setting changes to this parameter must be enabled by executing a software reset or by turning ON the power again.

Communications

ch	Variable type	Address
Shared	C3	0019 or 0119

Settings

Setting range	Unit	Default
00000000H to 00000001H 0: OFF (OFF) 1: ON (ON)	-	0: OFF

Note To switch between SPs using event input, set the “number of multi-SP uses” to “1.”

See Also

- Related Parameter
“Number of Multi-SP uses” (advanced function setting level) (page 154)

7-6-5 SP Ramp Set Value (SP-Ramp)

Function

- This parameter specifies the rate of change during SP ramp operation. Set the maximum permissible change width per unit of time (minute) as the “SP ramp set value.” When the “SP ramp set value” is set to 0, the SP ramp function is disabled.
- During temperature input, the decimal point position of the SP ramp set value is dependent on the currently selected sensor, and during analog input it is dependent on scaling.
- Setting changes to “SP ramp set value” must be enabled by executing a software reset or by turning ON the power again.

Communications

ch	Variable type	Address
1	C3	001A
2	C3	011A

Settings

Setting range	Unit	Default
00000000H to 00000271H (0 to 9999) 0: OFF	EU/min.	0: OFF

See Also

- Related Parameters
 “Input type” (initial setting level) (page 143)
 “Scaling upper limit” “Scaling lower limit” “Decimal point” (initial setting level) (page 144)

7-6-6 Standby Sequence Reset Method (*reset*)

Condition: The alarm 1 to 3 type must be set to an alarm with a standby sequence.

Function

- This parameter sets the conditions for enabling reset after the standby sequence of the alarm has been canceled.
- Condition A:
 Control started (including power ON) or change made in SP, alarm value (upper/lower limit alarm value), or input shift value (upper/lower limit temperature input shift value).
- Condition B:
 Power ON
- The following example shows the reset action when the alarm type is lower limit alarm with standby sequence.

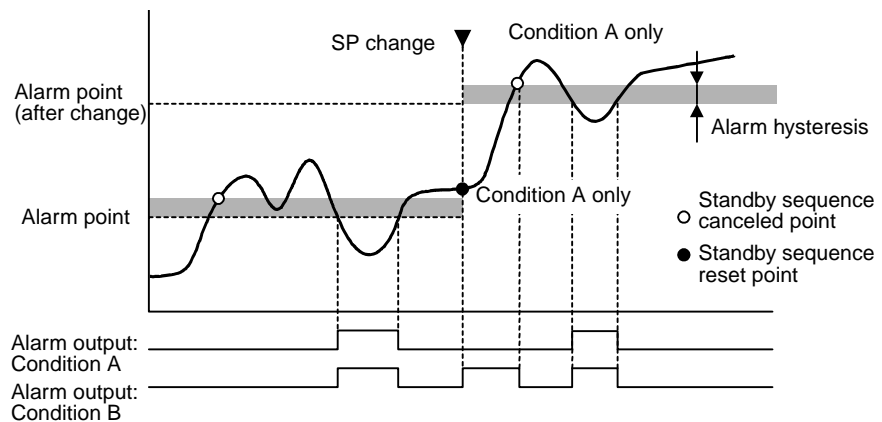

- Setting changes to “standby sequence reset” must be enabled by executing a software reset or by turning ON the power again.

Communications

ch	Variable type	Address
Shared	C3	001B or 011B

Settings

Setting range	Unit	Default
00000000H to 00000001H 0: Condition A (A) 1: Condition B (b)	-	0: Condition A

See Also

- Related Parameters
 “Alarm 1 to 3 type” (initial setting level) (page 147)
 “Alarm 1 to 3 latch” (advanced function setting level) (page 163)

**7-6-7 Alarm 1 Open in Alarm (AL 1_n)
 Alarm 2 Open in Alarm (AL 2_n)
 Alarm 3 Open in Alarm (AL 3_n)**

Function

- These parameters set the output states for alarms 1, 2, and 3.
- When the E5ZN is set to “close in alarm,” the alarm output is normally open. When set to “open in alarm,” the alarm output is normally closed. The following table shows the relationship between alarm output functions, alarm output, and operation indicator LEDs.
- When alarm 1 is set to “open in alarm,” the heater burnout alarm output also are also normally closed.

Setting	Alarm Output Function	Alarm Output	Operation Indicator LEDs
Close in alarm	ON	ON	Lit
	OFF	OFF	Not lit
Open in alarm	ON	OFF	Lit
	OFF	ON	Not lit

- Setting changes to “alarm 1 to 3 open in alarm” must be enabled by executing a software reset or by turning ON the power again.

Communications

Setting	ch	Variable type	Address
Alarm 1 open in alarm	1	C3	001C
	2	C3	011C
Alarm 2 open in alarm	1	C3	001E
	2	C3	011E
Alarm 3 open in alarm	1	C3	0020
	2	C3	0120

Settings

Setting	Setting range	Unit	Default
Alarm 1 open in alarm Alarm 2 open in alarm Alarm 3 open in alarm	00000000H to 00000001H 0: Close in alarm (n-ā) 1: Open in alarm (n-Ł)	-	0: close in alarm

See Also

- Related Parameters
 - “Alarm value 1 to 3” (operation level) (page 131)
 - “Upper limit alarm value 1” “Lower limit alarm value 1” (operation level) (page 132) “Upper limit alarm value 2” “Lower limit alarm value 2” (operation level) (page 132)
 - “Alarm 1 to 3 type” (initial setting level) (page 147)
 - “Control output 1 allocation” “Control output 2 allocation” (initial setting level) (page 147) “Auxiliary output 1 allocation” “Auxiliary output 2 allocation” (initial setting level) (page 148)
 - “Alarm 1 to 3 hysteresis” (advanced function setting level) (page 158)
 - “Standby sequence reset method” (advanced function setting level) (page 156)
 - “Alarm 1 to 3 latch” (advanced function setting level) (page 163)

**7-6-8 Alarm 1 Hysteresis (ALH1)
Alarm 2 Hysteresis (ALH2)
Alarm 3 Hysteresis (ALH3)**

Condition: The alarm type must be set to other than “no alarm.”

Function

- These parameters set the hystereses of alarm outputs 1, 2, and 3.
- Setting changes to “alarm 1 to 3 hysteresis” must be enabled by executing a software reset or by turning ON the power again.

Communications

Setting	ch	Variable type	Address
Alarm 1 hysteresis	1	C3	001D
	2	C3	011D
Alarm 2 hysteresis	1	C3	001F
	2	C3	011F
Alarm 3 hysteresis	1	C3	0021
	2	C3	0121

Settings

Setting	Setting range	Unit	Default
Alarm 1 hysteresis	00000001H to 00000270H (0.1 to 999.9)	Temperature input: °C/°F Analog input: EU	0.2
Alarm 2 hysteresis			
Alarm 3 hysteresis			

See Also

- Related Parameters
 - “Alarm value 1 to 2” (operation level) (page 131)
 - “Upper limit alarm value 1” “Lower limit alarm value 1” (operation level) (page 132) “Upper limit alarm value 2” “Lower limit alarm value 2” (operation level) (page 133)
 - “Alarm 1 to 3 type” (initial setting level) (page 147)
 - “Control output 1 allocation” “Control output 2 allocation” (initial setting level) (page 147) “Auxiliary output 1 allocation” “Auxiliary output 2 allocation” (initial setting level) (page 148)
 - “Alarm 1 to 3 open in alarm” (advanced function setting level) (page 157)
 - “Standby sequence reset method” (advanced function setting level) (page 156)
 - “Alarm 1 to 3 latch” (advanced function setting level) (page 163)

7-6-9 HBA Used (*HbU*)**Condition: Pulse output models only****Function**

- This parameter sets use of the heater burnout alarm.
- Setting changes to “HBA used” must be enabled by executing a software reset or by turning ON the power again.

Communications

ch	Variable type	Address
Shared	C3	0022 or 0122

Settings

Setting range	Unit	Default
00000000H to 00000001H 0: Not used (<i>̄FF</i>) 1: Used (<i>̄0</i>)	-	1: Used

7-6-10 Heater Burnout Latch (*HbL*)**Condition: Pulse output models only, and the “HBA used” parameter must be set to “ON.”****Function**

- When this parameter is set to ON, the heater burnout alarm is held until either of the following conditions is satisfied:
 - a) Heater burnout detection is set to 0.0 A.
 - b) The power is turned OFF and then turned ON again (power is reset).
- When switching to setting area 1, the output is turned OFF.
- Setting changes to “heater burnout latch” must be enabled by executing a software reset or by turning ON the power again.

Communications

ch	Variable type	Address
Shared	C3	0023 or 0123

Settings

Setting range	Unit	Default
00000000H to 00000001H 0: Disabled (<i>̄FF</i>) 1: Enabled (<i>̄0</i>)	-	0: Disabled

See Also

- Related Parameter
“HBA used” (advanced function setting level) (page 159)

7-6-11 Heater Burnout Hysteresis (*HbH*)**Condition: Pulse output models only, and the “heater burnout latch” parameter must be set to “OFF.”****Function**

- This parameter sets the hysteresis when HBA is detected.
- Setting changes to “heater burnout hysteresis” must be enabled by executing a software reset or by turning ON the power again.

Communications

ch	Variable type	Address
1	C3	0024
2	C3	0124

Settings

Setting range	Unit	Default
00000001H to 000001F4H (0.1 to 50.0)	A	0.1

See Also

- Related Parameter
“HBA used” (advanced function setting level) (page 159)

7-6-12 α (ALFA)

Condition: The control must be 2-PID control.

Function

- Normally, use this parameter at its default.
- This parameter sets the 2-PID constant α .
- Setting changes to “ α ” must be enabled by executing a software reset or by turning ON the power again.

Communications

ch	Variable type	Address
Shared	C3	0025 or 0125

Settings

Setting range	Unit	Default
00000000H to 00000064H (0.00 to 1.00)	-	0.65

See Also

- Related Parameter
“PID/OnOff” (initial setting level) (page 145)

7-6-13 MV Upper Limit ($\bar{\alpha}L-H$)
MV Lower Limit ($\bar{\alpha}L-L$)

Condition: The control must be 2-PID control.

Function

- The “MV upper limit” and “MV lower limit” parameters set the upper and lower limits of the manipulated variable. When the manipulated variable calculated by the E5ZN exceeds the upper or lower limit, the upper or lower limit will be used as the output level.
- MV Upper Limit
The setting ranges during standard control and heating and control output 2 control are different.
The manipulated variable at the cooling side during heating and cooling control is expressed as a negative value.
- MV Lower Limit
The setting ranges during standard control and heating and cooling control are different.
The manipulated variable at the cooling side during heating and cooling control is expressed as a negative value.
- Setting changes to “MV upper and lower limit” must be enabled by executing a software reset or by turning ON the power again.

Communications

Setting	ch	Variable type	Address
MV upper limit	1	C3	0026
	2	C3	0126
MV lower limit	1	C3	0027
	2	C3	0127

Settings

Setting	Setting range	Unit	Default
MV upper limit	For Standard Control: (MV lower limit + 1)H to 0000041AH (MV lower limit + 0.1 to 105.0)	%	105.0
	For Heating and Cooling Control: 00000000H to 0000041AH (0.0 to 105.0)	%	105.0
MV lower limit	For Standard Control: FFFFFFCEH to (MV upper limit – 1)H (–5.0 to MV upper limit – 1)	%	-5.0
	For Heating and Cooling Control FFFFFFBE6H to 00000000H (–105.0 to 0.0)	%	-105.0

See Also

- Related Parameter
“PID/OnOff” (initial setting level) (page 145)

7-6-14 Input Digital Filter (L_{DF})

Function

- Sets the time constant of the input digital filter. The following figure shows the effect on data after passing through the digital filter:

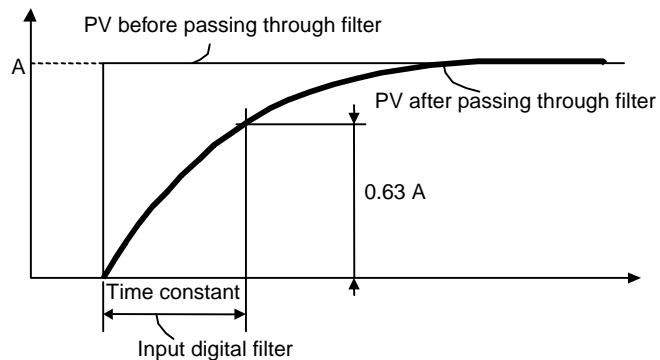

- Setting changes to “input digital filter” must be enabled by executing a software reset or by turning ON the power again.

Communications

ch	Variable type	Address
1	C3	0028
2	C3	0128

Settings

Setting range	Unit	Default
00000000H to 00000270H (0.0 to 999.9)	Second	0.0

7-6-15 Additional PV Display (P_{Ad})

Function

- This parameter enables displaying only the PV. It is added to the top of the operation level of the E5ZN-SDL Setting Display Unit. It is used to give the option of displaying the PV and SP, or just the PV only.
- Setting changes to “additional PV display” must be enabled by executing a software reset or by turning ON the power again.

Communications

ch	Variable type	Address
Shared	C3	0029 or 0129

Settings

Setting range	Unit	Default
00000000H to 00000001H 0: Not added (\bar{FF}) 1: Added ($\bar{0}$)	-	0: Not added

7-6-16 Additional Temperature Input Shift Value Display (L_{SDP})

Function

- This parameter conceals the display of the temperature input shift value in the E5ZN-SDL Setting Display Unit operation level. The input shift function is enabled even when this parameter is set to “no display.”
- Setting changes to “temperature input shift value display/not display” must be enabled by executing a software reset or by turning ON the power again.

Communications

ch	Variable type	Address
Shared	C3	002A or 012A

Settings

Setting range	Unit	Default
00000000H to 00000001H 0: No display (\bar{FF}) 1: Display ($\bar{0}$)	-	0: No display

7-6-17 Temperature Input Shift Type (L_{STP})

Condition:

Upgraded pulse output models and analog output models only

Function

- This parameter sets whether a one-point shift or a two-point shift is used as the input shift method.
- This function can be used with upgraded pulse output models and analog output models only.

Communications

ch	Variable type	Address
Shared	C3	003E or 013E

Settings

Setting range	Default
00000000H(0): Temperature input one-point shift	0: Temperature input one-point shift
00000001H(1): Temperature input two-point shift	

See Also

Refer to 4-1 Shifting Input Values (page 42).

7-6-18 Alarm 1 Latch (A1LL)
Alarm 2 Latch (A2LL)
Alarm 3 Latch (A3LL)

Condition: The alarm type must be set to other than “no alarm.”

Function

- When these parameters are set to ON, the latch function is added to the alarm functions. This means that once the alarm function has turned ON, the alarm output function is held ON until the power is turned OFF. The latch is canceled if setting area 1 is switched to.
- When alarm output function is set to “open in alarm,” the closed output is held, and when set to “close in alarm,” the open output is held.
- Setting changes to “alarm 1 to 3 latch” must be enabled by executing a software reset or by turning ON the power again.

Communications

Setting	ch	Variable type	Address
Alarm 1 latch	1	C3	002B
	2	C3	012B
Alarm 2 latch	1	C3	002C
	2	C3	012C
Alarm 3 latch	1	C3	002D
	2	C3	012D

Settings

Setting	Setting range	Unit	Default
Alarm 1 latch	00000000H to 00000001H	-	0: OFF
Alarm 2 latch	0: OFF ($\bar{a}FF$)		
Alarm 3 latch	1: ON ($\bar{a}n$)		

See Also

- Related Parameters
 “Alarm value 1 to 3” (operation level) (page 131)
 “Upper limit alarm value 1” “Lower limit alarm value 1” (operation level) (page 132) “Upper limit alarm value 2” “Lower limit alarm value 2” (operation level) (page 133)
 “Alarm 1 to 3 type” (initial setting level) (page 147)
 “Standby sequence reset method” (initial setting level) (page 156)
 “Alarm 1 to 3 open in alarm” (advanced function setting level) (page 157)
 “Alarm 1 to 3 hysteresis” (advanced function setting level) (page 158)

7-6-19 Input Error Output ($\overline{SEr\bar{o}}$)

Condition: The Alarm 1 must be allocated for control output or auxiliary output. Analog output models only.

Function

- This parameter sets whether to output only the alarm 1 output or whether to output an OR of the alarm 1 output and sensor error alarm output when an alarm 1 output is allocated in control or auxiliary output.
- When the sensor error alarm output is enabled ($\bar{o}n$), alarm 1 for ch1 will turn ON when a sensor error occurs in a ch1 input, and alarm 1 for ch2 will turn ON when a sensor error occurs in a ch2 input.
- Set the input alarm output to OFF when moving to the initial setting level, advanced function setting level, or communications setting level.
- This parameter is supported by analog output models only.

Communications

ch	Variable type	Address
Shared	C3	003D or 013D

Settings

Setting range	Default
00000000H(0): Sensor error alarm output disabled ($\bar{o}FF$)	0: Sensor error alarm output disabled
00000001H(1): Sensor error alarm output enabled ($\bar{o}n$)	

See Also

- Related Parameters

“Control Output 1 Allocation,” and “Control Output 2 Allocation” (initial setting level) (page 148)

“Auxiliary Output 3 Allocation,” and “Auxiliary Output 4 Allocation” (initial setting level) (page 149)

7-6-20 Cold Junction Compensation Method ($\overline{CJ\bar{C}}$)

Condition: Input type must be thermocouple or infrared temperature sensor.

Function

- Specifies whether cold junction compensation is to be performed internally by the Controller or to be performed externally when the input type set value is No. 0 to 15, 17 or 18.
- The cold junction compensation external setting is valid when the temperature difference is measured using two thermocouples or two ES1As.
- Setting changes to “cold junction compensation method” must be enabled by executing a software reset or by turning ON the power again.

Communications

ch	Variable type	Address
Shared	C3	002E or 012E

Settings

Setting range	Unit	Default
00000000H to 00000001H 0: External ($\bar{o}FF$) 1: Internal ($\bar{o}n$)	-	1: Internally

See Also

- Related Parameter
“Input type” (initial setting level) (page 143)

7-7 Communications Setting Level

7-7-1 Communications Data Length (*L_{E_n}*)

Function Setting changes to “communications data length” must be enabled by executing a software reset or by turning ON the power again.

Communications

ch	Variable type	Address
Shared	C3	0013 or 0113

Settings

Setting range	Unit	Default
00000007H to 00000008H (7 or 8)	Bit	7

7-7-2 Communications Stop Bit (*S_{b_L}*)

Function Setting changes to “communications stop bit” must be enabled by executing a software reset or by turning ON the power again.

Communications

ch	Variable type	Address
Shared	C3	0014 or 0114

Settings

Setting range	Unit	Default
00000001H to 00000002H (1 or 2)	Bit	2

7-7-3 Communications Parity (*P_{r_L}*)

Function Setting changes to “communications parity” must be enabled by executing a software reset or by turning ON the power again.

Communications

ch	Variable type	Address
Shared	C3	0015 or 0115

Settings

Setting range	Unit	Default
00000000H to 00000002H 00000000H (0): None (<i>nōnE</i>) 00000001H (1): Even (<i>E_vE_n</i>) 00000002H (2): Odd (<i>ōdd</i>)	-	1: Even

7-7-4 Communications Response Wait Time (5d4t)

Function

Setting changes to “communications response wait time” must be enabled by executing a software reset or by turning ON the power again.

Communications

ch	Variable type	Address
Shared	C3	0016 or 0116

Settings

Setting range	Unit	Default
00000000H to 0000270FH (0 to 9999)	ms	20

SECTION 8

Troubleshooting

This section describes the troubleshooting procedure and possible errors and remedies when the E5ZN is not operating properly. When performing troubleshooting, follow the order in which information is provided in this section.

8-1	Troubleshooting Procedure	170
8-2	Communications Errors	171
8-3	Temperature Sensing Errors	172
8-4	Temperature Control Errors	174
8-5	Output Errors.	176
8-6	HB Alarm Errors.	177
8-7	Key Operations Not Functioning	178
8-8	Error Displays	179
8-8-1	Input Error (5.Err)	179
8-8-2	Display Range Over (cccc,bbbb)	179
8-8-3	Memory Error (E!!!)	179
8-8-4	Current Value Exceeded (FFFF)	180
8-8-5	Disabled Status (----)	180

8-1 Troubleshooting Procedure

If the E5ZN has an error, refer to the following items to find the possible cause of the error and take corrective measures.

1,2,3...

1. Indicators

Check the operating status of the E5ZN using the indicators.

If the ERROR indicator is lit, turn the E5ZZ OFF and ON. If the ERROR indicator is not lit after the E5ZN is turned ON, it may mean that the E5ZN is being influenced by noise. Find the source of the noise and provide adequate protection against it.

2. Switch, Selectors, and Wiring

Check if the switch and selector settings of the E5ZN, the wiring of the E5ZN and devices connected to the E5ZN are correct.

a) Power Supply

- Check that the power supply connected to the E5ZN is turned ON.
- Check whether the supply voltage at the power supply terminals is within the allowable voltage range of the E5ZN.

b) Switch and Selectors

Check that the switch and selectors of the E5ZN are correctly set according to the system.

c) Wiring

- Check that the terminal block wiring is correct.
- Check that the polarity of each wire connected to the E5ZN is correct.
- Check if any wire is disconnected.
- Check if a wire or cable is cut or short-circuited.

d) Communications Conditions

Check that the communications conditions of the E5ZN are compatible with the host connected to the E5ZN.

Check the above items and remedy any problems listed above. If the error persists after error processing, perform further checks through communications.

3. Checking through Communications

- Check the end code and error code with the response returned from the E5ZN.
- Check the status of the E5ZN with the Status Read Command.
- Check if the functions used with the E5ZN have any operating restrictions.
- Check if the set data items of the communication commands used for the E5ZN are correct.

Troubleshoot problems on the basis of the data read with the E5ZE.

4. Troubleshooting Based on Error Symptoms

If the cause of the error is still unknown after checking all the previously mentioned items, find the cause by isolating the symptoms of the error while referring to the tables in *8-2 Communications Errors*, and correct the problem accordingly.

8-2 Communications Errors

Communications Not Possible or No Response

	Probable cause	Remedy
Communications conditions	Baud rate of the E5ZN is different from that of the host.	Set the same rate.
	Communications method of the E5ZN is different from that of the host.	Match the communications method of the E5ZN to the host's communications conditions.
Connections	Excessive number of E5ZN Units are connected in parallel.	Do not connect an excessive number of E5ZN Units. <ul style="list-style-type: none"> • The number of E5ZN Units that can be connected to the host for RS-485 communications is 16 max.
	Transmission path is too long.	The transmission path must be within the permissible range. <ul style="list-style-type: none"> • The maximum RS-485 transmission path is 500 m in total.
	Same unit number has been allocated more than once on the same transmission path.	Make sure that different numbers are assigned to all the E5ZN Units that communicate with the host.
	Communications data error due to ambient noise.	<ul style="list-style-type: none"> • Move the communications cable away from the source of noise. • Use shielded communication cables. • Use an Optical Interface. • Write a program that makes it possible for the host to detect a response error for any command that the host transmits and to re-transmit it again.
	Mistake in the use of the Optical Interface and RS-232C/RS-485 Converter Units.	Refer to the datasheets of the Optical Interface and RS-232C/RS-485 Converter Units used.
	Terminators incorrectly attached to RS-485.	Attach terminators only to the devices at each end of the communications path.
Program	System begins communications without any interval after the E5ZN Units are turned ON.	Write a program so that the system starts communications with an interval of 4 s min. after the E5ZN Units are turned ON.
	Unstable signal of the E5ZN, which is generated when the E5ZN is turned ON or OFF, is read as data by the host.	Initialize the reception buffer of the host at the following stages. <ul style="list-style-type: none"> • Before the host transmits the first command. • After the E5ZN is turned OFF.
	Host sends commands to the E5ZN before receiving any response from the E5ZN.	Write a program enabling the host to read the response after the host sends any command.
	Interval between the time the host receives a response and sends a command is too short.	The interval between the time the host receives a response and sends a command must be 5 minutes minimum.
	Program of the host is incorrect.	<ul style="list-style-type: none"> • Correct the program. • Check the command with the line monitoring function. • Run a sample program with the host.
Settings	Unit numbers set with the selectors are different from those set using the commands of the host.	The unit numbers must coincide.

8-3 Temperature Sensing Errors

Temperature Sensing Not Possible or Abnormal

	Probable cause	Remedy
Connections	Polarity or wiring of a temperature sensor is incorrect.	Correct the wiring of the temperature sensor.
	Temperature sensor is not an applicable one.	Replace the temperature sensor with an applicable one.
	Leads of a temperature sensor are disconnected, short-circuited, or deteriorated.	Replace the temperature sensor.
	Temperature sensors are not used.	Use temperature sensors.
	Thermocouple does not use applicable compensating conductors.	<ul style="list-style-type: none"> Replace the thermocouple with another thermocouple with long leads. Connect applicable compensating conductors for the thermocouple.
	Thermocouple is connected to the E5ZN with a device using a metal that is different in type from the metal of the thermocouple or that of the compensating conductors.	Connect a thermocouple-dedicated device between the thermocouple and the E5ZN.
	A screw of the terminal block of the E5ZN is loosened and improper contact is resulting.	Tighten the screw.
	Leads or compensating conductors of a thermocouple are too long and leads or compensating conductors have resistance.	<ul style="list-style-type: none"> Use sufficiently thick compensating conductors. Change the location of the thermocouple so that the length of the leads or compensating conductors can be shortened.
	The resistance of the conductors for the 3 terminals is different from the resistance of the temperature sensor connected to the E5ZN.	Use conductors that are the same in resistance for the two B terminals and the A terminal.
Installation	Noise is affecting the E5ZN.	<ul style="list-style-type: none"> Separate the E5ZN from the source of the noise. Connect a surge absorber or noise filter to the device generating the noise.
	Inductive noise generated from power lines is affecting the leads of a temperature sensor.	<ul style="list-style-type: none"> Separate the leads from the power lines. Wire the leads in a separate conduit or duct. Do not wire the leads alongside power lines. Shorten the leads. Shield the leads.
	Thermal response of a temperature sensor connected to the E5ZN is slow because the temperature sensor is located far from the temperature controlling position of the E5ZN.	Locate the tip of the protective tubing of the temperature sensor at the temperature controlling position.
	Ambient operating temperature of the E5ZN is not within the allowable ambient operating temperature range of the E5ZN.	The ambient operating temperature range of the E5ZN must be between -10 and 55°C.
	Ambient operating temperature of the E5ZN is not within the allowable ambient operating temperature range of the E5ZN.	Shield the E5ZN.
	E5ZN is affected by heat radiation from Peripheral Devices and the temperature of the terminal block of the E5ZN is not even.	Install the E5ZN in a location where it will not be affected by heat radiation.
	Terminal block of the E5ZN is affected by wind.	Protect the terminal block of the E5ZN against wind.

Probable cause		Remedy
Settings	Selector settings for the input type of temperature sensor are incorrect.	Correct the input type setting.
	Celsius-Fahrenheit designation of the E5ZN is incorrect.	Correct the °C/°F selection switch setting.
	The PV appears to be incorrect due to the input shift setting.	Set the input shift to 0.0.
	Data setting unit is incorrect.	Change the program of the host.
	Program of the host is incorrect.	
Operation	Temperature sensor input terminals of the E5ZN thermocouple input model have been short-circuited.	Connect a thermocouple to the temperature sensor input terminals.
	Temperature sensor connected to the E5ZN has been replaced or the switch or selector settings of the E5ZN have been changed while the power is ON.	Turn OFF the power to the E5ZN, and then turn ON again.

Simple Method for Checking Temperature Sensors

Platinum Resistance Thermometer

- 1,2,3...**
1. Connect a 100-Ω resistor between the A and B temperature sensor input terminals and short-circuit the B terminals.
 2. If the temperature sensed by the E5ZN is 0.0°C or 32.0°F, the E5ZN is operating normally.

Thermocouple

- 1,2,3...**
1. Short-circuit the temperature sensor input terminals of the E5ZN.
 2. If the E5ZN senses the temperature of the terminal block of the E5ZN, the E5ZN is operating normally.

8-4 Temperature Control Errors

Temperature Does Not Rise

	Probable cause	Remedy
Connections	PV of the E5ZN is abnormal.	Refer to 8-3 <i>Temperature Sensing Errors</i> for appropriate troubleshooting.
	Load is not connected to the control output terminal of the E5ZN.	Connect a load.
	Polarity or wiring of a load is incorrect.	Correct the wiring of the load.
	A screw of the terminal block of the E5ZN is loosened and improper contact is resulting.	Tighten the screw.
	Power is not supplied to heaters.	Supply power to the heaters.
	Heaters are burnt out or have deteriorated.	Replace the heaters.
	Heat capacity of the heater is too small.	<ul style="list-style-type: none"> Replace the heater with one having a larger heat capacity. If more than one heater is used and some are burnt out, replace the heaters.
	Overheating prevention device for the E5ZN is operating.	The set value of the overheating prevention device must be larger than the set value of the E5ZN.
Settings	E5ZN is in reverse operation mode, instead of direct operation mode, or vice versa.	Correct the operation mode setting.
	PID constants of the E5ZN are incorrect.	<ul style="list-style-type: none"> Execute autotuning. Set the PID constants of the E5ZN to appropriate values.
	E5ZN has not started temperature control.	Start the temperature control.
	Operation after power ON (initial setting level) is set to STOP.	Set the RUN/STOP parameter (operation level) to RUN.
	The initial setting level, communications setting level, or advanced function setting level is selected.	Move to the operation level, and set the RUN/STOP parameter to RUN.
	Control output value of the E5ZN does not increase because of the restrictions of the MV limit.	Set the MV limit of the E5ZN to an appropriate value.
	Cooling fan is operating.	Turn OFF the cooling fan.

PV Exceeds SP

	Probable cause	Remedy
Connections	PV of the E5ZN is abnormal.	Refer to 8-3 <i>Temperature Sensing Errors</i> for appropriate troubleshooting.
	Load is connected to the incorrect control point of the E5ZN and is controlling the heaters with the control output of the incorrect control point.	Correct the wiring of the load.
	Relay driven by control output has contact weld.	Replace the relay.
	SSR is short-circuited.	Replace the SSR.
	SSR leakage current is flowing into the heaters.	Connect a bleeder resistance to the SSR to prevent operation with the SSR leakage current.
Settings	E5ZN is in reverse operation mode, instead of direct operation mode, or vice versa.	Correct the operation mode setting.
	PID constants of the E5ZN are incorrect.	<ul style="list-style-type: none"> Execute autotuning. Set the PID constants of the E5ZN to the values suitable to the system.
	Control output value of the E5ZN does not increase because of the restrictions of the set MV limit.	Set the MV limit of the E5ZN to an appropriate value.
	E5ZN is outputting in manual mode.	Interrupt the manual mode of the E5ZN.

Probable cause		Remedy
Operation	Controlled object is radiating heat.	Execute heating and cooling control.
	Controlled object is influenced by large overshooting.	Refer to the following table regarding overshooting and undershooting for appropriate troubleshooting.

Overshooting or Undershooting

Probable cause		Remedy
Connections	PV of the E5ZN is abnormal.	Refer to 8-3 <i>Temperature Sensing Errors</i> for appropriate troubleshooting.
	General-purpose temperature sensor with slow thermal response characteristics is being used to sense a controlled object with quick thermal response characteristics.	Change to a sheath-type temperature sensor.
Settings	E5ZN has a narrow proportional band and small P constant.	<ul style="list-style-type: none"> • Increase the P constant keeping within the range where the response delay caused by the P constant can be allowed. • Execute autotuning.
	E5ZN has a short integral time or small I constant.	<ul style="list-style-type: none"> • Increase the I constant keeping within the range where the response delay caused by the I constant can be allowed. • Execute autotuning.
	E5ZN has a short derivative time or small D constant.	<ul style="list-style-type: none"> • Increase the D constant keeping within the range where the D constant will not have an undesirable influence on temperature stability. • Execute autotuning.
	E5ZN is executing ON and OFF control.	Execute P or PID control.
	Control period is too long when the E5ZN controls the temperature of an object with quick thermal response characteristics.	Shorten the control period.
	Dead band instead of an overlap band is set with the E5ZN in heating and cooling control operation.	Set the overlap band of the E5ZN.

Hunting

For troubleshooting problems with connections and settings, refer to the same probable causes and remedies as provided for overshooting and undershooting.

Probable cause		Remedy
Operation	Heat capacity of a heater controlling the temperature of an object is too large for the object.	Use a heater with a heat capacity suited to the object.
	Heat capacity of a controlled object changes due to periodical external disturbances.	Take appropriate measures to prevent the periodical external disturbances.
	E5ZN is executing autotuning.	Hunting will not occur if autotuning is completed.

8-5 Output Errors

Control Output or Alarm Output Does Not Turn ON

	Probable cause	Remedy
Connections	PV of the E5ZN is abnormal.	Refer to 8-3 <i>Temperature Sensing Errors</i> for appropriate troubleshooting.
	Polarity of the load or connected terminals are wired incorrectly.	Correct the wiring.
	Load exceeding the output ratings of the E5ZN is connected.	<ul style="list-style-type: none"> Connect a load that does not exceed the output ratings to the E5ZN. Request repair of the E5ZN if it is malfunctioning.
	Load power supply is not connected to transistor output.	Provide a power supply satisfying the output ratings of the E5ZN and suitable for the load.
	Polarity of the load power supply for transistor output is incorrect.	Correct the wiring.
Settings	Operation after power ON has been stopped.	<ul style="list-style-type: none"> Send A Control Operation run command from the host after turning the E5ZN ON. Set operation after power ON to "continue."
	E5ZN has not started control operation.	Send a Control Operation RUN command from the host.
	Control point designation is incorrect.	Set the correct control point numbers.
	SP of the E5ZN is set incorrectly.	Correct the SP settings.
	The output allocation is incorrect.	Set the correct output allocation.
	Incorrect multi-SP is designated.	Set the correct multi-SP.
	The same multi-SP is selected for all channels because event input is designated for multi-SP.	Specify a setting other than "event input" for multi-SP so that different multi-SP can be designated for each channel.
	When designating multi-SP with event input, the ON or OFF status of the input is not kept on hold.	Set the E5ZN so that the ON or OFF status of the input is kept on hold while designating the multi-SP with the event input.
	E5ZN attempts multi-SP designation with communications when multi-SP event input designation is selected.	Correct the multi-SP designation method setting.
	Alarm mode of the E5ZN is set to 0 (no alarm function).	Set the correct alarm mode.
Alarm mode of the E5ZN is set to alarm with standby sequence.	Use alarms without a standby sequence.	
Deviation value and absolute value are incorrect for the alarm mode set.	Set the correct alarm mode.	

8-6 HB Alarm Errors

HB Alarm Errors: Heater Burnout Detection Function Not Possible

	Probable cause	Remedy
Connections	Current Transformer is not connected.	Connect a Current Transformer to the E5ZN.
	Current Transformer is wired to an incorrect channel of the E5ZN.	Wire the Current Transformer to the correct channel.
	Heaters are controlled directly with an alarm output.	Change the wiring so that the CT input is connected to the correct control output.
Settings	E5ZN has not started control operation.	Start the control operation.
	Control output is ON for less than 190 ms.	The HB alarm will operate if the control output is turned ON for 190 ms or more.
	HB alarm is not set in output allocations.	Set "Alarm 1 and HAB OR output" in output assignments.
	Heaters are turned ON after the E5ZN starts control operation.	Turn ON the heaters before starting the E5ZN control operation.
	Heater burnout detection current value of the E5ZN is set to 0.0 or 50.0 A.	Set the heater burnout detection current value to an appropriate value between 0.1 and 49.9 A.
	Heater burnout detection current value of the E5ZN is set to the rated current.	Determine the heater burnout detection current value from the actual current consumption of the heaters.
	Heater burnout detection current value obtained from the actual current consumption of the heaters is incorrect.	Reset the heater burnout detection current value by considering the voltage range of the power supply for the heaters and any error in measurement of the current.
Operation	Total current consumption of the heaters connected to the E5ZN exceeds 50.0 A.	Set the heater current to 50.0 A maximum.
	Heaters connected are supplied with DC.	The HB alarm do not operate under this condition.
	Pure metal heaters are being used.	Determine the heater burnout detection current value from the actual current consumption of the heaters.

8-7 Key Operations Not Functioning

The Setting Display Unit Key Operations Are Not Functioning

	Probable cause	Remedy
Setting	Setting change protection (protect level) is set to ON.	Set the setting change protection (protect level) to OFF.

Cannot Move to Another Level from the Setting Display Device

	Probable cause	Remedy
Setting	Initial setting/communications protection (protect level) is set to disable movement to another level.	Change the setting/communications protection (protect level) setting, and set to enable movement to the initial setting level, communications setting level, or advanced function setting level as required.

The SP Cannot Be Changed from the Setting Display Device

	Probable cause	Remedy
Setting	The operation/adjustment protection (protect level) is set to the set value 3.	Set the operation/adjustment protection (protect level) setting to 0, 1, or 2, as required.

8-8 Error Displays

When an error has occurred, the E5ZN-SDL Setting Display Unit indicates the error code. This section describes how to check error codes on the display, and the actions you must take to remedy the problem.

8-8-1 Input Error (5.Err)

Meaning

The input value has exceeded the control range.

Control Range

Platinum resistance thermometer, thermocouple input:

Temperature setting lower limit -20°C to temperature setting upper limit 20°C
(temperature setting lower limit -40°F to temperature setting upper limit 40°F)

ES1A input:

Same as input indication range

Analog input:

-5% to 105% of scaling range

Action

Check the wiring of inputs for mistakes in wiring, disconnections, short-circuits, and the input type.

If no abnormality is found in the wiring and input type, turn the power OFF then back ON again. If the display remains the same, the E5ZN must be repaired. If the display is restored, then a probable cause can be electrical noise affecting the control system. Check for electrical noise.

Operation at Error

After the error occurs, the error is displayed, and control output functions turn OFF.

Alarm outputs function as if the upper limit has been exceeded.

An error message is displayed when "PV" or "PV/SP" is displayed.

8-8-2 Display Range Over (LLLL,bbbb)

Meaning

Although this is not an error, this is displayed when the PV exceeds the display range when the control range is larger than the display range (-1999 (-199.9) to 9999 (999.9)).

- When less than " -1999 " (-199.9)<<<<
- When larger than " 9999 " (999.9)>>>>

Action

Control continues, allowing normal operation. An error message is displayed when "PV" or "PV/SP" is displayed.

8-8-3 Memory Error (E!!!)

Meaning

Internal memory operation for the E5ZN-SDL Setting Display Unit is in error.

Action

First, turn the power OFF then back ON again. If the display remains the same, the E5ZN must be replaced. If the display is restored, then a probable cause can be electrical noise affecting the control system. Check for electrical noise.

Operation at Error

Key operations are not possible.

8-8-4 Current Value Exceeded (FFFF)

Meaning This error is displayed when the heater current value exceeds 55.0A.

Action Control continues, allowing normal operation. An error message is displayed when the heater current value monitor is displayed.

8-8-5 Disabled Status (----)

Meaning This error is displayed when one of the following errors has occurred in the connection with the E5ZN.

- The connecting cable is disconnected.
- The power supply to the E5ZN-SDL has been turned OFF while in copy mode.
- A memory error has occurred in the E5ZN. The control output and alarm outputs will be OFF for the E5ZN generating the error.

Action Units that do not show this disabled status will continue control and will operate normally. The selected Unit and the channel status will be displayed.

Appendix A

Specifications

Ratings

Supply voltage	24 VDC	
Operating voltage range	85% to 110% of rated supply voltage	
Power consumption	Approx. 3 W	
Sensor input	Thermocouple: K, J, T, E, L, U, N, R, S, B Platinum resistance thermometer: Pt100, JPt100 Infrared temperature sensor: K10 to 70°C, K60 to 120°C, K115 to 165°C, K160 to 260°C Voltage input: 0 to 50 mV	
Control output	Pulse voltage output (PNP)	12 VDC \pm 15%, max. load current 21 mA Short-circuit proof
	Transistor output	Max. operational voltage 30 VDC, max. load current 100 mA Max. residual voltage 1.5 V, max. leakage current 0.4 mA
	Linear current output	Current output range: 4 to 20 mA DC, 0 to 20 mA DC (resolution: 3,000) Allowable load impedance: 350 k Ω max. (See note.)
Auxiliary output	Sink type	Max. operational voltage 30 VDC, max. load current 50 mA
	Source type	Max. residual voltage 1.5 V, max. leakage current 0.4 mA
	Linear voltage output	Voltage output range: 1 to 5 VDC, 0 to 5 VDC (resolution: 3,000) Allowable load impedance: 10 k Ω min.
Event input	Contact	ON: 1 k Ω max., OFF: 100 k Ω min.
	Non-contact	ON: Max. residual voltage 1.5 V, OFF: Max. leakage current 0.1 mA
No. of input/control points	2 input points, 2 control points	
Setting method	Communications or E5ZN-SDL Setting Display Unit	
Control method	2-PID or ON/OFF control	
Other functions	Heater burnout alarm function, multi-SP with event input or RUN/STOP selection	
Ambient temperature	-10 to 55°C (with no condensation or icing)	
Ambient humidity	25% to 85%	
Storage temperature	-25 to 65°C (with no condensation or icing)	
Altitude	2,000 m or less	
Inrush current	13 A max.	
Recommended fuse	T4A, 125 V, time lag, low shut-off capacity	
Installation environment	Installation Category II, Pollution Class 2 (UL3121-1, CSA C22-2 No. 1010-1 compliant)	
Electromagnetic environment	Industrial electromagnetic environment (EN/IEC 61326-1 Table 2)	

Note The G32A-EA Cycle Control Unit (manufactured by OMRON, allowable load impedance: 352 Ω) can be used.

HBA

Max. heater current	Single-phase AC 50 A
Input current readout accuracy	$\pm 5\%FS \pm 1$ digit max.
Heater burnout alarm setting range	0.1 to 49.9 A (0.1 A units) 0.0 A: Heater burnout alarm output turns OFF. 50.0 A: Heater burnout alarm output turns ON.
Min. detection ON time (See note.)	190 ms

Note When the control output ON time is less than 190 ms, heater burnout detection and heater current measurement are not performed.

Characteristics

Indication accuracy	Thermocouple: ($\pm 0.5\%$ of indication value or $\pm 1^\circ\text{C}$, whichever is greater) ± 1 digit max. (See note 1.) Platinum resistance thermometer: ($\pm 0.5\%$ of indication value or $\pm 1^\circ\text{C}$, whichever is greater) ± 1 digit max. Analog input: $\pm 0.5\%$ FS ± 1 digit max. CT input: $\pm 0.5\%$ FS ± 1 digit max.	
Influence of Temperature or Voltage or EMC immunity tests (See note 2.)	Thermocouple (R, S, B): ($\pm 1\%$ of PV or $\pm 10^\circ\text{C}$, whichever is greater) ± 1 digit max. Other thermocouples: ($\pm 1\%$ of PV or $\pm 4^\circ\text{C}$, whichever is greater) ± 1 digit max. *K thermocouple at -100°C max: $\pm 10^\circ\text{C}$ max. Platinum resistance thermometer: ($\pm 1\%$ of PV or $\pm 2^\circ\text{C}$, whichever is greater) ± 1 digit max. Analog input: $\pm 1\%$ FS ± 1 digit max.	
Transfer output	Accuracy: $\pm 0.5\%$ FS (See note 3.)	
Hysteresis	0.1 to 999.9 EU (in units of 0.1 EU)	
Proportional band (P)	0.1 to 999.9 EU (in units of 0.1 EU)	
Integral time (I)	0 to 3,999 s (in units of 1 second)	
Derivative time (D)	0 to 3,999 s (in units of 1 second)	
Control period	1 to 99 s (in units of 1 second)	
Manual reset value	0.0% to 100.0% (in units of 0.1%)	
Alarm setting range	-1999 to 9999 (decimal point position dependent on input type)	
Sampling period	500 ms	
Insulation resistance	20 M Ω min. (at 500 VDC)	
Dielectric strength	600 VAC 50 or 60 Hz 1min	
Vibration resistance	10 to 55 Hz, 10 m/s ² for 2 hrs. each in X, Y and Z directions	
Shock resistance	150 m/s ² max. 3 times each in 3 axes, 6 directions	
Protective structure	Temperature Controller Module	IP00
	Terminal Unit	IP00
Memory protection	EEPROM (non-volatile memory) (number of writes: 100,000)	
Weight	Temperature Controller Module	Approx. 90 g
	Basic Terminal Unit	Approx. 100 g
	Expansion Terminal Unit	Approx. 80 g

- Note**
- The indication of K thermocouples in the -200 to $1,300^\circ\text{C}$ range, T and N thermocouples at a temperature of -100°C or less, and U and L thermocouples at any temperature is $\pm 2^\circ\text{C} \pm 1$ digit maximum. The indication of B thermocouples at a temperature of 400°C or less is unrestricted.
The indication of R and S thermocouples at a temperature of 200°C or less is $\pm 3^\circ\text{C} \pm 1$ digit maximum.
 - Ambient temperature: -10°C to 23°C to 55°C
Voltage range: -15 to $+10\%$ of rated voltage
 - When 0 to 20 mA DC is selected, the accuracy for 0 to 4 mA is $\pm 0.5\%$ FS + 0.7 mA.
When 0 to 5 VDC is selected, the accuracy for 0 to 1 V is $\pm 0.5\%$ FS + 0.175 V.

Ratings/Specifications for Setting Display Unit (Sold Separately)

Supply voltage	24 VDC
Operating voltage range	85% to 110% of rated supply voltage
Power consumption	Approx. 1 W
Indication method	7-segment digital display and single-light indicator
Ambient temperature	-10 to 55°C (with no condensation or icing)
Ambient humidity	25% to 85%
Storage temperature	-25 to 65°C (with no condensation or icing)
Altitude	2,000 m or less
Recommended fuse	T4A, 125 V, time lag, low shut-off capacity
Communications method	RS-485 (half duplex)
Communications format	Fixed
Insulation resistance	20 MΩ min. (at 500 VDC)
Dielectric strength	1500 VAC, 50 or 60 Hz 1min
Vibration resistance	10 to 55 Hz, 20 m/s ² for 2 hrs. each in X, Y and Z directions
Shock resistance	300 m/s ² max. 3 times each in 3 axes, 6 directions
Protective structure	Front panel: IP50, Rear case: IP20, Terminal section: IP00
Memory protection	EEPROM (non-volatile memory) (number of writes: 100,000)
Weight	Approx. 100 g, Adapter: approx. 10g

Current Transformer (CT)

Specifications

Item	Specifications	
Model	E54-CT1	E54-CT3
Max. continuous current	50 A	120 A (See note.)
Dielectric strength	1000 VAC (for 1 minute)	
Vibration resistance	50 Hz 98m/s ² {10G}	
Weight	Approx. 11.5 g	Approx. 50 g
Accessory	None	Armature (2) Plug (2)

Note The maximum continuous current of the E5ZN is 50 A.

External Dimensions (Unit: mm)

E54-CT1

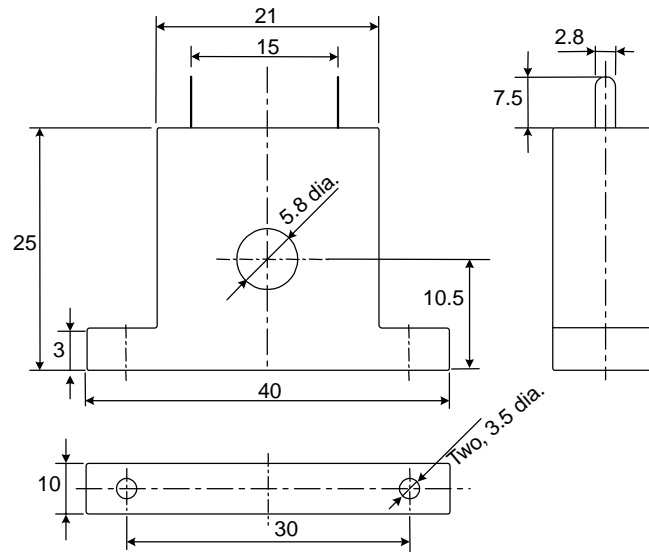

E54-CT3

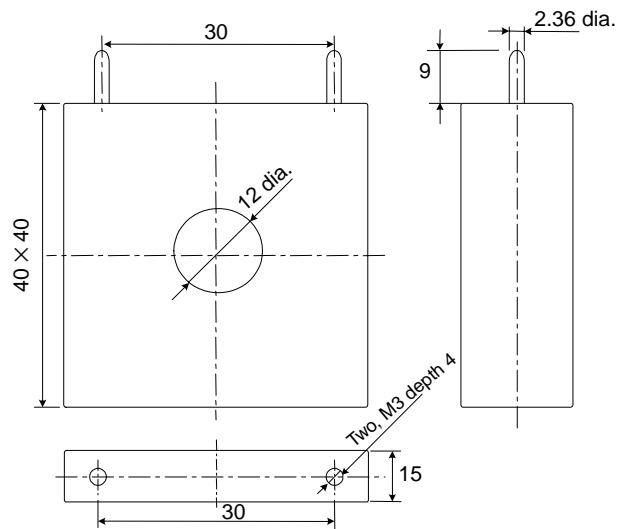

Appendix B

Sensor Input Setting Ranges/Control Ranges

Sensor	Input type	Name	Set value	Input temperature setting range	Control range
Platinum resistance thermometer input type	Platinum resistance thermometer	Pt100	0	-200 to 850°C or -300 to 1,500°F	-220 to 870°C or -340 to 1,540°F
			1	-199.9 to 500.0°C or -199.9 to 900.0°F	-219.9 to 520.0°C or -239.9 to 940.0°F
			2	0.0 to 100.0°C or 0.0 to 210.0°F	-20.0 to 120.0°C or -40.0 to 250.0°F
		JPt100	3	-199.9 to 500.0°C or -199.9 to 900.0°F	-219.9 to 520.0°C or -239.9 to 940.0°F
			4	0.0 to 100.0°C or 0.0 to 210.0°F	-20.0 to 120.0°C or -40.0 to 250.0°F
Thermocouple input type	Thermocouple	K	0	-200 to 1,300°C or -300 to 2,300°F	-220 to 1,320°C or -340 to 2,340°F
			1	-20.0 to 500.0°C or 0.0 to 900.0°F	-40.0 to 520.0°C or -40.0 to 940.0°F
		J	2	-100 to 850°C or -100 to 1,500°F	-120 to 870°C or -140 to 1,540°F
			3	-20.0 to 400.0°C or 0.0 to 750.0°F	-40.0 to 420.0°C or -40.0 to 790.0°F
		T	4	-200 to 400°C or -300 to 700°F	-220 to 420°C or -340 to 740°F
			17	-199.9 to 400.0°C or -199.9 to 700.0°F	-219.9 to 420.0°C or -239.9 to 740.0°F
		E	5	0 to 600°C or 0 to 1,100°F	-20 to 620°C or -40 to 1,140°F
		L	6	-100 to 850°C or -100 to 1,500°F	-120 to 870°C or -140 to 1,540°F
		U	7	-200 to 400°C or -300 to 700°F	-220 to 420°C or -340 to 740°F
			18	-199.9 to 400.0°C or -199.9 to 700.0°F	-219.9 to 420.0°C or -239.9 to 740.0°F
		N	8	-200 to 1,300°C or -300 to 2,300°F	-220 to 1,320°C or -340 to 2,340°F
		R	9	0 to 1,700°C or 0 to 3,000°F	-20 to 1,720°C or -40 to 3,040°F
		S	10	0 to 1,700°C or 0 to 3,000°F	-20 to 1,720°C or -40 to 3,040°F
	B	11	100 to 1,800°C or 300 to 3,200°F	0 to 1,820°C or 0 to 3,240°F	
	ES1A Infrared Temperature Sensor	K10 to 70°C	12	0 to 90°C or 0 to 190°F	-20 to 130°C or -40 to 270°F
		K60 to 120°C	13	0 to 120°C or 0 to 240°F	-20 to 160°C or -40 to 320°F
		K115 to 165°C	14	0 to 165°C or 0 to 320°F	-20 to 205°C or -40 to 400°F
		K160 to 260°C	15	0 to 260°C or 0 to 500°F	-20 to 300°C or -40 to 580°F
	Analog input	0 to 50 mA	16	One of the following ranges depending on the results of scaling: -1,999 to 9,999 or -199.9 to 999.9	-5% to 105% of setting range

- Default is 0.
- The applicable standards for each of the above input ranges are as follows:
 - K, J, T, E, N, R, S, B: JIS C1602-1995, IEC 584-1
 - L: Fe-CuNi, DIN 43710-1985
 - U: Cu-CuNi, DIN 43710-1985
 - JPt100: JIS C 1604-1989, JIS C 1606-1989
 - Pt100: JIS C 1604-1997 IEC 751

List of E5ZN-SDL Settings

Operation Level

Parameter	No. 1 display: Characters	No. 2 display: Default	Setting (monitor) value
PV		---	Displayed when a screen for PV display only has been added in additional PV display (advanced function setting level).
PV/SP		0	Temperature: Range specified for sensor input Analog: Scaling lower limit -5% FS to scaling upper limit +5% FS
Multi-SP	n-SP	0	0: SP0, 1: SP1
Ramp SP value monitor	SP-n	0	SP lower limit to SP upper limit
Heater current value monitor	Et	0.0	0.0 to 55.0 (pulse output models only)
RUN/STOP	r-S	StoP	rUn: Start operation, StoP: Stop operation
Alarm value 1	AL-1	0	-1999 to 1999/-199.9 to 999.9
Alarm upper limit value 1	AL-1H	0	-1999 to 1999/-199.9 to 999.9
Alarm lower limit value 1	AL-1L	0	-1999 to 1999/-199.9 to 999.9
Alarm value 2	AL-2	0	-1999 to 1999/-199.9 to 999.9
Alarm upper limit value 2	AL-2H	0	-1999 to 1999/-199.9 to 999.9
Alarm lower limit value 2	AL-2L	0	-1999 to 1999/-199.9 to 999.9
Alarm value 3	AL-3	0	-1999 to 1999/-199.9 to 999.9
MV monitor for heating	o	0.0	Standard control: -5.0 to 105.0 Heating and cooling control: 0.0 to 105.0
MV monitor for cooling	E-o	0.0	Heating and cooling control: 0.0 to 105.0

Adjustment Level

Parameter	No. 1 display: Characters	No. 2 display: Default	Setting (monitor) value
AT execute/cancel	ALt	oFF	on: AT execute, oFF: AT cancel
Communications writing	E-nEt	on	on: Enabled, oFF: Disabled
Heater current value monitor	Et	0.0	0.0 to 55.0 (pulse output models only)
Heater burnout detection	Hb	0.0	0.0 to 55.0 (pulse output models only)
SP 0	SP-0	0	SP lower limit to SP upper limit
SP 1	SP-1	0	SP lower limit to SP upper limit
Temperature input shift	LnS	0.0	-199.9 to 999.9
Upper limit temperature input shift value	LnSH	0.0	-199.9 to 999.9
Lower limit temperature input shift value	LnSL	0.0	-199.9 to 999.9
Proportional band	P	8.0	0.1 to 999.9
Integral time	I	233	0 to 3999
Derivative time	d	40	0 to 3999
Cooling coefficient	E-SC	1.00	0.01 to 99.99
Dead band	E-db	0.0	-199.9 to 999.9
Manual reset value	oF-r	50.0	1.1 to 100.0
Heating hysteresis	HYS	1.0	0.1 to 999.9
Cooling hysteresis	CHYS	1.0	0.1 to 999.9

Initial Setting Level

Parameter	No. 1 display: Characters	No. 2 display: Default	Setting (monitor) value
Input type	In-E	0	Platinum-resistance thermometer input: 0: Pt (-200 to 850°C or -300 to 1,500°F) 1: Pt (-199.9 to 500.0°C or -199.9 to 900.0°F) 2: Pt (0.0 to 100°C or 0.0 to 210.0°F) 3: JPt (-199.9 to 500.0°C or -199.9 to 900.0°F) 4: JPt (0.0 to 100.0°C or 0.0 to 210.0°F)
		0	Thermocouple input: 0: K (-200 to 1,300°C or -300 to 2,300°F) 1: K (-20.0 to 500.0°C or 0.0 to 900.0°F) 2: J (-100 to 850°C or -100 to 1,500°F) 3: J (-20.0 to 400.0°C or 0.0 to 750.0°F) 4: T (-200 to 400°C or -300 to 700°F) 5: E (0 to 600°C or 0 to 1,100°F) 6: L (-100 to 850°C or -100 to 1,500°F) 7: U (-200 to 400°C or -300 to 700°F) 8: N (-200 to 1,300°C or -300 to 2,300°F) 9: R (0 to 1,700°C or 0 to 3,000°F) 10: S (0 to 1,700°C or 0 to 3,000°F) 11: B (100 to 1,800°C or 300 to 3,200°F) 12: Infrared temperature sensor (K10 to 70°C) 13: Infrared temperature sensor (K60 to 120°C) 14: Infrared temperature sensor (K115 to 165°C) 15: Infrared temperature sensor (K160 to 260°C) 16: 0 to 50 mV 17: T (-199.9 to 400.0°C or -199.9 to 700.0°F) 18: U (-199.9 to 400.0°C or -199.9 to 700.0°F)
Scaling upper limit	In-H	100	Scaling lower limit + 1 to 9999
Scaling lower limit	In-L	0	-1999 to scaling upper limit -1
Decimal point	dP	0	0: 0000 1: 000.0
°C/°F selection	d-U	C	C: °C, F: °F
SP upper limit	SL-H	850 (Pt)/ 1300 (TC)	Temperature: SP lower limit +1 to input range upper limit Analog: SP lower limit +1 to scaling upper limit
SP lower limit	SL-L	-200	Temperature: Input range lower limit to SP upper limit -1 Analog: SP lower limit +1 to scaling upper limit
PID/OnOff	InbL	Pd	OnOff: ON/OFF control, Pd: 2-PID control
Heating control period	CP	2	1 to 99
Cooling control period	C-CP	2	1 to 99
Direct/reverse operation	OrEu	Or-r	Or-r: Reverse operation Or-d: Direct operation

Parameter	No. 1 display: Characters	No. 2 display: Default	Setting (monitor) value
Alarm 1 type	<i>RLLE1</i>	2	0: No alarm function 1: Upper and lower limit alarm 2: Upper limit alarm 3: Lower limit alarm 4: Upper and lower limit range alarm 5: Upper and lower limit alarm with standby sequence 6: Upper limit alarm with standby sequence 7: Lower limit alarm with standby sequence 8: Absolute value upper limit alarm 9: Absolute value lower limit alarm 10: Absolute value upper limit alarm with standby sequence 11: Absolute value lower limit alarm with standby sequence
Alarm 2 type	<i>RLLE2</i>	2	Same as for alarm 1 type.
Alarm 3 type	<i>RLLE3</i>	2	Same as for alarm 1 type.
Control output 1 allocation	<i>OUT1</i>	0	0: Heating control output for ch1 1: Cooling control output for ch1 2: Alarm 1 and HB alarm OR output for ch1 (pulse output models only) Alarm 1 and sensor error alarm OR output for ch1 (analog output models only) 3: Alarm 2 output for ch1 4: Alarm 3 output for ch1 5: Heating control output for ch2 6: Cooling control output for ch2 7: Alarm 1 and HB alarm OR output for ch2 (pulse output models only) Alarm 1 and sensor error alarm OR output for ch2 (analog output models only) 8: Alarm 2 output for ch2 9: Alarm 3 output for ch2 ----- 10: SP transfer output for ch1 (analog output models only) 11: Ramp SP transfer output for ch1 (analog output models only) 12: PV transfer output for ch1 (analog output models only) 13: Heating MV transfer output for ch1 (analog output models only) 14: Cooling MV transfer output for ch1 (analog output models only) 15: SP transfer output for ch2 (analog output models only) 16: Ramp SP transfer output for ch2 (analog output models only) 17: PV transfer output for ch2 (analog output models only) 18: Heating MV transfer output for ch2 (analog output models only) 19: Cooling MV transfer output for ch2 (analog output models only)
Control output 2 allocation	<i>OUT2</i>	5	Same as for control output 1 allocation.

Parameter	No. 1 display: Characters	No. 2 display: Default	Setting (monitor) value	
Auxiliary output 1 allocation	<i>SUb1</i>	<i>2</i>	0: Heating control output for ch1 1: Cooling control output for ch1 2: Alarm 1 and HB alarm OR output for ch1 (pulse output models only) Alarm 1 and sensor error alarm OR output for ch1 (analog output models only) 3: Alarm 2 output for ch1 4: Alarm 3 output for ch1 5: Heating control output for ch2 6: Cooling control output for ch2 7: Alarm 1 and HB alarm OR output for ch2 (pulse output models only) Alarm 1 and sensor error alarm OR output for ch2 (analog output models only) 8: Alarm 2 output for ch2 9: Alarm 3 output for ch2	
Auxiliary output 2 allocation	<i>SUb2</i>	<i>7</i>	Same as auxiliary output 1 allocation.	
Auxiliary output 3 allocation	<i>SUb3</i>	<i>12</i>	Same as control output 1 allocation.	Analog output models only
Auxiliary output 4 allocation	<i>SUb4</i>	<i>17</i>	Same as control output 1 allocation.	
Operation after power ON	<i>Cont</i>	<i>n0</i>	<i>n0</i> : Stop, <i>YES</i> : Continue (Continues the operation status from before the power supply was stopped.)	
OUT1 transfer output upper limit	<i>tr1H</i>	<i>850 (Pt)/ 1300 (TC)</i>	-1999 to 9999 or -199.9 to 999.9	Analog output models only
OUT1 transfer output lower limit	<i>tr1L</i>	<i>-200</i>	-1999 to 9999 or -199.9 to 999.9	
OUT2 transfer output upper limit	<i>tr2H</i>	<i>850 (Pt)/ 1300 (TC)</i>	-1999 to 9999 or -199.9 to 999.9	
OUT2 transfer output lower limit	<i>tr2L</i>	<i>-200</i>	-1999 to 9999 or -199.9 to 999.9	
SUB3 transfer output upper limit	<i>tr3H</i>	<i>850 (Pt)/ 1300 (TC)</i>	-1999 to 9999 or -199.9 to 999.9	
SUB3 transfer output lower limit	<i>tr3L</i>	<i>-200</i>	-1999 to 9999 or -199.9 to 999.9	
SUB4 transfer output upper limit	<i>tr4H</i>	<i>850 (Pt)/ 1300 (TC)</i>	-1999 to 9999 or -199.9 to 999.9	
SUB4 transfer output lower limit	<i>tr4L</i>	<i>-200</i>	-1999 to 9999 or -199.9 to 999.9	
Current output type	<i>0t-1</i>	<i>0</i>	0: 4 to 20 mA DC, 1: 0 to 20 mA DC	Analog output models only
Voltage output type	<i>0t-2</i>	<i>0</i>	0: 1 to 5 VDC, 1: 0 to 5 VDC	
Sensor error indicator used	<i>SEdU</i>	<i>3</i>	0: Indicators always not lit (both ch1 and ch2) 1: Sensor error indicator lit (ch1 only) 2: Sensor error indicator lit (ch2 only) 3: Sensor error indicators lit (both ch1 and ch2)	Upgraded pulse output models and analog output models only
Move to advanced function setting level	<i>Adv</i>	<i>0</i>	-1999 to 9999	

Advanced Function Setting Level

Parameter	No. 1 display: Characters	No. 2 display: Default	Set (monitor) value
Parameter initialize	$\bar{C}n\bar{C}t$	$\bar{\alpha}FF$	$\bar{\alpha}n$: All parameters initialized $\bar{\alpha}FF$: Returns to after $\bar{\alpha}FF$ initializing
Number of multi-SP uses	$Eu\bar{n}$	0	0: No multi-SP uses 1: Switch between SP0 and SP1
Event input allocation	Eu	$n\bar{\alpha}nE$	$n\bar{\alpha}nE$: Disabled $St\bar{\alpha}P$: RUN/STOP
Multi-SP used	$\bar{n}SPU$	$\bar{\alpha}FF$	$\bar{\alpha}FF$: Multi-SP disabled $\bar{\alpha}n$: Multi-SP enabled
SP ramp set value	$SPrt$	0	1 to 9999 0: SP ramp function disabled
Standby sequence reset method	$rESt$	R	R: Condition A b: Condition B
Alarm 1 open in alarm	$RLin$	$n\bar{\alpha}$	$n\bar{\alpha}$: Excitation $n\bar{C}$: Hysteresis
Alarm 1 hysteresis	$RLH1$	0.2	0.1 to 999.9
Alarm 2 open in alarm	$RL2n$	$n\bar{\alpha}$	$n\bar{\alpha}$: Excitation $n\bar{C}$: Hysteresis
Alarm 2 hysteresis	$RL2H$	0.2	0.1 to 999.9
Alarm 3 open in alarm	$RL3n$	$n\bar{\alpha}$	$n\bar{\alpha}$: Excitation $n\bar{C}$: Hysteresis
Alarm 3 hysteresis	$RL3H$	0.2	0.1 to 999.9
HBA used	HbU	$\bar{\alpha}n$	$\bar{\alpha}FF$: Not used $\bar{\alpha}n$: Used (pulse output models only)
Heater burnout latch	HbL	$\bar{\alpha}FF$	$\bar{\alpha}FF$: Disabled $\bar{\alpha}n$: Enabled (pulse output models only)
Heater burnout hysteresis	HbH	0.1	0.1 to 50.0 (pulse output models only)
α	$RLFR$	0.65	0.00 to 1.00
MV upper limit	$\bar{\alpha}L-H$	105.0	Standard control: Operation lower limit +0.1 to 105.0 Heating and cooling control: 0.0 to 105.0
MV lower limit	$\bar{\alpha}L-L$	-5.0	Standard control: -5.0 to operation limit -0.1 Heating and cooling control: -105.0 to 0
Input digital filter	$\bar{C}nF$	0.0	0.0 to 999.9
Additional PV display	$PuPd$	$\bar{\alpha}FF$	$\bar{\alpha}FF$: Not added $\bar{\alpha}n$: Added
Additional temperature input shift value display	$\bar{C}SdP$	$\bar{\alpha}FF$	$\bar{\alpha}FF$: Not displayed $\bar{\alpha}n$: Displayed
Temperature input shift type	$\bar{C}StP$	0	0: One-point temperature input shift 1: Two-point temperature input shift (upgraded pulse output models and analog output models only)
Alarm 1 latch	$R1Lt$	$\bar{\alpha}FF$	$\bar{\alpha}FF$: Disabled $\bar{\alpha}n$: Enabled
Alarm 2 latch	$R2Lt$	$\bar{\alpha}FF$	$\bar{\alpha}FF$: Disabled $\bar{\alpha}n$: Enabled
Alarm 3 latch	$R3Lt$	$\bar{\alpha}FF$	$\bar{\alpha}FF$: Disabled $\bar{\alpha}n$: Enabled

Parameter	No. 1 display: Characters	No. 2 display: Default	Set (monitor) value
Input error output	SEr \bar{o}	$\bar{o}FF$	$\bar{o}FF$: Sensor error alarm output disabled $\bar{o}n$: Sensor error alarm output enabled (analog output models only)
Cold junction compensation method	$\bar{C}J\bar{C}$	$\bar{o}n$	$\bar{o}FF$: External, $\bar{o}n$: Internal

Communications Setting Level

Parameter	No. 1 display: Characters	No. 2 display: Default	Set (monitor) value
Communications data length	LEn	7	7: 7, 8: 8
Communications stop bit	Sb $\bar{C}t$	2	1:1 bit, 2: 2 bits
Communications parity	Pr $\bar{L}Y$	$\bar{E}u\bar{E}n$	$n\bar{o}n\bar{E}$: None, $\bar{E}u\bar{E}n$: Even, $\bar{o}dd$: Odd
Communications response wait time	Sd $\bar{Y}t$	20	0 to 9999

Appendix C ASCII Table

Lower	Upper							
	0	1	2	3	4	5	6	7
0	NUL	DLE	SPACE	0	@	P	`	p
1	SOH	DC1	!	1	A	Q	a	q
2	STX	DC2	"	2	B	R	b	r
3	ETX	DC3	#	3	C	S	c	s
4	EOT	DC4	\$	4	D	T	d	t
5	ENQ	NAK	%	5	E	U	e	u
6	ACK	SYN	&	6	F	V	f	v
7	BEL	ETB	'	7	G	W	g	w
8	BS	CAN	(8	H	X	h	x
9	HT	EM)	9	I	Y	i	y
A	LF	SUB	*	:	J	Z	j	z
B	VT	ESC	+	;	K	[k	{
C	FF	FS	,	<	L	\	l	
D	CR	GS	-	=	M]	m	}
E	SO	RS	.	>	N	^	n	~
F	SI	US	/	?	O	_	o	DEL

Index

Symbols

°C/°F, 23

°C/°F selection, 144

Numerics

1-point shif, 42

2-PID control, 24

2-point temperature input shift, 45

3-position control, 29

A

α , 160

additional PV display, 162

additional temperature input shift value display, 162

address, 68

adjustment level, 115

advanced function setting level, 115

alarm 1 hysteresis, 158

alarm 1 latch, 163

alarm 1 open in alarm, 157

alarm 1 type, 147

alarm 2 hysteresis, 158

alarm 2 latch, 163

alarm 2 open in alarm, 157

alarm 2 type, 147

alarm 3 hysteresis, 158

alarm 3 latch, 163

alarm 3 open in alarm, 157

alarm 3 type, 147

alarm hysteresis, 46

alarm latch, 46

alarm lower limit alarm value 2, 133

alarm lower limit value 1, 132

alarm type, 33

alarm upper limit alarm value 2, 133

alarm upper limit value 1, 132

alarm value, 33, 35

alarm value 1, 131

alarm value 2, 131

alarm value 3, 131

ASCII table, 193

AT execute/cancel, 71, 135

AT execute/stop, 81

auto/manual, 56, 71

automatic mode, 56

autotuning, 31

auxiliary output, 27

auxiliary output 1 allocation, 148–149

auxiliary output 2 allocation, 149–150

auxiliary outputs, 15

B

baud rate, 3

BCC, 65–66

C

calculating the detection current value, 37

characteristics, 182

cold junction compensation method, 164

command frame, 65

communications data length, 166

communications parity, 166

communications procedure, 64

communications response wait time, 167

communications setting level, 115

communications stop bit, 166

communications writing, 54, 71, 80, 135

CompoWay/F, 5, 64

connector cover, 9

control output, 15

control output 1 allocation, 147

control output 2 allocation, 148

control period, 25

control start, 50

control stop, 50

cooling coefficient, 49, 140

cooling control output, 26–27

cooling control period, 25, 146

copy mode, 114, 118

CT, 16

current transformer (CT), 36, 183

D

dead band, 29, 49, 141

decimal point, 48, 144
derivative time, 32, 139
DIN track, 11
direct operation, 25
direct/reverse operation, 146
download, 118

E

echoback test, 67, 89
end code, 66
end plates, 10
ETX, 65–66
event input, 5, 16, 50
event input allocation, 50, 154
external dimensions, 8

F

FINS, 64
FINS-mini command text, 65
FINS-mini response text, 66
frame, 65
front panel, 111

H

HBA, 182
HBA used, 159
heater burnout, 36
heater burnout alarm, 16, 36, 47
heater burnout detection, 36
heater burnout hysteresis, 159
heater burnout latch, 159
heater current monitor, 36
heater current value monitor, 130, 135
heating and cooling control, 29, 49
heating control period, 146
hysteresis, 29

I

initial setting level, 115
initial setting/communications protection, 54, 128
input digital filter, 161

input type, 22, 143
integral time, 32, 139

L

levels, 114
list of parameters, 122
lower limit alarm, 33
lower limit temperature input shift value, 42, 44, 138
lower limit values, 35

M

manual mode, 56
manual reset value, 141
manual setup, 32
move to protect level, 71, 84
move to setting area 1, 71, 84
MRC, 67
MRES, 67
multiple reads of monitor values/setting data, 76
multiple writes of setting data, 79
multi-SP, 50, 71, 81, 130
multi-SP use, 50, 155
MV lower limit, 160
MV monitor for cooling, 134
MV monitor for heating, 133
MV upper limit, 160

N

no. of multi-SP uses, 50, 154
node no., 65–66

O

ON/OFF control, 24, 29
one-point shift, 43
open in alarm, 47
operation after power ON, 150
operation after turning ON the power supply, 38
operation commands, 67, 71
operation display, 3
operation level, 115
operation/adjustment protection, 54, 128

output allocations, 26

P

parameter initialize, 72, 86, 154

PID constants, 31

PID parameters, 32

PID/OnOff, 145

power supply, 14

proportional band, 32, 139

protect level, 77, 115

PV, 129

PV hold, 58, 72, 85

PV hold value, 58

PV/SP, 129

R

RAM data save, 71, 83

ramp SP value monitor, 130

ratings, 181

read controller attribute, 67, 87

read controller status, 67, 88

read from multiple variable area, 67

read from variable area, 67, 69

read monitor value, 74

read setting data, 75

response frame, 66

reverse operation, 25

RUN/STOP, 38, 71, 131

S

scaling, 48

scaling lower limit, 48, 144

scaling upper limit, 48, 144

sensor input setting ranges/control ranges, 185

setting change protection, 55, 128

setting display unit, 18, 108, 183

setting switches, 3

shifting input, 42

SID, 65

side connector, 8

software reset, 71, 83

solderless terminals, 13

SP 0, 137

SP 1, 137

SP during SP ramp, 53

SP limits, 52

SP lower limit, 145

SP ramp, 53

SP ramp set value, 53, 155

SP upper limit, 145

SRC, 67

SRES, 67

standby sequence, 46

standby sequence reset method, 156

starting control, 38

stopping control, 38

STX, 65–66

sub-address, 65–66

T

temperature input shift, 137

terminal arrangement, 13

terminator, 18

twisted-pair cable, 17

two-point shift, 44

U

unit number, 3

upload, 118

upper limit alarm, 33

upper limit temperature input shift value, 42, 44, 138

upper limit values, 35

using the keys, 112

V

variable area, 68

variable area map, 90

variable type, 68

W

wiring, 14

write mode, 82

write protect level setting data, 77

Index

write setting data, 78

write to multiple variable area, 67

write to variable area, 67, 70

Revision History

A manual revision code appears as suffix to catalog number on front cover of manual.

Cat. No. H113-E1-04



Revision code

The following table outlines changes made to manual during each revision. Page numbers refer to previous version.

Revision code	Date	Revised content
1	January 2001	Original production
02	June 2002	<p>Page xi: Added paragraph at beginning to indicate model name abbreviations.</p> <p>Page xv: Added paragraph to first precautionary item on forced cooling.</p> <p>Page 3: Added note at end of <i>1-1-3 Display</i>.</p> <p>Page 4: Replaced configuration graphic and added note.</p> <p>Page 5: Corrected one paragraph under <i>Control Output</i> and another under <i>HBA</i>.</p> <p>Page 13: Replaced graphic under <i>Terminal Arrangement</i>.</p> <p>Page 14: Added graphic and paragraph to <i>Power Supply and Inputs</i>.</p> <p>Page 15: Added graphics, replaced top terminal arrangement graphic, corrected table, and added note to table under <i>Control Output 1/2, Auxiliary Output 1/2, and CT Inputs</i>.</p> <p>Page 16: Added <i>Linear Voltage Output</i>, added graphics, and replace bottom graphic.</p> <p>Page 17, 102, and 109: Replaced graphics.</p> <p>Page 18: Added paragraph on forced cooling at end of 2-3-1.</p> <p>Page 22: Added note to table.</p> <p>Page 26: Changed tables under 3-4-3 and added setting examples.</p> <p>Page 28: Added graphic to <i>Hysteresis</i>.</p> <p>Page 40: Corrected first paragraph under 4-1-1, changed descriptions under <i>Two-point Shift</i>.</p> <p>Page 41: Deleted paragraph at end of 4-1-2.</p> <p>Pages 42 and 43: Replaced equations.</p> <p>Page 44: Added an item to 4-2-2.</p> <p>Page 47: Added graphic to <i>Cooling Coefficient</i>.</p> <p>Page 55: Updated two tables under 4-9-2.</p> <p>Page 58: Added new section 4-12.</p> <p>Page 60: Added note under 5-1-3.</p> <p>Page 64: Replaced 2nd and 3rd graphics.</p> <p>Page 67: Changed bottom table and added note.</p> <p>Pages 71, 72, 74, and 75: Corrected addresses for variable type C3.</p> <p>Pages 76, 77, and 81: Changed command tables.</p> <p>Page 82: Added new section 5-9-19 and changed response table.</p> <p>Pages 85 and 87 through 95: Changed tables.</p> <p>Pages 98 and 99: Added new section 6-1-2, replaced graphics, and deleted 6-1-3.</p> <p>Page 100: Corrected descriptions under <i>Operation Indicators</i>.</p> <p>Pages 107 and 108: Completely changed descriptions under 6-5 and 6-6.</p> <p>Pages 121, 122, 123, and 124: Changed descriptions under <i>Condition</i>.</p> <p>Pages 133 and 134: Changed tables under <i>Settings</i> and added 7-5-13 to 7-5-18.</p> <p>Pages 140 and 143: Changed descriptions under <i>Condition</i>.</p> <p>Page 143: Added new section 7-6-17.</p> <p>Page 144: Added new section 7-6-19.</p> <p>Page 152: Added few rows to <i>Settings</i> in top table.</p> <p>Page 154: Added one row to <i>Settings</i> in table.</p> <p>Page 156: Added new sections 8-7 and 8-8 (moved from Appendix B)</p> <p>Pages 157 and 158: Corrected tables and notes.</p> <p>Page 164: Added <i>List of E5ZN-SDL Settings</i> under new <i>Appendix B</i>.</p>

Revision code	Date	Revised content
03	September 2002	Pages xi, 14, 42, 46, 72, 80, 81, 85, 86, 90, 91, 104, 105, 138, 153, 162, 189, and 190: Added or revised information for upgraded pulse output models. Page14: Added an alternative model to <i>Recommended power supply</i> . Page 143: Corrected the analog input from "0 to 5 mV" to "0 to 50 mV" in the name column.
03A	October 2004	Page 182: Added information to table and accompanying notes.
03B	November 2005	Page 44: Equations 1 and 2 modified.
04	April 2015	Page xiii: Revised liability and warranty information. Page 109: Corrected the model name for P2CF-11. Added information on the influence of EMC immunity tests. Page 181: Added an Electromagnetic environment. Page 182: Added an Influence of EMC immunity tests.

OMRON Corporation Industrial Automation Company
Tokyo, JAPAN

Contact: www.ia.omron.com

Regional Headquarters

OMRON EUROPE B.V.

Wegalaan 67-69, 2132 JD Hoofddorp
The Netherlands
Tel: (31)2356-81-300/Fax: (31)2356-81-388

OMRON ASIA PACIFIC PTE. LTD.

No. 438A Alexandra Road # 05-05/08 (Lobby 2),
Alexandra Technopark,
Singapore 119967
Tel: (65) 6835-3011/Fax: (65) 6835-2711

OMRON ELECTRONICS LLC

2895 Greenspoint Parkway, Suite 200
Hoffman Estates, IL 60169 U.S.A
Tel: (1) 847-843-7900/Fax: (1) 847-843-7787

OMRON (CHINA) CO., LTD.

Room 2211, Bank of China Tower,
200 Yin Cheng Zhong Road,
PuDong New Area, Shanghai, 200120, China
Tel: (86) 21-5037-2222/Fax: (86) 21-5037-2200

Authorized Distributor:

© OMRON Corporation 2001 All Rights Reserved.
In the interest of product improvement,
specifications are subject to change without notice.

Cat. No. H113-E1-04

0415