

# C500-PRW06 PROM Writer

## OPERATION GUIDE

Revised February 1993

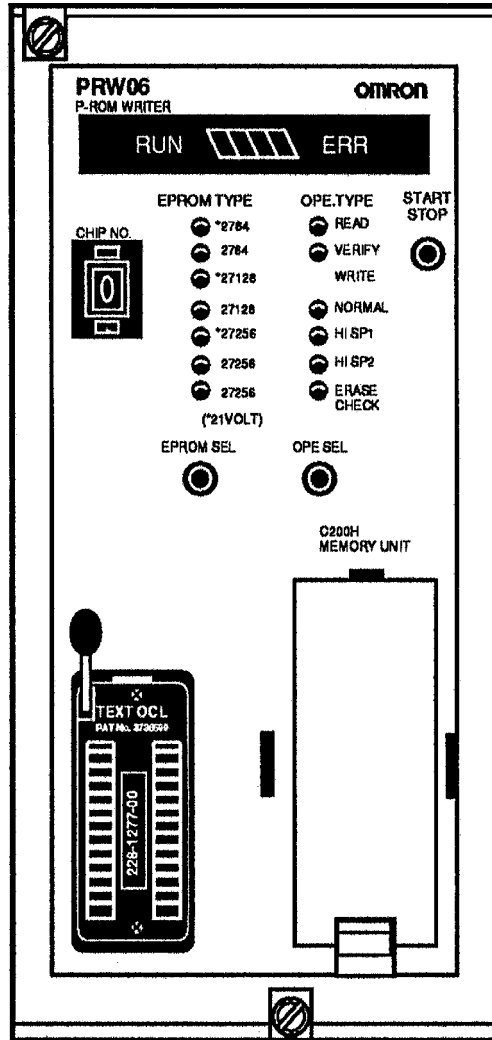

## **Notice:**

OMRON products are manufactured for use according to proper procedures by a qualified operator and only for the purposes described in this manual.

The following conventions are used to indicate and classify warnings in this manual. Always heed the information provided with them.

**DANGER!** Indicates information that, if not heeded, could result in loss of life or serious injury.

**Caution** Indicates information that, if not heeded, could result in minor injury or damage to the product.

## **OMRON Product References**

All OMRON products are capitalized in this manual. The word "Unit" is also capitalized when it refers to an OMRON product, regardless of whether or not it appears in the proper name of the product.

The abbreviation "Ch," which appears in some displays and on some OMRON products, means "word" and is abbreviated "Wd" in documentation.

The abbreviation "PC" means Programmable Controller and is not used as an abbreviation for anything else.

## **Visual Aids**

The following headings appear in the left column of the manual to help you locate different types of information.

**Note** Indicates information of particular interest for efficient and convenient operation of the product.

**1, 2, 3...** Indicates lists of one sort or another, such as procedures, precautions, etc.

## **© OMRON, 1989**

All rights reserved. No part of this publication may be reproduced, stored in a retrieval system, or transmitted, in any form, or by any means, mechanical, electronic, photocopying, recording, or otherwise, without the prior written permission of OMRON.

No patent liability is assumed with respect to the use of the information contained herein. Moreover, because OMRON is constantly striving to improve its high-quality products, the information contained in this manual is subject to change without notice. Every precaution has been taken in the preparation of this manual. Nevertheless, OMRON assumes no responsibility for errors or omissions. Neither is any liability assumed for damages resulting from the use of the information contained in this publication.

# TABLE OF CONTENTS

## SECTION 1

### **Introduction . . . . . 1**

- 1-1 Switches and Indicators . . . . . 2
- 1-2 System Configurations . . . . . 3

## SECTION 2

### **Preparation . . . . . 5**

- 2-1 EPROM Chips and C200H Memory Units . . . . . 6
- 2-2 Setting the PC . . . . . 6
- 2-3 DIP Switch Setting . . . . . 7
- 2-4 Mounting the PROM Writer . . . . . 7
- 2-5 Dimensions . . . . . 8

## SECTION 3

### **Operation . . . . . 9**

- 3-1 Switch Functions . . . . . 10
- 3-2 Checking Program Size . . . . . 12
- 3-3 EPROM Chip Installation . . . . . 14
- 3-4 Erase Check . . . . . 14
- 3-5 Writing, Verifying, and Reading the EPROM . . . . . 15
- 3-6 C200H Memory Unit Operations . . . . . 16
- 3-7 Stopping the PROM Writer during an Operation . . . . . 19

## SECTION 4

### **Writing Times . . . . . 21**

- 4-1 Program Memory (UM) . . . . . 22
- 4-2 HR, TC, and DM Areas . . . . . 23
- 4-3 Comment Memory . . . . . 23

## **Appendices**

- A Standard Models . . . . . 25
- B Specifications . . . . . 27
- C Error Messages and Troubleshooting . . . . . 29

### **Glossary . . . . . 31**

### **Index . . . . . 33**

### **Revision History . . . . . 35**

## ***About this Manual:***

This manual contains information on installing and operating the C500-PRW06 PROM Writer to write PC program and/or memory data to various types of ROM for permanent application. Please read this manual completely before attempting to install or use the PROM Writer.

**Section 1** describes the parts of the PROM Writer and the way it is connected with other devices.

**Section 2** describes the steps necessary to install the PROM Writer and prepare for operation.

**Section 3** provides the procedures to use the PROM Writer to write data and verify contents.

**Section 4** lists the times required to write data for the various PCs and types of ROM.

# SECTION 1

## Introduction

1-1	Switches and Indicators .....	2
1-2	System Configurations .....	3

# 1-1 Switches and Indicators

The PROM Writer may be used directly with all the C-series PCs or connected to the Graphic Programming Console (GPC). In addition, the Memory Unit for the C200H can be attached directly to the PROM Writer, enabling programs to be transferred and verified between this Memory Unit and another mounted to a C200H PC. This configuration allows programs or data to be copied easily without additional devices (e.g. the GPC or a cassette tape recorder). The contents of the GPC's comment memory (CM) can also be written to an EPROM chip via the PROM Writer when mounted to the GPC.

The following illustrations introduce the switches and indicators of the PROM Writer.

### Front Panel

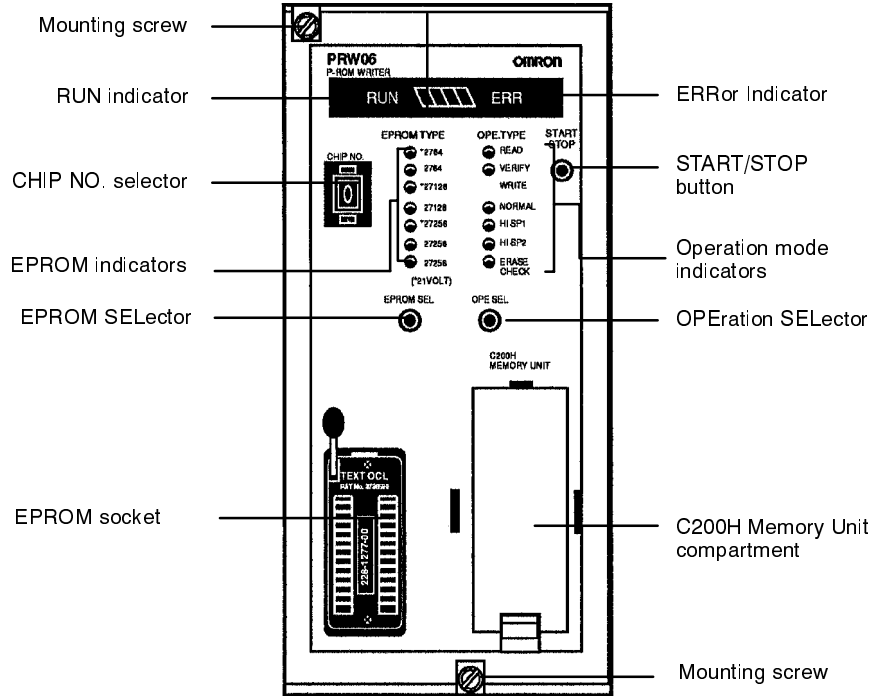

### Back Panel

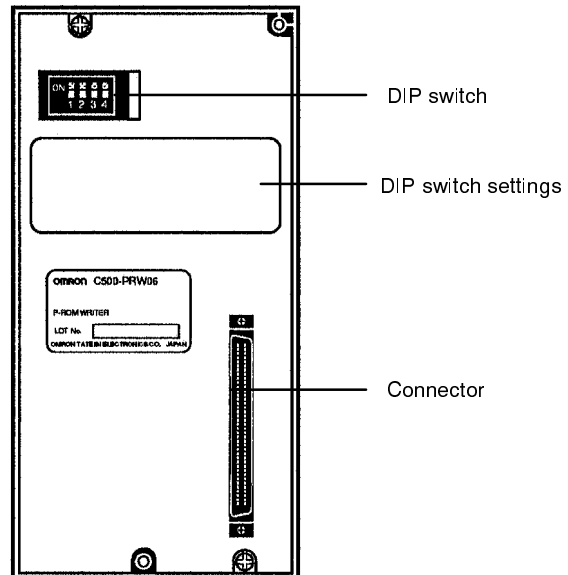

# 1-2 System Configurations

The PROM Writer may be mounted to a PC or to the GPC. To function, the proper settings must be made on the devices prior to operation. The following diagram shows how the PROM Writer may be used with C-series devices.

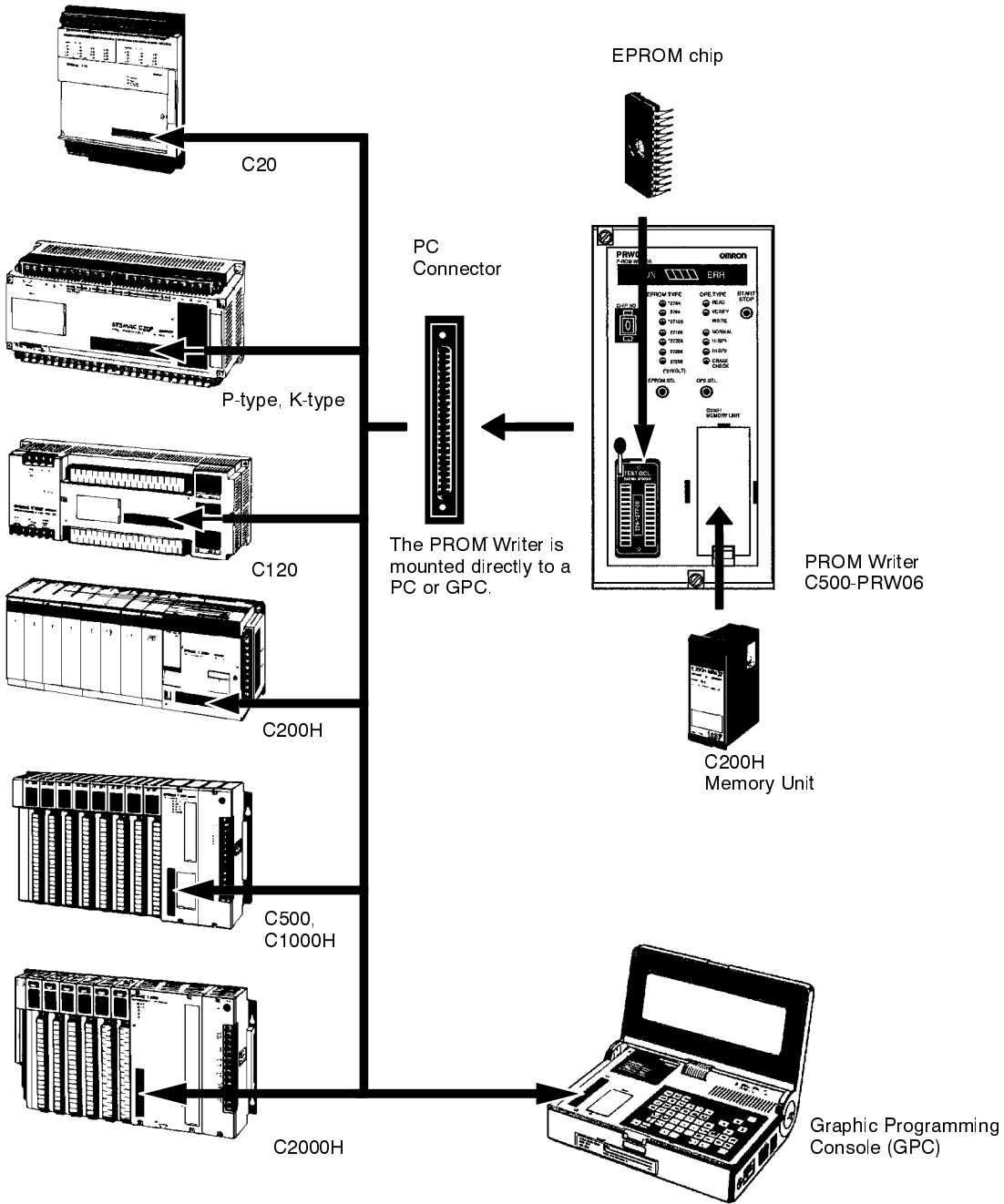

## SECTION 2

### Preparation

2-1	EPROM Chips and C200H Memory Units .....	6
2-2	Setting the PC .....	6
2-3	DIP Switch Setting .....	7
2-4	Mounting the PROM Writer .....	7
2-5	Dimensions .....	8



## 2-1 EPROM Chips and C200H Memory Units

The PROM Writer works with all the C-series PCs. Different PCs and EPROM chips require different settings on the PROM Writer. The table below shows the chips which may be used with the PROM Writer.

Model No.	Specifications	Write voltage
ROM-H	2764, 250 ns	21 V
ROM-HD	2764, 150 ns	
ROM-HB-B	2764, 200 ns	12.5 V
ROM-I	27128, 250 ns	21 V
ROM-IB-B	27128, 150 ns	12.5 V
ROM-ID-B	27128, 200 ns	
ROM-JD-B	27256, 150 ns	12.5 V
ROM-KD-B	27512, 150 ns	

The following table lists which C200H Memory Units are compatible with the PROM Writer.

RAM Unit	C200H-MR431
	C200H-MR432
	C200H-MR831
	C200H-MR832
EEPROM Unit	C200H-ME431
	C200H-ME831

## 2-2 Setting the PC

The PROM Writer operates when the PC is in PROGRAM mode. Attach the Programming Console to the PC and set the Programming Console mode selector to PROGRAM. Then remove the Programming Console, and mount the PROM Writer.



When the operation mode of the PC is changed from PROGRAM to RUN or MONITOR, i.e. when the PC is controlled by a host computer via a Host Link Unit, the PROM Writer stops.

Information concerning GPC operations can be found in the Graphic Programming Console Operation Manual.

## 2-3 DIP Switch Setting

A DIP switch on the back panel of the PROM Writer is used to select the PC model. If an incorrect EPROM chip is used (refer to 3-2 *Checking Program Size*) or these switches are incorrectly set, the ERRor indicator will light and the PROM Writer will not operate. Switch settings are indicated below.

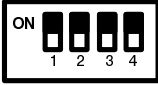
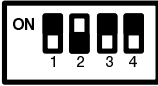
All switches are OFF when the PROM Writer is delivered.

Switch	PC when PROM Writer is mounted to CPU	PC when PROM Writer is mounted to GPC
 <p>1: OFF 2: OFF 3: OFF 4: OFF</p>	C120, C500	C20, C120, C500, P-type PCs
 <p>1: OFF 2: ON 3: OFF 4: OFF</p>	C200H, C1000H, C2000H	C200H, C1000H, C2000H, K-type PCs
 <p>1: OFF 2: OFF 3: OFF 4: ON</p>	C20, P-type PCs, K-type PCs	---

## 2-4 Mounting the PROM Writer

If the PROM Writer will be mounted to a PC, confirm that the DIP switch settings of the PROM Writer correspond to the PC being used. Then put the PC in PROGRAM mode and attach the PROM Writer directly to the PC.

If the PROM Writer will be mounted to the GPC, confirm that the Memory Pack is compatible with the PC model that will be used. Then attach the PROM Writer directly to the GPC.

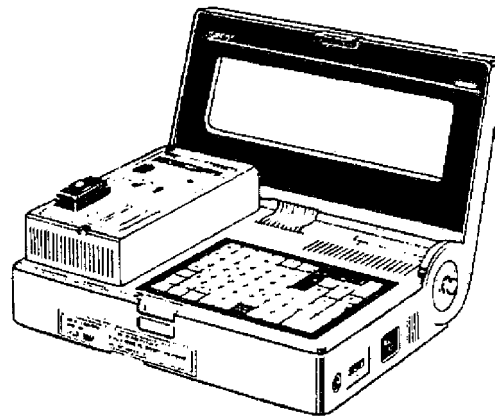

When using a C20 or P-type PC, model C500-MP303 memory pack should be used. This memory pack superior to the MP301 because it is compatible with both the C20 and P-type PCs as well as with the GPC.

**Caution** Tighten the mounting screws, and confirm that the PROM Writer is mounted securely.

## 2-5 Dimensions

The following diagram shows the dimensions of the PROM Writer. Dimensions are in millimeters.

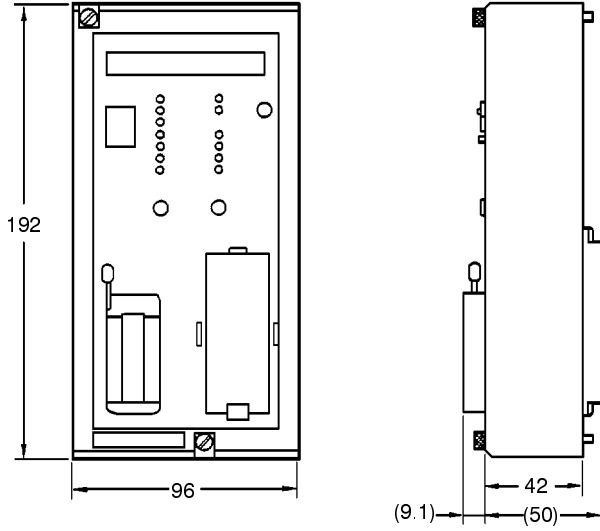



## SECTION 3

### Operation

3-1	Switch Functions .....	10
3-2	Checking Program Size .....	12
3-3	EPROM Chip Installation .....	14
3-4	Erase Check .....	14
3-5	Writing, Verifying, and Reading the EPROM .....	15
3-6	C200H Memory Unit Operations .....	16
3-6-1	Writing to the Memory Unit .....	17
3-6-2	Verifying the Memory Unit .....	18
3-6-3	Reading from the Memory Unit .....	18
3-7	Stopping the PROM Writer during an Operation .....	19

## 3-1 Switch Functions

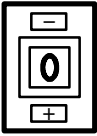
The switches and status indicators are used to set the PROM Writer and to determine its operational status. The following tables explain the PROM Writer's switches and indicators.

Switch	Function																													
START/STOP button START/STOP 	Starts and stops the PROM Writer.																													
CHIP NO. selector CHIP No. 	<p>When only one EPROM chip is used, set this switch to 0.</p> <p>If two or more EPROM chips are used, set this switch to 0 to write the first EPROM chip and to 1 to write the second EPROM chip, etc.</p> <p>To write the HR, TC, and DM area contents, set this switch to 9. Set to 8 to write CM data.</p>																													
EPROM SElector EPROM  <ul style="list-style-type: none"> <li>○ - *2764</li> <li>● - 2764</li> <li>● - *27128</li> <li>● - 27128</li> <li>● - *27256</li> <li>● - 27256</li> <li>● - 27512</li> </ul> EPROM SEL  <p><b>Note:</b> Asterisks mark indicators for chips with 21-V write voltages. Other indicators are for chips with 12.5-V write voltages.</p>	<p>Selects the EPROM chip to be used. Each time this switch is pressed, the LEDs above the switch light, moving from top to bottom, selecting the corresponding EPROM chip. (Disregard this switch when the C200H Memory Unit is used.)</p> <table border="1" data-bbox="480 821 1373 1178"> <thead> <tr> <th>Indicator</th> <th>EPROM</th> <th>Write voltage</th> <th>EPROM model</th> </tr> </thead> <tbody> <tr> <td>*2764</td> <td rowspan="2">2764</td> <td>21 V</td> <td>ROM-H/HD</td> </tr> <tr> <td>2764</td> <td>12.5 V</td> <td>ROM-HB-B/HD-B</td> </tr> <tr> <td>*27128</td> <td rowspan="2">27128</td> <td>21 V</td> <td>ROM-I</td> </tr> <tr> <td>27128</td> <td>12.5 V</td> <td>ROM-IB-B/ID-B</td> </tr> <tr> <td>*27256</td> <td rowspan="2">27256</td> <td>21 V</td> <td>-</td> </tr> <tr> <td>27256</td> <td>12.5 V</td> <td>ROM-JD-B</td> </tr> <tr> <td>27512</td> <td>27512</td> <td>12.5 V</td> <td>ROM-KD-B</td> </tr> </tbody> </table> <p><b>CAUTION</b> The correct write voltage must be used for each EPROM chip used. If a different voltage is used, the EPROM chip will be destroyed.</p>	Indicator	EPROM	Write voltage	EPROM model	*2764	2764	21 V	ROM-H/HD	2764	12.5 V	ROM-HB-B/HD-B	*27128	27128	21 V	ROM-I	27128	12.5 V	ROM-IB-B/ID-B	*27256	27256	21 V	-	27256	12.5 V	ROM-JD-B	27512	27512	12.5 V	ROM-KD-B
Indicator	EPROM	Write voltage	EPROM model																											
*2764	2764	21 V	ROM-H/HD																											
2764		12.5 V	ROM-HB-B/HD-B																											
*27128	27128	21 V	ROM-I																											
27128		12.5 V	ROM-IB-B/ID-B																											
*27256	27256	21 V	-																											
27256		12.5 V	ROM-JD-B																											
27512	27512	12.5 V	ROM-KD-B																											



Switch	Function										
<p>OPERation mode SElector</p> <p>OPE</p> <p>○ - READ</p> <p>● - VERIFY</p> <p>— WRITE</p> <p>● NORMAL</p> <p>● HI SP 1</p> <p>● HI SP 2</p> <p>● ERASE CHECK</p> <p>OPE SEL</p> <p>○</p>	<p>Selects the operation mode of the PROM Writer. Each time this switch is pressed, the LEDs above this switch light, to select the corresponding operation.</p> <table border="1"> <thead> <tr> <th>Operation</th> <th>Function</th> </tr> </thead> <tbody> <tr> <td>READ</td> <td>Reads the contents of the EPROM chip or C200H Memory Unit to the UM, or HR, TC, DM areas of the PC/GPC, or CM area of the GPC.</td> </tr> <tr> <td>VERIFY</td> <td>Verifies the contents of the EPROM chip or C200H Memory Unit against those of the UM, or HR, TC, DM areas of the PC/GPC, or CM area of the GPC.</td> </tr> <tr> <td>WRITE</td> <td>Writes the contents of the UM, HR, TC, DM, area of the PC/GPC, or CM area of the GPC, to the EPROM chip or C200H Memory Unit by any of three means: NORMAL, HI SP (high speed) 1, or HI SP 2.                      NORMAL: Standard write mode                      HI SP 1: Intel-format high-speed write                      HI SP 2: Fujitsu-format high-speed write                      The appropriate means of writing is determined by the EPROM chip and write voltage, as indicated in the following table. If a writing format or EPROM chip are incorrectly chosen, the ERRor indicator lights and the PROM Writer will not operate. If the write voltage is incorrectly chosen, the EPROM chip may be destroyed.</td> </tr> <tr> <td>ERASE CHECK</td> <td>Checks whether the EPROM chip is completely empty.</td> </tr> </tbody> </table>	Operation	Function	READ	Reads the contents of the EPROM chip or C200H Memory Unit to the UM, or HR, TC, DM areas of the PC/GPC, or CM area of the GPC.	VERIFY	Verifies the contents of the EPROM chip or C200H Memory Unit against those of the UM, or HR, TC, DM areas of the PC/GPC, or CM area of the GPC.	WRITE	Writes the contents of the UM, HR, TC, DM, area of the PC/GPC, or CM area of the GPC, to the EPROM chip or C200H Memory Unit by any of three means: NORMAL, HI SP (high speed) 1, or HI SP 2. NORMAL: Standard write mode HI SP 1: Intel-format high-speed write HI SP 2: Fujitsu-format high-speed write The appropriate means of writing is determined by the EPROM chip and write voltage, as indicated in the following table. If a writing format or EPROM chip are incorrectly chosen, the ERRor indicator lights and the PROM Writer will not operate. If the write voltage is incorrectly chosen, the EPROM chip may be destroyed.	ERASE CHECK	Checks whether the EPROM chip is completely empty.
Operation	Function										
READ	Reads the contents of the EPROM chip or C200H Memory Unit to the UM, or HR, TC, DM areas of the PC/GPC, or CM area of the GPC.										
VERIFY	Verifies the contents of the EPROM chip or C200H Memory Unit against those of the UM, or HR, TC, DM areas of the PC/GPC, or CM area of the GPC.										
WRITE	Writes the contents of the UM, HR, TC, DM, area of the PC/GPC, or CM area of the GPC, to the EPROM chip or C200H Memory Unit by any of three means: NORMAL, HI SP (high speed) 1, or HI SP 2. NORMAL: Standard write mode HI SP 1: Intel-format high-speed write HI SP 2: Fujitsu-format high-speed write The appropriate means of writing is determined by the EPROM chip and write voltage, as indicated in the following table. If a writing format or EPROM chip are incorrectly chosen, the ERRor indicator lights and the PROM Writer will not operate. If the write voltage is incorrectly chosen, the EPROM chip may be destroyed.										
ERASE CHECK	Checks whether the EPROM chip is completely empty.										

Refer to the following table to set the correct write voltage and speed for the EPROM chip being used.

Chip	2764		27128		27256		27512	C200H Memory Unit
	21 V	12.5 V	21 V	12.5 V	21 V	12.5 V	12.5 V	
NORMAL	Y	N	Y	N	N	N	N	Speed setting is ignored.
HI SP 1 (Intel)	Y	Y	Y	Y	N	Y	Y	
HI SP 2	Y	N	Y	N	Y	N	N	

**Note** Data can be written to the C200H RAM or EEPROM Memory Unit mounted to the PROM Writer when the Memory Unit is not write-protected. However, no data can be written to the C200H EPROM Memory Unit.

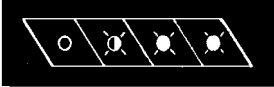
The RUN, Status, and ERRor indicators are explained in the following diagram.

Indicator	Function
<p>RUN</p> 	<p>Lit when the operation of the PROM Writer is initiated by the START/STOP switch and remains lit until the PROM Writer has completed its operation. If the PC or GPC is set incorrectly, the indicator will not be lit. (Refer to <i>Section 2 Preparation</i>.)</p> <p>While the RUN indicator is lit, do not remove the PROM Writer from the PC or GPC, attach or remove the EPROM chip or C200H Memory Unit to or from the PROM Writer, or operate any switch other than the START/STOP button.</p>
<p>Status indicator</p> 	<p>Indicates the amount of data written to the EPROM chip in four stages while the PROM Writer is in WRITE mode, as follows:</p> <ul style="list-style-type: none"> <li>• When data writing to the EPROM chip is started, all four LEDs light.</li> <li>• The amount of data written to the EPROM chip is indicated by each segment in 1/4's.</li> <li>• Each segment is unlit when the corresponding portion of data has been written to the EPROM chip.</li> <li>• When the operation is completed all LEDs are unlit.</li> </ul>
<p>ERRor</p> 	<p>Lights if the PROM Writer has detected an error and is unlit when the START/STOP button is pressed. Refer to <i>Appendix C</i> for error messages.</p>

### 3-2 Checking Program Size

The size of the program, the model of PC, and the memory area being used determine which and how many EPROM chips are required. If more than one chip is used, remember to set the CHIP No. selector to 0 for the first chip and increment this setting once with each additional chip.

**C20, P-type, K-type, and C120 PCs**

The memory capacity of each of these PCs is 8K bytes. Therefore, one ROM-H (2764, 250 ns), ROM-HB-B (2764, 200 ns), or ROM-HD (2764, 150 ns) is sufficient. Set the CHIP No. selector to 0.

**C200H PC**

The memory capacity of the C200H is 8K words. Therefore, one ROM-IB-B (27128, 200 ns) or ROM-ID-B (27128, 150 ns) is sufficient. Set the Chip No. selector to 0.

**C500 PC**

Use the keys on the Programming Console to search for END. The program size will be displayed in bytes (K), and the END address is displayed as a 4-digit number. Chips can then be selected as follows:

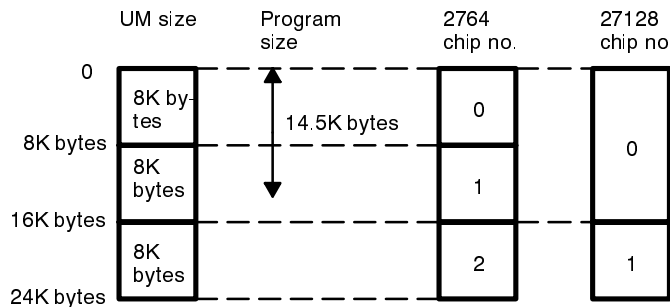

If two 2764 chips are used, the first 8K bytes of the program are stored in chip no. 0; the remaining 6.5K bytes in chip no. 1.

If the program size is 18.5K bytes, three 2764 chips, or two 27128 chips are necessary.

**C1000H and C2000H PCs**

Use the keys on the Programming Console to search for END. The program size is displayed in words (K), and the END address is displayed as a 5-digit number.

If the program size is 14.5K words two 27128 (ROM-ID-B) chips are necessary. Only 150-ns 27128, 27256, or 27512 EPROM chips can be used in the ROM Unit of the C1000H and C2000H.

Determine the required number of chips using the following figure:

UM	Up to 16K words				Up to 32K words			
	Two 27128 chips		Four 27128 chips		Two 27256 chips		Two 27512 chips	
	Higher 8 bits	Lower 8 bits	Higher 8 bits	Lower 8 bits	Higher 8 bits	Lower 8 bits	Higher 8 bits	Lower 8 bits
16 kW	0	1	0	1				
16 kW					0	1	0	1
32 kW			2	3				

**Note** When mounting program-written EPROM chips to the ROM Unit, mount chips 0 through 3 to their respective IC sockets on the ROM Unit. If chip number 4 and 5 are used, mount these chips to IC sockets 2 and 3.

**Number and Combination of EPROM Chips**

When storing UM information onto an EPROM chip, refer to the next table after determining the size of the program. This table relates the size of the program with the number of chips required.

PC	C20, P-type, K-type, C120	C200H	C500			C1000H, C2000H			
			8K bytes	16K bytes	24K bytes	8K words	16K words	24K words	32K words
Program size (up to)	8K bytes	8K words	8K bytes	16K bytes	24K bytes	8K words	16K words	24K words	32K words
ROM-H (2764, 250 ns) ROM-HB-B (2764, 200ns)	1	-	1	2	3	-	-	-	-
ROM-HD (2764, 150 ns)		-	-	-	-	-	-	-	-
ROM-I (27128, 250 ns)	-	-	-	-	-	-	-	-	-
ROM-IB-B (27128, 200 ns)		1	-	1	2	-	-	-	-
ROM-ID-B (27128, 150 ns)		-	-	-	2	-	2	-	4
ROM-JD-B (27256, 150 ns) ROM-KD-B (27512, 150 ns)	-							-	2

When storing HR, TC, and DM information onto an EPROM chip, use the following table to determine which EPROM chip to use with each model of PC. Remember to set the Chip No. selector to 9. When the PROM Writer is mounted to the GPC, memory areas mentioned below cannot be written to listed EPROM chips.



EPROM \ PC	C20, P-type, K-type	C200H	C120, C500	C1000H	C2000H
ROM-H (2764, 250 ns) ROM-HB-B (2764, 200 ns) ROM-HD (2764, 150 ns)	*	HR, TC, DM	HR, TC, DM	NA	*
ROM-I (27128, 250 ns) ROM-IB-B (27128, 200 ns) ROM-ID-B (27128, 150 ns) ROM-JD-B (27256, 150 ns) ROM-KD-B (27512, 150 ns)	*	HR, TC, DM			

\*Boxes marked with asterisks cannot have DM, TC, or HR areas written to the listed EPROM chips. For example, the C2000H PC cannot write DM information to a ROM-H chip, but it can write it to a ROM-I chip.

When performing comment memory (CM) operations, a GPC and a memory pack with CM functions must be used. The Chip No. selector of the PROM Writer must be set to 8 for CM data. Use one EPROM chip ROM-KD-B (27512, 150 ns).

### 3-3 EPROM Chip Installation

Install the EPROM chip on the IC socket as follows:

- 1, 2, 3... 1. Raise the lever to unlock the socket.
2. Holding the chip without touching the pins, insert it into the socket, with the notch end toward the top of the PROM Writer, as shown in the figure.
3. After confirming the proper insertion of the chip, lower the lever to lock it in place.

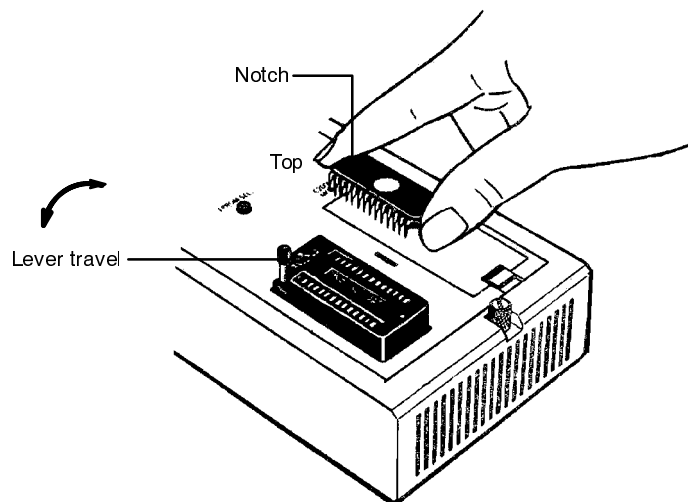

**Note** When a C200H Memory Unit is mounted to the PROM Writer, and the PROM Writer is connected to a C200H PC or a GPC in C200H mode, the EPROM socket of the PROM Writer is ignored. Therefore, remove the C200H Memory Unit before using an EPROM chip.

### 3-4 Erase Check

Before writing to an EPROM chip, it is necessary to first perform an erase check to verify that the chip is blank. Do this as follows:

- 1, 2, 3... 1. Adjust the EPROM SElector to the type of chip to be checked.
2. Set the OPEration SElector for ERASE CHECK.
3. Press the START/STOP button once to begin.

The ERRor indicator will light if the chip is not blank. The chip must then be erased entirely before it can be written.

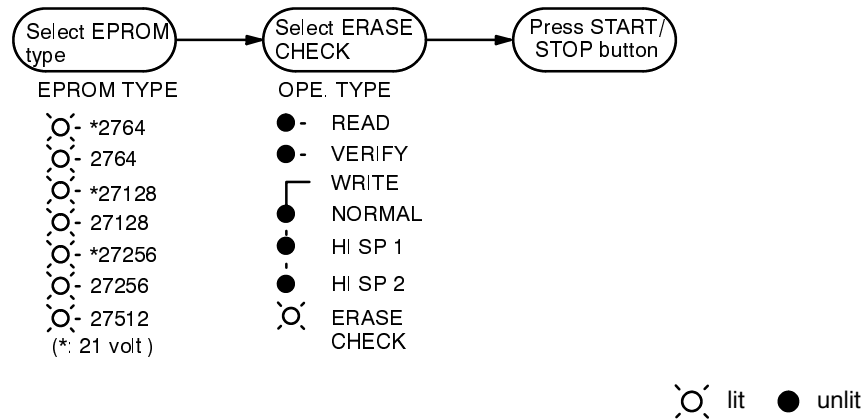

Operation	RUN	Status	ERR	Remarks
Operation in progress	○	● ● ● ●	●	—
Complete	●	● ● ● ●	●	—
Error	●	● ● ○ ●	○	EPROM is not erased

### 3-5 Writing, Verifying, and Reading the EPROM

When writing to the EPROM from the UM, or HR, TC, DM areas, follow the steps below and refer to the Summary of Chip Number and OPEration and SElector Settings on the following page.

- 1, 2, 3... 1. Set the EPROM SElector to the type of chip being used (see note).
2. Set the Chip No. selector as indicated on page 10.
3. Set the OPEration SElector to the operation desired.
4. Select the appropriate operation mode (NORMAL, HI SP 1, or HI SP 2). For details, refer to page 11.
5. Press the START/STOP button once to begin.

**Note** If the capacity of the RAM Unit mounted in the CPU is only 8K words, set the EPROM SElector to \*2764/2764 when writing from the EPROM to user memory regardless of the type of EPROM actually being used.

When writing to the EPROM interpret the indicators as follows:

○ lit    ◐ blinking    ● unlit

Operation	RUN	Status	ERR	Remarks
Beginning	○	◐ ○ ○ ○ ○	●	—
1/4 complete	○	● ◐ ○ ○ ○	●	—
2/4 complete	○	● ● ◐ ○	●	—
3/4 complete	○	● ● ● ◐	●	—
Complete	●	● ● ● ●	●	—
Error	●	● ● ● ○	○	ROM type error, write mode error
	●	● ● ○ ●	○	EPROM is not erased

Indicators can be interpreted in a similar manner for READ and VERIFY operations. That is, the RUN indicator is lit while the PROM Writer is operating and the Status indicator shows what percentage of the operation remains.

If the ERRor indicator is lit during the VERIFY or READ operations, refer to Appendix C.

### 3-6 C200H Memory Unit Operations

Writing, verifying, and reading can also be performed between a Memory Unit mounted to a C200H PC and another Memory Unit mounted to the PROM Writer.



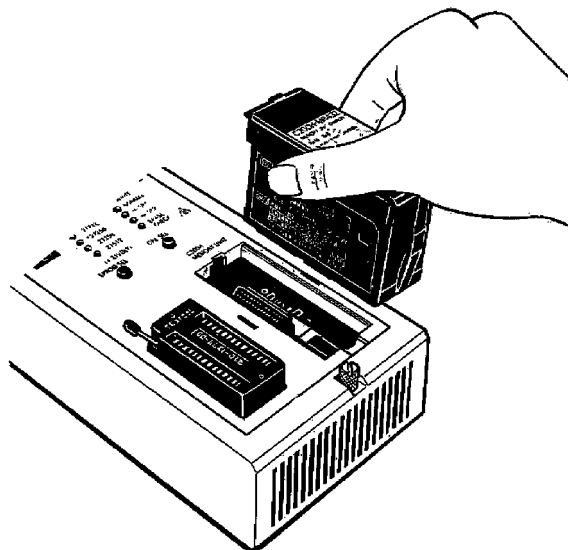

First, mount the desired Memory Unit to the PROM Writer, following these steps:

- 1, 2, 3... 1. Remove the cover from the Memory Unit compartment on the PROM Writer.
2. Insert a Memory Unit into the opening to connect the Memory Unit securely with the mating connector of the PROM Writer.



During read, write, or verify operations, the LED indicators of the PROM Writer can be interpreted as described in the following table:

 lit ● unlit

Operation	RUN	Status	ERR	Remarks
Writing		● ● ● ●	●	—
Complete	●	● ● ● ●	●	—
Error	●	●  ● ●		Mode error
	●	 ● ● ●		Write error

**Note** When the PC's UM area is written to, read from, or verified against the Memory Unit mounted to the PROM Writer, the capacity PC's Memory Unit takes precedence over the PROM Writer's Memory Unit. Therefore, if the memory capacity of the PC's Unit is equal to or greater than that of the PROM Writer's Unit, the operation is performed normally. Conversely, the following takes place, depending on whether the operation is to write, read, or verify:

Write	Data on the PROM Writer's Memory Unit in addresses exceeding those of the PC's Memory Unit will not be written.
Read	Only the data corresponding to the capacity of the Memory Unit in the PC is read.
Verify	An error occurs.

### 3-6-1 Writing to the Memory Unit

The contents of the UM area, i.e., the Memory Unit mounted to the PC, can be written to the Memory Unit mounted to the PROM Writer. However, it must be a RAM or EEPROM Unit which is not write-protected.

The write speed selected is ignored during this operation. Data will be written from the UM area to the Memory Unit at a constant speed regardless of the specified write mode (NORMAL, HI SP 1, or HI SP 2).

The EPROM SElector and Chip No. settings are also ignored.

To begin the WRITE operation, press the START/STOP button once.

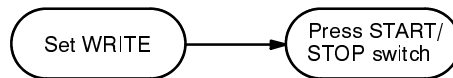

- OPE. TYPE
- - READ
- - VERIFY
- └ WRITE
- NORMAL } One of these indicators will be lit.
- HI SP 1 }
-  HI SP 2 }
- - ERASE CHECK

### 3-6-2 Verifying the Memory Unit

The content of the UM area (i.e. the Memory Unit mounted to the PC) can be verified against that of the Memory Unit mounted to the PROM Writer.

Follow these two steps:

- 1, 2, 3...**
1. Set the OPERator SElector to VERIFY. (The EPROM SElector and Chip No. selectors can be in any position.)
  2. Press the START/STOP button once to begin.

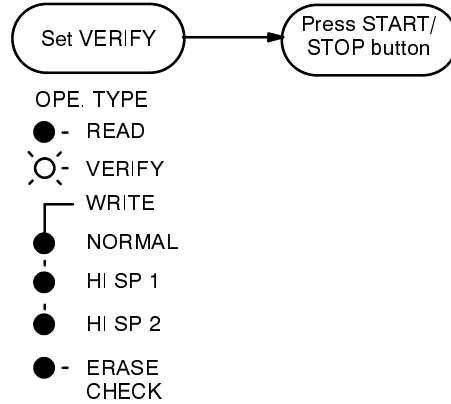

### 3-6-3 Reading from the Memory Unit

The contents of the Memory Unit mounted to the PROM Writer can be read to the UM area (i.e. the Memory Unit mounted to the PC). In this case, the UM area must be a RAM or EEPROM Unit which is not write-protected.

Follow these two steps:

- 1, 2, 3...**
1. Set the OPERator SElector to READ. (The EPROM SElector and Chip No. selectors can be in any position.)
  2. Press the START/STOP button once to begin.

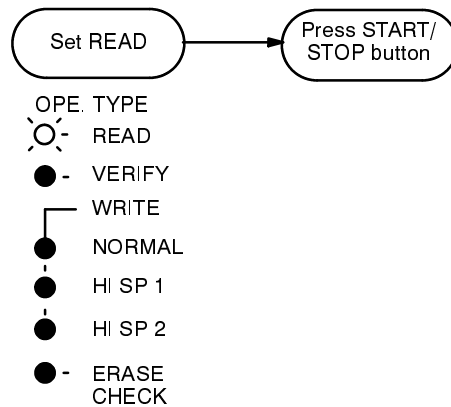

### 3-7 Stopping the PROM Writer during an Operation

The PROM Writer can be stopped at any time, during any operation, by simply pressing the START/STOP button again, after operation has begun. However, progress cannot be resumed once stopped. If it is stopped during the WRITE mode, it will be necessary to erase the EPROM chip, or change it to one that has been erased, before beginning again.

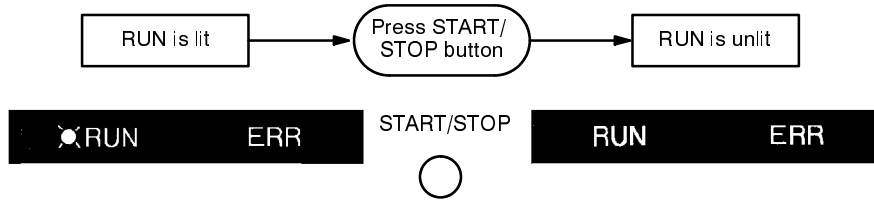

**Caution** Do not remove the PROM Writer while the RUN indicator is on. It does not matter whether the PC, or GPC, is ON.

## SECTION 4

### Writing Times

4-1	Program Memory (UM) .....	22
4-2	HR, TC, and DM Areas .....	23
4-3	Comment Memory .....	23

The writing times listed here are intended to give a general idea of how long it takes to write the EPROM chip. The times are not intended to be exact and should be referred to as a guide only. Writing times are written in the following form: minutes:seconds.

After the operation has been completed, remove the EPROM chip from the PROM Writer socket and attach the protective cover.

Insert the written EPROM chip into the desired PC, storage area, etc. The details for installing the chip into the PC can be found in the Installation Guide for that PC. Refer to the specifications table in Appendix B for environmental considerations.

## 4-1 Program Memory (UM)

	Chip	NORMAL	HI SP 1	HI SP 2
Write time (measured with C500)	*2764 (21 V)	Approx. 6:50	Approx. 0:50	Approx. 0:25
	2764 (12.5 V)	-	Approx. 0:45	-
	*27128 (21 V)	Approx. 13:35	Approx. 1:45	Approx. 0:50
	27128 (12.5 V)	-	Approx. 1:25	-
Write time (applicable to C1000H/C2000H with 27128)	*2764 (21 V)	Approx. 7:45	Approx. 1:10	Approx. 0:37
	2764 (12.5 V)	-	Approx. 0:58	-
	*27128 (21 V)	Approx. 15:23	Approx. 2:20	Approx. 1:13
	27128 (12.5 V)	-	Approx. 1:55	-
	27256 (12.5 V)	-	Approx. 3:50	-
	27512 (12.5 V)	-	Approx. 4:17	-
Write time (measured with C200H)	*27128 (21 V)	Approx. 13:20	Approx. 1:45	Approx. 0:55
	27128 (12.5 V)	-	Approx. 1:25	-
Write time (measured with C20P)	*2764 (21 V)	Approx. 6:10	Approx. 0:51	Approx. 0:30
	2764 (12.5 V)	-	Approx. 0:49	-

### C200H EEPROM

C200H-ME431	Approx. 0:04
C200H-ME831	Approx. 0:08



## 4-2 HR, TC, and DM Areas

	Chip	NORMAL	HI SP 1	HI SP 2
Write time (measured with C500)	*2764 (21 V)	Approx. 1:15	Approx. 0:10	Approx. 0:06
	2764 (12.5 V)	-	Approx. 0:10	-
	*27128 (21 V)	Approx. 1:15	Approx. 0:10	Approx. 0:06
	27128 (12.5 V)	-	Approx. 0:10	-
Write time (applicable to C1000H/C2000H with 27128)	*2764 (21 V)	Approx. 7:41	Approx. 1:10	Approx. 0:37
	2764 (12.5 V)	-	Approx. 0:58	-
	*27128 (21 V)	Approx. 7:57	Approx. 1:18	Approx. 0:39
	27128 (12.5 V)	-	Approx. 1:00	-
	27256 (12.5 V)	-	Approx. 1:05	-
	27512 (12.5 V)	-	Approx. 1:16	-
Write time (measured with C200H)	*27128 (21 V)	Approx. 5:08	Approx. 0:40	Approx. 0:20
	27128 (12.5 V)	-	Approx. 0:34	-

## 4-3 Comment Memory

	Chip	NORMAL	HI SP 1	HI SP 2
CM	27512 (12.5 V)	-	Approx. 4:00	-

# Appendix A

## Standard Models

Name	Description	Model
PROM Writer	C-series	C500-PRW06
C200H Memory Unit	RAM Unit	C200H-MR431
		C200H-MR432
		C200H-MR831
		C200H-MR832
	EEPROM Unit	C200H-ME431
		C200H-ME831
	EPROM Unit (EPROM ordered separately)	C200H-MP831

Name	Description	Access time	Write voltage	Model
EPROM Chip	2764	250 ns	21 V	ROM-H
		150 ns		ROM-HD
		200 ns	12.5 V	ROM-HB-B
	27128	250 ns	21 V	ROM-I
		200 ns	12.5 V	ROM-IB-B
		150 ns		ROM-ID-B
	27256	150 ns	12.5 V	ROM-JD-B
	27512	150 ns	12.5 V	ROM-KD-B

### EPROM Ordering Codes

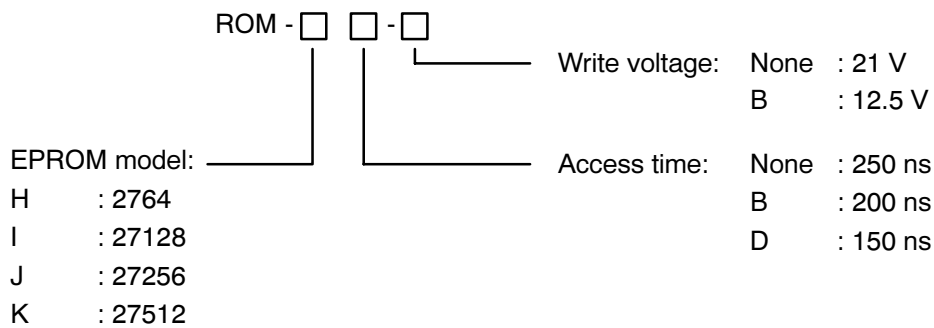

## Appendix B Specifications

Ambient temperature	Operating: 0° to 45°C Storage: -15° to 55°C
Humidity	35% to 85% (with no condensation)
Power supply	800 mA, 5 VDC max. (supplied by PC or GPC)
Dimensions	96 x 192 x 42 mm (H x W x D)
Weight	600 grams max.

# Appendix C

## Error Messages and Troubleshooting

If the ERRor indicator lights in any mode, press the START/STOP button to release the error. Use the following table to determine, and correct the cause.

### • EPROM chip

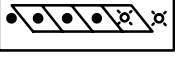
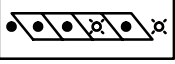
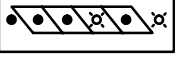
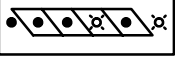
Operation	Indicator	Possible cause	Corrective action
ERASE CHECK		An EPROM chip whose contents have not been erased is mounted to the EPROM socket.	Replace the chip with a new chip whose contents have been erased.
		The EPROM chip mounted to the EPROM socket cannot be checked because the chip is faulty.	Replace the chip with a new chip whose contents have been erased.
WRITE, VERIFY, READ		An invalid chip number has been set.	Correct the chip number setting.
		The specified EPROM chip type does not match the chip actually mounted. A wrong writing format is set when the chip is to be written.	Correct the setting of the chip type and writing format.
WRITE		An unerased EPROM chip is mounted to the EPROM socket.	Replace the chip with a new one whose contents have been erased.
		No EPROM chip is mounted on the socket.	Mount an EPROM chip whose contents have been erased.
		Data cannot be written to the EPROM chip mounted to the EPROM socket because the chip is faulty.	Replace the chip with a new one whose contents have been erased.
VERIFY		Either a blank EPROM chip is mounted to the EPROM socket, or no EPROM chip is mounted to the socket.	Replace the chip with a new one to which data has been written
		The set chip number differs from the one specified when data was written to the chip.	Correct the chip number setting.
		The contents of the EPROM chip and those in the UM area of the PC or GPC do not match.	Either correct the UM area or read the contents of the EPROM.*
READ		Either a blank EPROM chip is mounted to the EPROM socket, or no EPROM chip is mounted to the socket.	Replace the chip with a new one to which data has been written.
		Either a ROM Unit is mounted to the PC or the Memory Unit in the PC is write-protected.	If a ROM Unit is mounted to the PC, replace it with a RAM or EEPROM Unit. If a RAM or EEPROM Unit is write-protected, clear the write-protection.
		The Host Link Unit mounted to the PC is in the HOST LINK mode.	Set the mode selector on the Host Link Unit to the LOCAL position.

\*There is a discrepancy between information on the EPROM chip and the PC's (or GPC's) UM area. Write the UM area to a blank chip or read the EPROM's information to the PC (or GPC) UM area again.

**Note** If the PC model specified by the DIP switch on the PROM Writer is different from the PC or GPC to which the PROM Writer is mounted, the PROM Writer will not operate.

• C200H Memory Unit

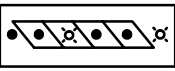
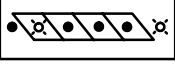
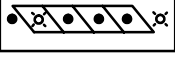
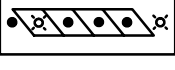
Operation	Indicator	Possible cause	Corrective action
WRITE, VERIFY, READ		ERASE CHECK mode is set.	Set the correct operation mode.
WRITE		An EPROM Unit is mounted to the PROM Writer.	Replace the EPROM Unit with a RAM or EEPROM Unit not write-protected.
		The Memory Unit mounted to the PROM Writer is write-protected.	Clear the write-protection.
		The Memory Unit mounted to the PROM Writer does not operate normally.	Replace the Memory Unit (RAM or EEPROM Unit) with a new one.
VERIFY		No Memory Unit is mounted to the C200H or PROM Writer.	Mount a Memory Unit to the C200H or PROM Writer.
		The contents of the Memory Unit in the C200H and those of the Memory Unit on the PROM Writer do not agree with each other.	Write the correct data to the Memory Units.
		The Memory Unit in the C200H or on the PROM Writer does not operate normally.	Replace the Memory Unit with a new one.
READ		A ROM Unit is mounted to the C200H.	Replace the Memory Unit with a RAM or EEPROM Unit not write protected.
		The Memory Unit mounted to the C200H is write protected.	Clear the write-protection.
		The Memory Unit in the C200H does not operate normally.	Replace the Memory Unit with a new one.

When the PROM Writer is mounted to the C200H or GPC and a C200H Memory Unit is mounted to the PROM Writer, operations are not possible between the EPROM chip and the PROM Writer.

# Glossary

<b>EEPROM</b>	Electrically erasable programmable read-only memory. A type of read-only memory (ROM) from which stored data can be erased for rewriting. It is erased (i.e., reset to all-zeros) by applying a voltage to two of its terminals.
<b>EPROM</b>	Erasable programmable read-only memory. A type of read-only memory (ROM) in which stored data can be erased via ultraviolet light applied to a small window on the EPROM chip.
<b>PROM</b>	Programmable read-only memory. A type of read-only memory (ROM) in which data can be written once but which cannot be altered after it has been written.
<b>verify</b>	A process that confirms that data is identical on a destination and a source, e.g., that data on an EPROM chip is identical to that in a C200H Memory Unit.
<b>write speed</b>	The rate at which data is recorded onto a chip.
<b>write voltage</b>	The voltage used to record data onto a chip.

# Index

## C–E

checking program size, 12  
compatible chips, compatible C200H Memory Packs, 6  
dimensions, 8  
DIP switch settings, 7  
erase checks, 14

## I

installing chips, 14  
interrupting operations, 19

## M–P

mounting instructions, 7  
nomenclature, 2  
number and combination of chips, 13  
PC settings, 6

## R–T

reading from the C200H Memory Unit, 18  
specifications, 27  
standard models, 25  
switch functions, 10  
system configurations, 3  
troubleshooting, 29

## V–W

verifying the C200H Memory Unit, 18  
writing EPROMs, verifying EPROMs, reading EPROMs, 15  
writing times, 22  
writing to the C200H Memory Unit, 17

# Revision History

A manual revision code appears as a suffix to the catalog number on the front cover of the manual.

Cat. No. W155-E1-2B

↑  
— Revision code

The following table outlines the changes made to the manual during each revision. Page numbers refer to the previous version.

Revision code	Date	Revised content
1	February 1989	Original production
2	October 1989	Redundancies removed, and general cleaning of text and graphics.
2A	July 1991	The ROM-IB (27128, 200 ns, 24 V) and ROM-ID (27128, 150 ns, 21 V) deleted, and the ROM-ID-B (27128, 150 ns, 12.5 V) added. Changes related to these on pages 6, 10, 12, 13, 14, and 25.
2B	February 1993	<b>Page 7:</b> PC specifications for DIP switch settings changed. <b>Page 8:</b> Dimensions added. <b>Page 13:</b> 2764 chip eliminated from use with C1000H/C2000H (use not possible). <b>Page 15:</b> Note added concerning writing to CPUs with 8K-word RAM memories.