

**DeviceNet Safety**

**DST1-series**

**Safety I/O Terminals**

**OPERATION MANUAL**

**OMRON**



# **DST1-series Safety I/O Terminals**

## **Operation Manual**

*Revised June 2011*





## Notice:

OMRON products are manufactured for use according to proper procedures by a qualified operator and only for the purposes described in this manual.

The following conventions are used to indicate and classify precautions in this manual. Always heed the information provided with them. Failure to heed precautions can result in injury to people or damage to property.

 **DANGER** Indicates an imminently hazardous situation which, if not avoided, is likely to result in serious injury or may result in death. Additionally, there may be severe property damage.

 **WARNING** Indicates a potentially hazardous situation which, if not avoided, will result in minor or moderate injury or may result in serious injury or death. Additionally, there may be severe property damage.

 **Caution** Indicates a potentially hazardous situation which, if not avoided, may result in minor or moderate injury or in property damage.



Indicates required actions.



Indicates prohibited actions.

## OMRON Product References

All OMRON products are capitalized in this manual. The word “Unit” is also capitalized when it refers to an OMRON product, regardless of whether or not it appears in the proper name of the product.

The abbreviation “PLC” means Programmable Controller. “PC” is used, however, in some Programming Device displays to mean Programmable Controller.

## Visual Aids

The following headings appear in the left column of the manual to help you locate different types of information.

**IMPORTANT** Indicates important information on what to do or not to do to prevent failure to operation, malfunction, or undesirable effects on product performance.

**Note** Indicates information of particular interest for efficient and convenient operation of the product.

**1,2,3...** 1. Indicates lists of one sort or another, such as procedures, checklists, etc.

## ***Trademarks and Copyrights***

DeviceNet and DeviceNet Safety are registered trademarks of the Open DeviceNet Vendors Association.

Other product names and company names in this manual are trademarks or registered trademarks of their respective companies.

The copyright of the DeviceNet Safety DST1-series Safety I/O Terminals belongs to OMRON Corporation.

### **© OMRON, 2005**

All rights reserved. No part of this publication may be reproduced, stored in a retrieval system, or transmitted, in any form, or by any means, mechanical, electronic, photocopying, recording, or otherwise, without the prior written permission of OMRON.

No patent liability is assumed with respect to the use of the information contained herein. Moreover, because OMRON is constantly

striving to improve its high-quality products, the information contained in this manual is subject to change without notice. Every precaution has been taken in the preparation of this manual. Nevertheless, OMRON assumes no responsibility for errors or omissions. Neither is any liability assumed for damages resulting from the use of the information contained in this publication.

# TABLE OF CONTENTS

<b>PRECAUTIONS</b> .....	<b>xv</b>
1 Intended Audience .....	xvi
2 General Precautions .....	xvi
3 Safety Precautions .....	xix
4 Operating Environment Precautions .....	xxi
5 Additional Precautions According to UL 1604 .....	xxiii
6 Regulation and Standards .....	xxiii
7 Glossary .....	xxiv
<b>SECTION 1</b>	
<b>Overview</b> .....	<b>1</b>
1-1 Overview .....	2
1-2 Standard Models .....	5
1-3 Functions .....	6
1-4 Description of Safety Functions .....	9
1-5 Logic Functions .....	17
1-6 Monitoring Functions .....	21
1-7 Maintenance Functions of DST1-series Safety I/O Terminals .....	27
<b>SECTION 2</b>	
<b>General Procedure</b> .....	<b>45</b>
2-1 General Procedure .....	46
2-2 Installation .....	47
2-3 Connecting I/O Power and I/O Cable .....	48
2-4 Connecting the Communications Connector .....	51
2-5 Node Address .....	52
2-6 Configuration .....	52
<b>SECTION 3</b>	
<b>Configuration</b> .....	<b>53</b>
3-1 Editing Parameters .....	54
3-2 Remote I/O Allocations .....	70
<b>SECTION 4</b>	
<b>Specifications</b> .....	<b>87</b>
4-1 Specifications .....	88
4-2 Indicators .....	90

# TABLE OF CONTENTS

## SECTION 5

<b>DST1 Series Specifications</b> .....	<b>93</b>
5-1 DST1-ID12SL-1 .....	94
5-2 DST1-MD16SL-1 .....	97
5-3 DST1-MRD08SL-1 .....	101
5-4 DST1-XD0808SL-1 .....	106

## SECTION 6

<b>Response Performance</b> .....	<b>111</b>
6-1 Reaction Time .....	112

## SECTION 7

<b>Troubleshooting and Maintenance</b> .....	<b>113</b>
7-1 Indicators and Error Processing .....	114
7-2 Troubleshooting .....	115
7-3 Error History .....	118
7-4 Maintenance .....	120

## SECTION 8

<b>Wiring Examples</b> .....	<b>123</b>
8-1 Wiring and Configuration .....	124
8-2 Examples of Wiring for Each Application .....	125
8-3 Logic Terminal Wiring Examples .....	133

<b>Appendices</b> .....	<b>137</b>
-------------------------	------------

<b>Index</b> .....	<b>151</b>
--------------------	------------

<b>Revision History</b> .....	<b>155</b>
-------------------------------	------------



## About this Manual:

This manual describes the installation and operation of a DST1-series Safety I/O Terminals (referred to as the DST1 in this manual).

Please read this manual carefully and be sure you understand the information provided before attempting to install or operate the DST1. Be sure to read the precautions provided in the following section.

The following manuals provide information on the DeviceNet and DeviceNet Safety.

Manual	Products	Contents	Cat. No.
DeviceNet Safety DST1-series Safety I/O Terminals Operation Manual (This manual)	DST1-series Safety I/O Terminals	Information on DST1-series Safety I/O Terminals	Z904
DeviceNet Safety System Configuration Manual	WS02-CFSC1-E	Information on using the Network Configurator	Z905
DeviceNet Safety Network Controller Operation Manual	NE1A Series: NE1A-SCPU01(-V1) NE1A-SCPU02 NE1A-SCPU01-EIP NE1A-SCPU02-EIP	Specifications, performance information, and operating procedure for NE1A-series Safety Network Controllers.	Z906
DeviceNet Safety NE0A Series Safety Network Controller Operation Manual	NE0A Series: NE0A-SCPU01	Specifications, functions, and usage of the NE0A-series Safety Network Controllers.	Z916
DeviceNet Operation Manual	Describes the network configuration and connection modes of a DeviceNet network. Also provides details on connection methods, specifications, and power supply methods to the communications systems of connection devices, such as cables and connectors.		W267



**WARNING** Failure to read and understand the information provided in this manual may result in personal injury or death, damage to the product, or product failure. Please read each section in its entirety and be sure you understand the information provided in the section and related sections before attempting any of the procedures or operations given.



## ***Read and Understand this Manual***

Please read and understand this manual before using the product. Please consult your OMRON representative if you have any questions or comments.

## ***Warranty and Limitations of Liability***

### ***WARRANTY***

OMRON's exclusive warranty is that the products are free from defects in materials and workmanship for a period of one year (or other period if specified) from date of sale by OMRON.

OMRON MAKES NO WARRANTY OR REPRESENTATION, EXPRESS OR IMPLIED, REGARDING NON-INFRINGEMENT, MERCHANTABILITY, OR FITNESS FOR PARTICULAR PURPOSE OF THE PRODUCTS. ANY BUYER OR USER ACKNOWLEDGES THAT THE BUYER OR USER ALONE HAS DETERMINED THAT THE PRODUCTS WILL SUITABLY MEET THE REQUIREMENTS OF THEIR INTENDED USE. OMRON DISCLAIMS ALL OTHER WARRANTIES, EXPRESS OR IMPLIED.

### ***LIMITATIONS OF LIABILITY***

OMRON SHALL NOT BE RESPONSIBLE FOR SPECIAL, INDIRECT, OR CONSEQUENTIAL DAMAGES, LOSS OF PROFITS OR COMMERCIAL LOSS IN ANY WAY CONNECTED WITH THE PRODUCTS, WHETHER SUCH CLAIM IS BASED ON CONTRACT, WARRANTY, NEGLIGENCE, OR STRICT LIABILITY.

In no event shall the responsibility of OMRON for any act exceed the individual price of the product on which liability is asserted.

IN NO EVENT SHALL OMRON BE RESPONSIBLE FOR WARRANTY, REPAIR, OR OTHER CLAIMS REGARDING THE PRODUCTS UNLESS OMRON'S ANALYSIS CONFIRMS THAT THE PRODUCTS WERE PROPERLY HANDLED, STORED, INSTALLED, AND MAINTAINED AND NOT SUBJECT TO CONTAMINATION, ABUSE, MISUSE, OR INAPPROPRIATE MODIFICATION OR REPAIR.

# ***Application Considerations***

## ***SUITABILITY FOR USE***

OMRON shall not be responsible for conformity with any standards, codes, or regulations that apply to the combination of products in the customer's application or use of the products.

At the customer's request, OMRON will provide applicable third party certification documents identifying ratings and limitations of use that apply to the products. This information by itself is not sufficient for a complete determination of the suitability of the products in combination with the end product, machine, system, or other application or use.

The following are some examples of applications for which particular attention must be given. This is not intended to be an exhaustive list of all possible uses of the products, nor is it intended to imply that the uses listed may be suitable for the products:

- Outdoor use, uses involving potential chemical contamination or electrical interference, or conditions or uses not described in this manual.
- Nuclear energy control systems, combustion systems, railroad systems, aviation systems, medical equipment, amusement machines, vehicles, safety equipment, and installations subject to separate industry or government regulations.
- Systems, machines, and equipment that could present a risk to life or property.

Please know and observe all prohibitions of use applicable to the products.

**NEVER USE THE PRODUCTS FOR AN APPLICATION INVOLVING SERIOUS RISK TO LIFE OR PROPERTY WITHOUT ENSURING THAT THE SYSTEM AS A WHOLE HAS BEEN DESIGNED TO ADDRESS THE RISKS, AND THAT THE OMRON PRODUCTS ARE PROPERLY RATED AND INSTALLED FOR THE INTENDED USE WITHIN THE OVERALL EQUIPMENT OR SYSTEM.**

## ***PROGRAMMABLE PRODUCTS***

OMRON shall not be responsible for the user's programming of a programmable product, or any consequence thereof.

## **Disclaimers**

### ***CHANGE IN SPECIFICATIONS***

Product specifications and accessories may be changed at any time based on improvements and other reasons.

It is our practice to change model numbers when published ratings or features are changed, or when significant construction changes are made. However, some specifications of the products may be changed without any notice. When in doubt, special model numbers may be assigned to fix or establish key specifications for your application on your request. Please consult with your OMRON representative at any time to confirm actual specifications of purchased products.

### ***DIMENSIONS AND WEIGHTS***

Dimensions and weights are nominal and are not to be used for manufacturing purposes, even when tolerances are shown.

### ***PERFORMANCE DATA***

Performance data given in this manual is provided as a guide for the user in determining suitability and does not constitute a warranty. It may represent the result of OMRON's test conditions, and the users must correlate it to actual application requirements. Actual performance is subject to the OMRON Warranty and Limitations of Liability.

### ***ERRORS AND OMISSIONS***

The information in this manual has been carefully checked and is believed to be accurate; however, no responsibility is assumed for clerical, typographical, or proofreading errors, or omissions.



# PRECAUTIONS

1	Intended Audience .....	xvi
2	General Precautions .....	xvi
3	Safety Precautions .....	xix
4	Operating Environment Precautions .....	xxi
5	Additional Precautions According to UL 1604 .....	xxiii
6	Regulation and Standards .....	xxiii
7	Glossary .....	xxiv

## 1 Intended Audience

This manual is intended for the following personnel, who must have knowledge of electrical systems (an electrical engineer or the equivalent).

- Personnel in charge of introducing FA and safety systems into production facilities
- Personnel in charge of designing FA and safety systems
- Personnel in charge of managing FA facilities
- Personnel who have the qualifications, authority, and obligation to provide safety during each of the following product phases: mechanical design, installation, operation, maintenance, and disposal

## 2 General Precautions

The user must operate the product according to the performance specifications described in the operation manuals.

Before using the product under conditions which are not described in the manual or applying the product to nuclear control systems, railroad systems, aviation systems, vehicles, combustion systems, medical equipment, amusement machines, safety equipment, and other systems, machines, and equipment that may have a serious influence on lives and property if used improperly, consult your OMRON representative.

Make sure that the ratings and performance characteristics of the product are sufficient for the systems, machines, and equipment, and be sure to provide the systems, machines, and equipment with double safety mechanisms.

This manual provides information for programming and operating the Unit. Be sure to read this manual before attempting to use the Unit and keep this manual close at hand for reference during operation.

 **WARNING** It is extremely important that a PLC and all PLC Units be used for the specified purpose and under the specified conditions, especially in applications that can directly or indirectly affect human life. You must consult with your OMRON representative before applying a PLC System to the above-mentioned applications.

 **WARNING** This is the Operation Manual for the DST1-series Safety I/O Terminals. Heed the following items during system construction to ensure that safety-related components are configured in a manner that allows the system functions to sufficiently operate.

### ■ Risk Assessment

The proper use of the safety device described in this Operation Manual as it relates to installation conditions and mechanical performance and functions is a prerequisite for its use. When selecting or using this safety device, risk assessment must be conducted with the aim of identifying potential danger factors in equipment or facilities in which the safety device is to be applied, during the development stage of the equipment or facilities. Suitable safety devices must be selected under the guidance of a sufficient risk assessment system. An insufficient risk assessment system may lead to the selection of unsuitable safety devices.

- Typical related international standards: ISO 14121, Safety of Machinery -- Principles of Risk Assessment



### ■ Safety Measures

When using this safety device to build systems containing safety-related components for equipment or facilities, the system must be designed with the full understanding of and conformance to international standards, such as those listed below, and/or standards in related industries.

- Typical related international standards: ISO/DIS 12100, Safety of Machinery -- Basic Concepts and General Principles for Design IEC 61508, Safety Standard for Safety Instrumented Systems (Functional Safety of Electrical/Electronic/Programmable Electronic Safety-related Systems)

### ■ Role of Safety Device

This safety device is provided with safety functions and mechanisms as stipulated in relevant standards, but suitable designs must be used to allow these functions and mechanisms to operate properly inside system constructions containing safety-related components. Build systems that enable these functions and mechanisms to perform properly, based on a full understanding of their operation.

- Typical related international standards: ISO 14119, Safety of Machinery -- Interlocking Devices Associated with Guards -- Principles of Design and Selection

### ■ Installation of Safety Device

The construction and installation of systems with safety-related components for equipment or facilities must be performed by technicians who have received suitable training.

- Typical related international standards: ISO/DIS 12100, Safety of Machinery -- Basic Concepts and General Principles for Design IEC 61508, Safety Standard for Safety Instrumented Systems (Functional Safety of Electrical/Electronic/Programmable Electronic Safety-related Systems)

### ■ Complying with Laws and Regulations

This safety device conforms to the relevant regulations and standards, but make sure that it is used in compliance with local regulations and standards for the equipment or facilities in which it is applied.

- Typical related international standards: IEC 60204, Safety of Machinery -- Electrical Equipment of Machines

### ■ Observing Precautions for Use







When putting the selected safety device to actual use, heed the specifications and precautions in this Operation Manual and those in the Instruction Manual that comes with the product. Using the product in a manner that deviates from these specifications and precautions will lead to unexpected failures in equipment or devices, and to damages that result from such failures, due to insufficient operating functions in safety-related components.

### ■ Moving or Transferring Devices or Equipment

When moving or transferring devices or equipment, be sure to include this Operation Manual to ensure that the person to whom the device or equipment is being moved or transferred will be able to operate it properly.

- Typical related international standards: ISO/DIS 12100 ISO, Safety of Machinery -- Basic Concepts and General Principles for Design IEC 61508, Safety Standard for Safety Instrumented Systems (Functional Safety of Electrical/Electronic/Programmable Electronic Safety-related Systems)

### 3 Safety Precautions

 <b>WARNING</b>	
<p><b> Serious injury may possibly occur due to loss of required safety functions. Do not use test outputs of the DST1 as any safety outputs.</b></p>	
<p><b> Serious injury may possibly occur due to loss of required safety functions. Do not use DeviceNet standard I/O data or Explicit message data as any safety data.</b></p>	
<p><b> Serious injury may possibly occur due to loss of required safety functions. Do not use LEDs on the DST1 for safety operations.</b></p>	
<p><b> Serious injury may possibly occur due to breakdown of safety outputs or test outputs. Do not connect loads beyond the rated value to the safety outputs and test outputs.</b></p>	
<p><b> Serious injury may possibly occur due to loss of required safety functions. Wire the DST1 properly so that 24-VDC line do NOT touch the safety outputs accidentally or unintentionally.</b></p>	
<p><b> Serious injury may possibly occur due to loss of required safety functions. Ground the 0V line of the power supply for external output devices so that the devices do Not turn ON when the safety output line or the test output line is grounded.</b></p>	

**! WARNING**

For the DST1-MRD08SL-1, isolating transformers, such as TR1, that are used to isolate between overvoltage categories III and II must conform to IEC60742, and the insulation between the primary input and secondary output must satisfy at least the basic insulation standards of overvoltage category III. One side of the secondary output of the isolating transformer must be grounded to prevent electrical shock in case of short-circuiting to the ground or to the frame of the isolating transformer. To protect the isolating transformer and to prevent electrical shock in case of short-circuiting to the frame, insert fuses according to transformer specifications, i.e., at points F1, F2, and F3.

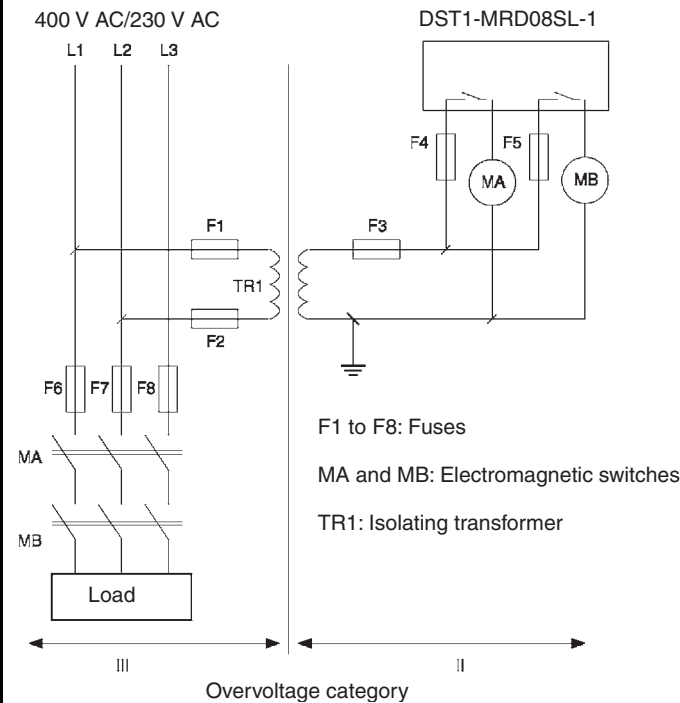

**Serious injury may possibly occur due to loss of required safety functions. Clear the previous configuration data before connecting devices to the network.**



**Serious injury may possibly occur due to loss of required safety functions. Set suitable node addresses before connecting devices to the network.**



**Serious injury may possibly occur due to loss of required safety functions. Perform user testing and confirm that all device configuration data and operations are correct before starting system operation.**



**Serious injury may possibly occur due to loss of required safety functions. When replacing a device, configure the replacement device appropriately and confirm that it operates correctly.**



**For Model DST1-MRD08SL-1, insert a fuse rated at 3.15 A or less for each output terminal to protect safety output contacts from welding. Confirm the fuse selection with the fuse manufacturer to ensure the dependability of the characteristics of the connected load.**



**Serious injury may possibly occur due to loss of safety functions. Use appropriate devices according to the requirements given in the following table.**



Control device	Requirements
Emergency stop switches	Use approved switches with a direct opening mechanism complying with IEC/EN 60947-5-1.
Door interlocking switches Limit switches	Use approved switches with a direct opening mechanism complying with IEC/EN 60947-5-1 and capable of switching micro-loads of 4 mA at 24 V DC.
Safety sensors	Use approved sensors complying with the relevant product standards, regulations, and rules in the country where it is used.
Relays with forcibly guided contacts Contactors	Use approved relays with forcibly guided contacts complying with EN 50205. For feedback purpose, use devices with contacts capable of switching micro-loads of 4 mA at 24 V DC.
Other devices	Evaluate whether devices used are appropriate to satisfy the requirements of safety category.

## 4 Operating Environment Precautions

### ■ Handle with Care

Do not drop the DST1 to the ground or excessive vibration or mechanical shocks. The DST1 may be damaged and may not function properly.

### ■ Installation and Storage Environment

Do not use or store the DST1 in any of the following locations.

- Locations subject to direct sunlight
- Locations subject to temperatures or humidity outside the range specified in the specifications
- Locations subject to condensation as the result of severe changes in temperature
- Locations subject to corrosive or flammable gases
- Locations subject to dust (especially iron dust) or salts
- Locations subject to water, oil, or chemicals
- Locations subject to shock or vibration

Take appropriate and sufficient countermeasures when installing systems in the following locations. Inappropriate and insufficient measures may result in malfunction.

- Locations subject to static electricity or other forms of noise
- Locations subject to strong electromagnetic fields
- Locations subject to possible exposure to radioactivity
- Locations close to power supplies

This is a class A product. In residential areas it may cause radio interference, in which case the user may be required to take adequate measures to reduce interference.

### ■ Installation/Mounting

- Use the DST1 within an enclosure with IP54 protection or higher of IEC/EN 60529.
- Use DIN rail (TH35-7.5 according to IEC60715) for placing the DST1 into the control board.
- Mount the DST1 to DIN rails with attachments (TYPE PFP-M, not incorporated to this product), not to drop out of rails by vibration etc.
- Spacing should be available around the DST1 at least 50 mm from its top and bottom surfaces for ventilation and wiring.

**■ Installation/Wiring**

- Use the following to wire external I/O devices to the DST1.

Solid wire	0.2 to 2.5 mm <sup>2</sup> AWG 24 to 12
Standard (Flexible) wire	0.34 to 1.5 mm <sup>2</sup> AWG 22 to 16

- Disconnect the DST1 from power supply when wiring. Devices connected to DST1 may operate unexpectedly.
- Properly apply the specified voltage and current to the DST1 inputs. Connecting a DC power supply that exceeds the ratings, connecting any AC power supply, or applying any current that exceeds the specified I/O power supply current to the I/O terminals may result in failure of the specified functions, may diminish safety functions, or may damage the DST1 (including burning damage).
- Do not wire any other Units or external devices from the I/O power supply terminals of the DST1.
- Be sure to separate the communication cable and the I/O cable from the high-voltage/ current lines.
- Be careful not to catch your fingers when attaching connectors to the plugs on the DST1.
- Mount the screws on DeviceNet Connectors and I/O Connectors correctly (0.25 to 0.3 N·m).
- Incorrect wiring may lead to loss of safety function. Wire conductors correctly and verify the operation of the DST1 before commissioning the system in which DST1 is incorporated.
- After wiring is completed, be sure to remove label for wire clipping prevention on the DST1 to enable heat to escape for proper cooling.

**■ Power Supply Selection**

Use a DC power supply that satisfies the following requirements.

- The secondary circuits of the DC power supply must be isolated from its primary circuit by double insulation or reinforced insulation.
- The DC power supply must satisfy the requirements of class 2 circuits or limited voltage/current circuit stated in UL 508.
- The output hold time must be 20 ms or longer.
- The DC power supply must satisfy the SELV requirements given in IEC/EN 60950-1 or EN 50178.

**■ Periodical Inspection and Maintenance**

- Disconnect the DST1 from power supply when replacing it. Devices connected to the DST1 may operate unexpectedly.
- Do not dismantle, repair, or modify the DST1. It may lead to loss of its safety functions.

**■ Disposal**

- Be careful not to get injured when dismantling the DST1.

## 5 Additional Precautions According to UL 1604

DST1-ID12SL-1 and DST1-MD16SL-1 are suitable for use in Class I, Div. 2, Group A, B, C, D or Non-Hazardous Location Only.

WARNING - Explosion Hazard - Substitution of Components May Impair Suitability For Class I, Div. 2.

WARNING - Explosion Hazard - Do not Disconnect Equipment Unless Power Has Been Switched Off Or The Area Is Known To Be Non-Hazardous.

## 6 Regulation and Standards

The DST1 Series has received the following certifications.

Certifying organization	Standards
TÜV Rheinland	IEC 61508 Part 1-7/12.98-05.00 EN 954-1: 1996 ISO 13849-1: 2006 EN/ISO 13849-2: 2003 IEC 61131-2: 2007 EN 60204-1: 2006 EN 61000-6-2: 2005 EN 61000-6-4: 2007 EN/ISO 13850: 2006 (EN 418: 1992) NFPA 79-2007 ANSI RIA15.06-1999, ANSI B11.19-2003
UL (See note.)	UL 1998 UL 508 UL 1604 (except for DST1-MRD08SL-1) NFPA 79 IEC 61508 CSA 22.2 No. 142 CSA 22.2 No. 213 (except for DST1-MRD08SL-1)

## 7 Glossary

Term	Description
idle data	Data sent when the originating application is in an inexecutable state.
assembly	Internal data in a device gathered as one group to be accessed externally.
safety data	Data with high reliability.
error latch time	The time period to hold an error state (control data, status data, and LED indications).
open type	The open method for Safety Connection. One of three types is selected in the settings of a connection to the Safety Master.
connection	A logical communications path used to communicate between devices.
configuration	The settings for a device and a network.
single channel	Using only one input or output as the input or output.
standard	A device or device function to which safety measures are not applied.
safety controller (safety PLC)	A controller with high reliability used for the safety control.
safety chain	The logical chain to actualize a safety function, that consists of the input device (sensor), the control device (including a remote I/O device), and the output device (actuator).
safety protocol	The communications hierarchy added to actualize highly reliable communications.
safety signature	A certificate of the configuration data issued to a device from the Network Configurator. The device verifies that the configuration data is correct by using the safety signature.
test pulse	A signal used to detect external wiring coming into contact with the power supply (positive) or short circuits between signal lines.
dual channel	Using two inputs or outputs as the input or output for redundancy.
Dual Channel Complementary	Setting to evaluate that two logic states are complementary.
Dual Channel Equivalent	Setting to evaluate that two logic states are equivalent.
Busoff	Status that occurs when the error rate is extremely high over a communications cable. An error is detected when the internal error counter exceeds a certain threshold value. (The internal error counter is cleared when it is started or restarted.)
DeviceNet Safety	A safety network that adds a safety protocol to DeviceNet to comply with IEC61508 SIL3, EN954-1 Safety Category 4.
discrepancy time	The time period from a change in one of two inputs until the other input changes.
EPI	The interval of safety data communications between the Safety Master and the Safety Slave.
multi-cast connection	Safety I/O communications in a 1:n configuration (n = 1 to 15).
single-cast connection	Safety I/O communications in 1:1 configuration.
TUNID	The UNID of the local node. Usually the TUNID is set from the Network Configurator.
UNID	A identifier to specify one device in all the network domains. Values combining the network address and the node address are used.



# SECTION 1

## Overview

1-1	Overview . . . . .	2
1-1-1	About the DST1-series Safety I/O Terminals . . . . .	2
1-1-2	DST1-series Safety I/O Terminals Features . . . . .	3
1-2	Standard Models . . . . .	5
1-2-1	Input Terminals and I/O Terminals . . . . .	5
1-2-2	Logic Terminals . . . . .	5
1-3	Functions . . . . .	6
1-3-1	Functions Supported by All DST1-series Terminals . . . . .	6
1-3-2	Input Terminals and I/O Terminals . . . . .	7
1-3-3	Logic Terminals . . . . .	8
1-4	Description of Safety Functions . . . . .	9
1-4-1	DST1-series Safety I/O Terminals . . . . .	9
1-4-2	Safety Inputs . . . . .	10
1-4-3	Safety Outputs . . . . .	15
1-4-4	I/O Status Data . . . . .	16
1-5	Logic Functions . . . . .	17
1-5-1	Overview . . . . .	17
1-5-2	Restrictions on the DST1-XD0808SL-1 . . . . .	17
1-5-3	Parameters That Can Be Set . . . . .	18
1-6	Monitoring Functions . . . . .	21
1-6-1	Monitoring Status . . . . .	21
1-6-2	Monitoring Parameters . . . . .	23
1-6-3	Monitoring the Error History . . . . .	25
1-7	Maintenance Functions of DST1-series Safety I/O Terminals . . . . .	27
1-7-1	Network Power Supply Voltage Monitor . . . . .	27
1-7-2	Monitoring the Run Hours . . . . .	29
1-7-3	Last Maintenance Date . . . . .	32
1-7-4	Monitoring the Contact Operation Counters . . . . .	34
1-7-5	Monitoring the Total ON Times . . . . .	37
1-7-6	Monitoring the Operation Time . . . . .	41

# 1-1 Overview

## 1-1-1 About the DST1-series Safety I/O Terminals

The DST1-series Safety I/O Terminals support the DeviceNet Safety protocol and provide various functions for the Safety System. The DST1-series Safety I/O Terminals allow the user to construct a safety control/network system that meets the requirements for Safety Integrity Level (SIL) 3 according to IEC 61508 (Functional Safety of Electrical/Electronic/ Programmable Electronic Safety-related Systems) and the requirements for Safety Category 4 according to EN 954-1.

The DST1-series Safety I/O Terminal's safety I/O data is transmitted through safety I/O communications conforming to the DeviceNet Safety Protocol, and the data processing is performed in conducted in the Safety Network Controller (NE1A-SCPU01).

Also, the status of the safety I/O data can be monitored in a standard PLC in an existing DeviceNet network using standard I/O communications or explicit message communications.

The DST1-XD0808SL-1 Logic Terminal has built-in logic functions. This enables direct control of local outputs from local inputs, allowing reaction time to be shortened.

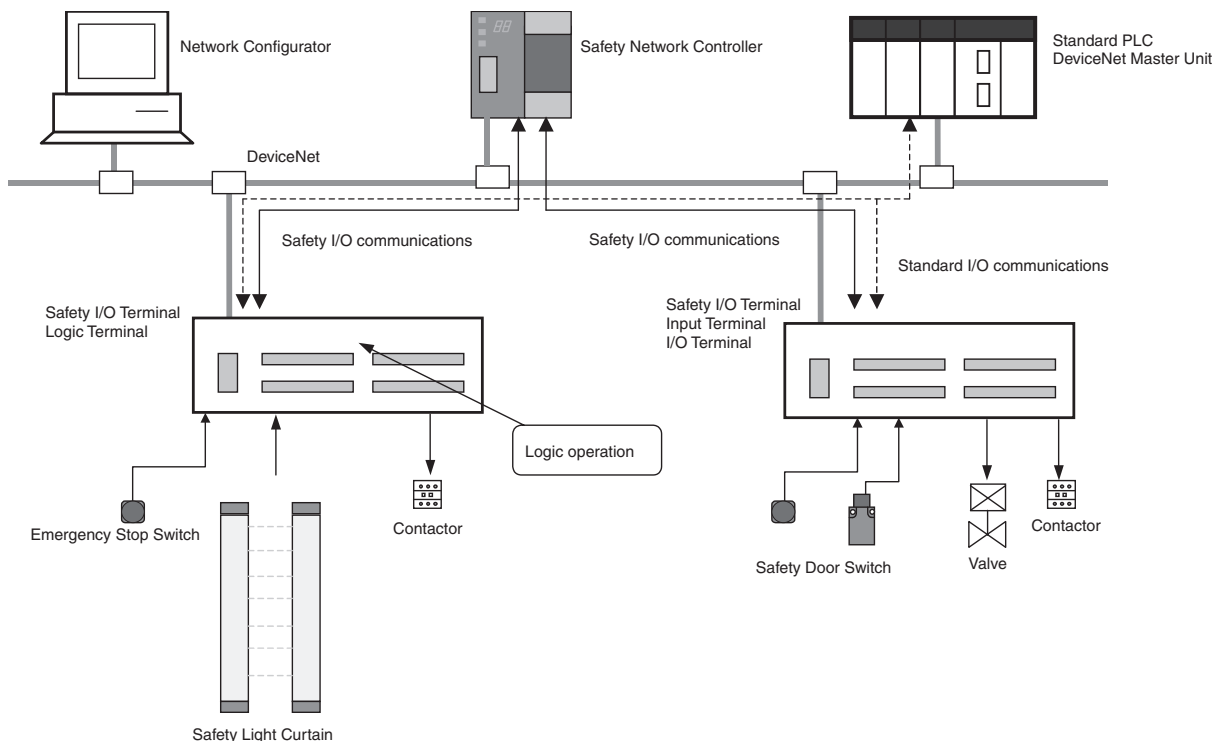

## 1-1-2 DST1-series Safety I/O Terminals Features

### Safety Inputs

- Semiconductor output devices such light curtains can be connected as well as contact output devices such as emergency stop switches.
- Faults in external wiring can be detected.
- Input delays (ON delays and OFF delays) can be set.
- Pairs of related local inputs can be set to Dual Channel Mode in order to be compliant with the Category 4 standards.  
When Dual Channel Mode is set, the input data patterns and the time discrepancy between input signals can be evaluated.

### Test Outputs

- 4 independent test outputs are available to use.
- A disconnected external indicator lamp can be detected. (Can be set for the T3 Terminal only.)
- Test outputs can be used as power supply terminals to devices such as sensors.
- Test outputs can be used as the standard output terminals for monitor outputs.

### Safety Outputs

#### ■ Semiconductor Outputs

- Pairs of related local outputs can be set to Dual Channel Mode in order to be compliant with the Category 4 standards.  
When Dual Channel Mode is set, the output data patterns can be evaluated.
- The rated output current is 0.5 A max. per output.

#### ■ Relay Outputs

- Pairs of related output terminals can be set to Dual Channel Mode in order to be compliant with the Category 4 standards.  
When Dual Channel Mode is set, the output data patterns can be evaluated.
- The rated output current is 2 A max. per output.
- The safety relays can be replaced.

### DeviceNet Safety Communications

As a Safety Slave, a DST1-series Safety I/O Terminal can perform safety I/O communications on up to four connections (or up to two connections for the DST1-XD0808SL-1).

### DeviceNet Standard Communications

As a Standard Slave, the DST1-series Safety I/O Terminals can perform standard I/O communications with one Standard Master with up to two connections.

**System Startup and Error Recovery Support**

- Error information can be checked by using the error log function or the indicators on the front of the DST1-series Safety I/O Terminals.
- The DST1-series Safety I/O Terminal's safety I/O data and internal status information can be monitored from a Standard PLC by allocating the information in the standard Master. In the same way, the information can be monitored from a safety PLC by allocating the information in the Safety Master.

**Access Control with a Password**

The DST1-series Safety I/O Terminals configuration data is protected by a password.

**I/O Connector Connection/Disconnection**

- The I/O Connector can be connected and disconnected.
- The I/O Connector is structured to prevent incorrect connection.

**Cage Clamp Wiring**

Cables can be wired without terminal screws.

**Maintenance Functions**

The DST1-series Safety I/O Terminals are equipped with maintenance functions, such as a contact operation counter and cumulative ON time monitor.

**Logic Functions (DST1-XD0808SL-1 Only)**

- The DST1-XD0808SL-1 Logic Terminal is provided with basic logic parameters, such as AND and OR.
- This enables direct control of DST1-XD0808SL-1 local outputs from local inputs without involving NE1A safety logic.

## 1-2 Standard Models

As shown in the following tables, the DST1 Series consists of Input Terminals, I/O Terminals, and Logic Terminals.

### 1-2-1 Input Terminals and I/O Terminals

Model	I/O capacity			
	Safety inputs	Test outputs	Safety outputs	
			Semiconductor outputs	Relay outputs
DST1-ID12SL-1	12 inputs	4 outputs (See note.)	-	-
DST1-MD16SL-1	8 inputs	4 outputs (See note.)	8 outputs	-
DST1-MRD08SL-1	4 inputs	4 outputs (See note.)	-	4 outputs

**Note** Each test output can be set to function as a test output or a standard output. Test outputs are used in combination with a safety input. Broken wires in an external indicator can be detected for terminal T3 only.

### 1-2-2 Logic Terminals

Model	I/O capacity			
	Safety inputs	Test outputs	Safety outputs	
			Semiconductor outputs	Relay outputs
DST1-XD0808SL-1	8 inputs	4 outputs (See note 1.)	8 outputs	-

**Note**

- (1) Each test output can be set to function as a test output or a standard output. Test outputs are used in combination with a safety input. Broken wires in an external indicator can be detected for terminal T3 only.
- (2) Use Network Configurator version 2.0 or higher to set the DST1-XD0808SL-1.

# 1-3 Functions

## 1-3-1 Functions Supported by All DST1-series Terminals

Function	Description	Reference
Safety I/O		
Safety inputs	The DST1-ID12SL-1 supports 12 safety inputs. The DST1-MD16SL-1 supports 8 safety inputs. The DST1-MRD08SL-1 supports 4 safety inputs. The DST1-XD0808SL-1 supports 8 safety inputs.	1-4 Description of Safety Functions SECTION 5 DST1 Series Specifications
Input circuit diagnosis	Diagnoses internal circuits and external devices and wiring using test pulses.	
Input delays (ON or OFF)	The input time constant can be set from 0 to 126 ms in units of 6 ms. This function can be used to reduce the effects of chattering and external noise.	
Dual channel evaluation	Dual channel evaluation can be used to evaluate the discrepancy time between two associated local input data items or input signals.	
Test outputs	Four independent test outputs are supported. Test outputs are used in combination with safety inputs. Depending on the settings, they can also be used as signal output terminals.	1-4 Description of Safety Functions SECTION 5 DST1 Series Specifications
Broken wire detection (terminal T3 only)	Broken wires can be detected for terminal T3.	
Overcurrent detection and protection	When an overcurrent is detected, the output is turned OFF to protect the circuit.	
Safety outputs	The DST1-MD16SL-1 supports 8 safety outputs. The DST1-MRD08SL-1 supports 4 safety outputs. The DST1-XD0808SL-1 supports 8 safety outputs.	1-4 Description of Safety Functions SECTION 5 DST1 Series Specifications
Output circuit diagnosis (See note.)	Diagnoses internal circuits and external devices and wiring according to test pulses.	
Overcurrent detection and protection (See note.)	When an overcurrent is detected, the output is turned OFF to protect the circuit.	
Dual channel evaluation	When an error occurs at one of two associated local outputs, the dual channel evaluation sets the two outputs to the safe state without relying on a user program.	
DeviceNet Communications		
Safety Slaves	DST1-series Terminals can be operated as DeviceNet Safety Slaves. Not only specified I/O areas, but also internal status information can be assigned in Safety Masters.	SECTION 3 Configuration
Standard Slaves	DST1-series Terminals can be operated as Standard Slaves. Not only specified I/O areas, but also internal status information can be assigned in Standard Masters.	SECTION 3 Configuration
Explicit message communications	Internal status information can be read by using a service for explicit messages.	Appendix 1: DeviceNet Explicit Messages
Automatic baud rate detection	The baud rate is automatically set to the baud rate of the network.	-
System Startup and Error Recovery Support		
Error history	Internally saves information on errors that are detected.	7-3 Error History
Online monitoring	Internal status information and I/O data can be read using the Network Configurator.	1-6 Monitoring Functions

Function	Description	Reference
Other Functions		
Configuration lock	After configuration data has been downloaded and verified, the configuration data that has been saved internally can be locked.	Section 3 in <i>DeviceNet Safety System Configuration Manual</i> (Cat. No. Z905)
Reset	DST1-series Terminals can be reset using a service from the Network Configurator.	
Password	A password can be set to prevent the DST1-series Terminal from being accessed unintentionally.	

**Note** Except for the DST1-MRD08SL-1.

### 1-3-2 Input Terminals and I/O Terminals

The following functions are provided by the DST1-ID12SL-1, DST1-MD16SL-1, and DST1-MRD08SL-1.

Function	Description	Reference
Maintenance		
Network power supply voltage monitor	The present, bottom, and peak values for the network power supply voltage can be recorded in the DST1-series Terminal.	1-7 <i>Maintenance Functions of DST1-series Safety I/O Terminals</i>
Unit conduction time monitor	The total ON time (unit: 0.1 h) of the internal circuit power can be calculated and recorded in the DST1-series Terminal.	
Unit name	The user can record a name or comment for each DST1-series Terminal, using up to 32 characters.	
I/O comments	The user can record a name or comment for each I/O terminal, using up to 32 characters.	
Last maintenance date	The date on which maintenance was last performed can be written in the DST1-series Terminal.	
I/O power status monitor	Can be used to check whether the I/O power is ON.	
Contact operation counters	Can be used to count the number of times each input or output contact changes from OFF to ON (maximum resolution of 50 Hz) and to record the total in the DST1-series Terminal.	
Total ON time monitor	Can be used to calculate the total ON time for each input or output contact (unit: s) and to record the total in the DST1-series Terminal.	
Operation time monitor	Can be used to measure the time from when an output contact turns OFF until an input contact turns OFF (unit: ms) and to record the time in the DST1-series Terminal.	

### 1-3-3 Logic Terminals

These functions are provided by the DST1-XD0808SL-1.

Function	Description	Reference
Logic Functions		
Logic functions	The DST1-XD0808SL-1 provides basic logic parameters, such as AND and OR. This enables direct control of local outputs from local inputs, reducing reaction time.	1-5 Logic Functions
Safety I/O		
Output ON/OFF delays	The output time constant can be set from 0 to 300,000 ms, in increments of 100 ms.	1-5 Logic Functions
Additional output setting	Any of the following outputs can be set: Same or inverse values for safety output terminal and another safety output, output indicating operating mode, output indicating normal status, and reset request outputs.	
Maintenance		
Network power voltage monitor	The present, bottom, and peak values for the network power supply voltage can be recorded in the DST1-series Terminal.	1-7 Maintenance Functions of DST1-series Safety I/O Terminals
Unit conduction time monitor	The total ON time (unit: 0.1 h) of the internal circuit power can be calculated and recorded in the DST1-series Terminal.	
Unit name	The user can record a name or comment for each DST1-series Terminal, using up to 32 characters.	
I/O comments	The user can record a name or comment for each I/O terminal, using up to 32 characters.	
Last maintenance date	The date on which maintenance was last performed can be written in the DST1-series Terminal.	
I/O power status monitor	Can be used to check whether the I/O power is ON.	
Contact operation counters (See note.)	Can be used to count the number of times each input or output contact changes from OFF to ON (maximum resolution of 50 Hz) and to record the total in the DST1-series Terminal.	
Total ON time monitor (See note.)	Can be used to calculate the total ON time for each input or output contact (unit: s) and to record the total in the DST1-series Terminal.	

**Note** Not including test output terminals.



## 1-4 Description of Safety Functions

### 1-4-1 DST1-series Safety I/O Terminals

#### Safe State

The following status is treated as the safe state by the DST1-series Safety I/O Terminals.

- Safety outputs: OFF
- Output data to network: OFF

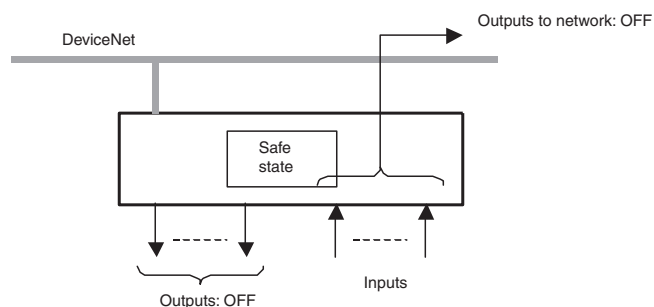

Therefore, the DST1-series Safety I/O Terminals must be used for applications in which it enters into safe state when the safety outputs turn OFF and the output data to the network turns OFF.

#### Self-diagnosis Functions

Self-diagnosis is performed when the power is turned ON and periodically during operation. If an error occurs, it will be treated as a fatal error (the MS indicator will light in red), and the safety outputs and output data to the network will turn OFF.

#### Access Control by Password

After configuration data had been downloaded and verified, the configuration data within the DST1-series Safety I/O Terminals can be protected by a password.

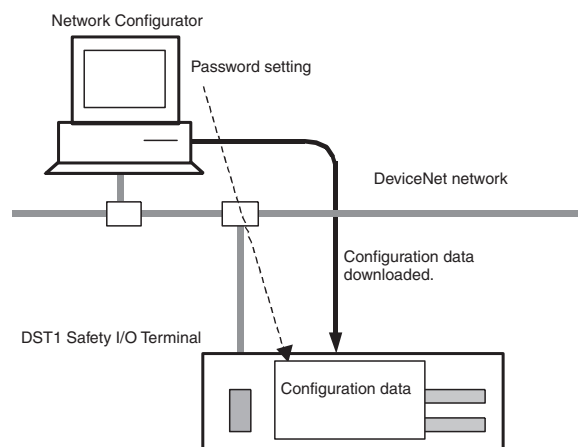

**Note** Refer to the *System Configuration Manual* (Cat. No. Z905) for password setting.

## 1-4-2 Safety Inputs

### Safety Inputs with Test Pulses (Input Circuit Diagnosis)

A test output is used in combination with a safety input. Specify the corresponding test output terminal to use as the test source. The test output terminal is used as a power supply to connect an external input device to the safety input terminal.

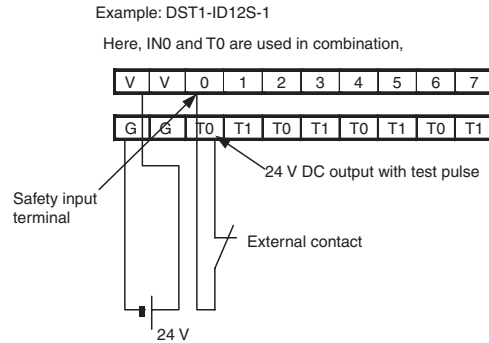

A test pulse is output from the test output terminal to diagnose the internal circuit when the external input contact turns ON. Using this function, short-circuits between input signal lines and the power supply (positive side), and short-circuits between input signal lines can be detected.

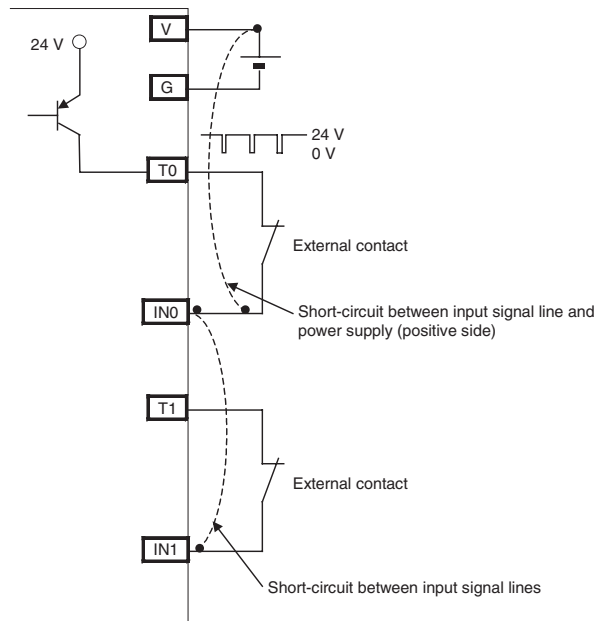

If an error is detected, safety input data and individual safety input status will turn OFF.

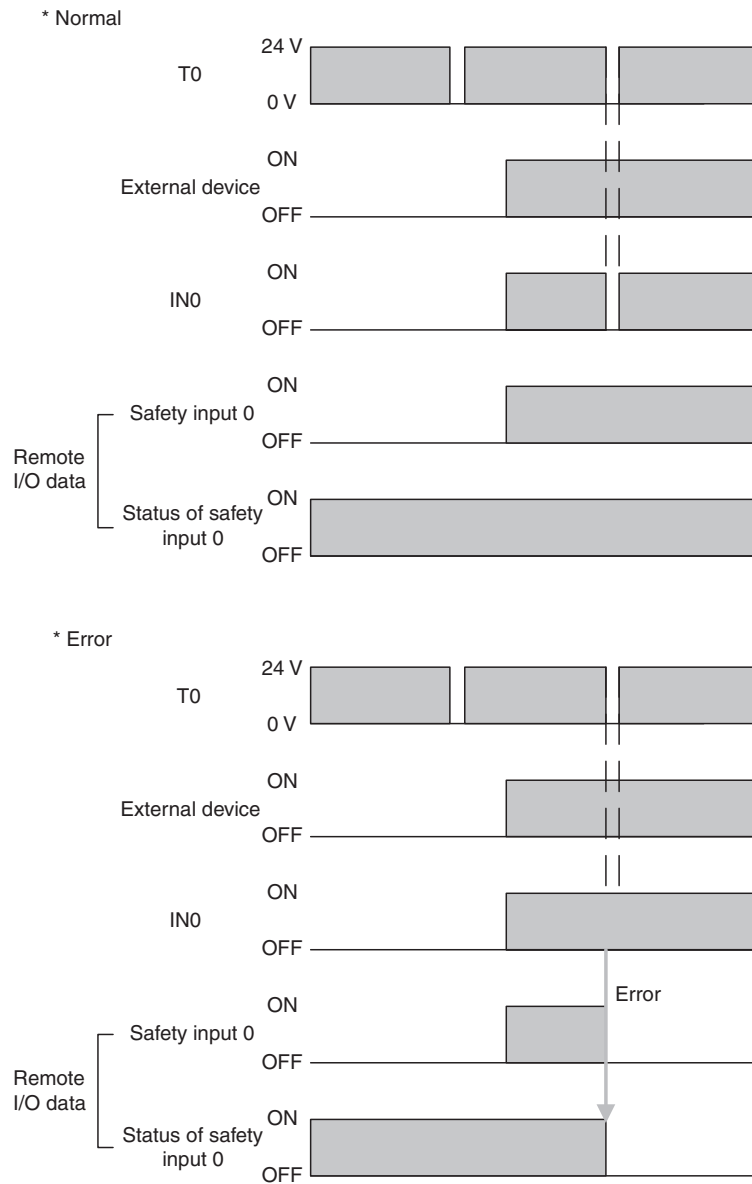

### Setting Dual Channel Mode and Discrepancy Time

The consistency between signals on two channels can be evaluated. Either of the following settings can be selected. This function monitors the time during which there is a discrepancy in the logic between the two channels set as dual channels. If the length of the discrepancy exceeds the set discrepancy time (0 to 65,530 ms, in increments of 10 ms), the safety input data and the individual safety input status will turn OFF for both inputs.

**IMPORTANT** The dual channel function is used with 2 consecutive inputs that start from even input numbers: inputs 0 and 1, inputs 2 and 3, inputs 4 and 5, etc.

The following table shows the relation between terminal input and remote I/O data.

Dual channel mode	Input terminals		Remote I/O data		Meaning of data
	IN0	IN1	Safety input 0	Safety input 1	
Dual Channel Equivalent	0	0	0	0	OFF
	0	1	0	0	OFF
	1	0	0	0	OFF
	1	1	1	1	ON
Dual Channel Complementary	0	0	0	1	OFF
	0	1	0	1	OFF
	1	0	1	0	ON
	1	1	0	1	OFF

Dual Channels, Equivalent

The status is treated as normal when both channels are ON or OFF. If one channel is ON and the other channel is OFF, it will be treated as an error, and the safety input data and the individual safety input status will turn OFF for both inputs.

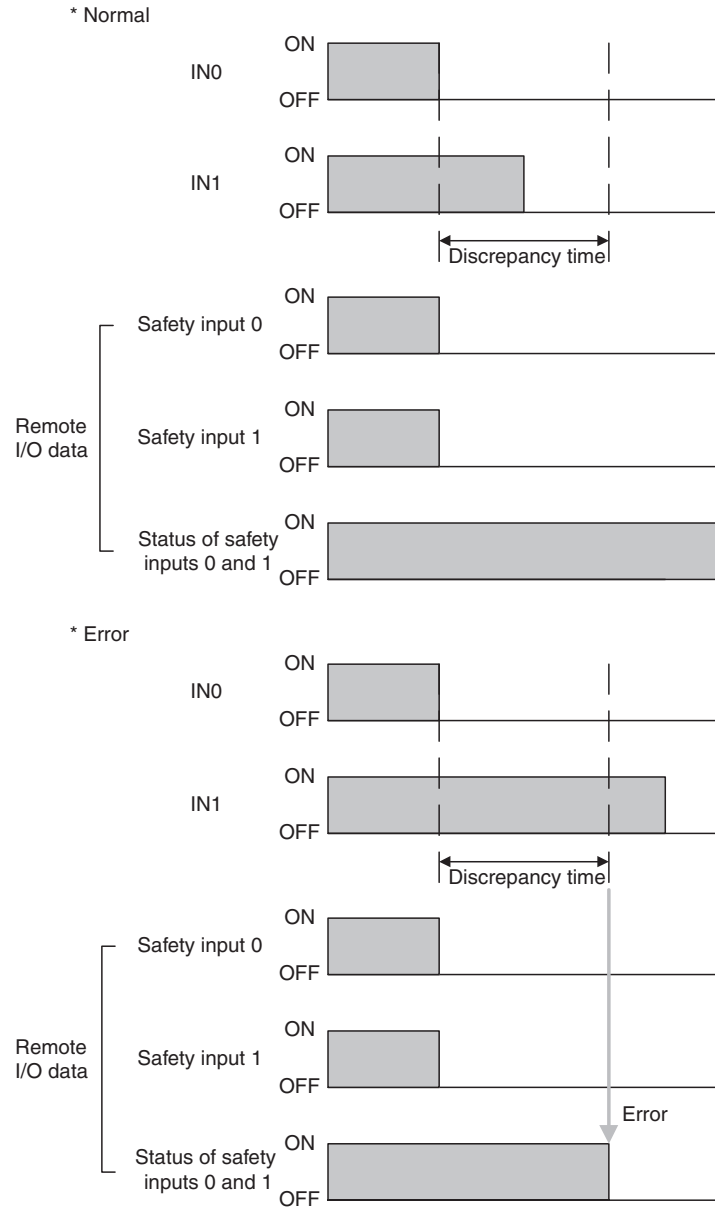

**Dual Channels, Complementary**

The status is treated as normal when one channel is ON and the other channel is OFF. When both channels are ON or both channels are OFF, it is treated as an error, and the safety input data and the individual safety input status will turn OFF for both inputs.

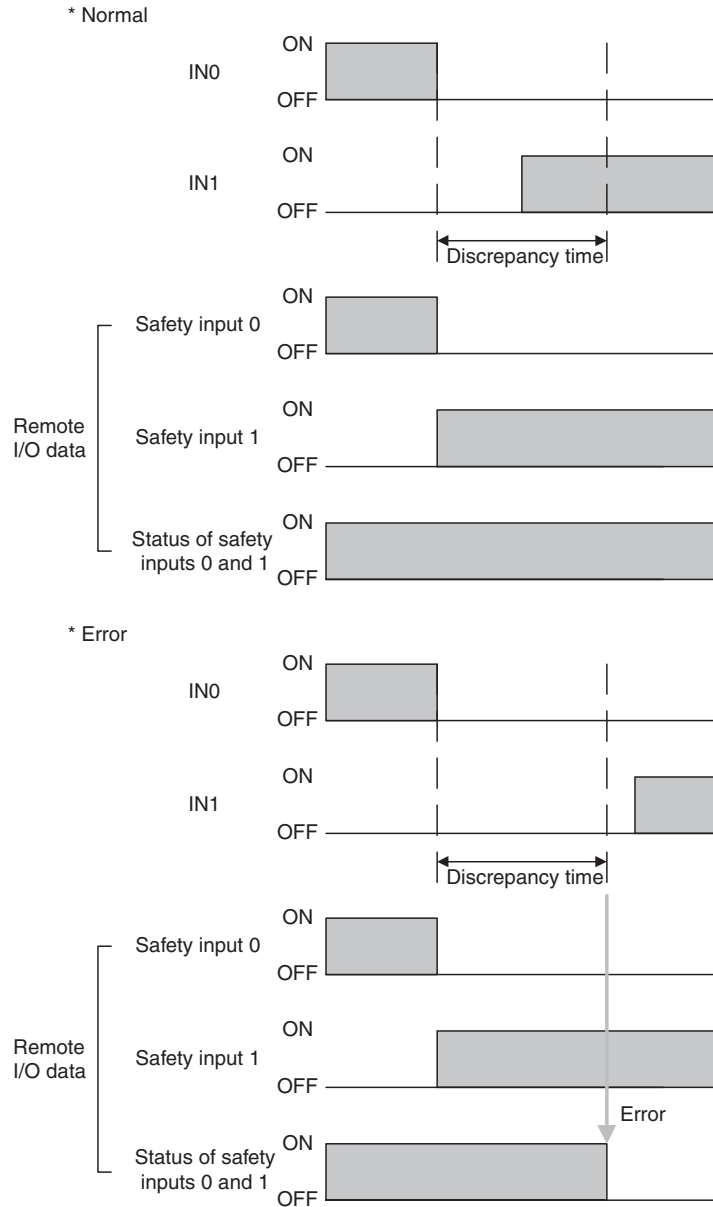

**Error Recovery**

All conditions below are necessary to recover from an error that has occurred in a safety input.

- The cause of the error must be removed.
- The error latch time must have passed.
- The input signal must return to an inactive state and there must be no error condition detected. (e.g., by pressing the emergency stop switch or opening a door)

### Input Delays

#### ON Delay

An input signal is treated as being OFF during the ON delay setting time (0 to 126 ms, in increments of 6 ms) after the input contact's rising edge. The input will turn ON only if the input contact remains ON after the ON delay time has elapsed. This helps prevent chattering of the input contacts.

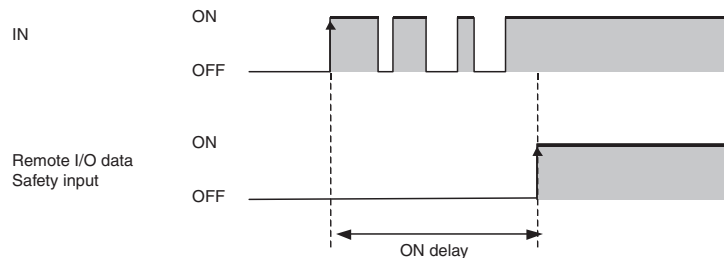

#### OFF Delay

An input signal is treated as being ON during the OFF delay setting time (0 to 126 ms, in increments of 6 ms) after the input contact's falling edge. The input will turn OFF only if the input contact remains OFF after the OFF delay time has elapsed. This helps prevent chattering of the input contacts.

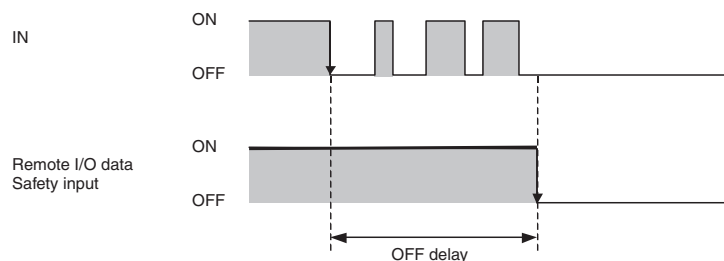

### 1-4-3 Safety Outputs

#### Safety Outputs with Test Pulses (Output Circuit Diagnosis)

When the output is ON, the test pulse is turned OFF for 580  $\mu$ s in a cycle of 648 ms. Using this function, short-circuits between output signal lines and the power supply (positive side) and short-circuits between output signal lines can be detected.

If an error is detected, the safety output data and the individual safety output status will turn OFF.

**IMPORTANT** To prevent the test pulse from causing the connected device to malfunction, pay careful attention to the input response time of the device.

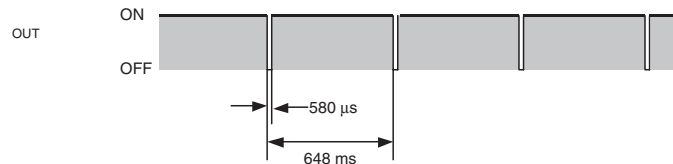

#### Dual Channel Setting

When both channels are normal, the outputs can be turned ON.

The status is treated as normal when both channels are normal. If an error is detected for one channel, the safety output data and the individual safety output status will turn OFF for both channels.

\* Normal



\* Error

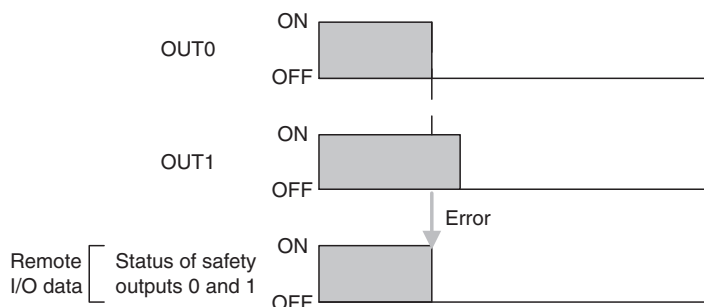

## **Error Recovery**

All conditions below are necessary to recover from an error that has occurred in a safety output.

- The cause of the error must be removed.
- Error latch time must have passed.
- The output signals to the output I/O tags from the user application that correspond to the safety output must go inactive.

### **1-4-4 I/O Status Data**

In addition to I/O data, the DST1-series Safety I/O Terminals support status data to check the I/O circuits. The status data includes the following data, for which remote I/O communications can be performed.

- Normal Flags (ON when there is no faults in the internal circuit and the external wiring)
- An AND Flag of the Normal Flags
- Output monitors (the actual output ON/OFF status)

### **Normal Flags**

Normal Flags indicates whether each safety input, safety output, or test output is normal (normal status: ON, error status: OFF).



**Output Monitors**

The outputs monitors indicated the actual ON/OFF status of the safety outputs.

**1-5 Logic Functions**

The DST1-XD0808SL-1 supports logic functions.

**1-5-1 Overview**

Safety logic control can be easily performed by setting a combination of I/O data from local I/O terminals and remote I/O data from a Standard Master or Safety Master with the logic operations supported by the DST1-XD0808SL-1. In addition, the safety status can be monitored from standard controls by using the safety output terminals as additional outputs and outputting data such as error information.

- Note**
- (1) Refer to the *NE0A Series Safety Network Controller Operation Manual* (Cat. No. Z916) for details on functions and setting methods.
  - (2) Some NE0A-SCPU01 functions are not supported by the DST1-XD0808SL1. Refer to *1-5-2 Restrictions on the DST1-XD0808SL-1* for details

**1-5-2 Restrictions on the DST1-XD0808SL-1**

NE0A Series Safety Network Controller Operation Manual		Restrictions on the DST1-XD0808SL-1
Section	Item	
6-3-1	Starting the Safety Wizard	Network settings cannot be made.
6-3-4	Setting Networks	Network settings cannot be made.
6-4-1	Safety Input Evaluation	Enable switches cannot be set.
		User mode switches cannot be set.
		Input ON-delay and OFF-delay times must be set from 0 to 126 ms (in 6-ms increments).
6-4-2	Input Condition Operations	Refer to <i>1-5-3 Parameters That Can Be Set</i> for the input condition signals that can be set.
6-4-3	Reset Operation	Refer to <i>1-5-3 Parameters That Can Be Set</i> for the reset condition signals that can be set.
6-4-4	Output Condition Operations	Refer to <i>1-5-3 Parameters That Can Be Set</i> for the output condition signals that can be set.
6-4-5	Welding Check (EDM: External Device Monitoring) Operation	Refer to <i>1-5-3 Parameters That Can Be Set</i> for the feedback signals that can be set.
6-4-6	Safety Output Evaluation	Refer to <i>1-5-3 Parameters That Can Be Set</i> for the additional outputs that can be set.

### 1-5-3 Parameters That Can Be Set

#### Data That Can Be Set for Input Condition Signals ... --

Name	Option	Setting range
Input condition signal	Remote I/O	Remote safety I/O data (received from Safety Master through the network)
	Input 0 to Input 5	Safety input terminals IN0 to IN5

The following data is used for remote I/O data. For details on remote I/O allocations, refer to 3-2-4 I/O Assembly Data.

Bit 7	Bit 6	Bit 5	Bit 4	Bit 3	Bit 2	Bit 1	Bit 0
Reserved for system.		Input condition signal No. 5	Input condition signal No. 4 (4/5)	Input condition signal No. 3	Input condition signal No. 2 (2/3)	Input condition signal No. 1	Input condition signal No. 0 (0/1)

Example 1: IN0 and IN1 Used in Single Channel Mode

IN0 input condition signal: Bit 0 input condition signal 0 (0/1) is used.

IN1 input condition signal: Bit 1 input condition signal 1 is used.

Example 2: IN0 and IN1 Used in Dual Channel Mode

IN0 input condition signal: Bit 0 input condition signal 0 (0/1) is used.

IN1 input condition signal: Not Used.

#### Data That Can Be Set for Reset Signals ... --

Name	Option	Setting range
Reset signal	Remote I/O Low-High-Low	Remote safety I/O data (received from Safety Master or Standard Master through the network) used for a Low-high-Low reset.
	Remote I/O Rising Edge	Remote safety I/O data (received from Safety Master or Standard Master through the network) used for a Rising Edge reset.
	IN6 Low-High-Low	The IN6 terminal is used for a Low-High-Low reset.
	IN6 Rising Edge	The IN6 terminal is used for a Rising Edge reset.
	IN7 Low-High-Low	The IN7 terminal is used for a Low-High-Low reset.
	IN7 Rising Edge	The IN7 terminal is used for a Rising Edge reset.

The following data is used for remote I/O data. For details on remote I/O allocation, refer to 3-2-4 I/O Assembly Data.

Bit 7	Bit 6	Bit 5	Bit 4	Bit 3	Bit 2	Bit 1	Bit 0
Reserved for system.		Reset signal No.5	Reset signal No.4 (4/5)	Reset signal No.3	Reset signal No.2 (2/3)	Reset signal No.1	Reset signal No.0 (0/1)

Example 1: IN0 and IN1 Used in Single Channel Mode

IN0 reset signal: Bit 0 reset signal 0 (0/1) is used.

IN1 reset signal: Bit 1 reset signal 1 is used.

Example 2: IN0 and IN1 Used in Dual Channel Mode

IN0 reset signal: Bit 0 reset signal 0 (0/1) is used.

IN1 reset signal: Setting not required.

Data That Can Be Set for Safety Input Logic Result or Remote I/O ...

Name	Option	Setting range
Output condition signal	Remote I/O	Data received from Safety Master or Standard Master through the network
	IN0 to IN5	Safety input logic operation result

The following data is used for remote I/O data. For details on remote I/O allocations, refer to 3-2-4 I/O Assembly Data.

Bit 7	Bit 6	Bit 5	Bit 4	Bit 3	Bit 2	Bit 1	Bit 0
Safety output terminal 7, output condition signal 7	Safety output terminal 6, output condition signal 6 (6/7)	Safety output terminal 5, output condition signal 5	Safety output terminal 4, output condition signal 4 (4/5)	Safety output terminal 3, output condition signal 3	Safety output terminal 2, output condition signal 2 (2/3)	Safety output terminal 1, output condition signal 1	Safety output terminal 0, output condition signal 0 (0/1)

Or

Bit 7	Bit 6	Bit 5	Bit 4	Bit 3	Bit 2	Bit 1	Bit 0
Output condition signal 7	Output condition signal 6 (6/7)	Output condition signal 5	Output condition signal 4 (4/5)	Output condition signal 3	Output condition signal 2 (2/3)	Output condition signal 1	Output condition signal 0 (0/1)

Example 1: Outputs 0 and 1 Used in Single Channel Mode

Output 0 output condition signal: Bit 0 output condition signal 0 (0/1) is used.

Output 1 output condition signal: Bit 1 output condition signal 1 is used.

Example 2: Outputs 0 and 1 Used in Dual Channel Mode

Output 0 output condition signal: Bit 0 output condition signal 0 (0/1) is used.

Output 1 output condition signal: Setting not required.

Data That Can Be Set for Feedback Signals ...

Name	Option	Setting range
Feedback signal	IN4	Use the IN4 terminal as the feedback input terminal.
	IN5	Use the IN5 terminal as the feedback input terminal.
	IN6	Use the IN6 terminal as the feedback input terminal.
	IN7	Use the IN7 terminal as the feedback input terminal.

## Data That Can Be Set for Additional Outputs

	Additional output data	Description
S	Same value as safety output terminal	Outputs the same value as any safety output terminal.
S	Inverse value of safety output terminal	Outputs the inverse value of any safety output terminal.
	Reset required indication	Outputs a 1-Hz pulsing signal to trigger a reset input. The signal is output when resetting is enabled for one or more terminals from among all the safety input terminals.
	RUN Status Flag	Outputs the operating mode. 0: Not RUN mode 1: RUN mode
	Normal Status Flag	Outputs the status. 0: Error (See note.) 1: Normal

**Note** Turns OFF (0) when one of the errors shown in *7-3 Error History* occurs.

**IMPORTANT** When additional output data is set, safety output terminals will reflect the output status even in Idle Mode.

- Note**
- (1) An additional output can be used only when the output terminals are set as a single channel.
  - (2) An ON delay or OFF delay can be set for safety output terminals even when an additional output is set.

## 1-6 Monitoring Functions

DST1-series Safety I/O Terminals hold a variety of status information internally. This information can be monitored using the Network Configurator.

### 1-6-1 Monitoring Status

#### Description

The status of the DST1-series Safety I/O Terminals can be monitored using the Network Configurator. If an error occurs in a device, detailed information about the error can be accessed.

#### Monitoring Status Using the Network Configurator

The user can monitor the status using any of the following methods:

1. Select a device and select **Device - Monitor** from the menu bar. Click the **Status** Tab in the displayed window.
2. Select a device and click the **Monitor Device** Button on the toolbar. Click the **Status** Tab in the displayed window.
3. Right-click a device and select **Monitor** from the pop-up menu. Click the **Status** Tab in the displayed window.

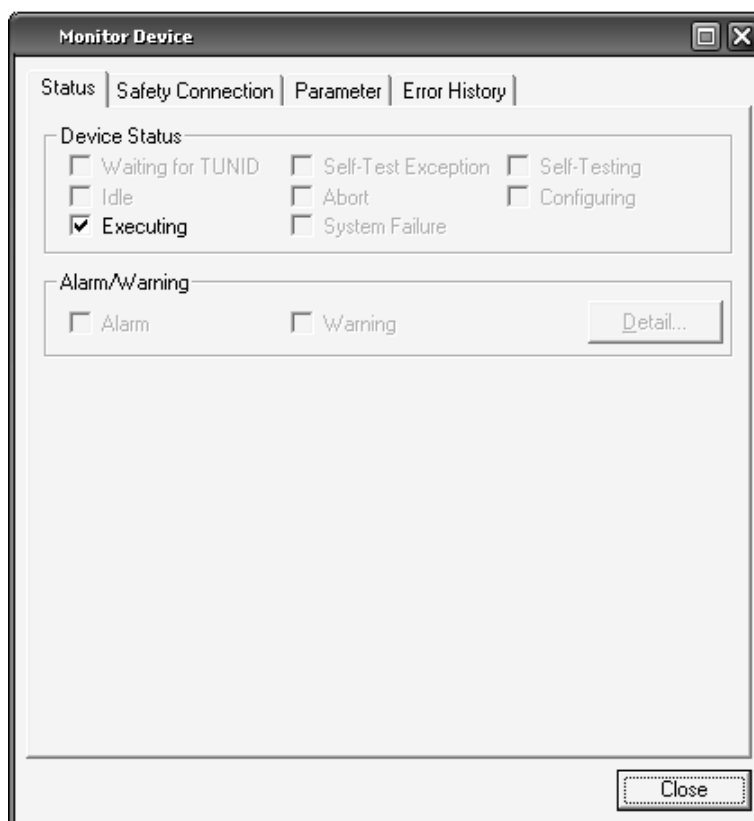



**Device Status**

The device status is displayed.

**Alarm/Warning**

Errors and warning that have occurred in the device are displayed.

Click the **Detail** Button to identify the error. The  icon will be displayed for alarms and the  icon for warnings.

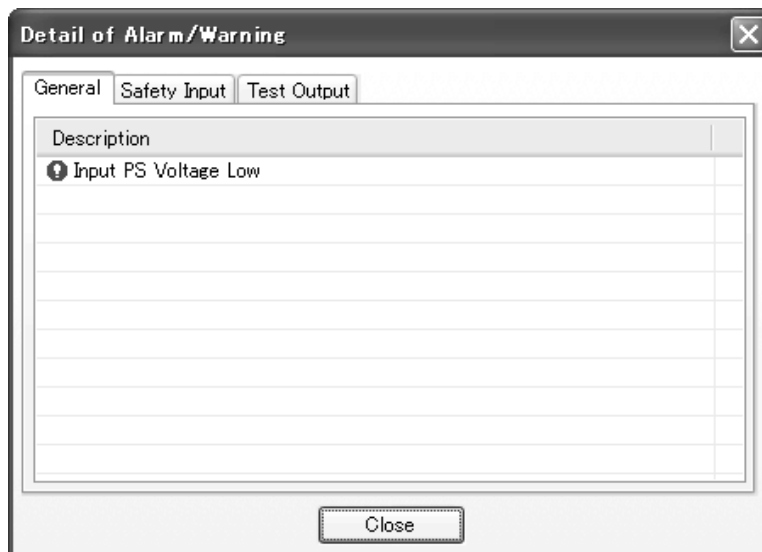

The Detail of Alarm/Warning Dialog Box has the following tab pages: General, Safety Output, Safety Input, and Test Output.

The General Tab Page displays the current Unit errors.

The other tab pages display errors occurring at the output terminal, the input terminal, and the test output terminal respectively. (The items displayed are outlined in *1-6-2 Monitoring Parameters*.)

If there is an alarm, the device will stop operation. Therefore the problem must be resolved.

If there is a warning, the device will continue to operate but the incident may develop into a problem. Therefore it is recommended that the cause of the warning is removed.

## 1-6-2 Monitoring Parameters

### Description

The I/O status of a DST1-series Safety I/O Terminal can be monitored using the Network Configurator. If the configuration fails or if an error occurs in any I/O, monitoring this information enables the user to determine the cause of the error.

### Monitoring Using the Network Configurator

The user can monitor the parameters using any of the following methods:

1. Select a device and select **Device – Monitor** from the menu bar. Click the **Parameters** Tab in the displayed window.
2. Select a device and click the **Monitor Device** Button on the toolbar. Click the **Parameters** Tab in the displayed window.
3. Right-click a device and select **Monitor** from the pop-up menu. Click the **Parameters** Tab in the displayed window.

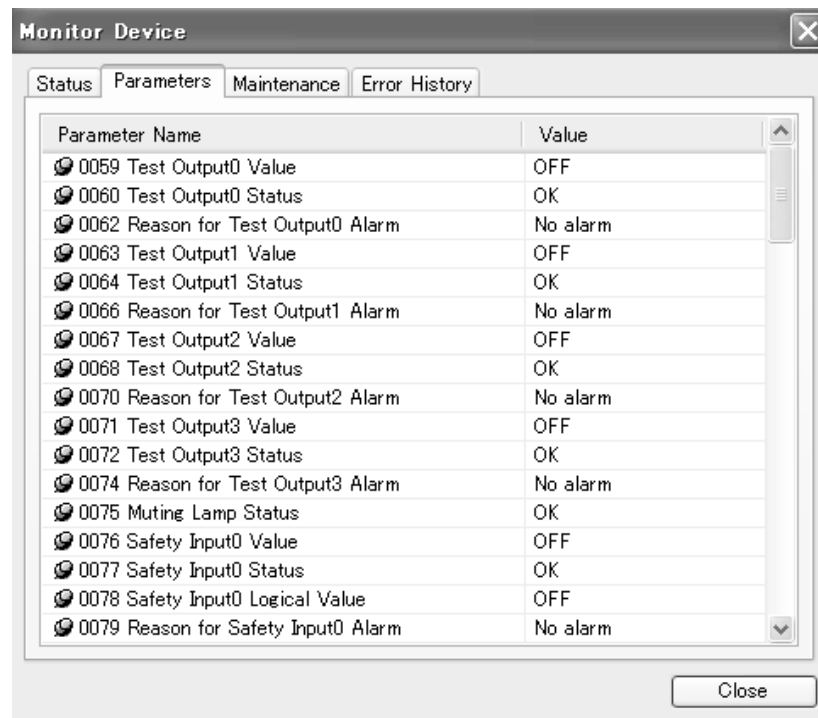

**Test Output Terminal Status**

Item	Description
Test Output Value	Output value of the test output.
Test Output Status	Evaluation result of the test output. "Alarm" is displayed if an error occurs.
Reason for Test Output Alarm	The cause of the error is displayed.
Muting Lamp Status	"Alarm" is displayed if an error occurs.

**Safety Input Terminal Status**

Item	Description
Safety Input Value	Input value to the safety input.
Safety Input Status	Evaluation result of the single-channel safety input. "Alarm" is displayed if an error occurs.
Safety Input Logical Value	The logical value of the safety input.
Reason for Safety Input Alarm	The cause of the error is displayed.

**Safety Output Terminal Status**

Item	Description
Safety Output Value	Output value of the safety output.
Safety Output Monitor Value	Monitoring value of the output for the safety output.
Safety Output Status	Evaluation result of the single-channel safety output. "Alarm" is displayed if an error occurs.
Reason for Safety Output Alarm	The cause of the error is displayed.

**Dual Channel Safety Input Status**

Item	Description
Dual Channel Safety Input Evaluation	Evaluation result of the dual-channel safety input. "Alarm" is displayed if an error occurs.

For the DST-XD0808SL-1, the following items will be displayed in addition to the above items.

**Output Value of the Input Section Internal Logic**

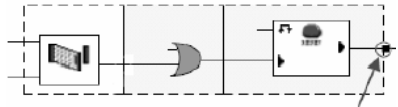
	Item	Description
Safety Input Logic Result	Output Value	<p>The output of the internal logic (as shown in the following figure) will be displayed.</p> 



### 1-6-3 Monitoring the Error History

#### Description

The error history of a DST1-series Safety I/O Terminal can be monitored using the Network Configurator.

Ten records can be saved internally in a DST1-series Safety I/O Terminal. When the number of errors exceeds the number of records, the oldest records will be deleted.

#### Monitoring Using the Network Configurator

The user can monitor the error history using any of the following methods:

1. Select a device and select **Device – Monitor** from the menu bar. Click the **Error History** Tab in the displayed window.
2. Select a device and click the **Monitor Device** Button on the toolbar. Click the **Error History** Tab in the displayed window.
3. Right-click a device and select **Monitor** from the pop-up menu. Click the **Error History** Tab in the displayed window.

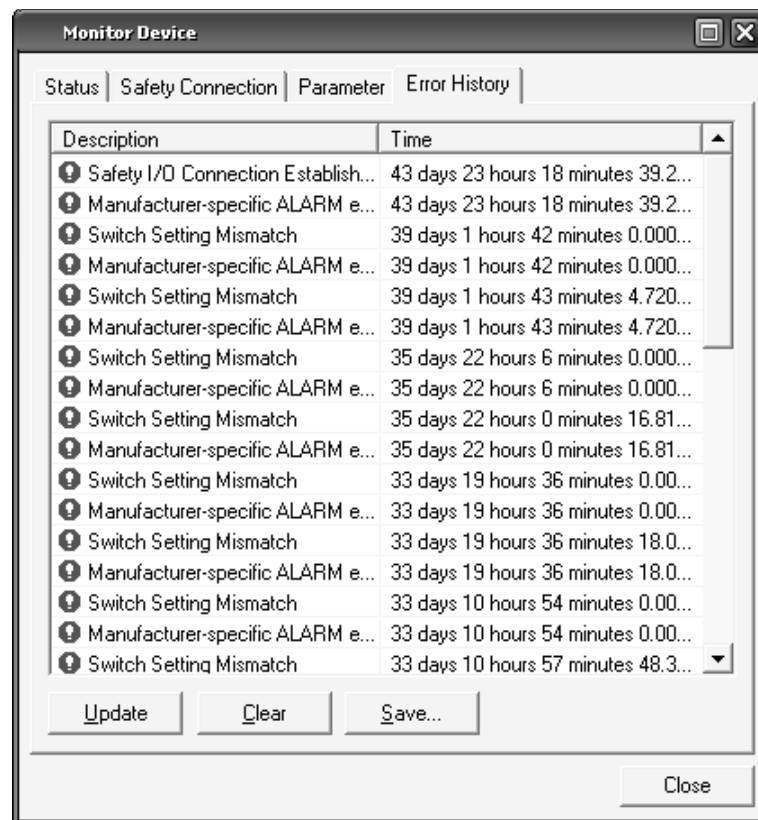

**Error History Display Items**

Item	Description
Description	Provides error details.
Time	The total device operation time when the error occurred. DST1-series Safety I/O Terminals do not support this function and 0 will always be displayed. (Refer to <i>1-7-2 Monitoring the Run Hours.</i> )

**Saving the Error History**

The error history information can be saved in CSV format. Click the **Save** Button to save the information.

**Clearing the Error History**

Click the **Clear** Button to clear the error history saved internally in the NE1A-series Controller or DST1-series Safety I/O Terminal.

**Updating the Error History**

Click the **Update** Button to access the most recent error history.

## 1-7 Maintenance Functions of DST1-series Safety I/O Terminals

DST1-series Safety I/O Terminals support the same maintenance functions as DRT2-series Smart Slaves, which are Standard Slaves.

### 1-7-1 Network Power Supply Voltage Monitor

#### Description

DST1-series Safety I/O Terminals always monitor the present, minimum, and maximum values of the network power supply voltage. If the voltage falls below the set threshold voltage (11 V in the default settings), the Threshold Network Power Voltage Error Flag will be turned ON in the General Status. The user can monitor this information using the Network Configurator and explicit messages.

- Note**
- The minimum communications power voltage of the DeviceNet network is 11 V. If the voltage falls below 11 V, the Configurator may not be able to read measured values.
  - The present, maximum, and minimum values of the network power supply voltage are cleared when the power supply to the DST1-series Safety I/O Terminal (network power) is turned OFF.

#### Setting the Threshold Network Power Supply Voltage Using the Network Configurator

Set the threshold voltage in the *Threshold Network Power Voltage* Field in the General Parameter Group.

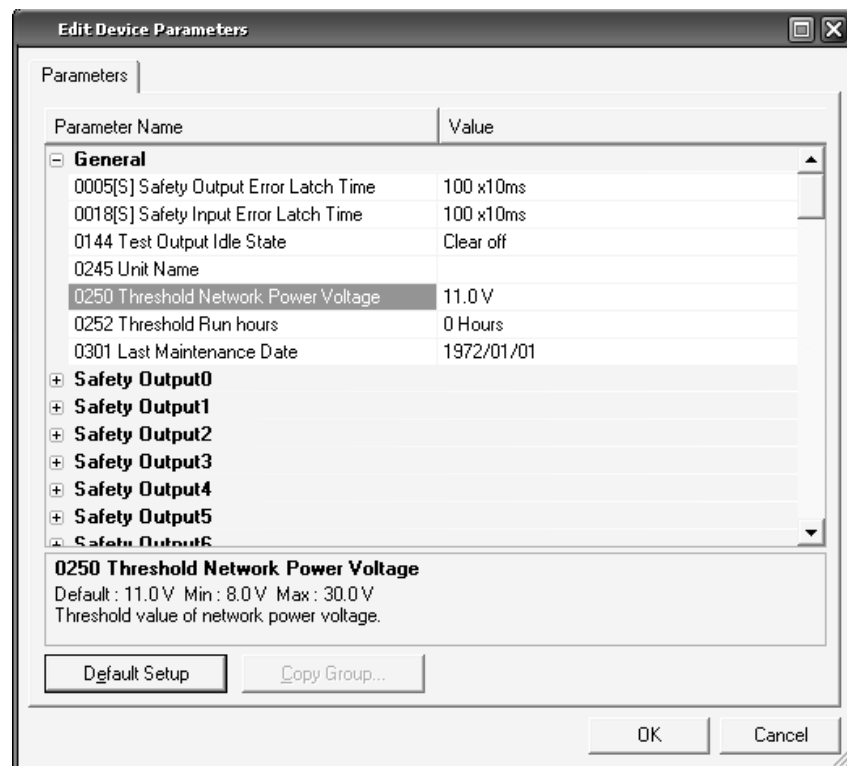

## Monitoring Using the Network Configurator

The user can monitor the present, maximum, and minimum values of the network power voltage in the General Status using any of the following methods:

1. Select a device and select **Device - Maintenance Information** from the menu bar.
2. Select a device and click the **Maintenance Information** Button on the toolbar.
3. Right-click a device and select **Maintenance Information** from the pop-up menu.
4. Select a device and select **Device - Monitor** from the menu bar. Click the **Maintenance** Tab in the displayed window.
5. Select a device and click the **Monitor Device** Button on the toolbar. Click the **Maintenance** Tab in the displayed window.
6. Right-click a device and select **Monitor** from the pop-up menu. Click the **Maintenance** Tab in the displayed window.

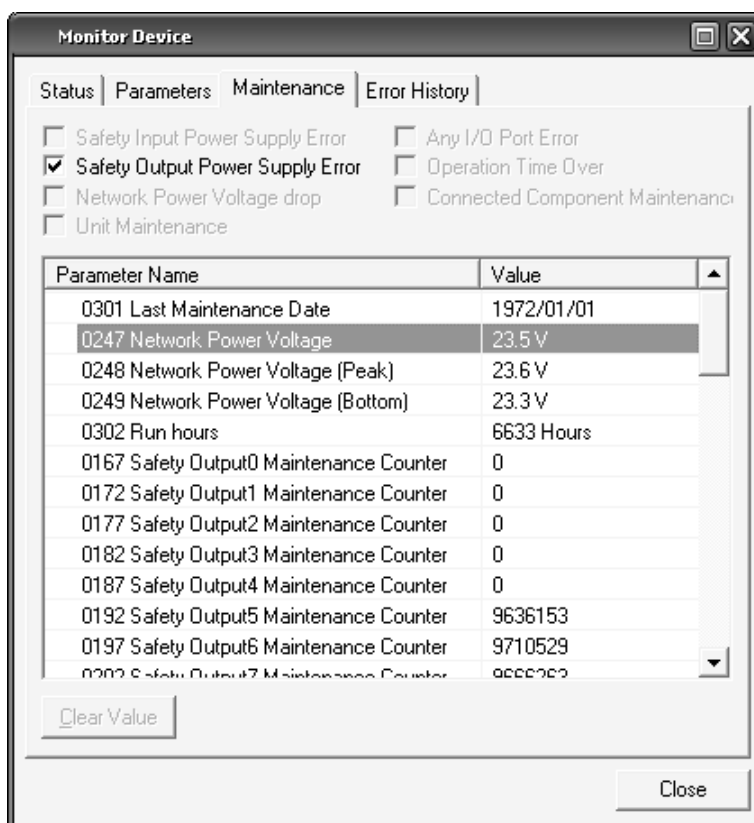

The maximum and minimum values of the network power voltage can be cleared. Select the maximum or minimum value and click the **Clear Value** Button.

## 1-7-2 Monitoring the Run Hours

### Description

A DST1-series Safety I/O Terminal totals the number of hours the internal circuit power is supplied and internally saves it in non-volatile memory. If the cumulative time reaches the set threshold value, the Unit Maintenance Flag will turn ON in the General Status.

- Measurement time: 0 to 429,496,729.5 hours  
(stored data: 0000 0000 to FFFF FFFF hex)
- Measurement unit: 0.1 hour

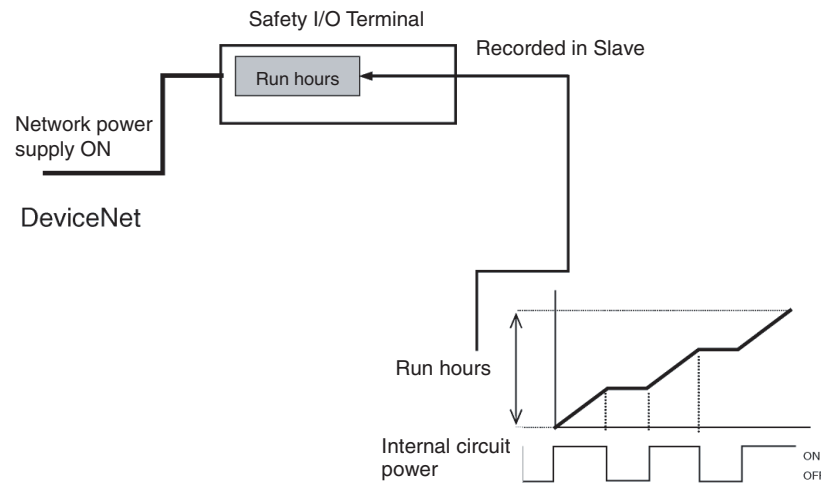

The user can monitor this information using the Network Configurator and explicit messages.

### Note

- The run hours monitoring function totals the time when the power supply to the DST1-series Safety I/O Terminal (network power) is ON. This does not include the time when the power is OFF.
- The DST1-series Safety I/O Terminals measure time internally in 0.1-hour increments. When the Threshold Run Hours parameter is set on the Network Configurator and when the run hours are monitored, however, the time will be in 1-hour increments.

## Setting the Threshold Run Hours Using the Network Configurator

Set the threshold value in the *Threshold Run hours* Field of the *General* Parameter Group.

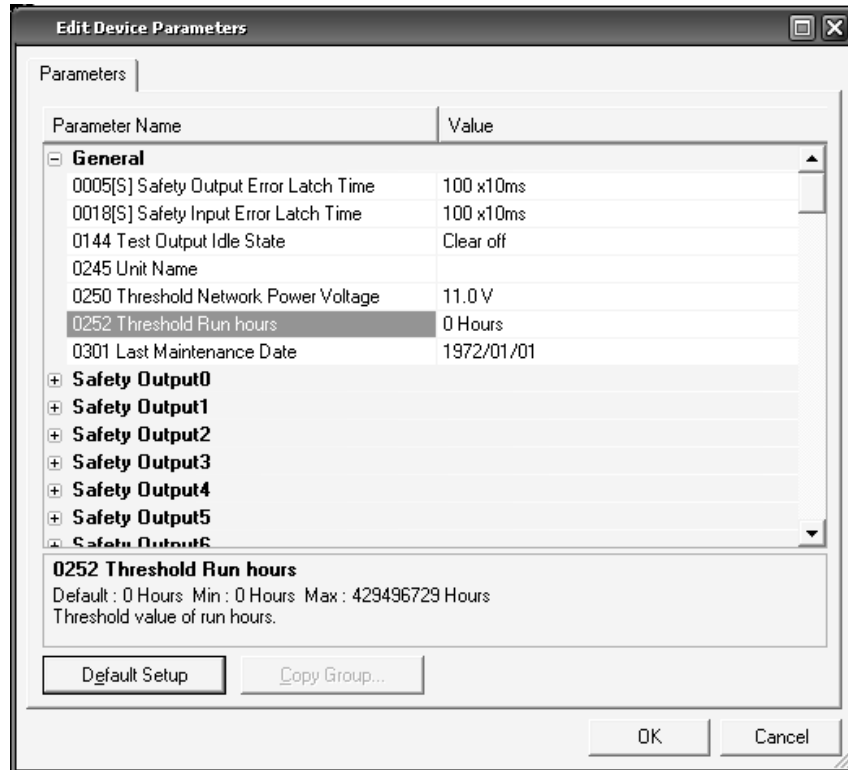

If the threshold value is set to 0, the threshold value will not be checked.

## Monitoring Using the Network Configurator

The user can monitor run hours in the General Status using any of the following methods:

1. Select a device and select **Device - Maintenance Information** from the menu bar.
2. Select a device and click the **Maintenance Information** Button on the toolbar.
3. Right-click a device and select **Maintenance Information** from the pop-up menu.
4. Select a device and select **Device - Monitor** from the menu bar. Click the **Maintenance** Tab in the displayed window.
5. Select a device and click the **Monitor Device** Button on the toolbar. Click the **Maintenance** Tab in the displayed window.
6. Right-click a device and select **Monitor** from the pop-up menu. Click the **Maintenance** Tab in the displayed window.

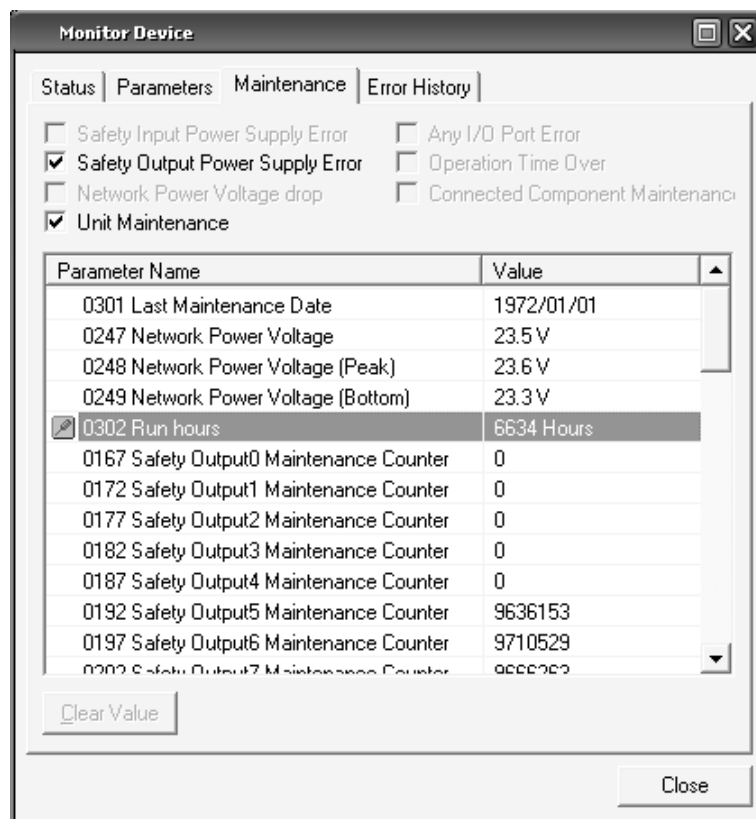

### 1-7-3 Last Maintenance Date

#### Description

With a DST1-series Safety I/O Terminal the last maintenance date can be recorded internally in non-volatile memory. This enables the user to easily decide the time for the next maintenance. The recorded maintenance date can be monitored using the Network Configurator or explicit messages.

#### Recording the Maintenance Date Using the Network Configurator

Record the data using the Last Maintenance Date Parameter in the *General* Parameter Group.

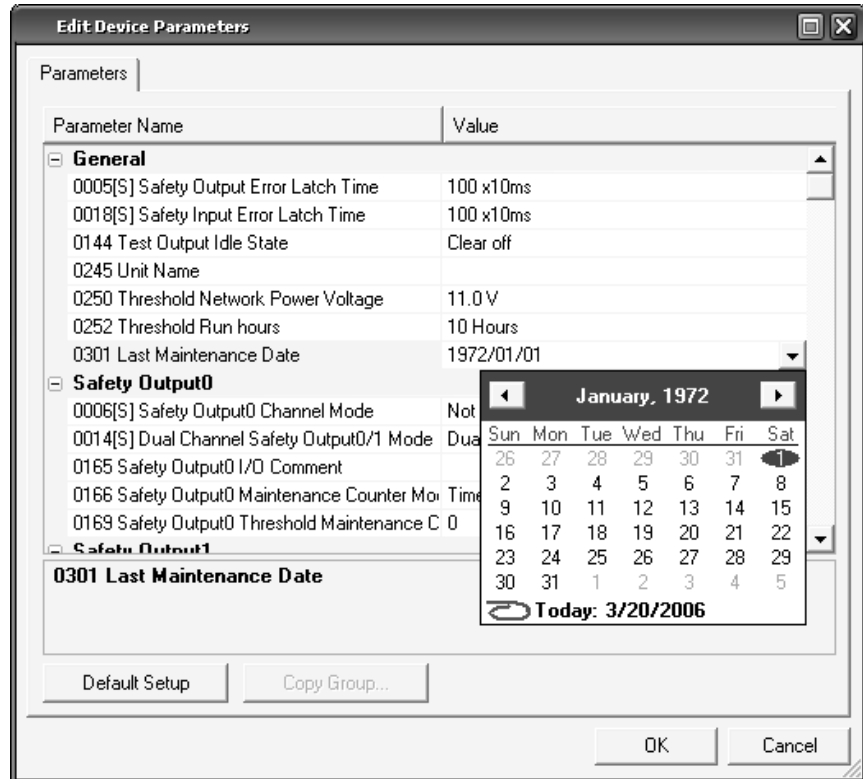



## Monitoring Using the Network Configurator

The user can monitor the maintenance date using any of the following methods:

1. Select a device and select **Device - Maintenance Information** from the menu bar.
2. Select a device and click the **Maintenance Information** Button on the tool-bar.
3. Right-click a device and select **Maintenance Information**.
4. Select a device and select **Device - Monitor** from the menu bar. Click the **Maintenance** Tab in the displayed window.
5. Select a device and click the **Monitor Device** Button. Click the **Maintenance** Tab in the displayed window.
6. Right-click a device and select **Monitor** from the pop-up menu. Click the **Maintenance** Tab in the displayed window.

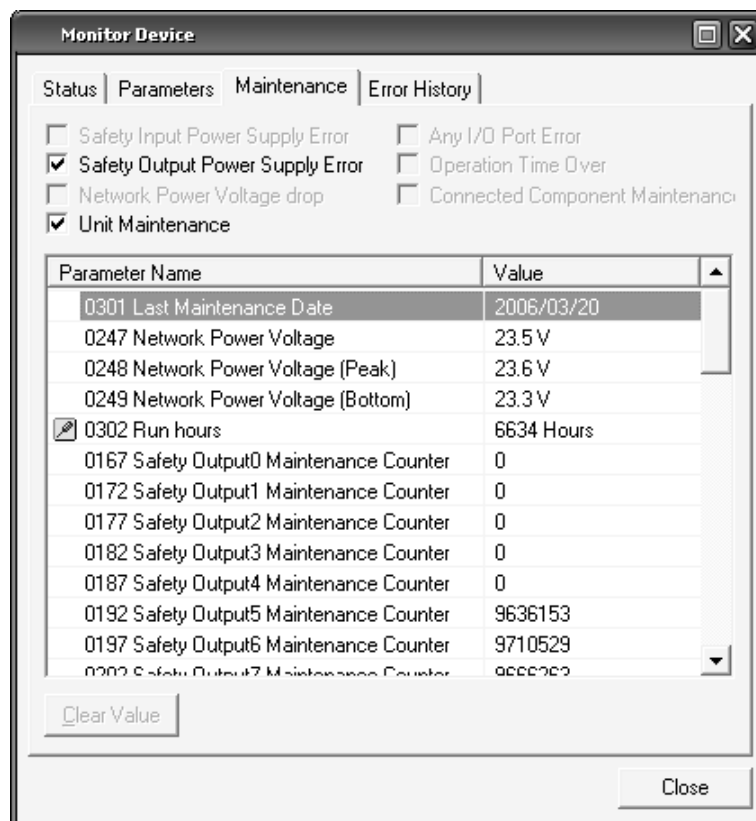

## 1-7-4 Monitoring the Contact Operation Counters

### Description

A DST1-series Safety I/O Terminal totals the number of times each safety input contact, test output contact, and safety output contact turns ON and internally saves the data in non-volatile memory. If the value of a counter reaches the threshold value, the Connected Component Maintenance Flag in General Status will turn ON.

- Measurement count: 0 to 4,294,967,295 counts  
(stored data: 0000 0000 to FFFF FFFF hex)
- Measurement unit: Operations
- Maximum resolution: 166.7 Hz

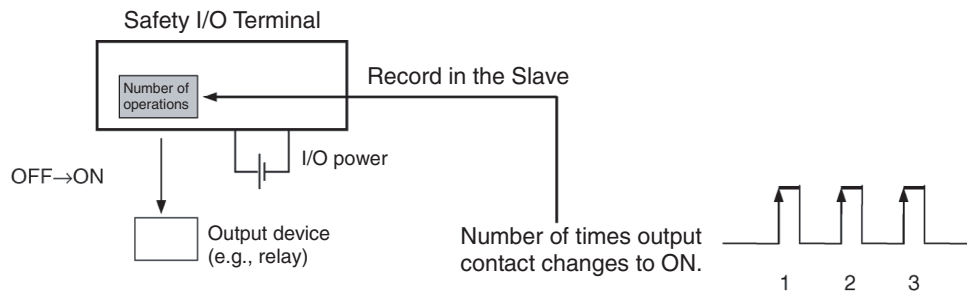

The user can monitor this information using the Network Configurator and explicit messages.

- Note**
- **One contact cannot be used at the same time for both the time and count monitoring functions. Select only one of these in the *Maintenance Counter Mode Choice*.**
  - **If the *Maintenance Counter Mode Choice* is changed, the counter or time data saved internally will be cleared.**
  - **This function does not operate when the I/O power supply is OFF.**

**Setting the Contact Operation Counter Threshold Using the Network Configurator**

Set the Maintenance Counter Mode Choice Parameter and Threshold Maintenance Counter Parameter for each I/O of the safety input group, test output group, and safety output group.

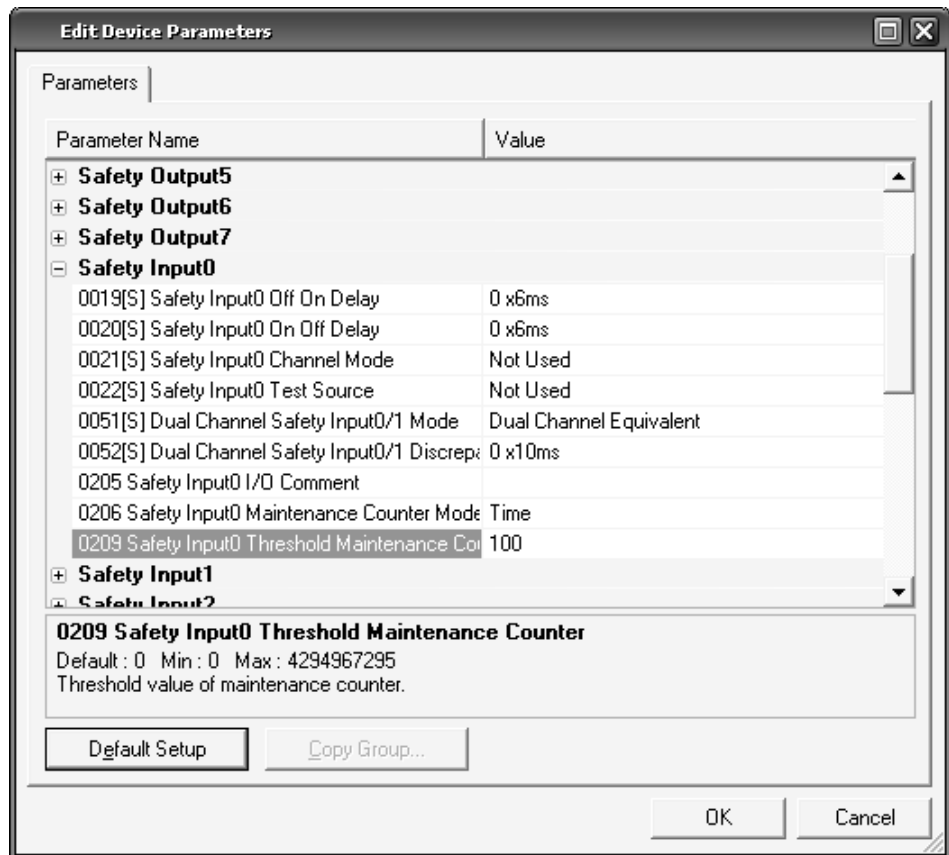

When the Threshold Maintenance Counter is set to 0, the threshold value will not be checked.

## Monitoring Using the Network Configurator

The user can monitor the counts for safety input status, test output status, and safety output status using any of the following methods:

1. Select a device and select **Device - Maintenance Information** from the menu bar.
2. Select a device and click the **Maintenance Information** Button on the toolbar.
3. Right-click a device and select **Maintenance Information** from the pop-up menu.
4. Select a device and select **Device - Monitor** from the menu bar. Click the **Maintenance** Tab in the displayed window.
5. Select a device and click the **Monitor Device** Button on the toolbar. Click the **Maintenance** Tab in the displayed window.
6. Right-click a device and select **Monitor** from the pop-up menu. Click **Maintenance** Tab in the displayed window.

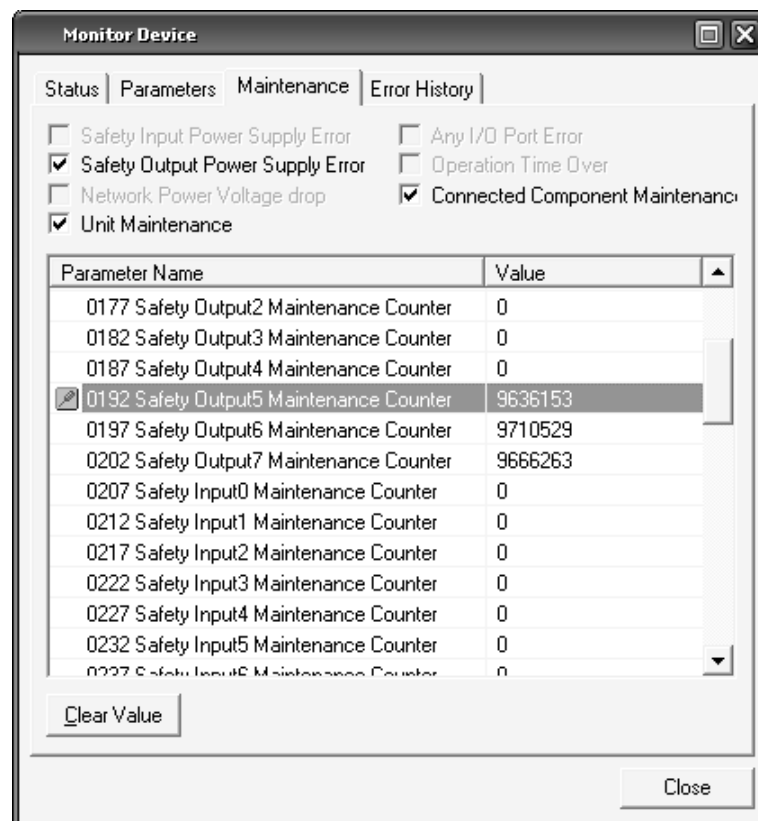

Each counter can be cleared. Select the counter to clear and click the **Clear Value** Button.

## 1-7-5 Monitoring the Total ON Times

### Description

A DST1-series Safety I/O Terminal totals the time each safety input contact, test output contact, and safety output contact is ON, and saves it internally in non-volatile memory. If a cumulative time reaches the threshold value, the Connected Component Maintenance Flag in General Status will turn ON.

- Measurement time: 0 to 4,294,967,295 seconds  
(stored data: 0000 0000 to FFFF FFFF hex)
- Measurement unit: Seconds

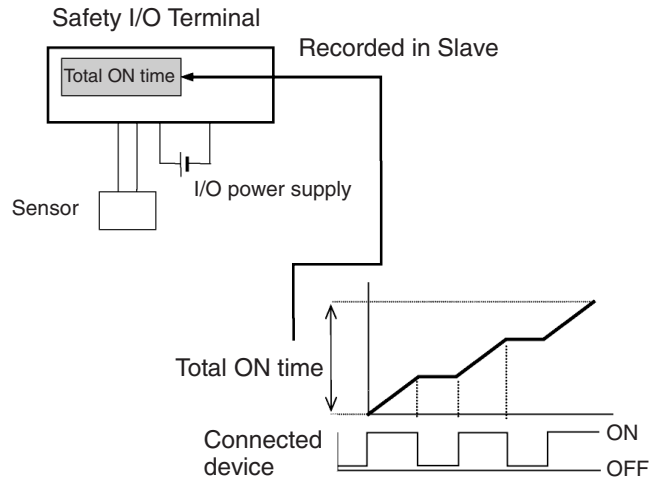

The user can monitor this information using the Network Configurator and explicit messages.

- Note**
- **One contact cannot be used at the same time for both the time and count monitoring functions. Select only one of these in the *Maintenance Counter Mode Choice*.**
  - **If the *Maintenance Counter Mode Choice* is changed, the counter or time data saved internally will be cleared.**
  - **This function does not operate when the I/O power supply is OFF.**
  - **The time monitor checks if the connected component is ON approximately every second. This should be noted when the time is measured in increments of 1 second or less.**

**Measuring 0.5-second ON Time**

In *Figure A*, the actual ON time is 0.5 seconds x 3, or 1.5 seconds. Operation is ON only once when measurements are made, however, so the time is measured as 1 second.

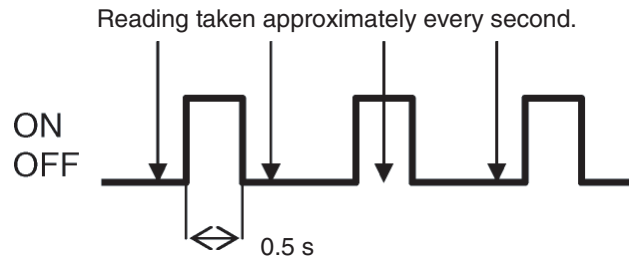

Figure A

In *Figure B*, the actual ON time is 0.5 seconds x 3, or 1.5 seconds. Operation is ON twice when measurements are made, however, so the time is measured as 2 seconds.

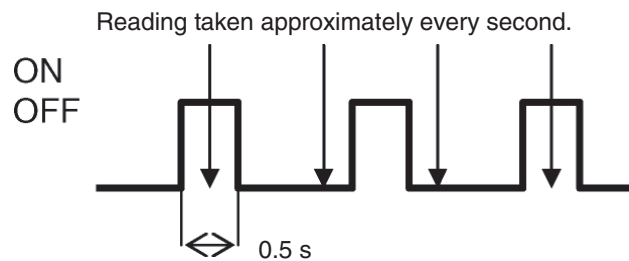

Figure B

**Measuring 1.5-second ON Time**

In *Figure C*, the actual ON time is 1.5 seconds x 2, or 3 seconds. Operation is ON four times when measurements are made, however, so the time is measured as 4 seconds.

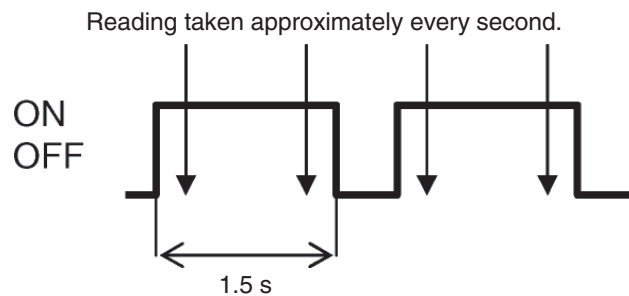
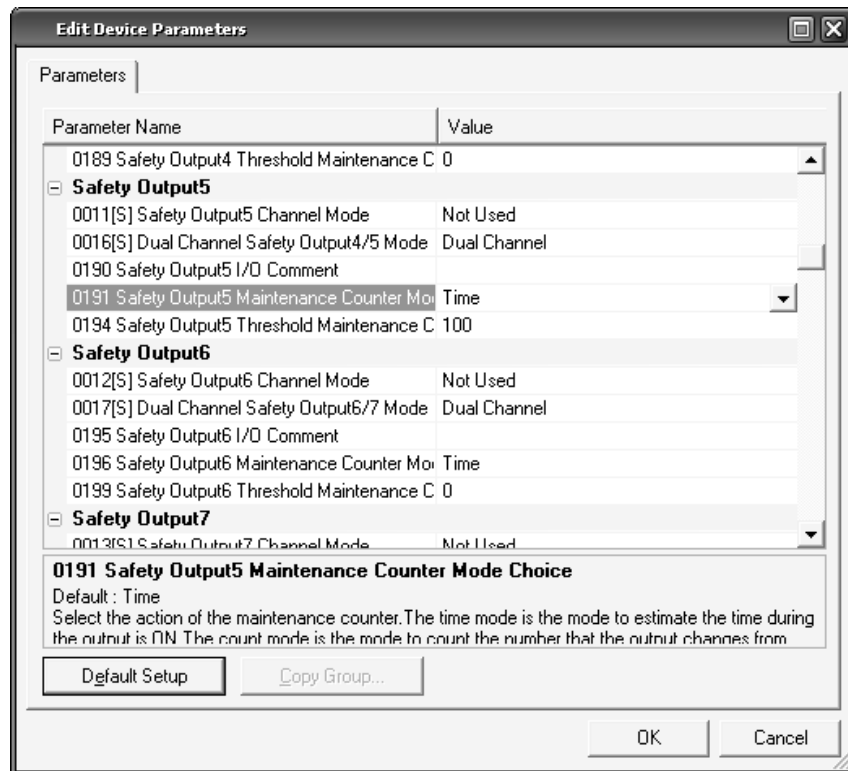

Figure C

### Setting the Threshold Value for Total ON Time Using the Network Configurator

Set the Maintenance Counter Mode Choice Parameter and Threshold Maintenance Counter Parameter for each contact of the safety input group, test output group, and safety output group.



If the Threshold Maintenance Counter is set to 0, the threshold value will not be checked.

## Monitoring Using the Network Configurator

The user can monitor the times for safety input status, test output status, and safety output status using any of the following methods:

1. Select a device and select **Device - Maintenance Information** from the menu bar.
2. Select a device and click the **Maintenance Information** Button on the toolbar.
3. Right-click a device and select **Maintenance Information** from the pop-up menu.
4. Select a device and select **Device - Monitor** from the menu bar. Click the **Maintenance** Tab in the displayed window.
5. Select a device and click the **Monitor Device** Button on the toolbar. Click the **Maintenance** Tab in the displayed window.
6. Right-click a device and select **Monitor** from the pop-up menu. Click the **Maintenance** Tab in the displayed window.

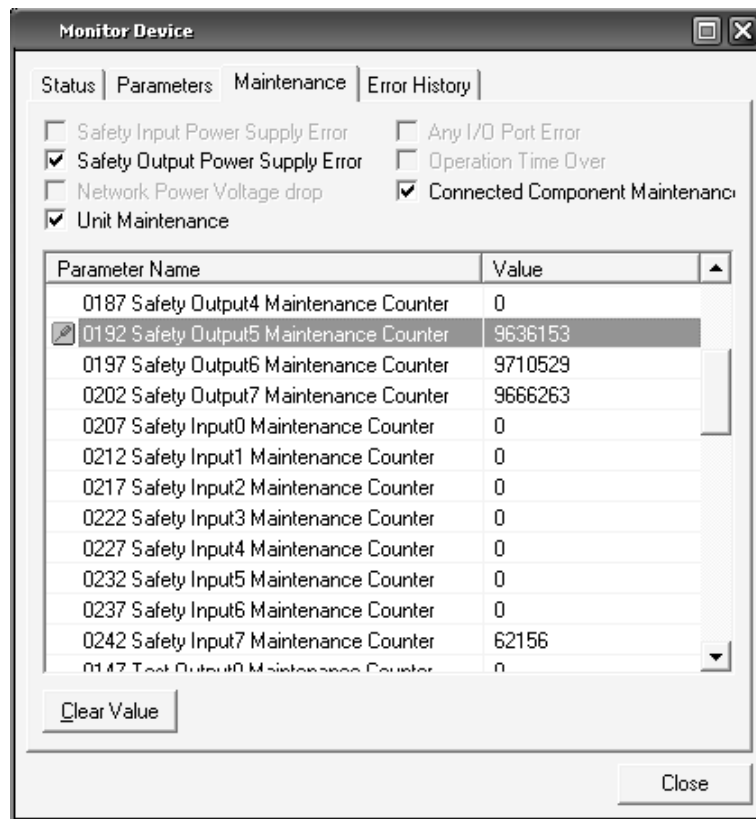

Each time value can be cleared. Select the time to clear and click the **Clear Value** Button.



## 1-7-6 Monitoring the Operation Time

### Description

A DST1-series Safety I/O Terminal measures the time from when a safety output turns ON until the safety input turns ON and internally saves the data in non-volatile memory. If the value of the operation time reaches the threshold value, the Threshold Response Time Flag in General Status will turn ON.

- Measurement time: 0 to 65,535 ms (stored data: 0000 to FFFF hex)
- Measurement unit: ms

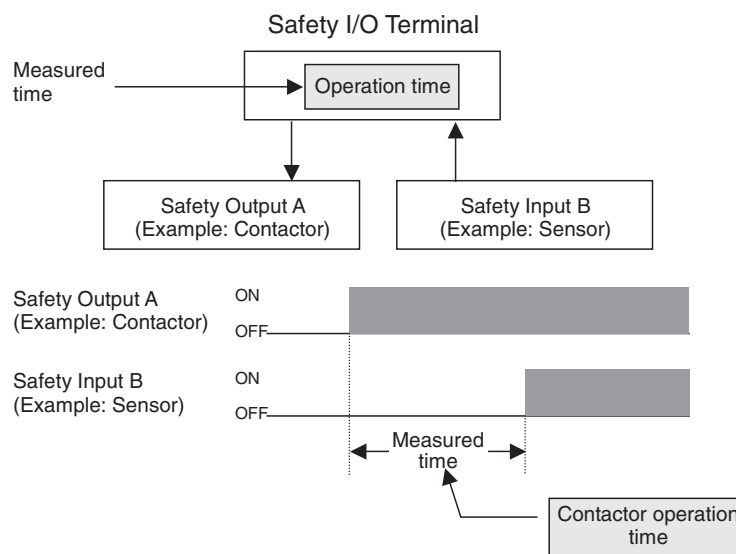

The input reaction time and the output reaction time of the DST1-series Safety I/O Terminal are added to monitor the operation time.

Maximum input reaction time of the DST1-series Safety I/O Terminal  
 = 16.2 ms + ON/OFF delay

Maximum output reaction time of the DST1-series Safety I/O Terminal  
 = 6.2 ms + Relay reaction time (DST1-MRD08SI-1 only)

The measurement is accurate to  $\pm 6$  ms.

The user can monitor this information using the Network Configurator and explicit messages.

- Note**
- In the DST1-MD16SL-1 or DST1-MRD08SL-1, the time is measured from when a safety output turns ON until the safety input turns ON for the safety input and safety output with the same number (e.g., Safety Input 0 and Safety Output 0).
  - In the DST1-ID12SL-1, the time is measured between two safety inputs turning ON (e.g., Safety Input 0 and Safety Input 6).
  - The operation time is stored when the time from an output turning ON to an input turning ON is measured. The measurement, however, continues internally until the next time the output turns ON. If the input turns ON again before the output turns ON, the measurement time will be updated. If an input occurs in the middle of the operating range of reciprocating motion, like a cylinder, the measurement value of operation (outward path) may be updated when returning (return path).
  - When an output turns ON two consecutive times before the input turns ON, the time will be measured from the second time the output turned ON until the time the input turned ON.

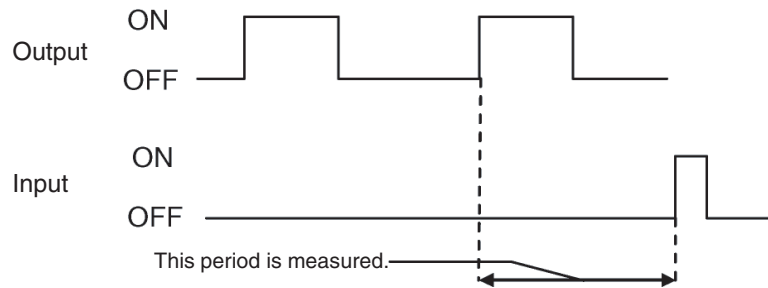
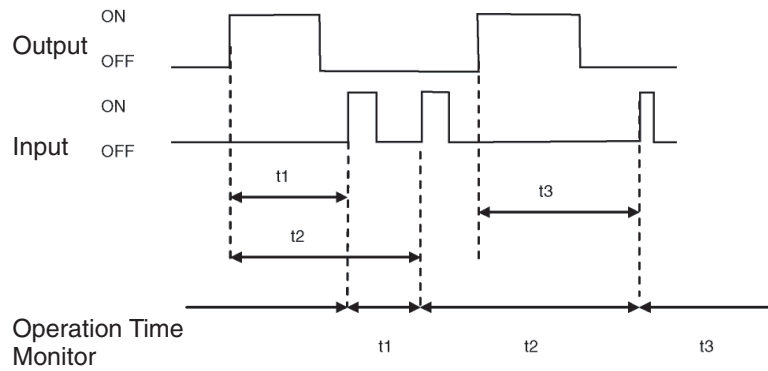

### Setting the Threshold Response Time Using the Network Configurator

The Threshold Response Time is set for each pair in the *Operation Time* Parameter Group.

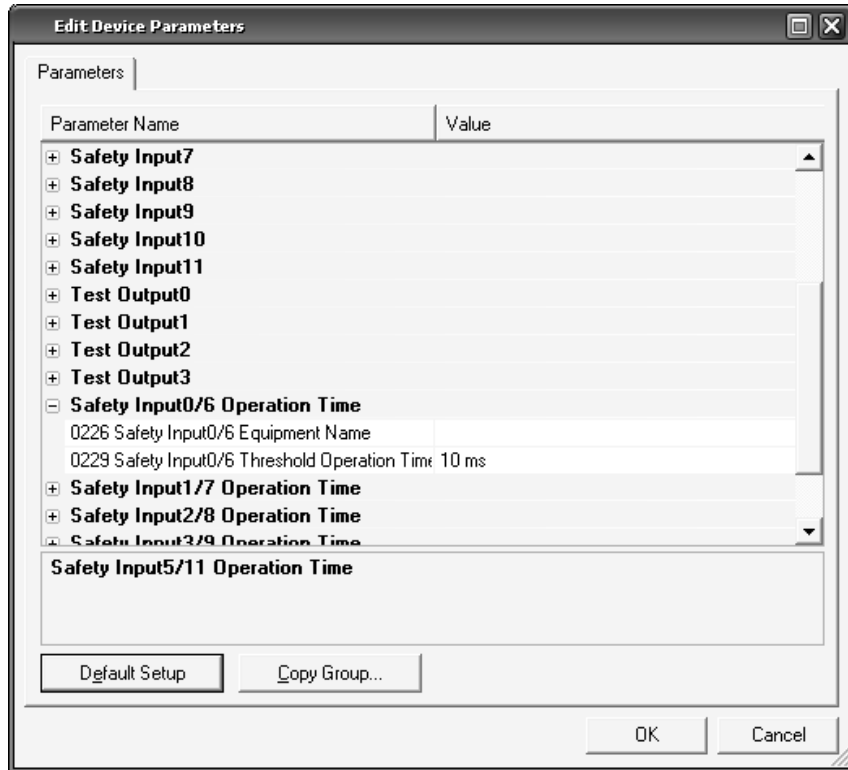

If the threshold value is set to 0, the threshold value will not be checked.

## Monitoring Using the Network Configurator

The user can monitor the operation time using any of the following methods:

1. Select a device and select **Device - Maintenance Information** from the menu bar.
2. Select a device and click the **Maintenance Information** Button on the tool bar.
3. Right-click a device and select **Maintenance Information** from the pop-up menu.
4. Select a device and select **Device - Monitor** from the menu bar. Click the **Maintenance** Tab in the displayed window.
5. Select a device and click the **Monitor Device** Button on the toolbar. Click the **Maintenance** Tab in the displayed window.
6. Right-click a device and select **Monitor** from the pop-up menu. Click the **Maintenance** Tab in the displayed window.

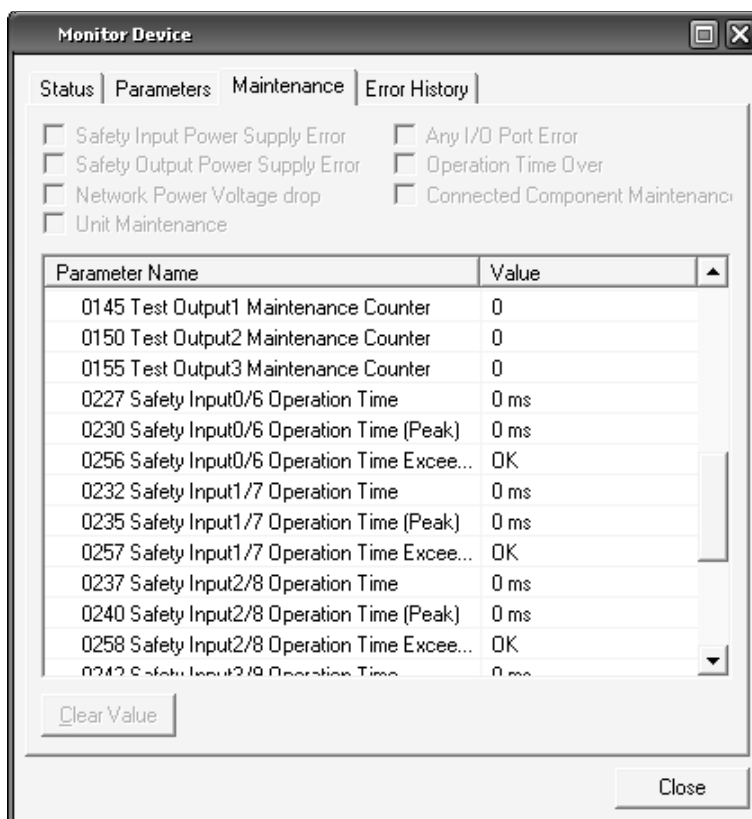

- The present value of the operation time is displayed for the *Operation Time*.
- The slowest value of the operation time is displayed for the *Operation Time (Peak)*.
- If the Threshold Response Time is set and the value exceeds the threshold value even once, “Alarm” will be displayed for the *Operation Time Exceed Hold*.

The user can clear the *Operation Time (peak)* and *Operation Time Exceed Hold* values. Select an item to clear and click the **Clear Value** Button.

## **SECTION 2**

### **General Procedure**

2-1	General Procedure.....	46
2-2	Installation.....	47
2-3	Connecting I/O Power and I/O Cable.....	48
2-4	Connecting the Communications Connector.....	51
2-5	Node Address.....	52
2-6	Configuration.....	52

## 2-1 General Procedure

The general procedure for using the DST1-series Safety I/O Terminals is given below.

Refer to the *DeviceNet Operation Manual* (Cat. No. W267) for the network structure and the topology.

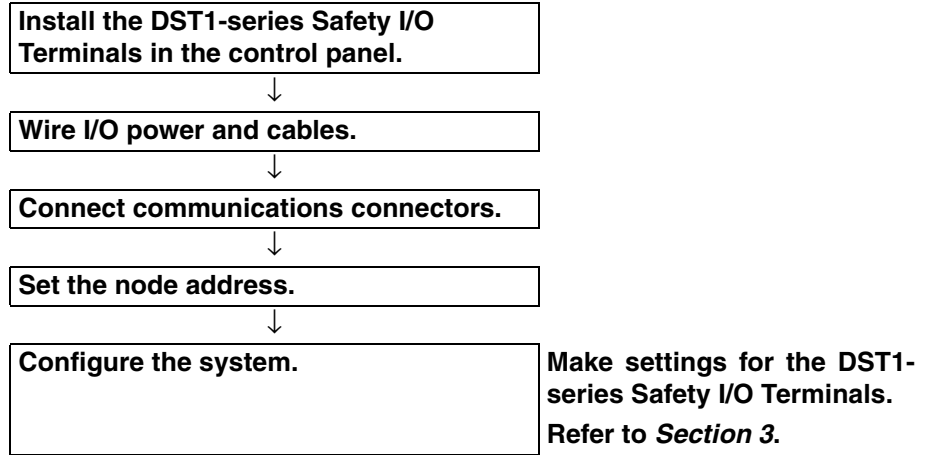

The baud rate of the entire system is determined by the baud rate of the Master Unit. The baud rate does not need to be set for each DST1-series Safety I/O Terminals.

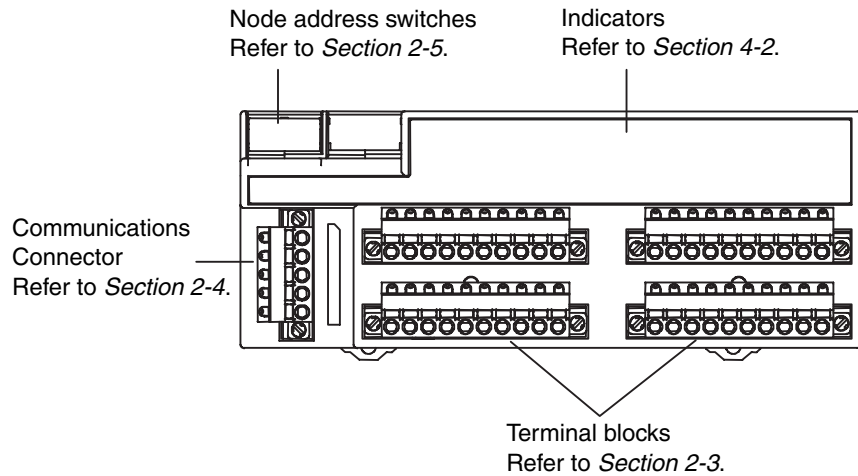

## 2-2 Installation

Use the DIN Track (35 mm wide) to install the DST1-series Safety I/O Terminals in the control panel.

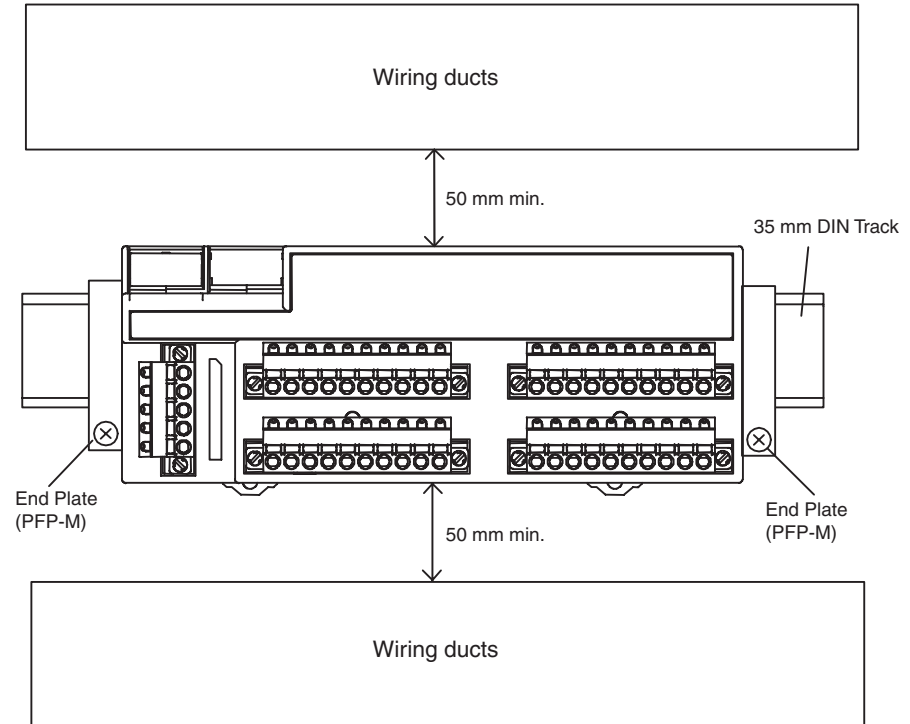

\* Refer to the descriptions of individual DST1 models (*Section 5*) for dimensions.

- IMPORTANT**
- Use the DST1 in an environment that is within the general specifications.
  - Use the DST1 in an enclosure rated IP54 (IEC 60529) or higher.
  - Use DIN Track (35 mm wide) to mount the DST1 in the control panel.
  - Always use an End Plate on each end of the DST1 to secure it.
  - Allow a minimum of 50 mm above and below the DST1 for ventilation.

## 2-3 Connecting I/O Power and I/O Cable

Use the following wire sizes to wire external I/O devices.

Solid wire	0.2 to 2.5 mm <sup>2</sup> (AWG 24 to AWG 12)
Stranded wires	0.34 to 1.5 mm <sup>2</sup> (AWG 22 to AWG 16)

\* Refer to the descriptions of individual DST1 models (*Section 5*) for the terminal arrangement of the terminal block and wiring for external I/O.

### **Recommended Materials and Tools**

#### **Ferrules with Plastic Insulating Collars**

Use the ferrules with insulating collars conforming to DIN 46228-4. Ferrules with similar appearance but not conforming to the standard may not match the terminal blocks of the DST1-series Safety I/O Terminals. (The wire dimensions shown below are rough dimensions. Confirm before application.)

- Note**
- (1) If the terminal block is wired with ferrules, firmly insert them all the way in.
  - (2) When using 2-wire ferrules, the power lines must be of the same diameter.
  - (3) When using 2-wire ferrules, the metal part of the ferrule must be inserted straight into the terminal block.



Reference Specifications (Product Specifications from Phoenix Contact)

Model of ferrule		Wire dimensions		Ferrule specifications					Dimensions
		Cross-sectional area of conductor (mm <sup>2</sup> )	AWG	Removed length of insulation (mm)	Overall length L1 (mm)	Length of metal part L2 (mm)	Inner diameter of conductor D1 (mm)	Inner diameter of insulation cover D2 (mm)	
For one wire	AI 0,34-8TQ	0.34	22	10	12.5	8	0.8	2.0	*1
	AI 0,5-10WH	0.5	20	10	16	10	1.1	2.5	
	AI 0,75-10GY	0.75	18	10	16	10	1.3	2.8	
	AI 1-10RD	1.0	18	10	16	10	1.5	3.0	
	AI 1,5-10BK	1.5	16	10	18	10	1.8	3.4	
For two wires	AI-TWIN 2 x 0,75	2 x 0.75	-	10	17	10	1.8	2.8/5.0	*2
	AI-TWIN 2 x 0,75-10GY								
	AI-TWIN 2 x 1-10RD	2 x 1	-	10	17	10	2.05	3.4/5.4	

\* 1 For One Wire

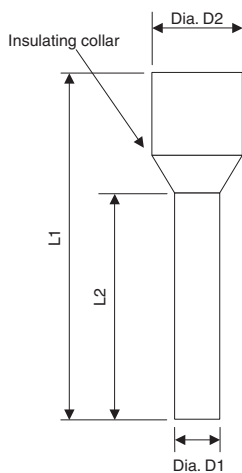

\* 2 For Two Wires

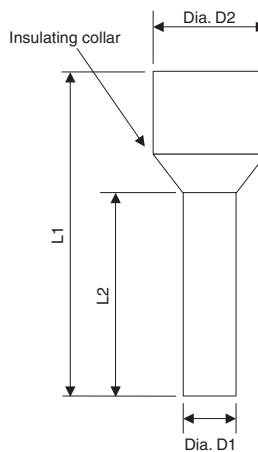

Crimping Tool for Ferrules

Manufacturer	Model
Phoenix Contact	CRIMPFOX UD6 or CRIMPFOX ZA3

**IMPORTANT**

- I/O connectors are detachable. Tighten the screws on the I/O connector to 0.25 to 0.3 N·m.
- Separate I/O signal cables from high-voltage lines and power lines.
- I/O signal cables must be no longer than 30 m.
- Do not apply power to safety output terminals or test output terminals. Doing so may cause burning or other damage to the product.
- Do not remove the label from the DST1 before wiring.
- Always remove the label after completing wiring to ensure proper heat dispersion.

**IMPORTANT** The two sets of power supply terminals on the DST1 can be used when wiring DST1 Units individually, e.g., to use the same power supply for both inputs and outputs. Do not wire any other Units or external devices from the I/O power supply terminals of the DST1.

**Correct**

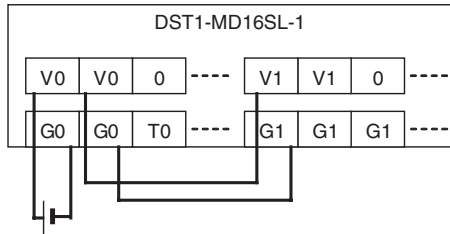

**Incorrect**

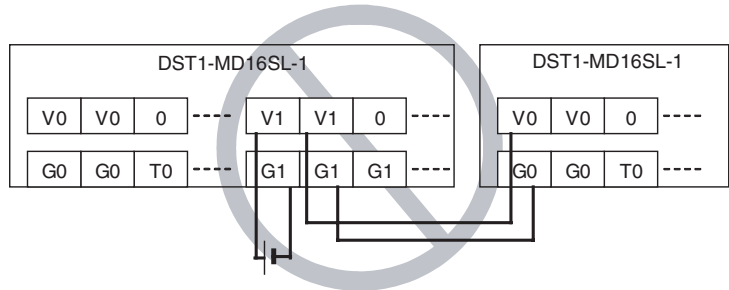

## 2-4 Connecting the Communications Connector

Colored stickers are provided on the communications connector that match the colors of the lines to be inserted. Check that the colors of the lines and stickers match when wiring the connectors. The colors are as follows:

Color	Signal
Red	Power cable positive side (V+)
White	High side of communications data (CAN_H)
-	Shield
Blue	Low side of communications data (CAN_L)
Black	Power cable negative side (V-)

Refer to the *DeviceNet Operation Manual* (Cat. No. W267) for details on communications specifications and wiring.

**IMPORTANT**

- When connecting the communications connector to the DST1, tighten the screws on the communications connector to 0.25 to 0.3 N·m.
- OMRON's S8□□ Power Supplies are recommended for communications power.
- Be sure to separate communications cables from high-voltage and power lines.
- Use DeviceNet-compliant Thick Cables or Thin Cables for the communications cables. Do not use flat cables.

**Note**

- The internal power for the DST1-series Safety I/O Terminals is supplied from the communications power supply (V+, V-).

## 2-5 Node Address

Set the node address using the two rotary switches on the front panel of the DST1-series Safety I/O Terminals. The default setting is 63. Set the tens digit of the node address (decimal) using the left rotary switch and set the ones digit using the right rotary switch. A value between 00 and 63 can be set.

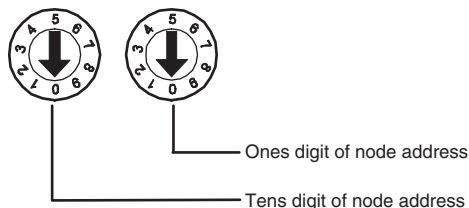

If a node address between 64 and 99 is set, the node address can be set from the Network Configurator.

### IMPORTANT

- The node address must be set while the communications power supply is turned OFF.
- Do not change the rotary switches while the power is ON. The DST1-series Safety I/O Terminals will detect this as a change in the configuration and will switch to fault state.
- Use a small flat-blade screwdriver to set the rotary switches, being careful not to scratch them.

## 2-6 Configuration

Configure the DST1-series Safety I/O Terminals using the Network Configurator. Refer to *Section 3 Configuration* for details on settings. Refer to the *System Configuration Manual* (Cat. No. Z905) for Network Configurator operating procedures.

# SECTION 3 Configuration

- 3-1 Editing Parameters ..... 54
  - 3-1-1 Setting Parameters Using the Wizard ..... 54
  - 3-1-2 Parameter Groups ..... 59
  - 3-1-3 General Parameter Group ..... 60
  - 3-1-4 Safety Input Parameter Groups ..... 62
  - 3-1-5 Test Output Parameter Groups ..... 64
  - 3-1-6 Safety Output Parameter Groups ..... 65
  - 3-1-7 Operation Time Parameter Groups ..... 66
  - 3-1-8 Safety Input Logic Parameter Groups (Safety Input Logic) ..... 67
  - 3-1-9 Safety Output Logic Parameter Groups (Safety Output Logic) ..... 68
  - 3-1-10 Editing I/O Comments ..... 69
- 3-2 Remote I/O Allocations ..... 70
  - 3-2-1 I/O Allocations ..... 70
  - 3-2-2 I/O Data ..... 70
  - 3-2-3 I/O Data Supported by Each Model ..... 72
  - 3-2-4 I/O Assembly Data ..... 77
  - 3-2-5 Changing Default Standard I/O Assembly Data  
(DST1-XD0808SL-1 Only) ..... 84

### 3-1 Editing Parameters

Device parameters can be edited using any of the following methods.

1. Double-click a device icon.
2. Select a device, and then select **Device - Parameter - Edit** from the menu bar.
3. Select a device, and then click the **Edit Parameter** Button on the toolbar.
4. Right-click the device and select **Parameter - Edit**.
5. Select the device, and then select **Device - Parameter - Wizard**.

**Note** With Network Configurator version 2.0 or higher, basic parameters can be set using a wizard. Using this parameter will reduce errors in the parameter settings.

#### 3-1-1 Setting Parameters Using the Wizard

With Network Configurator Ver. 2.0 or higher, I/O parameters for DST1-series Safety I/O Terminals can be set using a wizard. This section explains the procedure.

1. Select a DST1-series Safety I/O Terminal, and then select **Device - Parameter - Wizard**. The following window will be displayed.  
If there are no output terminals (DST1-ID12SL-1), the window for setting input terminals will be displayed.

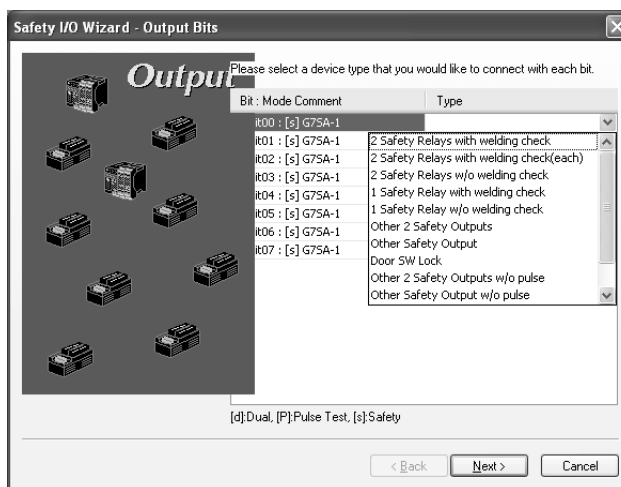

2. In the window above, specify the type of device to be connected to each terminal. The following types can be specified.

Type	Description
2 Safety Relays with welding check (See note.)	Specify to connect to two Safety Relay outputs (with welding check for each).
2 Safety Relays w/o welding check (See note.)	Specify to connect to two Safety Relay outputs (with no welding check).
1 Safety Relay with welding check	Specify to connect to one Safety Relay output (with welding check).
1 Safety Relay w/o welding check	Specify to connect to one Safety Relay output (with no welding check).
Other 2 Safety Outputs (See note.)	Specify to connect to two outputs without welding check.
Other Safety Output	Specify to connect to one output without welding check.
Door SW Lock	Specify to connect to an electromagnetic door switch.

Type	Description
Other 2 Safety Outputs w/o pulse (See note.)	Specify to connect to two outputs that do not require pulse to be checked.
Other Safety Output w/o pulse	Specify to connect to one output that does not require pulse to be checked.
2 Contactors with welding check (See note.)	Specify to connect to two contactor outputs (with welding check for each).
2 Contactors w/o welding check (See note.)	Specify to connect to two contactor outputs (with no welding check).
1 Contactor with welding check	Specify to connect to one contactor output (with welding check).
1 Contactor w/o welding check	Specify to connect to one contactor output (with no welding check).
Other Standard Output	Specify to use the output for non-safety applications.
Not Use	Specify to not use the output.

**Note** Can be selected only when the terminal number is an even number.

- The following dialog box will be displayed if a type with welding check is selected when the terminal is set.

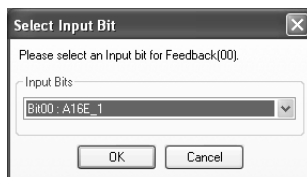

- In this dialog box, select the input for which welding is to be checked, and then click the OK Button.

3. Click the **Next** Button.  
The window for setting input terminals will be displayed.

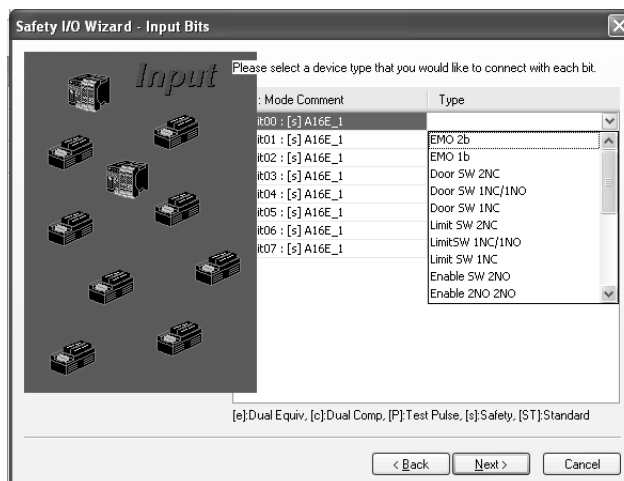

4. In the above window, specify the type of device to be connected to each terminal. The following types can be specified.

Type	Description
EMO 2b (DPST-NC, see note 1.)	Specify to connect two inputs from an emergency OFF button.
EMO 1b (SPST-NC)	Specify to use one input from an emergency OFF button.

Type	Description
Door SW 2NC (See note 1.)	Specify to use two inputs (both NC) from a door switch.
Door SW 1NC/1NO (See note 1.)	Specify to use two inputs (NC and NO) from a door switch.
Door SW 1NC	Specify to use one input from a door switch.
Limit SW 2NC (See note 1.)	Specify to use two inputs (both NC) from a limit switch.
Limit SW 1NC/1NO (See note 1.)	Specify to use two inputs (NC and NO) from a limit switch.
Limit SW 1NC	Specify to use one input from a limit switch.
Enable SW 2NO (See note 1.)	Specify to use two inputs from an enable switch.
Enable 2NO 2NO (See note 2.)	Specify to use four inputs from an enable switch.
Two Hand Switch (See note 1.)	Specify to use two inputs from a two hand switch.
Other 2NC (See note 1.)	Specify to use input from other 2-NC devices.
Other 2NO (See note 1.)	Specify to use input from other 2-NO devices.
Other 1NC/1NO (See note 1.)	Specify to use input from other NC/NO devices.
Other 1NO/1NC (See note 1.)	Specify to use input from other NO/NC devices.
Other 1NC (Single Contact)	Specify to use other 1-NC devices.
SLC 2 outputs (See note 1.)	Specify to use two inputs from a light curtain.
SLC 1 output	Specify to use one input from a light curtain.
Other PNP 2 outputs (See note 1.)	Specify to use two inputs from other semiconductors.
Other PNP output	Specify to use one input from other semiconductors.
Reset SW	Specify to use inputs from a reset switch.
Feedback (EDM input)	Specify to use as feedback signal to EDM.
Standard SW	Specify to use inputs from a switch for non-safety applications.
Not Use	Specify to not use the input.

- Note**
- (1) Can be selected only when the terminal number is an even number.
  - (2) Can be selected only when the terminal number is an even number and there are at least four remaining terminals.
5. Click the **Next** Button. If there are output terminals (e.g., DST1-MD16SL-1), the following dialog box will be displayed.



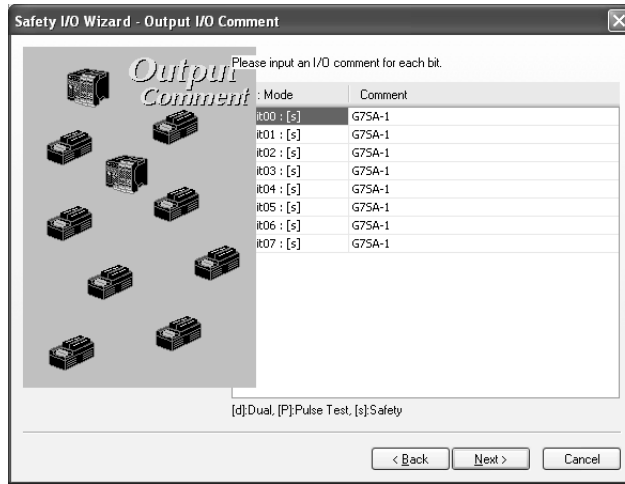

Comments for each output terminal can be edited in this window.

- After making the settings, click the **Next** Button. The following dialog box will be displayed. Comments for each input terminal can be edited in this dialog box.

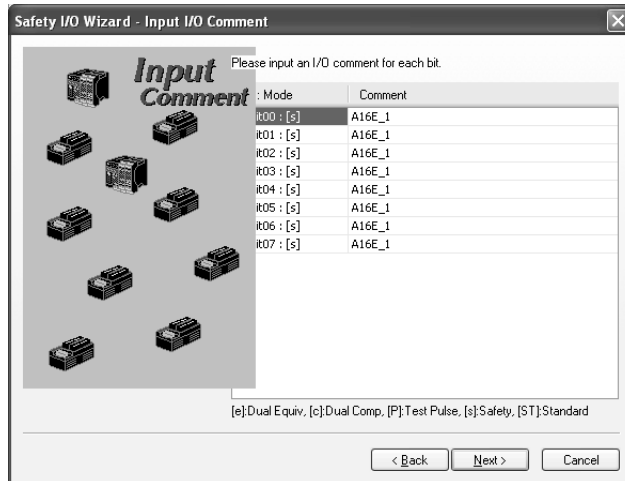

- After making the setting, click the **Next** Button. As shown in the following figure, the details set using the wizard will be listed.

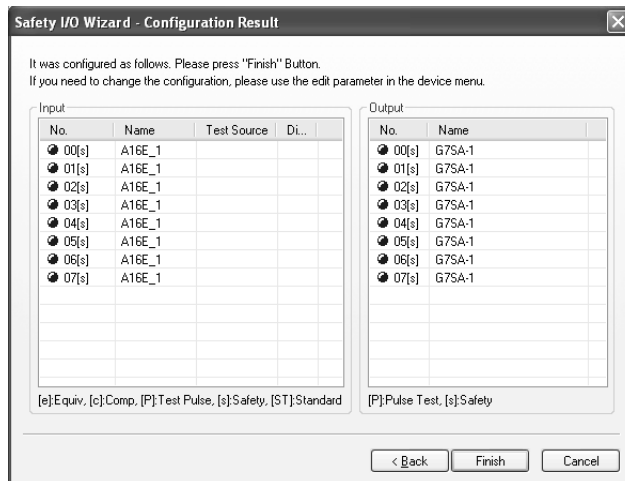

8. After checking the settings, click the **Finish** Button.  
(After this, the Edit Logic Dialog Box will be displayed for the Logic Terminal (DST1-XD0808SL-1).

**Note** Refer to the *DeviceNet Safety NE0A Series Safety Network Controller Operation Manual* (Cat. No. Z916) for setting methods for the DST1-XD0808SL-1 Logic Terminal.

### 3-1-2 Parameter Groups

DST1-series Safety I/O Terminal parameters are classified into groups as shown in the following diagram.

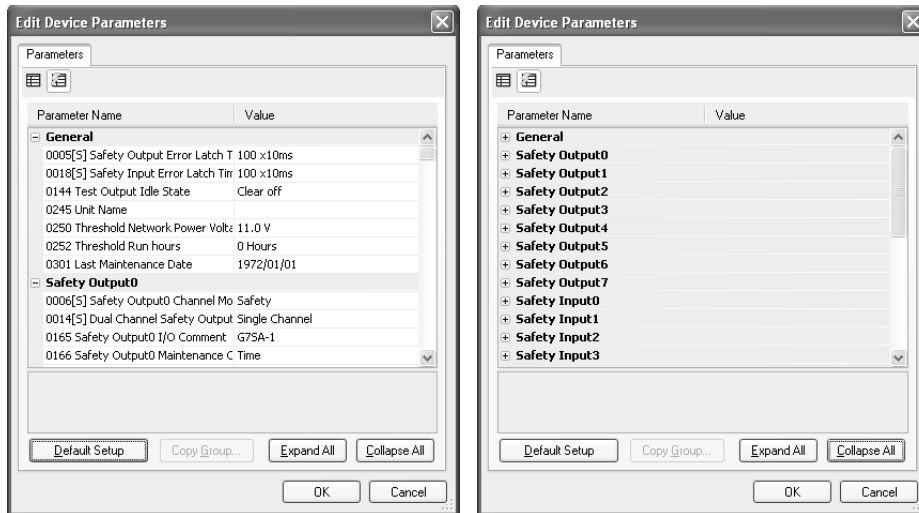

- Double-click a group name or click the icon to display or hide that group.
- Parameter settings for a particular terminal can be batch copied to the parameters for another terminal.

The **Copy Group** Button is enabled when a group name is selected and a group with a different terminal number but similar parameters exists, e.g., when safety input 0 is selected and safety input 1 or safety input 2 exists. Click the **Copy Group** Button to display the Group Copy Dialog Box shown below.

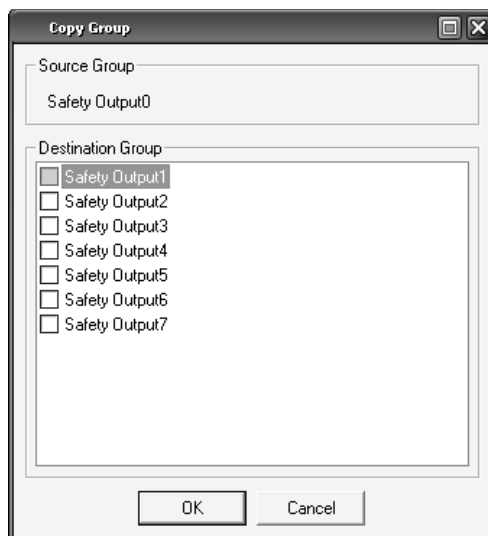

The source and destination groups will be displayed. Select the desired destination groups and then click the **OK** Button. The parameters will be copied.

- Parameter names with [S] in front of them are related to the safety application.
- The size of the Edit Device Parameters Window can be changed.

### 3-1-3 General Parameter Group

This section describes parameters in the general parameter group.

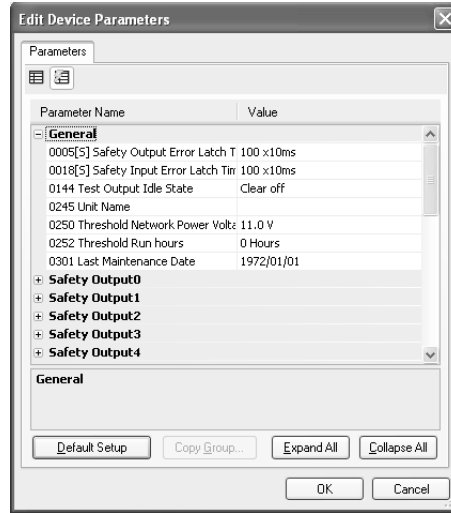

	Item	Settings	Description	Default
S	Safety Output Error Latch Time	0 to 65,530 ms (in 10-ms increments)	This parameter is common to all the safety outputs. It sets the time to latch the error state when an error occurs in these outputs. Even when the cause of the error has been removed, the error state will remain latched for the time set here.	1,000 ms
S	Safety Input Error Latch Time	0 to 65,530 ms (in 10-ms increments)	This parameter is common to all safety inputs and test outputs. It sets the time to latch the error state when an error occurs in these inputs/test outputs. Even when the cause of the error has been removed, the error state will remain latched for the time set here.	1,000 ms
	Test Output Idle State	Clear off Keep output data	This parameter is common to all test outputs for which the Test Output Channel Mode is set to <i>Standard Output</i> . It sets the output state of the test output when idle data is received.	Clear off
	Unit Name	32 characters max.	This parameter sets a user-chosen name for the Safety I/O Terminal. The set name is saved in the Safety I/O Terminal and displayed in the network configuration.	None
	Threshold Network Power Voltage	8.0 to 30.0 V	This parameter sets the threshold of the network power voltage. When the voltage falls below the set threshold voltage, the corresponding bit in General Status turns ON.	11.0 V
	Threshold Run Hours	0 to 429,496,729 hours	This parameter sets the threshold for unit operating hours. When the operating hours exceeds the set threshold, the corresponding bit in General Status will turn ON.	0 hours
	Last Maintenance Date	January 1, 1972 to January 19, 2038	This parameter saves the maintenance date in the Safety I/O Terminal.	January 1, 1972

	Item	Settings	Description	Default
S	Execution Mode (DST1-XD0808SL-1 only)	After Establishing Safety I/O Connection	Starts in Idle Mode after the configuration has been completed. Goes into RUN Mode when safety I/O communications are started.	After Establishing Safety I/O Connection
		Auto Execution	Selecting this mode and executing the following operations causes startup in RUN Mode from that point onwards. <ul style="list-style-type: none"> <li>• Locking the configuration</li> <li>• Turning OFF the power after changing to RUN Mode</li> </ul> Safety I/O communications are not possible in this mode.	

**IMPORTANT** If the power is turned OFF in Idle Mode, the next operation will not start in RUN Mode even if Auto Execution is set as the execution mode and the configuration is locked. The power must be turned OFF in RUN Mode.

**IMPORTANT** Safety I/O communications cannot be used when Auto Execution is set as the execution mode. To use safety I/O communications, set After Establishing Safety I/O Connection as the execution mode.

### 3-1-4 Safety Input Parameter Groups

This section describes parameters in the safety input parameter groups. The safety input parameters are grouped by terminal number.

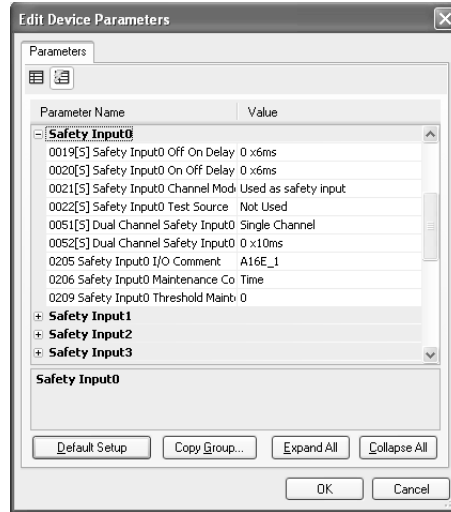

	Item	Settings	Description	Default
S	Off On Delay	0 to 126 ms (in 6-ms increments)	Sets the OFF/ON delay time.	0 ms
S	On Off Delay	0 to 126 ms (in 6-ms increments)	Sets the ON/OFF delay time.	0 ms
S	Safety Input Channel Mode	Not Used.	The safety input is not used. (External input device not connected.)	Not Used.
		Test pulse from test out	Specifies connecting a device with a contact output in combination with a test output. When this mode is selected, select the test output to use for the test source and then set the test output mode to <i>Pulse Test Output</i> . When these settings are made, contact between the input signal line and the power supply (plus) and short circuits with other input signal lines can be detected.	
		Used as a safety input.	Specifies connecting a safety device with a semiconductor output, such as a light curtain.	
		Used as a standard input.	Specifies connecting a standard device (i.e., a non-safety device).	
S	Test Source	Not Used.	If the channel mode of a safety input is set to <i>Test Pulse from Test Out</i> , the test output is selected for use in combination with the safety input. Set the channel mode of the test output selected here to <i>Pulse Test Output</i> .	Not Used.
		Test Output 0		
		Test Output 1		
		Test Output 2		
		Test Output 3		
S	Dual Channel Safety Input Mode	Single Channel	Specifies using Single Channel Mode. If <i>Single Channel</i> is selected, the safety input that would be paired for the dual channel parameter will also be set to Single Channel Mode.	Dual Channel Equivalent
		Dual Channel Equivalent	Specifies using the Dual Channel Equivalent Mode with a paired safety input.	
		Dual Channel Complementary	Specifies using Dual Channel Complementary Mode with a paired safety input.	

	Item	Settings	Description	Default
S	Dual Channel Safety Input Discrepancy Time	0 to 65,530 ms (in 10-ms increments)	Sets the time to monitor the logic discrepancy in the dual channel input logic.	0 ms
	I/O Comment	32 characters max.	Sets an I/O comment for the safety input. The I/O comment set here is used as the I/O tag in the Logic Editor.	None
	Maintenance Counter Mode Choice	Time (cumulative ON time monitor) Count (contact operation counter)	Sets the operating mode for the maintenance counter.	Time
	Threshold Maintenance Counter	0 to 4,294,967,295 hours	Sets the threshold value for the maintenance counter.	0

**IMPORTANT** When the Safety Input Channel Mode is set to *Test Pulse from Test Out*, specify the test output to use for the test source and set the Test Output Channel Mode of the test output to *Pulse Test Output*.

### 3-1-5 Test Output Parameter Groups

This section describes parameters in the test output groups. The test output parameters are grouped by terminal number.

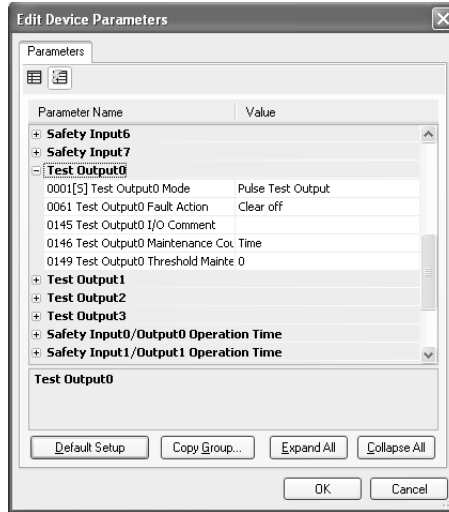

	Item	Settings	Description	Default
S	Test Output Mode	Not Used.	The corresponding test output is not used.	Not Used.
		Standard Output	Specifies connecting to the input for a muting lamp or PLC. Used as a monitor output.	
		Pulse Test Output	Specifies connecting a device with a contact output in combination with the safety input.	
		Power Supply Output	Specifies connecting to the power supply terminal of a safety sensor. The voltages supplied to the IO power from the test output are output.	
		Muting Lamp Output (Setting supported only for T3 terminal.)	Specifies a muting lamp output. When the output is ON, disconnection of the muting lamp can be detected.	
	Fault Action	Clear off	Sets the output state of the test output when a communications error occurs.	Clear off
		Hold last data	This parameter is enabled when the Test Output Channel Mode is set to <i>Standard Output</i> or <i>Muting Lamp Output</i> .	
	I/O Comment	32 characters max.	Sets an I/O comment for the test output. The I/O comment set here is used as the I/O tag in the Logic Editor.	None
	Maintenance Counter Mode Choice	Time (cumulative ON time monitor)	Sets the operating mode for the maintenance counter.	Time
		Count (contact operation counter)		
	Threshold Maintenance Counter	0 to 4,294,967,295 hours	Sets the threshold value for the maintenance counter.	0

**Note** The time and count maintenance counter modes (contact operation counter and total ON time monitor function) cannot be used for the test output terminals of the DST1-XD0808SL-1.



### 3-1-6 Safety Output Parameter Groups

This section describes parameters in the safety output groups. The safety output parameters are grouped by terminal number.

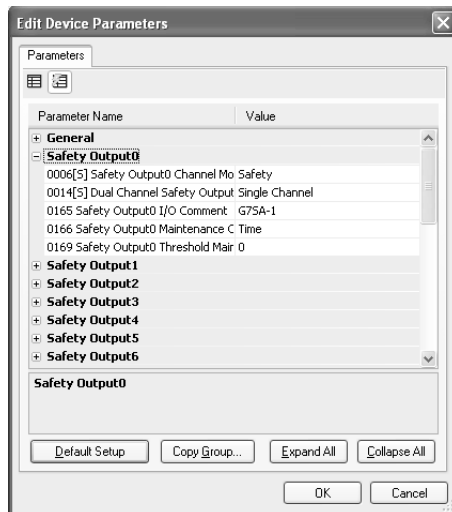

	Item	Settings	Description	Default
S	Safety Output Channel Mode	Not Used.	The safety output is not used. (External output device not connected.)	Not Used.
		Safety	Specifies not outputting the test pulse when the output is ON. Contact between the output signal line and the power supply (positive) when the output is OFF and ground faults can be detected.	
		Safety Pulse Test (Setting supported only for the DST1-MD16SL-1.)	Outputs the test pulse when the output is ON. Contact between the output signal line and the power supply, and short circuits with other output signal lines can be detected.	
S	Dual Channel Safety Output Mode	Single Channel	Specifies using Single Channel Mode. When <i>Single Channel</i> is set, the safety output that would be paired for the dual channel parameter is also set to Single Channel Mode.	Dual Channel
		Dual Channel	Specifies using Dual Channel Mode. When both of the safety outputs to be paired are normal, the outputs can be turned ON.	
	I/O Comment	32 characters max.	Sets an I/O comment for the safety output. The I/O comment set here is used as the I/O tag in the Logic Editor.	None
	Maintenance Counter Mode Choice	Time	Sets the operating mode for the maintenance counter.	Time
		Count		
	Threshold Maintenance Counter	0 to 4,294,967,295 hours	Sets the threshold value for the maintenance counter.	0

### 3-1-7 Operation Time Parameter Groups

This section describes parameters in the safety input/output operation time groups. The operation time parameters are grouped by the terminal numbers to be paired.

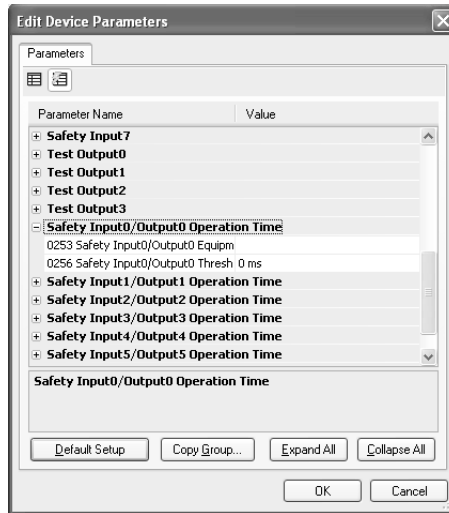

	Item	Settings	Description	Default
	Equipment Name	32 characters max.	Sets a comment for the operation time to monitor.	None
	Threshold Response Time	0 to 65,535 ms (in 1-ms increments)	Sets the threshold value for the operation time.	0 ms

**Note** Safety input parameter groups can be set for DST1-XD0808SL-1 safety inputs IN0 to IN5. For details on DST1-XD0808SL-1 logic functions, refer to *1-5 Logic Functions*.

### 3-1-8 Safety Input Logic Parameter Groups (Safety Input Logic)

Safety input parameter groups can be set only for the DST1-XD0808SL-1. Set these parameters using the Safety Logic Wizard.

Parameter name		Value	Description	Default
S	Input Condition	Not Used	Does not perform logic operations with safety input terminals.	Not Used
		Logic operations for other safety input terminals and remote I/O signals	Performs logic operations with safety input terminals. The values for the OR operation are set from AND or OR operations of signals received from other safety input terminals and remote I/O (from the Master).	
S	Reset Condition	Auto Reset	Sets reset conditions and reset input terminals. The reset conditions are selected from Auto Reset, L-H-L (Low - High - Low), and Rising Edge. Values used for reset inputs are selected from signals received from IN6, IN7, and remote I/O (from the Master).	Auto Reset
		IN6 L-H-L		
		IN6 Rising Edge		
		IN7 L-H-L		
		IN7 Rising Edge		
		Remote I/O signal L-H-L		
Remote I/O signal Rising Edge				
---	Safety Input Logic Comment	48 single-byte characters max.	Sets the I/O comment for the results of safety input logic operations (input condition operations and reset operations). The I/O comment set here is used as the I/O tag by the NE1A-series Logic Editor.	None

**Note** Safety input parameter groups can be set only for DST1-XD0808SL-1 safety inputs IN0 to IN5. For details on DST1-XD0808SL-1 logic functions, refer to *1-5 Logic Functions*.

### 3-1-9 Safety Output Logic Parameter Groups (Safety Output Logic)

Safety output parameter groups can only be set for the DST1-XD0808SL-1. Set these parameters using the Safety Logic Wizard.

Parameter name	Value	Description	Default
S Output Condition	Output from network	Uses a safety output terminal as a network output. The value (safety output) received from the network is directly output.	Output from network
	Logic operations for safety input logic operation results and remote I/O signals (Output from internal logic)	Uses the output as a safety output terminal logic output. The logic operation result is output. Set logic operations for safety input logic operation results and remote I/O (received from the Master).	
	Additional output	Uses a safety output terminal as an additional output terminal. Select the data to be output as the additional output data.	
S Welding Check (EDM) Feedback	Not Used	EDM feedback is not used.	Not Used
	IN4	EDM feedback is used. Select the terminals for connecting feedback signals from external devices.	
	IN5		
	IN6		
	IN7		
S Additional Output Data	Not Used	This setting is enabled when the safety output condition is set to <i>additional output</i> .	Not Used
	OUT0	Outputs the same value as OUT0.	
	OUT0 (NOT)	Outputs the inverse value of OUT0.	
	OUT2	Outputs the same value as OUT2.	
	OUT2 (NOT)	Outputs the inverse value of OUT2.	
	OUT4	Outputs the same value as OUT4.	
	OUT4 (NOT)	Outputs the inverse value of OUT4.	
	OUT6	Outputs the same value as OUT6.	
	OUT6 (NOT)	Outputs the inverse value of OUT6.	
	Reset Required Indication	Outputs a 1-Hz pulsing signal to trigger a reset input.	
	RUN Status Flag	Outputs the operating mode. 0: Not RUN mode 1: RUN mode	
	Normal Status Flag	Outputs the status. 0: Error (See note 1.) 1: Normal	
S Off On Delay	0 to 300,000 ms (Unit: 100 ms)	Sets the ON delay time.	0 ms
S On Off Delay	0 to 300,000 ms (Unit: 100 ms)	Sets the OFF delay time.	0 ms

- Note**
- (1) Turns OFF (0) when one of the errors shown in 7-3 Error History occurs.
  - (2) Safety output parameter groups can be set only for DST1-XD0808SL-1 safety outputs OUT0 to OUT7. For details on DST1-XD0808SL-1 logic functions, refer to 1-5 Logic Functions.

### 3-1-10 Editing I/O Comments

I/O comments can be edited by setting the safety input terminals and safety output terminals. The edited comments here are used as I/O tags in the Logic Editor.

In the following procedure, separate I/O tags for safety input terminals and safety output terminals are edited in one window.

1. Select **Device - Edit I/O Comments**. The following window will be displayed.

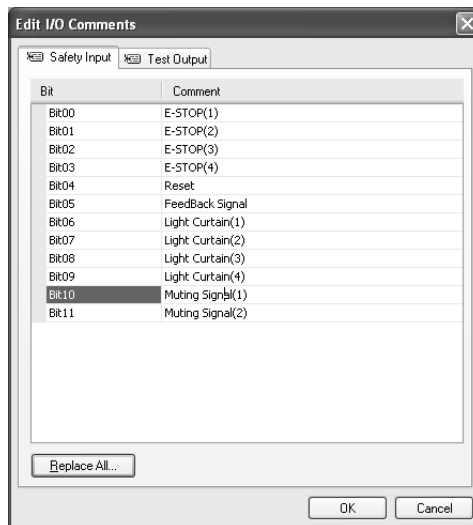

2. Edit each terminal comment, and then click the **OK** Button. The following window will be displayed.

With Network Configurator Ver. 2.0□ or higher, the following procedure can be used to replace I/O comments.

1. Click the **Replace All** Button in the window above. The following window will be displayed.

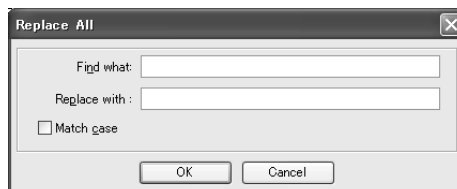

2. Input the character string to be searched for and the characters it is to be replaced with, and then click the **OK** Button. The comments will be replaced.

**Note** With Network Configurator version 2.0□ or higher, the following toolbar icons will be displayed at the top of the Edit Device Parameters Window.

 : Standard Mode

 : Expansion Mode

These buttons can be used to switch between displaying or hiding expansion parameters. Normally, device settings are made using only parameters displayed in Standard Mode.

## 3-2 Remote I/O Allocations

### 3-2-1 I/O Allocations

The DST1-series Safety I/O Terminals internally store I/O data. Connection paths can be set using the Network Configurator to allocate I/O data for the Master Unit. Be sure to set the required connection paths.

### 3-2-2 I/O Data

The DST1-series Safety I/O Terminals store the following data.

- **SAFE:** The Controller can use this information in safety-related functions.

Data		Description
Input data	Safety Input Data <b>SAFE</b>	ON/OFF value of safety input terminal after input evaluation 0: Input terminal OFF or error 1: Input terminal ON
	Combined Safety Input Status	Normal Status Flag for all safety input terminals. Used to monitor safety input terminal errors, such as disconnections, ground faults, and short-circuits. 0: Error for one or more terminals 1: All terminals normal (no error)
	Individual Safety Input Status	Normal Status Flag based on evaluation of the safety input terminal. Used to monitor safety input terminal errors, such as disconnections, ground faults, and short-circuits. 0: Error 1: Normal (no error)
	Combined Safety Output Status	Normal Status Flag for all safety output terminals. Used to monitor safety output terminal errors, such as ground faults and short-circuits. 0: Error for one or more terminals 1: All terminals normal (no error)
	Individual Safety Output Status	Normal Status Flag based on evaluation of the safety output terminal. Used to monitor safety output terminal errors, such as ground faults and short-circuits. 0: Error 1: Normal (no error)
	Muting Lamp Status	Indicates the status when terminal T3 is configured as the muting lamp output. 0: Error 1: Normal (no error)
	Safety Output Monitor	Safety output terminal monitored value 0: Output terminal OFF 1: Output terminal ON
	Individual Test Output Status	Indicates the status of the test output terminal. 0: Error 1: Normal (no error)
	Safety Input Logic Result (DST1-XD0808SL-1 only.) <b>SAFE</b>	Operation result for safety input logic operation 0: OFF 1: ON
	Reset Required Indication Signal (DST1-XD0808SL-1 only.)	Reset required indication signal pulse for reset of logic operations.

Data		Description		
Input data	General Status Data		DST1-ID12SL-1 DST1-MD16SL-1 DST1-MRD08SL-1	DST1-XD0808SL-1
		Bit 0	Safety Input Power Status Flag 0: Input power supply ON 1: Input power supply OFF	
		Bit 1	Safety Output Power Status Flag 0: Output power supply ON 1: Output power supply OFF	
		Bit 2	Network Power Voltage Drop Flag 0: Normal (higher than set monitor value) 1: Error (same as or lower than set monitor value)	
		Bit 3	Unit Maintenance Flag 0: Within range (lower than set monitor value) 1: Over range (same as or higher than set monitor value)	
		Bit 4	Reserved	Operating Mode Flag 0: Not RUN mode 1: RUN mode
		Bit 5	Combined I/O Port Status Flag 0: Normal (all I/O points normal) 1: Error (one or more I/O point error)	
		Bit 6	Operation Time Exceeded Flag 0: Within range (all I/O values are lower than set monitor value) 1: Over range (one or more value is same as or higher than set value)	Status Flag 0: Error (See note 1.) 1: Normal
		Bit 7	Connected Component Maintenance Flag 0: Within range (all I/O points are lower than set monitor value) 1: Over range (one or more I/O point is same as or higher than set monitor value)	
Output data	Safety Output Data <b>SAFE</b>	Controls the safety output terminal. 0: OFF 1: ON		
	Safety Output Data and Output Condition Signal (DST1-XD0808SL-1 only) <b>SAFE</b>	When the safety output terminal is set to <i>Output from network</i> : Safety output terminal ON/OFF status 0: OFF 1: ON  When the safety output terminal is set to <i>Output from internal logic</i> : Remote I/O signal for output condition operation 0: OFF 1: ON		
	Output Condition Signal (DST1-XD0808SL-1 only)	Remote I/O signal for output condition operation When the safety output terminal is set to <i>Output from internal logic</i> : 0: OFF 1: ON		
	Standard Output Data	Controls the test output when test output mode is set to a standard output. 0: OFF 1: ON		
	Input Condition Signal (DST1-XD0808SL-1 only) <b>SAFE</b>	Input condition signal for safety inputs. Used for input condition operations. 0: OFF 1: ON		
	Reset Signal (DST1-XD0808SL-1 only)	Reset signal for safety inputs. Used for reset operations. 0: OFF (Low) 1: ON (High)		

- Note**
- (1) Turns OFF when one of the errors shown in 7-3 *Error History* occurs.
  - (2) For information on errors, refer to 7-2 *Troubleshooting*.
  - (3) Safety input data is not the data directly from the safety input terminals, but rather it is the value after input evaluation (input device and input circuit diagnosis, input ON/OFF delays, and dual channel evaluation).

### 3-2-3 I/O Data Supported by Each Model

The following tables show the I/O data supported by each model of the DST1-series Safety I/O Terminals.

Refer to 3-2-4 I/O Assembly Data for data arrangements.

From among the I/O data, safety connections for up to four items, including one output, can be allocated for the Master Unit and standard connections for up to two items can be allocated for the Master Unit.

**IMPORTANT** Communications with up to 15 Safety Controllers for each connection can be performed using multi-cast connection. If four connections are used, however, only a maximum of 30 Safety Controllers total can communicate with the DST1-series Safety I/O Terminals. Up to two safety connections can be used with the DST1-XD0808SL-1.

#### DST1-ID12SL-1

The default values for the I/O assembly data are as follows:

**Safety connections:**

Default (Assembly instance number)	
IN	Safety input assembly 1 (Instance No. 20C)
OUT	None

**Standard Connections:** The default values for each type of connection are given below.

Connection	Default (Assembly instance number)	
Poll	IN	Safety input assembly 6 (No. 312)
	OUT	Standard output assembly (No. 21)
Bit strobe	IN	Safety input assembly 6 (No. 312)
	OUT	None
COS	IN	Test out status with General status assembly (No. 340)
	OUT	None
Cyclic	IN	Test out status with General status assembly (No. 340)
	OUT	None

The following I/O data can be selected from the Network Configurator.

	Network Configurator setting	Assembly Instance No.	I/O size (bytes)	Inputs							Outputs					
				Safety Input Data	Combined Safety Input Status	Individual Safety Input Status	Combined Safety Output Status	Individual Safety Output Status	Muting Lamp Status	Safety Output Monitors	Individual Test Output Status	General Status	Safety Output Data	Standard Output Data		
✓	Standard connection	Safety input assembly 1	20C	Input 2	✓											
✓	Standard connection	Safety input assembly 2	224	Input 2	✓		✓									
✓	Standard connection	Safety input assembly 3	22C	Input 3	✓		✓									
✓	Safety connection	Safety input assembly 4	310	Input 2	✓	✓				✓						



Safety connection	Standard connection	Network Configurator setting	Assembly Instance No.	I/O size (bytes)	Inputs							Outputs				
					Safety Input Data	Combined Safety Input Status	Individual Safety Input Status	Combined Safety Output Status	Individual Safety Output Status	Muting Lamp Status	Safety Output Monitors	Individual Test Output Status	General Status	Safety Output Data	Standard Output Data	
√	√	Safety input assembly 5	311	Input 4	√		√				√					
√	√	Safety input assembly 6	312	Input 4	√		√				√		√			
√	√	Standard output assembly	21	Output 1												√
	√	General status assembly	300	Input 1									√			
	√	Test output status with general status assembly	340	Input 2								√	√			

**DST1-MD16SL-1**

The default values for the I/O assembly data are as follows:

**Safety connections:**

Default (Assembly instance number)	
IN	Safety input assembly 1 (Instance No. 204)
OUT	Safety output assembly 1 (Instance No. 234)

**Standard connection:** The default values for each type of connection are given below.

Connection	Default (Assembly instance number)	
Poll	IN	Safety input assembly 5 (No. 323)
	OUT	Standard output assembly (No. 21)
Bit strobe	IN	Safety input assembly 5 (No. 323)
	OUT	None
COS	IN	Output Monitor/Test Out status with General status assembly (No. 341)
	OUT	None
Cyclic	IN	Output Monitor/Test Out status with General status assembly (No. 341)
	OUT	None

The following I/O data can be selected from the Network Configurator.

Safety connection	Standard connection	Network Configurator setting	Assembly Instance No.	I/O size (bytes)	Inputs								Outputs			
					Safety Input Data	Combined Safety Input Status	Individual Safety Input Status	Combined Safety Output Status	Individual Safety Output Status	Muting Lamp Status	Safety Output Monitors	Individual Test Output Status	General Status	Safety Output Data	Standard Output Data	
√	√	Safety input assembly 1	204	Input 1	√											
√	√	Safety input assembly 2	320	Input 2	√	√		√		√						
√	√	Safety input assembly 3	321	Input 4	√		√		√	√						
√	√	Safety input assembly 4	322	Input 5	√		√		√	√	√					
√	√	Safety input assembly 5	323	Input 5	√		√		√	√	√	√				
√	√	Standard output assembly	21	Output 1												√
√		Safety output assembly 1	234	Output 1										√		
√		Safety output assembly 2	351	Output 2										√	√	
	√	General status assembly	300	Input 1									√			
	√	Output monitor/test output status with general status assembly	341	Input 3							√	√	√			

**DST1-MRD08SL-1**

The default values for the I/O assembly data are as follows:

**Safety connections:**

Default (Assembly instance number)	
IN	Safety input assembly 1 (Instance No. 203)
OUT	Safety output assembly 1 (Instance No. 233)

**Standard connection:** The default values for each type of connection are given below.

Connection	Default (Assembly instance number)	
Poll	IN	Safety input assembly 5 (No. 333)
	OUT	Standard output assembly (No. 21)
Bit strobe	IN	Safety input assembly 5 (No. 333)
	OUT	None
COS	IN	Output Monitor/Test Out status with General status assembly (No. 342)
	OUT	None
Cyclic	IN	Output Monitor/Test Out status with General status assembly (No. 342)
	OUT	None

The following I/O data can be selected from the Network Configurator.

Safety connection	Standard connection	Network Configurator setting	Assembly Instance No.	I/O size (bytes)	Inputs								Outputs			
					Safety Input Data	Combined Safety Input Status	Individual Safety Input Status	Combined Safety Output Status	Individual Safety Output Status	Muting Lamp Status	Safety Output Monitors	Individual Test Output Status	General Status	Safety Output Data	Standard Output Data	
√	√	Safety input assembly 1	203	Input 1	√											
√	√	Safety input assembly 2	330	Input 1	√	√		√		√						
√	√	Safety input assembly 3	331	Input 2	√		√		√	√						
√	√	Safety input assembly 4	332	Input 3	√		√		√	√	√					
√	√	Safety input assembly 5	333	Input 3	√		√		√	√	√	√				
√	√	Standard output assembly	21	Output 1												√
√		Safety output assembly 1	233	Output 1											√	
√		Safety output assembly 2	350	Output 1											√	√
	√	General status assembly	300	Input 1									√			
	√	Output monitor/test output status with general status assembly	342	Input 2							√	√	√			

**DST1-XD0808SL-1**

The default values for the I/O assembly data are as follows:

**Safety connections:**

Default (Assembly instance number)	
IN	Safety input assembly 1 (Instance No. 204)
OUT	Safety output assembly 1 (Instance No. 352)

**Standard connection:** The default values for each type of connection are given below.

Connection	Default (Assembly instance number)	
Poll	IN	Safety input assembly 3 (No. 3A1)
	OUT	None
Bit strobe	IN	Safety input assembly 3 (No. 3A1)
	OUT	None
COS	IN	Safety input assembly 3 (No. 3A1)
	OUT	None
Cyclic	IN	Safety input assembly 3 (No. 3A1)
	OUT	None

The following I/O data can be selected from the Network Configurator.

Safety connection	Standard connection	Network Configurator setting	Assembly Instance No.	I/O size (bytes)	Inputs										Outputs										
					Safety Input Data	Safety Input Status	Safety Output Status	Muting Lamp Status	Safety Output Monitors	Test Output Status	Safety Input Logic Result	Reset Required Indication	General Status	Safety Output Data and Output Condition Signal	Output Condition Signal	Standard Output Data	Input Condition Signal	Reset Signal							
√	√	Safety input assembly 1	204	Input 1	√																				
√	√	Safety input assembly 2	3A0	Input 2	√						√	√													
√	√	Safety input assembly 3	3A1	Input 7	√	√	√	√	√	√	√	√	√												
√		Safety output assembly 1	352	Output 1																			√		
√		Safety output assembly 2	353	Output 2																			√		√
√		Safety output assembly 3	354	Output 3																			√		√
√	√	Standard output assembly	355	Output 3																			√	√	√

## 3-2-4 I/O Assembly Data

Input Data

Instance (hex)	Byte	Bit 7	Bit 6	Bit 5	Bit 4	Bit 3	Bit 2	Bit 1	Bit 0
203	0	Reserved				Safety Input 3	Safety Input 2	Safety Input 1	Safety Input 0

Applicable Terminal: DST1-MRD08SL-1

Instance (hex)	Byte	Bit 7	Bit 6	Bit 5	Bit 4	Bit 3	Bit 2	Bit 1	Bit 0
204	0	Safety Input 7	Safety Input 6	Safety Input 5	Safety Input 4	Safety Input 3	Safety Input 2	Safety Input 1	Safety Input 0

Applicable Terminals: DST1-MD16SL-1 and DST1-XD0808SL-1

Instance (hex)	Byte	Bit 7	Bit 6	Bit 5	Bit 4	Bit 3	Bit 2	Bit 1	Bit 0
20C	0	Safety Input 7	Safety Input 6	Safety Input 5	Safety Input 4	Safety Input 3	Safety Input 2	Safety Input 1	Safety Input 0
	1	Reserved				Safety Input 11	Safety Input 10	Safety Input 9	Safety Input 8

Applicable Terminal: DST1-ID12SL-1

Instance (hex)	Byte	Bit 7	Bit 6	Bit 5	Bit 4	Bit 3	Bit 2	Bit 1	Bit 0
224	0	Safety Input 7	Safety Input 6	Safety Input 5	Safety Input 4	Safety Input 3	Safety Input 2	Safety Input 1	Safety Input 0
	1	Safety Input 7 Status	Safety Input 6 Status	Safety Input 5 Status	Safety Input 4 Status	Safety Input 3 Status	Safety Input 2 Status	Safety Input 1 Status	Safety Input 0 Status

Applicable Terminal: DST1-ID12SL-1

Instance (hex)	Byte	Bit 7	Bit 6	Bit 5	Bit 4	Bit 3	Bit 2	Bit 1	Bit 0
22C	0	Safety Input 7	Safety Input 6	Safety Input 5	Safety Input 4	Safety Input 3	Safety Input 2	Safety Input 1	Safety Input 0
	1	Safety Input 3 Status	Safety Input 2 Status	Safety Input 1 Status	Safety Input 0 Status	Safety Input 11	Safety Input 10	Safety Input 9	Safety Input 8
	2	Safety Input 11 Status	Safety Input 10 Status	Safety Input 9 Status	Safety Input 8 Status	Safety Input 7 Status	Safety Input 6 Status	Safety Input 5 Status	Safety Input 4 Status

Applicable Terminal: DST1-ID12SL-1

Instance (hex)	Byte	Bit 7	Bit 6	Bit 5	Bit 4	Bit 3	Bit 2	Bit 1	Bit 0
300	0	General Status							

Applicable Terminal: DST1-ID12SL-1, DST1-MD16SL-1, DST1-MRD08SL-1

Instance (hex)	Byte	Bit 7	Bit 6	Bit 5	Bit 4	Bit 3	Bit 2	Bit 1	Bit 0
310	0	Safety Input 7	Safety Input 6	Safety Input 5	Safety Input 4	Safety Input 3	Safety Input 2	Safety Input 1	Safety Input 0
	1	Muting Lamp Status	Safety In Status	Reserved		Safety Input 11	Safety Input 10	Safety Input 9	Safety Input 8

Applicable Terminal: DST1-ID12SL-1

Instance (hex)	Byte	Bit 7	Bit 6	Bit 5	Bit 4	Bit 3	Bit 2	Bit 1	Bit 0
311	0	Safety Input 7	Safety Input 6	Safety Input 5	Safety Input 4	Safety Input 3	Safety Input 2	Safety Input 1	Safety Input 0
	1	Safety Input 3 Status	Safety Input 2 Status	Safety Input 1 Status	Safety Input 0 Status	Safety Input 11	Safety Input 10	Safety Input 9	Safety Input 8
	2	Safety Input 11 Status	Safety Input 10 Status	Safety Input 9 Status	Safety Input 8 Status	Safety Input 7 Status	Safety Input 6 Status	Safety Input 5 Status	Safety Input 4 Status
	3	Muting Lamp Status	Reserved						

Applicable Terminal: DST1-ID12SL-1

Instance (hex)	Byte	Bit 7	Bit 6	Bit 5	Bit 4	Bit 3	Bit 2	Bit 1	Bit 0
312	0	Safety Input 7	Safety Input 6	Safety Input 5	Safety Input 4	Safety Input 3	Safety Input 2	Safety Input 1	Safety Input 0
	1	Safety Input 3 Status	Safety Input 2 Status	Safety Input 1 Status	Safety Input 0 Status	Safety Input 11	Safety Input 10	Safety Input 9	Safety Input 8
	2	Safety Input 11 Status	Safety Input 10 Status	Safety Input 9 Status	Safety Input 8 Status	Safety Input 7 Status	Safety Input 6 Status	Safety Input 5 Status	Safety Input 4 Status
	3	Muting Lamp Status	Reserved			Test Output 3 Status	Test Output 2 Status	Test Output 1 Status	Test Output 0 Status

Applicable Terminal: DST1-ID12SL-1

Instance (hex)	Byte	Bit 7	Bit 6	Bit 5	Bit 4	Bit 3	Bit 2	Bit 1	Bit 0
320	0	Safety Input 7	Safety Input 6	Safety Input 5	Safety Input 4	Safety Input 3	Safety Input 2	Safety Input 1	Safety Input 0
	1	Muting Lamp Status	Safety In Status	Safety Out Status	Reserved				

Applicable Terminal: DST1-MD16SL-1

Instance (hex)	Byte	Bit 7	Bit 6	Bit 5	Bit 4	Bit 3	Bit 2	Bit 1	Bit 0
321	0	Safety Input 7	Safety Input 6	Safety Input 5	Safety Input 4	Safety Input 3	Safety Input 2	Safety Input 1	Safety Input 0
	1	Safety Input 7 Status	Safety Input 6 Status	Safety Input 5 Status	Safety Input 4 Status	Safety Input 3 Status	Safety Input 2 Status	Safety Input 1 Status	Safety Input 0 Status
	2	Safety Output 7 Status	Safety Output 6 Status	Safety Output 5 Status	Safety Output 4 Status	Safety Output 3 Status	Safety Output 2 Status	Safety Output 1 Status	Safety Output 0 Status
	3	Muting Lamp Status	Reserved						

Applicable Terminal: DST1-MD16SL-1

Instance (hex)	Byte	Bit 7	Bit 6	Bit 5	Bit 4	Bit 3	Bit 2	Bit 1	Bit 0
322	0	Safety Input 7	Safety Input 6	Safety Input 5	Safety Input 4	Safety Input 3	Safety Input 2	Safety Input 1	Safety Input 0
	1	Safety Input 7 Status	Safety Input 6 Status	Safety Input 5 Status	Safety Input 4 Status	Safety Input 3 Status	Safety Input 2 Status	Safety Input 1 Status	Safety Input 0 Status
	2	Safety Output 7 Status	Safety Output 6 Status	Safety Output 5 Status	Safety Output 4 Status	Safety Output 3 Status	Safety Output 2 Status	Safety Output 1 Status	Safety Output 0 Status
	3	Safety Output 7 Monitor	Safety Output 6 Monitor	Safety Output 5 Monitor	Safety Output 4 Monitor	Safety Output 3 Monitor	Safety Output 2 Monitor	Safety Output 1 Monitor	Safety Output 0 Monitor
	4	Muting Lamp Status	Reserved						

Applicable Terminal: DST1-MD16SL-1

Instance (hex)	Byte	Bit 7	Bit 6	Bit 5	Bit 4	Bit 3	Bit 2	Bit 1	Bit 0
323	0	Safety Input 7	Safety Input 6	Safety Input 5	Safety Input 4	Safety Input 3	Safety Input 2	Safety Input 1	Safety Input 0
	1	Safety Input 7 Status	Safety Input 6 Status	Safety Input 5 Status	Safety Input 4 Status	Safety Input 3 Status	Safety Input 2 Status	Safety Input 1 Status	Safety Input 0 Status
	2	Safety Output 7 Status	Safety Output 6 Status	Safety Output 5 Status	Safety Output 4 Status	Safety Output 3 Status	Safety Output 2 Status	Safety Output 1 Status	Safety Output 0 Status
	3	Safety Output 7 Monitor	Safety Output 6 Monitor	Safety Output 5 Monitor	Safety Output 4 Monitor	Safety Output 3 Monitor	Safety Output 2 Monitor	Safety Output 1 Monitor	Safety Output 0 Monitor
	4	Muting Lamp Status	Reserved			Test Output 3 Status	Test Output 2 Status	Test Output 1 Status	Test Output 0 Status

Applicable Terminal: DST1-MD16SL-1

Instance (hex)	Byte	Bit 7	Bit 6	Bit 5	Bit 4	Bit 3	Bit 2	Bit 1	Bit 0
330	0	Muting Lamp Status	Safety In Status	Safety Out Status	Reserved	Safety Input 3	Safety Input 2	Safety Input 1	Safety Input 0

Applicable Terminal: DST1-MRD08SL-1

Instance (hex)	Byte	Bit 7	Bit 6	Bit 5	Bit 4	Bit 3	Bit 2	Bit 1	Bit 0
331	0	Safety Input 3 Status	Safety Input 2 Status	Safety Input 1 Status	Safety Input 0 Status	Safety Input 3	Safety Input 2	Safety Input 1	Safety Input 0
	1	Muting Lamp Status	Reserved			Safety Output 3 Status	Safety Output 2 Status	Safety Output 1 Status	Safety Output 0 Status

Applicable Terminal: DST1-MRD08SL-1

Instance (hex)	Byte	Bit 7	Bit 6	Bit 5	Bit 4	Bit 3	Bit 2	Bit 1	Bit 0
332	0	Safety Input 3 Status	Safety Input 2 Status	Safety Input 1 Status	Safety Input 0 Status	Safety Input 3	Safety Input 2	Safety Input 1	Safety Input 0
	1	Safety Output 3 Monitor	Safety Output 2 Monitor	Safety Output 1 Monitor	Safety Output 0 Monitor	Safety Output 3 Status	Safety Output 2 Status	Safety Output 1 Status	Safety Output 0 Status
	2	Muting Lamp Status	Reserved						

Applicable Terminal: DST1-MRD08SL-1



Instance (hex)	Byte	Bit 7	Bit 6	Bit 5	Bit 4	Bit 3	Bit 2	Bit 1	Bit 0
333	0	Safety Input 3 Status	Safety Input 2 Status	Safety Input 1 Status	Safety Input 0 Status	Safety Input 3	Safety Input 2	Safety Input 1	Safety Input 0
	1	Safety Output 3 Monitor	Safety Output 2 Monitor	Safety Output 1 Monitor	Safety Output 0 Monitor	Safety Output 3 Status	Safety Output 2 Status	Safety Output 1 Status	Safety Output 0 Status
	2	Muting Lamp Status	Reserved			Test Output 3 Status	Test Output 2 Status	Test Output 1 Status	Test Output 0 Status

Applicable Terminal: DST1-MRD08SL-1

Instance (hex)	Byte	Bit 7	Bit 6	Bit 5	Bit 4	Bit 3	Bit 2	Bit 1	Bit 0
340	0	General Status							
	1	Reserved				Test Output 3 Status	Test Output 2 Status	Test Output 1 Status	Test Output 0 Status

Applicable Terminal: DST1-ID12SL-1

Instance (hex)	Byte	Bit 7	Bit 6	Bit 5	Bit 4	Bit 3	Bit 2	Bit 1	Bit 0
341	0	General Status							
	1	Safety Output 7 Monitor	Safety Output 6 Monitor	Safety Output 5 Monitor	Safety Output 4 Monitor	Safety Output 3 Monitor	Safety Output 2 Monitor	Safety Output 1 Monitor	Safety Output 0 Monitor
	2	Reserved				Test Output 3 Status	Test Output 2 Status	Test Output 1 Status	Test Output 0 Status

Applicable Terminal: DST1-MD16SL-1

Instance (hex)	Byte	Bit 7	Bit 6	Bit 5	Bit 4	Bit 3	Bit 2	Bit 1	Bit 0
342	0	General Status							
	1	Test Output 3 Status	Test Output 2 Status	Test Output 1 Status	Test Output 0 Status	Safety Output 3 Monitor	Safety Output 2 Monitor	Safety Output 1 Monitor	Safety Output 0 Monitor

Applicable Terminal: DST1-MRD08SL-1

Instance (hex)	Byte	Bit 7	Bit 6	Bit 5	Bit 4	Bit 3	Bit 2	Bit 1	Bit 0
3A0	0	Safety Input 7	Safety Input 6	Safety Input 5	Safety Input 4	Safety Input 3	Safety Input 2	Safety Input 1	Safety Input 0
	1	Reserved	Reset Required Indication	Safety Input Logic Result 5	Safety Input Logic Result 4 (4/5)	Safety Input Logic Result 3	Safety Input Logic Result 2 (2/3)	Safety Input Logic Result 1	Safety Input Logic Result 0 (0/1)

Applicable Terminal: DST1-XD0808SL-1

Instance (hex)	Byte	Bit 7	Bit 6	Bit 5	Bit 4	Bit 3	Bit 2	Bit 1	Bit 0
3A1	0	Safety Input 7	Safety Input 6	Safety Input 5	Safety Input 4	Safety Input 3	Safety Input 2	Safety Input 1	Safety Input 0
	1	Safety Input 7 Status	Safety Input 6 Status	Safety Input 5 Status	Safety Input 4 Status	Safety Input 3 Status	Safety Input 2 Status	Safety Input 1 Status	Safety Input 0 Status
	2	Safety Output 7 Status	Safety Output 6 Status	Safety Output 5 Status	Safety Output 4 Status	Safety Output 3 Status	Safety Output 2 Status	Safety Output 1 Status	Safety Output 0 Status
	3	Safety Output 7 Monitor	Safety Output 6 Monitor	Safety Output 5 Monitor	Safety Output 4 Monitor	Safety Output 3 Monitor	Safety Output 2 Monitor	Safety Output 1 Monitor	Safety Output 0 Monitor
	4	Muting Lamp Status	Reserved			Test Output 3 Status	Test Output 2 Status	Test Output 1 Status	Test Output 0 Status
	5	Reserved	Reset Required Indication	Safety Input Logic Result 5	Safety Input Logic Result 4 (4/5)	Safety Input Logic Result 3	Safety Input Logic Result 2 (2/3)	Safety Input Logic Result 1	Safety Input Logic Result 0 (0/1)
	6	General Status							

Applicable Terminal: DST1-XD0808SL-1

**Output Data**

Instance (hex)	Byte	Bit 7	Bit 6	Bit 5	Bit 4	Bit 3	Bit 2	Bit 1	Bit 0
21	0	Reserved				Standard Output 3	Standard Output 2	Standard Output 1	Standard Output 0

Applicable Terminal: DST1-ID12SL-1, DST1-MD16SL-1, DST1-MRD08SL-1

Instance (hex)	Byte	Bit 7	Bit 6	Bit 5	Bit 4	Bit 3	Bit 2	Bit 1	Bit 0
233	0	Reserved				Safety Output 3	Safety Output 2	Safety Output 1	Safety Output 0

Applicable Terminal: DST1-MRD08SL-1

Instance (hex)	Byte	Bit 7	Bit 6	Bit 5	Bit 4	Bit 3	Bit 2	Bit 1	Bit 0
234	0	Safety Output 7	Safety Output 6	Safety Output 5	Safety Output 4	Safety Output 3	Safety Output 2	Safety Output 1	Safety Output 0

Applicable Terminal: DST1-MD16SL-1

Instance (hex)	Byte	Bit 7	Bit 6	Bit 5	Bit 4	Bit 3	Bit 2	Bit 1	Bit 0
350	0	Standard Output 3	Standard Output 2	Standard Output 1	Standard Output 0	Safety Output 3	Safety Output 2	Safety Output 1	Safety Output 0

Applicable Terminal: DST1-MRD08SL-1

Instance (hex)	Byte	Bit 7	Bit 6	Bit 5	Bit 4	Bit 3	Bit 2	Bit 1	Bit 0
351	0	Safety Output 7	Safety Output 6	Safety Output 5	Safety Output 4	Safety Output 3	Safety Output 2	Safety Output 1	Safety Output 0
	1	Reserved				Standard Output 3	Standard Output 2	Standard Output 1	Standard Output 0

Applicable Terminal: DST1-MD16SL-1

Instance (hex)	Byte	Bit 7	Bit 6	Bit 5	Bit 4	Bit 3	Bit 2	Bit 1	Bit 0
352	0	Safety Output 7/ Output Condition Signal 7	Safety Output 6/ Output Condition Signal 6 (6/7)	Safety Output 5/ Output Condition Signal 5	Safety Output 4/ Output Condition Signal 4 (4/5)	Safety Output 3/ Output Condition Signal 3	Safety Output 2/ Output Condition Signal 2 (2/3)	Safety Output 1/ Output Condition Signal 1	Safety Output 0/ Output Condition Signal 0 (0/1)

Applicable Terminal: DST1-XD0808SL-1

Instance (hex)	Byte	Bit 7	Bit 6	Bit 5	Bit 4	Bit 3	Bit 2	Bit 1	Bit 0
353	0	Safety Output 7/ Output Condition Signal 7	Safety Output 6/ Output Condition Signal 6 (6/7)	Safety Output 5/ Output Condition Signal 5	Safety Output 4/ Output Condition Signal 4 (4/5)	Safety Output 3/ Output Condition Signal 3	Safety Output 2/ Output Condition Signal 2 (2/3)	Safety Output 1/ Output Condition Signal 1	Safety Output 0/ Output Condition Signal 0 (0/1)
	1	Reserved		Reset Signal 5	Reset Signal 4 (4/5)	Reset Signal 3	Reset Signal 2 (2/3)	Reset Signal 1	Reset Signal 0 (0/1)

Applicable Terminal: DST1-XD0808SL-1

Instance (hex)	Byte	Bit 7	Bit 6	Bit 5	Bit 4	Bit 3	Bit 2	Bit 1	Bit 0
354	0	Safety Output 7/ Output Condition Signal 7	Safety Output 6/ Output Condition Signal 6 (6/7)	Safety Output 5/ Output Condition Signal 5	Safety Output 4/ Output Condition Signal 4 (4/5)	Safety Output 3/ Output Condition Signal 3	Safety Output 2/ Output Condition Signal 2 (2/3)	Safety Output 1/ Output Condition Signal 1	Safety Output 0/ Output Condition Signal 0 (0/1)
	1	Reserved		Reset Signal 5	Reset Signal 4 (4/5)	Reset Signal 3	Reset Signal 2 (2/3)	Reset Signal 1	Reset Signal 0 (0/1)
	2	Reserved		Input Condition Signal 5	Input Condition Signal 4 (4/5)	Input Condition Signal 3	Input Condition Signal 2 (2/3)	Input Condition Signal 1	Input Condition Signal 0 (0/1)

Applicable Terminal: DST1-XD0808SL-1

Instance (hex)	Byte	Bit 7	Bit 6	Bit 5	Bit 4	Bit 3	Bit 2	Bit 1	Bit 0
355	0	Output Condition Signal 7	Output Condition Signal 6 (6/7)	Output Condition Signal 5	Output Condition Signal 4 (4/5)	Output Condition Signal 3	Output Condition Signal 2 (2/3)	Output Condition Signal 1	Output Condition Signal 0 (0/1)
	1	Reserved		Reset Signal 5	Reset Signal 4 (4/5)	Reset Signal 3	Reset Signal 2 (2/3)	Reset Signal 1	Reset Signal 0 (0/1)
	2	Reserved				Standard Output 3	Standard Output 2	Standard Output 1	Standard Output 0

Applicable Terminal: DST1-XD0808SL-1

### 3-2-5 Changing Default Standard I/O Assembly Data (DST1-XD0808SL-1 Only)

With the DST1-XD0808SL-1, a Network Configurator can be used to change the default standard I/O assembly data (Default Connection Path). This function is enabled for communications with a Standard Master which cannot change I/O assembly data. This kind of Standard Master can perform standard I/O communications with a Standard Slave using default I/O assembly data only. This function must be used to perform I/O communications using other I/O assembly data.

## CS/CJ-series DeviceNet Unit

A CS/CJ-series DeviceNet Unit can change I/O assembly data, so there is no need to use this function to change the default standard I/O assembly data. Even if this function is used to change the data, the CS/CJ-series DeviceNet Unit settings will be given priority.

**Note** For details on making these settings, refer to the *CS/CJ-series DeviceNet Unit Operation Manual* (Cat. No. W380).

## Using a Standard Master That Cannot Actively Change the Default Standard I/O Assembly Data

Set the initial standard I/O assembly data (Default Connection Path) when using the Network Configurator to set the configuration.

- 1,2,3...**
1. Open the Edit Device Parameters Window of the DST1-XD0808SL-1. From Default Connection Path, select the I/O assembly data for the type of connection (Poll, BitStrobe, COS, Cyclic) to be used for I/O communications with the Standard Master. "Null" means that I/O assembly data is not to be used, i.e., that the data size is 0 bytes.

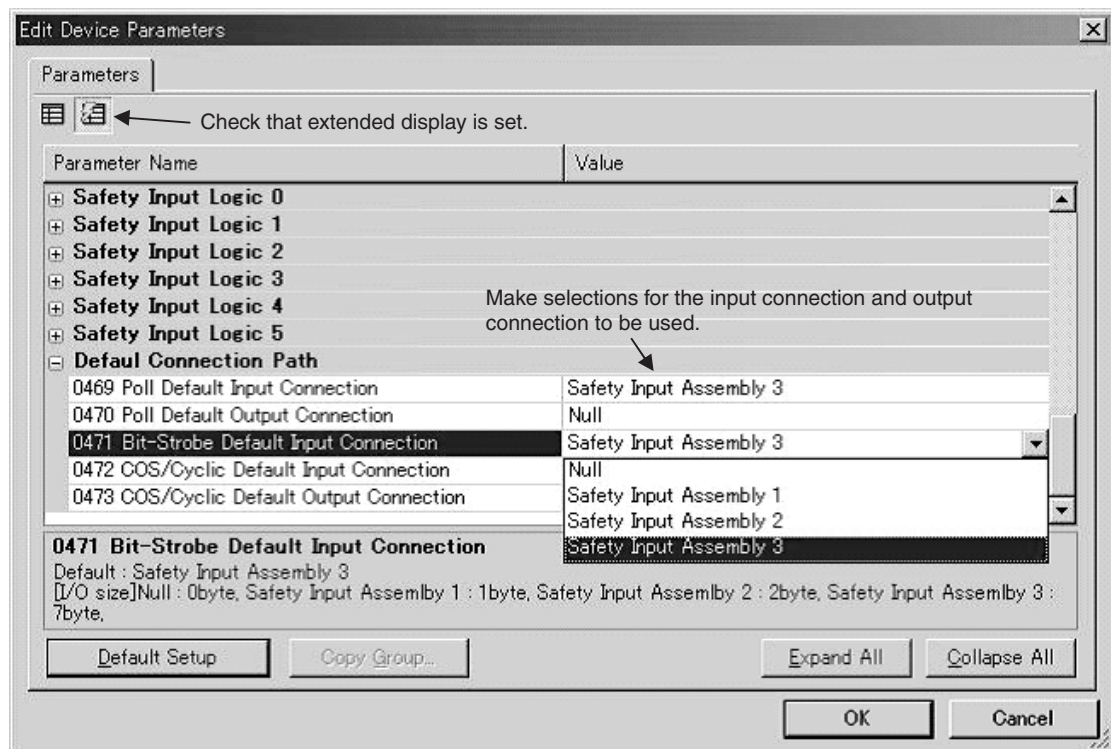

2. Download the specified configuration to the DST1-XD0808SL-1.
3. Set the Standard Master so that the connection type (Poll, BitStrobe, COS, or Cyclic) and I/O data size agree with the settings that were made in step 1 above.

**Note** "Null" means that I/O assembly data is not used, i.e., that the data size is 0 bytes. The output connection size for a Bit-Strobe connection is always 0 bytes.



# SECTION 4 Specifications

4-1	Specifications .....	88
4-1-1	Common Specifications .....	88
4-1-2	Current Consumption and Weights .....	88
4-1-3	DeviceNet Communications Specifications .....	89
4-2	Indicators .....	90
4-2-1	MS/NS Indicators .....	90
4-2-2	Configuration Lock Indicator .....	90
4-2-3	IN PWR/OUT PWR Indicators .....	91
4-2-4	I/O Indicators .....	91

## 4-1 Specifications

### 4-1-1 Common Specifications

Item	Specifications
Communications power supply voltage	11 to 25 V DC (Supplied from the communications connector.)
I/O power supply voltage	20.4 to 26.4 V DC (24 V DC, -15% to +10%)
EMC	Conforms to IEC61131-2.
Vibration resistance	10 to 57 Hz: 0.35-mm single amplitude, 57 to 150 Hz: 50 m/s <sup>2</sup>
Shock resistance	150 m/s <sup>2</sup> for 11 ms DST1-MRD08SL-1: 100 m/s <sup>2</sup> for 11ms
Operating temperature	-10 to 55°C
Relative humidity	10% to 95% (with no condensation) DST1-MRD08SL-1: 10% to 85% (with no condensation)
Operating environment	No corrosive gases
Storage temperature	-40 to 70°C
Mounting	35-mm DIN Track
Degree of protection	IP20
Overvoltage Category	II

### 4-1-2 Current Consumption and Weights

Model	Communications current consumption	Current consumption for I/O power supply (See note.)	Weight
DST1-ID12SL-1	100 mA at 24 V DC	70 mA at 24 V DC	420 g
DST1-MD16SL-1	110 mA at 24 V DC	50 mA at 24 V DC for inputs 130 mA at 24 V DC for outputs	420 g
DST1-MRD08SL-1	100 mA at 24 V DC	80 mA at 24 V DC for inputs 130 mA at 24 V DC for outputs	600 g
DST1-XD0808SL-1	110 mA at 24 V DC	50 mA at 24 V DC for inputs 130 mA at 24 V DC for outputs	420 g

**Note** This does not include the current consumption of the externally connected devices.

The maximum current that can be supplied to the I/O power terminal is shown below.

Model	Terminals	I/O power supply current
DST1-ID12SL-1	V, G	2.94 A
DST1-MD16SL-1	V0, G0	2.90 A
	V1, G1	4.13 A
DST1-MRD08SL-1	V0, G0	2.90 A
	V1, G1	0.13 A
DST1-XD0808SL-1	V0, G0	2.90 A
	V1, G1	4.13 A

**Note** The I/O power supply current is calculated as shown below.

- Input device and test output power terminal  
I/O power supply current that can be supplied to V and G terminals = input current (of number of points used) + test output current (of number of points used) + current consumption for I/O power supply



- Output device power terminal  
I/O power supply current that can be supplied to V and G terminals = output current (of number of points used) + current consumption for I/O power supply

**IMPORTANT** Do not supply a current that exceeds the I/O power supply current to the I/O power terminal.

### 4-1-3 DeviceNet Communications Specifications

Item		Specifications			
Communications protocol		Conforms to DeviceNet and DeviceNet Safety.			
Topology		Combination of multi-drop and T-branch connections (for trunk or branch lines)			
Baud rate		125 kbps, 250 kbps, or 500 kbps			
Communications media		Special 5-wire cable (2 signal lines, 2 power lines, 1 shield line)			
Communications distances					
	<b>Baud rate</b>	<b>Network length</b>	<b>Branch line length</b>	<b>Total branch line length</b>	
	500 kbps	100 m max. *1	6 m max.	39 m max.	
	250 kbps	250 m max. *1	6 m max.	78 m max.	
	125 kbps	500 m max. *1	6 m max.	156 m max.	
Communications power supply		11 to 25 V DC			
Maximum number of nodes		63 nodes			
Safety I/O Communications	Number of connections	4*2, *3			
	Connection type	Single-cast, Multi-cast			
Standard I/O Communications	Number of connections	2			
	Connection type	Poll/Bit-strobe/COS/Cyclic			

\*1: If Thin Cable is used, the maximum network length at any baud rate is 100 m.

\*2: Communications are enabled with 15 Safety Masters for each multi-cast connection, but if four connections are used, it is not possible to communicate with more than 30 Safety Masters total.

\*3: There are a maximum of two connections for the DST1-XD0808SL-1.

## 4-2 Indicators

### 4-2-1 MS/NS Indicators

This section describes the meanings of MS and NS indicators for the DST1-series Safety I/O Terminals.

The MS (Module Status) indicator displays the status of a node on the network.

The NS (Network Status) indicator displays the status of the entire network.

The MS and NS indicators can be green or red and they can be ON, flashing, or OFF. The meanings indicated by the combination of their colors and status are as given in the following table.

Indicator	Color	Status	Meaning
MS	Green		Normal operation status; RUN status (See note.)
			Waiting for communications from the Safety Master; Idle status (See note.)
	Red		System failure
			Minor failure (Switch settings incorrect, etc.)
	Green/Red		The DST1 is performing initialization process or waiting for configuration.
	-		Power is not supplied
NS	Green		Online connection has been established.
			Online connection has not been established.
	Red		Unable to communicate
			I/O communication error
	-		Not online/Not powered

: Lit : Flashing : Not lit

**Note** Applicable to the DST1-XD0808SL-1 only.

### 4-2-2 Configuration Lock Indicator





The LOCK indicator indicates that the configuration data has been locked.



Indicator	Color	Status	Meaning
LOCK	Yellow		Lock has been completed with a valid configuration.
			Lock has not been completed with a valid configuration.
			Configuration has not been performed.

: Lit : Flashing : Not lit

### 4-2-3 IN PWR/OUT PWR Indicators

The IN PWR and OUT PWR indicators indicate the status of the I/O power supplied to the DST1-series Safety I/O Terminals.









LED Indicators	Color	Status	Meaning
IN PWR	Green		Normal status of input power
			Input power is not supplied.
OUT PWR	Green		Normal status of output power
			Output power is not supplied. Output power exceeds the upper/lower limit of the power range. A system error has occurred.



 : Lit    : Flashing    : Not lit

### 4-2-4 I/O Indicators

The I/O indicators show the ON/OFF and error status of I/O.

**Note** The indicators are not lit for safety inputs and safety outputs for which the Safety Input Channel Mode or Safety Output Channel Mode is set to *Not Used*.

Name	Color	Status	Meaning
IN0 to INn (See note.)	Yellow		Safety input ON.
			Safety input OFF.
	Red		<ul style="list-style-type: none"> <li>• Error detected in safety input circuits.</li> <li>• Discrepancy error has occurred set for Dual Channel Mode.</li> </ul>
			Error detected in the other input circuit set for Dual Channel Mode (no error in this circuit)
OUT0 to OUTn (See note.)	Yellow		Safety output ON.
			Safety output OFF.
	Red		<ul style="list-style-type: none"> <li>• Error detected in safety output circuits.</li> <li>• EDM error (See note 2.)</li> </ul>
			Error detected in the other output circuit set for Dual Channel Mode (no error in this circuit)

 : Lit    : Flashing    : Not lit

**Note** (1) "n" indicates the terminal number.  
(2) Applicable to the DST1-XD0808SL-1 only.



# SECTION 5

## DST1 Series Specifications

5-1	DST1-ID12SL-1 . . . . .	94
	5-1-1 Safety Input Specifications . . . . .	94
	5-1-2 Test Output Specifications . . . . .	94
	5-1-3 Nomenclature . . . . .	94
	5-1-4 Internal Circuits and Terminal Arrangement . . . . .	95
	5-1-5 Dimensions . . . . .	96
5-2	DST1-MD16SL-1 . . . . .	97
	5-2-1 Safety Input Specifications . . . . .	97
	5-2-2 Test Output Specifications . . . . .	97
	5-2-3 Safety Output Specifications for Semiconductor Outputs . . . . .	97
	5-2-4 Nomenclature . . . . .	98
	5-2-5 Internal Circuits and Terminal Arrangement . . . . .	98
	5-2-6 Dimensions . . . . .	100
5-3	DST1-MRD08SL-1 . . . . .	101
	5-3-1 Safety Input Specifications . . . . .	101
	5-3-2 Test Output Specifications . . . . .	101
	5-3-3 Safety Output Specifications for Relay Outputs . . . . .	101
	5-3-4 Nomenclature . . . . .	102
	5-3-5 Internal Circuits and Terminal Arrangement . . . . .	102
	5-3-6 Dimensions . . . . .	105
5-4	DST1-XD0808SL-1 . . . . .	106
	5-4-1 Safety Input Specifications . . . . .	106
	5-4-2 Test Output Specifications . . . . .	106
	5-4-3 Safety Output Specifications for Semiconductor Outputs . . . . .	106
	5-4-4 Nomenclature . . . . .	106
	5-4-5 Internal Circuits and Terminal Arrangement . . . . .	107
	5-4-6 Dimensions . . . . .	109

## 5-1 DST1-ID12SL-1

### 5-1-1 Safety Input Specifications

The following table gives the safety input specifications for the DST1-ID12SL-1.

Item	Specifications
Input type	Sinking input (PNP)
ON voltage	11 VDC min. between each input terminal and G
OFF voltage	5 VDC max. between each input terminal and G
OFF current	1 mA max.
Input current	6 mA

### 5-1-2 Test Output Specifications

The following table gives the test output specifications for the DST1-ID12SL-1.

Item	Specifications
Output type	Sourcing output (PNP)
Rated output current	0.7 A
Residual voltage	1.2 V max. between each output terminal and V
Leakage current	0.1 mA max.

### 5-1-3 Nomenclature

The following figure shows the names of the parts of the DST1-ID12SL-1.

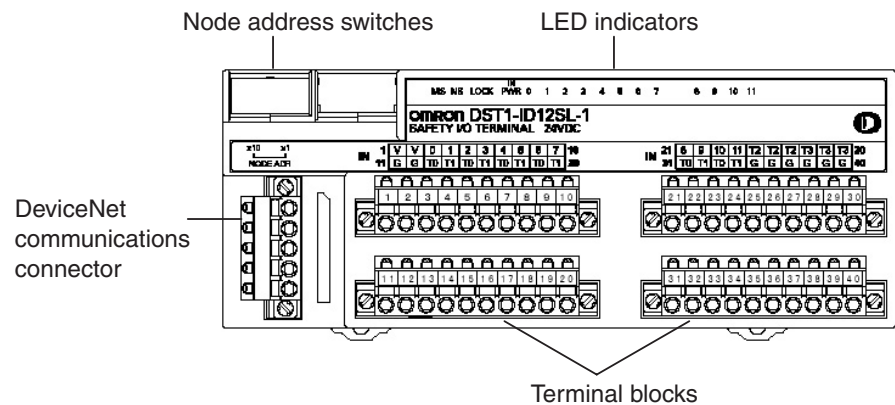

- Refer to *4-2 Indicators* for information on the LED indicators.
- Refer to *2-4 Connecting the Communications Connector* for information on the DeviceNet communications connector.
- Refer to *5-1-4 Internal Circuits and Terminal Arrangement* for information on the terminal blocks.

### 5-1-4 Internal Circuits and Terminal Arrangement

The following figure shows the internal circuits of the DST1-ID12SL-1.

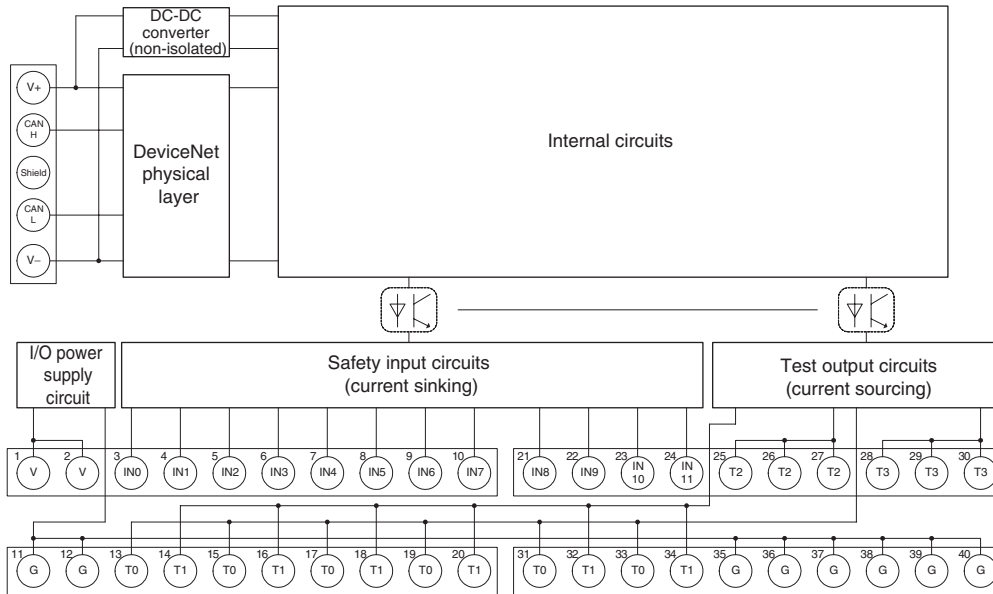

The following table gives the terminal arrangement of the terminal blocks on the DST1-ID12SL-1.

Terminals	Names	Functions
1, 2	V	Power terminals for the input devices and test outputs. (24 VDC)
11, 12	G	
35 to 40	G	Common terminals The terminals 11, 12 and 35 to 40 are internally connected.
3 to 10 21 to 24	IN0 to IN11	Terminals for safety inputs
13 to 20 25 to 30 31 to 34	T0 to T3	Terminals for test outputs

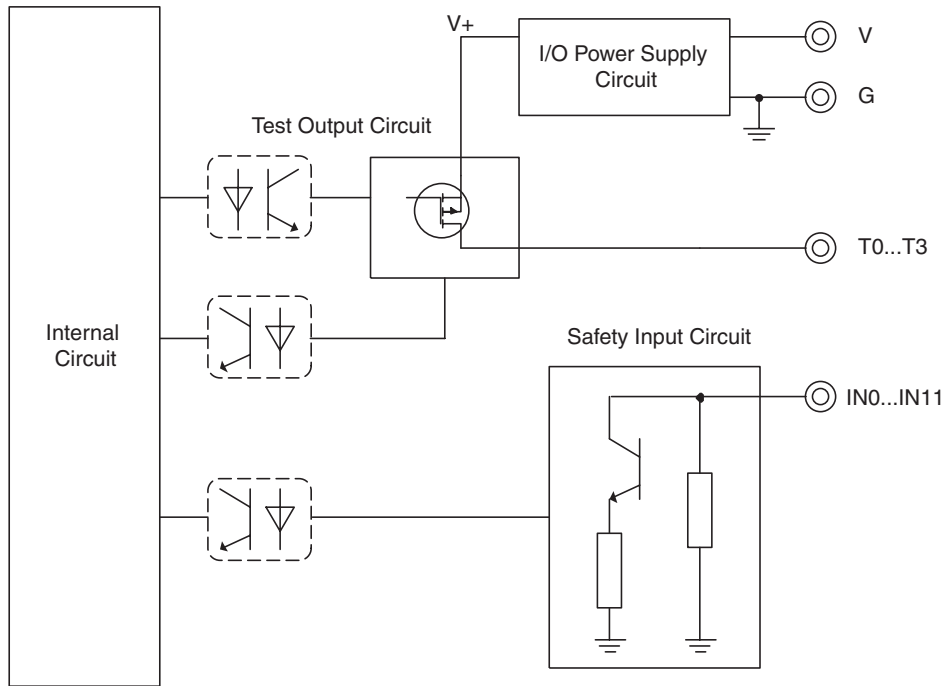

### 5-1-5 Dimensions

The following figures show the dimensions of the DST1-ID12SL-1 (unit: mm).

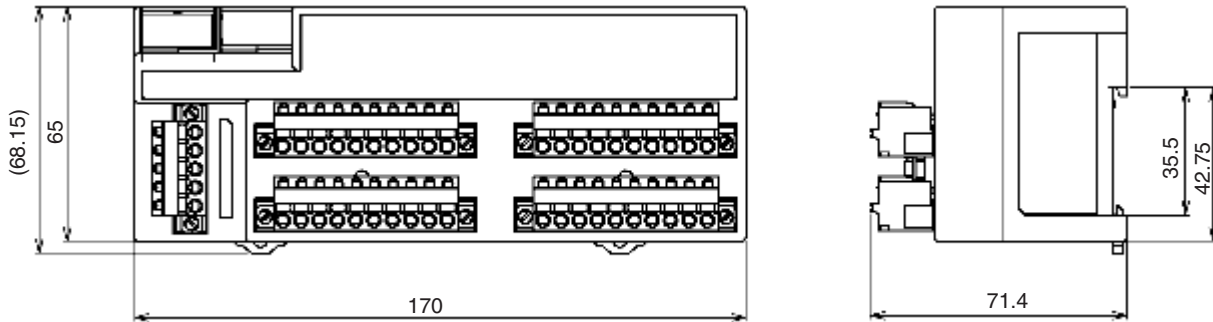



## 5-2 DST1-MD16SL-1

### 5-2-1 Safety Input Specifications

The following table gives the safety input specifications for the DST1-MD16SL-1.

Item	Specifications
Input type	Sinking input (PNP)
ON voltage	11 VDC min. between each input terminal and G0
OFF voltage	5 VDC max. between each input terminal and G0
OFF current	1 mA max.
Input current	6 mA

### 5-2-2 Test Output Specifications

The following table gives the test output specifications for the DST1-MD16SL-1.

Item	Specifications
Output type	Sourcing output (PNP)
Rated output current	0.7 A
Residual voltage	1.2 V max. between each output terminal and V0
Leakage current	0.1 mA max.

### 5-2-3 Safety Output Specifications for Semiconductor Outputs

The following table gives the safety output specifications for the Semiconductor outputs on the DST1-MD16SL-1.

Item	Specifications
Output type	Sourcing output (PNP)
Rated output current	0.5 A
Residual voltage	1.2 V max. between each output terminal and V1
Leakage current	0.1 mA max.

**IMPORTANT** In case that a safety output is configured as *Safety pulsed test*, while this output is in an ON state, the signal sequence shown below is output continuously to enable diagnosis. Confirm the response times of the devices connected to the safety outputs so that the devices do not malfunction due to the OFF pulse.

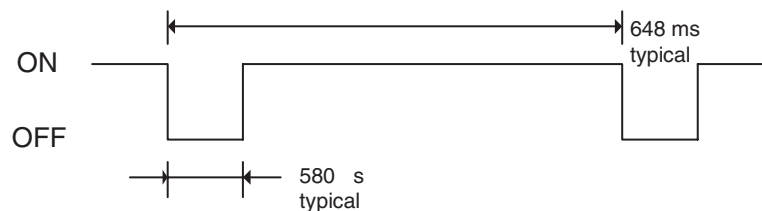

### 5-2-4 Nomenclature

The following figure gives the names of the parts of the DST1-MD16SL-1

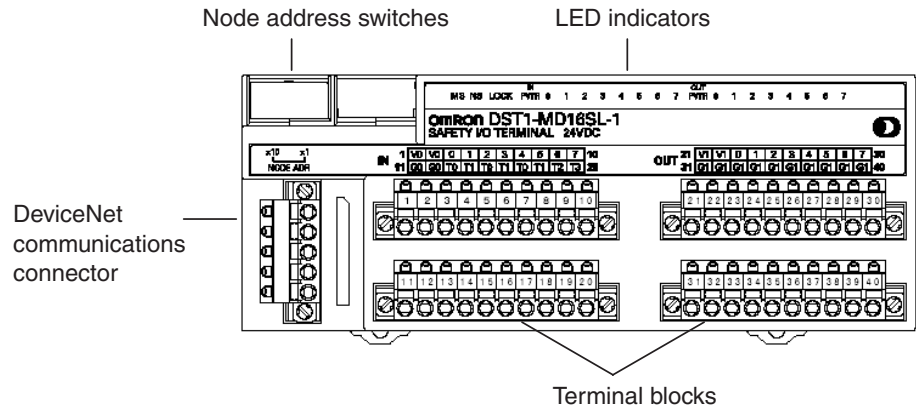

- Refer to 4-2 Indicators for information on the LED indicators.
- Refer to 2-4 Connecting the Communications Connector for information on the DeviceNet communications connector.
- Refer to 5-2-5 Internal Circuits and Terminal Arrangement for information on the terminal blocks.

### 5-2-5 Internal Circuits and Terminal Arrangement

The following figure shows the internal circuits of the DST1-MD16SL-1.

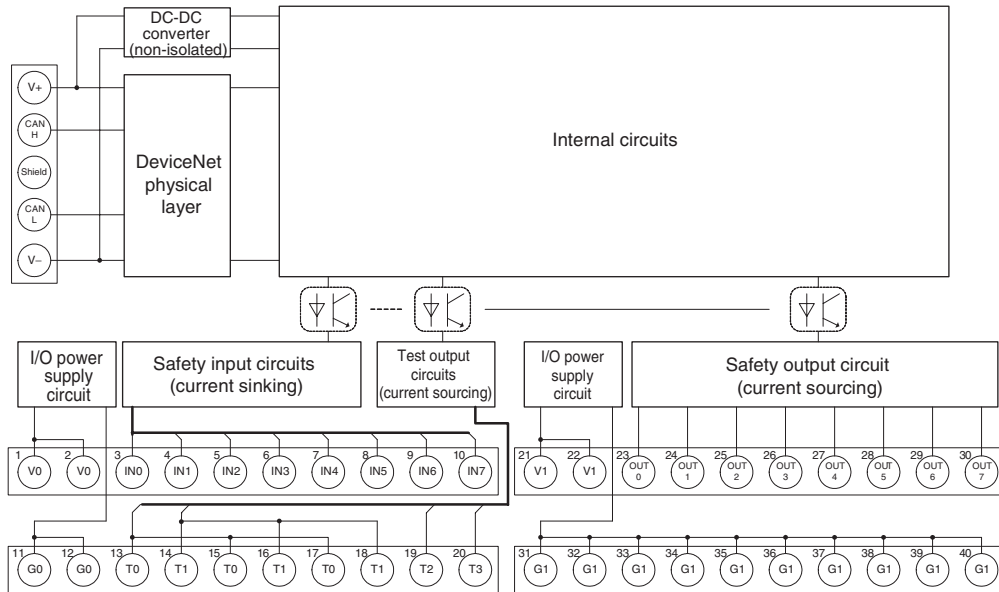

The following table shows the terminal arrangement of the terminal blocks on the DST1-MD16SL-1.

Terminals	Names	Functions
1,2	V0	Power terminals for the input devices and test outputs. (24 VDC)
11,12	G0	
3 to 10	IN0 to IN7	Terminals for safety inputs
13 to 20	T0 to T3	Terminals for test outputs
21, 22	V1	Power terminals for the output devices. (24 VDC)
31, 32	G1	
23 to 30	OUT0 to OUT7	Terminals for safety outputs
33 to 40	G1	Common terminals. Terminals 31 to 40 are internally connected.

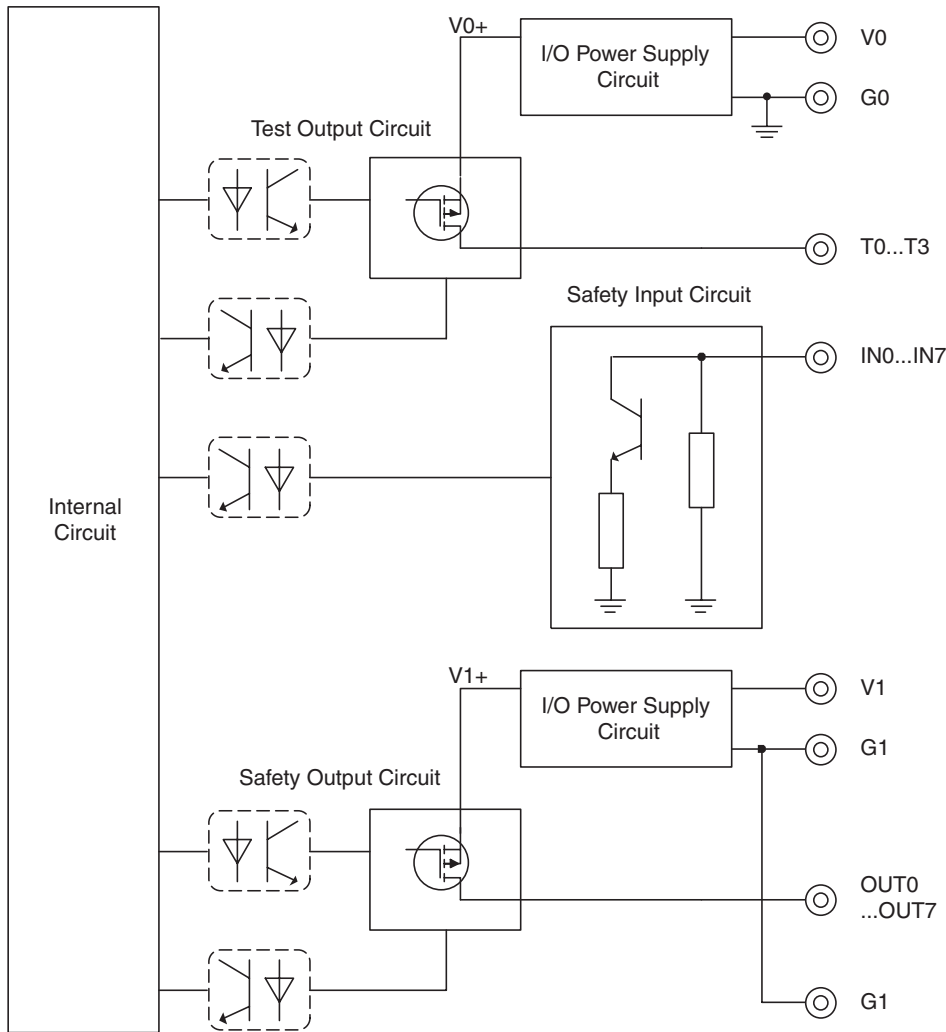

**IMPORTANT** Power supply terminal V1 for the outputs is internally monitored. Supply the voltage in the specified range (20.4 to 26.4 VDC). If the voltage is supplied outside this range, voltage will not be supplied to the output circuits.

### 5-2-6 Dimensions

The following figures show the dimensions of the DST1-MD16SL-1 (unit: mm).

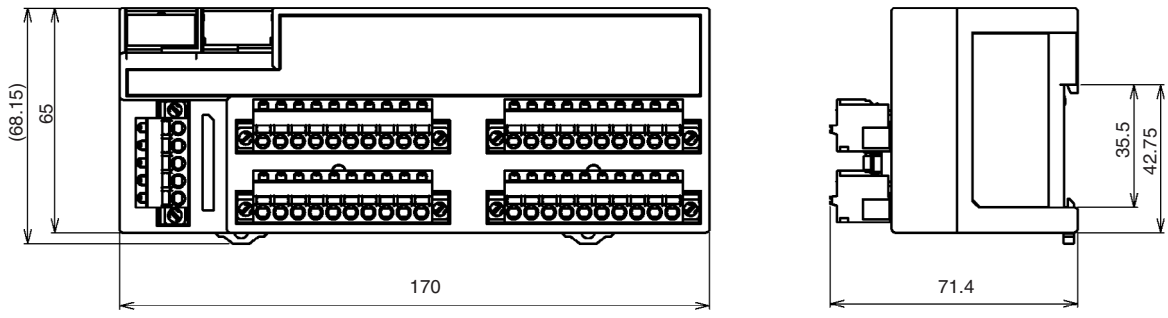

## 5-3 DST1-MRD08SL-1

### 5-3-1 Safety Input Specifications

The following table gives the safety input specifications for the DST1-MRD08SL-1.

Item	Specifications
Input type	Sinking input (PNP)
ON voltage	11 VDC min. between each input terminal and G0
OFF voltage	5 VDC max. between each input terminal and G0
OFF current	1 mA max.
Input current	6 mA

### 5-3-2 Test Output Specifications

The following table gives the test output specifications for the DST1-MRD08SL-1.

Item	Specifications
Output type	Sourcing output (PNP)
Rated output current	0.7 A
Residual voltage	1.2 V max. between each output terminal and V0
Leakage current	0.1 mA max.

### 5-3-3 Safety Output Specifications for Relay Outputs

The following table gives the safety output specifications for the DST1-MRD08SL-1.

Item		Specifications
Relays		G7SA-2A2B EN50205 Class A
Failure rate P level (See note.) (Reference value)		1 mA at 5 VDC
Rated load for a resistive load		240 VAC: 2 A 30 VDC: 2 A
Durability	Mechanical life expectancy	5,000,000 operations min. (at approx. 7,200 operations/h)
	Electrical life expectancy	100,000 operations min. (at rated load and approx. 1,800 operations/h)

**Note** This value applies to a switching frequency of 300 operations/min.

### 5-3-4 Nomenclature

The following figure shows the names of the parts of the DST1-MRD08SL-1.

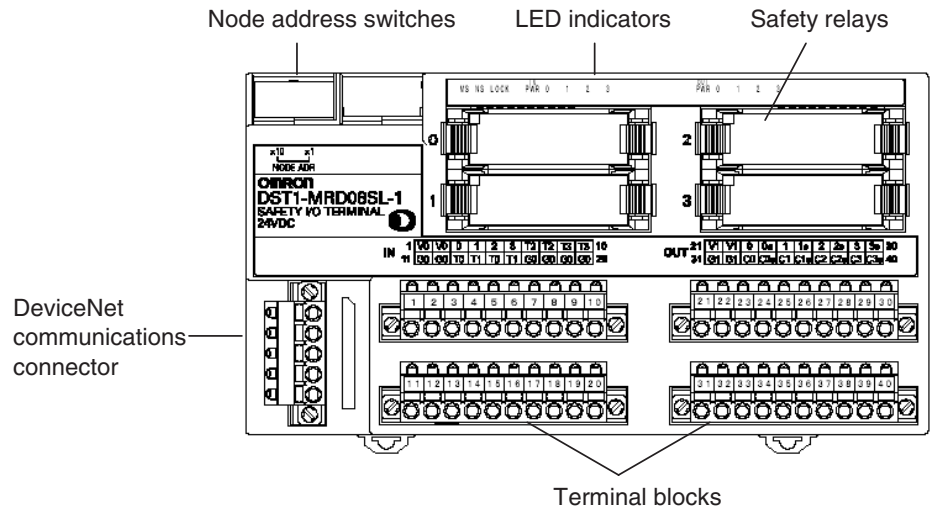

- Refer to 4-2 *Indicators* for information on the LED indicators.
- Refer to 2-4 *Connecting the Communications Connector* for information on the DeviceNet communications connector.
- Refer to 5-3-5 *Internal Circuits and Terminal Arrangement* for information on the terminal blocks.

### 5-3-5 Internal Circuits and Terminal Arrangement

The following figure shows the internal circuits of the DST1-MRD08SL-1.

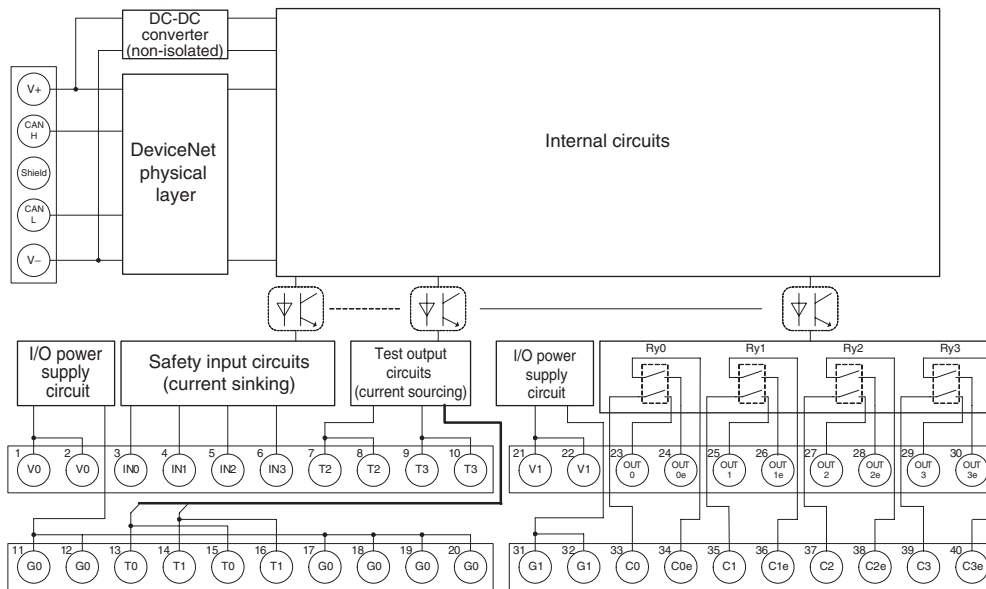

The following table shows the terminal arrangement of the terminal blocks on the DST1-MRD08SL-1.

Terminals	Names	Functions
1, 2	V0	Power terminals for the input devices, test outputs and internal relay feedback monitors. (24 VDC)
11, 12	G0	
17 to 20	G0	Common terminals. Terminals 11, 12, and 17 to 20 are internally connected.
3 to 6	IN0 to IN3	Terminals for safety inputs

Terminals	Names	Functions
7 to 10 13 to 16	T0 to T3	Terminals for test outputs
21, 22	V1	Power terminals for driving internal relays. (24 VDC)
31, 32	G1	
23 to 30 33 to 40	OUT0 to OUT3 C0 to C3 OUT0e to OUT3e C0e to C3e	Terminals for safety outputs Outputs of terminals 23/33 (OUT0) and 24/34 (OUT0e) are the same. Output of terminals 25/35 (OUT1) and 26/36 (OUT1e) are the same. Output of terminals 27/37 (OUT2) and 28/38 (OUT2e) are the same. Output of terminals 29/39 (OUT3) and 30/40 (OUT3e) are the same.

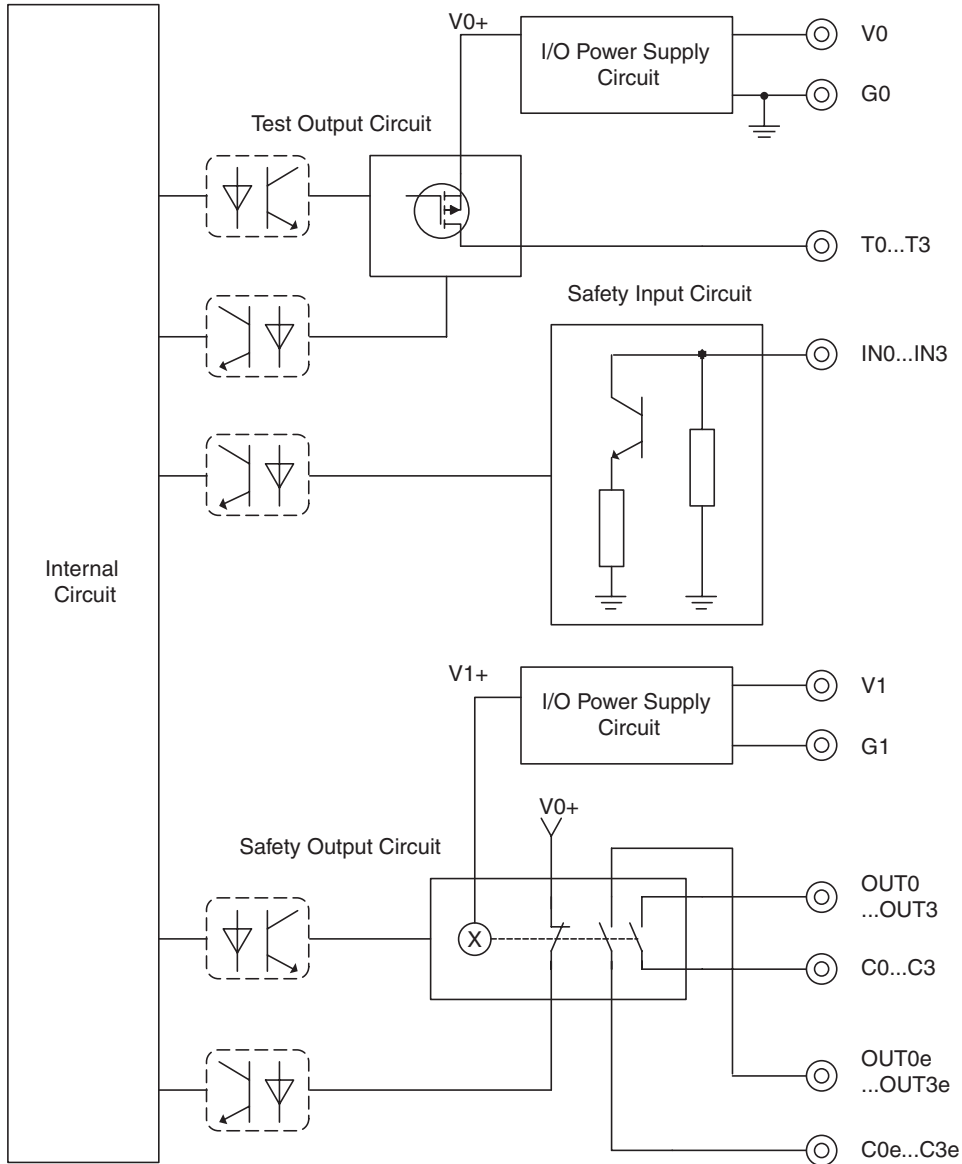

**! WARNING**

For the DST1-MRD08SL-1, isolating transformers, such as TR1, that are used to isolate between overvoltage categories III and II must conform to IEC60742, and the insulation between the primary input and secondary output must satisfy at least the basic insulation standards of overvoltage category III.

One side of the secondary output of the isolating transformer must be grounded to prevent electrical shock in case of short-circuiting to the ground or to the frame of the isolating transformer.

To protect the isolating transformer and to prevent electrical shock in case of short-circuiting to the frame, insert fuses according to transformer specifications, i.e. at points F1, F2, and F3.

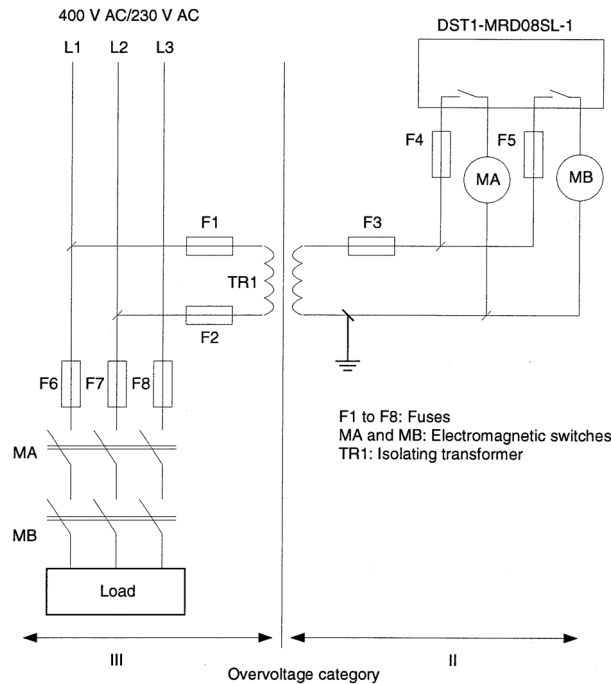

For Model DST1-MRD08SL-1, Insert a fuse rated at 3.15 A or less for each output terminal to protect safety output contacts from welding.

Confirm the fuse selection with the fuse manufacturer to ensure the dependability of the characteristics of the connected load.



**IMPORTANT**

- Supply power to both V0 and V1. The states of the relay contacts are internally monitored from the power supply of V0.
- Power supply terminal V1 for the outputs is internally monitored. Supply the voltage in the specified range (20.4 to 26.4 VDC). If the voltage is supplied outside this range, voltage will not be supplied to the output circuits.



### 5-3-6 Dimensions

The following figures show the dimensions of the DST1-MRD08SL-1 (unit: mm).

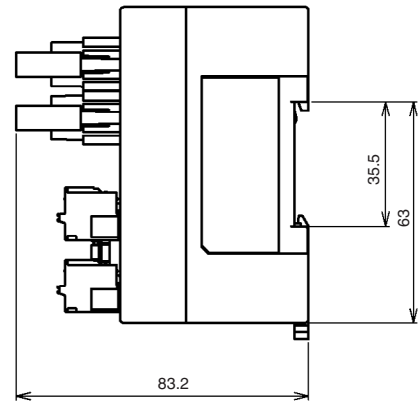
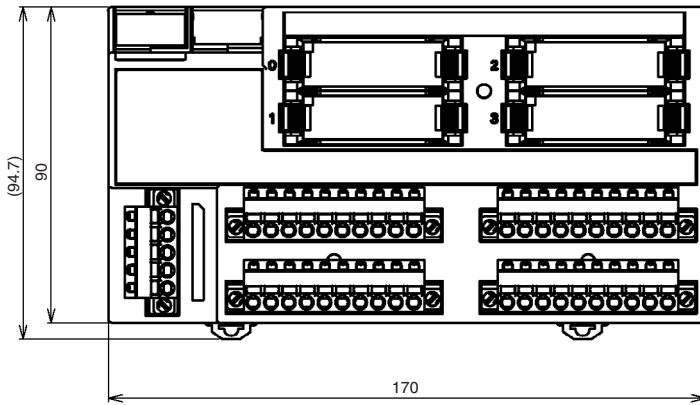

## 5-4 DST1-XD0808SL-1

### 5-4-1 Safety Input Specifications

The following table gives the safety input specifications for the DST1-XD0808SL-1.

Item	Specifications
Input type	Sinking input (PNP)
ON voltage	11 VDC min. between each input terminal and G0
OFF voltage	5 VDC max. between each input terminal and G0
OFF current	1 mA max.
Input current	6 mA

### 5-4-2 Test Output Specifications

The following table gives the test output specifications for the DST1-XD0808SL-1.

Item	Specifications
Output type	Sourcing output (PNP)
Rated output current	0.7 A
Residual voltage	1.2 V max. between each output terminal and V0
Leakage current	0.1 mA max.

### 5-4-3 Safety Output Specifications for Semiconductor Outputs

The following table gives the safety output specifications (for semiconductor outputs) for the DST1-XD0808SL-1.

Item	Specifications
Output type	Sourcing output (PNP)
Rated output current	0.5 A
Residual voltage	1.2 V max. between each output terminal and V1
Leakage current	0.1 mA max.

When the safety output channel mode for a safety output terminal is set to Safety Pulse Test, the following pulse signal is output when the safety output turns ON. Confirm the input response times for control devices connected to the safety outputs so that the devices do not malfunction due to the OFF pulse.

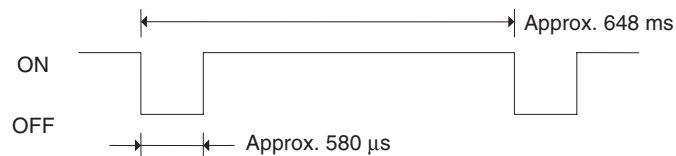

### 5-4-4 Nomenclature

The following figure shows the names of the DST1-XD0808SL-1.

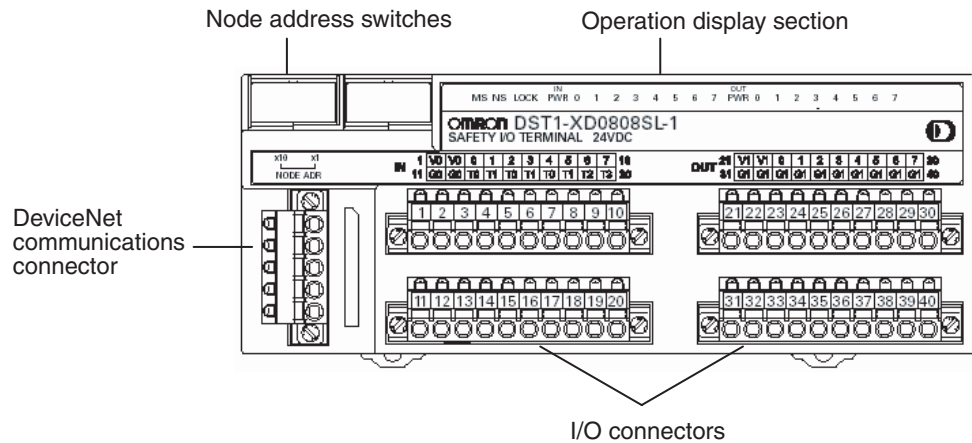

- Refer to 4-2 Indicators for details on the LED indicators.
- Refer to 2-4 Connecting the Communications Connector for details on the DeviceNet communications connector.
- Refer to 5-4-5 Internal Circuits and Terminal Arrangement for details on the terminal arrangement.

### 5-4-5 Internal Circuits and Terminal Arrangement

The following diagram shows the internal circuits of the DST1-XD0808SL-1.

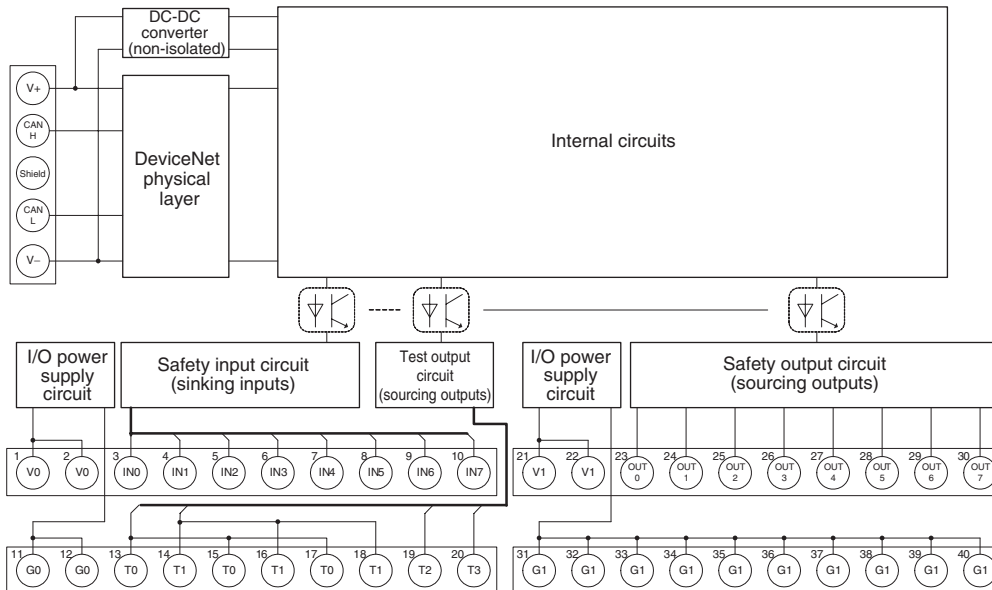

Terminals	Names	Functions
1, 2	V0	Power terminals for input devices and test outputs (24 VDC)
11, 12	G0	
3 to 10	IN0 to IN7	Terminals for safety inputs
13 to 20	T0 to T3	Terminals for test outputs
21, 22	V1	Power terminals for output devices (24 VDC)
31, 32	G1	
23 to 30	OUT0 to OUT7	Terminals for safety outputs
33 to 40	G1	Common terminals. Terminals 31 to 40 are internally connected.

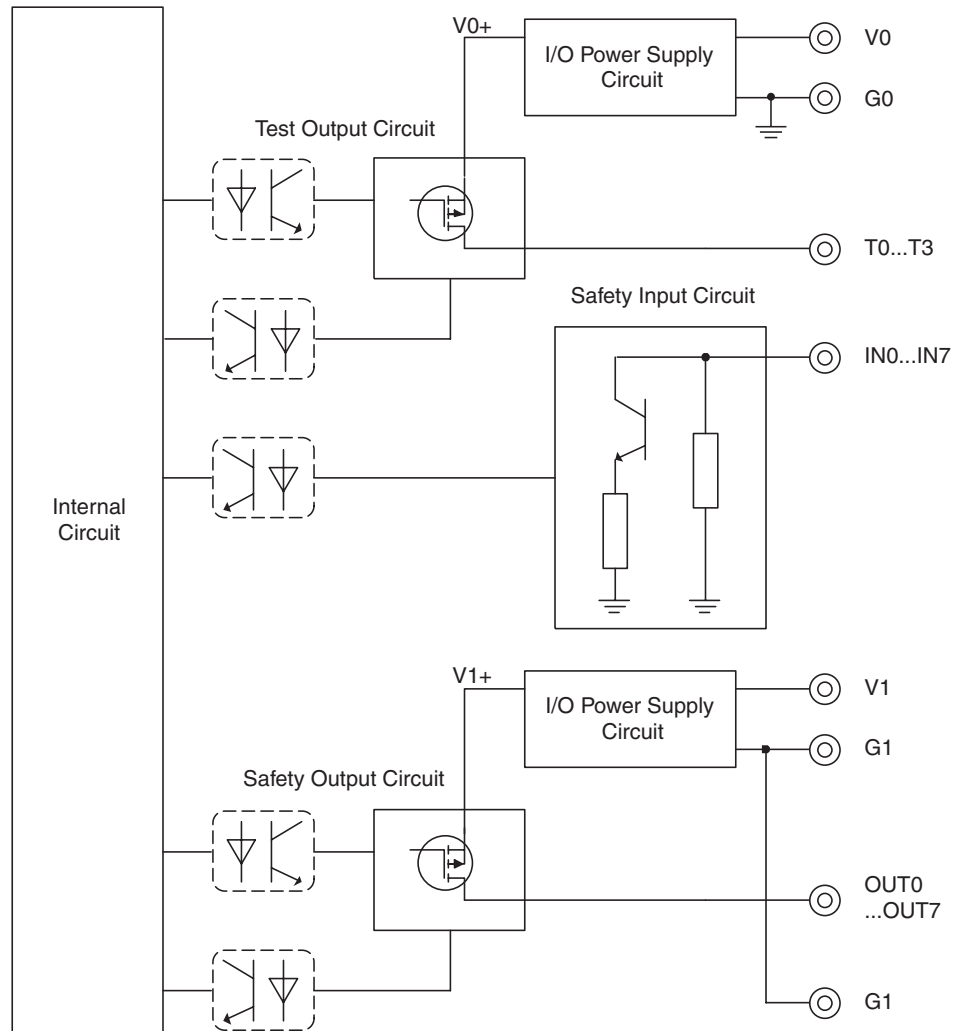

**Note** Power supply terminal V1 for the output devices is internally monitored. Supply the voltage in the specified range (20.4 to 26.4 VDC). If the voltage is supplied outside this range, voltage will not be supplied to the output circuits.

### 5-4-6 Dimensions

The following figures show the dimensions of the DST1-XD0808SL-1 (unit: mm).

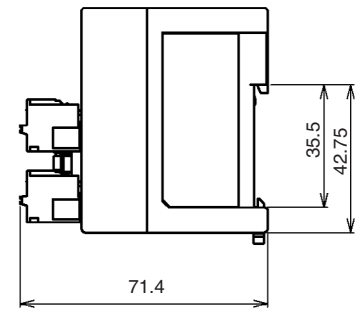
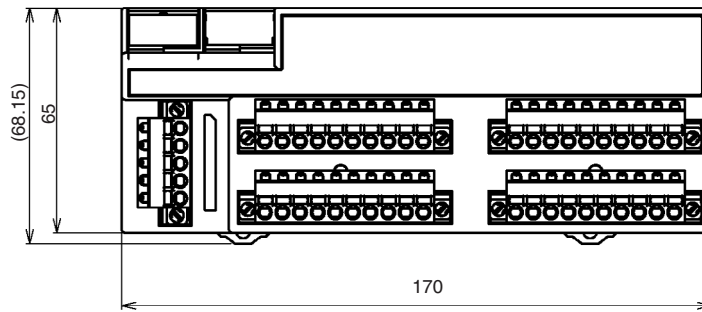



# SECTION 6

## Response Performance

6-1	Reaction Time . . . . .	112
6-1-1	Reaction Time Concept . . . . .	112
6-1-2	Input Reaction Time . . . . .	112
6-1-3	Output Reaction Time. . . . .	112
6-1-4	Local Input and Local Output Reaction Times. . . . .	112

## 6-1 Reaction Time

### 6-1-1 Reaction Time Concept

The reaction time is the maximum time required for stopping an output, taking into account errors that may occur in safety chains (logical connections for creating safety devices, consisting of input devices, control devices including remote I/O devices, and output devices). The safety distance is found based on the reaction time.

### 6-1-2 Input Reaction Time

The input reaction time is the time from when an input terminal signal is changed until an output is sent to the network. The input reaction time is determined as follows:

**Input reaction time = 16.2 ms + Input ON/OFF delay time**

The input reaction time for the safety input logic result of the DST1-XD0808SL-1 is as follows:

**Input reaction time = 22.2 ms + Input ON/OFF delay time**

**Note** For details on reaction times for the entire system, refer to the *DeviceNet Safety System Configuration Manual* (Cat. No. Z905).

### 6-1-3 Output Reaction Time

The output reaction time is the time from when a network signal is received until the output terminal is changed. The output reaction time is determined as follows:

**Output reaction time (DST1-MD16SL-1) = 6.2 ms**

**Output reaction time (DST1-MRD08SL-1) = 26.2 ms**

**Output reaction time (DST1-XD0808SL-1) = 6.2 ms + Output ON/OFF delay time**

**Note** For details on reaction times for the entire system, refer to the *DeviceNet Safety System Configuration Manual* (Cat. No. Z905).

### 6-1-4 Local Input and Local Output Reaction Times

The DST1-XD0808SL-1 can stop local outputs according to local input status by using logic operations. In such cases, the Unit can independently calculate the reaction time.

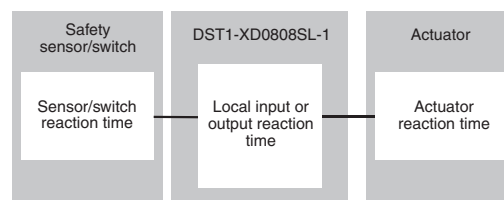

**Local input and output reaction time = 18.7 ms + Input ON/OFF delay time + Output ON/OFF delay time**



# SECTION 7

## Troubleshooting and Maintenance

7-1	Indicators and Error Processing .....	114
7-2	Troubleshooting .....	115
7-2-1	Safety Input Errors .....	115
7-2-2	Test Output Errors .....	116
7-2-3	Safety Output Errors .....	117
7-3	Error History .....	118
7-4	Maintenance .....	120
7-4-1	Cleaning .....	120
7-4-2	Inspection .....	120
7-4-3	Replacing the DST1 .....	121

# 7-1 Indicators and Error Processing

MS		NS		LOCK	I/O PWR	I/O		Description	Probable cause and remedy
Green	Red	Green	Red	Yellow	Green	Yellow	Red		
					-	-	-	Safety I/O communications in progress (normal status)	
		-	-	-	-	-	-	RUN status (DST1-XD0808SL-1 only)	
					-	-	-	Standard I/O communications or message communications in progress (normal status)	
					-	-	-	The DST1 performing initialization process or waiting for configuration.	
				-	-	-	-	Waiting for safety or standard connection	
				-	-	-	-	Communications timeout	Check the following items and restart the DST1.
				-	-	-	-	BusOff status (communications stopped due to consecutive data errors)	Are lengths of cables (trunk and branch lines) correct? Are cables broken or loose? Are Terminating Resistors connected to both ends of the trunk line only? Is noise interference excessive?
								Node address duplication	Reset the DST1 so that it has a unique node address, and then restart the DST1.
				-	-	-	-	Waiting for completion of node address duplication check	
				-	-	-	-	Switch settings are incorrect	Check the node address, and then restart the DST1.
					Input -			System failure	Check to see if the positive side of the power supply is in contact with the signal line. Replace the DST1 if the system failure still occurs after turning the power supply ON again.
-	-	-	-	-				Input/output power is not supplied.	Check the following items. Are cables broken? Is the I/O power voltage within specifications?
-	-	-	-	-				An error occurred in an input/output circuit.	Check the following items. • Has a ground fault occurred in the signal line? • Is the signal line broken? • Are there any troubles with the connected device? • Is the power source (positive side) in contact with the signal line? • Has a short-circuit occurred in the signal line? • Is the discrepancy time setting suitable? • Is the I/O power supply voltage within specifications? • Did an EDM error occur? Details on the error can be read from the Network Configurator.
-	-	-	-	-				When dual channels are set: An error occurred in the other channel.	

: Lit   : Flashing   : Not lit

## 7-2 Troubleshooting

I/O errors can be read out from safety input status, test output status, and safety output status.

Status data when I/O is normal: ON (1)

Status data when an error occurs I/O: OFF (0)

The details of errors can be read out by using explicit messages and the Network Configurator.

**Note** For I/O error latch time settings, the OFF status is maintained for at least the error latch time (0 to 65,530 ms, in increments of 10 ms) when individual safety input status turns OFF.

### 7-2-1 Safety Input Errors

Code	Error	Probable cause	Countermeasure
01 hex	Configuration invalid	The configuration is invalid.	Configure the DST1 correctly.
02 hex	External test signal failure	1. The power source (positive side) is in contact with the input signal line. 2. Short-circuit between input signal lines 3. Trouble with the connected device	1. 2. Check the wiring. 3. Replace the connected device.
03 hex	Internal input failure	Trouble with the internal circuits	Replace the DST1 if the system failure still occurs after turning the power supply ON again.
04 hex	Discrepancy error	1. Ground fault or break in an input signal line 2. Trouble with the connected device 3. The discrepancy time setting is not satisfied.	1. Check the wiring. 2. Replace the connected device. 3. Change the time setting.
05 hex	Failure of the associated dual channel input	Dual channels are set and an error occurred in the other channel.	Remove the error in the other channel.

#### Explicit Message for Reading the Cause of the Error

Explicit message	Read/write	Function	Command					Response
			Service code	Class ID	Instance ID	Attribute ID	Data size	
Safety Input Cause of Error Information Read	Read	Reads the cause for the normal flag (1 to 12) specified by the instance ID turning OFF. (See note.)	0E hex	3D hex	01 to 0C hex	6E hex	-	0: No error Or error code

**Note** The instance numbers for safety inputs 0 to 11 are 1 to 12 (01 to 0C hex), respectively.

### 7-2-2 Test Output Errors

Code	Error	Probable cause	Countermeasure
01 hex	Configuration invalid	The configuration is invalid.	Configure the DST1 correctly.
02 hex	Overload detected	1. Ground fault or short-circuit of an output signal line 2. Trouble with the connected device	1. Check the wiring. 2. Replace the connected device.
05 hex	Stuck-at-high detected	1. The power source (positive side) is in contact with the output signal line. 2. Trouble with the internal circuit	1. Check the wiring. 2. Replace the DST1.
06 hex	Under current was detected using muting lamp	1. The output signal line is broken or disconnected. 2. Trouble with the connected device	1. Check the wiring. 2. Replace the connected device.

#### Explicit Message for Reading the Cause of the Error

Explicit message	Read/write	Function	Command					Response
			Service code	Class ID	Instance ID	Attribute ID	Data size	
Test Output Cause of Error Information Read	Read	Reads the cause for the normal flag (1 to 4) specified by the instance ID turning OFF. (See note.)	0E hex	09 hex	01 to 04 hex	76 hex	-	0 = No error Or error code

**Note** The instance numbers for test outputs 0 to 3 are 1 to 4 (01 to 04 hex), respectively.

### 7-2-3 Safety Output Errors

Code	Error	Probable cause	Countermeasure
01 hex	Configuration invalid	The configuration is invalid.	Configure the DST1 correctly.
02 hex	Over current detected	Trouble with the connected device	Replace the connected device.
03 hex	Short circuit to low	Ground fault of the output signal line	Check the wiring.
04 hex	Stuck at high	<ol style="list-style-type: none"> <li>1. The power source (positive side) is in contact with the output signal line.</li> <li>2. Trouble with the internal circuit</li> <li>3. The I/O power supply voltage is not within specifications.</li> </ol>	<ol style="list-style-type: none"> <li>1. Check the wiring.</li> <li>2. Replace the DST1.</li> <li>3. Make sure the I/O power supply voltage is within specifications.</li> </ol>
05 hex	Failure of the associated dual channel output	Dual channels are set and an error occurred in the other channel.	Remove the error in the other channel.
06 hex	Internal Relay Relevant Circuit Error (Replace Module) (DST1-MRD08SL-1 only)	Trouble with the internal circuit	Replace the DST1 if the system failure still occurs after turning the power supply ON again.
07 hex	Relay Failure (Replace Relay) (DST1-MRD08SL-1 only)	Trouble with the relay	Replace the relay.
08 hex	Dual channel violation	Wrong setting for output data	Check the program.
09 hex	Cross connection detected	Short-circuit between output signal lines.	Check the wiring.
0x0A	EDM Error (Replace Module) (DST1-XD0808SL-1 only)	<ol style="list-style-type: none"> <li>1. Break in the EDM feedback signal line, or contact with power supply (positive side), or ground fault</li> <li>2. Contactor or relay contact weld fault</li> </ol>	<ol style="list-style-type: none"> <li>1. Check the wiring.</li> <li>2. Replace the contactor or relay.</li> </ol>

#### Explicit Message for Reading the Cause of the Error

Explicit message	Read/write	Function	Command					Response
			Service code	Class ID	Instance ID	Attribute ID	Data size	
Safety Output Cause of Error Information Read	Read	Reads the cause for the normal flag (1 to 8) specified by the instance ID turning OFF. (See note.)	0E hex	3B hex	01 to 08 hex	6E hex	-	0: No error Or error code

**Note** The instance numbers for safety outputs 0 to 7 are 1 to 8 (01 to 08 hex), respectively.

## 7-3 Error History

The DST1-series Safety I/O Terminals internally store up to 10 error history records. The history is updated each time an error occurs. When more than ten records exist, the oldest record will be deleted. The error history can be read using the Network Configurator.

Message	Countermeasure
<b>DST1 Series System Failures</b>	
System Failure	Check to see if the positive side of the power supply is in contact with the signal line. Replace the DST1 if the system failure still occurs after turning ON the power.
Invalid Configuration	Configure the DST1 correctly.
<b>DeviceNet Communications Errors</b>	
Switch Setting Mismatch	Check to see if the node address is the same as the node address used for the previous configuration. If not, set the node address to that of the previous configuration, or configure the DST1 again. If the error occurs again, replace the DST1.
Duplication MAC ID	Check the node addresses of other nodes. After setting the node addresses to eliminate address duplication, turn ON the power to the DST1 again.
Transmission Timeout	Check the following items. • Are cable lengths (trunk and branch lines) correct? • Are cables broken or loose? • Are Terminating Resistors connected to both ends of the trunk line and only to both ends of the trunk line? • Is noise interference excessive?
Bus off	
Standard I/O Connection Timeout	
Safety I/O Connection Timeout	
<b>Test Output Terminal-related Failures</b>	
Stuck-at-high Detected at Test Output	Check to see if the positive side of the power source is in contact with the output signal line. If the wiring is okay, replace the DST1.
Overload Detected at Test Output	Check the wiring to see if a ground fault occurred in the output signal line.
Under Current is Detected using Muting Lamp	Check the wiring to see if an output signal line is broken. If the wiring is okay, replace the external lamp.
<b>Safety Input Terminal-related Failures</b>	
Discrepancy Error at Safety Input	Check the following points: • Make sure the input signal wire is not contacting the positive side of the power source. • Make sure the input signal wire does not have an earth fault. • Make sure the input signal wire is not disconnected. • Make sure there is not a short circuit between input signal wires. • Make sure a failure has not occurred in the connected device. • Make sure the set value of the discrepancy time is valid.  To recover from these failures, the following conditions are required: The latch input error time must have passed, and the cause of the error must have been removed. The target safety input terminal inputs must turn OFF.  When changing the discrepancy time, reconfiguration is required.
External Connected Device Failure at Safety Input	
Internal Input Failure at Safety Input	• Replace the DST1 if the system failure still occurs after turning the power supply ON again.

Message	Countermeasure
Safety Output Terminal-related Failures	
Cross Connection Detected at Safety Output	Check the following points: <ul style="list-style-type: none"> <li>• Make sure there is no overcurrent for the output.</li> <li>• Make sure the output signal wire does not have an earth fault.</li> <li>• Make sure the output signal wire is not contacting the positive side of the power supply.</li> <li>• Make sure there is not a short circuit between output signal wires.</li> <li>• Make sure the power supply voltage is set within the specification range.</li> </ul> To recover from these failures, the following conditions are required: The latch output error time must have passed, and the cause of the error must have been removed. The output signal from the user application for the target safety output must turn OFF.
Stuck-at-high Detected at Safety Output	
Short Circuit to Low at Safety Output	
Over Current Detected at Safety Output	
Dual Channel Output Failure	Check the program to see if output data for dual channels are the same.
Internal Relay Relevant Circuit Error at Safety Relay Output	• Check whether noise interference is excessive.
Relay Failure	Replace the safety relay.
EDM Error	Check the following items. <ul style="list-style-type: none"> <li>• Is the output signal line broken?</li> <li>• Is the output signal line grounded?</li> <li>• Is the output signal line in contact with the power supply (positive side)?</li> <li>• Is there a contactor or relay contact weld fault?</li> </ul>
Maintenance Information	
Total On Time or Contact Operation Counter Exceeded Threshold at Any Point	---
Operation Time Exceeded Threshold	---
Unit Conduction Time Exceeded Threshold	---
Network PS Voltage Fell Below Threshold	---
Error Related to Power Supply for I/O	
Output PS Voltage Low	Check the following items. <ul style="list-style-type: none"> <li>• Are cables broken?</li> <li>• Is the power supply voltage within specifications?</li> </ul>
Input PS Voltage Low	

## 7-4 Maintenance

This section describes the routine cleaning and inspection recommended as regular maintenance. Handling methods when replacing the DST1-series Safety I/O Terminals are also explained here.

### 7-4-1 Cleaning

Clean the DST1-series Safety I/O Terminals regularly as described below to keep the network in optimal operating condition.

- Wipe the DST1-series Safety I/O Terminals with a dry, soft cloth for regular cleaning.
- When dust or dirt cannot be removed with a dry cloth, dampen the cloth with a neutral cleanser (2%), wring out the cloth, and wipe the DST1-series Safety I/O Terminals.
- Smudges may remain on the DST1-series Safety I/O Terminals from gum, vinyl, or tape that was left on for a long time. Remove these smudges when cleaning.

**Note** Never use volatile solvents, such as paint thinner or benzene, or chemical wipes to clean the DST1-series Safety I/O Terminals. These substances may damage the surface of the DST1-series Safety I/O Terminals.

### 7-4-2 Inspection

Inspect the system periodically to keep it in optimal operating condition.

In general, inspect the system once every 6 to 12 months, but inspect more frequently if the system is used in high-temperature, humid, or dusty conditions.

### Inspection Equipment

Prepare the following equipment before inspecting the system.

#### Equipment Required for Regular Inspection

- Phillips screwdriver
- A flat-blade screwdriver
- A screwdriver for connecting communications connectors
- A tester (or a digital voltmeter)
- Industrial alcohol and a clean cloth

#### Other Equipment That May Be Required

- A synchroscope
- An oscilloscope
- A thermometer or hygrometer



## Inspection Procedure

Check the items in the following table and correct any condition that is below standard.

Inspection item	Details	Standard	Equipment
Environmental conditions	Are ambient and panel temperatures correct?	Refer to the specifications for each DST1.	Thermometer
	Are ambient and panel humidity correct?	Refer to the specifications for each DST1.	Hygrometer
	Has dust or dirt accumulated?	No dust or dirt	Visual inspection
Installation conditions	Is the DST1 installed securely?	No looseness	Phillips screwdriver
	Are the connectors of the communications cables fully inserted?	No looseness	A flat-blade screwdriver
	Are the external wiring screws tight?	No looseness	A flat-blade screwdriver
	Are the connecting cables undamaged?	No external damage	Visual inspection
Safety relay operation	Does the safety relay contact go to OFF state?	No welded contacts	Visual inspection

- IMPORTANT**
- The maintenance interval for the relay contacts must not exceed a period of 6 month to meet safety category 4 in accordance with EN 954-1.
  - The G7SA-2A2B must be used when replacing safety relays.

### 7-4-3 Replacing the DST1

The network consists of the DeviceNet Unit (master) and DST1 Terminals. The entire network is affected when a DST1 is faulty, so a faulty DST1 must be repaired or replaced quickly. We recommend having spare DST1 Terminals available to restore network operation as quickly as possible.

#### Precautions for Replacing the DST1

Observe the following precautions when replacing a faulty DST1.

After replacement, make sure that there are no errors in the new DST1.

When a DST1 is being returned for repair, attach a detailed description of the problem and return the DST1 to your OMRON representative.

If there is a faulty contact, try wiping the contact with a clean, lint-free cloth dampened with alcohol.

#### Settings after Replacing a DST1

After replacing a DST1, set the new DST1's switches and configuration data to the same settings that were used on the old DST1.

#### **WARNING**

**Safety functions may be impaired and serious injury may occasionally occur. When replacing a device, configure the replacement device suitably and confirm that it operate correctly.**





# SECTION 8

## Wiring Examples

8-1	Wiring and Configuration . . . . .	124
8-2	Examples of Wiring for Each Application . . . . .	125
8-2-1	Emergency Stop Switch Dual Channel Inputs with Manual Reset . . . . .	125
8-2-2	Two-Hand Input . . . . .	126
8-2-3	User Mode Switch Input . . . . .	127
8-2-4	Muting Lamp Output . . . . .	128
8-2-5	Limit Switch Dual Channel Inputs and a Manual Reset . . . . .	129
8-2-6	Safety Light Curtain Input . . . . .	130
8-2-7	Semiconductor Outputs for Dual Channel Mode . . . . .	131
8-2-8	Relay Outputs with Dual Channel Mode and EDM Input . . . . .	132
8-3	Logic Terminal Wiring Examples . . . . .	133
8-3-1	Stopping Outputs by Using an Emergency Stop Switch or a Signal from a Safety Master . . . . .	133

# 8-1 Wiring and Configuration

The following table shows input device connection methods and configuration.

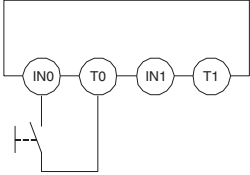
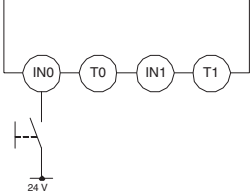
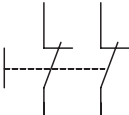
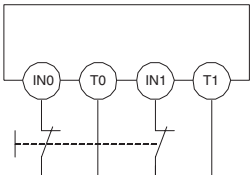
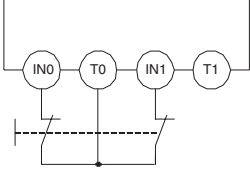
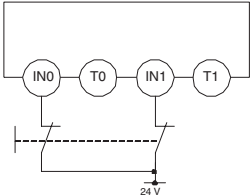
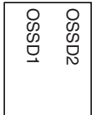
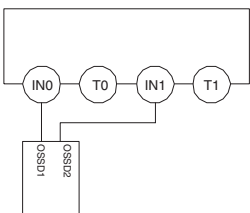
Connected device	Schematic diagram	Configuration
Reset switch 	Connect the switch between IN0 and T0. 	Safety Input used as "Single Channel input" without test output. Test output used as power supply output.
	Connect the switch between 24 V DC and IN0. 	Safety Input used as "Single Channel input" without test output.
Emergency stop switch Door monitor 	Connect the switches between IN0 and T0, and IN1 and T1. 	Safety Inputs used as "Dual Channel input" with test output. Test outputs used as "Pulse Test Output".
	Connect the switches between T0 and IN0, IN1. 	Safety Inputs used as "Dual Channel input" with test output. Test output used as "Pulse Test Output".
	Connect the switches between 24 V DC and IN0, IN1. 	Safety Inputs used as "Dual Channel input" without test output.
Safety Light Curtain 	Connect OSSD1 and OSSD2 to IN0 and IN1, respectively. 	Safety Inputs used as "Dual Channel input" without test output.

## 8-2 Examples of Wiring for Each Application

### 8-2-1 Emergency Stop Switch Dual Channel Inputs with Manual Reset

An example of the wiring and configuration when using the DST1-ID12SL-1 is shown below.

#### Wiring

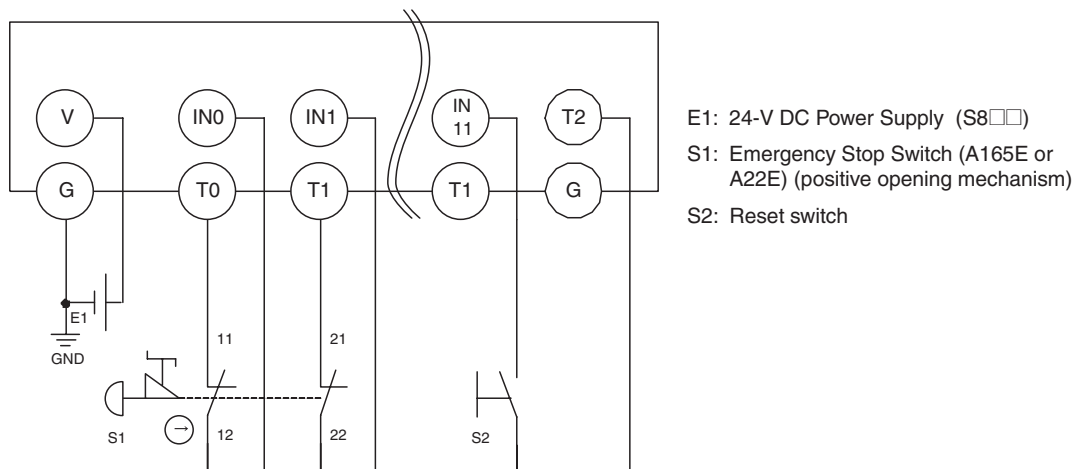

#### Configuration

Parameter group	Parameter name		Value
Safety Input 0	0008	Safety Input 0 Channel Mode	Test pulse from test out
	0009	Safety Input 0 Test Source	Test Output 0
	0054	Dual Channel Safety Input 0/1 Mode	Dual Channel Equivalent
	0055	Dual Channel Safety Input 0/1 Discrepancy Time	100 x 10 ms
Safety Input 1	0012	Safety Input 1 Channel Mode	Test pulse from test out
	0013	Safety Input 1 Test Source	Test Output 1
Safety Input 11	0052	Safety Input 11 Channel Mode	Used as standard input
	0053	Safety Input 11 Test Source	Not Used
	0064	Dual Channel Safety Input 10/11 Mode	Single Channel
Test Output 0	0001	Test Output 0 Mode	Pulse Test Output
Test Output 1	0002	Test Output 1 Mode	Pulse Test Output
Test Output 2	0003	Test Output 2 Mode	Power Supply Output

### 8-2-2 Two-Hand Input

An example of the wiring and configuration when using the DST1-ID12SL-1 is shown below.

#### Wiring

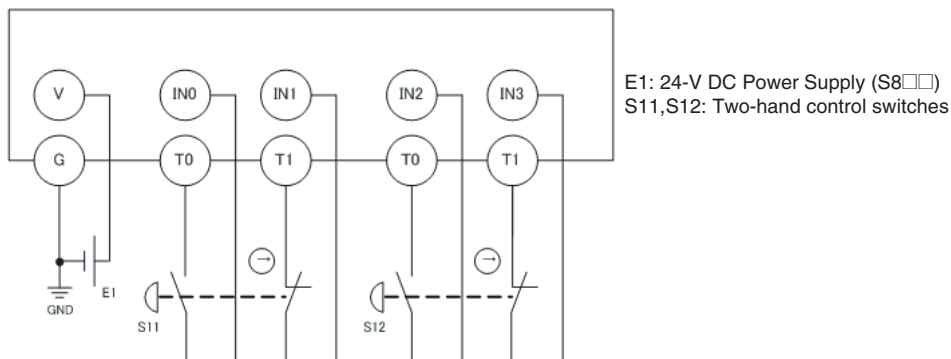

#### Configuration

Parameter group	Parameter name		Value
Safety Input 0	0008	Safety Input 0 Channel Mode	Test pulse from test out
	0009	Safety Input 0 Test Source	Test Output 0
	0054	Dual Channel Safety Input 0/1 Mode	Single channel
Safety Input 1	0012	Safety Input 1 Channel Mode	Test pulse from test out
	0013	Safety Input 1 Test Source	Test Output 1
Safety Input 2	0016	Safety Input 2 Channel Mode	Test pulse from test out
	0017	Safety Input 2 Test Source	Test Output 0
	0056	Dual Channel Safety Input 2/3 Mode	Single channel
Safety Input 3	0020	Safety Input 3 Channel Mode	Test pulse from test out
	0021	Safety Input 3 Test Source	Test Output 1
Test Output 0	0001	Test Output 0 Mode	Pulse Test Output
Test Output 1	0002	Test Output 1 Mode	Pulse Test Output

**Note** To connect switches, connect the NO terminals to input 0/2 and NC terminals to input 1/3.

### 8-2-3 User Mode Switch Input

An example of the wiring and configuration when using the DST1-ID12SL-1 is shown below.

#### Wiring

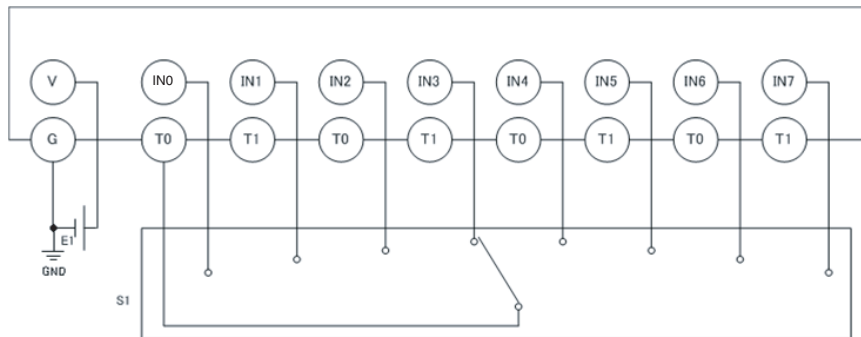

E1: 24-V DC Power Supply (S8□□)  
S1: User mode switch

#### Configuration

Parameter group	Parameter name		Value
Safety Input 0	0008	Safety Input 0 Channel Mode	Test pulse from test out
	0009	Safety Input 0 Test Source	Test Output 0
	0054	Dual Channel Safety Input 0/1 Mode	Single Channel
Safety Input 1	0012	Safety Input 1 Channel Mode	Test pulse from test out
	0013	Safety Input 1 Test Source	Test Output 0
Safety Input 2	0016	Safety Input 2 Channel Mode	Test pulse from test out
	0017	Safety Input 2 Test Source	Test Output 0
	0056	Dual Channel Safety Input 2/3 Mode	Single Channel
Safety Input 3	0020	Safety Input 3 Channel Mode	Test pulse from test out
	0021	Safety Input 3 Test Source	Test Output 0
Safety Input 4	0024	Safety Input 4 Channel Mode	Test pulse from test out
	0025	Safety Input 4 Test Source	Test Output 0
	0058	Dual Channel Safety Input 4/5 Mode	Single Channel
Safety Input 5	0028	Safety Input 5 Channel Mode	Test pulse from test out
	0029	Safety Input 5 Test Source	Test Output 0
Safety Input 6	0032	Safety Input 6 Channel Mode	Test pulse from test out
	0033	Safety Input 6 Test Source	Test Output 0
	0060	Dual Channel Safety Input 6/7 Mode	Single Channel
Safety Input 7	0036	Safety Input 7 Channel Mode	Test pulse from test out
	0037	Safety Input 7 Test Source	Test Output 0
Test Output 0	0001	Test Output 0 Mode	Pulse Test Output

### 8-2-4 Muting Lamp Output

An example of the wiring and configuration when using the DST1-ID12SL-1 is shown below.

#### Wiring

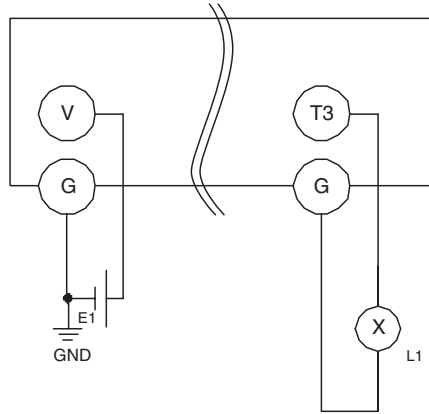

E1: 24-V DC Power Supply (S8□□)  
L1: External muting lamp

#### Configuration

Parameter group	Parameter name		Value
Test Output 3	0004	Test Output 3 Mode	Muting Lamp Output



### 8-2-5 Limit Switch Dual Channel Inputs and a Manual Reset

An example of the wiring and configuration when using the DST1-ID12SL-1 is shown below.

#### Wiring

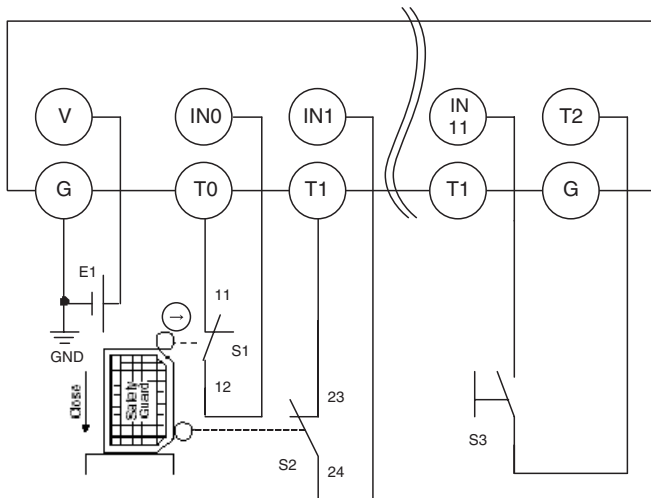

- E1: 24-V DC Power Supply (S8□□)
- S1: Safety Limit Switch (D4D or D4B) (positive opening mechanism)
- S2: Limit switch
- S3: Reset switch

#### Configuration

Parameter group	Parameter name		Value
Safety Input 0	0008	Safety Input 0 Channel Mode	Test pulse from test out
	0009	Safety Input 0 Test Source	Test Output 0
	0054	Dual Channel Safety Input 0/1 Mode	Dual Channel Equivalent
	0055	Dual Channel Safety Input 0/1 Discrepancy Time	100 x 10 ms
Safety Input 1	0012	Safety Input 1 Channel Mode	Test pulse from test out
	0013	Safety Input 1 Test Source	Test Output 1
Safety Input 11	0052	Safety Input 11 Channel Mode	Used as standard input
	0053	Safety Input 11 Test Source	Not Used
	0064	Dual Channel Safety Input 10/11 Mode	Single Channel
Test Output 0	0001	Test Output 0 Mode	Pulse Test Output
Test Output 1	0002	Test Output 1 Mode	Pulse Test Output
Test Output 2	0003	Test Output 2 Mode	Power Supply Output

### 8-2-6 Safety Light Curtain Input

An example of the wiring and configuration when using the DST1-ID12SL-1 is shown below.

#### Wiring

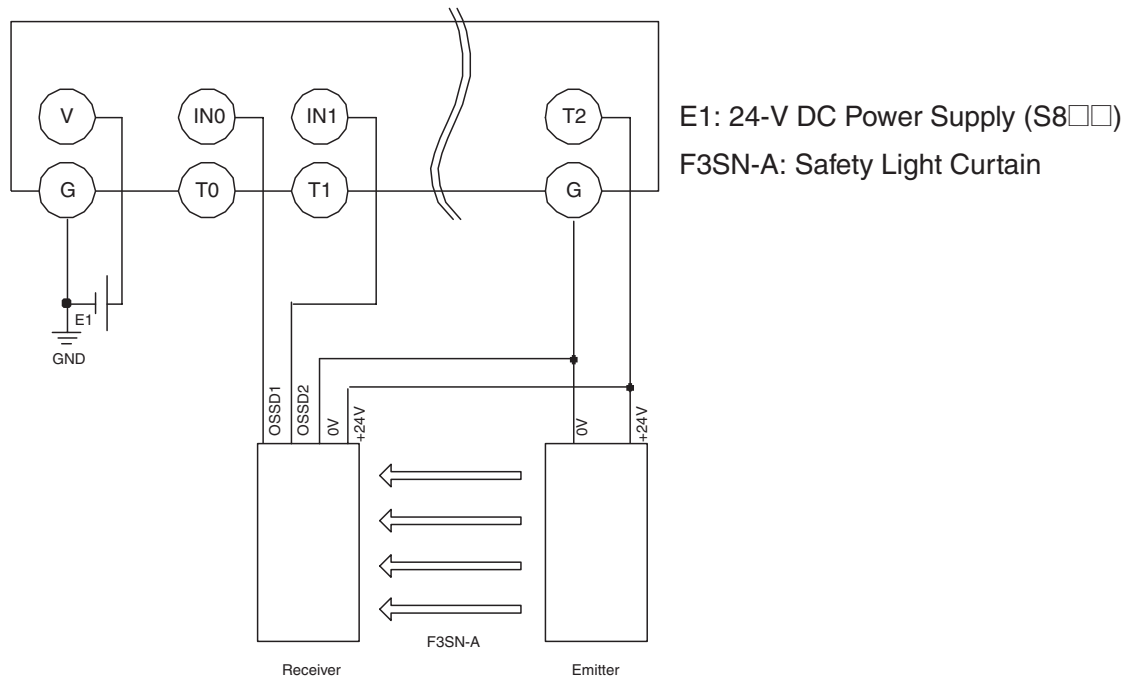

#### Configuration

Parameter group	Parameter name		Value
Safety Input 0	0008	Safety Input 0 Channel Mode	Used as safety input
	0009	Safety Input 0 Test Source	Not Used
	0054	Dual Channel Safety Input 0/1 Mode	Dual Channel Equivalent
	0055	Dual Channel Safety Input 0/1 Discrepancy Time	100 x 10 ms
Safety Input 1	0012	Safety Input 1 Channel Mode	Used as safety input
	0013	Safety Input 1 Test Source	Not Used
Test Output 2	0003	Test Output 2 Mode	Power Supply Output

### 8-2-7 Semiconductor Outputs for Dual Channel Mode

An example of the wiring and configuration when using the DST1-MD16SL-1 is shown below.

#### Wiring

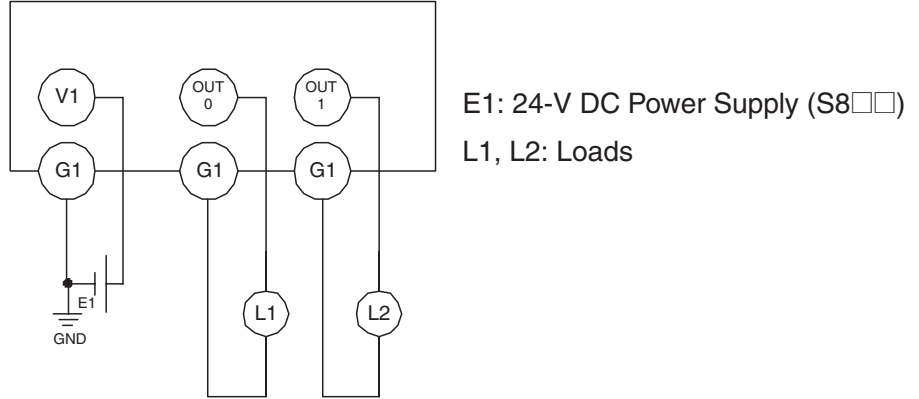

#### Configuration

Parameter group	Parameter name		Value
Safety Output 0	0006	Safety Output 0 Channel Mode	Safety Pulse Test
	0014	Dual Channel Safety Output 0/1 Mode	Dual Channel
Safety Output 1	0007	Safety Output 1 Channel Mode	Safety Pulse Test

### 8-2-8 Relay Outputs with Dual Channel Mode and EDM Input

An example of the wiring and configuration when using the DST1-MRD08SL-1 is shown below.

#### Wiring

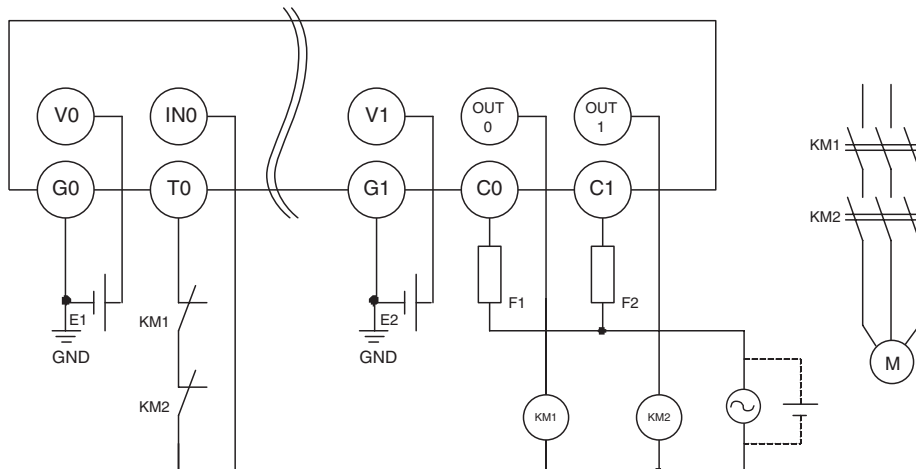

E1, E2: 24-V DC Power Supply (S8□□)

KM1, KM2: Magnetic Contactors

M: 3-phase motor

F1, F2: Fuses

#### Configuration

Parameter group	Parameter name		Value
Safety Input 0	0015	Safety Input 0 Channel Mode	Test pulse from test out
	0016	Safety Input 0 Test Source	Test Output 0
	0029	Dual Channel Safety Input 0/1 Mode	Single Channel
Test Output 0	0001	Test Output 0 Mode	Pulse Test Output
Safety Output 0	0006	Safety Output 0 Channel Mode	Used
	0010	Dual Channel Safety Output 0/1 Mode	Dual Channel
Safety Output 1	0007	Safety Output 1 Channel Mode	Used

### 8-3 Logic Terminal Wiring Examples

#### 8-3-1 Stopping Outputs by Using an Emergency Stop Switch or a Signal from a Safety Master

An example of the wiring and configuration when using the DST1-XD0808SL-1 is shown below.

#### Wiring

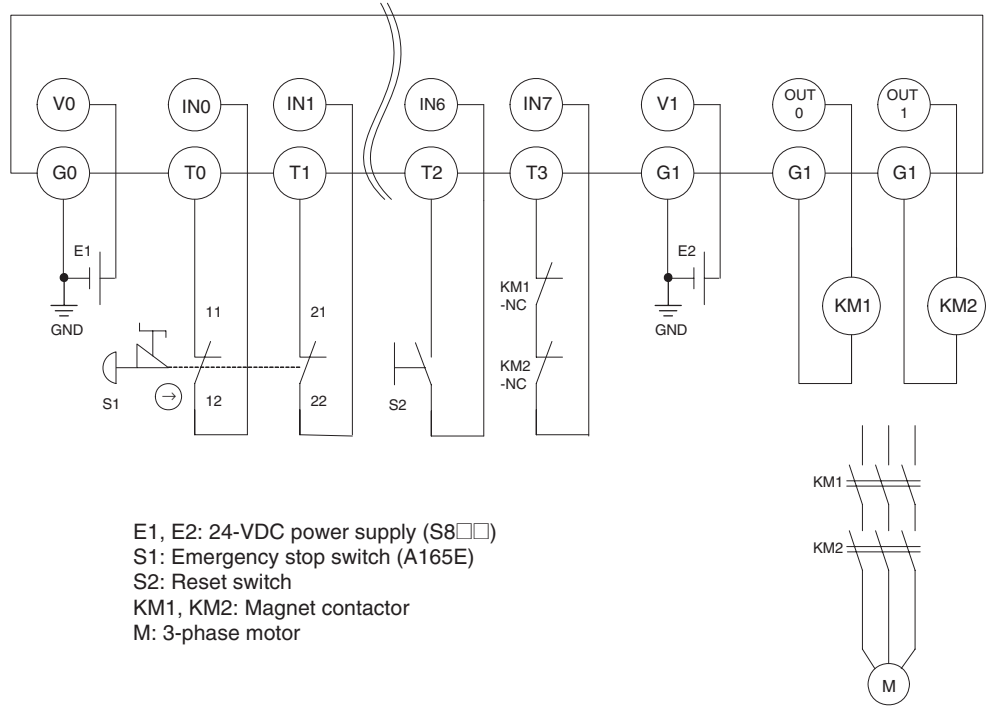

- E1, E2: 24-VDC power supply (S8□□)
- S1: Emergency stop switch (A165E)
- S2: Reset switch
- KM1, KM2: Magnet contactor
- M: 3-phase motor

**Operation Chart**

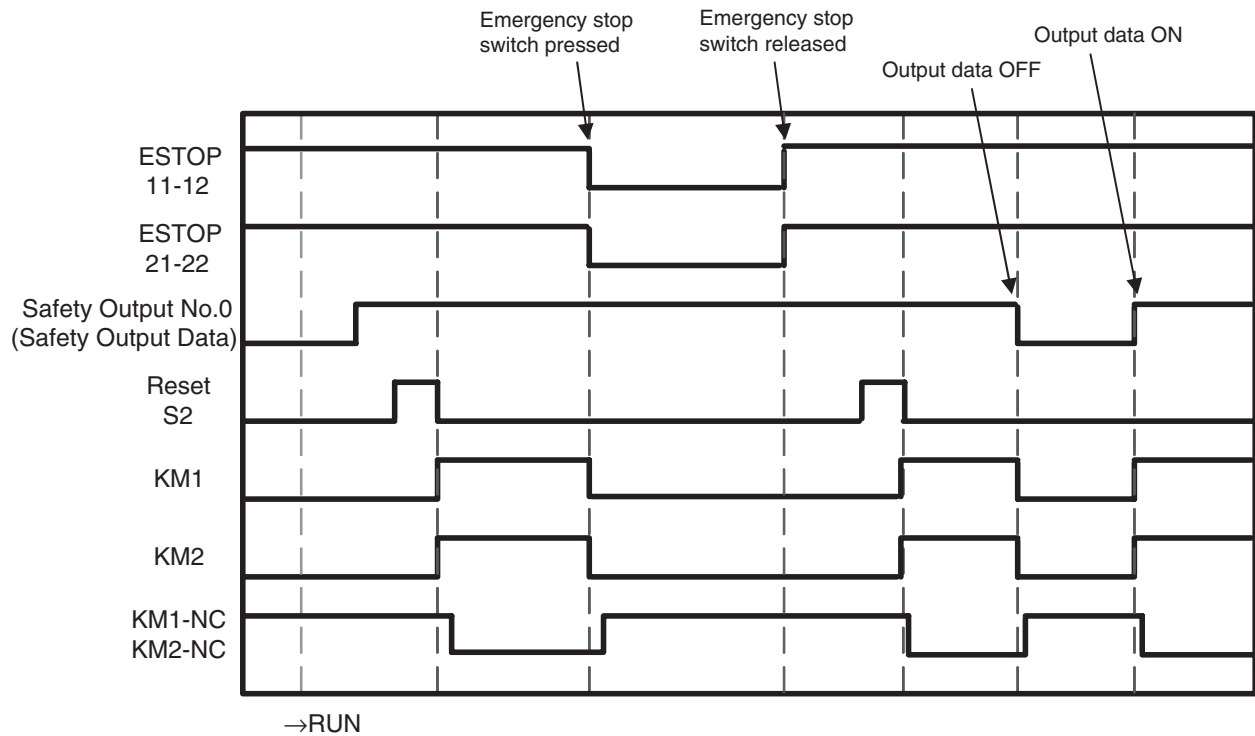





**Configuration**

Port	Safety Input Parameter					
	Channel Mode	Test Source	Off On Delay	On Off Delay	Dual Channel Mode	Discrepancy Time
IN 0	Test Pulse from test out	Test Output 0	0 ms	0 ms	Dual Channel Equivalent	500 ms
IN 1	Test Pulse from test out	Test Output 1	0 ms	0 ms		
IN 6	Test Pulse from test out	Test Output 2	0 ms	0 ms	Single Channel	---
IN 7	Test Pulse from test out	Test Output 3	0 ms	0 ms	Single Channel	---

Port	Test Output Parameter
	Output Mode
T0	Pulse Test Output
T1	Pulse Test Output
T2	Pulse Test Output
T3	Pulse Test Output

Port	Safety Output Parameter			
	Channel Mode	Off On Delay	On Off Delay	Dual Channel Mode
OUT 0	Safety Pulse Test	0 ms	0 ms	Dual Channel
OUT 1	Safety Pulse Test	0 ms	0 ms	

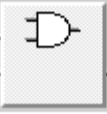
	Input	Input Condition	Reset	
[IN0/1] EMO NC EMO NC			 Reset Condition : IN6 Reset Low-High-Low	[Jump0] EMO NC
[IN6] Reset				
[IN7] Feedback(00)				

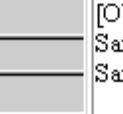
Output Condition	Welding Check(EDM)	Output	
 AND Condition : [Jump0] EMO NC Remote I/O	 Feedback : IN7 Feedback(00)	 Off On Delay : 0 ms On Off Delay :	[OUT0/1] Safety Relay Safety Relay





# Appendix

## Appendix 1: DeviceNet Explicit Messages

DeviceNet explicit messages sent from the Master Unit to the DST1-series Terminals can be used to read or write any parameter of a specified Terminal. The DST1-series Terminal processes a command sent from the Master Unit and then returns a response.

### A-1-1 Basic Format of Explicit Messages

The basic format of each command and response is shown below.

#### Command Block

Destination node address	Service code	Class ID	Instance ID	Attribute ID	Data
--------------------------	--------------	----------	-------------	--------------	------

#### **Destination Node Address**

The node address of the Unit that is sending the explicit message is specified with one hexadecimal byte.

#### **Service Code, Class ID, Instance ID, and Attribute ID**

The parameters used for specifying the command, processing object, and processing content.

**Note** The number of bytes designated for the class ID, instance ID, and attribute ID depend on the Master Unit. When sent from an OMRON DeviceNet Master, the class ID and instance ID are 2 bytes (4 digits) each, and the attribute ID is 1 byte (2 digits).

#### **Data**

Data is not required when a read command is used.

#### Response Block

##### **Normal Response Block**

Number of bytes received	Source node address	Service code	Data
--------------------------	---------------------	--------------	------

##### **Error Response Block**

Number of bytes received 0004 hex (fixed)	Source node address	Service code	Error code
--	---------------------	--------------	------------

#### **Number of Bytes Received**

The number of bytes received from the source node address is returned in hexadecimal. When an error response is returned for an explicit message, the number of bytes is always 0004 hex.

#### **Source Node Address**

The node address of the node from which the command was sent is returned in hexadecimal.

**Service Code**

For normal completions, the service code specified in the command with the leftmost bit turned ON is stored as shown in the following table.

Function	Command service code	Response service code
Read data	0E hex	8E hex
Write data	10 hex	90 hex
Reset	05 hex	85 hex
Save	16 hex	96 hex

When an error response is returned for an explicit message, the value is always 94 hex.

**Data**

Read data is included only when a read command is executed.

**Error Code**

The explicit message error code. For details, refer to the list of error codes in the following table.

**Error Codes**

Code	Error name	Cause
08FF	Service not supported	The service code is incorrect.
09FF	Invalid attribute value	The specified attribute value is not supported. The data written was outside the valid range.
16FF	Object does not exist	The specified Instance ID is not supported.
15FF	Too much data	The data is larger than the specified size.
13FF	Not enough data	The data is smaller than the specified size.
0CFF	Object state conflict	The specified command cannot be executed due to an internal error.
20FF	Invalid parameter	The specified operation command data is not supported.
0EFF	Attribute not settable	An attribute ID supported only for reading has been executed for a write service code.
10FF	Device state conflict	The specified command cannot be executed due to an internal hardware error.
14FF	Attribute not supported	The specified attribute is not supported.
19FF	Store operation failure	The data cannot be stored in memory.
2AFF	Group 2 only server general failure	The specified command or attribute is not supported or the attribute was not set.

## A-1-2 Explicit Messages

### Reading General Status

Explicit message	Read/write	Function	Command					Response
			Service code	Class ID	Instance ID	Attribute ID	Data size	
General Status Read	Read	Reads the specified slave's status flags (8 bits)	0E hex	95 hex	01 hex	65 hex	-	1 byte

### Setting and Monitoring the Unit Conduction Time

Explicit message	Read/write	Function	Command					Response
			Service Code	Class ID	Instance ID	Attribute ID	Data size	
Unit Maintenance Set Value	Read	Reads the set value for the Unit Conduction Time (unit: 0.1 h).	0E hex	95 hex	01 hex	73 hex	-	4 bytes 0000 0000 to FFFF FFFF hex (0 to 4,294,967,295)
	Write	Writes the set value for the Unit Conduction Time (unit: 0.1 h).	10 hex	95 hex	01 hex	73 hex	4 bytes 0000 0000 to FFFF FFFF hex (0 to 4,294,967,295)	
Unit Maintenance Present Value	Read	Reads the present value for the Unit Conduction Time (unit: 0.1 h).	0E hex	95 hex	01 hex	71 hex		4 bytes 0000 0000 to FFFF FFFF hex (0 to 4,294,967,295)
Unit Maintenance Flag	Read	Reads the monitor status of Unit Conduction Time.	0E hex	95 hex	01 hex	72 hex		1 byte 00 hex: Within range 01 hex: Over range (over the monitor value)

**Setting and Monitoring a Safety Input**

Explicit message	Read/write	Function	Command					Response
			Service Code	Class ID	Instance ID	Attribute ID	Data size	
Terminal Maintenance Information Monitor Mode	Read	Reads the monitor mode for maintenance information of the input (1 to 12) specified by the instance ID.	0E hex	3D hex	01 to 0C hex	65 hex		1 byte 00 hex: Total ON time mode 01 hex: Contact operation counter mode
	Write	Writes the monitor mode for maintenance information of the input (1 to 12) specified by the instance ID.	10 hex	3D hex	01 to 0C hex	65 hex	1 byte 00 hex: Total ON time mode 01 hex: Contact operation counter mode	
Input Set Value for Total ON Time or Contact Operation Counter	Read	Reads the set value for the total ON time (unit: s) or number of contact operations (unit: operations) of the input (1 to 12) specified by the instance ID.	0E hex	3D hex	01 to 0C hex	68 hex		4 bytes 0000 0000 to FFFF FFFF hex (0 to 4,294,967,295)
	Write	Writes the set value for the total ON time (unit: s) or number of contact operations (unit: operations) of the input (1 to 12) specified by the instance ID.	10 hex	3D hex	01 to 0C hex	68 hex	4 bytes 0000 0000 to FFFF FFFF hex (0 to 4,294,967,295)	
Input Total ON Time or Contact Operation Counter Read	Read	Reads the set value for the total ON time (unit: s) or number of contact operations (unit: operations) of the input (1 to 12) specified by the instance ID.	0E hex	3D hex	01 to 0C hex	66 hex		4 bytes 0000 0000 to FFFF FFFF hex (0 to 4,294,967,295)
Input Total ON Time or Contact Operation Counter Reset	Reset	Resets the total ON time or number of contact operations (unit: operations) for time input (1 to 12) specified by the instance ID.	05 hex	3D hex	01 to 0C hex	66 hex		

Explicit message	Read/write	Function	Command					Response
			Service Code	Class ID	Instance ID	Attribute ID	Data size	
Input Monitor Status for Total ON Time or Contact Operation Counter Read	Read	Reads the set value for the total ON time (unit: s) or number of contact operations (unit: operations) of the input (1 to 12) specified by the instance ID.	0E hex	3D hex	01 to 0C hex	67 hex		1 byte 00 hex: Within range 01 hex: Over range (over the monitor value)
Safety Input Cause of Error Information Read	Read	Reads the cause for the normal flag (1 to 12) specified by the Instance ID turning OFF.	0E hex	3D hex	01 to 0C hex	6E hex		0: No error 01 hex: Configuration invalid 02 hex: External wiring error 03 hex: Internal input failure 04 hex: Two-input logic discrepancy 05 hex: Error in the other dual channel input

**Setting and Monitoring the Safety Output Point**

Explicit message	Read/write	Function	Command					Response
			Service Code	Class ID	Instance ID	Attribute ID	Data size	
Terminal Maintenance Information Monitor Mode Read	Read	Reads the monitor mode for maintenance information of the output (1 to 8) specified by the instance ID.	0E hex	3B hex	01 to 08 hex	65 hex	-	1 byte 00 hex: Total ON time mode 01 hex: Contact operation counter mode
	Write	Writes the monitor mode for maintenance information of the output (1 to 8) specified by the instance ID.	10 hex	3B hex	01 to 08 hex	65 hex	1 byte 00 hex: Total ON time mode 01 hex: Contact operation counter mode	-
Output Set Value for Total ON Time or Contact Operation	Read	Reads the set value for the total ON time (unit: s) or number of contact operations (unit: operations) of the output (1 to 8) specified by the instance ID.	0E hex	3B hex	01 to 08 hex	68 hex	-	4 bytes 0000 0000 to FFFF FFFF hex (0 to 4,294,967,295)
	Write	Writes the set value for the total ON time (unit: s) or number of contact operations (unit: operations) of the output (1 to 8) specified by the instance ID.	10 hex	3B hex	01 to 08 hex	68 hex	4 bytes 0000 0000 to FFFF FFFF hex (0 to 4,294,967,295)	-
Output Total ON Time or Contact Operation Counter Read	Read	Reads the set value for the total ON time (unit: s) or number of contact operations (unit: operations) of the output (1 to 8) specified by the instance ID.	0E hex	3B hex	01 to 08 hex	66 hex	-	4 bytes 0000 0000 to FFFF FFFF hex (0 to 4,294,967,295)
Output Total ON Time or Contact Operation Counter Reset	Reset	Resets the total ON time or number of contact operations for time output (1 to 8) specified by the instance ID.	05 hex	3B hex	01 to 08 hex	66 hex		

Explicit message	Read/write	Function	Command					Response
			Service Code	Class ID	Instance ID	Attribute ID	Data size	
Output Monitor Status for Total ON Time or Contact Operation Counter Read	Read	Reads the set value for the total ON time or number of contact operations of the output (1 to 8) specified by the instance ID.	0E hex	3B hex	01 to 08 hex	67 hex	-	1 byte 00 hex: Within range 01 hex: Over range (over the monitor value)
Safety Output Cause of Error Information Read	Read	Reads the cause for the normal flag (1 to 8) specified by the Instance ID turning OFF.	0E hex	3B hex	01 to 08 hex	6E hex		0: No error 01 hex: Configuration invalid 02 hex: Overcurrent detected 03 hex: Short-circuit detected 04 hex: Output ON error 05 hex: Error in the other dual channel output 06 hex: Internal relay relevant circuit error 07 hex: Relay failure 08 hex: Dual channel violation 09 hex: Cross connection detected 0A hex: EDM error

**Setting and Monitoring the Test Output Point**

Explicit message	Read/write	Function	Command					Response
			Service Code	Class ID	Instance ID	Attribute ID	Data size	
Terminal Maintenance Information Monitor Mode Read	Read	Reads the monitor mode for maintenance information of the output (1 to 4) specified by the instance ID.	0E hex	09 hex	01 to 04 hex	65 hex	-	1 byte 00 hex: Total ON time mode 01 hex: Contact operation counter mode
	Write	Writes the monitor mode for maintenance information of the output (1 to 4) specified by the instance ID	10 hex	09 hex	01 to 04 hex	65 hex	1 byte 00 hex: Total ON time mode 01 hex: Contact operation counter mode	-
Output Set Value for Total On Time or Contact Operation	Read	Reads the set value for the total ON time (unit: s) or number of contact operations (unit: operations) of the output (1 to 4) specified by the instance ID.	0E hex	09 hex	01 to 04 hex	68 hex	-	4 bytes 0000 0000 to FFFF FFFF hex (0 to 4,294,967,295)
	Write	Writes the set value for the total ON time (unit: s) or number of contact operations (unit: operations) of the output (1 to 4) specified by the instance ID.	10 hex	09 hex	01 to 04 hex	68 hex	4 bytes 0000 0000 to FFFF FFFF hex (0 to 4,294,967,295)	-
Output Total ON Time or Contact Operation Counter Read	Read	Reads the set value for the total ON time (unit: s) or number of contact operations (unit: operations) of the output (1 to 4) specified by the instance ID.	0E hex	09 hex	01 to 04 hex	66 hex	-	4 bytes 0000 0000 to FFFF FFFF hex (0 to 4,294,967,295)
Output Total ON Time or Contact Operation Counter Reset	Reset	Resets the total ON time or number of contact operations for time output (1 to 4) specified by the instance ID.	05 hex	09 hex	01 to 04 hex	66 hex		



Explicit message	Read /write	Function	Command					Response
			Service Code	Class ID	Instance ID	Attribute ID	Data size	
Output Monitor Status for Total ON Time or Contact Operation Counter Read	Read	Reads the set value for the total ON time or number of contact operations (unit: operations) of the output (1 to 4) specified by the instance ID.	0E hex	09 hex	01 to 04 hex	67 hex	-	1 byte 00 hex: Within range 01 hex: Over range (over the monitor value)
Safety Output Cause of Error Information Read	Read	Reads the cause for the normal flag (1 to 8) specified by the Instance ID turning OFF.	0E hex	09 hex	01 to 04 hex	76 hex		0 = No error 01 hex: Configuration invalid 02 hex: Overload detected 05 hex: Output ON error 06 hex: Current limit detection

**Setting and Monitoring Operation Time**

Explicit message	Read /write	Function	Command					Response Data size
			Service Code	Class ID	Instance ID	Attribute ID	Data size	
Set Value for Operation Time Monitor	Read	Reads the monitor value for the time (unit: ms) from when the output (1 to 8) specified by the instance ID turns ON until the corresponding input turns ON.	0E hex	97 hex	01 to 08 hex	67 hex	-	2 bytes 0000 to FFFF hex (0 to 65535)
	Write	Writes the monitor value for the time (unit: ms) from when the output (1 to 8) specified by the instance ID turns ON until the corresponding input turns ON.	10 hex	97 hex	01 to 08 hex	67 hex	2 bytes 0000 to FFFF hex (0 to 65535)	
Present Value for Operation Time Monitor	Read	Reads the present value for the time (unit: ms) from when the output (1 to 8) specified by the instance ID turns ON until the corresponding input turns ON.	0E hex	97 hex	01 to 08 hex	65 hex	-	2 bytes 0000 to FFFF hex (0 to 65535)
Monitor Status Value for Operation Time Monitor Read	Read	Reads the monitor status for the time (unit: ms) from when the output (1 to 8) specified by the instance ID turns ON until the corresponding input turns ON.	0E hex	97 hex	01 to 08 hex	66 hex	-	1 byte 00 hex: Within range 01 hex: Over range (over the monitor value)

**Setting Hold/Clear for Communications Errors (Test Output)**

Explicit message	Read /write	Function	Command					Response
			Service Code	Class ID	Instance ID	Attribute ID	Data size	
Setting for Output Status (Hold or Clear) after Communications Error	Read	Reads whether hold or clear is set as the output status after a communications error for the output (1 to 4) specified by the instance ID. The setting can be read for a specified number of points.	0E hex	09 hex	01 to 04 hex	05 hex	-	1 byte 00 hex: Clear 01 hex: Hold
Setting for Output Status (Hold or Clear) after Communications Error	Write	Sets either hold or clear as the output status after a communications error for an output (1 to 4) specified by the instance ID. The setting can be read for a specified number of points.	10 hex	09 hex	01 to 04 hex	05 hex	1 byte 00 hex: Clear 01 hex: Hold	

**Note** The default setting is for all outputs to be cleared (0).

**Writing Maintenance Information**

Explicit message	Read /write	Function	Command					Response
			Service Code	Class ID	Instance ID	Attribute ID	Data size	
Maintenance Counter Save	Save	Records the maintenance counter in the Slave's memory	16 hex	95 hex	01 hex	-	-	-

### A-1-3 Using Explicit Messages

The following example shows how to use explicit messages with the DST1-series Safety I/O Terminals using a CS1W-DRM21 DeviceNet Unit (Master).

Example: Reading the Monitor Status for the Operation Time Monitor

#### Example Conditions

- DeviceNet Unit node address: 05
- Unit number: 0
- Unit address: FE hex (or 10 hex)
- DST1 node address: 11

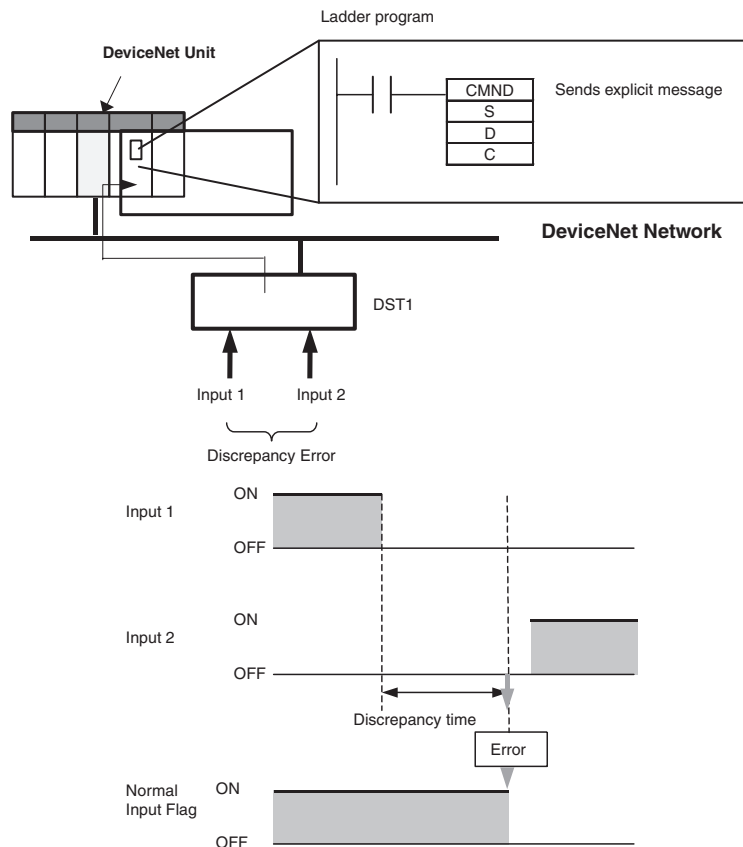

**Command Details**

• [CMND S D C]

S: D01000

D (first response word): D02000

C: D00000

**Contents of S**

Address	Contents	Meaning
D01000	2801 hex	Command code
D01001	0B0E hex	DST1 node address: 11 Service code: 0E hex
D01002	003D hex	Class ID: 003D hex
D01003	0001 hex	Instance ID: 0001 hex
D01004	6E** hex	Attribute ID: 6E□□ hex (Set any value for the blank boxes.)

**Contents of C**

Address	Contents	Meaning
D00000	0009 hex	Number of bytes of command data
D00001	0009 hex	Number of bytes of response data
D00002	0000 hex	Destination DeviceNet Unit network address: 0
D00003	05FE hex	Destination DeviceNet Unit node address: 5 Destination DeviceNet Unit address: FE hex (or 10 hex)
D00004	0000 hex	Response required Communications port number: 0 Number of retries: 0
D00005	003C hex	Response monitoring time: 6 s

**Response**

**Contents of D**

Address	Contents	Meaning
D02000	2801 hex	
D02001	0000 hex	
D02002	0003 hex	
D02003	0B8E hex	Response source node address: 11 (0B hex) Normal completion: 8E hex
D02004	0400 hex	Safety input cause of error information:  <div style="display: flex; align-items: center;"> <span style="margin-right: 10px;">0004</span>  </div>

## Appendix 2: Calculated Values of PFD and PFH

Calculated values of PFD and PFH of the DST1-series Safety I/O Terminals are given in the following tables. These values must be calculated for the overall devices within the system to comply with the SIL level required for application.

### A-2-1 Calculated PFD Values

Model	Proof test interval (years)	PFD
DST1-ID12SL-1	0.25	2.21E-07
	0.5	4.39E-07
	1	8.76E-07
	2	1.76E-06
DST1-MD16SL-1	0.25	2.22E-07
	0.5	4.40E-07
	1	8.77E-07
	2	1.76E-06
DST1-MRD08SL-1	0.25	4.70E-06
	0.5	9.54E-06
DST1-XD0808SL-1	0.25	2.22E-07
	0.5	4.40E-07
	1	8.77E-07
	2	1.76E-06

**IMPORTANT** The proof test interval of the DST1-MRD08SL-1 must not exceed 0.5 years because the maintenance interval for the relay contacts must not exceed a period of 6 month to satisfy safety category 4 in accordance with EN 954-1.

### A-2-2 Calculated PFH Values

Model	PFH
DST1-ID12SL-1	2.00E-10
DST1-MD16SL-1	2.00E-10
DST1-MRD08SL-1	4.20E-09
DST1-XD0808SL-1	2.00E-10

# Index

## A

applications  
precautions, xxiii

## C

cleaning, 120  
clearing the error history, 26  
communications connector, 51  
configuration, 52  
configuration lock indicator, 90  
configuration status, 90  
Connected Component Maintenance Flag, 34, 37  
Copy Group Button, 59  
current consumption, 88

## D

DeviceNet communications  
connector, 51  
specifications, 89  
DeviceNet explicit messages, 137  
DeviceNet Safety  
protocol, 2  
dimensions  
DST1-ID12SL-1, 96  
DST1-MD16SL-1, 100  
DST1-MRD08SL-1, 105  
DST1-XD0808SL-1, 109  
discrepancy time, 11  
DST1-ID12SL-1  
dimensions, 96  
internal circuits, 95  
nomenclature, 94  
safety input specifications, 94  
terminal arrangement, 95  
test output specifications, 94  
DST1-MD16SL-1  
dimensions, 100  
internal circuits, 98  
nomenclature, 98  
safety input specifications, 97  
safety output specifications, 97  
terminal arrangement, 99  
test output specifications, 97  
DST1-MRD08SL-1  
dimensions, 105

internal circuits, 102  
nomenclature, 102  
safety input specifications, 101  
safety output specifications, 101  
terminal arrangement, 102  
test output specifications, 101

DST1-XD0808SL-1  
dimensions, 109  
internal circuits, 107  
nomenclature, 106  
safety input specifications, 106  
safety output specifications, 106  
terminal arrangement, 107  
test output specifications, 106  
dual channel mode, 11, 15  
complementary, 14  
equivalent, 13  
relay outputs, 132  
semiconductor outputs, 131  
dual channel safety input status, 24

## E

editing parameters, 54  
error codes  
list, 138  
error history, 118  
error processing  
indicators, 114  
error recovery, 14, 16  
explicit messages, 137  
application examples, 148  
list, 139

## F

features, 3  
ferrules, 48  
list of models, 49  
functions  
password protection, 9  
safety, 9  
safety inputs, 7  
safety outputs, 15  
self-diagnosis, 9  
test outputs, 8

## **G**

general parameter group, 60  
glossary, xxiv

## **I**

I/O assembly data, 77  
I/O cables, 48  
I/O comments, 63  
I/O data, 72  
I/O indicators, 91  
I/O power supply indicators, 91  
I/O status data, 16  
IN PWR indicator, 91  
indicators, 90  
    error processing, 114  
inspection, 120  
installation, 47

## **L**

last maintenance date, 32  
Limit Switch  
    with dual channel inputs, 129  
LOCK indicator, 90

## **M**

maintenance, 120  
Maintenance Counter Mode, 34, 39  
maintenance functions, 27  
maintenance functions of DST1-series safety I/O terminals, 27  
manual reset, 125, 129  
Monitor Device Button, 21  
monitoring functions, 21  
monitoring parameters, 23  
monitoring status, 21  
monitoring the contact operation counters, 34  
monitoring the error status, 25  
monitoring the operation time, 41  
monitoring the run hours, 29  
monitoring the total ON times, 37  
MS indicator, 90  
muting lamp output, 128

## **N**

Network Configurator, 52  
node address, 52  
nomenclature  
    DST1-ID12SL-1, 94  
    DST1-MD16SL-1, 98  
    DST1-MRD08SL-1, 102  
    DST1-XD0808SL-1, 106  
NS indicator, 90

## **O**

OFF delay, 15  
ON delay, 15  
operating environment  
    precautions, xxi  
operation time, 41, 66  
operation time exceed hold alarm, 44  
operation time parameter groups, 66  
OUT PWR indicator, 91

## **P**

password protection, 9  
PFD  
    calculated values, 150  
PFH  
    calculated values, 150  
precautions  
    applications, xxiii  
    general, xvi  
    operating environment, xxi  
    replacing the DST1, 121  
    safety precautions, xix

## **R**

recording the maintenance date, 32  
regulations, xxiii  
relay outputs  
    dual channel mode, 132  
remote I/O allocations, 70  
replacing the DST1, 121



**S**

- safety functions, 9
- Safety I/O Terminals, 2
  - with relay outputs, 101
- safety input, 62
- safety input parameter groups, 62
- safety input specifications, 97
  - DST1-ID12SL-1, 94
  - DST1-MRD08SL-1, 101
  - DST1-XD0808SL-1, 106
- safety input terminal status, 24
- safety input terminals, 94
- safety inputs, 7, 10
  - errors, 115
- Safety Light Curtain input, 130
- Safety Network Controller, 2
- safety output parameter groups, 65
- safety output parameters, 68
- safety output specifications
  - DST1-MD16SL-1, 97
  - DST1-MRD08SL-1, 101
  - DST1-XD0808SL-1, 106
  - relay outputs, 101
  - semiconductor outputs, 97
- safety output terminal status, 24
- safety outputs, 15, 65
  - errors, 117
- safety precautions, xix
- saving the error history, 26
- self-diagnosis functions, 9
- semiconductor outputs
  - dual channel mode, 131
- Setting the Contact Operation Counter Threshold, 35
- setting the threshold run hours, 29
- setting the threshold value for total ON time, 39
- specifications
  - common, 88
  - current consumption, 88
  - DeviceNet communications, 89
  - safety inputs, 94, 97, 101
  - test outputs, 94, 97, 101
  - weight, 88
- standard models, 5
- standards, xxiii

**T**

- terminal arrangement
  - DST1-ID12SL-1, 95
  - DST1-MD16SL-1, 99
  - DST1-MRD08SL-1, 102
  - DST1-XD0808SL-1, 107
- test output parameter groups, 64
- test output specifications
  - DST1-ID12SL-1, 94
  - DST1-MD16SL-1, 97
  - DST1-MRD08SL-1, 101
  - DST1-XD0808SL-1, 106
- test output terminal status, 24
- test outputs, 8, 64
  - errors, 116
- threshold maintenance counter, 35, 39
- threshold network power voltage, 27
- threshold response time, 43
- troubleshooting, 115
- two-hand input, 126

**U**

- user mode switch input, 127

**V**

- voltage monitor, 27

**W**

- weight, 88
- wiring
  - examples, 125
  - input devices, 124



## Revision History

The manual revision is indicated at the end of the Cat. No. printed at the lower left of back cover of the manual.

Cat. No. Z904-E1-06

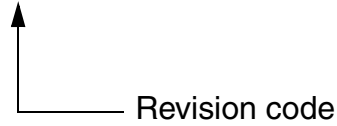

The following table outlines the changes made to the manual during each revision. Page numbers refer to the previous version.

Revision code	Date	Revised content
1	April 2005	First edition
02	February 2006	<p><b>Page 9:</b> Precautions added.</p> <p><b>Pages 9 and 5-12:</b> Information added on isolating transformers.</p> <p><b>Pages 3-7 and 3-8:</b> Information added on I/O data supported by Safety I/O Terminals.</p> <p><b>Page 5-9:</b> Changes made to safety output specifications.</p> <p><b>Page 6-2:</b> Changes made to indicators and error processing table.</p> <p><b>Pages 6-3 to 6-5:</b> Changes made to troubleshooting tables.</p> <p><b>Pages 6-6 and 6-7:</b> Changes made to error history table.</p>
03	June 2007	Revised to add information on DST-XD0808SL-1 and corrected mistakes.
04	March 2008	<p><b>Page xx:</b> Added precaution.</p> <p><b>Page xxi:</b> Updated regulations and standards and removed note.</p> <p><b>Page 7:</b> Changed definition of “contact operation counters.”</p> <p><b>Page 17:</b> Added new material on DST-XD0808SL-1 and parameters that can be set and deleted previous material.</p> <p><b>Page 41:</b> Added crimping tool model.</p> <p><b>Page 53:</b> Changed “SAFE” and “NON-SAFE” designations in table.</p> <p><b>Pages 55 to 58:</b> Changed description of default values.</p> <p><b>Pages 77, 80, 84, and 89:</b> Changed “DRAIN” to “Shield” in circuit diagrams.</p> <p><b>Page 83:</b> Removed specification for the rated load for an inductive load.</p> <p><b>Page 94:</b> Added information for the DST-XD0808SL-1.</p> <p><b>Pages 97 to 99:</b> Changed error names and responses.</p>
05	September 2008	<p><b>Page xxi:</b> Changed TUV Rheinland standards.</p> <p><b>Pages 6 to 8:</b> Changed references for online monitoring and maintenance functions.</p> <p><b>Page 20:</b> Added sections 1-6 and 1-7.</p> <p><b>Page 30:</b> Added new section 3-1 (but new section 3-1-9 was previously 3-1-8).</p> <p><b>Page 37:</b> Changed descriptions of input data.</p> <p><b>Page 38:</b> Changed descriptions of output data, moved note from previous page, and added note.</p> <p><b>Page 57:</b> Changed first note in section 4-2-4.</p>

## *Revision History*

Revision code	Date	Revised content
05A	November 2009	<p><b>Page 86:</b> Added communications current consumption to section 4-1-2.</p> <p><b>Page 87:</b> Changed layout of bottom table.</p>
06	June 2011	<p><b>Page ix:</b> Added new models to table.</p> <p><b>Page xix:</b> Added test outputs (at three locations).</p> <p><b>Page xx:</b> Changed switching capacity from 5 to 4 mA and added item toward bottom of page.</p> <p><b>Page 2:</b> Changed “safety” to “standard” in figure.</p> <p><b>Page 5:</b> Corrected reference to note.</p> <p><b>Page 15:</b> Changed length of test pulse in first sentence of 1-4-3 Safety Outputs.</p> <p><b>Page 59:</b> Added “test” to description of Safety Input Error Latch Time.</p> <p><b>Page 61:</b> Corrected second row of table.</p> <p><b>Pages 62 and 63:</b> Added information in parentheses to second to last row of table.</p> <p><b>Page 86:</b> Added information at bottom of page.</p> <p><b>Page 93:</b> Changed “input” to “I/O” in figure.</p> <p><b>Pages 96 and 100:</b> Changed “input” and “output” to “I/O” in figure.</p> <p><b>Page 101:</b> Removed “standard” at top of page.</p> <p><b>Page 110:</b> Changed “or” to “and” at bottom of page.</p> <p><b>Page 112:</b> Removed text from middle of page.</p> <p><b>Page 114:</b> Corrected last row of first table.</p> <p><b>Page 115:</b> Changed the rows for the following codes: 05, 06, and 07 hex.</p> <p><b>Pages 116 and 117:</b> Made minor changes to some messages.</p> <p><b>Page 122:</b> Corrected “IN” to “IN1” in middle of table.</p> <p><b>Pages 123 to 125, 127, and 130:</b> Changed “output” to “out” in some of the cells in the value column.</p> <p><b>Page 124:</b> Changed figure, corrected test output numbers, and notes at bottom.</p> <p><b>Page 125:</b> Changed figure.</p> <p><b>Page 136:</b> Corrected codes for read data and write data in top table.</p> <p><b>Page 146:</b> Corrected operands of CMND and changed direction of arrow in figure.</p>

---

*Revision History*

---

**OMRON Corporation Industrial Automation Company**

Tokyo, JAPAN

Contact: [www.ia.omron.com](http://www.ia.omron.com)

**Regional Headquarters**

**OMRON EUROPE B.V.**

Wegalaan 67-69-2132 JD Hoofddorp  
The Netherlands  
Tel: (31)2356-81-300/Fax: (31)2356-81-388

**OMRON SCIENTIFIC TECHNOLOGIES INC.**

6550 Dumbarton Circle,  
Fremont, CA 94555-3605 U.S.A.  
Tel: (1) 510-608-3400/Fax: (1) 510-744-1442

**OMRON ASIA PACIFIC PTE. LTD.**

No. 438A Alexandra Road # 05-05/08 (Lobby 2),  
Alexandra Technopark,  
Singapore 119967  
Tel: (65) 6835-3011/Fax: (65) 6835-2711

**OMRON (CHINA) CO., LTD.**

Room 2211, Bank of China Tower,  
200 Yin Cheng Zhong Road,  
PuDong New Area, Shanghai, 200120, China  
Tel: (86) 21-5037-2222/Fax: (86) 21-5037-2200

**Authorized Distributor:**

© OMRON Corporation 2005 All Rights Reserved.  
In the interest of product improvement,  
specifications are subject to change without notice.

Printed in Japan

**Cat. No. Z904-E1-06**

0611