

Enterprise Manager 1100

User's Guide



I615-E-01C

Copyright Notice

The information contained herein is the property of Omron Adept Technologies, Inc., and shall not be reproduced in whole or in part without prior written approval of Omron Adept Technologies, Inc. The information herein is subject to change without notice and should not be construed as a commitment by Omron Adept Technologies, Inc. The documentation is periodically reviewed and revised.

Omron Adept Technologies, Inc., assumes no responsibility for any errors or omissions in the documentation. Critical evaluation of the documentation by the user is welcomed. Your comments assist us in preparation of future documentation. Please submit your comments to: tech-pubs@adept.com.

Copyright © 2015 - 2017 by Omron Adept Technologies, Inc. All rights reserved.

Any trademarks from other companies used in this publication
are the property of those respective companies.

Created in the United States of America

Table of Contents

Chapter 1: Introduction	7
Definitions	7
Purpose of the Enterprise Manager 1100	7
1.1 Product Description	7
Features	9
1.2 Hardware that Comes with Enterprise Manager 1100 Systems	9
Appliance	9
Options	10
What Doesn't Come with an Enterprise Manager 1100?	10
1.3 Software that Comes with Enterprise Manager 1100 Systems	10
Mobile Robot Software Suite	10
SetNetGo	12
1.4 How Can I Get Help?	13
Related Manuals	13
Support	13
Chapter 2: Safety	15
2.1 Dangers, Warnings, Cautions, and Precautions	15
2.2 Safety Precautions for Mobile Robots	15
General Hazards	15
Electrical Hazards	16
Pinch Hazard	16
Magnetic Field Hazards	16
2.3 Mobile Robot Battery Safety	17
2.4 What to Do in an Emergency /Abnormal Situation	17
2.5 Additional Safety Information	18
Mobile Robot LD Safety Guide	18
2.6 Manufacturer's Declarations Guide	18
Chapter 3: Installation	19
3.1 Site Preparation	19
3.2 Transport and Storage	19
3.3 Before Unpacking	19
3.4 Mounting the Appliance	20
3.5 Connecting Power	20
Installing a Secondary Appliance	20

Chapter 4: Connectors and Indicators	21
4.1 Front Controls and Indicators	21
Power Switch	21
SYS LED	21
HDD LED	21
MAINT Ethernet Port	21
MGMT Ethernet Port	22
FLEET PORTS	22
PRIMARY WHEN LIT LED	22
KEY Port	22
4.2 Rear Controls and Indicators	22
AC Power In	22
AC Power Switch	23
Factory Field Service Ports	23
4.3 Connecting to a Network	23
Network Ports and Protocols	23
Chapter 5: Configuration	27
5.1 Overview	27
Ethernet Connection	27
Configuration Tasks	27
5.2 Setting the IP Address on Your PC	28
5.3 Connecting Your PC to the Enterprise Manager 1100 Appliance	29
5.4 Connecting to SetNetGo	29
5.5 Configuring Network Settings for the Management Interface	31
5.6 Setting SetNetGo and ARAMCentral Security	31
SetNetGo Password	31
ARAMCentral Account Passwords	31
5.7 Synchronizing Time	32
5.8 Enabling the ARCL Server	33
5.9 Configuring a Secondary Appliance and Autosync	33
Tasks in Autosync Setup	35
Installing a Secondary Appliance	36
Configuring the Primary Appliance	36
Configuring the Secondary Appliance	36
5.10 Configuring Each AIV to Connect to the Enterprise Manager 1100	37
MobilePlanner Icons	38
AIV-Level Settings	39
Fleet-Level Settings	40
5.11 Customizing Each AIV	40
Docking Station Assignment	40
Distinct Voices	41
5.12 Call Buttons	41

Chapter 6: Operation	43
6.1 Turning Power ON and OFF	43
Reaction to a Power Failure	43
6.2 Generating a Map for a Fleet	43
6.3 Managing Queuing	44
Queuing/Job Definitions	44
Queuing Examples	46
Queuing Parameters	47
Manually Clearing the Entire Queue	50
6.4 Troubleshooting	51
Including a debugInfo File	52
6.5 Updating ARAMCentral	53
Restarting ARAMCentral	53
6.6 What to do if a Primary Appliance Fails	53
Chapter 7: Options	55
7.1 Auto-Synchronized Secondary Appliance	55
Chapter 8: Technical Specifications	57
8.1 Processing Specifications	57
8.2 Environmental Specifications	57
8.3 Power Requirements	57
8.4 Dimensions	58
8.5 Connections	59
Front	59
Rear	59

Chapter 1: Introduction

Definitions

Platform: The most basic part of a mobile robot. This includes the chassis, drive assemblies, suspension, battery, sensors, an on-board core, software needed to navigate, and connectors for interfacing with and powering the payload structure.

Payload Structure: Anything you attach to the mobile robot platform. This could be as simple as a box for holding parts or documents that you want transported, or as complicated as a robotic arm, that is used to pick up parts to transport.

Autonomous Intelligent Vehicle (AIV): The mobile robot platform with a payload structure attached to it. This is your complete mobile robot, which will handle and transport your products, parts, or data.

When referring to the setup, configuration, and connections, we will refer to the platform. When talking about controlling or monitoring the full mobile robot, with a payload structure attached, we will refer to the AIV.

For descriptions of software refer to Software that Comes with Enterprise Manager 1100 Systems on page 10.

Purpose of the Enterprise Manager 1100

Typically, when managing a fleet of AIVs, all of the AIVs should be configured identically. However, maintaining identical configurations on each individual AIV can be time-consuming and error-prone. The Enterprise Manager 1100 system solves this by allowing you to manage map and configuration updates from a central communication point. These are then pushed out to each AIV in the fleet. Additionally, the Enterprise Manager provides a queuing manager to receive job requests from call buttons and automation equipment, and dispatch jobs to the AIVs in the fleet.

The Enterprise Manager 1100 also coordinates the movement of up to 100 AIVs in a fleet, to make sure that each AIV knows the location and path of any other AIV that might affect it, allowing the AIVs to work within close range of each other. This prevents AIVs from colliding, or otherwise interfering with each other's movement.

This manual covers the Enterprise Manager 1100 system, which consists of applications from the Mobile Software Suite running on an Enterprise Manager appliance.

1.1 Product Description

The Enterprise Manager 1100 system is a hardware and software solution that helps you to manage a fleet of AIVs. The Enterprise Manager appliance can communicate with the AIVs in the fleet and perform a variety of fleet-oriented tasks.

The Enterprise Manager 1100 system consists of the Mobile Robot Software Suite running on an Enterprise Manager appliance. It allows you to manage map and configuration updates in a central location, which are then pushed out to each AIV in the fleet. It includes a queuing manager, which ensures that all of the requested tasks get performed by assigning them to appropriate AIVs.

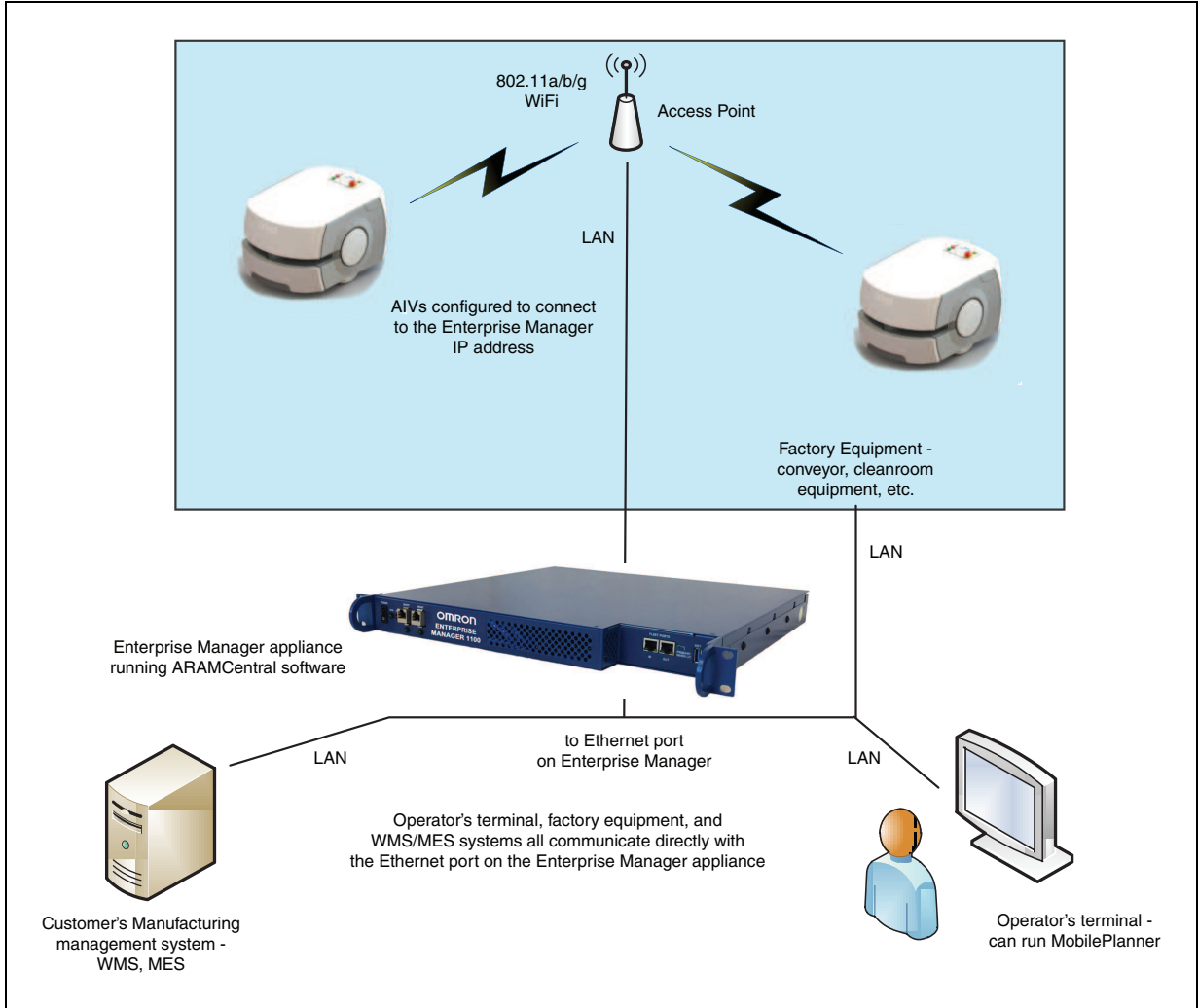

Figure 1-1. Main Components of an Enterprise Manager 1100 Installation



Figure 1-2. EM1100 Appliance

Features

The following is a list of the key features of the Enterprise Manager 1100. The Mobile Robot Software Suite, running on the Enterprise Manager appliance:

- Allows you to manage the configuration for a fleet of AIVs.

Each AIV gets its configuration data from the Enterprise Manager appliance, saving you time and making updates less error-prone.

- Helps optimize traffic flow by sharing each AIV's position and trajectory with other AIVs in its vicinity.

This allows each AIV to make path adjustments to avoid potential conflicts.

- Provides Queuing Manager functionality.

This receives job requests from call buttons and factory equipment management systems (WMS or MES), makes decisions about which AIV to dispatch a job to, and provides real-time job status updates to connected automation equipment.

- Saves wireless bandwidth.

Each AIV only exchanges information with the Enterprise Manager appliance, rather than communicating with every individual AIV. This leaves valuable WiFi space for other devices.

- Serves as a proxy for AIV data, such as location, battery state, and job status.

As a result, not only does this save wireless bandwidth, it also allows all of the AIVs in a fleet to connect to one central point, so an operator can monitor all the AIVs from a single application.

- Runs robustly without human intervention.

The Enterprise Manager 1100 is an appliance, not a server, therefore it does not need maintenance from IT staff. It can handle power outages without loss of data, it is solely dedicated to the task and won't be affected by other services, and, if something happens to the appliance, it can be replaced and the new one will operate identically, once the configuration is re-created on the new appliance.

A Secondary appliance is available as an option, running as a backup. See Auto-Synchronized Secondary Appliance on page 55.

1.2 Hardware that Comes with Enterprise Manager 1100 Systems

Appliance

The Enterprise Manager 1100 is an appliance with a processor capable of running the Mobile Robot Software Suite, and the connectivity for communicating with a fleet of AIVs.

For day-to-day operation, this only involves the use of the appliance's MGMT and FLEET IN Ethernet ports.

The Enterprise Manager appliance includes:

- Intel® Xeon® CPU
- 4 GB DDR3 RAM

- Solid state storage
- All of the connectors listed in the table Connectors and Indicators on page 21
- Rack-mount brackets
- Rack-mount rails for two- or four-post rack
- Enterprise Manager license

Options

- Secondary Enterprise Manager appliance, to back up Primary appliance
This can be auto-synchronized with the Primary, enabling a quick switch-over in case of a failure of the Primary appliance.

What Doesn't Come with an Enterprise Manager 1100?

- A UPS is highly recommended. Contact your local Omron sales support for more information.
- Mobile robots

NOTE: Keyboard, mouse, and monitor are not required, as all operation and management is done through the network interfaces.

1.3 Software that Comes with Enterprise Manager 1100 Systems

The software includes:

Mobile Robot Software Suite

The Mobile Robot Software Suite includes all of the software used for our platforms and the Enterprise Manager appliance, with the exception of the SetNetGo OS.

ARAM

The Advanced Robotics Automation Management software (ARAM) runs on the LD Platform core. It operates ranging sensors like the safety scanning laser and sonar, and performs all the high-level, autonomous robotics functions, including obstacle avoidance, path planning, localization, navigation, and so on, culminating in motion commands to the MARC firmware. ARAM also controls the battery and light discs, and manages digital and analog I/O, which, along with the LD Platform battery power, provide for integration of application-specific sensors and effectors (user-supplied).

ARAM manages wired and wireless Ethernet communications with offboard software, for external monitoring, development, and systems coordination, including coordination of a fleet of AIVs through the optional Enterprise Manager 1100 system. It also manages integration with other systems, as well as external monitoring, setup, and control with the MobilePlanner application.

ARAMCentral

ARAMCentral is the software that runs on the Enterprise Manager appliance. This software and the appliance combined are referred to as the Enterprise Manager 1100.

For a fleet, the ARAMCentral software manages:

- the map that all AIVs use
- the configuration that all AIVs use
- traffic control of the AIVs

This includes multi-AIV avoidance, destination, standby, and dock control.

- queuing of jobs for the AIVs
- remote I/O, if you are using it

MobilePlanner (licensed)

In order to have your AIV perform autonomous mobile activities, you need to make a map of its operating space, and configure its operating parameters. The MobilePlanner software is used to make this map and perform this configuration.

Refer to the separate *Mobile Robot Software Suite User's Guide* for details on how to map a working space and prepare the virtual elements, goals, routes, and tasks for your application. In particular, refer to:

Working With Map Files > Editing a Map File > Using the Drawing Tools > Adding Goals and Docks

The MobilePlanner software requires a license to run. You will need at least one license for MobilePlanner for each fleet of AIVs. Once you generate a map for an area, it can be shared between multiple AIVs in one fleet.

MobilePlanner, Operator Mode

The MobilePlanner Operator Mode is used to monitor one or more AIV's activities and have them perform mobile tasks in the mapped space. When MobilePlanner is started without its license dongle, it defaults to this mode. Refer to the separate *Mobile Robot Software Suite User's Guide* for details.

Mobile Adept Robot Controller (MARC)

At the lowest level, a microcontroller running MARC firmware handles the details of platform mobility, including maintaining the platform's drive speed and heading, as well as acquiring sensor readings, such as from the encoders and gyroscope, and managing the platform's emergency stop systems, bumper, and joystick. The MARC firmware computes and reports the platform's odometry (X, Y, and heading) and a variety of other low-level operating conditions to ARAM.

Touchscreen Support

Whenever the Mobile Software suite is downloaded, it includes support software for the touchscreen (usually an option).

Call/Door Box Support

Call/Door Boxes have one software component on the boxes and another on either the Enterprise Manager 1100 or on the single AIV, when there is no Enterprise Manager 1100.

ARCL Protocol

ARCL is a function of ARAM and ARAMCentral, which is included as part of this suite.

The Advanced Robotics Command Language, or ARCL, is a simple text-based command and response server for integrating an AIV (or fleet of AIVs) with an external automation system.

ARCL allows you to operate and monitor the AIV, its accessories, and its payload devices over the network, with or without MobilePlanner.

SetNetGo

The SetNetGo OS runs on each LD Platform core and Enterprise Manager appliance. It is the host OS in which ARAM and ARAMCentral run.

The SetNetGo interface in the MobilePlanner software is used for configuring the Ethernet settings for the platform, upgrading software, and performing systems diagnostics, such as retrieving log files. It can be accessed when connected via the maintenance and management Ethernet ports, or via wireless Ethernet if enabled.

NOTE: It is possible to connect directly to the SetNetGo OS on an LD Platform through a web browser. The main intent of this is to allow your IT support to set up the network for you, without using MobilePlanner, which requires a license for anything other than Operator Mode.

1.4 How Can I Get Help?

For details on getting assistance with your software or hardware, you can access the following information sources on the corporate websites:

Refer to:

<http://www.ia.omron.com>

and

<http://www.adept.com>

Related Manuals

This manual covers the installation and startup of an Enterprise Manager appliance with the Mobile Robot Software Suite. There are additional manuals that cover programming the system, reconfiguring installed components, and adding other optional or related components. The following manuals provide information on safety, related products, advanced configurations and system specifications.

Table 1-1. Related Manuals

Manual Title	Description
<i>Mobile Robot LD Safety Guide</i>	Describes safety aspect for LD Platforms.
<i>Advanced Robotics Command Language Reference Guide</i>	Describes the Advanced Robotics Command Language (ARCL), which is a simple, text-based server from which you can control our AIVs.
<i>Mobile Robot Software Suite User's Guide</i>	Describes the software for LD Platforms and the Enterprise Manager 1100.
<i>LD Platform OEM User's Guide</i>	Describes the operation and maintenance of the LD Platform OEM.
<i>LD Platform Cart Transporter User's Guide</i>	Describes the operation and maintenance of the LD Platform Cart Transporter.
<i>LD Platform Peripherals User's Guide</i>	Describes various peripherals available for use with LD Platform-based AIVs.

Support

If, after reading this manual, you are having problems with your Enterprise Manager appliance, contact your local Omron sales support.

Tell us when and how we can best contact you. We will assume e-mail is the best format, unless otherwise notified. We will try to resolve the problem through communication. If the Enterprise Manager appliance must be returned to the factory for repair, obtain a Return Materials Authorization (RMA) and shipping details from us first.

Chapter 2: Safety

2.1 Dangers, Warnings, Cautions, and Precautions

There are six levels of special alert notation used in our manuals. In descending order of importance, they are:



DANGER: This indicates an imminently hazardous electrical situation which, if not avoided, will result in death or serious injury.



DANGER: This indicates an imminently hazardous situation which, if not avoided, will result in death or serious injury.



WARNING: This indicates a potentially hazardous electrical situation which, if not avoided, could result in serious injury or major damage to the equipment.



WARNING: This indicates a potentially hazardous situation which, if not avoided, could result in serious injury or major damage to the equipment.



CAUTION: This indicates a situation which, if not avoided, could result in minor injury or damage to the equipment.



Precautions for Safe Use: This indicates precautions on what to do and what not to do to ensure safe use of the product.

2.2 Safety Precautions for Mobile Robots

Read the installation and operation instructions, as well as the *Mobile Robot LD Safety Guide*, before using the equipment.

General Hazards



CAUTION: The following situations could result in minor injury or damage to the equipment.

- Do not ride on the platform.
- Do not exceed the maximum weight limit.
- Do not exceed the maximum recommended speed, acceleration, deceleration, or rotation limits.
- Do not drop the AIV, run it off a ledge, or otherwise operate it in an irresponsible manner.
- Do not allow the AIV to drive through an opening that has an automatic gate/door unless the door and AIV are configured correctly with the Call/Door Box option.
Refer to the *LD Platform Peripherals User's Guide* for details on the Call/Door Box.
- Do not get the platform wet. Do not expose the platform to rain or moisture.
- Do not continue to run the platform after hair, yarn, string, or any other items have become wound around the platform's axles or wheels.
- Do not use unauthorized parts.

Electrical Hazards



WARNING: The docking station has AC power inside. Its covers are not interlocked.

- Do not use power extension cords with the docking station unless properly rated.
- Never access the interior of the AIV with the charger attached. Immediately disconnect the battery after opening the battery compartment door.
- Do not use any charger not supplied by Omron Adept Technologies, Inc.

Pinch Hazard

Platform Covers



CAUTION: Pinch hazard. The covers are held in place with strong magnets, which can pinch you if you are not careful. Follow the instructions in the Maintenance chapter for handling covers.

Magnetic Field Hazards

Platform Covers



WARNING: Magnetic fields can be hazardous to medical implant wearers. Medical implant wearers stay back 30 cm (12 inches) from the platform covers, which are held in place with strong magnets.

Docking Funnel



WARNING: Magnetic fields can be hazardous to medical implant wearers. Medical implant wearers stay back 30 cm (12 inches) from the underside of the platform, which is exposed during certain maintenance procedures for which the platform is tipped on its side.

2.3 Mobile Robot Battery Safety

- Batteries must be stored upright at 5 to 60°C (41 to 140°F).
- Do not expose batteries to water.
- If a battery is found to be leaking, do not expose it to water. If possible, submerge it in mineral oil and contact your local Omron sales support
- In case of a fire, use a type D extinguisher: foam, dry chemical, or CO₂.

2.4 What to Do in an Emergency / Abnormal Situation

Press the E-Stop button (a red push-button on a yellow background) and then follow the internal procedures of your company or organization for an emergency situation. If a fire occurs, use a type D extinguisher: foam, dry chemical, or CO₂.

In case of an emergency or abnormal situation, the AIV can be manually moved. However, only qualified personnel who have read and understood this manual and the *Mobile Robot LD Safety Guide* should manually move the platform. The brakes on the drive wheels can be released with the brake release button. This requires battery power, and an E-Stop must be pressed on the AIV.

NOTE: The LD Platform Cart Transporter LD-130CT is difficult to move manually, even with the use of the brake release.

2.5 Additional Safety Information

We provide other sources for more safety information:

Mobile Robot LD Safety Guide

The *Mobile Robot LD Safety Guide* provides detailed information on safety for Omron Adept Technologies, Inc. LD Platform-based AIVs. It also gives resources for information on relevant standards. It ships with each LD Platform.

2.6 Manufacturer's Declarations Guide

This lists all standards with which the platform complies. The Manufacturer's Declarations are in the Mobile Robots, Manufacturer's Declarations Guide. This guide ships with each LD Platform.

Chapter 3: Installation

This chapter covers the installation of the Enterprise Manager appliance.

3.1 Site Preparation

The primary concern in preparing for the installation of an Enterprise Manager 1100 for running the Mobile Robot Software Suite is the appropriate setup of communication, which will be needed between the Enterprise Manager 1100 and:

- AIVs
- Operator Terminal(s)
- Factory equipment management systems (WMS or MES)

Access must be allowed for all of these to initiate a connection with the Enterprise Manager 1100 system.

Static IP addresses are needed for the Enterprise Manager appliance and each AIV.

3.2 Transport and Storage

The Enterprise Manager appliance must be shipped and stored in a temperature-controlled environment, within the range -40 to 60°C (-40 to 140°F). The recommended humidity range is 5 to 95%.

The appliance must always be stored and shipped in a clean, dry area that is free from condensation.

It should be shipped and stored in the factory-supplied packaging, which is designed to prevent damage from normal shock and vibration. You should protect the package from excessive shock and vibration. For environmental specifications, refer to Technical Specifications on page 57.

The Enterprise Manager appliance weighs 6.8 kg (15 lbs).

3.3 Before Unpacking

Carefully inspect all packaging for evidence of damage during transit. If any damage is indicated, request that the carrier's agent be present at the time the package is opened.

Compare the actual items received (not just the packing slip) with your equipment purchase order, and verify that all items are present and that the shipment is correct. Inspect each item for external damage as it is unpacked. Contact your local Omron sales support immediately if any damage is evident. See Introduction on page 7.

Retain all containers and packaging materials. These items may be needed in the future to settle a damage claim.

3.4 Mounting the Appliance

The Enterprise Manager appliance is not intended for use in hazardous environments (explosive gas, water, dust, oil mist). It has an IP rating of IP20 (NEMA Type 1).

The Enterprise Manager appliance must operate in a temperature-controlled environment, within the range 10 to 35°C (50 to 95°F). The recommended humidity range is 8 to 90%.

The appliance is a 1U rackmount designed to be rack-mounted in a standard 19-inch equipment rack. Refer to the following figure.

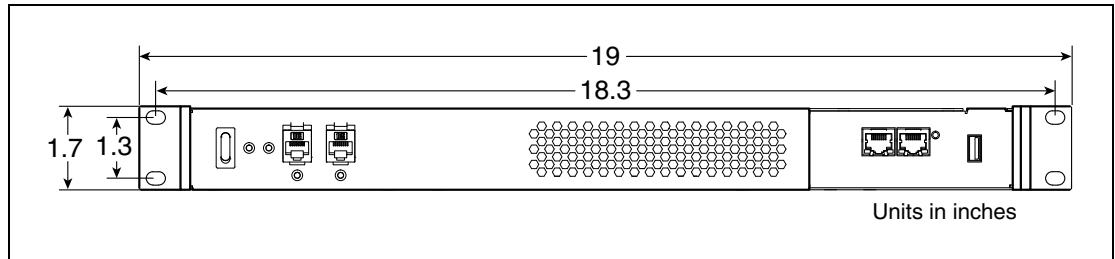

Figure 3-1. Mounting the Enterprise Manager 1100 Appliance

3.5 Connecting Power

1. Connect the AC plug on the rear of the appliance to AC power.

The appliance takes 100 – 240 VAC, 50/60 Hz.

2. Set the rear power switch to ON (1).

Installing a Secondary Appliance

If you are installing a Secondary appliance as a backup for the Primary, it needs to be installed with the same steps as the Primary. It can be installed in the same rack as the Primary appliance, but should be on a different UPS than the Primary.

Chapter 4: Connectors and Indicators

The Enterprise Manager appliance, shown in the following figure, has a variety of Ethernet connections. This section describes its connectors and indicators.

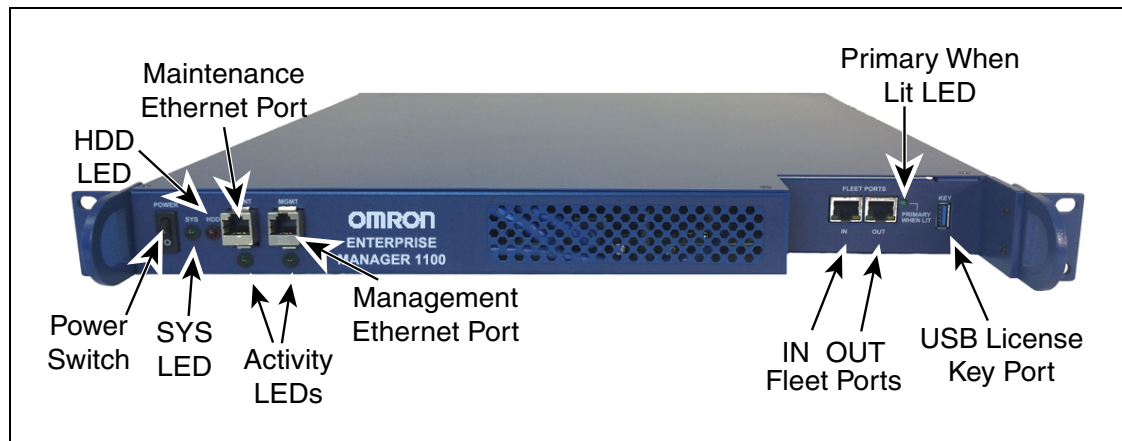

Figure 4-1. Enterprise Manager 1100 Appliance Connectors

NOTE: In a typical installation, while running the Mobile Robot Software Suite, the appliance will have only the AC power, the Management Ethernet connector, and the FLEET PORTS - IN Ethernet connector attached.

The MAINT port is only used during setup.

4.1 Front Controls and Indicators

Power Switch

The power switch enables or disables power.

SYS LED

When on, the appliance has power.

HDD LED

On when the disk is being accessed.

MAINT Ethernet Port

The Maintenance port is used for initial setup, troubleshooting, and an emergency backdoor in case the password or IP address is lost. Its address is fixed at 1.2.3.4, and there is no password on it.

MAINT LED (not labeled)

Indicates activity on the MAINT port.

- On = link, no activity
- Flashing = link, activity
- Off = no link

MGMT Ethernet Port

The Management port will only be used for accessing SetNetGo on the network. It has a user-definable IP address, but will not allow MobilePlanner or AIV connections. If you have a Primary and Secondary appliance, you would access SetNetGo on each via the Management port.

MGMT LED (not labeled)

Indicates activity on the Management port.

- On = link, no activity
- Flashing = link, activity
- Off = no link

FLEET PORTS

Both Fleet Ports have built-in Link and Activity LEDs.

IN

This is a general-purpose LAN connection. It will be used by your AIVs as well as the MobilePlanner software for connecting to the appliance.

OUT

This Ethernet port is only used if you have a Secondary appliance that is synced to the Primary appliance. The Secondary OUT connects to the Primary IN.

PRIMARY WHEN LIT LED

This will be lit for the Primary appliance, and off for the Secondary appliance.

KEY Port

The license dongle plugs into this port, and must remain plugged in.

4.2 Rear Controls and Indicators

AC Power In

This is where AC power needs to be connected.

AC Power Switch

This is an on/off switch for AC power. Under normal circumstances, this will remain ON, and control of the appliance's power status will be managed with the power switch on the front of the appliance.

Factory Field Service Ports

The following ports are intended for use by our field service, not by the end user.

- VGA Port
- USB Ports (x4)

4.3 Connecting to a Network

To attach your appliance to a network, or broadband device, connect Ethernet cables between the device and the FLEET PORTS - IN and Management Ethernet ports on the Enterprise Manager appliance. Do not use the MAINT Ethernet port.



CAUTION: Do not connect the Enterprise Manager appliance directly to the Internet. If the Enterprise Manager appliance is on a LAN that has Internet access, make sure there is a firewall between the LAN and the Internet in order to prevent unwanted and unauthorized network traffic from reaching the Enterprise Manager appliance.

We recommend that you use Category 5e or better wiring and connectors for your network.

NOTE: Ethernet configuration for the Enterprise Manager appliance is covered in Configuration on page 27.

Network Ports and Protocols

Enterprise Manager 1100 Appliance

Protocol	Port(s)	Initiator -> Recipient
Intra-fleet Communications Used for Enterprise Manager to broadcast configuration updates to AIVs, to dispatch job commands, and to share position and trajectory updates throughout the fleet.		
TCP	37	Robot -> EM
TCP/UDP	5000	Robot -> EM
UDP	Range 10000 and up	Robot -> EM This will use as many ports as there are AIVs. Each AIV that connects will use the next available port >= 10000. For best results, allow a large number of ports such as 10000-10999.
TCP/UDP	7272	EM -> Robot

Protocol	Port(s)	Initiator -> Recipient
Configuration and Monitoring of Fleet		
Used for MobilePlanner connections to the EM1100 and AIVs for purposes of monitoring and configuration.		
TCP	443	PC -> Robot
TCP	443	PC -> EM
TCP/UDP	Range 7272 and up	PC -> EM This will use as many ports as there are AIVs. Each AIV that connects will use the next available port >= 7272. For best results, allow a large number of ports, such as 7272-7999.
TCP/UDP	7272	PC -> Robot
UDP	Range 10000 and up	EM -> PC This will use as many ports as there are AIVs. Each AIV that connects will use the next available port >= 10000. For best results, allow a large number of ports such as 10000-10999.
UDP	10000	Robot -> PC
Job Monitoring and Submission (ARCL Interface)		
Used for managing jobs on the Enterprise Manager 1100. These are typically submitted from a Warehouse Management System (WMS) or Manufacturing Execution System (MES).		
TCP	7171	WMS/MES -> EM ARCL Server: if enabled in the configuration (Robot Interface > ARCL Server Setup), then this port will be open on the Enterprise Manager and will accept unlimited incoming connections. The port number is configurable. (This port may also be available on the AIV, depending on the application.)
TCP	Configurable port #	EM -> WMS/MES Outgoing ARCL Connection: if enabled in the configuration (Robot Interface > Outgoing ARCL connection setup), then the Enterprise Manager will initiate an outgoing connection to the specified hostname and TCP port number.
Optional		
TCP	123	EM -> NTP server If the Network Time Protocol (NTP) client is enabled on the EM (SetNetGo > System > Date/Time), then the EM will attempt to connect to the configured IP address to synchronize its clock. (This function is available on the AIV if not using an EM)
UDP/TCP	Range 1000-65535	Offboard devices -> Robot If RS232 or Ethernet Port Forwarding is enabled on the AIV (SetNetGo -> Network) then the configured TCP ports will be open on the AIV for incoming connections.

Single-AIV Ports

Protocol	Port(s)	Initiator -> Recipient
Configuration and Monitoring of Robot Used for MobilePlanner connections to the AIV for purposes of monitoring and configuration.		
TCP	443	PC -> Robot
TCP/UDP	7272	PC -> Robot
UDP	10000	Robot -> PC
Job Monitoring and Submission (ARCL Interface) Used for managing jobs on the Enterprise Manager. These are typically submitted from call buttons or other automation equipment		
TCP	7171	Off-board Devices -> Robot ARCL Server: if enabled in the configuration (Robot Interface > ARCL Server Setup), then this port will be open on the AIV and will accept unlimited incoming connections. The port number is configurable.
TCP	Configurable port #	Robot -> Off-board Devices Outgoing ARCL connection: if enabled in the configuration (Robot Interface > Outgoing ARCL connection setup), then the AIV will initiate an outgoing connection to the specified hostname and TCP port number.
Optional		
TCP	123	Robot -> NTP server If the Network Time Protocol (NTP) client is enabled on the AIV (SetNetGo > System > Date/Time), then the AIV will attempt to connect to the configured IP address to synchronize its clock.
UDP/TCP	Range 1000-65535	Offboard devices -> Robot If RS232 or Ethernet Port Forwarding is enabled on the AIV (SetNetGo > Network) then the configured TCP ports will be open on the AIV for incoming connections.

Chapter 5: Configuration

This chapter covers the data connections and configuration of the Enterprise Manager appliance. When you are using an Enterprise Manager appliance, any configuration changes that you make will be stored on that appliance, rather than on an AIV.

5.1 Overview

Ethernet Connection

A wired Ethernet connection between the Enterprise Manager appliance and your network is required.

The Enterprise Manager appliance has four built-in Ethernet ports:

- a Maintenance port (MAINT)

The Maintenance port is always enabled and permanently set to the IP address 1.2.3.4.

Use the MAINT port to initially connect to and configure the unit. After you configure the Enterprise Manager appliance, use the Management and FLEET PORTS - IN Ethernet ports to connect the unit to your network.

- a SetNetGo Ethernet port, MGMT, used to access the SetNetGo interface

This Ethernet port will not be accessible by the AIVs.

- a port for AIV and MobilePlanner connections, FLEET PORTS - IN

This port is used to connect the appliance to your LAN. The IP address is user-definable. This is the port that your AIVs will connect to, as well as the MobilePlanner client.

For a Primary appliance, this will be connected to the FLEET PORTS - OUT of the Secondary appliance.

- an Ethernet port for syncing from a Secondary appliance, FLEET PORTS - OUT

This port is only used if you are using Autosync with a Secondary appliance. This will plug into FLEET PORTS - IN on the Primary appliance. The Primary's OUT is not used.

NOTE: Contact your System Administrator for assistance configuring the Enterprise Manager appliance for your network.

Configuration Tasks

To connect to and configure the Enterprise Manager appliance, perform the following tasks:

- Set the IP address on your PC.
- Connect your PC to the Enterprise Manager appliance.
- Run the MobilePlanner software, and access the SetNetGo interface.
- Configure the network settings for the appliance Management Ethernet port.

- Configure the network settings for the FLEET PORTS - IN Ethernet port.
- Define login information.
- Connect the appliance to your network.
- Configure each AIV to connect to the Enterprise Manager 1100.
- Customize each AIV, if desired.

If a Secondary appliance is installed:

- Install the same SetNetGo and ARAMCentral software version on the Secondary as is on the Primary appliance.
- Configure a unique IP address for the Management port.
- Connect the Management port to the LAN.
- Connect the FLEET PORTS - IN port to the LAN.
- Enter the Secondary Management IP address on the Primary appliance, under **Software > Autosync > Secondary IP**.
- Generate and download a key from the Primary appliance.
- Set the Secondary appliance Autosync role to Secondary.
- Upload the key to the Secondary appliance.
The Secondary appliance only needs the Primary appliance key.
- Verify that the status of both appliances is active.
- Connect a network cable directly from the Secondary appliance's FLEET PORTS - OUT port to the Primary's FLEET PORTS - IN port.

A direct network connection is needed between the Primary and Secondary appliances, so they should be installed close to each other. We recommend that they be plugged into separate power sources.

These tasks are described in the sections that follow.

5.2 Setting the IP Address on Your PC

Configure a PC with the following network settings:

- IP address = 1.2.3.x

where x is any number 1 through 254, except 4. See the *Mobile Robot Software Suite User's Guide* for more information.

- Netmask = 255.255.255.0

No special DNS or gateway settings are needed.

5.3 Connecting Your PC to the Enterprise Manager 1100 Appliance

Connect a Category 5e or better Ethernet cable to an Ethernet plug (RJ-45) on the PC and the Maintenance Ethernet plug on the Enterprise Manager appliance (MAINT ETH).

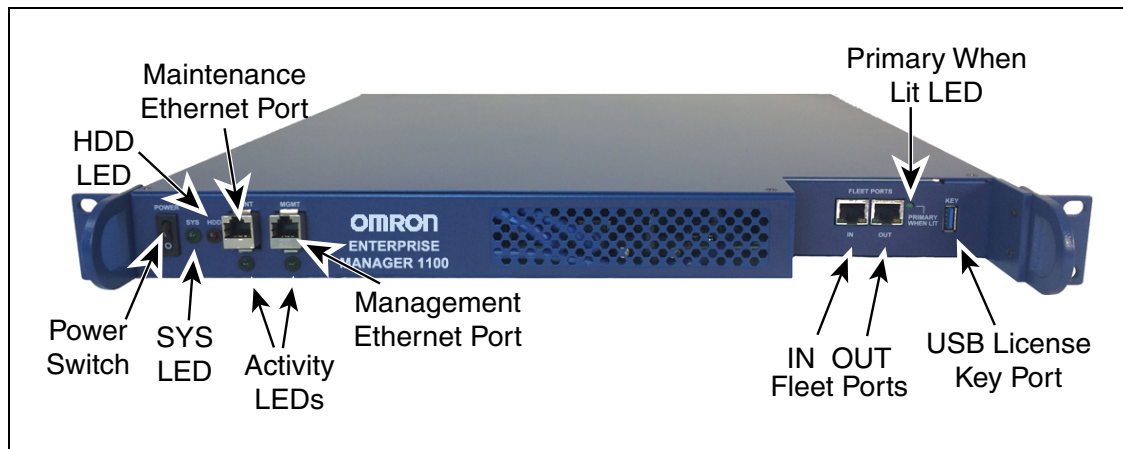

Figure 5-1. Front Connectors and Indicators

NOTE: If you are ever unable to connect to the Enterprise Manager appliance using the Management Ethernet port (due to a lost password or IP address conflict), you can directly connect to the Maintenance Ethernet port, which does not require a password and has a fixed IP address of 1.2.3.4.

5.4 Connecting to SetNetGo

SetNetGo lets you manage a variety of settings, both on the Enterprise Manager appliance and on the AIVs. It can also read an AIV's operation log. SetNetGo is normally accessed through the MobilePlanner software.

NOTE: The user interface for SetNetGo on an Enterprise Manager appliance will have some different parameters available than SetNetGo on an AIV.

NOTE: The upper-left of the screen will display SETNETGO - ENTERPRISE MANAGER or SETNETGO - AIV, to tell you what your SetNetGo context is.

To access SetNetGo:

1. Start the MobilePlanner software on your PC.
2. Click anywhere in the SetNetGo selection box, to access the SetNetGo interface.

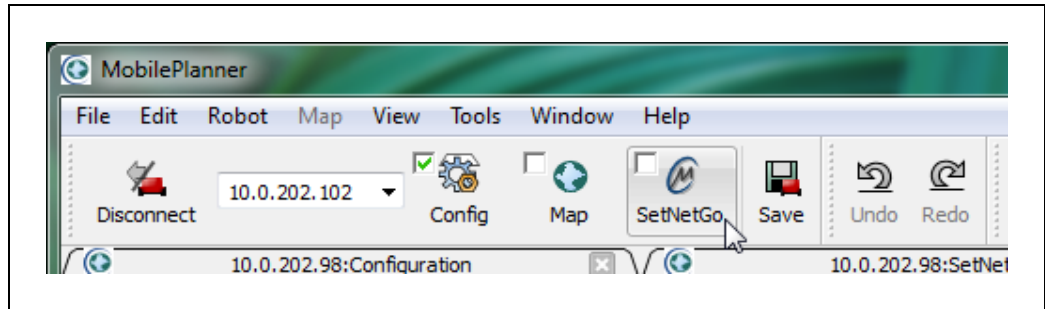

Figure 5-2. SetNetGo Selection Box, Being Hovered Over

Hovering over the selection box will reveal its boundaries. Note the cursor in the preceding figure.

NOTE: You do not need to click the checkbox within the SetNetGo selection box to activate the SetNetGo interface. The checkbox determines whether SetNetGo will automatically be activated when the MobilePlanner software starts.

The SetNetGo interface will be displayed.

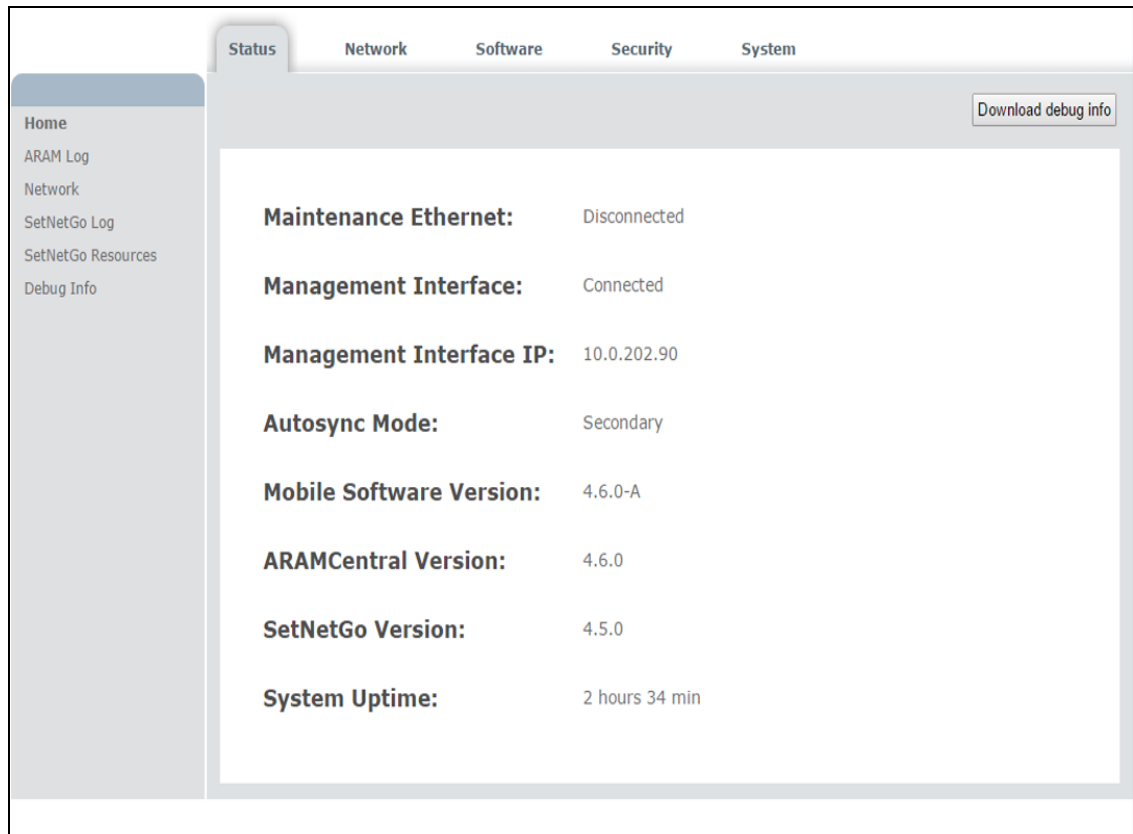

Figure 5-3. SetNetGo Interface, Status Screen

This screen provides a quick overview of link status, IP addresses, and software versions.

5.5 Configuring Network Settings for the Management Interface

To set the network settings for the LAN Ethernet port, from the SetNetGo interface:

1. Select **Network > User LAN Ethernet**.

The Onboard Ethernet Settings screen is displayed:

NOTE: This port is referred to as the Management IP on the Enterprise Manager 1100, and LAN Ethernet on an AIV.

2. Enter a valid, available IP address for the Enterprise Manager 1100 in the IP Address field.

Do not use the IP address 1.2.3.4, because this would create a conflict with the IP address permanently set for the Maintenance Ethernet port.
3. Enter the appropriate subnet mask for a host on your network in the Netmask field.
4. Enter the IP address of the default Gateway. (This is the IP address of the device used to connect to your network, typically a router.)
5. Enter the IP address of your Domain Name Server (DNS), if applicable.

Leave 0.0.0.0 otherwise.
6. Click Apply. (Clicking Reset will restore the original values.)

5.6 Setting SetNetGo and ARAMCentral Security

SetNetGo Password

To set a password for SetNetGo:

1. Select **Security > SetNetGo Password**.
2. Enter the desired password in the New password field.
3. Re-enter the password in the Confirm Password field.
4. Click Apply.

(Clicking Reset will restore the original value.)

ARAMCentral Account Passwords

This is used to manage user account passwords for access to an AIV through the MobilePlanner software.

To change or set an account password:

1. Enter a new password in the first Password field for the account.
2. Enter the same password in the second Password field for that account.
3. Click Apply. (Clicking Reset will restore the original values.)

5.7 Synchronizing Time

The Enterprise Manager appliance clock may synchronize with an external device (Network Time Protocol, or NTP).

With NTP, the Enterprise Manager appliance is a client of the NTP device, and will be synchronized with its clock.

The AIVs are clients of the Enterprise Manager appliance, and will be synchronized with its clock. If you explicitly enable NTP on an AIV, then the AIV's clock will no longer synchronize directly with the Enterprise Manager appliance.

To use NTP, enable the NTP client button, and enter the IP address of the NTP server.

The screenshot displays the 'Date / Time Settings' interface. At the top, there are tabs for 'Status', 'Network', 'Software', 'Security', and 'System', with 'System' being the active tab. On the left, a sidebar contains 'Date/Time', 'Upload SetNetGo OS', and 'Reboot'. The main content area is titled 'Date / Time Settings' and includes a 'Reset' button. Under the heading 'Timezone & Synchronization Settings', the 'NTP client' is set to 'Disabled' (radio button selected). The 'NTP server Address' is entered as '192.168.10.1'. The 'Timezone' is set to 'US/Eastern' with an 'Apply' button next to it. Below this, the 'Set system clock' section shows the current 'Time' as '15:15:35' and the 'Date' as '04/09/2015', with a 'Set time/date' button.

Figure 5-4. Date and Time Settings

To use the Enterprise Manager appliance to synchronize the AIV clocks, use the following procedure.

On the Enterprise Manager 1100:

1. Select **System > Date/Time**.
2. If using NTP:
 - a. Enable the NTP client field.
 - b. Enter the IP address of a server that can provide the Network Time Protocol (NTP) service in the NTP Server Address field.
3. Otherwise, leave the NTP client field Disabled.

On each AIV, from SetNetGo:

1. Select **System > Date/Time**.
2. Leave the NTP client field Disabled.

Each AIV will get its time from the Enterprise Manager appliance, regardless of how the appliance is getting its time.

3. Select the appropriate Timezone from the pull-down menu.
4. Click Apply.

(Clicking Reset will clear the form and restore the original values.)

5.8 Enabling the ARCL Server

In order to communicate with the Enterprise Manager 1100 from other network devices, such as WMS, MES, or call button applications, you must enable the text-based TCP port, ARCL.

1. From MobilePlanner, Config select:
Robot Interface > ARCL server setup
2. In the OpenTextServer field, use the drop-down box to select True, to enable the server.
The default port is 7171.
3. Enter a password in the Password field.
4. Click Save.

Refer to the following figure:

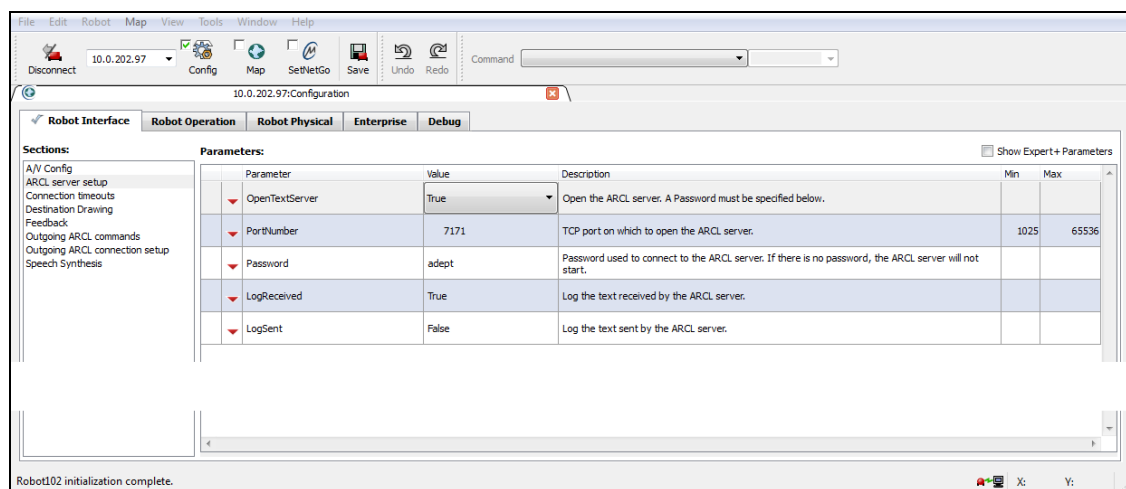

Figure 5-5. MobilePlanner, ARCL Server Setup Screen

5.9 Configuring a Secondary Appliance and Autosync

A Secondary Enterprise Manager appliance can be installed to back up the Primary appliance. The Secondary can be auto-synchronized with the Primary, enabling a quick switch-over in case of a failure of the Primary appliance.

This option supports two units – one Primary and one Secondary. The use of multiple backup appliances is not supported.

All Enterprise Manager appliances are configured as Primary, as a default. Using SetNetGo, you can reconfigure one to be Secondary, and set up the Primary to communicate with it.

- The Primary unit will be a fully-functional Enterprise Manager appliance, running the Mobile Robot Software Suite.
- The Secondary unit will be powered on, and the web interface will be accessible to the Primary unit. However, the Mobile Robot Software Suite will not be active on the Secondary unit, so it will not be accessible via MobilePlanner or by the AIVs.

The Primary unit will have two active IP addresses, the Secondary unit just one.

The following figure shows the physical connection of cables to the appliances:

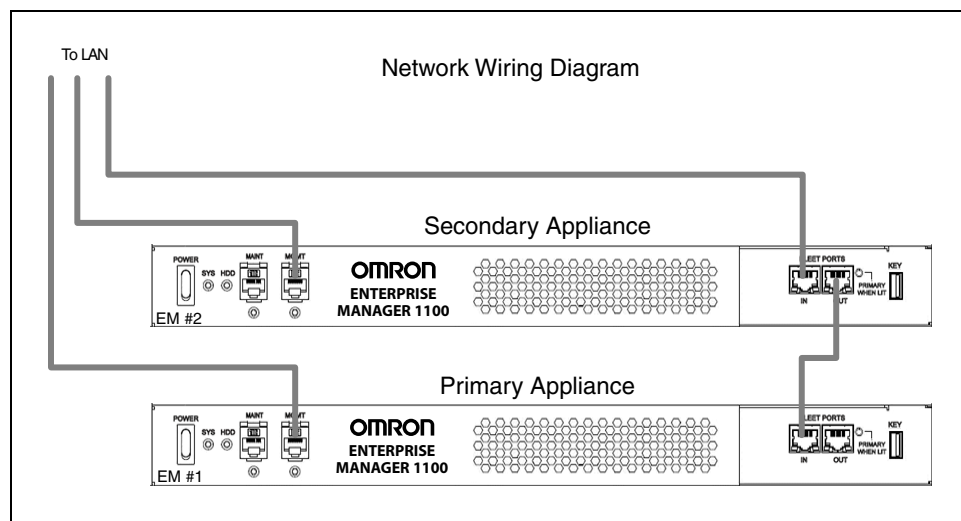

Figure 5-6. Sample Autosynchronized Network Connections

The following two figures show the communication paths, rather than physical cabling, for the appliance. The physical connections for these two figures is the same as in the previous figure.

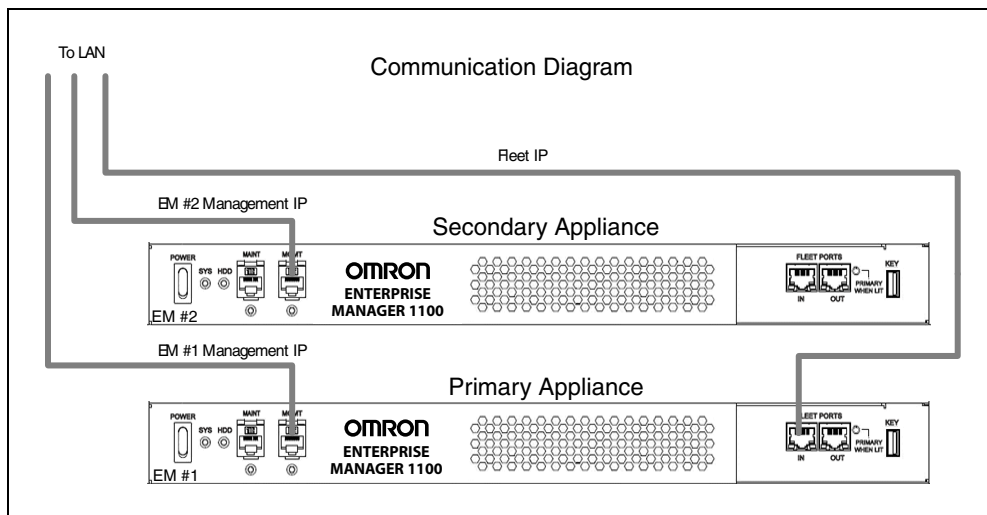

Figure 5-7. Sample Autosynchronized Application Communication

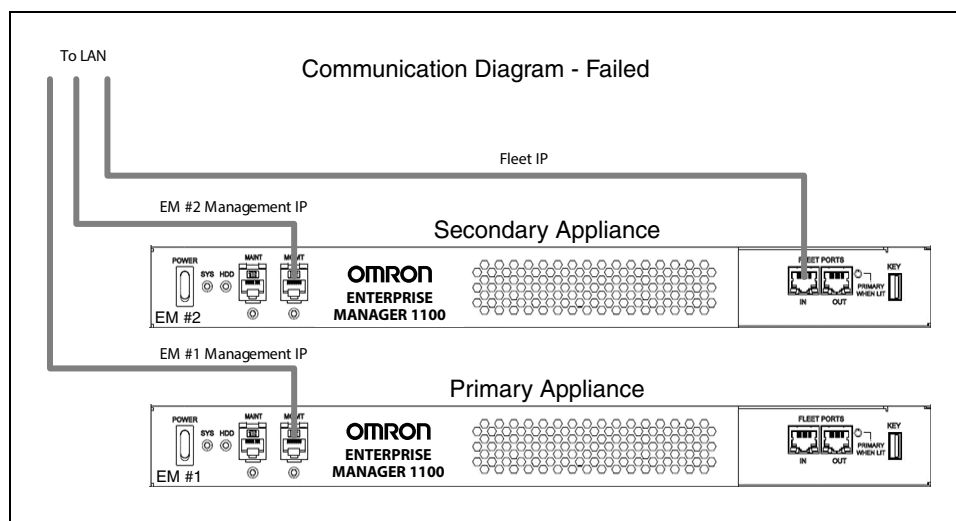

Figure 5-8. Sample Autosynchronized Application Communication, Primary Failed

Tasks in Autosync Setup

NOTE: This section assumes that you have set up the Maintenance Ethernet interface, and the Enterprise Manager appliances are installed and on the network.

- Configure the Primary appliance with an appropriate Fleet IP Address
- Enter the Secondary appliance IP Address in the Primary appliance
- Generate and Download the Primary key (to your PC)
- Set the Secondary appliance Autosync role to Secondary
- Upload the Primary key to the Secondary appliance

Installing a Secondary Appliance

Physical installation is covered in Installing a Secondary Appliance on page 20.

Configuring the Primary Appliance

1. From SetNetGo on the Primary appliance, select:

Network > Fleet Interface

The status of this interface is dependent on the Autosync role - if Primary, then this interface is enabled. If Secondary then this interface is disabled.

2. Enter the Fleet IP Address, Netmask, and Gateway.

NOTE: In all of the SetNetGo screens in this procedure, clicking Reset will clear the form and restore the original values.

If the Secondary EM is online, then you will need to generate and download the Primary key, and upload it to the Secondary.

3. Click Apply.
4. From SetNetGo on the Primary appliance, select:
Software > Autosync
5. Enter the Secondary appliance Management IP Address.

NOTE: You will not be able to generate and download the Primary key until you have clicked Apply, and the software has processed your request.

6. Click Apply.
7. Click Generate New Key, or Download Existing Key.

NOTE: If a key was previously generated, you can skip the Generate step, and click Download Existing Key.

The key for the Primary includes the Primary's IP address, which the Secondary needs for sharing information with it.

You will be prompted for a location for saving the key file. The key can be saved to your PC, so you can later upload it to the Secondary appliance.

8. Enter the path where you want the file saved.
9. You will be shown a warning, indicating that any connected AIVs and clients will be disconnected. Click Ok.

Configuring the Secondary Appliance

1. From SetNetGo on the Secondary appliance, select:
Software > Autosync
2. Select Secondary for the Autosync role field, using the drop-down arrow.

The default Autosync role is Primary.

3. Click Apply.

You will be shown a warning that AIVs will need to be reconfigured to point to the new IP address. Click Ok.

4. Click Choose File to select the Primary key from your PC.

Enter the name and path of the file to upload the key from the PC.

5. Click Upload.

NOTE: The Network > Fleet Interface settings will be saved for the Secondary appliance, though the interface will be disabled because it is the Secondary.

The Primary and Secondary should show a Current Status of active after they are connected.

Autosync Settings Status

- Disabled

The current appliance is Primary, but the Secondary IP Address is 0.0.0.0. Autosync is disabled without a valid Secondary appliance IP Address.

- Startup

Autosync is configured, but the two appliances have not yet communicated successfully

- Active

Primary and Secondary appliances are communicating

- Failed

Primary and Secondary appliances were communicating, but lost the connection

The Primary will automatically attempt to re-establish communication with the Secondary.







5.10 Configuring Each AIV to Connect to the Enterprise Manager 1100

Before you can use the Enterprise Manager appliance with your AIVs, you must configure each AIV to connect to the appliance. To do so, you must connect to each AIV.

NOTE: When an AIV connects to the appliance, the Mobile Robot Software Suite will overwrite the AIV's parameters.

MobilePlanner Icons

The first two columns in the MobilePlanner Parameters screen indicate whether ARAM will reboot if that parameter is changed, and what user-level the parameter is considered.

Column	Icon	Meaning	Expert+ Checkbox
First		ARAM will reboot if this parameter is changed	n/a
Second		Beginner level	No
		Intermediate level	No
		Advanced level	No
		Expert level	Yes
		Factory level	Yes
		Calibration level	Yes

- Beginner (green) covers simple things that will probably need to be changed for a given installation.
- Intermediate (yellow) are straightforward things that may need to be changed, but shouldn't have side effects (or else very obvious side effects that are explained).
- Advanced (red) are things that might change, but not often, and where any side effects are obvious and explained.

The following three parameter levels all require that the Expert+ checkbox be checked. We recommend that you NOT check the Expert+ checkbox unless specifically instructed to do so.

- Expert (grey circle) are likely to have side effects, which may be subtle.
- Factory (robot outline) are generally only set at the factory or by integrators.
- Calibration (Factory with a yellow shield in front) are specific to one AIV, and will likely only be set once.

NOTE: Entering an identifier into the Identifier field for each AIV in the next section is a Calibration-level parameter, and requires that the Expert+ checkbox be checked.

AIV-Level Settings

- From MobilePlanner, Config select:
Enterprise > Enterprise Manager Connection

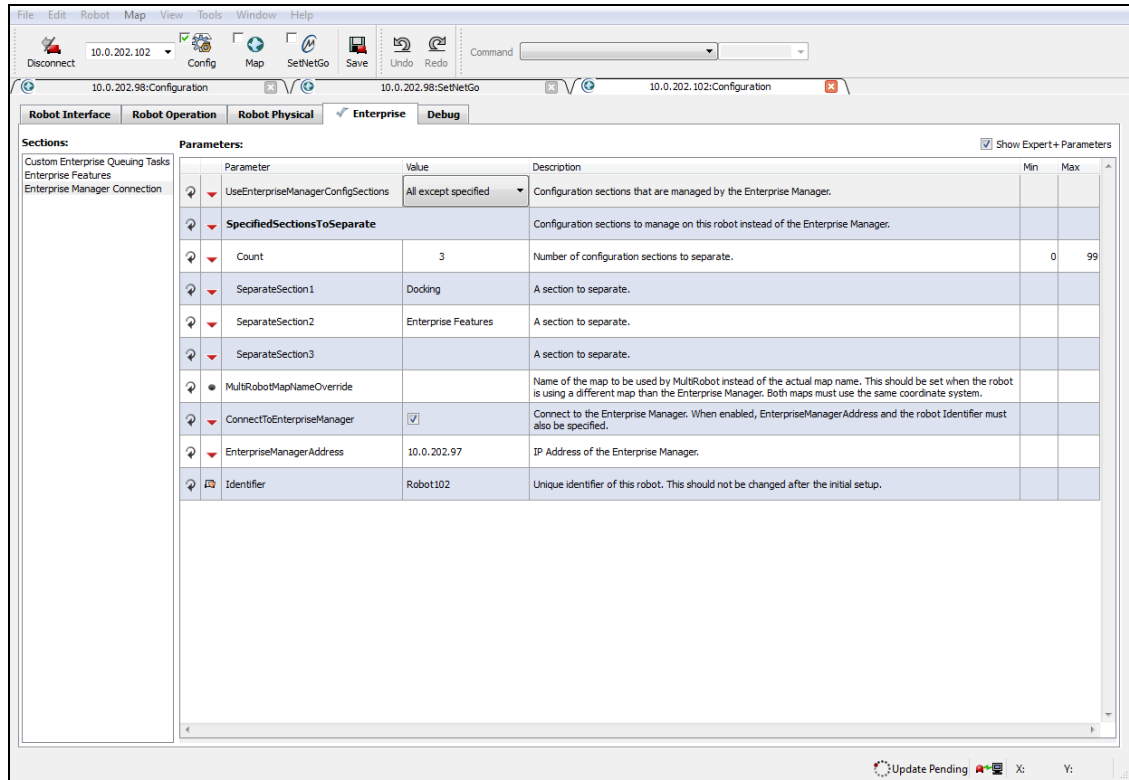

Figure 5-9. Enterprise Manager Connection Screen

- Check the ConnectToEnterpriseManager checkbox.
- Enter the IP address of the Enterprise Manager 1100 appliance, in the EnterpriseManagerAddress field.

NOTE: This is the Fleet IP address, not the Management IP address, of the Enterprise Manager appliance.

- Enter an identifier in the Identifier field.

This must be a unique identifier for this AIV. After initial setup, this should not be changed.

The Expert+ checkbox must be checked in order to see or change this parameter.

Repeat these steps for each AIV in your fleet that you want controlled by this Enterprise Manager appliance, using the same IP address and a different identifier for each.

Fleet-Level Settings

From MobilePlanner, Config, on the Enterprise Manager 1100:

1. Select **Enterprise > Enterprise Features**.

2. Check the EnterpriseManagerGatherScans box.

This lets the Mobile Robot Software Suite gather any scan files created by the AIVs.

3. It's also a good idea to check DeleteUnusedMaps.

This deletes unnecessary map files from each AIV.

NOTE: All unused map files will be deleted from the AIV if this is checked. Make sure that all necessary map files are backed up.

5.11 Customizing Each AIV

The mode for docking station assignment is set with the MobilePlanner, Config software on each AIV.

Docking Station Assignment

There are three modes that you can use for determining which docking station an AIV will use. All modes are set with:

Robot Operation > Docking

Default Mode

When an AIV needs to recharge, it will use the closest docking station that's available.

Available docking stations are those that aren't occupied and are not given up on. If that leaves no docking stations, then the oldest given-up-on becomes available.

1. Leave PreferredDock empty.
2. Set OnlyUsePreferredDock to False.

Mixed Mode

In this mode, the AIV will use its PreferredDock if that docking station is valid, isn't occupied, and hasn't been given up on. If that fails, the AIV will find another docking station.

1. Select PreferredDock, and enter the name of the docking station that is preferred for the AIV.
2. Set OnlyUsePreferredDock to False.

Separate Docking Stations

In this mode, each AIV is assigned its own docking station.

1. Select PreferredDock, and enter the name of the docking station that is preferred for the AIV.
2. Set OnlyUsePreferredDock to True.

Distinct Voices

By default, the AIV voice parameters are set at the Enterprise Manager level, and the voice will be the same for all of the AIVs.

If desired, each or some AIVs can have independently configured speech-synthesis settings. This gives you the ability to give every or some AIVs a distinctive voice.

To enable different voices for each AIV:

1. From MobilePlanner, Config select:
Enterprise > Enterprise Config Management
2. Under SectionsToSeparate, increment Count if there are no empty SeparateSectionX rows, where 'X' is a number, with an empty Value field.
3. Enter the string "Speech Synthesis" in an empty Value field.
4. Click Save.

The Speech Synthesis section of parameters will now be displayed on each AIV, and any voice that you set on an AIV will now be controlled by the AIV, rather than overwritten by the Mobile Robot Software Suite.

To enable different voices for only some AIVs, use the MobilePlanner software to connect to each of those specific AIVs and do the following:

1. In **Enterprise > Enterprise Manager Connection**, use the drop-down arrow to change the Value field of UseEnterpriseManagerConfigSections from "All" to "All except specified".
2. If there are no SeparateSectionX rows, where 'X' is a number, with an empty Value field, increment the Count parameter.

Count and SeparateSectionX parameters will not be displayed if the UseEnterpriseManagerConfigSections is set to All.

3. Add the string "Speech Synthesis" to an empty SeparateSectionX Value field.

5.12 Call Buttons

The Call button option can be used to call for an AIV from a remote location. When a call button is pressed, it sends a request to the Enterprise Manager 1100 system that says it needs an AIV to be sent to the call button's assigned goal. The Enterprise Manager 1100 will respond by selecting an available AIV, and assigning the call button's goal to that AIV.

Call buttons are covered in the *LD Platform Peripherals User's Guide*.

Chapter 6: Operation

This chapter describes how to operate the Enterprise Manager appliance. Before proceeding, you need to have performed the steps covered in the Installation and Configuration chapters.

6.1 Turning Power ON and OFF

Pressing the front Power switch initiates powering on the Enterprise Manager appliance. The Power LED will come on immediately. The boot sequence can take up to two minutes, though typically less.

Pressing the front Power switch, when the appliance is on, initiates the shutdown sequence for the Enterprise Manager appliance. It will beep three times. The Power LED will go out when the sequence is complete. The shutdown can take up to a minute, though typically less. After shutdown is complete, some lights inside the enclosure will remain on, even though the appliance is logically powered off.

Reaction to a Power Failure

The queue will be saved and automatically recovered in the event of power failure.

The Enterprise Manager appliance will automatically return to the power-state that it was in prior to a power failure. If the unit is already off when the power loss occurs, it will remain off even when power is restored. If the unit is on when the power fails, it will boot when power is restored.

This feature is enabled by default, but can be changed in the BIOS. In rare cases, this feature may get disabled by a CMOS battery failure.

6.2 Generating a Map for a Fleet

Creating and sharing a map for your fleet involves the use of the MobilePlanner software, running on a user-supplied PC. The software used is covered in the *Mobile Robot Software Suite User's Guide*.

The tasks involved are generally:

- Generate a map, using a single AIV.
- Upload the map to the Enterprise Manager appliance and make it the current map.

The map will automatically get downloaded to each AIV in your fleet.

The Enterprise Manager appliance communicates with each AIV individually, rather than doing a broadcast. In addition to maps, it can download configuration parameters to each AIV.

NOTE: If you are doing a trial with a single AIV, you should save the data and configuration to your PC, and then download from your PC to the Enterprise Manager appliance when you are confident it's what you want.

6.3 Managing Queuing

Queuing/Job Definitions

- Job - a single command issued to the Enterprise Manager, consisting of one or more related, ordered moves (job segments). Each job has a unique job ID.
- Job segment - one discreet move that will be assigned to a AIV. A segment consists of a single goal name, and can be defined as a PICKUP or a DROPOFF job segment. The goals may have tasks that are assigned to the AIV, which count as part of the job segment. Each job segment has a unique ID.
- Queue - a collection of jobs and job segments, stored on the Enterprise Manager 1100, that have been requested and have been or will be assigned to AIVs.
- Assigned Job - a job segment becomes assigned once the Enterprise Manager has actively allocated a AIV to perform the job. A job segment will transition from Pending to InProgress when this happens.
- Pickup - a job segment that ends at a goal so that a payload can be put onto the AIV. If the first segment of a job is a PICKUP, then this job can be assigned to whichever AIV the EM deems is most appropriate.
- Dropoff - a job segment that ends at a goal so that a payload can be removed from the AIV. A DROPOFF segment will only be handled by the required AIV.
- Required Robot - certain job segments can only be serviced by a specific AIV. For example, the DROPOFF segment of a PICKUP-DROPOFF job must be handled by the same AIV that performed the pickup. Thus, whichever AIV handles the initial PICKUP job will be referred to as the 'required robot' for the DROPOFF.

The Enterprise Manager 1100 includes the ability to queue jobs. It can accept multiple requests for AIVs, and then select the best AIV for each job, based on the criteria you specify. It sends the selected AIV to the requested location. It tracks the status of jobs and AIVs as they perform their assigned jobs.

The requests that are queued include:

- a request for any AIV to be sent for a pickup (PICKUP) for which the delivery destination (DROPOFF) is not yet known (queuePickup ARCL command).
It is assumed that the delivery destination will be communicated directly to the AIV that responds, prior to completion of the pickup.
- a request that a specific AIV drive to a particular goal (DROPOFF) (queueDropoff ARCL command).
This is communicated directly to the AIV, but is queued and tracked by the Enterprise Manager 1100.
- a request that an AIV be sent for a job that has predetermined pickup and dropoff destinations (queuePickupDropoff ARCL command).

In this case, no further job commands need to be given to the AIV in order to complete this job.

The Enterprise Manager 1100 manages jobs associated with either a PICKUP or a DROPOFF goal. Any AIV tasks that are associated with the goals will be executed at the proper times, though they are not managed as separate jobs in the queue.

It is recommended and assumed that the AIV task "pause" be used to pause the AIV at its destination, although this is not managed by the queue. The associated "pauseTaskCancel" task should be used to signal dismissal once the AIV has been loaded or unloaded. This can be triggered either by a manually-activated button, or by an automated system.

When the Enterprise Manager 1100 receives a request, it does the following:

1. Queuing

- The request is assigned a default priority (unless another priority is specified) and put into the queue.

Pickup/Dropoff requests are entered as two separate jobs - a pickup, and a dropoff.

Each segment has a unique queue ID, as well as a job ID that tracks the entire pickup/dropoff sequence.

- Queuing allows for canceling the job.

2. Dispatching

- An AIV is selected, based on the criteria you specified.
- The AIV is sent to the goal.

3. Tracking

- The queuing manager monitors the AIV and job status.
- The job is deleted from the queue when the request has been satisfied, or requeues the job in the event of failure.

Jobs can be in one of six states:

- Pending - new, unassigned jobs.
- In Progress - jobs that are being actively processed.
- Completed - jobs that were successfully processed.
- Failed - jobs that failed, due to reasons such as a blocked path or E-Stop.
- Canceled - jobs that were manually canceled with the queueCancel command
- Interrupted - jobs that have been interrupted by an Operator manually controlling the AIV. These will be reassigned after a brief wait.

Queuing Examples

The following flowcharts represent sample usage scenarios, and require some application-layer support to fully implement.

The following flowchart illustrates a simple pickup and delivery cycle. Other factors, such as state of charge, can alter this flow.

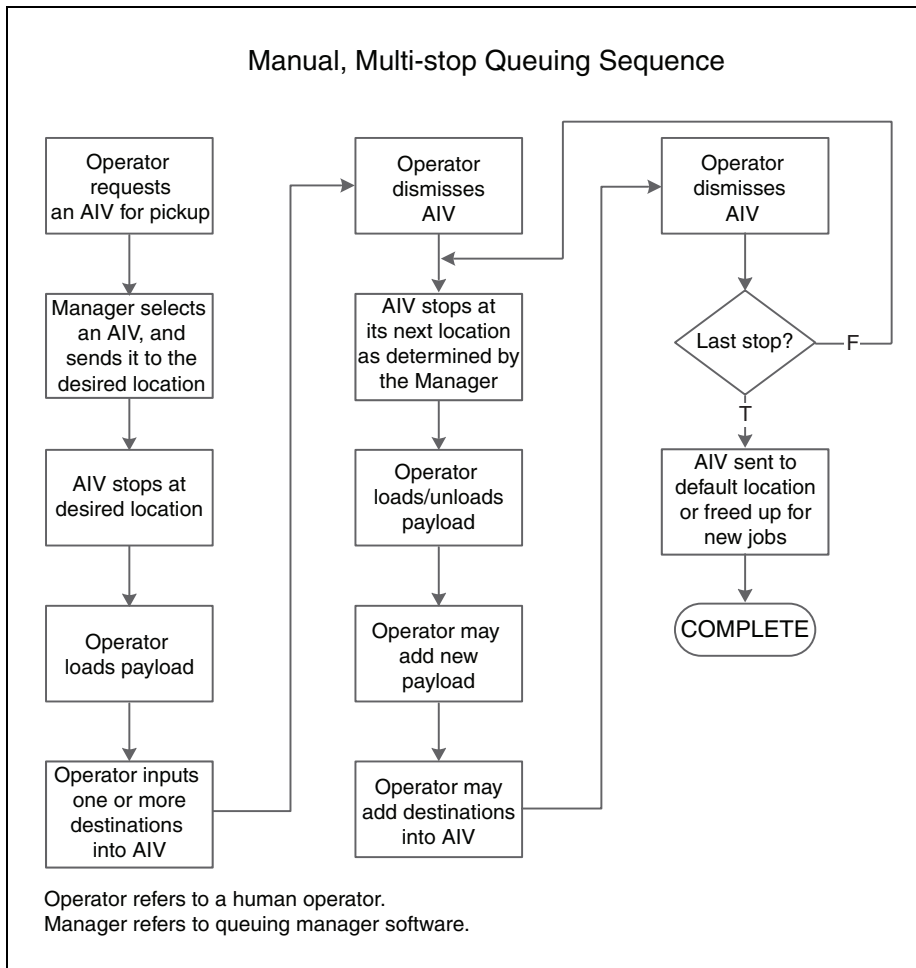

Figure 6-1. Manual Queuing Cycle

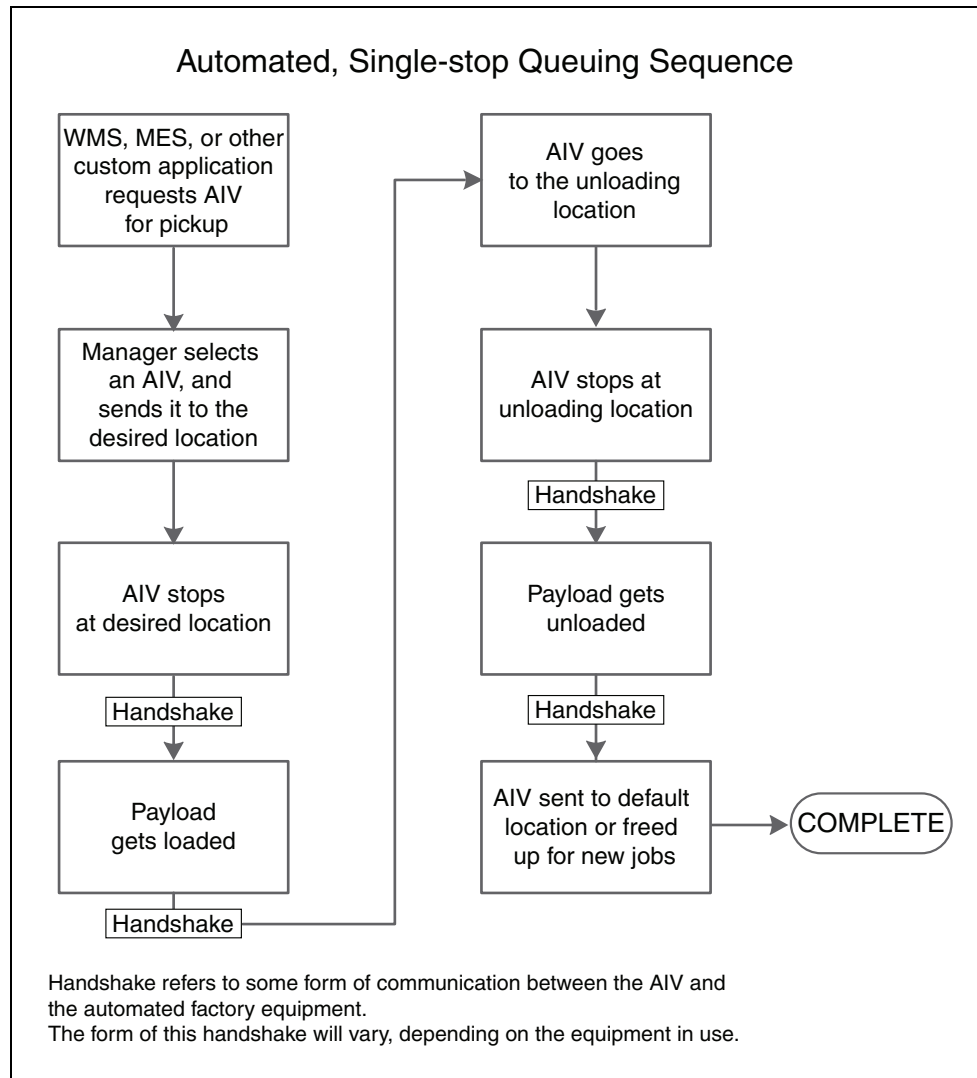

Figure 6-2. Fully-automated Queuing Cycle

Queuing Parameters

There are various parameters that need to be set to specify how the Enterprise Manager 1100 handles queued requests. Most of these are set from within the MobilePlanner software. See the *Mobile Robot Software Suite User's Guide* for information on using the MobilePlanner software.

Access these parameters from Enterprise Manager 1100, MobilePlanner, Config:

Robot Operation > Queuing Manager

The parameters that control the way that the Enterprise Manager 1100 handles queuing are:

- IdleTimeUntilResume

Number of minutes to wait, after an AIV becomes available, before automatically resuming an interrupted job.

If an AIV has just booted up, or has been operated manually, then this is the number of minutes that the queuing manager will wait before assigning any new jobs to this AIV. This can be a decimal number of minutes (e.g. 0.1 minutes is 6 seconds).

The queuing manager will not interrupt an AIV active on a job.

- **LowStateOfCharge**

This is the state-of-charge (SOC) below which the queuing manager will no longer assign new jobs to that AIV. If an AIV is below this state of charge when it completes a job, it will be sent to dock.

The AIV will continue completing its assigned jobs until it reaches the SOC settings in **Docking > AutoDockStateOfCharge**.

NOTE: An AIV will drive to a docking station any time that its state of charge falls below **Docking > AutoDockStateOfCharge** setting even, if it is performing a job. This is an AIV-level parameter, not visible or settable on the Enterprise Manager 1100.

We recommend that there be at least a 10% difference between LowStateOfCharge and AutoDockStateOfCharge, in order to ensure the AIV does not drive to a docking station while performing a job.

NOTE: An AIV will only dock if AutoDock is set to True.

- **DefaultDropoffPriority**

The default priority to use in all dropoff requests to the queuing manager.

- **DefaultPickupPriority**

The default priority to use in all pickup requests to the queuing manager.

- **DeleteCompletedItemsMinutes**

Number of minutes to keep completed jobs.

- **MaxNumberOfCompletedItems**

Maximum number of completed jobs to keep.

- **EnableParking**

Sends the AIV to a standby goal after it completes its jobs.

The following screen shows configuration parameters that need to be set for queuing:

Parameters for 'Queuing Manager':						
Parameter	Value	Description	Min	Max	Default	
EnableParking	True	When enabled, robots are sent to parking goals after they complete their job assignments. Applicable only when Map Features > Standby is enabled.				
InterruptParkingForNewJobs	True	When enabled, robots that are en route to a parking goal can be interrupted and assigned new jobs. Otherwise, the robots must reach the parking goal before they can be assigned new jobs.				
IdleTimeUntilResume	1.0	Number of minutes to wait after a robot becomes available before automatically resuming an interrupted item. Fractional values are allowed.	0.1			
ParkLowStateOfCharge	40.0	State of charge (in %) that is considered too low for parking by the Queuing Manager. If the battery is below this level when the robot completes a job, then the robot will dock instead of going to a parking goal.	0.0	100.0		
LowStateOfCharge	20.0	State of charge (in %) that is considered low by the Queuing Manager. If the battery is below this level when the robot completes a job, then the robot will be sent to the dock.	0.0	100.0		
DefaultDropoffPriority	20	Default priority to use in all DROPOFF requests to the Queuing Manager. Larger numbers have higher priority.	0	200000		
DefaultPickupPriority	10	Default priority to use in all PICKUP requests to the Queuing Manager. Larger numbers have higher priority.	0	200000		
DeleteCompletedItemsMinutes	60	Number of minutes to maintain a record of completed Queuing Manager job segments.	1	500000		
MaxNumberOfCompletedItems	100	Maximum number of completed Queuing Manager job segments to keep.	1	500000		
QueueFailedJobsInFront	False	When enabled, failed jobs will be queued using time and priority. When disabled (the default), failed jobs will be queued using priority only.				

Figure 6-3. Queuing Manager Parameters

The following list shows the commands available for queuing.

- CancelQueueId
- CancelQueueJobId
- DisplayDeliveryQueue
Presents a pop-up window showing the delivery queue.
- DisplayShowRobot
Presents a pop-up window that shows the status of all AIVs in the fleet.
- QueuingLog
- QueuingStats

These are in MobilePlanner > Config > Robot Operation > Queuing Manager

NOTE: A red + in front of some commands means that they take an argument.

Manually Clearing the Entire Queue

A Note on ARAMCentral

ARAMCentral lets you set a large number of parameters that will apply to your fleet. For some parameters, corresponding changes will need to be made to the configuration on the applicable AIVs.

In general, ARAMCentral parameters only get used in limited circumstances, often working with your local Omron sales support.

Procedure for Clearing the Queue

If you ever wish to clear the entire queue, you can do so by temporarily adding a special startup argument to ARAMCentral. The following procedure will clear the queue:

1. From MobilePlanner, Config select:
Enterprise > Enterprise Config Management
2. Under SectionsToSeparate, increment Count if there are no empty SeparateSectionX rows, where 'X' is a number, with an empty Value fields.
3. Enter the string "EnterpriseManagerFlush" in an empty Value field.
4. Click Save.
5. Wait for the ARAMCentral software to restart.
6. Use the custom command in MobilePlanner to verify that the queue has been cleared.
 - a. Select EnterpriseManagerDisplayDeliveryQueue from the Command field drop-down list.
 - b. Click the Command icon.

The queue should now be empty.

7. Reconnect to the MobilePlanner software, and remove the "EnterpriseManagerFlush" entry.
8. Click Save.
9. Wait for the ARAMCentral software to restart.

Reconnect to the MobilePlanner software.

6.4 Troubleshooting

Symptom	Possible Causes	Possible Remedies
No Power LED	Power or hardware failure	<p>Verify power cord plugged into working outlet or functional UPS</p> <p>Verify power switch on back of EM is in the ON position</p> <p>Contact your local Omron sales support</p>
Power LED ON Can't ping 1.2.3.4 via Maint Eth interface	<p>Network failure</p> <p>OS image failure</p>	<p>Verify PC network settings</p> <p>Verify cable, plugged into MAINT port</p> <p>Contact your local Omron sales support</p>
Can't ping Management IP address on LAN	LAN configuration error	<p>Verify proper "Management Interface" settings in SetNetGo</p> <p>Verify firewall access across network</p> <p>Verify network cable plugged into LAN from MGMT port</p>
Can't ping Fleet IP address on LAN	<p>LAN configuration error</p> <p>Network cabling error</p> <p>Autosync configuration error</p>	<p>Verify firewall access across network</p> <p>Single EM (no Autosync):</p> <ul style="list-style-type: none"> • Verify autosync mode set to Primary • Verify proper "Fleet Interface" settings in SetNetGo • Verify Ethernet cable connected from LAN to FLEET PORTS IN <p>With Autosync:</p> <ul style="list-style-type: none"> • Verify proper "Fleet Interface" settings on Primary unit in SetNetGo • Verify Autosync mode set to Primary on one EM, and Secondary on the other EM • Verify Ethernet cable connections per diagram in Figure 5-6.
Can ping Fleet IP address	<p>ARAMCentral configuration error</p> <p>Network permissions error</p> <p>Autosync configuration error</p>	<p>Verify that the Fleet IP address is different than the Management IP address</p> <p>Verify ARAMCentral is running by checking logs in SetNetGo</p> <p>Verify firewall access</p> <p>If using Autosync, verify autosync mode is set to Primary on only one Enterprise Manager</p>

Symptom	Possible Causes	Possible Remedies
Can't connect to ARCL port	ARAMCentral configuration error License key error	Verify ARCL Server is enabled Verify firewall access Verify USB license key is plugged in to KEY port
Can connect with ARCL to Fleet IP address No AIVs appear in MobilePlanner	Configuration error on AIV WiFi network permissions error Software versioning mismatch	Verify AIVs are configured with "ConnectToEnterpriseManager" and related parms. Verify AIVs are set up on WiFi. Verify AIVs have firewall access to access Enterprise Manager appliance from WiFi network Verify AIVs are running same MAJOR.MINOR version of software as EM. For best results, install exact same Mobile Software suite on EM and AIVs. For instance, all 4.4.x are compatible with each other, all 4.5.x are compatible with each other, but 4.4.x is not compatible with 4.5.x.

If you are requesting help from Omron Adept Technologies, Inc., it is very useful to include a debugInfo file. Instructions for doing so follow.

Including a debugInfo File

The debugInfo file can be retrieved using the MobilePlanner SetNetGo interface.

If you are unable to use the MobilePlanner SetNetGo interface:

1. Open a web browser and enter the URL:

`https://<your_EnterpriseManager_IP>`

If the Enterprise Manager appliance has not been set up on the main LAN, then a direct connection will need to be established from a PC to the MAINT ETH port.

2. Set the IP address to: 1.2.3.5 and the Subnet Mask to: 255.255.255.0.
3. Using a network patch cable (straight-through), connect the network port of your computer to AIV's maintenance port (MAINT ETH).
4. Open a web browser and enter the URL: `https://1.2.3.4`

In either case, you will be requested to confirm security certificates. You should now have the SetNetGo Home window.



1. Select **Status > Debug Info**.
2. Click **Download debug info**.
3. Save the file, and attach it to your support request.

6.5 Updating ARAMCentral

You can update the ARAMCentral version on the Enterprise Manager appliance from within SetNetGo. This is part of the Mobile Software suite.

To update the ARAMCentral package:

1. Open SetNetGo. Refer to Connecting to SetNetGo on page 29.
2. Select **Software > Manage Installed Software**.
3. Click Choose File to select the update file and the directory where it is located.
4. Click Upload to upload the Mobile Software suite to the Enterprise Manager appliance. This will upload the ARAMCentral software.

Restarting ARAMCentral

Some changes made to the Enterprise Manager appliance will cause ARAMCentral to be automatically stopped and restarted. However, you can force ARAMCentral to restart through SetNetGo, if needed.

1. Open SetNetGo. Refer to Connecting to SetNetGo on page 29.
2. Select **Software > Manage Installed Software**.
3. Click Restart.

6.6 What to do if a Primary Appliance Fails

NOTE: This section only applies if you have installed a Secondary Enterprise Manager appliance, and have it autosynchronized with the Primary.

In event of failure:

1. Using the SetNetGo interface, connect to the Management IP address for the Secondary appliance.

2. From SetNetGo on the Secondary appliance, select:
Software > Autosync
3. Switch the Secondary appliance from Secondary to Primary.
Use the drop-down arrow in the Autosync role field to select Primary.
4. Click Apply.
Clicking Reset will clear the form and restore the original values.

The AIVs will now automatically reconnect to the new Primary appliance.

The queue, configuration, and map data on the new Primary will be identical to that of the old Primary, prior to failure. Depending on exact network configuration, it will take between 1-3 minutes for the AIVs to reconnect and resume operation.

The original (failed) Primary appliance can now be safely removed from the rack without causing disruption to the fleet.

NOTE: The new Primary will now be operating on the same Fleet IP as the old Primary appliance was. Therefore, do not reconnect the old Primary to the network without first reconfiguring it, or you may cause a network IP conflict.

NOTE: The failed Primary will still have the queue file, which will no longer be current. Before putting the failed Primary back into service, you should manually clear the queue. Refer to Manually Clearing the Entire Queue on page 50.

Chapter 7: Options

7.1 Auto-Synchronized Secondary Appliance

A Secondary Enterprise Manager appliance can be installed to back up the Primary appliance.

This can be auto-synchronized with the Primary, enabling a quick switch-over in case of a failure of the Primary appliance.

Installation and configuration of the Secondary appliance is covered in the Installation and Configuration chapters.

Chapter 8: Technical Specifications

This chapter gives the technical specifications and dimensions of the Enterprise Manager appliance.

8.1 Processing Specifications

Table 8-1. Processing Specifications

CPU	Intel® Xeon® CPU
Memory	4 GB DDR3
Operating System	SetNetGo Embedded LINUX
Flash Storage	32 GB SSD

8.2 Environmental Specifications

The Enterprise Manager appliance must be shipped and stored in a temperature-controlled environment. Refer to the following table.

Table 8-2. Environmental Specifications

Operating temperature	10 to 35°C (50 to 95°F)
Operating humidity range	8 to 90%, non-condensing
Storage and shipment temperature	-25 to +60°C (-13 to +140°F)
Storage and shipment humidity range	5 to 95%, non-condensing
Chassis protection class	IP20 (NEMA Type 1)

8.3 Power Requirements

Table 8-3. Power Specifications

Input Voltage	100 - 240 VAC, 50/60 Hz
Typical Power Consumption	100 W
Maximum Power Consumption	200 W

8.4 Dimensions

The Enterprise Manager appliance is a standard 1U rackmount.

Table 8-4. Physical Specifications

Weight	6.8 kg (15 lbs)
Dimensions: Width	426.0 mm (16.77 inches)
Depth - body alone Depth - with handles	404.9 mm (15.94 inches) 438.4 mm (17.26 inches)
Height	42.4 mm (1.67 inches)

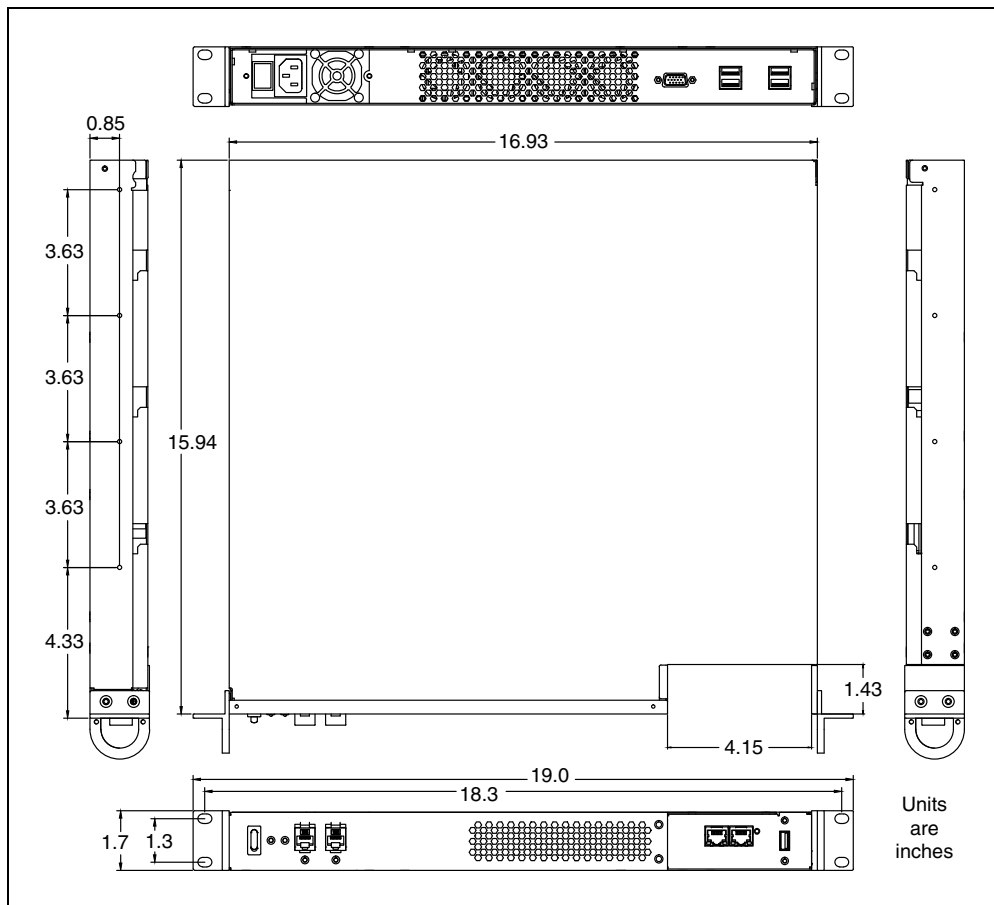

Figure 8-1. Dimensions

8.5 Connections

Front

- 10/100/1000 Ethernet x 4
- USB for license dongle

Rear

- USB x 4 for factory service use
- VGA (HDB15F) for factory service use
- AC Power in

OMRON Corporation Industrial Automation Company
Kyoto, JAPAN

Contact: www.ia.omron.com

Regional Headquarters

OMRON EUROPE B.V.

Wegalaan 67-69, 2132 JD Hoofddorp
The Netherlands
Tel: (31)2356-81-300/Fax: (31)2356-81-388

OMRON ASIA PACIFIC PTE. LTD.

No. 438A Alexandra Road # 05-05/08 (Lobby 2),
Alexandra Technopark,
Singapore 119967
Tel: (65) 6835-3011/Fax: (65) 6835-2711

OMRON ELECTRONICS LLC

2895 Greenspoint Parkway, Suite 200 Hoffman Estates,
IL 60169 U.S.A.
Tel: (1) 847-843-7900/Fax: (1) 847-843-7787

OMRON ADEPT TECHNOLOGIES, INC.

4550 Norris Canyon Road, Suite 150, San Ramon, CA 94583 U.S.A.
Tel: (1) 925-245-3400/Fax: (1) 925-960-0590

OMRON (CHINA) CO., LTD.

Room 2211, Bank of China Tower, 200 Yin Cheng Zhong Road,
PuDong New Area, Shanghai, 200120, China
Tel: (86) 21-5037-2222/Fax: (86) 21-5037-2200

Authorized Distributor:

© OMRON Corporation 2017 All Rights Reserved.
In the interest of product improvement,
specifications are subject to change without notice.

Cat. No. I615-E-01C

Printed in USA
0417 (0117)

14413-000 D