

## 2D Code Reader

V400-F050/250/350

## User's Manual

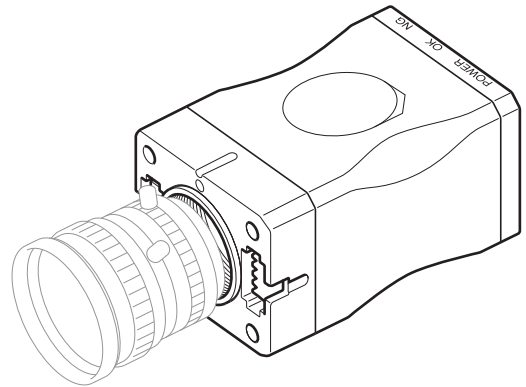
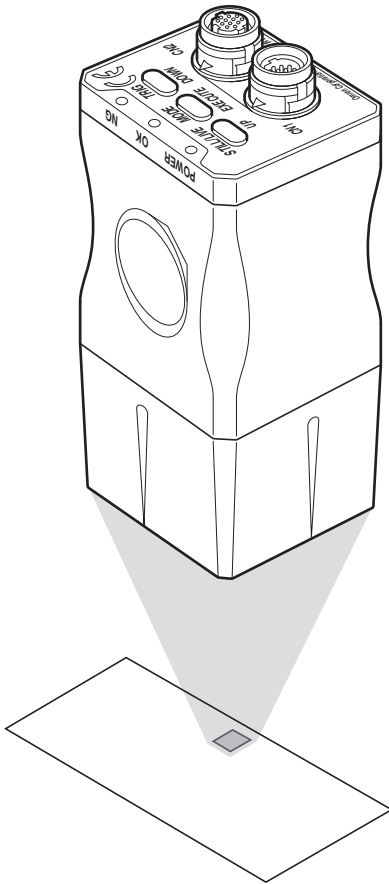
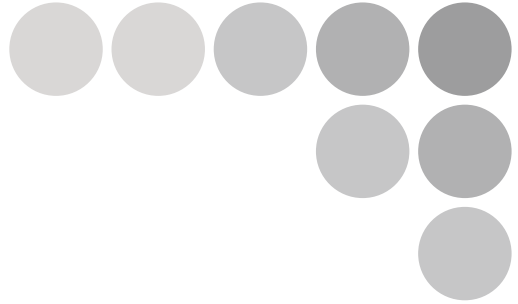

## Introduction

Thank you for purchasing the OMRON V400-F050/250/350. This manual describes the functions, performance, and application methods of the V400-F050/250/350.

This manual is intended for personnel with knowledge of electrical systems. Be sure to read and understand this manual thoroughly before using the product, and keep this manual in an easily accessible location for quick reference when required.

Introduction	Application Considerations (Read and understand this information first.)	Introduction
Section 1	Studying the V400-F	Section 1
Section 2	Changing Reading Conditions	Section 2
Section 3	Setting RS-232C and Discrete I/O Communication Conditions	Section 3
Section 4	Other Settings	Section 4
Section 5	Communicating with PC and Programmable Controller	Section 5
Section 6	Troubleshooting	Section 6
Appendix		Appendix

# 2D Code Reader User's Manual

V400-F050/250/350

**READ AND UNDERSTAND THIS DOCUMENT**

Please read and understand this document before using the products. Please consult your OMRON representative if you have any questions or comments.

**WARRANTY**

OMRON's exclusive warranty is that the products are free from defects in materials and workmanship for a period of one year (or other period if specified) from date of sale by OMRON.

OMRON MAKES NO WARRANTY OR REPRESENTATION, EXPRESS OR IMPLIED, REGARDING NON-INFRINGEMENT, MERCHANTABILITY, OR FITNESS FOR PARTICULAR PURPOSE OF THE PRODUCTS. ANY BUYER OR USER ACKNOWLEDGES THAT THE BUYER OR USER ALONE HAS DETERMINED THAT THE PRODUCTS WILL SUITABLY MEET THE REQUIREMENTS OF THEIR INTENDED USE. OMRON DISCLAIMS ALL OTHER WARRANTIES, EXPRESS OR IMPLIED.

**LIMITATIONS OF LIABILITY**

OMRON SHALL NOT BE RESPONSIBLE FOR SPECIAL, INDIRECT, OR CONSEQUENTIAL DAMAGES, LOSS OF PROFITS OR COMMERCIAL LOSS IN ANY WAY CONNECTED WITH THE PRODUCTS, WHETHER SUCH CLAIM IS BASED ON CONTRACT, WARRANTY, NEGLIGENCE, OR STRICT LIABILITY.

In no event shall responsibility of OMRON for any act exceed the individual price of the product on which liability is asserted.

IN NO EVENT SHALL OMRON BE RESPONSIBLE FOR WARRANTY, REPAIR, OR OTHER CLAIMS REGARDING THE PRODUCTS UNLESS OMRON'S ANALYSIS CONFIRMS THAT THE PRODUCTS WERE PROPERLY HANDLED, STORED, INSTALLED, AND MAINTAINED AND NOT SUBJECT TO CONTAMINATION, ABUSE, MISUSE, OR INAPPROPRIATE MODIFICATION OR REPAIR.

**SUITABILITY FOR USE**

THE PRODUCTS CONTAINED IN THIS DOCUMENT ARE NOT SAFETY RATED. THEY ARE NOT DESIGNED OR RATED FOR ENSURING SAFETY OF PERSONS, AND SHOULD NOT BE RELIED UPON AS A SAFETY COMPONENT OR PROTECTIVE DEVICE FOR SUCH PURPOSES. Please refer to separate catalogs for OMRON's safety rated products.

OMRON shall not be responsible for conformity with any standards, codes, or regulations that apply to the combination of products in the customer's application or use of the product.

At the customer's request, OMRON will provide applicable third party certification documents identifying ratings and limitations of use that apply to the products. This information by itself is not sufficient for a complete determination of the suitability of the products in combination with the end product, machine, system, or other application or use.

The following are some examples of applications for which particular attention must be given. This is not intended to be an exhaustive list of all possible uses of the products, nor is it intended to imply that the uses listed may be suitable for the products:

- Outdoor use, uses involving potential chemical contamination or electrical interference, or conditions or uses not described in this document.

- Nuclear energy control systems, combustion systems, railroad systems, aviation systems, medical equipment, amusement machines, vehicles, safety equipment, and installations subject to separate industry or government regulations.
- Systems, machines, and equipment that could present a risk to life or property.

Please know and observe all prohibitions of use applicable to the products.

NEVER USE THE PRODUCTS FOR AN APPLICATION INVOLVING SERIOUS RISK TO LIFE OR PROPERTY WITHOUT ENSURING THAT THE SYSTEM AS A WHOLE HAS BEEN DESIGNED TO ADDRESS THE RISKS, AND THAT THE OMRON PRODUCT IS PROPERLY RATED AND INSTALLED FOR THE INTENDED USE WITHIN THE OVERALL EQUIPMENT OR SYSTEM.

### **PERFORMANCE DATA**

Performance data given in this document is provided as a guide for the user in determining suitability and does not constitute a warranty. It may represent the result of OMRON's test conditions, and the users must correlate it to actual application requirements. Actual performance is subject to the OMRON Warranty and Limitations of Liability.

### **CHANGE IN SPECIFICATIONS**

Product specifications and accessories may be changed at any time based on improvements and other reasons.

It is our practice to change model numbers when published ratings or features are changed, or when significant construction changes are made. However, some specifications of the product may be changed without any notice. When in doubt, special model numbers may be assigned to fix or establish key specifications for your application on your request. Please consult with your OMRON representative at any time to confirm actual specifications of purchased products.

### **DIMENSIONS AND WEIGHTS**

Dimensions and weights are nominal and are not to be used for manufacturing purposes, even when tolerances are shown.

### **ERRORS AND OMISSIONS**

The information in this document has been carefully checked and is believed to be accurate; however, no responsibility is assumed for clerical, typographical, or proofreading errors, or omissions.

### **PROGRAMMABLE PRODUCTS**

OMRON shall not be responsible for the user's programming of a programmable product, or any consequence thereof.

### **COPYRIGHT AND COPY PERMISSION**

This document shall not be copied for sales or promotions without permission.

This document is protected by copyright and is intended solely for use in conjunction with the product. Please notify us before copying or reproducing this document in any manner, for any other purpose. If copying or transmitting this document to another, please copy or transmit it in its entirety.

## Meanings of Signal Words

In this manual, precautions are indicated using the following symbols and signal words to ensure safe use of the V400-F050/250/350. The precautions indicated by these symbols and signal words are important for safety and must be observed.



**WARNING**

Indicates a potentially hazardous situation which, if not avoided, will result in minor or moderate injury, or may result in serious injury or death. Additionally there may be significant property damage.

## Meanings of Alert Symbols



Indicates the possibility of explosion under specific conditions.



Indicates general prohibitions for which there is no specific symbol.

## Alert Statements in this Manual



**WARNING**

This product is not designed or rated for ensuring safety of persons.

Do not use it for such purposes.



## Precautions for Safe Use

Observe the following precautions to ensure safe use of the product.

### ■ Installation Environment Precautions

- Do not use the product in environments with flammable or explosive gases.
- Do not install outdoors.
- Do not install the product close to high-voltage devices and power devices in order to secure the safety of operation and maintenance.
- During installation, make sure that screws are tightened firmly.

### ■ Power Supply and Wiring Precautions

- Use the product with the power supply voltages specified in this manual.
- Use a DC power supply with countermeasures against high-voltage spikes (safe extra low-voltage circuits on the secondary side).

 p.20

### ■ Regulations and Standards

- EN61326-1
- Electromagnetic environment : Industrial electromagnetic environment (EN/IEC 61326-1 Table 2)
- The following condition is applied to the immunity test of this product.
  - a) If the level of disturbance of the video is such that characters on the monitor are readable, the test is a pass.
  - b) Power line: 10 m max.
  - c) Signal line: 30 m max.
- Notice for Korea Radio Law  
 A급 기기 (업무용 방송통신기자재)  
 이 기기는 업무용 ( A급 ) 전자파적합기기로서 판매자 또는 사용자는 이 점을 주의하시기 바라며 , 가정외의 지역에서 사용하는 것을 목적으로 합니다.

### ■ Other Precautions

- If the product becomes extremely hot, or abnormal odors or smoke occurs, stop using the product immediately, turn OFF the power, and consult with your OMRON representative.
- Dispose of the product as industrial waste.
- Do not apply pressure or deform the product when disposing of it.

## Precautions for Correct Use

Always observe the following precautions to prevent operation failures, malfunctions, and adverse effects on performance and equipment.

### ■ Installation of the Product

#### ■ Do not install the product in the following locations:

- Locations subject to ambient temperature that exceeds the rated temperature range
- Locations subject to rapid changes in temperature (causing condensation)
- Locations subject to relative humidity that exceeds the rated humidity range
- Locations subject to corrosive or flammable gases
- Locations subject to dust, salt, or metallic powder
- Locations subject to direct vibration or shock outside the specified ranges
- Locations subject to direct sunlight
- Locations subject to oil or chemical spray

#### ■ Ambient Temperature

- Maintain a minimum clearance of 50 mm above and below the product to improve air circulation.
- Do not install the product immediately above significant heat sources, such as heaters, transformers, or large-capacity resistors.
- Do not let the ambient operating temperature exceed 45°C.
- Provide a forced-air fan cooling or air conditioning if the ambient temperature is near 45°C so that the ambient temperature never exceeds 45°C.

#### ■ Noise Resistance

- Do not install the product in areas where high-voltage equipment is installed.
- Do not install the product within 200 mm of power cables.

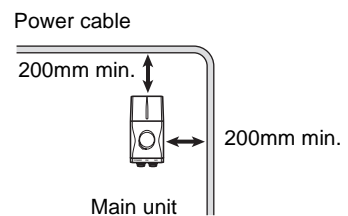



## ■ Installation and Handling of Components

- Use the cables specified in this manual.



- Keep the power supply cable as short as possible (10 m maximum).
- The power lines and discrete I/O lines of the communication/power cable should not be short-circuited with each other.
- Power output lines of the monitor cable should not be short-circuited with each other.
- Do not supply power from the monitor's power cable, since it is provided for output only.
- Do not attempt to dismantle, repair, or modify the product. Failure to observe this may result in breakdown or fire.

## ■ Connecting and Removing Cables

- Do not connect or disconnect the cables while power is supplied.
- Do not connect a cable to the 2D Code Reader if the other end of the cable is connected to a personal computer or a Programmable Controller.
- To prevent damage from static electricity, use a wrist strap or another device for preventing electrostatic charges when touching terminals or signal lines inside connectors.

## ■ Turning OFF the Power Supply

- Do not turn OFF the power supply while a message is being displayed indicating that processing is being performed. Data in memory will be destroyed, and the product may not operate correctly the next time it is started.
- Do not turn OFF the power while the setting data is being saved. Data in memory will be corrupted, and the product may not operate correctly the next time it is started.

# How to Use This Manual

## Page Format

**Section 2**  
Changing Reading Conditions

### Setting Reading Conditions Manually

This section explains how to set reading conditions manually.

- Switch to the setting mode.  
Hold down the center button for more than two seconds to activate the setting mode.  
☞ "Changing Settings" p.24
- Select [Bank Setting] from [Setting Menu].  
The [Bank Setting] screen will appear.
- From [Bank #00] to [Bank #09], select the bank to which you want to set reading condition.  
The contents of the selected bank are displayed in the right area of the screen.  
The edit menu will be displayed.

Setting item	Settings	Details
Light Channel	Select the light to be used. (For V400-F050)	
	Right CH*	The light connected to the right light connector will be used.
	Left CH.	The light connected to the left light connector will be used.
	None	No light will be used.
Code Type	Set the code type.	
	DataMatrix	The code will be read as a DataMatrix type code.
	QRCode	The code will be read as a QRCode type code.
	Auto*	The code type will be identified automatically.
Shape	Select the code shape.	
	This item is effective only when [DataMatrix] is selected for [Code Type].	
	Square	The code will be read as a square code.
	Rectangle	The code will be read as a rectangular code.
Auto*	The code shape will be identified automatically.	

V400-F050/250/350  
User's Manual 31

### Procedure and additional explanations

Information useful during the operation and reference pages are provided here with special marks to indicate the kind of information being provided.



\*This page does not actually exist in this manual.

# Visual Aids

---



Indicates points that are important in using product functions or in application procedures.

CHECK!



Indicates page numbers providing related information.



Indicates helpful information when a problem occurs and explanations of technical terms.

# Contents

---

## Introduction

Meanings of Signal Words	4
Meanings of Alert Symbols	4
Alert Statements in this Manual	4
Regulations and Standards	5
Precautions for Safe Use	5
Precautions for Correct Use	6
How to Use This Manual	8
Visual Aids	9
Contents	10

## Section 1 Studying the V400-F 13

Features and Functions of V400-F	14
Installing and Connecting the Code Reader	18
Simple Teaching	22
Changing Settings	24
Reading Results	26

## Section 2 Changing Reading Conditions 29

Setting Reading Conditions by Teaching	30
Setting Reading Conditions Manually	32
Selecting the Bank to be Used Normally	37
Copying a Bank	38
Deleting the Content of a Bank	40
Setting the Retry Method	41

Section 3 Setting RS-232C and Discrete I/O Communication Conditions	43
Setting RS-232C Communication Conditions	44
Setting Discrete I/O Communication Conditions	48
Section 4 Other Settings	51
Setting Screen Display	52
Viewing the Images Read in the Past	53
Saving/Initializing All the Settings	56
Displaying the Version Information	58
Section 5 Communicating with PC and Programmable Controller	59
RS-232C Communication	60
Discrete I/O Communication	73
Section 6 Troubleshooting	81
Error Codes and Corrective Actions	82
Troubleshooting	82
Appendix	85
Lens and Lighting	86
Line Speed and Reading Time/Exposure Time	91
Maintenance	93
Specifications and Dimensions	94
ASCII Table	99
Ladder Programming Example for Connecting to a PLC	100
FCS Check Program Example (BASIC)	104
Data Capacity Table	106
Menu Hierarchy	109
Revision History	110

MEMO

# Section 1

## Studying the V400-F

This section provides items, such as the V400-F is features, installation, connections and operation flow, with which the operator should be familiar to use the V400-F.

☒ Features and Functions of V400-F	14
Compact and Easy-to-Operate	14
Advanced Functions	16
Other Features	17
☒ Installing and Connecting the Code Reader	18
Mounting the Main Unit	18
Connecting Peripheral Devices	20
☒ Simple Teaching	22
☒ Changing Settings	24
☒ Reading Results	26
Monitor Display	26
RS-232C Communications Output	28

# Features and Functions of V400-F

This fixed type 2D code reader provides advanced reading functions and is designed for easy operation by anyone. It reads 2D codes directly marked on boards and metal materials.

Two types of code reader are available: the **V400-F250/350**, whose lens and light are integrated into one compact body, and the **V400-F050**, to which a C-mount lens can be attached to enable use of various lights.

## Compact and Easy-to-Operate

### Light/Lens Integrated Type **V400-F250/350**

- Light and Lens are Integrated
- Eliminates troublesome lens mounting and light.

#### V400-F250

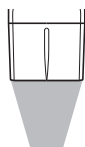

Narrow-field light

#### V400-F350

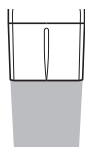

Wide-field light

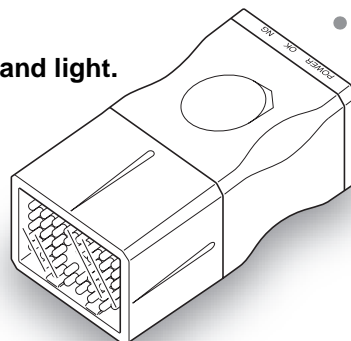

External size: 40 × 50 × 97 mm

### C-mount Type **V400-F050**

- Allows Mounting of a C-mount Type Lens
  - Provides Two Connectors that Allow Direct Connection of Light
- No power source is required for the light.

C-mount type lens  
(Recommended: p.89)

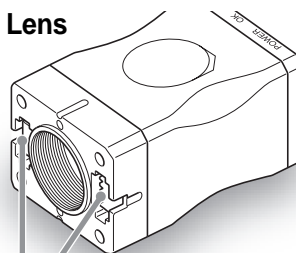
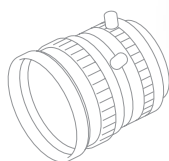

External size: 40 × 50 × 75 mm

Direct ring light      Low-angle ring light

(Recommended: p.86)

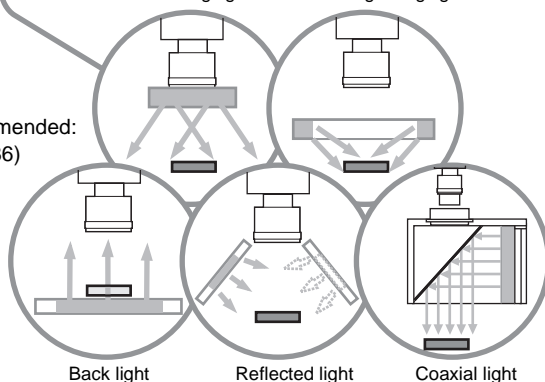

Back light

Reflected light

Coaxial light

- Supports **DataMatrix ECC200 (max. 64 × 64)**

#### Readable codes

DataMatrix



• ECC200  
10 × 10 to 64 × 64  
8 × 18 to 16 × 48

QRCode



• Model 1, 2  
21 × 21 to 57 × 57  
(Version 1 to Version 10)



- Checking Reading Results by Easy-to-See LEDs
- Easy Operations with 3 Buttons

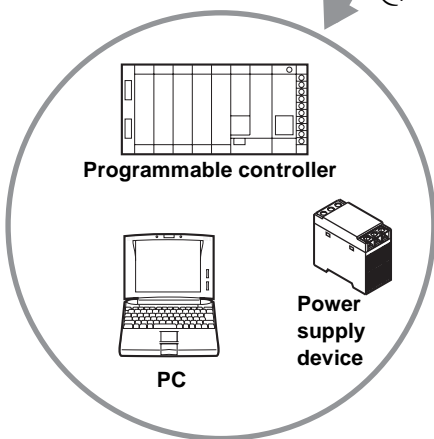
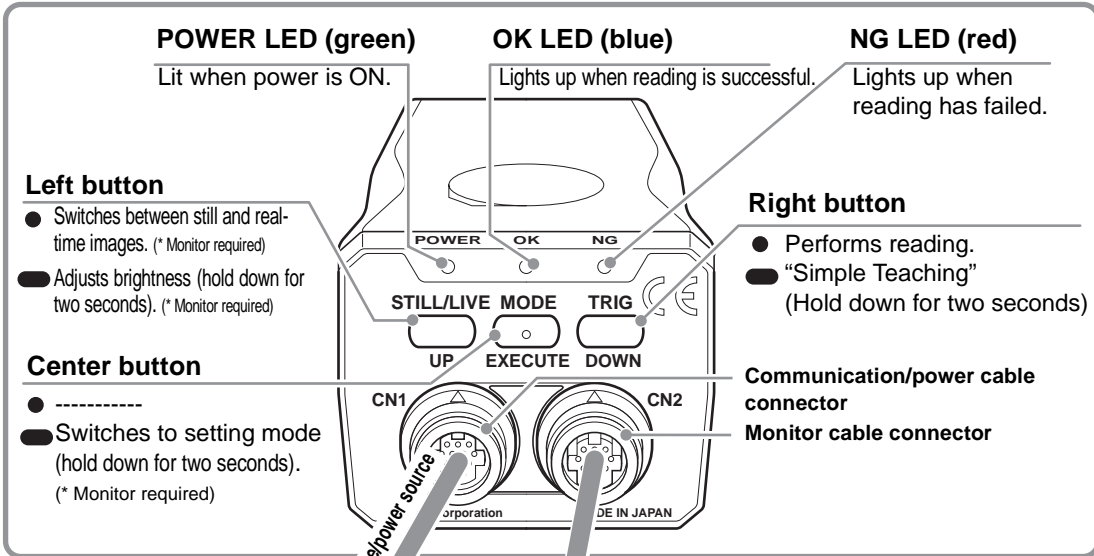

● **One-Touch Reading by "Simple Teaching"**

( p.22)  
Teaching/reading can be executed and completed by just holding down the right button for two seconds. Reading can be started without monitor.

● **Various Retry Functions**

( p.41)  
Retry can be performed not only with different exposure time, but also with two or more reading conditions that are switched automatically.

● **Connecting to a Monitor Allows Advanced Settings**

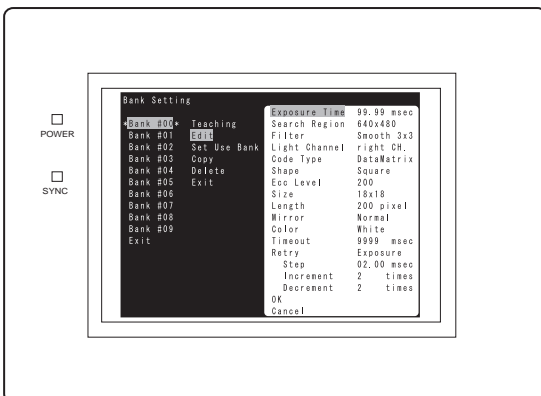

## Advanced Functions

### ● Retrying by switching to another bank automatically (📖 p.41)

Retry is performed by switching the reading condition (Bank) among the maximum five conditions.

Two condition switching methods are available: one which determines the order of the conditions to be used automatically according to the frequency of their use, and the other that switches them according to the registered order.

Combining with the retry settings that are made for each reading condition enables various retry settings.

#### [Automatically determining the order according to frequency of use]

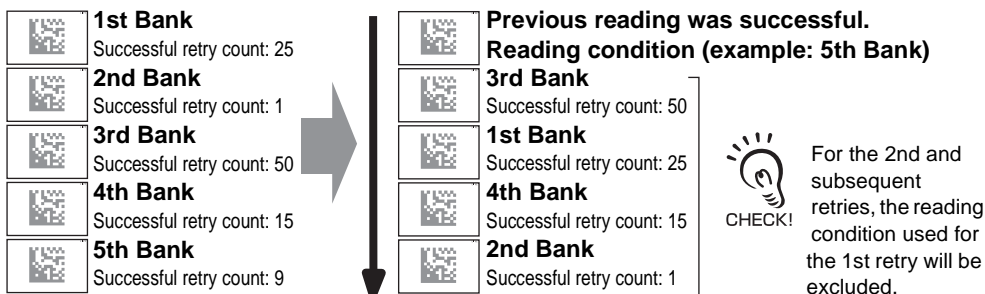

### ● Setting the reading region (📖 p.33)

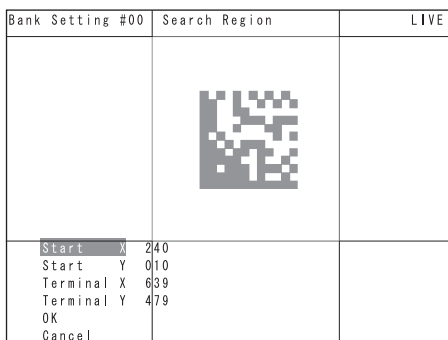

Set the image region to be read.  
This shortens the processing time.

### ● Setting a filter (📖 p.34)

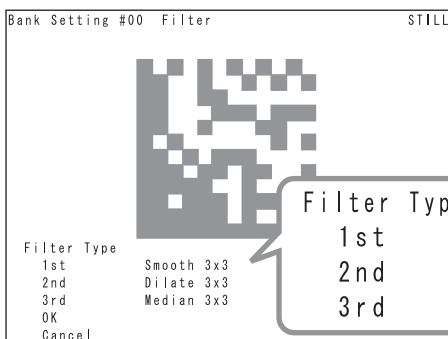

Performing image processing before reading reduces possibility of reading error.  
Filtering can be performed in 3 steps.

- Smooth, Dilate/Erosion, Median

Filter Type	
1st	Smooth 3x3
2nd	Dilate 3x3
3rd	Median 3x3

- **Enables switching between two lights (V400-F050 only)** (📖 p.34)

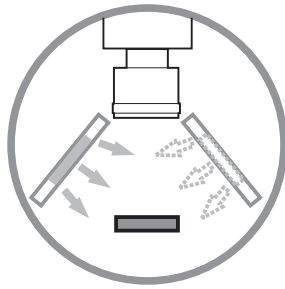

The light to be used can be switched between two lights according to the situation.

Combining this function with the auto bank switch retry function enables the code reader to handle partially reflecting work pieces.

## Other Features

- **Saves up to 10 reading conditions** (📖 p.30)
- **Saves up to 28 past read images** (📖 p.53)  
This allows you to identify the errors that occurred, by checking the saved past images.
- **Supports NPN/PNP by simply exchanging the cable.**
- **Allows direct power supply to the monitor.**  
Use of the monitor cable (V400-WM0) and LCD monitor (F150-M05L-2D) enables the V400-F to supply power to the monitor, making settings monitoring and maintenance easy.
- **Displays results in various ways** (📖 p.26)

Highlights the reading state.  
**Highlighting** (📖 p.26)

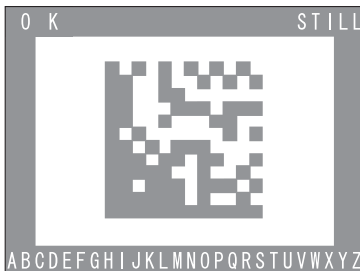

Displays analysis result of code quality numerically and graphically (bar).

**Code quality analysis display** (📖 p.27)

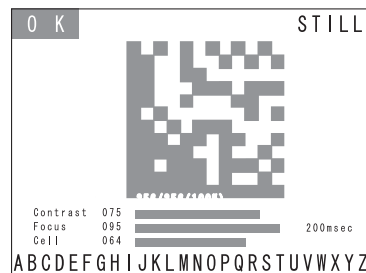

Displays the RS-232C communication history.  
**Communication history display** (📖 p.27)

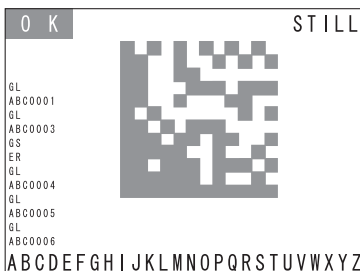

# Installing and Connecting the Code Reader

## Mounting the Main Unit

Mount the reader at a distance where the code image can be shot correctly. There are two mounting methods: "DIN track mounting" and "Base mounting".

### Field of Vision and Distance from the Code



CHECK!

- An accurate image will not be obtained if the installation distance is too long or too short. Always use the installation distance given below.
- The field of vision and installation distance of the V400-F050 vary with the lens to be used. "Selecting a Lens" p.89

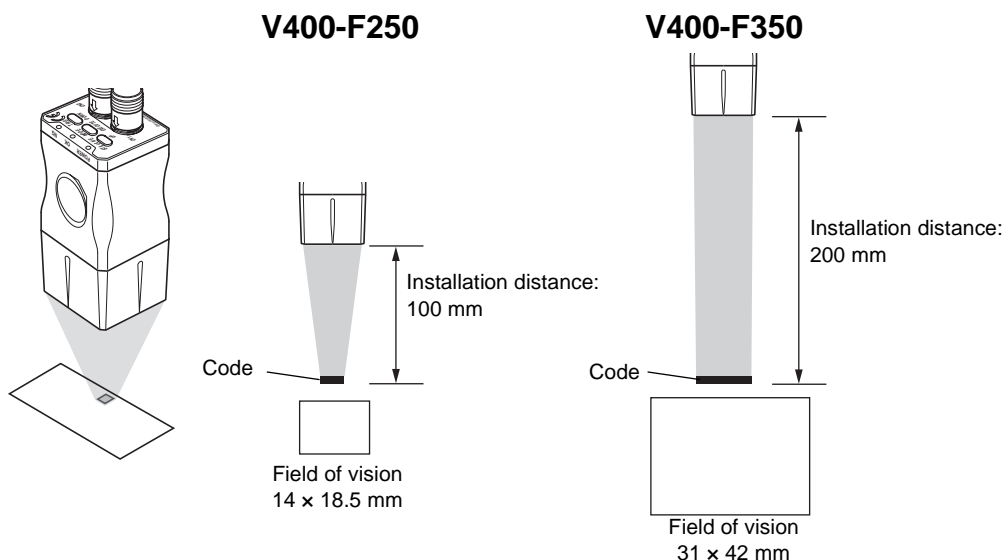

### Glossy Workpieces

Install the Main Unit at an angle so that regular reflective light is not included in the image.

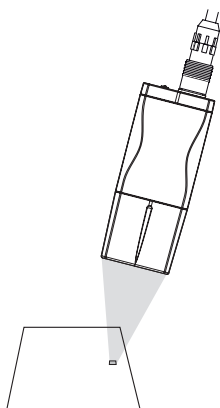

Recommended Installation Angle

Model	Recommended angle
V400-F250	10°
V400-F350	5°

## ■ Base Mounting

Mount the reader with four M3 screws.

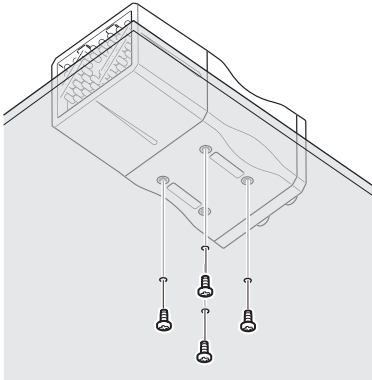

### Mounting dimensions (Unit: mm)

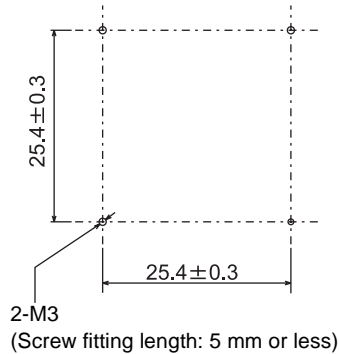

## ■ Mounting the Mount Seat

First mount the mount seat, then mount the reader to the seat with two M4 screws. The reader can also be mounted with one 1/4-20UNC screw.

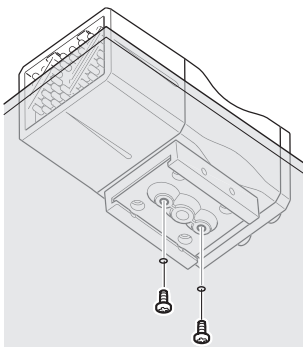

### Mounting dimensions (Unit: mm)

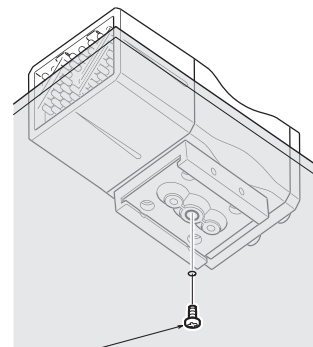
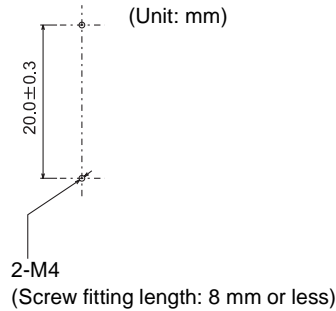

1/4-20 UNC  
(Screw fitting length: 8 mm or less)

## ■ DIN Track Mounting

1. Mount the mount seat to the undersurface of the base of the reader with M3 screws (supplied with the reader).
2. Slide the seat into the DIN rail, and then tighten the two screws at one edge of the rail using the hexagonal wrench (supplied with the reader).

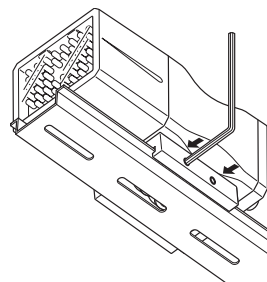
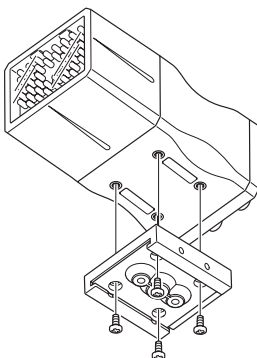

## Connecting Peripheral Devices

Connect peripheral devices to the reader.



Always turn OFF the reader before connecting or disconnecting a peripheral device's cable. Peripheral devices may be damaged if the cable is connected or disconnected with the power ON. The connector (CN2) for the monitor is capped when the reader is shipped. The cap must be left on those connectors that are not used to protect them from dust, dirt and static electricity.

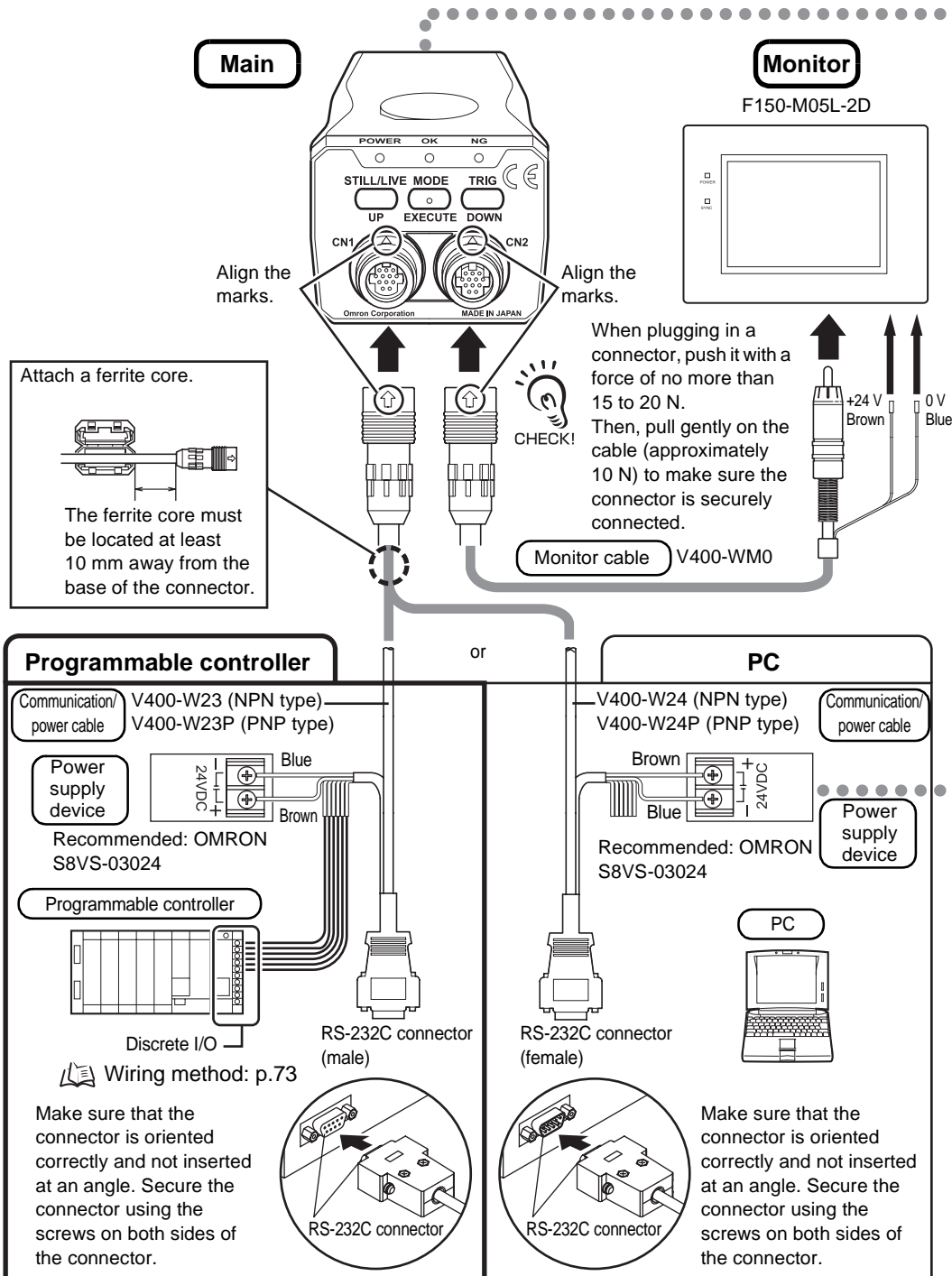

**Lens and light (for V400-F050 only)**

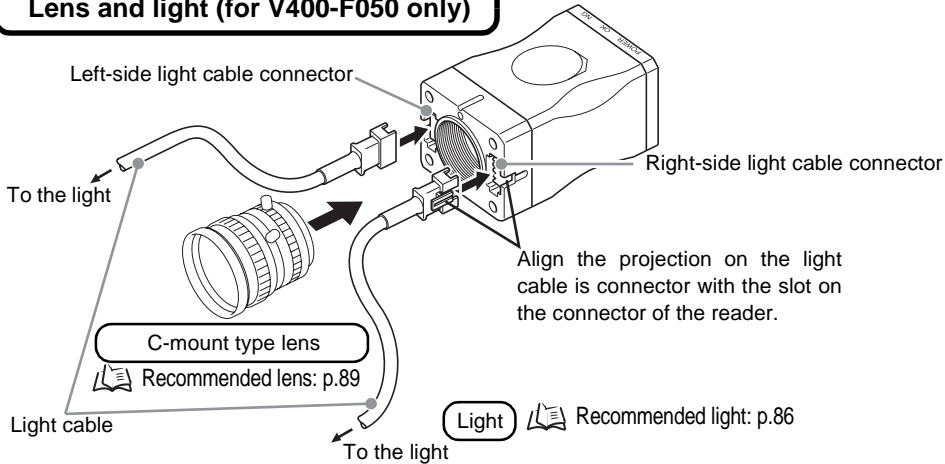

**Power**

For V400-F050/250/350, a power supply device must be provided separately. Wire the power supply independently of other devices. In particular, keep the power supply wired separately from inductive loads.



CHECK!

Use a DC power supply with safety measures against high-voltage spikes (safety extra low-voltage circuits on the secondary side). If UL recognition is required for the overall system, use a UL Class II DC power supply.

Use a power supply that meets the following requirements.

Output current	1.2 A min.
Power supply voltage	24 VDC $\pm$ 10%
Recommended	S8VS-03024

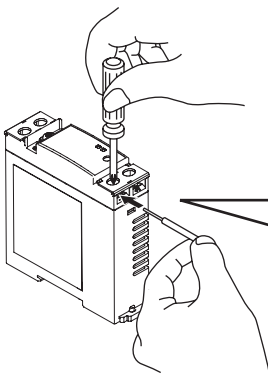

Connect the brown wire to the positive (+) side of the power supply and the blue wire to the negative (-) side.

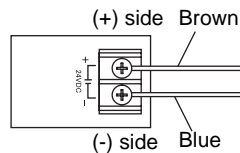

**■ Handling the Cable**

After the connector is plugged in, do not apply a force of more than 30 N to the connector in the directions shown below. Excessive force will damage the connector.

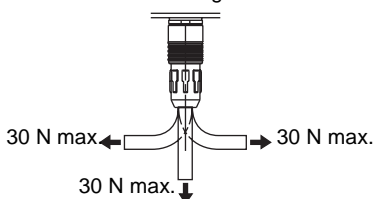

When disconnecting a cable, hold the part of the plug shown below and then pull it out straight.

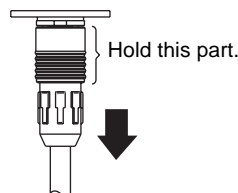

# Simple Teaching

Use "Simple Teaching" to check whether codes on the work piece are readable.

"Simple Teaching" enables you to set necessary reading conditions automatically by simple operations.

To change reading conditions or set them in detail, use the setting mode.

## 1 Turning ON the power

### 1-1 Turn ON the power to the monitor.

- When using F150-M05L-2D, make sure that it is connected before turning ON the power to the power supply device.

### 1-2 Turn ON the power to the power supply device.

The POWER LED (green) will light up.

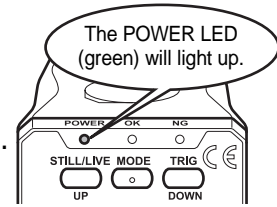

## 2 Performing teaching

### 2-1 Capture the work piece.

Switch to the real-time image display mode, and adjust the position and brightness of the work piece while observing the image on the monitor.

[STILL]: Still image  
[LIVE]: Real-time image

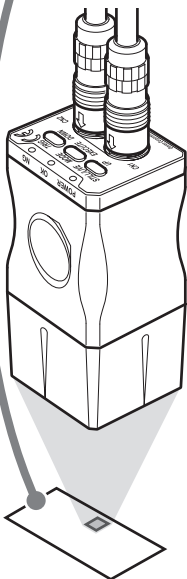
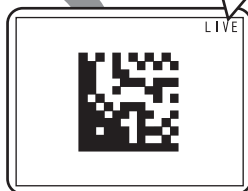

### Display switching

Press the left button to switch from the still image to the real-time image or vice versa.



### Brightness adjustment

Hold down the left button for more than two seconds, to display the exposure time adjustment screen. The brightness will be adjusted based on the exposure time.



### 2-2 Perform teaching.

Hold down the right button for more than two seconds, to perform "Simple Teaching".

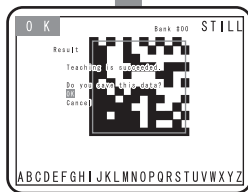
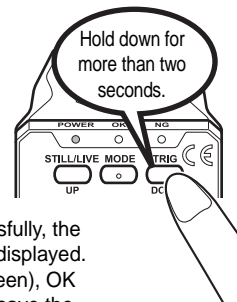

When teaching is completed successfully, the teaching and reading results will be displayed. Three indicators will light: Power (green), OK (blue), and NG (red). Select [OK] to save the results.

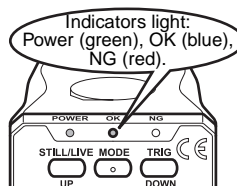





- The teaching results will be overwritten, registered to [Bank #00], and saved.
- If [Cancel] is selected in the result display screen, the results will not be saved.

### 3 Exiting

Turn OFF the power to the power supply device and then to the monitor.

# Changing Settings

The setting mode allows you to make changes to reading conditions and system settings. This section explains operations for the setting mode.

## 1 Switch to the setting mode.

Hold down the center button for more than two seconds.  
All the LEDs will light up and the [Setting Menu] appears.

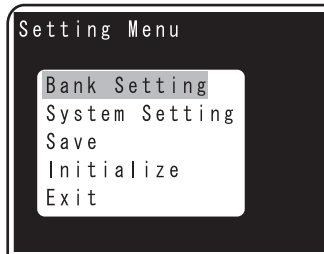
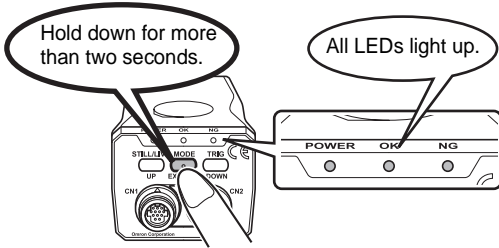

## 2 Make settings

### ● Basic operation for setting mode

Use the right and left buttons to select the desired item, and then press the center button to confirm the selection.

To close the current menu, select [Exit] and then press the center button.

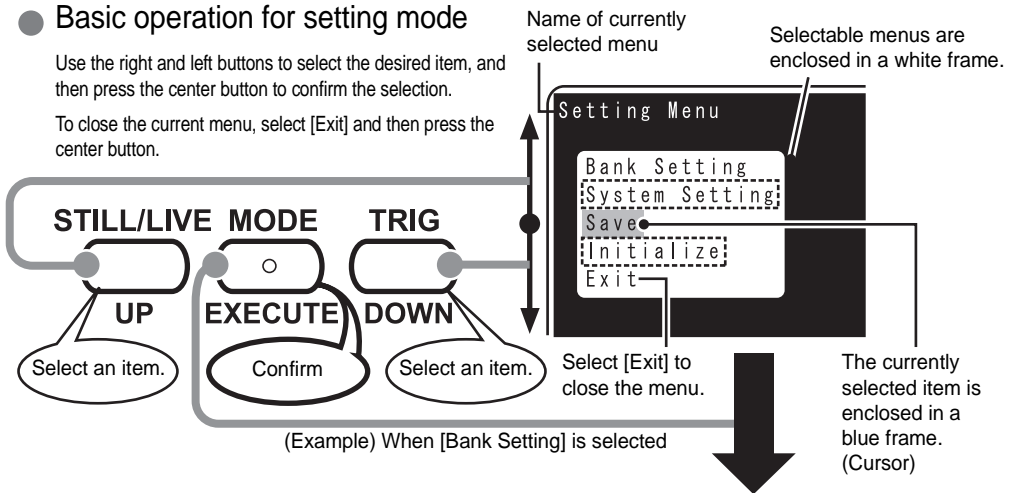

(Example) When [Bank Setting] is selected

Indicates that this reading condition is normally used.  
\* Only when [Bank Setting] is selected

### ● Numerical value inputting method

- 1 0 Move the cursor to the desired item and press the center button.
- 1 2 Change the value using the right and left buttons.
- 1 2 Press the center button to confirm the setting.

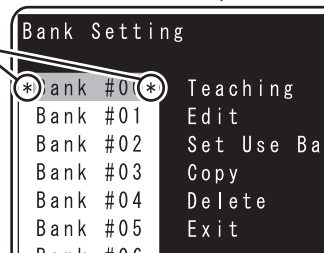

● **Setting the reading conditions**  p.29

Select [Bank Setting] from [Setting Menu].

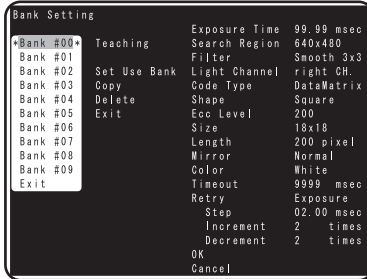







- Up to 10 reading conditions are available.
- When a reading condition is selected, its settings will be displayed in the right area of the screen.
- Select the desired reading condition from among the ten conditions, and set each condition item manually or by teaching.
- Reading conditions can be copied or deleted.



Reading condition [Bank #00] contains the contents of "Simple Teaching".

● **Other settings**

Select [System Setting] from [Setting Menu].

[RS-232C]	Set RS-232C communication related parameters such as baud rate and parity.	 p.44
[Data Format]	Set data format setting for RS-232C communication.	 p.46
[Discrete I/O]	Set discrete I/O related settings including trigger mode and busy input.	 p.48
[Display]	Change the monitor display method.	 p.52
[Image Store]	Select the methods for storing images and referring to stored images.	 p.53
[Bank Switching]	Change the automatic bank switch retry setting.	 p.41
[Version Information]	Displays the software version.	 p.58

**3** **Saving the settings**  p.56

Select [Save] from [Setting Menu].  
All the settings including reading conditions will be saved.



Before exiting, make sure to save the settings in the setting mode. If the settings are not saved, the reading conditions and other settings will be lost.

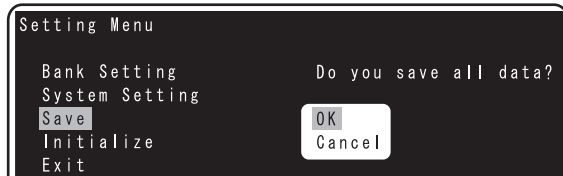

# Reading Results

This section explains details of the read results.

## Monitor Display

Explanation of reading results displayed on the monitor is given below.

There are four display methods: normal display, highlighting display, code quality analysis display and communication display.

The desired display method can be set in the setting mode.

 Display setting: p.52

### ■ Normal Display

Normal screen

#### Reading status

The reading status is displayed.

**OK (blue):** Reading is completed successfully.

**NG (red):** Reading has failed.

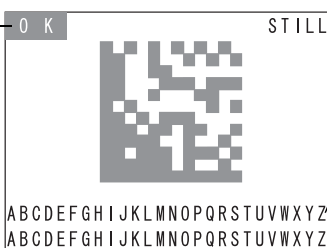

#### Read data

The read data is displayed.  
(Max. **208** characters =  
8 lines × 26 characters)

An error code is displayed in case of reading error.

#### • Error code contents

Error code	Action
?E000	2D code cannot be found, possibly due to uneven background. Check the work piece surface and lighting condition.
?E100	2D code cell cannot be recognized correctly. Check the marking and lighting conditions, and then perform teaching again.
?E200	Reading was not completed within the specified period of time. Check the work piece and lighting condition, then perform teaching again. Increase the reading timeout value.



If reading has failed, it may be possible that the cause can be identified by checking the read image.

 p.53

### ■ Highlighting Display

The screen is enclosed in a frame whose color that indicates the reading status.

#### Reading status

The reading status is displayed.

**OK (blue):** Reading is completed successfully.

**NG (red):** Reading has failed.

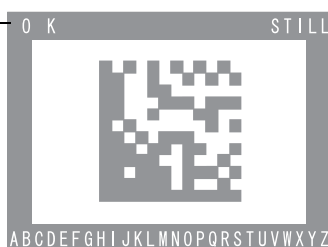

#### Read data

The read data is displayed.  
(Max. **26** characters)  
An error code is displayed in case of reading error.

## Code quality analysis display

This screen displays analysis result of code quality numerically and graphically (bar).

### Reading status

The reading status is displayed.

**OK (blue):** Reading is completed successfully.

**NG (red):** Reading has failed.

### Code quality analysis

The code quality analysis result is displayed numerically (0 to 100) and graphically (bar).

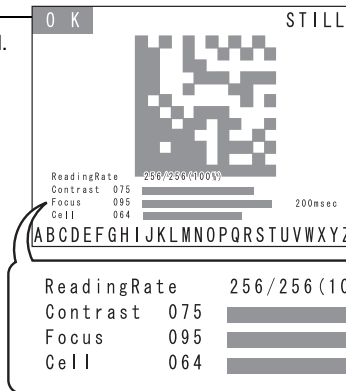

### Read data

The read data is displayed.

(Max. 26 characters)

An error code is displayed in case of reading error.

### Code quality analysis items

Item	Description
Reading Rate	Displays the rate of successful reading count to the total reading count.
Contrast	Evaluates the code is white/black contrast that varies with the lighting condition. The larger the difference between the white and black parts of the code, the larger the contrast. "1" will be displayed if the code is contrast is the minimum readable level.
Focus	Evaluates the focus level of the image. If the code is out of focus, it can no longer be recognized. The more the code is out of focus, the smaller the value displayed.
Cell	Evaluates the number of recognition fails for each cell in the finder pattern, timing pattern and data. The more cells in which recognition failure occurs and the more unstable the reading is, the smaller the value displayed.

## Communication Display

This screen displays the RS-232C communication history.

### Reading status

The reading status is displayed.

**OK (blue):** Reading is completed successfully.

**NG (red):** Reading has failed.

### Communication history

The RS-232C communication history is indicated by yellow and green characters.

Communication contents are displayed from the bottom to the top of the history display area.

**Yellow:** Indicates that the content was input to the main body.

**Green:** Indicates that the content was output from the main body.

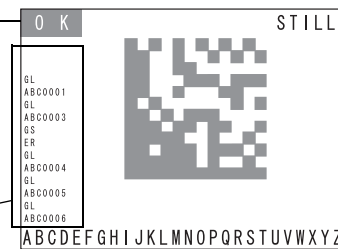

### Read data

The read data is displayed.

(Max. 26 characters)

An error code is displayed in case of reading error.

## RS-232C Communications Output

This section explains the reading results to be output via RS-232C communication.

### ■ When reading is successful

The read data is output in the following format.

Number of read data digits	Code quality	Read data
----------------------------	--------------	-----------

“Number of read data digits” and “Code quality” are output only if [Digit Data] and [Checker Data] are set to [ON] in the data format setting.

 p.46

### ■ When reading has failed

By factory default, an error code is output in the following format. However, it is possible to make a data format setting so that no error code will be output.

 Error code output setting: p.47







Header	?E000	Footer
--------	-------	--------

 Error code: p.26, p.82

# Section 2

## Changing Reading Conditions

This section provides information required for changing reading conditions.

 Setting Reading Conditions by Teaching	30
 Setting Reading Conditions Manually	32
 Selecting the Bank to be Used Normally	37
 Copying a Bank	38
 Deleting the Content of a Bank	40
 Setting the Retry Method	41
Setting the Bank Switching Retry Function	41

# Setting Reading Conditions by Teaching

Teaching uses one sample to read it and sets a reading condition based on the results.

## 1. Switch to the setting mode.

Hold down the center button for more than two seconds to activate the setting mode.

 "Changing Settings" p.24

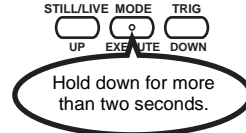

## 2. Select [Bank Setting] from [Setting Menu].

The [Bank Setting] screen will appear.

## 3. From [Bank #00] to [Bank #09], select the bank to which the teaching results are to be saved.

The contents of the selected bank are displayed in the right area of the screen.



[Bank #00] contains the reading condition set by "Simple Teaching".

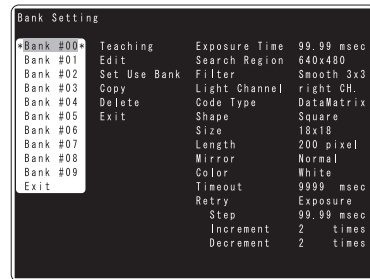

The edit menu will be displayed.

## 4. Select [Teaching].

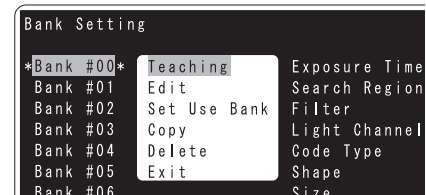

The [Teaching] screen will appear and the screen brightness is adjusted automatically.

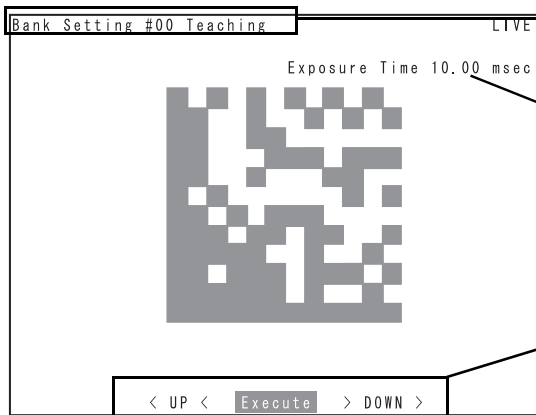

### Menu name

Displays the name of the currently selected menu and the name of the upper hierarchical level.

### Exposure time

Displays the currently set exposure time.

### Guidance

Displays the operating method in brief.



### 5. Adjust the brightness.

Check the automatically adjusted brightness.

To change the brightness, press the right and left buttons.



CHECK!

The brightness is adjusted based on the exposure time. The longer the exposure time, the brighter the image but the image is easily blurred if the work piece is not stationary.

p.91

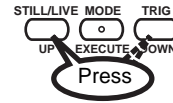

### 6. Confirm the brightness.

Press the center button.

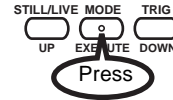

Teaching will start.

When teaching is complete, the teaching results are displayed.

### 7. Checking the results.

Check the teaching results.

To change the reading condition, select the condition item to be changed. For details, refer to "Setting Reading Conditions Manually" p.32.

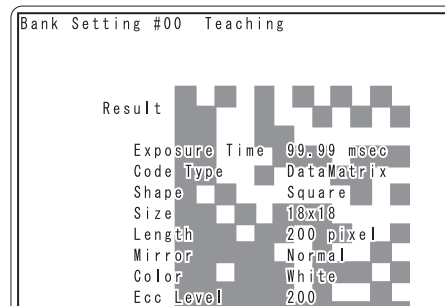

### 8. Confirm the reading condition.

Select [OK] to confirm the reading condition. This will bring you to the operation menu.

If you select [Cancel], the operation menu will reappear without reflecting the teaching results.

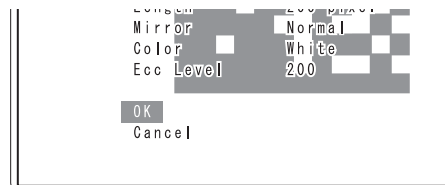

### 9. Save the settings.

Select [Save] from [Setting Menu] to save the changes you have made to the reading condition.

p.56

# Setting Reading Conditions Manually

This section explains how to set reading conditions manually.

## 1. Switch to the setting mode.

Hold down the center button for more than two seconds to activate the setting mode.

"Changing Settings" p.24

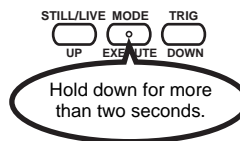

## 2. Select [Bank Setting] from [Setting Menu].

The [Bank Setting] screen will appear.

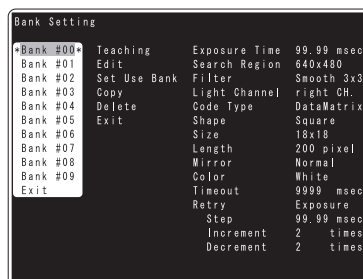

## 3. From [Bank #00] to [Bank #09], select the bank to which you want to set reading condition.

The contents of the selected bank are displayed in the right area of the screen.

The edit menu will be displayed.

## 4. Select [Edit].

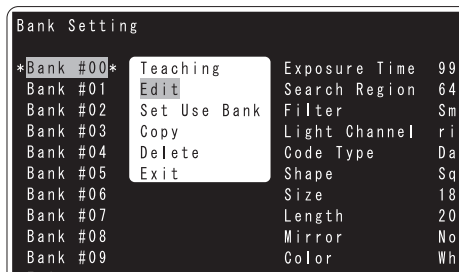

The reading condition change menu will appear.

## 5. Make changes to the reading condition.

For reading condition items, refer to "Reading Condition Items" ( p.33).

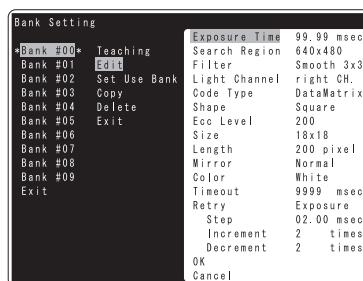

## 6. Confirm the reading condition.

Select [OK] to confirm the reading condition. This will bring you to the operation menu.

If you select [Cancel], the operation menu will reappear without reflecting the changes.



## 7. Save the settings.

Select [Save] from [Setting Menu] to save the changes you have made to the reading condition.

p.56

### ■ Reading Condition Items

#### ■ [Exposure Time]

Set the desired exposure time. The longer the exposure time, the brighter the image is, but the image is blurred easily if the work piece is not stationary. p.91

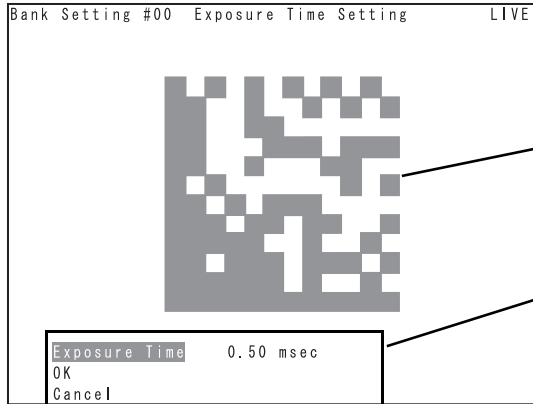

The brightness changes in real time as you change the setting.

Set the desired exposure time.  
0.03 to 10.00 (msec)  
Select [OK] to confirm the changes and return to the edit menu.  
Select [Cancel] to cancel the changes and return to the edit menu.

#### ■ [Search Region]

Set the image region to be read. The region enclosed by the red and green boundary lines will be the subject of reading.

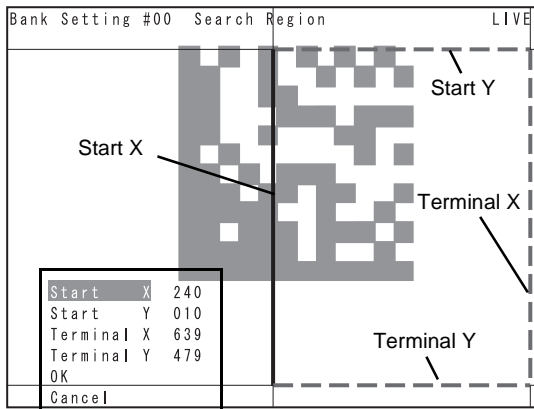

The region boundary lines move in real time as you change the setting.

**Line type**

- Red: Currently changed region boundary line
- Green: Region boundary line
- Black: Boundary line outside region

**CHECK!** In the actual screen, the same line type and thickness are used. Different type and thickness are used to make color distinction easier.

Set the region boundary lines.  
Select [OK] to confirm the changes and return to the edit menu.  
Select [Cancel] to cancel the changes and return to the edit menu.

■ **[Filter]**

Set the image processing to be performed at completion of reading. This will lower the possibility of reading failure.

Filtering can be performed in 3 steps (filter type can be selected from Smooth, Dilate, Erosion and Median).

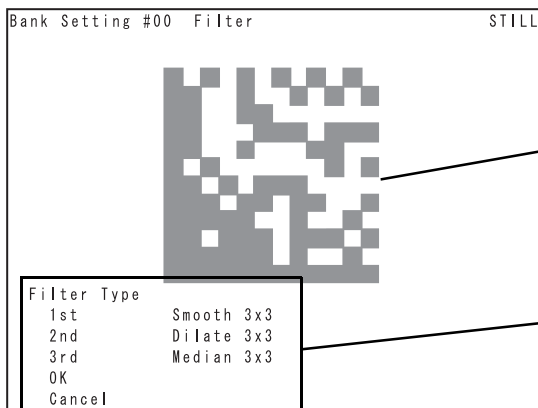

The image changes in real time as you change the setting.

**Filter**  
Select [OK] to confirm the changes and return to the edit menu.  
Select [Cancel] to cancel the changes and return to the edit menu.

Settings	Details
Smooth 3 × 3	Smoothing filter. This filter smooths the image.
Smooth 5 × 5	The filter size can be selected from 3 × 3 and 5 × 5.
Dilate 3 × 3	Dilate filter. This filter makes the cell smaller if the code is black.
Dilate 5 × 5	The filter size can be selected from 3 × 3 and 5 × 5.
Erosion 3 × 3	Erosion filter. This filter makes the cell larger if the code is black.
Erosion 5 × 5	The filter size can be selected from 3 × 3 and 5 × 5.
Median 3 × 3	Median filter. This filter eliminates noise.
Median 5 × 5	The filter size can be selected from 3 × 3 and 5 × 5.
None*	No filtering is performed.



The default settings are indicated with an asterisk (\*).

■ **Other Settings**

Setting item	Settings	Details
Light Channel (For V400-F050)	Select the light to be used.	
	Left CH.*	The light connected to the left light connector will be used.
	Right CH.	The light connected to the right light connector will be used.
	None	No light will be used.
Lighting (For V400-F250/ 350)	ON*	The light will be used.
	OFF	The light will not be used.
Code Type	Set the code type.	
	DataMatrix	The code will be read as a DataMatrix type code.
	QRCode	The code will be read as a QRCode type code.
	Auto*	The code type will be identified automatically.

Setting item	Settings	Details
Shape	Select the code shape. This item is effective only when [DataMatrix] is selected for [Code Type].	
	Square	The code will be read as a square code.
	Rectangle	The code will be read as a rectangular code.
	Auto*	The code shape will be identified automatically.
Model	Select the QR code model. This item can be selected only when [QRCode] is selected for [Code Type].	
	Model 1	The code will be handled as Model 1 code.
	Model 2	The code will be handled as Model 2 code.
	Auto*	The code model will be identified automatically.
Ecc Level	Select the error correction level (ECC level).	
	200	The code will be read as the ECC level recommended by ECC200 (AIM). Only this item is available if [DataMatrix] is selected for [Code Type].
	L (7%)*	Up to 7% damage can be handled. This item can be selected only when [QRCode] is selected for [Code Type].
	M (15%)	Up to 15% damage can be handled. This item can be selected only when [QRCode] is selected for [Code Type].
	Q (25%)	Up to 25% damage can be handled. This item can be selected only when [QRCode] is selected for [Code Type].
	H (30%)	Up to 30% damage can be handled. This item can be selected only when [QRCode] is selected for [Code Type].
	Auto*	The ECC level will be identified automatically.
Size	Select the number of cells present for each side of the code. The size varies with the code.	
	10 × 10 to 64 × 64	This item can be selected only when [Square] is selected for [Shape].
	8 × 18 to 16 × 48	This item can be selected only when [Rectangle] is selected for [Shape].
	21 × 21 to 57 × 57	This item can be selected only when [QRCode] is selected for [Code Type].
	Auto*	The size will be identified automatically.
Length	Enter the code length (the length on the screen) in pixels.	
	50 to 480	-
	Auto*	The length will be identified automatically.
Mirror	Select the mirror image.	
	Normal	The code will be read as a non-reverse image (in normal direction).
	Reverse	The code will be read as a mirrored image (in reverse direction).
	Auto*	Whether the code is a normal or reverse image will be identified automatically.

## Section 2 Changing Reading Conditions

Setting item	Settings	Details
Color	Set the code cell color.	
	Black	The code will be read as a black code.
	White	The code will be read as a white code.
	Auto*	The color will be identified automatically.
Timeout	Enter the time (in msec) allowed before reading is completed after it is started.	
	100 to 9999 (2000*)	-
Retry	<p>Set this item when you need to retry (capture the image twice or more) after reading is executed. Capturing the image can be performed with a different exposure time.</p>  It is possible to retry capturing the image twice or more with different reading conditions. CHECK!  "Setting the Bank Switching Retry Function" p.41	
	None*	Capture will not be retried (i.e. capture will be performed only once).
	Exposure	Allows retry with different exposure time. Capturing the image can be performed twice or more with a different exposure time. For instance, if [02.00 msec] is set for [Step], [2 times] for [Increment] and [2 times] for [Decrement], the exposure time will be changed each time capture is performed, starting from 10 msec to 12 msec, 8 msec, 14 msec and then 6 msec (if the original exposure time is 10 msec).
	Normal	Simple retry. Capture will be retried with the same reading condition.
Step	0.01 to 05.00* (0.30*)	Set the step (msec) in which the exposure time is changed. This item can be selected only when [Exposure] is selected for [Retry].
Increment	0 to 4 (2*)	Set the number of times (Times) the exposure time is to be increased. This item can be selected only when [Exposure] is selected for [Retry].
Decrement	0 to 4 (2*)	Set the number of times (Times) the exposure time is to be decreased. This item can be selected only when [Exposure] is selected for [Retry].
Interval	32 to 999 (100*)	Set the interval (msec) at which capture is to be performed. This item can be selected only when [Normal] is selected for [Retry].
Max Count	0 to 8 (4*)	Set the number of times (Times) capture is to be repeated. This item can be selected only when [Normal] is selected for [Retry].

The default settings are indicated with an asterisk (\*). However, in the case of [Bank #00], [Exposure] will be set for [Retry] as the default.

# Selecting the Bank to be Used Normally

This section explains how to select the bank that is to be used normally.

## 1. Switch to the setting mode.

Hold down the center button for more than two seconds to activate the setting mode.

"Changing Settings" p.24

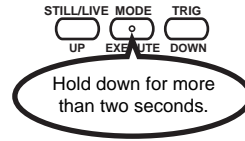

## 2. Select [Bank Setting] from [Setting Menu].

The [Bank Setting] screen will appear.

## 3. From [Bank #00] to [Bank #09], select the bank that is to be used normally.

The contents of the selected bank are displayed in the right area of the screen.

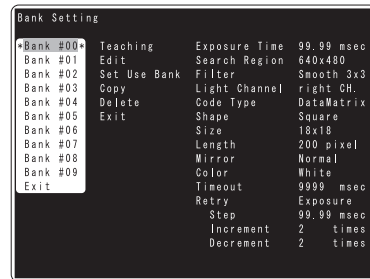

The edit menu will be displayed.

## 4. Select [Set Use Bank].

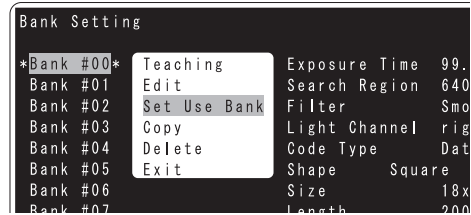

A confirmation message will be displayed.

## 5. Confirm the reading condition.

Select [OK] to confirm the setting. This will bring you to the operation menu.

If you select [Cancel], the operation menu will reappear without reflecting the changes.

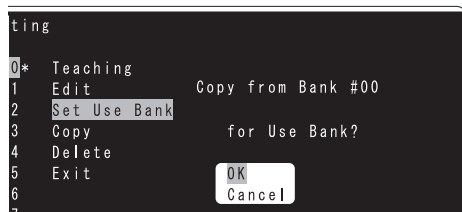

An asterisk (\*) will appear at both right and left ends of the reading condition to be normally used.

## 6. Save the settings.

Select [Save] from [Setting Menu] to save the changes you have made to the reading condition.

p.56

# Copying a Bank

This section explains how to copy the content of one bank to another bank.

## 1. Switch to the setting mode.

Hold down the center button for more than two seconds to activate the setting mode.

"Changing Settings" p.24

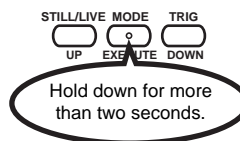

## 2. Select [Bank Setting] from [Setting Menu].

The [Bank Setting] screen will appear.

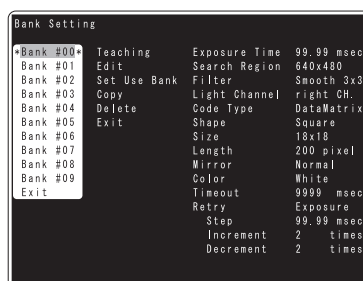

## 3. From [Bank #00] to [Bank #09], select the bank whose content is to be copied to another bank.

The contents of the selected bank are displayed in the right area of the screen.

The edit menu will be displayed.

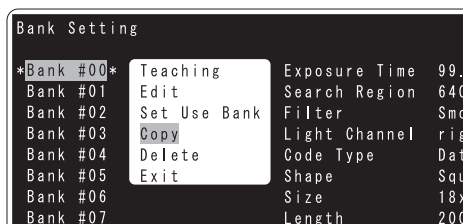

## 4. Select [Copy].

A confirmation message will be displayed.

## 5. Select the copy destination bank.

If you select [Cancel], the operation menu will reappear without reflecting the changes.

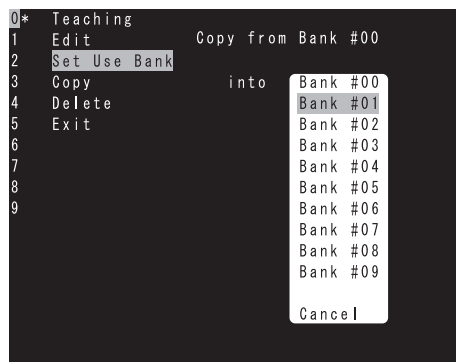



▼  
A confirmation message will be displayed.

## 6. Execute copy.

Select [OK] to execute copy. This will bring you to the operation menu.

If you select [Cancel], the previous menu will reappear without reflecting the changes.

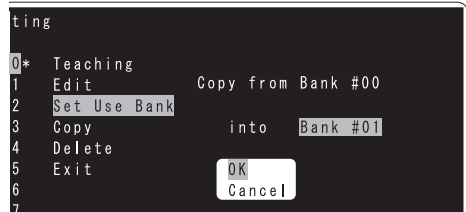

## 7. Save the settings.

Select [Save] from [Setting Menu] to save the changes you have made.

 p.56

# Deleting the Content of a Bank

This section explains how to delete the content of a bank and restore the default settings for that bank.

## 1. Switch to the setting mode.

Hold down the center button for more than two seconds to activate the setting mode.

"Changing Settings" p.24

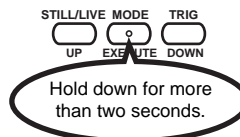

## 2. Select [Bank Setting] from [Setting Menu].

The [Bank Setting] screen will appear.

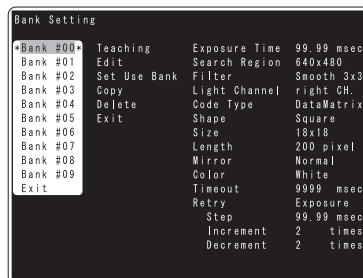

## 3. From [Bank #00] to [Bank #09], select the bank whose content is to be deleted.

The contents of the selected bank are displayed in the right area of the screen.

The edit menu will be displayed.

## 4. Select [Delete].

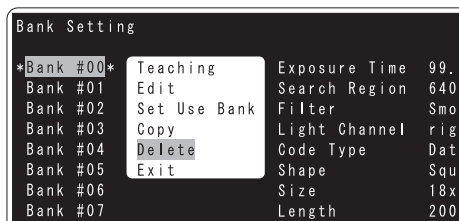

A confirmation message will be displayed.

## 5. Execute deletion.

Select [OK] to confirm the settings. This will bring you to the operation menu.

If you select [Cancel], the operation menu will reappear without deletion.



The content of the selected bank will be deleted, and the default settings will be restored for that bank.

## 6. Save the settings.

Select [Save] from [Setting Menu] to save the settings.

p.56

# Setting the Retry Method

This section explains how to set the retry method (to execute reading and then capture an image twice or more).

Two retry methods are available: “Same bank” and “Bank Switching”.

Item		Details
Same bank	Exposure time change retry (Exposure)	Capture is performed for the same bank by changing the exposure time in steps. p.36
	Simple retry (Normal)	Capture is performed the specified number of times for the same bank. p.36
Automatic bank switch retry (Bank Switching)		Capture is performed continuously by switching from one bank to another.

## Setting the Bank Switching Retry Function

### 1. Switch to the setting mode.

Hold down the center button for more than two seconds to activate the setting mode.

“Changing Settings” p.24

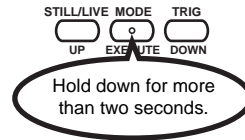

### 2. Select [System Setting] → [Bank Switch] from [Setting Menu].

### 3. Make the desired bank switch settings.

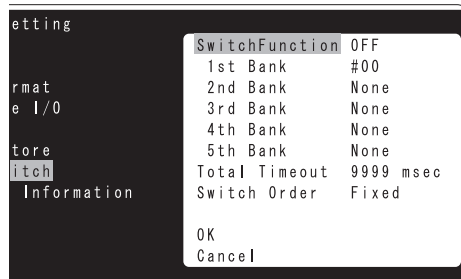

### 4. Confirm the settings.

Select [OK] to confirm the settings. This will bring you to the operation menu.

If you select [Cancel], the operation menu will reappear without reflecting the settings.

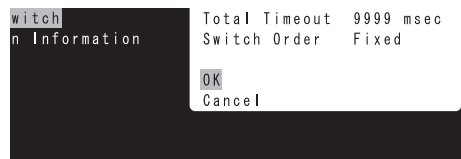

**5.** Save the settings.

Select [Save] from [Setting Menu] to save the settings.

 p.56

Setting item	Settings	Details
Switch Function	OFF*/ON	If [ON] is selected, the bank will be switched from one to another as specified.
1st Bank 2nd Bank 3rd Bank 4th Bank 5th Bank	1st Bank: #00 to #09 (*#00) Other: #00 to #09, None*	Select the reading conditions to be switched. No reading condition will be selected if [None] is selected.
Total Timeout	1000 to 9999 (9999*)	Set the time at which reading is to be stopped following start of bank switch retry in case of reading failure.
Switch Order	Select the reading condition switching method.	
	Auto*	The switching order is determined automatically based on the frequency of use.
	Fixed	Banks will be switched in the order they have been registered, starting from [1st Bank].

# Section 3

## Setting RS-232C and Discrete I/O Communication Conditions

This section explains how to set RS-232C and discrete I/O communication conditions.

▣	Setting RS-232C Communication Conditions	44
	Setting Communication Conditions	44
	Setting the Data Format	46
▣	Setting Discrete I/O Communication Conditions	48

# Setting RS-232C Communication Conditions

This section explains how to set RS-232C communication conditions and data format.

## Setting Communication Conditions

Set RS-232C communication conditions as follows.

### 1. Switch to the setting mode.

Hold down the center button for more than two seconds to activate the setting mode.

 "Changing Settings" p.24

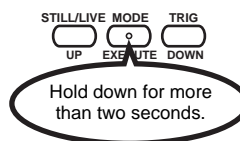

### 2. Select [System Setting] → [RS-232C] from [Setting Menu].

The RS-232C setting menu will appear.

### 3. Make the desired changes to the settings.

### 4. Confirm the changes.

Select [OK] to confirm the changes made to the [RS-232C] settings. This will bring you to the operation menu.

If you select [Cancel], the operation menu will reappear without reflecting the changes.

### 5. Save the settings.

Select [Save] from [Setting Menu] to save the settings.

 p.56

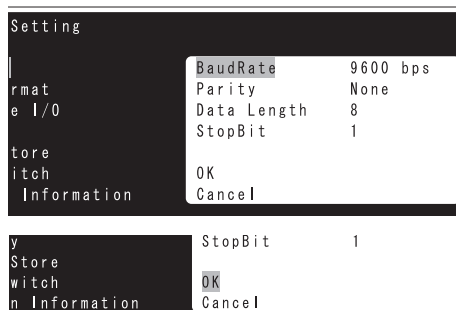

Setting item	Settings	Details
Baud Rate	9600*/19200/38400/ 57600/115200	Select the desired baud rate (bps).  Baud rates exceeding 20 kbps are not defined in the RS-232C standards. Therefore, if [38400 bps] or higher baud rate is selected, communications may be unreliable depending on the cable length. <b>CHECK!</b> If there are problems with communications, a baud rate of [19200 bps] or below must be used.
Parity	Select the desired parity. Parity is used to detect data failure.	
	None*	No parity will be used.
	Odd	Odd parity will be used.
	Even	Even parity will be used.
Data Length	8*/7	Select the data length to be used. The data length is the number of bits required to send one character.
Stop Bit	1*/2	Select the stop bit length to be used. The stop bit indicates the end of data.

The default settings are indicated with an asterisk (\*).



Make the communication settings as follows when using save or load command (e.g. CB, CU).

**Parity:** None, **Data Length:** 8, **Stop Bit:** 1

 p.71

## Setting the Data Format

Set the RS-232C data format as follows.

### 1. Switch to the setting mode.

Hold down the center button for more than two seconds to activate the setting mode.

 "Changing Settings" p.24

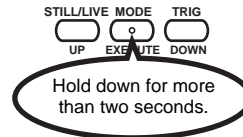

### 2. Select [System Setting] → [Data Format] from [Setting Menu].

The [Data Format] setting menu will appear.

### 3. Make the desired changes to the settings.

 "Description of Format" p.63

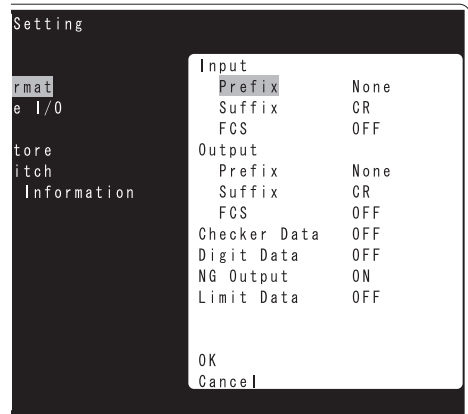

### 4. Confirm the changes.

Select [OK] to confirm the changes made to the [Data Format] settings. This will bring you to the operation menu.

If you select [Cancel], the operation menu will reappear without reflecting the changes.



### 5. Save the settings.

Select [Save] from [Setting Menu] to save the settings.

 p.56



Setting item	Settings	Details
Input	Set the basic input format items.	
Output	Set the basic output format items.	
Prefix	None*/STX/ESC	Select the symbol that indicates the beginning (header) of the command format. No symbol will be selected if [None] is selected.
Suffix	CR*/CR+LF/ETX/LF	Select the symbol that indicates the end (footer) of the command format.
FCS	OFF*/ON	Select whether to use the frame check sequence to detect data input/output errors. Use of FCS will improve communication reliability.  "FCS Check Program Example (BASIC)" p.104
Checker Data	OFF*/ON	Select whether to add a value that indicates the code quality when the data is output.
Digit Data	Select whether to add a value that indicates the number of read data digits when the data is output.	
	OFF*	No value will be added.
	ON 2Byte	A 2-byte value will be added.
	ON 4Byte	A 4-byte value will be added.
NG Output	OFF/ON*	Select whether to output an error code when reading fails.
Limit Data	OFF*/ON	Set the read data output range. If [ON] is selected, the settings made for [Start Point] and [End Point] will be effective.
Start Point	001 to 999 (001*)	Enter the start digit position.
End Point	001 to 999 (999*)	Enter the end digit position.

The default settings are indicated with an asterisk (\*).

# Setting Discrete I/O Communication Conditions

This section explains the procedure of setting the input/output of discrete I/O.

## 1. Switch to the setting mode.

Hold down the center button for more than two seconds to activate the setting mode.

 "Changing Settings" p.24

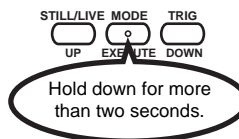

## 2. Select [System Setting] → [Discrete I/O] from [Setting Menu].

The [Discrete I/O] setting menu will appear.

## 3. Make the desired changes to the settings.

## 4. Confirm the changes.

Select [OK] to confirm the changes made to the [Discrete I/O] settings. This will bring you to the operation menu. If you select [Cancel], the operation menu will reappear without reflecting the changes.

## 5. Save the settings.

Select [Save] from [Setting Menu] to save the settings.

 p.56

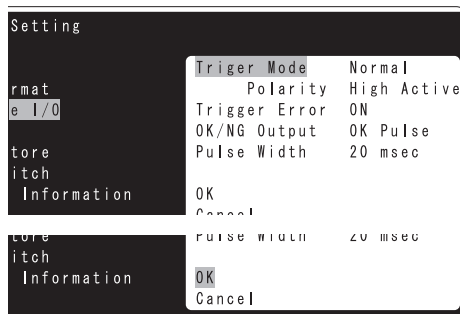

Setting item	Settings	Details
Trigger Mode	Select how to use the trigger signal for discrete I/O.	
	One Shot*	Reading is performed once at the rise of trigger signal (OFF → ON). If reading is successful, it will be exited and the reading results will be output. Since the trigger signal is synchronized with the camera shutter input, shooting of moving workpieces can be performed at accurate positions.
	Level	Reading is repeated while the trigger signal is ON, until reading is successful. If reading is not successful, "NG" will be output when the trigger signal is turned OFF.
	Continuous	Reading is performed continuously while the trigger signal is ON.
Trigger Error	Select whether to output a discrete I/O error when a trigger is received during BUSY.	
	ON*	A discrete I/O error will be output when a trigger is received during BUSY.
	OFF	No discrete I/O error will be output even if a trigger is received during BUSY.
Polarity	Set the trigger signal active polarity.	
	Low Active*	The trigger signal is active when it is low.
	High Active	The trigger signal is active when it is high.
OK/NG Output	Select the OK/NG signal output method.	
	OK Pulse*	A pulse signal will be output when reading is successful.
	NG Pulse	A pulse signal will be output when reading fails.
	Level Output	Outputs OK/NG at low/high levels.
Pulse Width	10 to 100 (10*)	Specify the width (msec) of the pulse signal if a pulse signal is to be output.

The default settings are indicated with an asterisk (\*).

MEMO

# Section 4

## Other Settings

This section explains how to set screen display, operate images read in the past, save and initialize settings of the V400-F.

☒	Setting Screen Display	52
☒	Viewing the Images Read in the Past	53
	Viewing Stored Images	53
	Selecting the Images to be Stored	55
☒	Saving/Initializing All the Settings	56
	Saving All the Settings	56
	Initializing All the Settings	57
☒	Displaying the Version Information	58

# Setting Screen Display

Set how the reading results and standby state are to be displayed.

## 1. Switch to the setting mode.

Hold down the center button for more than two seconds to activate the setting mode.

"Changing Settings" p.24

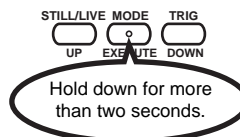

## 2. Select [System Setting] → [Display] from [Setting Menu].

The [Display] menu will be displayed.

## 3. Select the desired display mode.

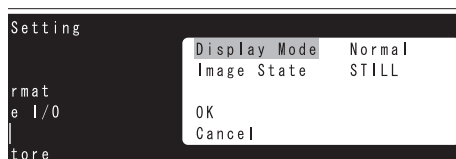

Setting item	Settings	Details
Display Mode	Select the reading result display method.	
	Normal*	Normal display
	Checker	Displays analysis result of code quality numerically and graphically (bar).
	COM Monitor	This screen displays the RS-232C communication history.
	Emphasis	Highlights the reading state.
Image State	Select how the standby state is to be displayed at completion of start-up.	
	STILL*	Displays a still image.
	LIVE	Displays a real-time image.

The default settings are indicated with an asterisk (\*).

## 4. Select [OK] to close the [Display] menu.

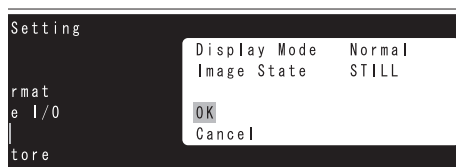

The [System Setting] menu will be displayed.

# Viewing the Images Read in the Past

This section explains how to view the images that were read in the past and stored in the reader temporarily. This will help you analyze the causes of reading failures.

Up to 28 images can be stored in the reader. If more than 28 images are taken, the stored images will be replaced with new ones, starting from the oldest image. These images will be deleted when the power is turned OFF.

## Viewing Stored Images

View the images that were read in the past and stored in the reader temporarily.

### 1. Switch to the setting mode.

Hold down the center button for more than two seconds to activate the setting mode.

 "Changing Settings" p.24

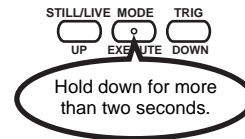

### 2. Select [System Setting] → [Image Store] → [Refer to Image] from [Setting Menu].

The [Reference] screen will be displayed.

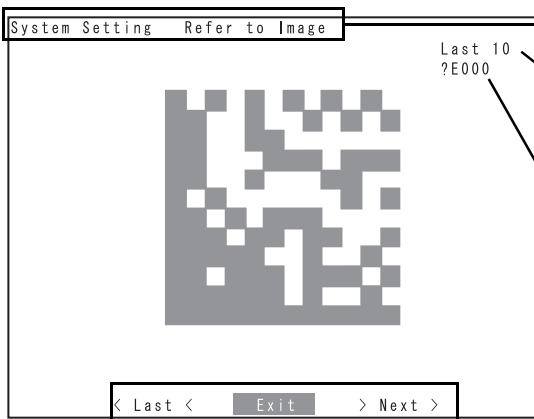

#### Menu name

Displays the name of the currently selected menu and the name of the upper hierarchical level.

#### Saved image No.

Image Nos. (Last 00 to 27) are assigned to the images, starting from the latest image.

For instance, when a new image is taken, the image "Last00" will change to "Last01".

#### Status display

Displays an error code or reading status.

#### Guidance

Displays the operating method in brief.

### 3. Press the left or right button to select a saved image.



## Section 4 Other Settings

4. After you have viewed the desired image, press the center button to close the [Refer to Image] screen.

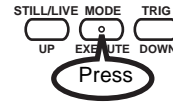

The [Image Store] menu will be displayed.

5. Select [Cancel] to close the [Image Store] menu.

If the current setting for [Store Mode] is satisfactory, select [OK] to close the menu.

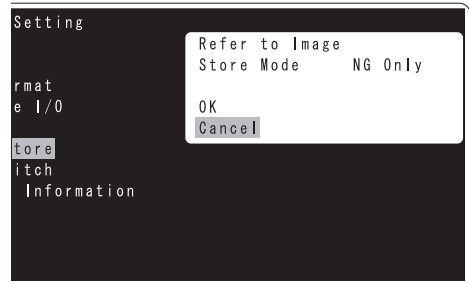

The [System Setting] menu will be displayed.



## Selecting the Images to be Stored

Select the read images to be stored in the reader temporarily.

### 1. Switch to the setting mode.

Hold down the center button for more than two seconds to activate the setting mode.

 "Changing Settings" p.24

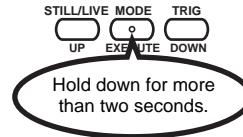

### 2. Select [System Setting] → [Image Store] → [Store Mode] from [Setting Menu].

### 3. Select the images to be stored.

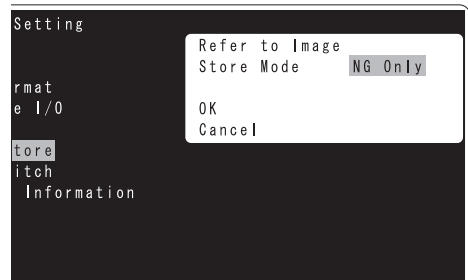

Setting item	Settings	Details
Store Mode	NG only*	Only the reading-failed images will be stored.
	All	All the images will be stored.

The default settings are indicated with an asterisk (\*).

### 4. Select [OK] to close the [Image Store] menu.

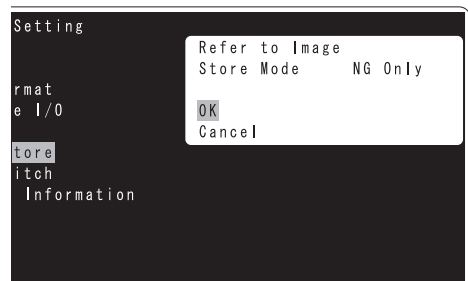

▼  
The [System Setting] menu will be displayed.

# Saving/Initializing All the Settings

This section explains how to save all the settings including reading conditions and system settings, as well as initializing them to the factory settings.

## Saving All the Settings

Save all the settings including reading conditions and system settings to the internal ROM as follows. Once they are saved to the internal ROM, they will not be deleted even if the power is turned OFF.

### 1. Switch to the setting mode.

Hold down the center button for more than two seconds to activate the setting mode.

 "Changing Settings" p.24

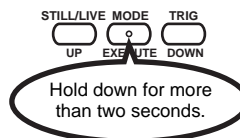

### 2. Select [Save] from [Setting Menu].

▼  
A confirmation menu will appear.

### 3. Select [OK].

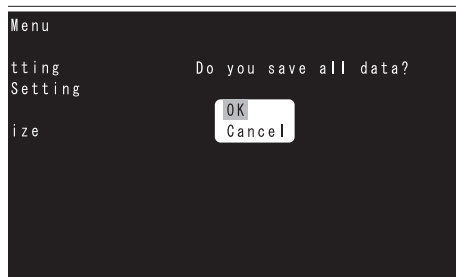

▼  
All the settings will be saved, and the [Setting Menu] will reappear.

## Initializing All the Settings

Reset all the settings including reading conditions and system settings to the factory settings as follows.



To initialize reading conditions individually, select [Delete] from the [Bank Setting] menu.

p.40

### 1. Switch to the setting mode.

Hold down the center button for more than two seconds to activate the setting mode.

"Changing Settings" p.24

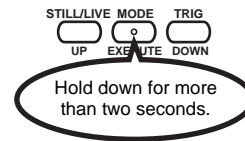

### 2. Select [Initialize] from [Setting Menu].

▼  
A confirmation menu will appear.

### 3. [Select [OK].



▼  
All the settings will be initialized to the factory settings, and the [Setting Menu] will reappear.

# Displaying the Version Information

Display the software version as follows.

## 1. Switch to the setting mode.

Hold down the center button for more than two seconds to activate the setting mode.

 "Changing Settings" p.24

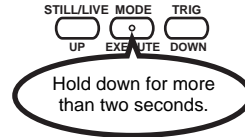

## 2. Select [System Setting] → [Version Information] from [Setting Menu].

▼  
The version information appears.

## 3. Select [Exit].

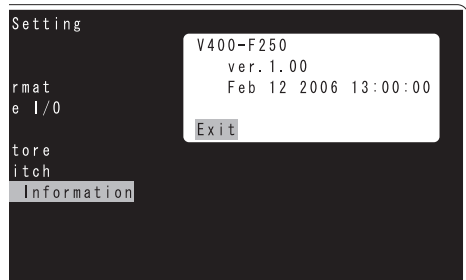

▼  
The [System Setting] menu will reappear.

# Section 5

## Communicating with PC and Programmable Controller

This section explains the commands required to make a connection and communicate with a PC or programmable controller via RS-232C or discrete I/O.

☒ RS-232C Communication	60
Wiring Diagram	60
List of Commands	62
☒ Discrete I/O Communication	73
Internal Specifications	74
Description of I/O Terminals	75
Timing Charts	76

# RS-232C Communication

It is possible to input a reading trigger and output reading results via RS-232C.

This section explains connecting method and commands.

For the setting method of communication mode and conditions, refer to "Setting Communication Conditions" (p.44).

## Wiring Diagram

### ■ PC

A D-SUB 9-pin connector (female) is used for the cable type V400-W24 (NPN type) and V400-W24P (PNP type). The connector is compatible with the connection port on the DOS/V PC.

2D code reader  
V400-F050/250/350



Cable  
V400-W24 (NPN type)  
V400-W24P (PNP type)

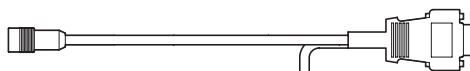

Power supply device  
24VDC

Recommended: OMRON  
S8VS-03024

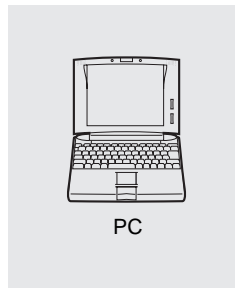

PC

2D code reader V400-F050/250/350 Special round connector	
Name	
SD	
RD	
+24V	
GND	
TRIG	
RESET	
RUN	
OK/NG	
ERROR	
BUSY	

Not used with RS-232C communication.

DOS/V PC D-sub, 9-pin	
Name	Pin No.
-	1
RD	2
SD	3
ER	4
SG	5
DR	6
RS	7
CS	8
-	9
Shield wire	Connector cover

← +24 V (Brown)  
← 0 V (Blue)

- ← TRIG (Pink)
- ← RESET (Orange)
- ← RUN (Green)
- ← OK/NG (Black)
- ← ERROR (Gray)
- ← BUSY (Yellow)

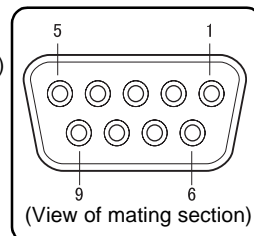

■ **Programmable Controller**

A D-SUB 9-pin connector (male) is used for the cable type V400-W23 (NPN type) and V400-W23P (PNP type). The connector is compatible with the connection port on OMRON CJ-series and CS-series Programmable Controller.

2D code reader  
V400-F050/250/350



Cable  
V400-W23 (NPN type)  
V400-W23P (PNP type)

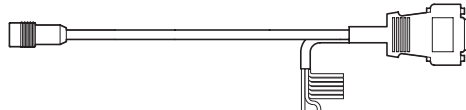

Power supply device  
24VDC  
Recommended: OMRON  
S8VS-03024

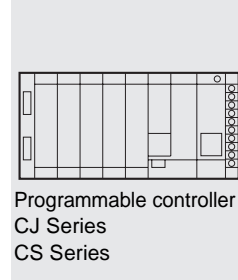

Programmable controller  
CJ Series  
CS Series

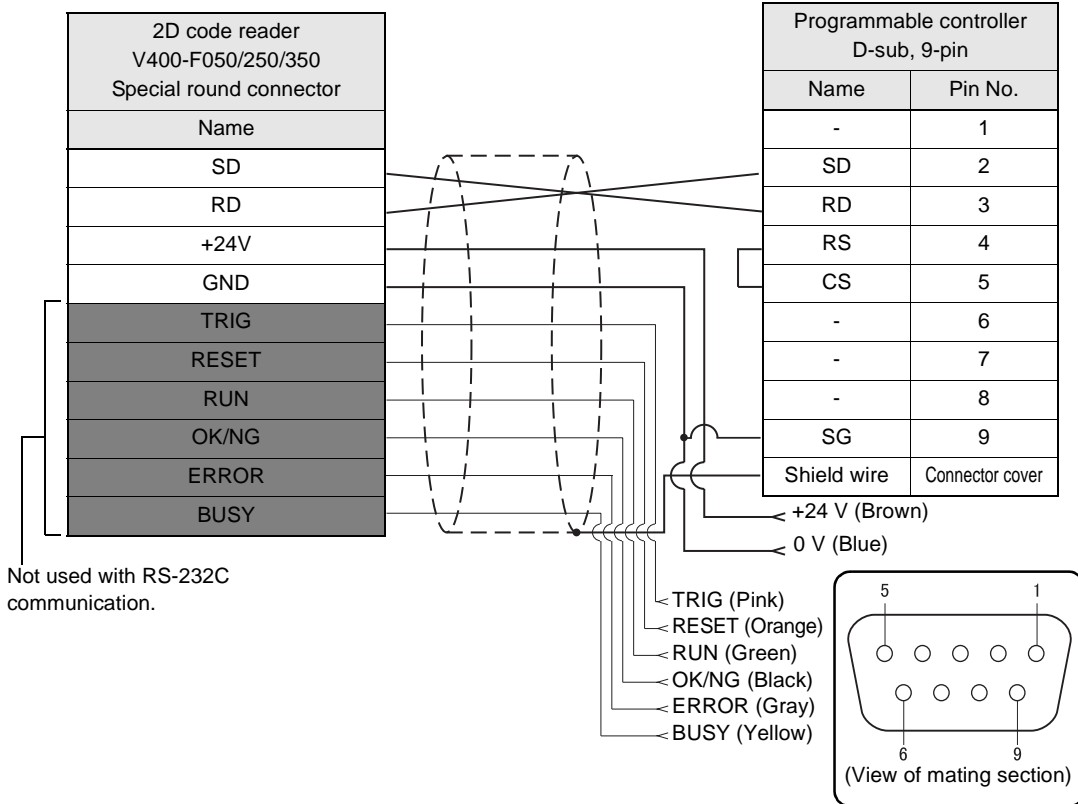

Not used with RS-232C communication.

## List of Commands

Communication is carried out via RS-232C using the following commands while the reading screen is active.

### ■ Commands that Control Controller Operations

Use the following commands to instruct the controller to perform certain operations, such as executing reading and switching reading condition.

Command	Function	Page
GL	Performs one reading.	p.64
GO	Performs a level trigger.	p.64
SO	Stops the level trigger.	p.64
GC	Performs continuous reading.	p.65
SC	Stops continuous reading.	p.65
RD	Outputs the previous send data (polling).	p.65
DC	Switches the image display mode (still image/real-time image).	p.66
GM	Switches the currently used trigger mode.	p.67
SN	Confirms/switches reading condition.	p.68
GT	Performs teaching.	p.68
LC	Switches the light to be turned ON from one to another.	p.69
LT	Adjusts the exposure time.	p.70
FT	Performs teaching without changing the exposure time.	p.70
VR	Checks the software version.	p.71

### ■ Commands that Save and Load Data

Use the following commands to back up the settings you made to the code reader or PC.

Command	Function	Page
CB	Backs up the setting data to the PC.	p.71
CU	Loads the setting data from the PC.	p.71
SV	Saves the setting data to the flash memory.	p.72



## ■ Description of Format

Commands must be input in ASCII code. They can be input in either upper-case or lower-case.

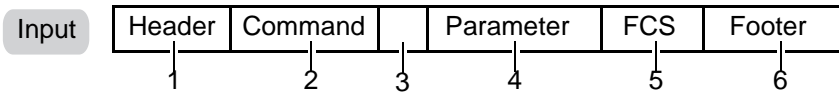

No.	Item	Number of characters	Settings
1	Header (Prefix)	1	Enter the symbol that indicates the beginning of the command format. This item is not available if [None] is selected for [Prefix] setting mode. p.47
2	Command	2	These characters indicate the operation content.
3	Space	1	A space must be inserted between the command (2) and parameter (4).
4	Parameter	Not fixed	This parameter needs to be specified depending on the command (3). If needed, enter a numerical value.
5	FCS (Frame check sequence)	2	Specify the FCS to be used. This item is not available if [OFF] is selected for [FCS] setting mode. p.47
6	Footer(Suffix)	1 to 2	Enter the symbol that indicates the end of the command format. p.47



In the explanation of the format for each command, only the items “command (2)” to “parameter (4)” are given.

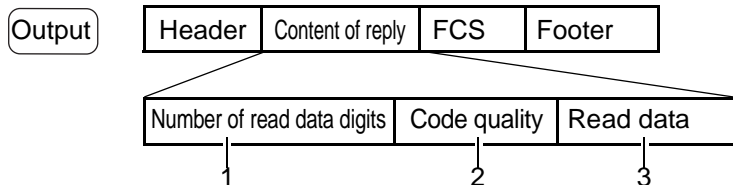

- In the explanation of the format for each command, only “content of reply” when a command is executed correctly is given.
- The content of reply when a command is not executed will be E R.

No.	Item	Number of characters	Settings
1	Number of read data digits (Digit Data)	2 or 4	Returns the number of reading data digits. The number of characters must be set in [Digit Data] of the setting mode. This item is not available if [OFF] is set. p.47
2	Code quality (Checker Data)	12	Returns the code quality of the read data. This item is not available if [OFF] is selected for [Checker Data] setting mode. p.47
3	Read data	Depends on the read data.	Returns the read data.

## ■ Data Format for Each Command

### GL

---

Function... Performs one reading.

Reading is executed with the retry condition that is set when a trigger is input.

“Number of read data digits” and “Code quality” are output only if they are set.

 p.47

Input

G	L
---	---

Output

- When reading is successful

Read data
-----------

- When reading has failed

?	Error Code
---	------------

### GO

---

Function... Execute a level trigger.

“Number of read data digits” and “Code quality” are output only if they are set.

 p.47

Input

G	O
---	---

Output

- When reading is successful

Read data
-----------

- When reading has failed

?	Error Code
---	------------

Reading is repeated until it is successful.

### SO

---

Function... Stops the level trigger.

This command is effective only when a level trigger is being executed.

Input

S	O
---	---

Output

O	K
---	---

## GC

---

Function... Performs continuous reading.

“Number of read data digits” and “code quality” are output only if they are set.

 p.47

Input

G	C
---	---

Output

- When reading is successful

Read data
-----------

- When reading has failed

?	Error	Code
---	-------	------

Data is output each time reading is executed.

## SC

---

Function... Stops continuous reading.

This command is effective only when a continuous trigger is being executed.

Input

S	C
---	---

Output

O	K
---	---

## RD

---

Function... Outputs the previous send data. (Polling command)

Use this command to resend data that has been lost due to communication error.

Input

R	D
---	---

Output

- When reading is successful

Read data
-----------

- When reading has failed

?	Error	Code
---	-------	------

DC

Function 1... Checks the monitor image display mode (still image/real-time image).

Input 

D	C
---	---

Output 

O	K	Image display state
---	---	---------------------

Image display state	Details
0	Switches to still image.
1	Switches to real-time image.

Function 2... Switches the monitor image display mode (still image/real-time image).

Input 

D	C	Image display state
---	---	---------------------

Enter the image display state.

Image display state	Details
0	Switches to still image.
1	Switches to real-time image.

Output 

O	K
---	---

## GM

---

Function 1... Checks the currently used trigger mode.

Input 

G	M
---	---

Output 

O	K	Trigger mode
---	---	--------------

Function 2... Switches the trigger mode.  
Only the mode is switched (no trigger is input).

Input 

G	M		Trigger mode
---	---	--	--------------

Set the desired trigger mode as shown below.

Trigger mode	Details
0	One-shot trigger
1	Continuous trigger
2	Level trigger

Output 

O	K
---	---



CHECK!

If the level trigger is selected, error code for reading failure will not be output.

**SN**

---

Function 1... Checks the currently used reading condition No. (Bank #00 to #09).

Input 

S	N
---	---

Output 

O	K		Reading condition No.
---	---	--	-----------------------

---

Function 2... Switches the reading condition No. (Bank #00 to #09) to be used.

Input 

S	N		Reading condition No.
---	---	--	-----------------------

Set a reading condition No. (0 to 9).

Output 

O	K
---	---

---

**GT**

---

Function... Performs teaching.

Input 

G	T		Reading condition No.
---	---	--	-----------------------

Set a reading condition No. (0 to 9).  
 If no reading condition No. is specified, the currently used bank will be overwritten with the teaching results.

Output

- When teaching is successful

O	K
---	---

- When teaching has failed

?	Error Code
---	------------

---

## LC

Function 1... Checks the lighting state.

Input

L	C
---	---

Output

O	K	Lighting state
---	---	----------------

Lighting state	Details	
	For V400-F050	For V400-F250/350
0	The light connected to the left connector (L) is ON.	The light is ON.
1	The light connected to the right connector (R) is ON.	The light is OFF.
2	The light is OFF.	The light is OFF.

Function 2... Switches the light to be turned ON from one to another.

Input

L	C	Light
---	---	-------

Specify the light to be turned ON.

Light	Details	
	For V400-F050	For V400-F250/350
0	Turns ON the light connected to the left connector (L).	Turns ON the light.
1	Turns ON the light connected to the right connector (R).	Turns OFF the light.
2	Turns OFF the light.	Turns OFF the light.

Output

O	K
---	---

## LT

---

Function 1... Checks the exposure time.

Input

L	T
---	---

Output

O	K	Exposure time
---	---	---------------

The exposure time is output with a 4-digit numerical value at 1/100 msec.  
 If the exposure time is set automatically, "OK AUTO" is output.

Example: When the exposure time is 5.47 msec.

OK 0547

---

Function 2... Adjusts the exposure time.

Input

L	T	Exposure time
---	---	---------------

Enter the exposure time with a 4-digit numerical value.

To automatically set the exposure time, enter "LT AUTO".

Output

O	K
---	---



The value specified with the LT command causes a difference of max. 0.04 msec. However, it will not affect the reading process.

CHECK!

## FT

---

Function... Performs teaching without changing the exposure time.

The exposure time is fixed to the currently set value.

Input

F	T	Reading condition No.
---	---	-----------------------

Specify the reading condition No. between 0 and 9.

If no reading condition No. is specified, the currently used bank will be overwritten with the teaching results.

Output

- When teaching is successful

O	K
---	---

- When teaching has failed

?	Error Code
---	------------



## VR

Function... Checks the version information.

Input V R

Output 1 . 0 0

\* The above value is given as an example.

## CB

Function... Backs up the setting data to the PC.

Input C B      Backup source

Specify the data to be backed up.

Backup source	Details
AL	All data
SY	System data
BK	All reading condition data
B0 to 9	Corresponding reading condition data
00 to 27	Corresponding image No.

Output R E A D Y

After "READY" is output, the main unit switches to XMODEM communication automatically, and outputs O K when communication is completed successfully.

## CU

Function... Loads the setting data from the PC.

Input C U      Upload source

Specify the data to be uploaded from the PC.

Upload source	Details
AL	All data
SY	System data
BK	All reading condition data
B0 to 9	Corresponding reading condition data
00 to 27	Corresponding image No.

Output R E A D Y

After "READY" is output, the controller switches to XMODEM communication automatically, and outputs O K when communication is completed successfully.

## SV

---

Function... Saves the reading conditions and system settings to the flash memory of the reader.

Input 

S	V
---	---

Output 

O	K
---	---

# Discrete I/O Communication

It is possible to execute reading from the programmable controller and output reading result (OK/NG) via discrete I/O.

For the setting method of communication mode and conditions necessary to communicate via discrete I/O, refer to “Setting Discrete I/O Communication Conditions” (p.48).

## ■ Connecting Diagram

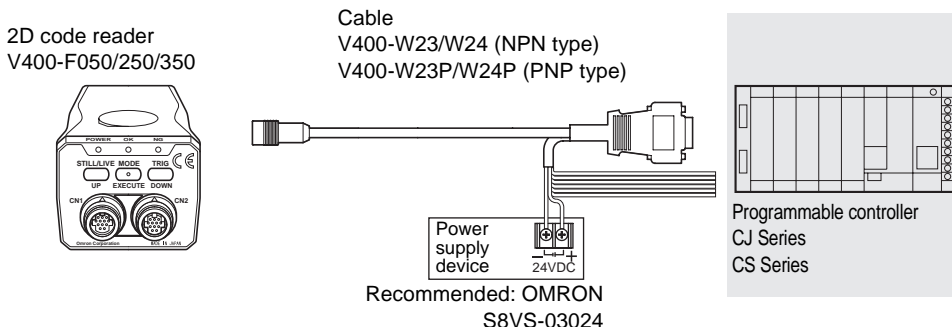

## ■ Cable Wiring

Cable and signal assignment on the main unit are shown below. Just wire only necessary terminals.

2D code reader V400-F050/250/350 Special round connector		Discrete I/O
Name	Description	Wire color
TRIG	Input signal: Reading trigger signal	Pink
RESET	Input signal: Restart	Orange
RUN	Output signal: Output while the reading screen is displayed.	Green
OK/NG	Output signal: (OK) (reading is successful) or (NG) (reading fails) is output.	Black
ERROR	Output signal: Output when an error occurs.	Gray
BUSY	Output signal: Output while processing is in progress.	Yellow

\* The brown and blue wires must be connected to the power supply device.

## Internal Specifications

### Input specifications

Item	Specifications	
Cable model	V400-W23/24 (NPN type)	V400-W23P/24P (PNP type)
Input voltage	12 to 24V $\pm$ 10%	
Input ON current *1	5 to 15 mA	
Input ON voltage *1	7 V min.	
Input OFF current *2	0.1 mA max.	
Input OFF voltage *2	5 V max.	
Input ON delay	RESET: 10 msec max.	
	TRIG: 0.5 msec max.	
Input OFF delay	RESET: 15 msec max.	
	TRIG: 0.5 msec max.	
Internal circuit diagram		

**\*1: ON current/ON voltage**

This refers to the current or voltage values needed to shift from the OFF  $\rightarrow$  ON state.  
The ON voltage value is the following potential difference.

- NPN type: Potential difference between 24 V terminal and input terminal
- PNP type: Potential difference between input terminal and GND terminal

**\*2: OFF current/OFF voltage**

This refers to the current or voltage values needed to shift from the ON  $\rightarrow$  OFF state.  
The OFF voltage value is the following potential difference.

- NPN type: Potential difference between 24 V terminal and input terminal
- PNP type: Potential difference between input terminal and GND terminal

### Output specifications

Item	Specifications	
Cable model	V400-W23/24 (NPN Type)	V400-W23P/24P (PNP Type)
Output voltage	12 to 24 V $\pm$ 10%	
Output load current	45 mA max.	
ON residual voltage	1.5 V max.	
OFF leakage current	0.1 mA max.	
Internal circuit		

## Description of I/O Terminals

Terminal		Description
Input	TRIG	Inputs a reading trigger from a photoelectric sensor etc. Make sure that the TRIG is ON for at least 0.5 ms. The interval at which the TRIG can be input depends on the reading time. The BUSY signal is output during reading process to disable input of the TRIG.
	RESET	Resets the controller.
Output	RUN	This signal is ON while V400-F050/250/350 is active.
	OK/NG	Outputs OK when reading is successful, and outputs "NG" when reading has failed. It is also possible to specify whether the signal is to be output when reading is successful or when reading has failed.  p.49
	ERROR	This signal is turned ON when an error occurs.
	BUSY	This signal is turned ON while the controller is performing reading. TRIG and commands will not be accepted while the BUSY signal is ON.

## Timing Charts

### ■ When [One Shot] is Selected as Trigger Mode and [OK Pulse] is Selected for [OK/NG Output]

The OK/NG signal is not output when reading has failed.



- If [NG Pulse] is selected for [OK/NG Output], the OK/NG signal will not be output when reading is successful.
- If [OFF] is selected for [NG Output], no outputs will be made via RS-232C when reading has failed.

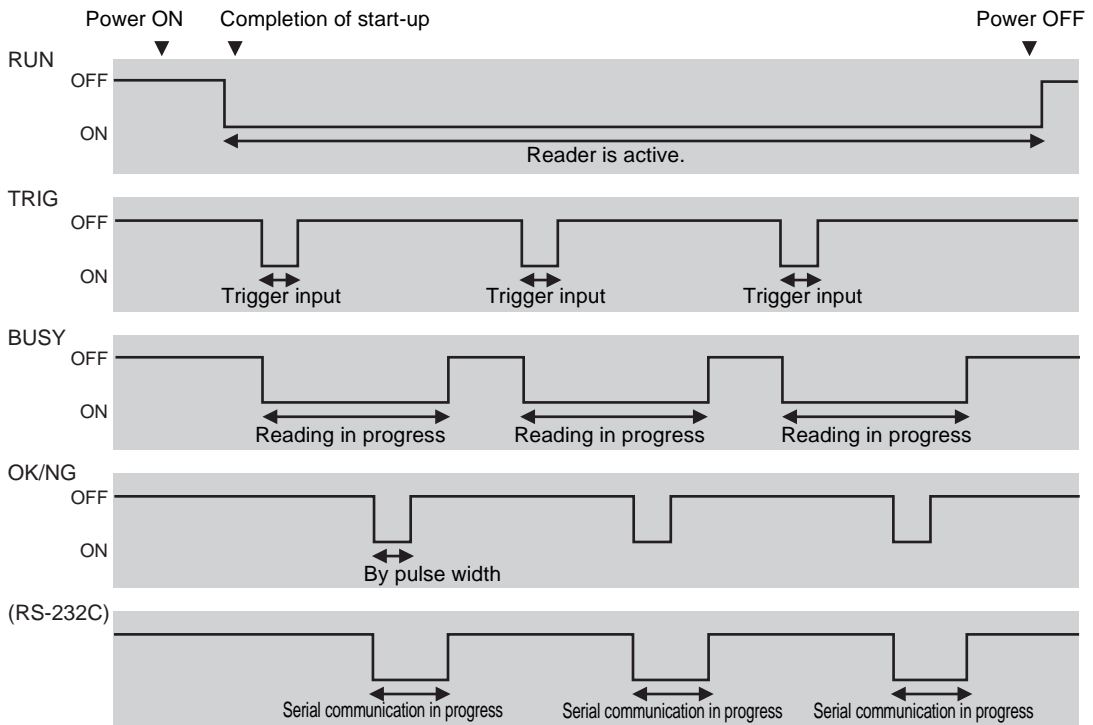

■ When [One Shot] is Selected as Trigger Mode and [Level] is Selected for [OK/NG Output]

The OK and NG signals are expressed as level signals.

The signals are input when the BUSY signal switches from ON to OFF.



If [OFF] is selected for [NG Output], no outputs will be made via RS-232C when reading has failed.

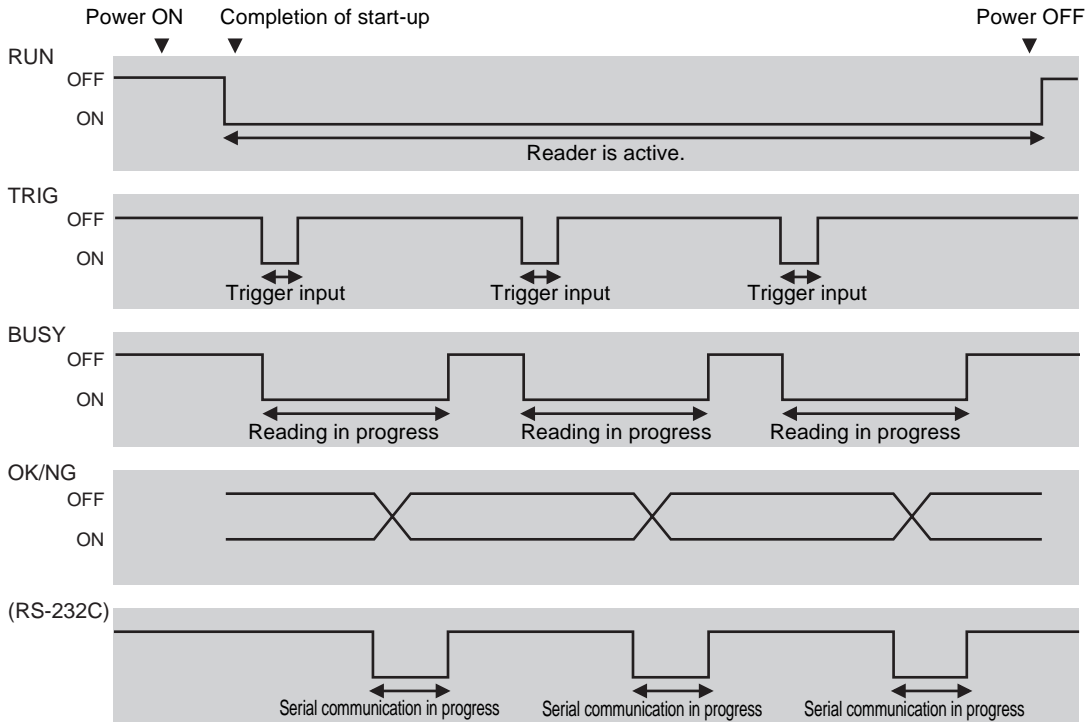

If [Level] is selected for [OK/NG Output], this signal is turned ON/OFF to indicate the reading result (i.e. whether reading is successful or has failed).

The signal is ON when reading is successful, and it is OFF when reading has failed.

■ When [Level] is Selected as Trigger Mode and [OK Pulse] is Selected for [OK/NG Output]

Reading is repeated while the TRIG signal is ON until reading is successful, and reading is exited when it is successful.

Therefore, this setting executes one output per trigger input.

If the TRIG signal is turned OFF before reading is successful, reading failure will result.



Even if an item other than [NG Pulse] is selected for [OK/NG Output], this signal will perform the same operation as when [One Shot] is selected.

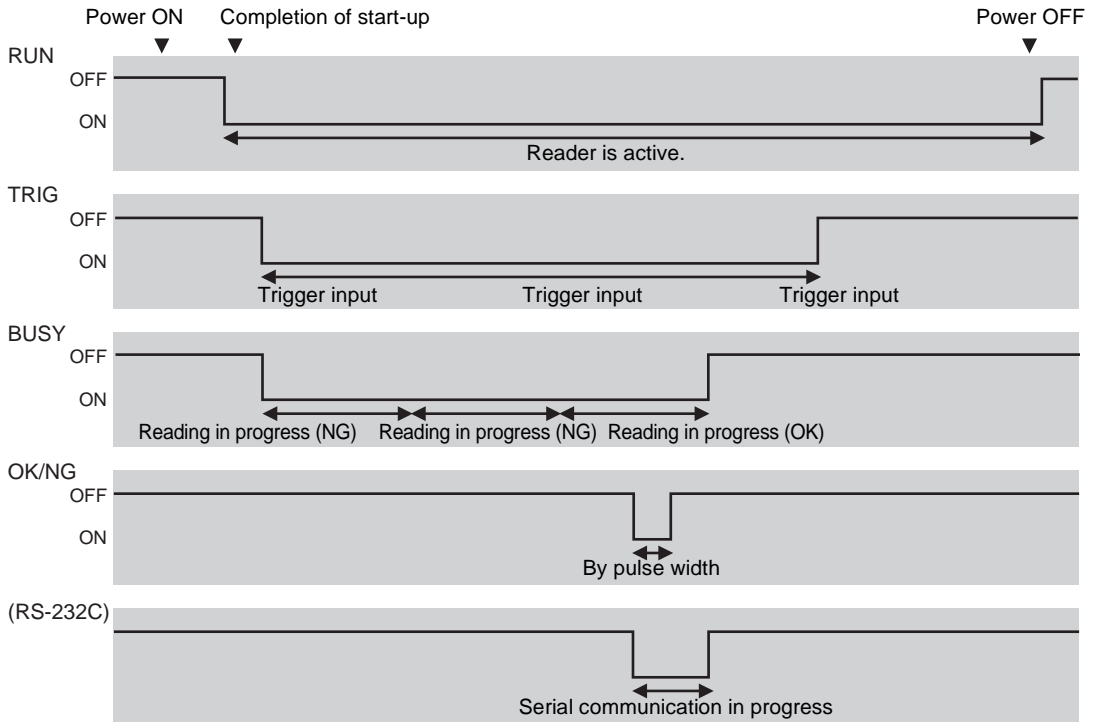



■ When [Continuous] is Selected as Trigger Mode and [OK Pulse] is Selected for [OK/NG Output]

Reading and result output are repeated while the TRIG signal is ON.  
The BUSY signal will remain ON while reading is executed repeatedly.



With this setting, correct detection is not possible if [Level] is selected for [OK/NG Output]. Set [OK Pulse] or [NG Pulse] for [OK/NG Output].

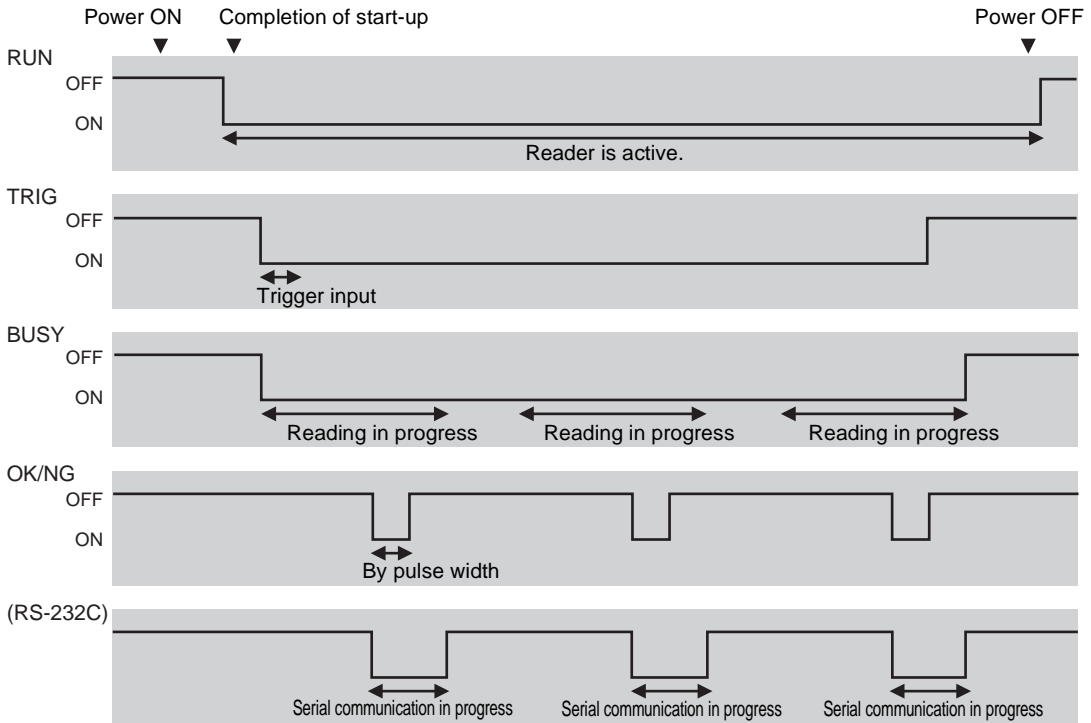

MEMO

# Section 6

## Troubleshooting

This section explains the countermeasures to take when reading cannot be executed correctly or when a problem occurs.

☒ Error Codes and Corrective Actions	82
☒ Troubleshooting	82
Connection Errors	82
Reading Errors	82
Discrete I/O Errors	83
RS-232C Errors	83

# Error Codes and Corrective Actions

This section lists the error codes that may be displayed on the screen when reading fails, along with their corrective actions. They are given in error code order.

Error Code	Action
?E000	2D code cannot be found, possibly due to uneven background. Check the workpiece surface and lighting condition.
?E100	2D code cell cannot be recognized correctly. Check the marking and lighting conditions, and then perform teaching again.
?E200	Reading was not completed within the specified period of time. Check the workpiece and lighting condition, then perform teaching again. Increase the reading timeout value.

## Troubleshooting

### Connection Errors

Symptom	Action	Page
The POWER indicator is not lit.	<ul style="list-style-type: none"> <li>Is the power supply device connected properly?</li> <li>Is power current capacity sufficient?</li> </ul>	p.20
Monitor image is not clear.	<ul style="list-style-type: none"> <li>Is the monitor cable connected correctly?</li> </ul>	p.20
No images are displayed on monitor. (For V400-F050)	<ul style="list-style-type: none"> <li>Is the lens cap removed?</li> <li>Is the lens attached correctly?</li> </ul>	- p.21
No codes are displayed on monitor.	<ul style="list-style-type: none"> <li>Press the left button to switch to the real-time image, or execute teaching and check the image.</li> </ul>	p.22 p.30
No menu is displayed.	<ul style="list-style-type: none"> <li>Hold down the center button for more than two seconds.</li> </ul>	p.24

### Reading Errors

Symptom	Action	Page
Not possible to read, though teaching was successful.	<ul style="list-style-type: none"> <li>Does the teaching condition match the code conditions? Code type Symbol size Mirror status Reverse</li> <li>Check the content of the bank.</li> </ul>	p.30

## Discrete I/O Errors

Symptom	Action	Page
Failed to respond to signals from input terminals.	<ul style="list-style-type: none"> <li>Is the signal cable wired correctly?</li> </ul>	p.73
No signal is output from output terminal.	<ul style="list-style-type: none"> <li>Is the signal cable wired correctly?</li> </ul>	p.73

## RS-232C Errors

Symptom	Action	Page
Cannot communicate.	<ul style="list-style-type: none"> <li>Is the cable connected correctly?</li> <li>Do the communication specifications match those of the host device?</li> <li>Is the correct communication mode selected?</li> </ul>	<p>p.20</p> <p>p.44</p> <p>p.45</p>
Communication status is unknown.	<ul style="list-style-type: none"> <li>Switch to the communication display. Communication status is displayed in the left area of the monitor screen.</li> </ul>	p.52

MEMO

# Appendix

☒ Lens and Lighting	86
Light and Lens V400-F050	86
☒ Line Speed and Reading Time/Exposure Time	91
Exposure Time	91
Reading Time	92
☒ Maintenance	93
Handling the Code Reader	93
Inspection	93
☒ Specifications and Dimensions	94
☒ ASCII Table	99
☒ Ladder Programming Example for Connecting to a PLC	100
☒ FCS Check Program Example (BASIC)	104
☒ Data Capacity Table	106
☒ Menu Hierarchy	109

## Lens and Lighting

Please note that the field of vision and installation distance differ between V400-F250 and V400-F350.

When choosing a lens and light for V400-F050, refer to the explanation given below.

### Light and Lens V400-F050

If V400-F250/350 do not meet the requirements of field of vision and installation distance, use V400-F050, which is a C-mount type and allows connection of an external light. Refer to the following to choose the appropriate light and lens.

#### ■ Lights

The following Moritex lights are recommended.

\* Refer to the following website for details on Moritex products.

<http://www.moritex.co.jp/home/english/index.html>

#### ■ Back lights

A stable, high-contrast image can be obtained.

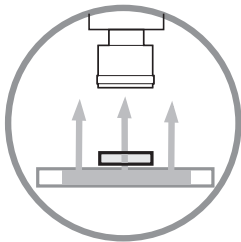

Model	Emitting color	Emitting size
MEBL-CR25	Red	25 x 25
MEBL-CG25	Green	25 x 25
MEBL-CB25	Blue	25 x 25
MEBL-CR50	Red	50 x 50
MEBL-CG50	Green	50 x 50
MEBL-CB50	Blue	50 x 50

#### ■ Reflected lights

Partially reflecting workpieces can be read.

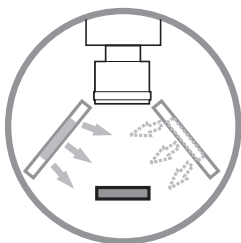

The lights to be used are the same as those used for back lighting.



## ■ Ring lights

Light can be shone uniformly on workpieces.

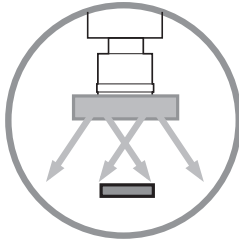

Direct ring light

Model	Emitting color	Inner ring diameter	Outer ring diameter	Emitting angle
MDRL-CR16	Red	Ø16	Ø48	76°
MDRL-CR28	Red	Ø28	Ø50	75°
MDRL-CR31	Red	Ø31	Ø66	75°
MDRL-CR35	Red	Ø35	Ø70	90°

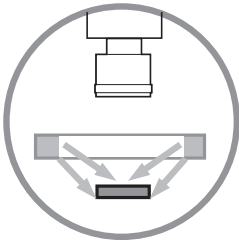

Low-angle ring light

Model	Emitting color	Inner ring diameter	Outer ring diameter	Emitting angle
MLRL-CR48	Red	Ø48	Ø74	30°

## ■ Coaxial light

A stable image can be obtained with few shadows from uneven surfaces on workpieces.

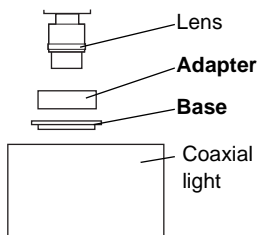
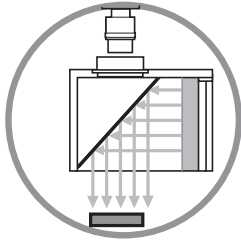

Model	Emitting color	Box height (mm)	Light path extension distance (mm)
MSCL-CR24	Red	24	6.8
MSCL-CG24	Green	24	6.8
MSCL-CB24	Blue	24	6.8
MSCL-CR39	Red	39	1.2
MSCL-CG39	Green	39	1.2
MSCL-CB39	Blue	39	1.2

Attach the following bases and adapters.

Model	Type	Applicable lens
MLA-SCM255	Adapter	M25.5P0.5 lens
MLA-SCM270		M27P0.5 lens
MLA-SCM305		M30.5P0.5 lens
MLA-SCBS	Base	-

### ■ Setting the Field of Vision and Working Distance

Refer to the following formula to calculate the field of vision and working distance.

$$(\text{Code size: } C) + 2 \times (\text{Cell size: } S) < (\text{Field of vision: } A) < 121 \times (\text{Cell size: } S)$$

Number of effective pixels of camera	640 (H) × 480 (V)
Code size	C (mm)
Symbol size	M × M
(Cell size)	S (mm) = C/M 4 pixels/cell required A margin for one cell is required.
Field of vision	Max.: A (mm) = S/4 × 480 Min.: A (mm) = C + S × 1 × 2

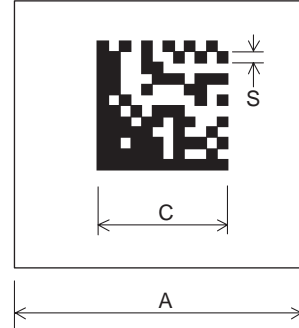

Set an appropriate field of vision with workpiece positioning accuracy taken into account.

Example: When the code size is 3 mm and the symbol size is 12 × 12

- Cell size:  $S = 3/12 = 0.25$  mm
- Max. field of vision:  $0.25/4 \times 480 = 30$  mm
- Min. field of vision:  $3 + 0.25 \times 1 \times 2 = 3.5$  mm

If the positioning accuracy is  $\pm 5$  mm, the field of vision must be set between 13.5 mm or higher and below 30 mm.

## ■ Selecting a Lens

Select a lens according to the required field of vision and working distance between the workpiece and lens.

- The longer the extension tube, the lower the brightness.
- The longer the working distance, the larger the depth of field.
- Make sure that the working distance can be adjusted since there are individual differences among cameras.

## ■ CCTV lens

The following Moritex lenses are recommended.

\* Refer to the following website for details on Moritex products.

<http://www.moritex.co.jp/home/english/index.html>

### CCTV Lenses and Dimensions

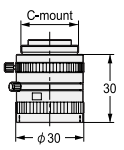
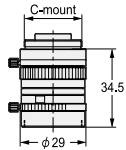
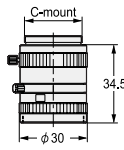
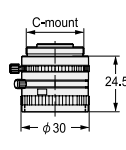
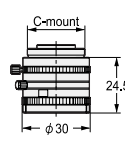
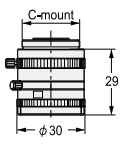
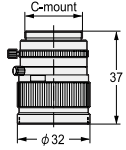
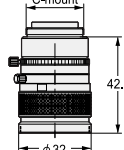
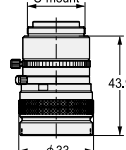
CCTV lens					
Model	ML-0614	ML-0813	ML-1214	ML-1614	ML-2514
External dimensions					
Lock mechanism	With focus/diaphragm lock mechanism				
Mount	C-mount				
Model	ML-3519	ML-5018	ML-7527	ML-10035	
External dimensions					
Lock mechanism	With focus/diaphragm lock mechanism				
Mount	C-mount				

### Extension tube

Model	Configuration
ML-EXR	Thickness: 7 rings/set (0.5 mm, 1 mm, 2 mm, 5 mm, 10 mm, 20 mm, 40 mm)

The table below shows the field of vision and working distance for each lens when an extension tube is attached to the lens.

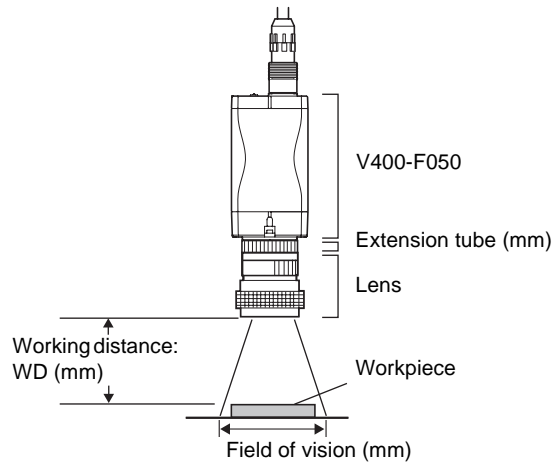

(Unit: mm)

Extension tube (mm)	ML-0614		ML-0813		ML-1214		ML-1614		ML-2514		ML-3519		ML-5018		ML-7527		ML-10035	
	Field of vision	WD	Field of vision	WD	Field of vision	WD	Field of vision	WD	Field of vision	WD	Field of vision	WD	Field of vision	WD	Field of vision	WD	Field of vision	WD
0	124.0	200.0	72.0	147.7	77.0	247.7	81.8	357.8	64.9	457.7	49.1	500.0	67.6	943.0	45.0	1000.0	34.8	1000.0
0.5	44.6 32.8	63.2 43.0	57.4 31.9	115.2 59.0	89.1 41.3	289.2 125.0	116.7 48.1	514.6 206.1	181.2 47.8	1270.0 338.2	251.4 41.1	2458.7 422.1						
1	22.3 18.9	24.8 19.0	28.7 20.5	51.8 33.7	44.6 28.2	135.9 80.0	58.4 34.1	251.8 142.8	90.6 37.8	636.5 268.5	125.7 35.3	1240.0 366.1						
1.5			19.1 15.1	30.6 21.7	29.7 21.4	84.9 56.7	38.9 26.4	164.2 108.2	60.4 31.3	425.3 222.8	83.8 31.0	833.8 323.9	115.1 42.6	1576.5 609.9				
2					22.3 17.3	59.3 42.4	29.2 21.5	120.3 86.3	45.3 26.7	319.7 190.6	62.8 27.6	630.7 290.9	86.3 37.9	1193.0 547.6	138.2 32.3	3188.9 776.1		
5							11.7 10.2	41.5 35.4	18.1 14.2	129.6 103.1	25.1 16.6	265.1 184.8	34.5 22.9	502.6 347.0	55.3 22.6	1421.7 607.0	71.3 20.5	2412.7 724.2
10							5.8 5.4	15.2 14.0	9.1 8.0	66.3 59.6	12.6 10.0	143.2 120.6	17.3 13.8	272.5 225.7	27.6 15.1	832.7 474.7	35.7 14.3	1431.6 608.6
15									6.0 5.5	45.2 42.7	8.4 7.2	102.6 93.0	11.5 9.8	195.8 173.5	18.4 11.4	636.3 408.4	23.8 11.3	1104.6 545.7
20									4.5 4.2	34.6 33.6	6.3 5.6	82.2 77.6	8.6 7.7	157.5 144.5	13.8 9.1	538.2 368.5	17.8 9.2	941.0 505.3
25											5.0 4.6	70.1 67.8	6.9 6.3	134.4 126.0	11.1 7.6	479.2 341.9	14.3 7.8	842.9 478.1
30													5.8 5.3	119.1 113.1	9.2 6.5	440.0 322.8	11.9 6.7	777.5 457.6
35													4.9 4.6	108.1 103.7	7.9 5.7	411.9 308.5	10.2 5.9	730.8 442.6
40													4.3 4.1	99.9 96.5	6.9 5.1	390.9 297.4	8.9 5.3	695.8 430.1
45															6.1 4.6	374.5 288.5	7.9 4.8	668.5 420.7
50															5.5 4.1	361.4 281.3	7.1 4.4	646.7 412.3
60																	5.9 3.7	614.0 400.1

Source: Lenses, lighting, and peripheral devices for image processing catalog from Moritex

Note: Since values shown in the table are calculated values they may differ from actual measured values. They must be used as your reference.

# Line Speed and Reading Time/Exposure Time

The following points must be observed when reading moving workpieces.

- Make sure that the still image display mode is constantly selected.

## Exposure Time

To eliminate image blurring and stabilize reading, refer to the following formula to set the lower limit of exposure time.

$$(\text{Exposure time: } T) \cong \frac{(\text{Moving shift tolerance: } W)}{(\text{Max. line speed: } V)}$$

$$W \cong 0.1 \times \frac{(\text{Code size: } C)}{(\text{Symbol size: } M)}$$

Exposure time	T (s)
Code size	C (mm)
Symbol size	M
Field of vision	A (mm)
Number of image pickup pixels (Moving direction)	N
Pixels/cell	$n = (C \times N)/(A \times M) *1$
Moving shift tolerance	$W = C/M \times 0.1 \text{ (mm)} *2$
Reading time	R (s)
Code pitch	L (mm)
Line speed	V (mm/s)

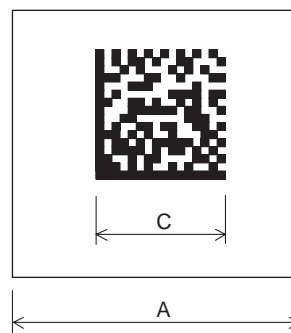

\*1: "Pixels/cell > 4" must be satisfied with sufficient margin taken into account.

\*2: The moving shift tolerance is 10% of the cell size.

Example: When  $V = 60 \text{ mm/s}$ ,  $C = 1.6 \text{ mm}$ ,  $M = 16$ ,  $A = 10 \text{ mm}$ ,  $N = 512$ ,  $R = 300 \text{ ms}$  and  $L = 30 \text{ mm}$

The exposure time is calculated as follows, which will not cause problems with reading.

$$n \cong \frac{1.6 \times 512}{(10 \times 16)} = 5.12 > 4$$

The exposure time is as follows.

$$T \cong \frac{0.1 \times 1.6}{(16 \times 60)} = 0.17 \text{ msec}$$



If the exposure time does not meet the following, the image will be blurred causing adverse effects on reading.

$$T \cong \frac{W}{V} = \frac{0.1 C}{(MV)}$$

If you want to set the exposure time, hold down the left button for more than two seconds to change the current one or set it in the setting mode.



p.22, p.32

## Reading Time

The reading time can be calculated using the formula below.

$$(\text{Reading time: } R) \cong \frac{(\text{Code pitch: } L)}{(\text{Max. line speed: } V)}$$

If the reading time does not meet this formula, the code will be outside the field of vision so the code cannot be read even if the requirement of exposure time is satisfied.

Example: When the line speed is 60 mm/s and code pitch is 30 mm

$$R \cong \frac{30}{60} = 0.5 \text{ s} = 500 \text{ ms}$$

The above calculation indicates that the code cannot be read unless the reading time is 500 ms or shorter.

If the reading time is 500 ms or longer, the line speed must be decreased or the code pitch increased.

# Maintenance

## Handling the Code Reader

The main unit, lens and light are optical components. so they must be handled carefully.

If they get dirty or scratched, image pickup will deteriorate, disabling code reading.

- Do not touch the lens and light cover surface with your fingers or any pointed object.
- The code reader must be used in a dust-free environment.  
If the lens or light cover get dirty, clean them with lens-cleaning cloth or air brush.
- When attaching a lens to the main unit (V400-F050), take care not to touch the CCD pickup surface of the lens and not to let dust collect on it.

 p.21

## Inspection

To maintain the code reader in the best condition, perform the following regularly.

- Remove dirt from the lens and LED light using lens-cleaning cloth or air brush.
- Wipe off dirt on the main unit gently with a soft cloth.

Inspection items	Details	Required tools
Power supply	Measure the power supply voltage at the power terminal block, and make sure that it is within the rated voltage range (21.6 to 26.4 VDC).	Multimeter
Ambient operating temperature	Measure the ambient operating temperature inside the cabinet, and make sure that it is between 0 and +45 °C.	Thermometer
Ambient operating humidity	Measure the ambient operating humidity inside the cabinet, and make sure that it is between 35% and 85% RH.	Hygrometer
Installation condition	Cables and connectors connected to each device must be correctly inserted and locked. The lens must be secured firmly. The lens mount must be secured firmly.	Screwdriver



CHECK!

- Turn OFF the power and take safety precautions before conducting maintenance or inspections.
- Do not use thinners or benzene to clean the code reader.

# Specifications and Dimensions

Main unit

V400-F050

(Unit: mm)

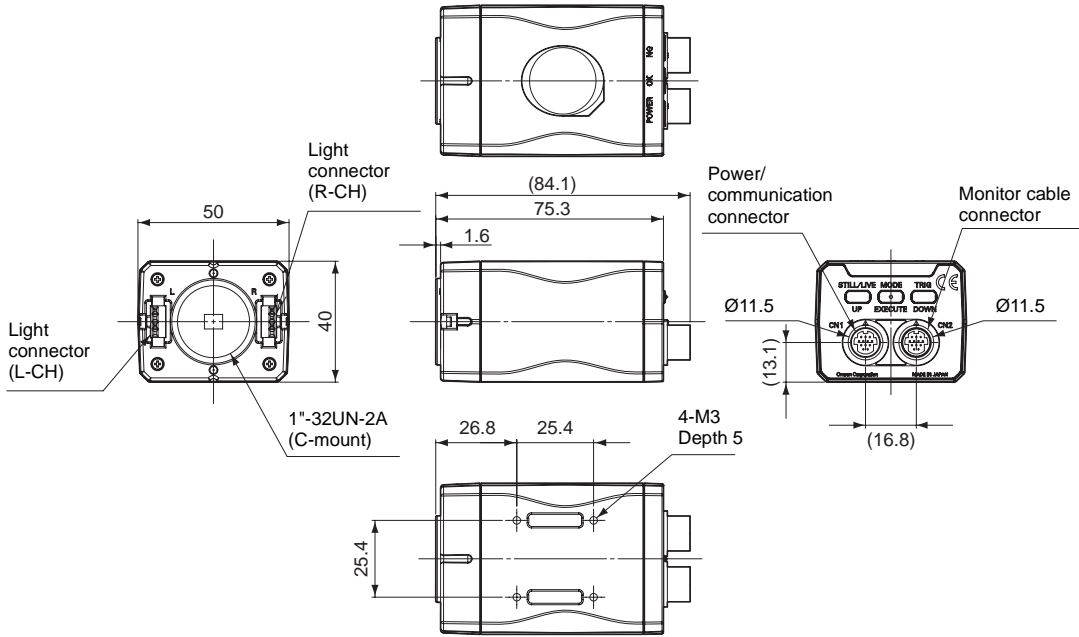

V400-F250/350

(Unit: mm)

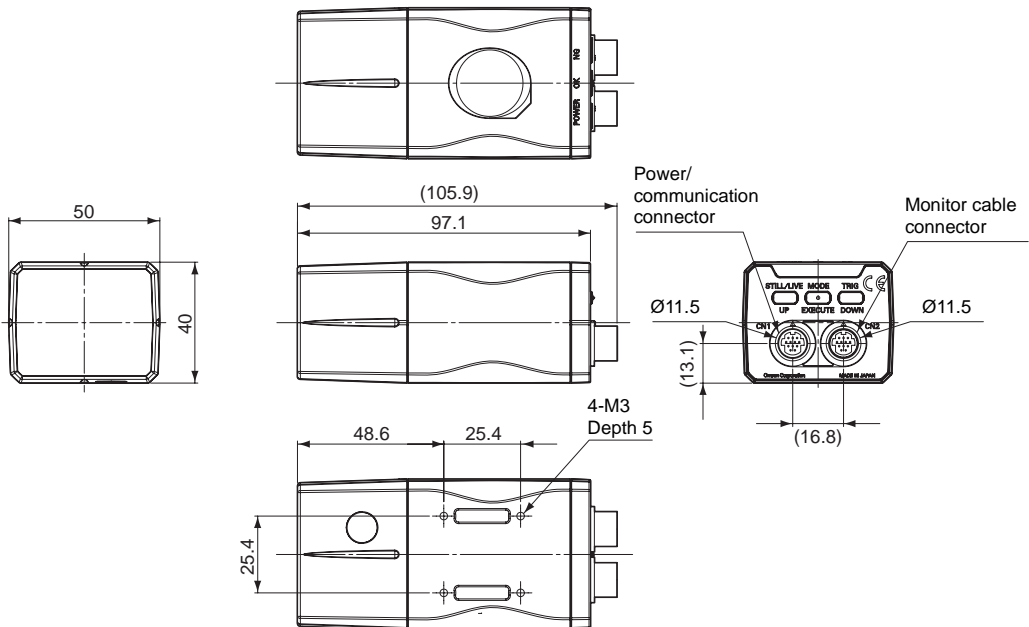



## Mount seat

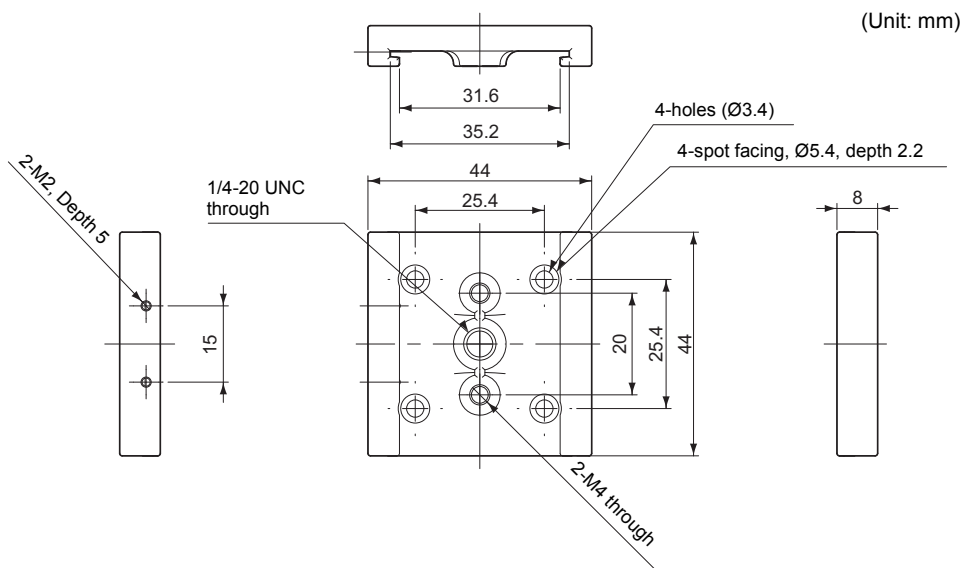

## General specifications

Model	V400-F050	V400-F250	V400-F350
External size	40 × 50 × 75 mm	40 × 50 × 97 mm	
Focal length (WD)	Depends on the lens used.	Approx. 100 mm	Approx. 200 mm
Field of vision	Depends on the lens used.	Approx. 14 × 18 mm	Approx. 31 × 42 mm
Light	Up to two lights can be directly driven.	Red LED	
Sensing element	1/3-inch CCD		
Number of effective pixels	640 × 480 dots		
Power supply voltage	24 VDC±10%		
Power consumption	0.5 A max.		
Insulation resistance	20 MΩ or higher		
Dielectric strength	1000 V AC (1 minute)		
Leakage current	0.25 mA max.		
Noise resistance	Power line: 2 kVp-p; Pulse width: 50 ns; Rise time: 5 ns Burst continuation time: 15 ms; Period: 300 ms		
Vibration resistance	10 to 150 Hz at a single-amplitude of 0.35 mm (maximum acceleration: 50 m2/s), 10 times for 8 minutes each in 3 directions		
Shock resistance	150 m2; 3 times each in 6 directions		
Operating ambient temperature	0 to +45 °C		
Storage ambient temperature	-25 to +65 °C		
Ambient humidity	25% to 85% RH (with no icing or condensation)		
Ambient environment	No corrosive gases		
Installation	Mount the reader with four M3 screws or fixture (supplied with the reader).		
Degree of protection	None	IP67 (IEC60529)	
Weight	Approx. 150 g		

Communication Cable  
V400-W23/23P/24/24P

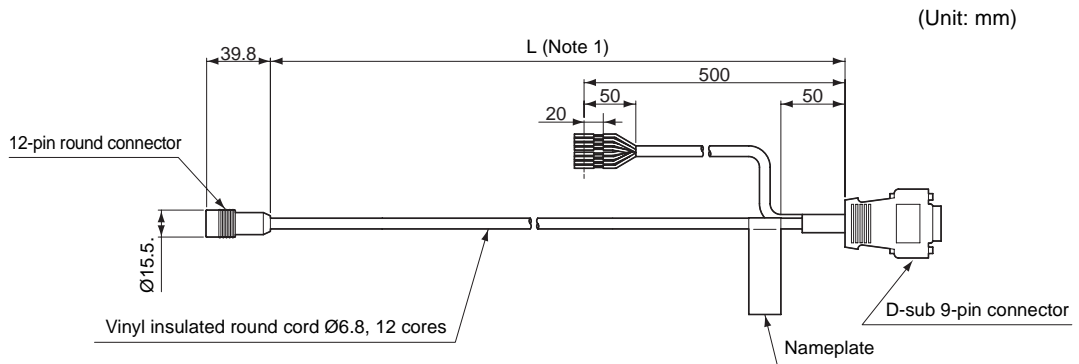

Note 1: The cable length (L1) must be as follows.

Length L
3 m
5 m
10 m
15 m

General specifications

Model	V400-W23/P	V400-W24/P
I/F connector	D-sub 9-pin connector (male) PLC connection type	D-sub 9-pin connector (female) DOS/V PC connection type
Power supply wire	Brown: +24V, Blue: GND	
I/O type	V400-W23, V400-W24: NPN V400-W23P, V400-W24P: PNP	
Operating ambient temperature	0 to +50 °C	
Storage ambient temperature	-25 to +65 °C	
Ambient humidity	25% to 85% RH (with no icing or condensation)	
Ambient environment	No corrosive gases	
Materials	Cable sheath: Heat-resistant vinyl chloride Special connector: PPS, PBT, POM D-sub connector: ABS	
Minimum bending radius	42 mm	
Accessories	Ferrite core (x1)	

## Monitor cable V400-WM0

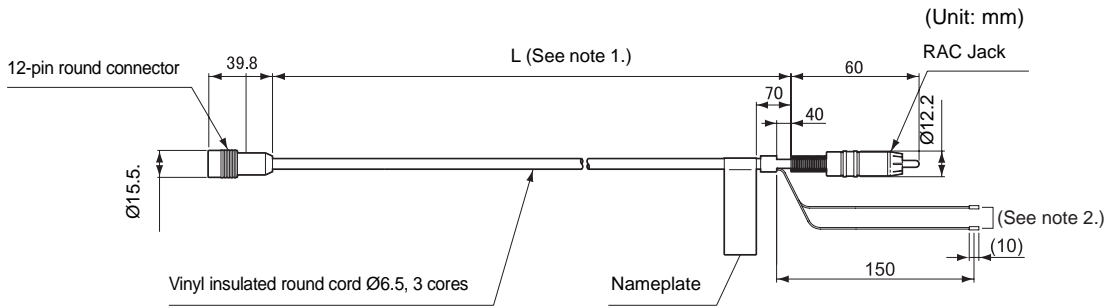

Note 1: The cable length (L1) must be as follows.

Length L
1 m
5 m

Note 2: These two wires are for a 24-V output.  
Do not use them for input; doing so may result in malfunction.

### General specifications

Operating ambient temperature	0 to +50 °C
Storage ambient temperature	-25 to +65 °C
Ambient humidity	25% to 85% RH (with no icing or condensation)
Ambient environment	No corrosive gases
Materials	Cable sheath: Heat-resistant vinyl chloride Special connector: PPS, PBT, POM

Color LCD Monitor  
F150-M05L-2D

(Unit: mm)

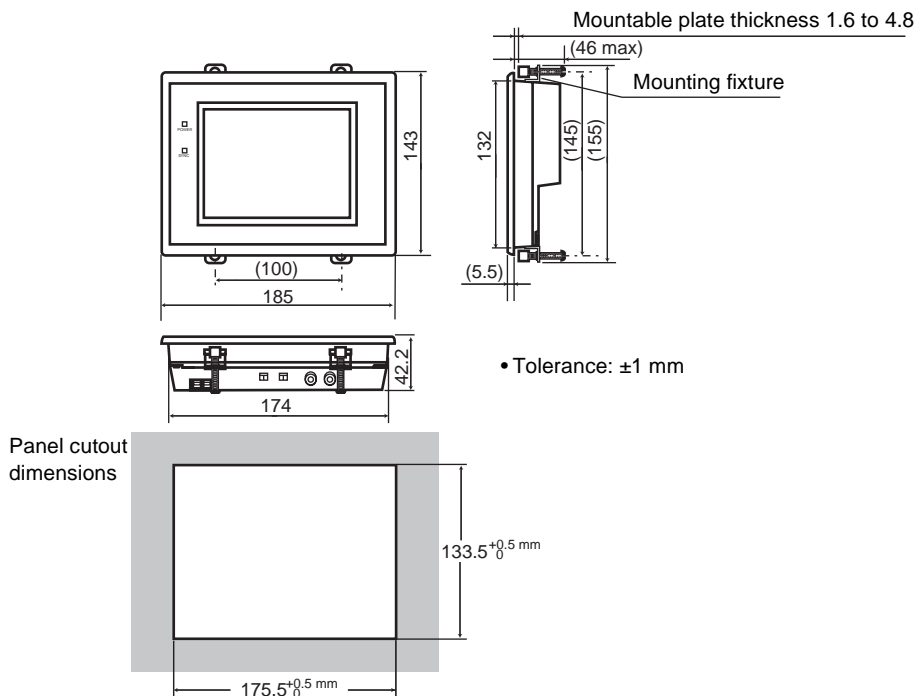

General specifications

Power supply voltage	20.4 to 26.4 VDC
Current consumption	700 mA max.
Vibration resistance	10 to 150 Hz at a single-amplitude of 0.1 mm (maximum acceleration: 15 m/s <sup>2</sup> ), 10 times for 8 minutes each in 3 directions
Shock resistance	150m/s <sup>2</sup> ; 3 times each in 6 directions
Ambient temperature	Operating: 0 to +50°C; Storage: -25 to +65°C (with no icing or condensation)
Ambient humidity	Operating and storage: 35% to 85% RH (with no condensation)
Ambient environment	No corrosive gases
Degree of protection	IEC60529 IP20
Materials	Case: ABS/PC; Display surface: PMMA (Acrylic)
Weight	Approx. 610 g
Accessories	Mounting bracket (x4)

Performance Specifications

Panel size	5.5 inches (111.36 (H) × 83.52 (V) mm)
Panel type	TFT color liquid crystal display
Resolution	320 × 240 dots
Image pitch	0.348 (H) × 0.348 (V) mm
Contrast	85:1 (TYP)
Viewable angle	25° up/down and 50° left/right (with a contrast ratio > 10)
Luminance	250 cd/m <sup>2</sup> (TYP)
Backlight	Cold cathode fluorescent light
Response time	60 ms max.
Input signals	NTSC composite video (1.0 V/75 W termination)

# ASCII Table

Data read using RS-232C is output as 2 ASCII characters.  
The ASCII characters correspond to the following characters.

(Examples)

- When the read data is A, 41 is output.
- When the data read is T, 54 is output.

		Upper 4 bits							
		0	1	2	3	4	5	6	7
Lower 4 bits	0		D <sub>E</sub>		0	@	P	`	p
	1	S <sub>H</sub>	D <sub>1</sub>	!	1	A	Q	a	q
	2	S <sub>X</sub>	D <sub>2</sub>	”	2	B	R	b	r
	3	E <sub>X</sub>	D <sub>3</sub>	#	3	C	S	c	s
	4	E <sub>T</sub>	D <sub>4</sub>	\$	4	D	T	d	t
	5	E <sub>Q</sub>	N <sub>K</sub>	%	5	E	U	e	u
	6	A <sub>K</sub>	S <sub>N</sub>	&	6	F	V	f	v
	7	B <sub>L</sub>	E <sub>B</sub>	'	7	G	W	g	w
	8	B <sub>S</sub>	C <sub>N</sub>	(	8	H	X	h	x
	9	H <sub>T</sub>	E <sub>M</sub>	)	9	I	Y	i	y
	A	L <sub>F</sub>	S <sub>B</sub>	*	:	J	Z	j	z
	B	H <sub>M</sub>	E <sub>C</sub>	+	;	K	[	k	{
	C	C <sub>L</sub>	F <sub>S</sub>	,	<	L	¥	l	!
	D	C <sub>R</sub>	G <sub>S</sub>	-	=	M	]	m	}
	E	S <sub>O</sub>	R <sub>S</sub>	.	>	N	^	n	~
	F	S <sub>I</sub>	U <sub>S</sub>	/	?	O	_	o	

# Ladder Programming Example for Connecting to a PLC

## ■ Connections Used in this Example

The following configuration is used in this example.

2D code reader  
V400-F050/250/350



Cable  
V400-W23 (NPN type)  
V400-W23P (PNP type)

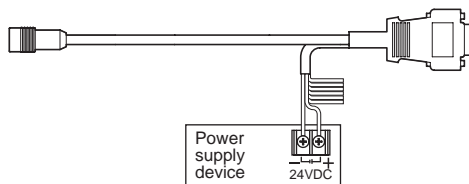

Recommended: OMRON  
S8VS-03024

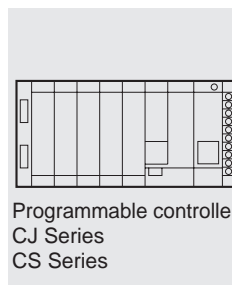

Programmable controller  
CJ Series  
CS Series

## ■ V400-F050/250/350 Settings (Default Settings)

Baud rate: 9,600 bps

Data length: 8 bits

Stop bits: 1 bit

Parity: None

Header: None

Footer: CR

## ■ CS/CJ-series PLC Settings

Change the settings in the PLC Setup to those shown below using the CX-Programmer and then transfer the settings to the CPU Unit of the PLC.

Communications Settings: Select the Custom Option and then set the baud rate to 9,600 and the format to "8,1,N".

Mode: RS-232C

Start Code: Select Disable Option.

End Code: Select the Set End Code Option and set "000D".

■ Sample Programming for CJ-series PLC Using a Software Trigger  
 With the following programming, the V400-F will start reading when the Read Start Bit (CIO 0.00) turns ON. The reading results will be stored in DM200 to DM220.

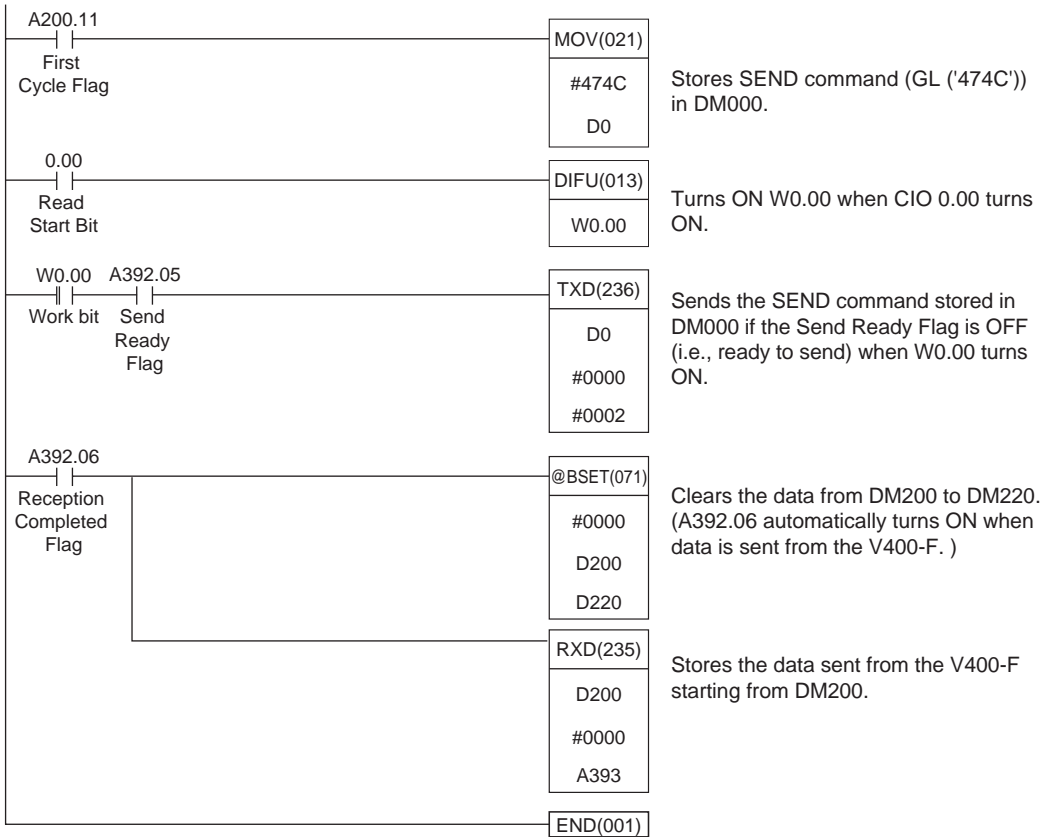

This programming example assumes that the read data is 20 digits or less.



## ■ Sample Programming for CJ-series PLC Using a Hardware Trigger

With the following programming, the results of reading using a hardware trigger will be stored in DM200 to DM220.

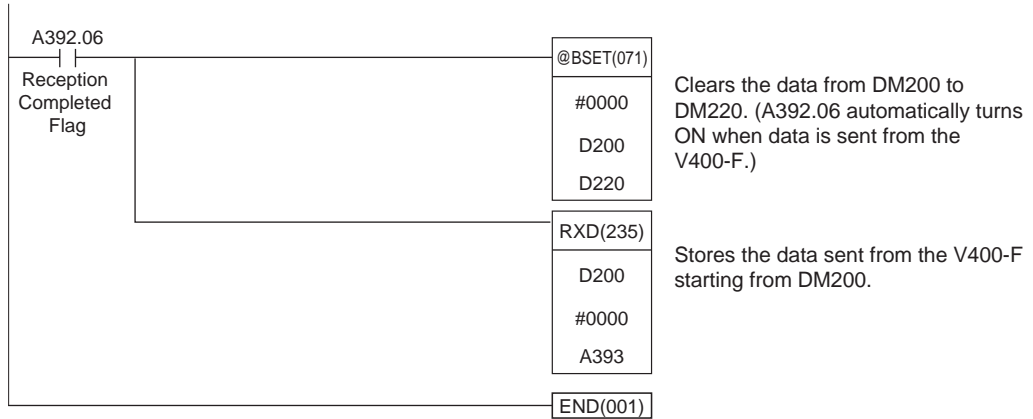

This programming example assumes that the read data is 20 digits or less.

# FCS Check Program Example (BASIC)

## ■ Calculation Programming Example for Sending FCS

DATA\$	Sample data string
L	Data length
CODE\$	Data character
A	Exclusive OR

```

100      * * * * * CALCULATE FCS * * * * *
110      * FCSSET
120      L = LEN (DATA$)
130      A = 0
140      FOR J = 1 TO L
150      CODE$ = MID$ (DATA$,J,1)
160      A = ASC (CODE$) XOR A
170      NEXT J
180      FCS$ = HEX$ (A)
190      IF LEN (FCS$) = 1 THEN FCS$ = "0" + FCS$
200      RETURN

```

## ■ FCS Check Subroutine Example for Received Data

```

1000     * * * * * FCSHECK * * * * *
1010     * FCSHECK
1020     Q = 0: FCCK$ = "OK"
1030     PRINT RESPONSE $
1040     LENG$ = LEN (RESPONSE$) -3
1050     FCSP$ = MID$ (RESPONSE$,LENG$ + 1,2)      'FCS in response data
1060     FOR J = 1 TO LENG$                        'Calculation range of FCS
1070     Q = ASC (MID$ (RESPONSE$,J,1)) XOR Q
1080     NEXT J
1090     FCSD$ = HEX$ (Q)
1100     IF LEN (FCSD$) = 1 THEN FCSD$ = "0" + FCSD$      'FCS calculated in a program
1110     IF FCSD$ < > FCSP$ THEN FCCK$ = "ERR"
1120     PRINT "FCSD$ = "; FCSD$; "FCSP$ = "; FCSP$;      'FCS received correctly: OK
                                         "FCCK$ = "; "FCCK$ =" 'FCS not received correctly:
                                         ERR
1130     RETURN

```

## ■ FCS Calculation Method

The FCS (Frame Check Sequence) is the result of taking the XOR for each byte between the header and footer (8 bits) and converting it to 2 characters of ASCII.

The FCS can be attached to output data to improve the reliability of communications.

Each time data is received, the PC calculates the FCS and checks it against the FCS attached to the sent data so that the send data can be checked for errors.

 FCS Setting p.47

## ■ Calculation Example for Sending FCS

Sample read data: ABCDEFG

The details of the read data and calculation method are as follows:

- Read data

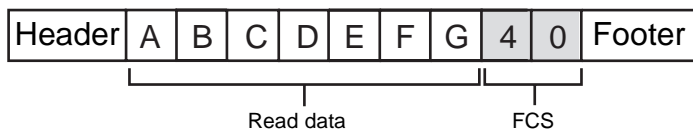

- Calculation method

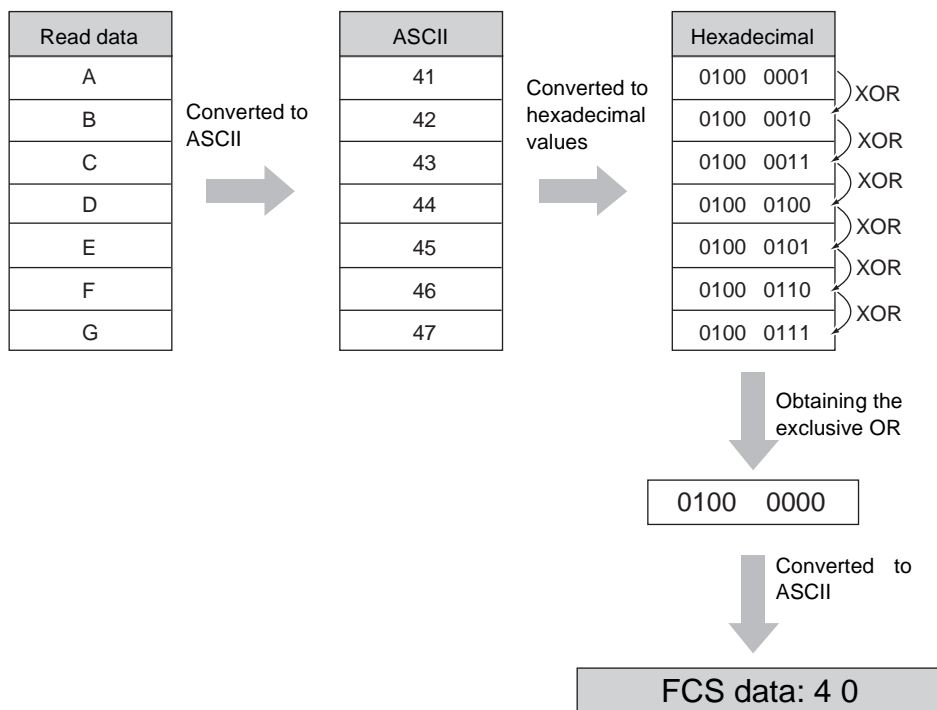

# Data Capacity Table

The maximum quantity of information that can be stored depends on the symbol size of the code. Also the maximum data capacity in relation to the amount of information carried by the code depends on the character type and the arrangement and combination of characters. The relation between the symbol size (number of cells) and data capacity is shown in the following table.

- DataMatrix
- DataMatrix ECC200

In the following diagram, the symbol size is 12 × 12.

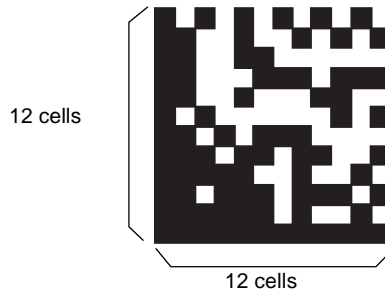

Symbol size	Data capacity				
	Numeral	Alphanumeric	Alphanumeric and symbol	2-byte character	1-byte Japanese character
10 × 10	6	3	3	-	1
12 × 12	10	6	5	1	3
14 × 14	16	10	9	3	6
16 × 16	24	16	14	5	10
18 × 18	36	25	22	8	16
20 × 20	44	31	28	10	20
22 × 22	60	43	38	14	28
24 × 24	72	52	46	17	34
26 × 26	88	64	57	21	42
32 × 32	124	91	81	30	60
36 × 36	172	127	113	42	84
40 × 40	228	169	150	56	112
44 × 44	288	214	190	72	142
48 × 48	348	259	230	86	172
52 × 52	408	304	270	101	202
64 × 64	560	418	372	139	278
8 × 18	10	6	5	1	3
8 × 32	20	13	12	4	8
12 × 26	32	22	20	7	14
12 × 36	44	31	28	10	20
16 × 36	64	46	41	15	30
16 × 48	98	72	64	23	47

## ■ QRCode

### ■ QRCode (Model 2)

In the following diagram, the symbol size is 21 × 21 (Version 1).

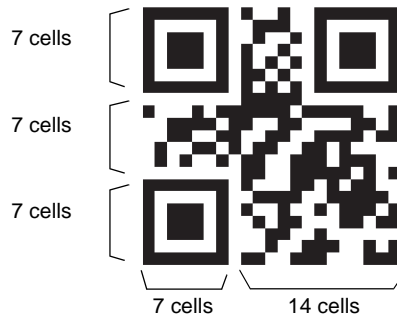

Symbol size (version)	Error correction level (ECC level)	Data capacity			
		Numeral	Alphanumeric (uppercase)	8-bit byte Byte	Japanese character
21 × 21 (Version 1)	L (7%)	41	25	17	10
	M (15%)	34	20	14	8
	Q (25%)	27	16	11	7
	H (30%)	17	10	7	4
25 × 25 (Version 2)	L (7%)	77	47	32	20
	M (15%)	63	38	26	16
	Q (25%)	48	29	20	12
	H (30%)	34	20	14	8
29 × 29 (Version 3)	L (7%)	127	77	53	32
	M (15%)	101	61	42	26
	Q (25%)	77	47	32	20
	H (30%)	58	35	24	15
33 × 33 (Version 4)	L (7%)	187	114	78	48
	M (15%)	149	90	62	38
	Q (25%)	111	67	46	28
	H (30%)	82	50	34	21
37 × 37 (Version 5)	L (7%)	255	154	106	65
	M (15%)	202	122	84	52
	Q (25%)	144	87	60	37
	H (30%)	106	64	44	27
41 × 41 (Version 6)	L (7%)	322	195	134	82
	M (15%)	255	154	106	65
	Q (25%)	178	108	74	45
	H (30%)	139	84	58	36

Symbol size (version)	Error correction level (ECC level)	Data capacity			
		Numeral	Alphanumeric (uppercase)	8-bit byte Byte	Japanese character
45 × 45 (Version 7)	L (7%)	370	224	154	95
	M (15%)	293	178	122	75
	Q (25%)	207	125	86	53
	H (30%)	154	93	64	39
49 × 49 (Version 8)	L (7%)	461	279	192	118
	M (15%)	365	221	152	93
	Q (25%)	259	157	108	66
	H (30%)	202	122	84	52
53 × 53 (Version 9)	L (7%)	552	335	230	141
	M (15%)	432	262	180	111
	Q (25%)	312	189	130	80
	H (30%)	235	143	98	60
57 × 57 (Version 10)	L (7%)	652	395	271	167
	M (15%)	513	311	213	131
	Q (25%)	364	221	151	93
	H (30%)	288	174	119	74

Source: 2D Codes, Basic Specifications for QR Code (JIS X 0510)



#### Maximum Data Capacity

Even with the same 2D code, the maximum quantity of information that can be stored depends on the symbol size of the code.

In other words, the symbol size must be increased to increase the data capacity.

The data capacity also depends on the type of characters used for the information contained in the code. With QR and DataMatrix Code, the maximum number of characters for the same symbol size will be greatest for numbers only and then for alphanumerics, and will be the least with 2-byte characters.

The data capacity also depends on the character type, and the order and combination of characters used.

# Menu Hierarchy

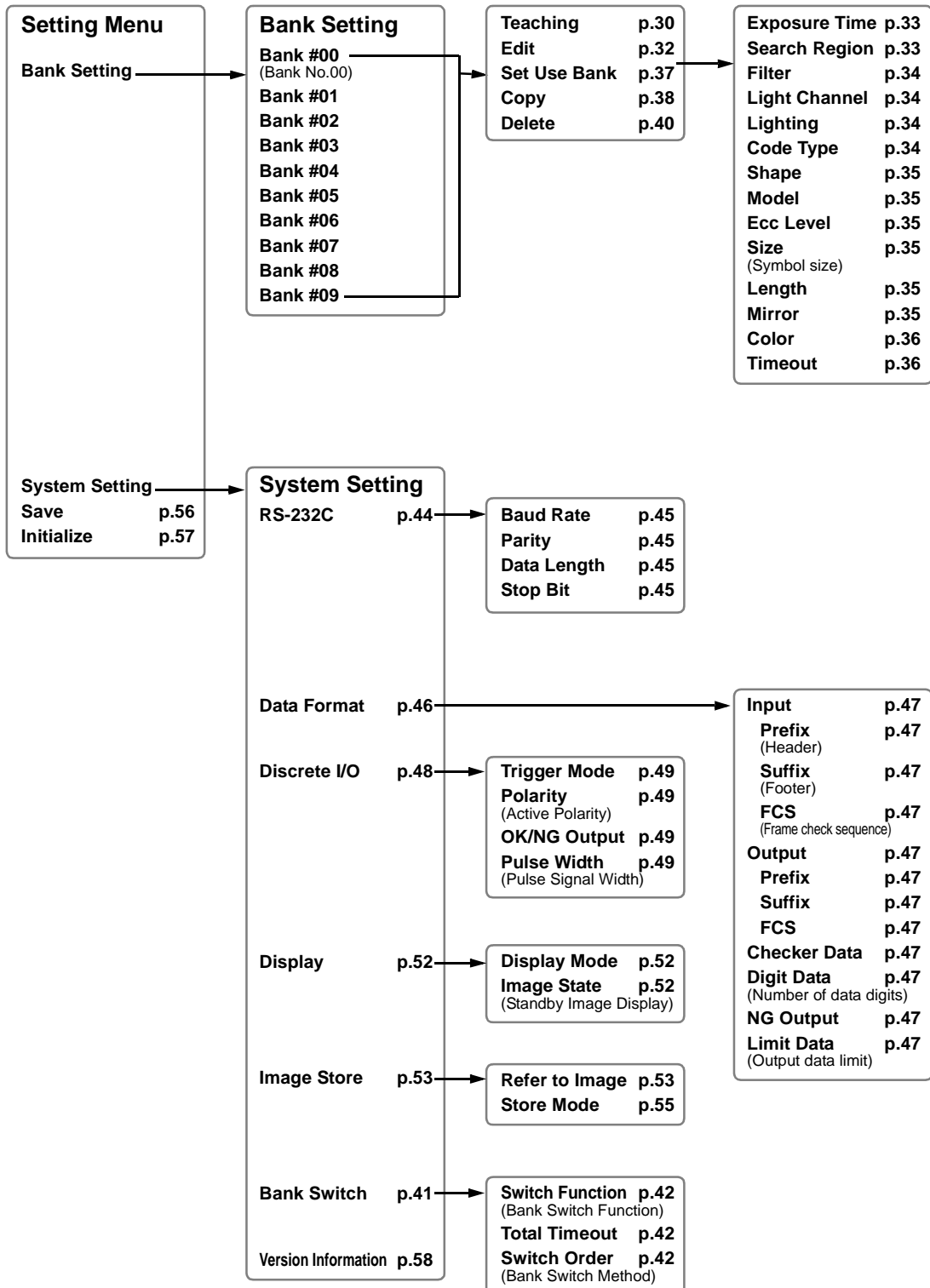

# Revision History

A manual revision code appears as a suffix to the catalog number at the bottom of the front and back covers.



Reprint code	Date	Revised contents
01	Apr. 2006	Original production
02	May 2006	Addition and slight correction of communication commands
03	Dec. 2006	Page 18: "CHECK" item added and section on glossy workpieces added. Page 22: Callouts changed at bottom of page. Pages 60 and 61: Wiring diagram changed. Page 70: "Exposure Time" removed from middle graphic. Page 99: Arrows changed at bottom left of table. Page 97: Note added. Page 100: Programming example added.
03A	Mar. 2012	Additions for Notice for Korea Radio Law
04	Aug. 2015	Additions corresponding to change of EN standard.



MEMO



MEMO



**OMRON Corporation Industrial Automation Company**

Kyoto, JAPAN

Contact: [www.ia.omron.com](http://www.ia.omron.com)

**Regional Headquarters**

**OMRON EUROPE B.V.**

**Sensor Business Unit**

Carl-Benz-Str. 4, D-71154 Nufringen, Germany  
Tel: (49) 7032-811-0/Fax: (49) 7032-811-199

**OMRON ELECTRONICS LLC**

2895 Greenspoint Parkway, Suite 200  
Hoffman Estates, IL 60169 U.S.A.  
Tel: (1) 847-843-7900/Fax: (1) 847-843-7787

**OMRON ASIA PACIFIC PTE. LTD.**

No. 438A Alexandra Road # 05-05/08 (Lobby 2),  
Alexandra Technopark,  
Singapore 119967  
Tel: (65) 6835-3011/Fax: (65) 6835-2711

**OMRON (CHINA) CO., LTD.**

Room 2211, Bank of China Tower,  
200 Yin Cheng Zhong Road,  
PuDong New Area, Shanghai, 200120, China  
Tel: (86) 21-5037-2222/Fax: (86) 21-5037-2200

**Authorized Distributor:**

© OMRON Corporation 2006 All Rights Reserved.  
In the interest of product improvement,  
specifications are subject to change without notice.

**Cat. No. Z242-E1-04**

0815