

**OMRON**

**V720 Series Electromagnetic Inductive RFID System**

**V720**

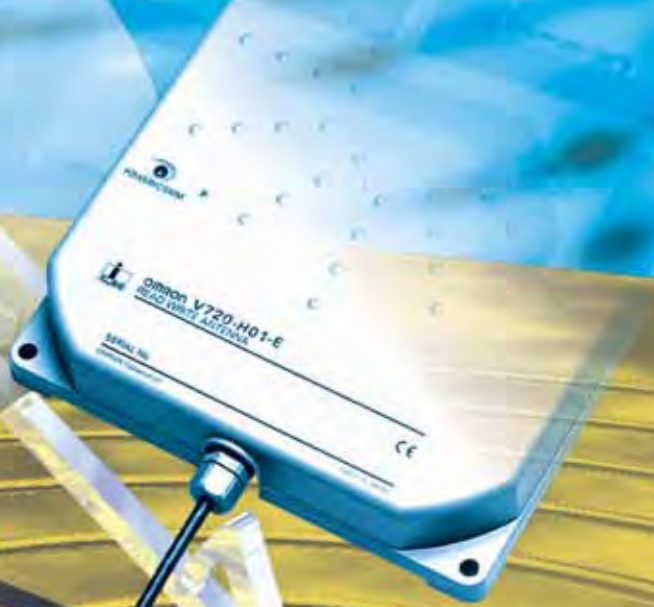

# V720

V720 ANTENNA + CONTROLLER + TAG INLET SERIES

## Series Electromagnetic Inductive RFID System

OMRON supplies each business partner with the following V720 RFID system components: Tag Inlets (for use in RF tags), an ID Controller, a Read Write Antenna, a Read Write Module, a Development Kit and specially customized antennas for specific applications. These products are key components to establish total RF solutions for system integrators and users.

### Features

The RF tags can be simultaneously accessed by read write antennas and, unlike bar code systems, RFID systems do not require a direct line-of-sight between the antenna and tag. For end users, these features broaden the areas in which RFID systems can be applied and provide unified and convenient means of handling objects and information. The results are further reductions in personnel expenses and work time, increased productivity, and reduced stock volumes. As its four main features, the V720 system provides a wide variety of functions, flexibility, standardization, and low-cost systems.

#### A Wide Variety of Functions

Equipped with the basic functions for RFID systems: single access, multiple access, selective access, and FIFO queue functions.

#### Flexibility

Traditional RFID systems have been somewhat limited in their range of applicability due to the hardness of the majority of the RF tags, but thanks to innovatory technological advances, OMRON has developed a more flexible tag. The OMRON Tag Inlet is very thin and can be easily adapted to the size and specification requirements of a wide variety of user needs.

#### Standardization

Nowadays contactless IC cards have been standardized internationally and this has created an increasing demand for products that meet these international standards. By using the I•CODE chip from Philips Semiconductors, OMRON V720 products meet with international standards, including ISO 15693.

#### Low Cost











OMRON V720 products provide high quality at low cost, reflecting scale merit and production methods for a thoroughly low-cost operation using the most up-to-date technology.



### Applications

Recently the diversification of consumer needs has made RFID systems an important means within the manufacturing industry to achieve multi-product, small-lot production. Supply chain management in particular, from manufacture through to final point of sale, has become a major logistical tool. For specific applications, the RF tags are well suited for use in airport baggage handling systems, parcel services, libraries, retail logistics and asset tracking systems, along with a wide range of other applications.

# Ordering Information

Product	Model		Shape/Specification	
Tag Inlet	V720□-D□□P□□-R1K (1,000 pcs.)		1,000 pcs. per roll	
	V720□-D□□P□□-R5K (5,000 pcs.)		5,000 pcs. per roll	
Read Write Antenna	V720S-H01		250 × 200 × 35 mm	10-cm cable (The connector is not waterproof.)
ID Controller	V720S-CD□D		24 VDC 1-channel Antenna 90 × 65 × 75 mm	V720S-CD1D RS-232C host interface V720S-CD2D RS-485 host interface
Antenna	V720-HS03		334 × 407 × 46 mm	Conforms to IP65 (IEC 60529).
Gate Antenna	V720-HS71 (2-Antenna Configuration) V720-HS71S (1-Antenna Configuration)		622 × 1,597 × 120 mm (Dimensions of 1-antenna configuration)	Can be used in 2-antenna or 1-antenna configuration. (Communications distance varies according to configuration. Consult your OMRON representative for details.)
Reader/Writer	V720S-BC5D4		247 × 128 × 64 mm	Connection is also possible to antennas other than the V720-HS03 and V720-HS71. Consult your OMRON representative.
Antenna Cable	V700-A40□		The connector is not waterproof. Material: Vinyl chloride	Select from 3-m, 5-m, 10-m, 20-m, or 30-m cables.
	V720-A40-□□□m			Select from 3.35-m or 10.35-m cables.
RS-232C Cable	V720-A60-□□□m	Refer to manual.	Special for Reader/Writer	Select from 3-m or 15-m cables.
Power Cable	V720-A50 3m		Special for Reader/Writer	3 m
PCB-type Read Write Module	V720S-HMC73 (Unified Type)		5 VDC 40 × 44 × 14 mm	A Read Write Antenna and controller functions are built into a compact module, which facilitates mounting to other equipment.
	V720S-HMC73T (Separate Type)		5 VDC 40 × 44 × 1 mm 40 × 44 × 9 mm	
CF II I/F Reader/Writer	V720S-HMF01		52 × 35 × 16 mm (Protruding part when mounted to a PDA)	Creates a handheld RFID Reader/Writer when combined with a PDA.
Development Kits A/B	V720S-W01-1-E (with 110 tags) V720S-W01-2-E (without tags)		480 × 300 × 160 mm	The Development Kit includes a Read Write Antenna, an ID Controller, and RFID Tags. It is provided at a reasonable price to enable system appraisal and sales promotion. A Type: 110 tags included. B Type: No tags included.

ID Tags are also available. Consult your OMRON representative.

# System Configuration

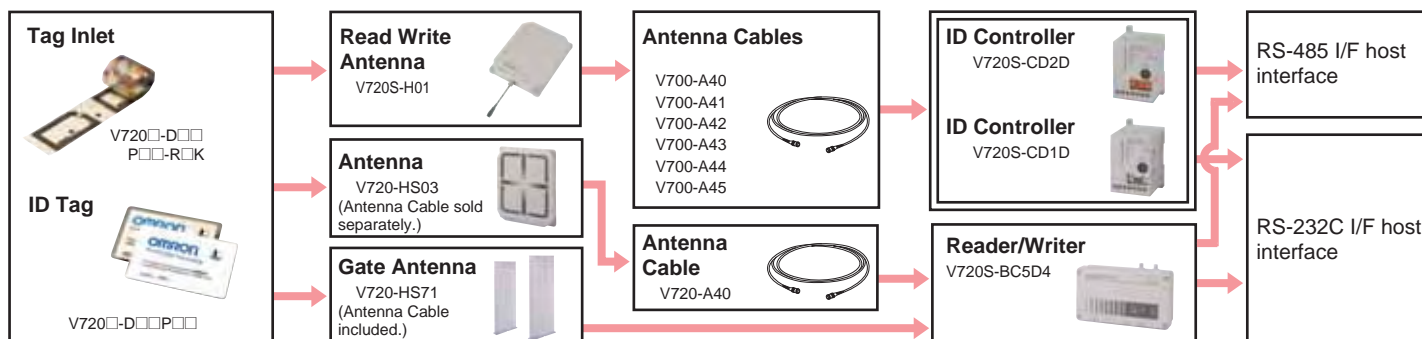

Consult your OMRON representative concerning other products and configurations.

# V720-series Electromagnetic Inductive RFID System ID Controllers V720S-CD□D



V720S-CD1D



V720S-CD2D

## Product Description

OMRON's ID Controllers suit a wide range of applications by offering a variety of access functions, and general-purpose host interfaces. Simply connect the ID Controller to a Read Write Antenna (V720S-H01) to configure an RFID system. The V720S-CD□D ID Controllers conform completely to the international standard ISO 15693.

## Features

- Equipped with single access (1 to 1), multiple access (1 to n), selective access, and FIFO queue functions.
- General-purpose RS-232C or RS-485 command/response interface for host.
- Conform to EC Directives and FCC.

## Benefits

- Small and easy to install.
- General-purpose interfaces for easy connection to a host system.

## General Specifications

	V720S-CD1D	V720S-CD2D
Host interface	RS-232C	RS-485 (Maximum number of connectable Controllers: 10)
Number of connectable Antennas	1	
Supply voltage	24 VDC $+10\%/_{-15\%}$	
Power consumption	20 W max. including the power consumption of the Read Write Antenna	
Insulation resistance	20 M $\Omega$ min. (at 100 VDC) between the ground and both power supply terminals, both power supply terminals and both I/O terminals, both power supply terminals and cables, both I/O terminals and ground, both I/O terminals and case, and ground terminal and case	
Dielectric strength	Leakage current of 1 mA max. at 500 VAC (50/60 Hz) for 1 minute in any of the above combinations.	
Vibration resistance	No abnormality after applying variable vibration of 10 to 150 Hz and 0.2-mm double amplitude in X, Y, and Z directions for 8 minutes each for 10 repetitions.	
Shock resistance	No abnormality after applying 150 m/s <sup>2</sup> in X, Y, and Z directions 3 times each for 18 repetitions.	
Ambient temperature in operation	-10 to 55°C (with no icing)	
Ambient humidity in operation	35% to 85% (with no condensation)	
Ambient temperature in storage	-25 to 65°C (with no icing)	
Ground	Ground at a resistance of less than 100 $\Omega$ . (If not grounded, communications performance may be affected by the surrounding environment.)	
Degree of protection	Panel mounted	
Material	PC/ASA resin	
Weight	Pyrex. 290 g	
Applicable standards	EN55022, EN55024	

■ Dimensions

**ID Controller V720S-CD□□D**

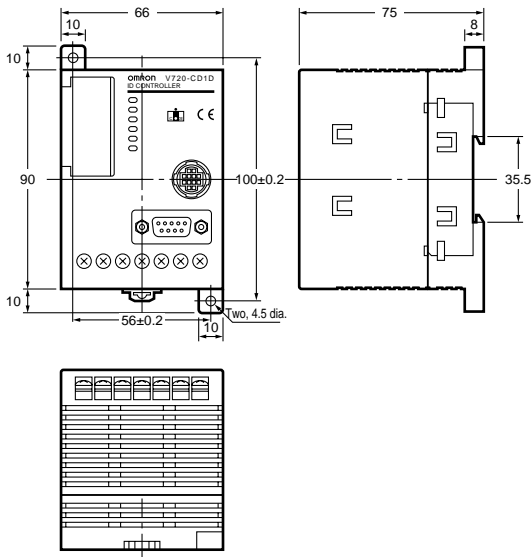

■ Communications Time (Reference Values)

The communications time is the time taken for communications to take place between the Read Write Antenna and the ID Tag, not including the host communications time.

**Standard Mode**

Calculation Methods (msec)

	Communications time
High-speed read	$T = 1.3 N + 43.4$
Normal read	$T = 1.3 N + 91.6$
Write	$T = 54.2 N + 90.0$

**Fast Mode**

Calculation Methods (msec)

	Communications time
High-speed read	$T = 1.3 N + 6.2$
Normal read	$T = 1.3 N + 12.7$
Write	$T = 13 N + 13.5$

**Communications Time for Multi-access**

The communications time when using multiple commands depends on various conditions. It depends not only on the number of bytes to be processed but also on the number of Tags there are within the communications range. The relationship between these factors and the average communications time is shown in the table below.

Number of Tags	Tag numeric constant	Reading 2 pages (8 bytes)		Writing 2 pages (8 bytes)	
		Standard mode	Fast mode	Standard mode	Fast mode
2	2	560	144	715	190
4	3	917	301	1,139	378
8	4	1,659	644	2,016	784
16	5	3,239	1,391	3,867	1,656

■ Functions for Accessing Multiple Tags

● FIFO (First In First Out) Queue Function

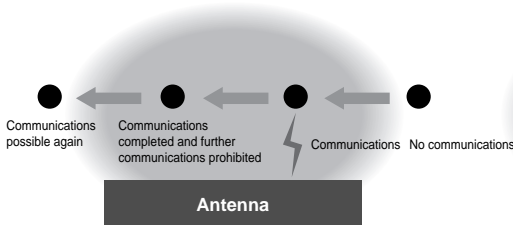

Using this function, communications are performed in order starting with the first Tag to enter the communications range.

● Multiple Access Function

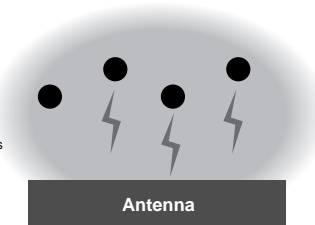

Using this function, communications are performed with every Tag inside the communications range. The Tags are accessed in random order.

● Selective Access Function

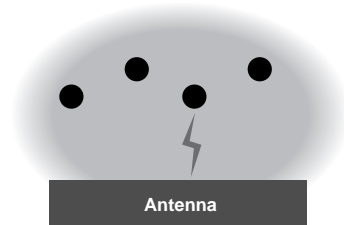

Using this function, it is possible to specify which Tags in the communications range are accessed.

**ALL DIMENSIONS SHOWN ARE IN MILLIMETERS.**

To convert millimeters into inches, multiply by 0.03937. To convert grams into ounces, multiply by 0.03527.

Cat. No. S903-E1-03 In the interest of product improvement, specifications are subject to change without notice.

**OMRON Corporation**

RFID Project Group

14th Fl, Gate City Osaki West Tower  
 1-11 Osaki, Shinagawa-ku  
 Tokyo, 141-0032 Japan  
 Tel: (81)3-5435-2016/Fax: (81)3-5435-2017  
 E-mail: card@dev.keijo.omron.co.jp  
 URL: <http://www.omron.com/card/rfid/>

Printed in Japan  
 0802 (0100)

# V720-series Electromagnetic Inductive RFID System Read Write Antennas V720□-H01 Antenna Cables V700-A4S



V700-A40  
V700-A41  
V700-A42  
V700-A43  
V700-A44  
V700-A45

## Product Description

OMRON's medium-range Read Write Antennas have a maximum communications distance of 25 cm with OMRON smart labels. Connection of the Read Write Antenna with the ID Controller (V720S-CD1D or V720S-CD2D) via the V700-A□ Antenna Cable provides a complete RFID system.

## Features

- Conform to the international standard ISO 15693 for contactless IC cards.
- Six different cable lengths available.
- Provide a communications distance of 25 cm.
- Conform to EC Directives and FCC.
- Both I-CODE1 and I-CODE SLI types are available

## Benefits

- Easy installation
- High reading accuracy even in dirty or dusty environments.

## General Specifications

Item	Specifications
Communications frequency	13.56 MHz
Ambient temperature in operation	-20 to 55°C (with no icing)
Ambient temperature in storage	-35 to 65°C (with no icing)
Ambient humidity in operation	35% to 85% (with no condensation)
Insulation resistance	20 MΩ min. (at 100 VDC) between rear plate and case
Dielectric strength	Leakage current of 1 mA max. at 1,000 VAC (50/60 Hz) for 1 minute between rear plate and case.
Degree of protection	IED60529 IP40 (except connector)
Vibration resistance	No abnormality after applying variable vibration of 10 to 150 Hz and 0.7-mm double amplitude in X, Y, and Z directions for 8 minutes each for 10 repetitions.
Shock resistance	No abnormality after applying 150 m/s <sup>2</sup> in X, Y, and Z directions 3 times each for 18 repetitions.
Cable length	0.1 m (use and extension cable to connect to the ID Controller up to 30 m)
LED indicators	Power supply: Green, Communications: Orange
Weight	Approx. 750 g
Applicable standards	EN300 330, ETS 300 683, EN 60065, FCC Part 15 Subpart C

V700-A4 Antenna Cables

	A40	A41	A42	A43	A44	A45
Cable length	2 m	3 m	5 m	10 m	20 m	30 m

The connectors do not have waterproof specifications.

Dimensions

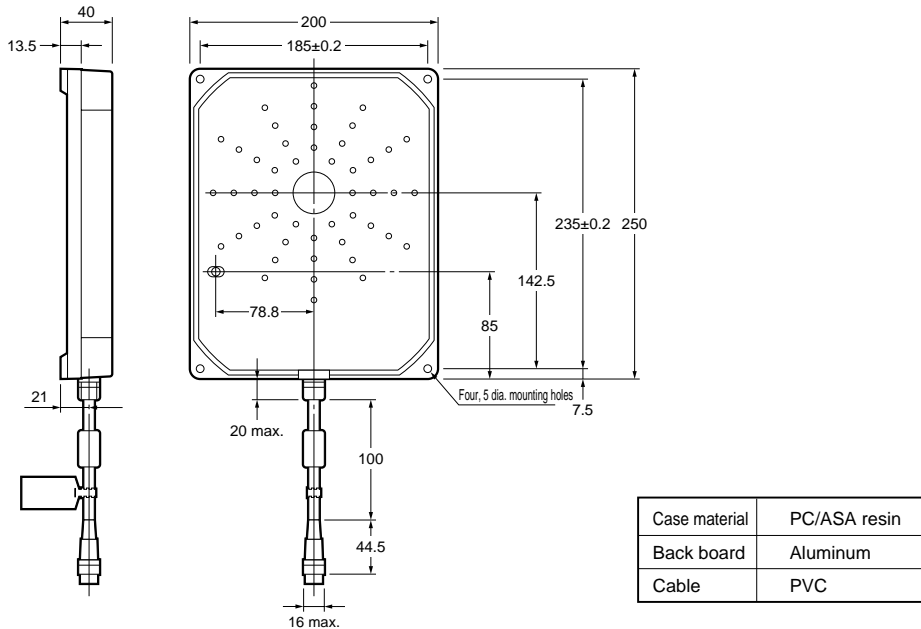
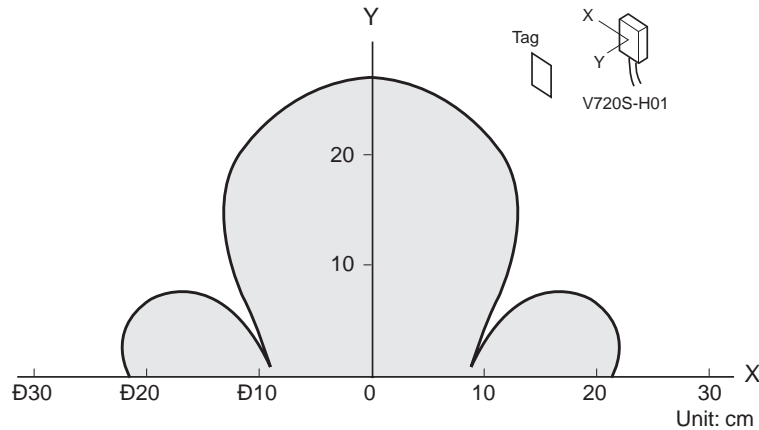

Diagram of Communications Range

A diagram of the V720S-H01's communications range is given below. The communications distance may vary, however, depending on surrounding noise and equipment.

- Read Write Antenna: V720S-H01,  
Tags: V720-D52P30/V720-D52P40/V720S-D13P30/V720S-D13P40



**ALL DIMENSIONS SHOWN ARE IN MILLIMETERS.**  
To convert millimeters into inches, multiply by 0.03937. To convert grams into ounces, multiply by 0.03527.

Cat. No. S902-E1-03 In the interest of product improvement, specifications are subject to change without notice.

**OMRON Corporation**  
RFID Project Group

14th Fl, Gate City Osaki West Tower  
1-11 Osaki, Shinagawa-ku  
Tokyo, 141-0032 Japan  
Tel: (81)3-5435-2016/Fax: (81)3-5435-2017  
E-mail: card@dev.keijo.omron.co.jp  
URL: <http://www.omron.com/card/rfid/>

# V720-series Electromagnetic Inductive RFID System

## Reader/Writer V720S-BC5D4



V720S-BC5D4

### ■ Product Description

OMRON's Reader/Writer enables the industry's top level of communications distance for OMRON Smart Cards, with connection to a V720-HS03 Antenna or V720-HS71 Gate Antenna.

### ■ Features

- Two Antenna terminals available for use in a variety of applications.
- Includes RS-232C and RS-485 interfaces.
- Allows multi-drop connection of up to 32 Antennas
- Both I-CODE1 and I-CODE SLI types are available.

### ■ Benefits

- Durable construction conforms to IP65.
- Inherits the user-friendly host command structure of the previous OMRON series.

### ■ General Specifications

Item	Specifications
Communications frequency	13.56 MHz
Ambient temperature in operation	-10 to 50°C (with no icing)
Degree of protection	IEC 60592, IP65
Power supply voltage	24 VDC ±10%
Dimensions	247 (W) × 64 (H) × 128 (D) mm
Antenna output impedance	50 Ω
I/O interface	Input: 4 signals (IN1, IN2, IN3 RESET), Output: 4 signals (OUT1, OUT2, OUT3, OUT4)
Host interface	COM1 (RS-232C/RS-485), COM2 (RS-232C) 9,600 to 115,200 bps
Applicable standards	R & TTE, FCC Part 15



■ Dimensions

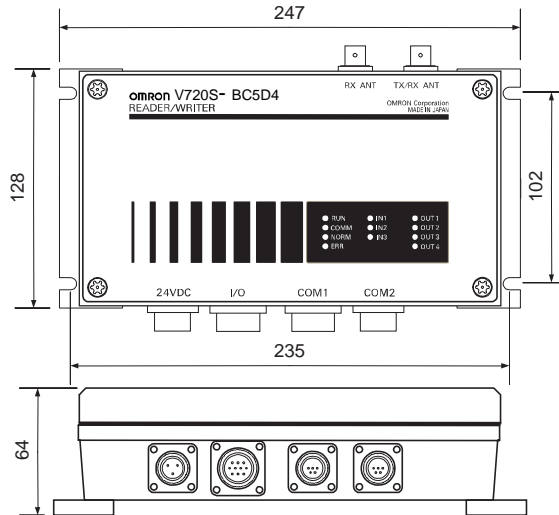

■ Communications Time (Reference Value)

The communications time is the time taken for communications to take place between the Read Write Antenna and the ID Tag, not including the host communications time.

**Standard Mode**

Calculation Methods	(msec)
Communications time	
High-speed read	$T = 1.3 N + 43.4$
Normal read	$T = 1.3 N + 91.6$
Write	$T = 54.2 N + 90.0$

**Fast Mode**

Calculation Methods	(msec)
Communications time	
High-speed read	$T = 1.3 N + 6.2$
Normal read	$T = 1.3 N + 12.7$
Write	$T = 13 N + 13.5$

■ System Configuration

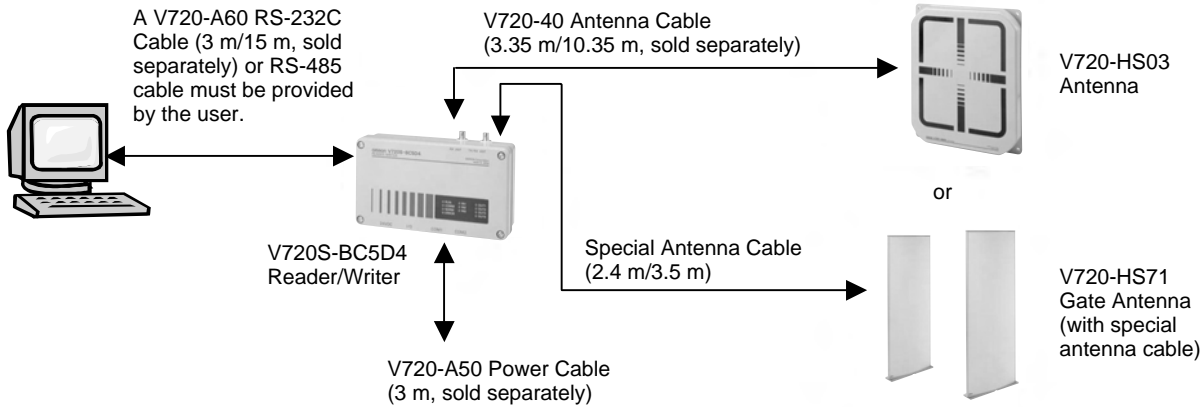

**ALL DIMENSIONS SHOWN ARE IN MILLIMETERS.**  
 To convert millimeters into inches, multiply by 0.03937. To convert grams into ounces, multiply by 0.03527.

Cat. No. S932-E1-01 In the interest of product improvement, specifications are subject to change without notice.

**OMRON Corporation**  
 RFID Project Group

14th Fl, Gate City Osaki West Tower  
 1-11 Osaki, Shinagawa-ku  
 Tokyo, 141-0032 Japan  
 Tel: (81)3-5435-2016/Fax: (81)3-5435-2017  
 E-mail: card@dev.keijo.omron.co.jp  
 URL: <http://www.omron.com/card/rfid/>

Printed in Japan  
 0802 (0802)

# V720-series Electromagnetic Inductive RFID System

## ID Tags

### V720□-D□□P□□



V720-D52P40  
V720S-D13P40



V720-D52P30  
V720S-D13P30

### ■ Product Description

OMRON's V720-series ID Tags conform to the international standard ISO 15693 (communications frequency). Two types are available: the V720□-D□□P40, which is sealed in PET resin, and the V720□-D□□P30, which is processed pouch-style using PET sheets. The ID Tag is widely used in RFID system testing and evaluation. A variety of ID Tag samples are also available. Contact your OMRON representative for details.

### ■ Features

- Conform to ISO 15693, the international standard for contactless IC cards.
- Apply I-CODE chip technology from Philips Semiconductors. Both I-CODE1 and I-CODE SLI types are available.

### ■ General Specifications

Item	V720-D52P□□	V720S-D13P□□ (Available soon)
Applicable chip	I-CODE1	I-CODE SLI
Memory capacity	44 bytes (user area)	112 bytes (user area)
Memory type	64-byte EEPROM	128-byte EEPROM
Communications frequency	13.56 MHz	
Data retention time	10 years after data is written (at 55°C max.)	
Number of overwrites	100,000 times for each address	
Ambient temperature in operation	-10 to 70°C (with no icing)	
Ambient temperature in storage	-30 to 70°C (with no icing)	
Degree of protection	IEC 60529, IP67	
Material	PET resin	
Shock resistance	Destruction: 500 m/s <sup>2</sup> 3 times each in X, Y, and Z directions for 18 repetitions	
Vibration resistance	Destruction: 10 Hz to 500 Hz, 1.5-mm double amplitude, 100-m/s <sup>2</sup> acceleration with 10 sweeps of 11 minutes each in X, Y, and Z directions	
Weight	V720□-D□□P40: Approx. 4 g, V720□-D□□P30: Approx. 2 g,	

■ Dimensions

**V720□-D□□P40**

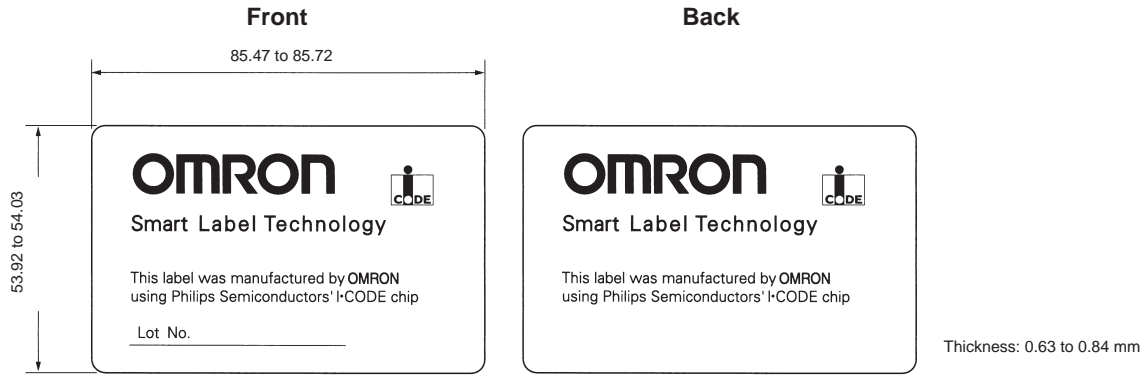

**V720□-D□□P30**

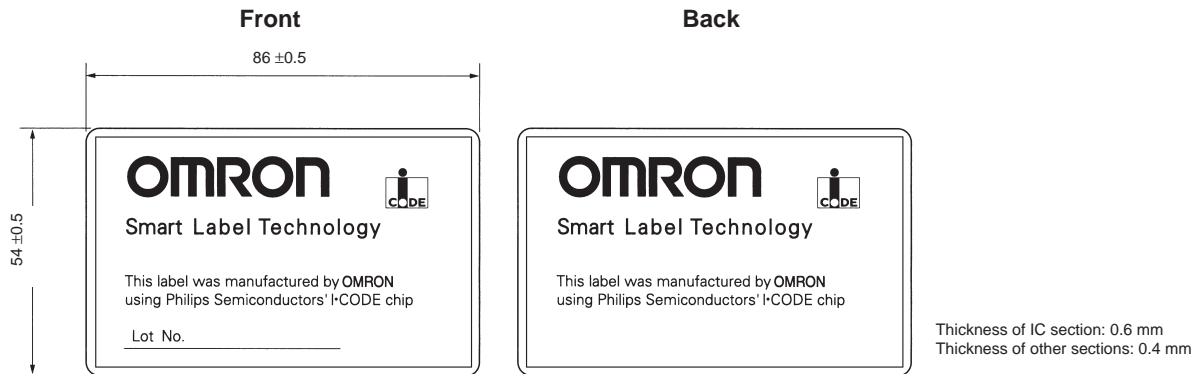

■ Communications Distance <sup>(\*1)</sup> (Measured at 25°C)

Model	V720-D52P30 V720-D52P40	V720S-D13P30 (Available soon) V720S-D13P40 (Available soon)
V720□-H01	0 to 250 mm	0 to 250 mm
V720S-HMC73□	0 to 30 mm	0 to 30 mm

\*1: The communications distance may vary depending on surrounding noise and equipment. Be sure to check the effects prior to use.

**ALL DIMENSIONS SHOWN ARE IN MILLIMETERS.**  
To convert millimeters into inches, multiply by 0.03937. To convert grams into ounces, multiply by 0.03527.

Cat. No. S936-E1-01 **In the interest of product improvement, specifications are subject to change without notice.**

**OMRON Corporation**  
RFID Project Group

14th Fl, Gate City Osaki West Tower  
1-11 Osaki, Shinagawa-ku  
Tokyo, 141-0032 Japan  
Tel: (81)3-5435-2016/Fax: (81)3-5435-2017  
E-mail: card@dev.keijo.omron.co.jp  
URL: <http://www.omron.com/card/rfid/>

Printed in Japan  
0802 (0802)

# V720-series Electromagnetic Inductive RFID System

## Tag Inlets

### V720□-D□□P□□-R□K



V720-D52P01  
V720S-D13P01

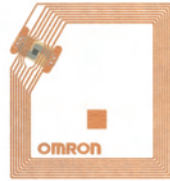

V720-D52P02  
V720S-D13P02



V720-D52P03



V720-D52P04

### ■ Product Description

Smart Labels are Radio Frequency Identification (RFID) tags from OMRON that conform to the international standard ISO 15693. Smart Labels are super thin and highly flexible, making them the most cost-effective of all ID tag products to date, and well suited to a wide range of applications.

- Airport baggage handling systems
- Museum collection management
- Supply chain management systems
- Designer brand product control
- Library book and document management
- Facility and equipment maintenance

Combined with OMRON's ID Controllers and Read Write Antennas, the Tag Inlets are provided for system integrators to use in building RFID systems, converters considering the marketing of ID tags, and bar code equipment manufacturers who want to add RFID labels to their existing line of bar code labels.

### ■ Features

- Conform to ISO 15693, the international standard for contactless IC cards.
- Apply I-CODE chip technology from Philips Semiconductors. Both I-CODE1 and I-CODE SLI types are available



### ■ Benefits

- Thin and flexible.
- Withstand bending.
- Easy secondary processing onto business forms (roll-to-roll).

### ■ General Specifications 1

Item	V720-D52P□□	V720S-D13P□□ (Available soon)
Applicable chip	I-CODE1	I-CODE SLI
Memory capacity	44 bytes (user area)	112 bytes (user area)
Memory type	64-byte EEPROM	128-byte EEPROM
Communications frequency	13.56 MHz	
Data retention time	10 years after data is written (at 55°C max.)	
Number of overwrites	100,000 times for each address	
Ambient temperature in operation	-10 to 55°C (with no icing)	
Ambient temperature in storage	-30 to 70°C (with no icing)	
Heat resistance	No communications error after leaving the product for 250 hours at 85°C	
Cold resistance	No communications error after leaving the product for 250 hours at -30°C	
Thermal shock resistance	No communications error after 100 cycles between 85°C and -30°C, holding 30 minutes at each temperature	
Vibration resistance	Destruction: 10 Hz to 2 kHz, 1.5-mm double amplitude, 150-m/s <sup>2</sup> acceleration with 10 sweeps of 11 minutes each in X, Y, and Z directions	
Shock resistance	Destruction: 500 m/s <sup>2</sup> 3 times each in X, Y, and Z directions	
Moisture resistance	No communications error after leaving the product for 250 hours at 85°C and 85% humidity	

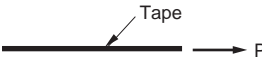
## ■ General Specifications 2

Item	V720-D52P01 V720S-D13P01	V720-D52P02 V720S-D13P02	V720-D52P03	V720-D52P04
Tape tension (P)	< 10 N 			
Bending diameter (D)	> 20 mm dia. 			
Static pressure (P)	< 10 MPa (10 N/mm <sup>2</sup> ) 			

## ■ Dimensions

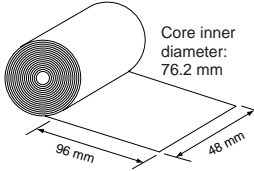
Item	V720-D52P01 V720S-D13P01	V720-D52P02 V720S-D13P02	V720-D52P03	V720-D52P04	<b>Dimensions of Tag Inlets</b> 
Width	48 ±0.3 mm				
Length per piece	96 ±0.3 mm <sup>(*)</sup>	48 ±0.3 mm	32 ±0.3 mm	32 ±0.3 mm	
Thickness at electronic parts	270+/-5 μm				
Overall thickness of copper antenna coil	50 +10 μm/-0 μm				
Size of antenna coil	46 × 75 mm	46 × 43 mm	Diameter 21	16.5 × 22 mm	

## ■ Tag Inlet Roll Delivery Form

Item	V720-D52P01 V720S-D13P01	V720-D52P02 V720S-D13P02	V720-D52P03	V720-D52P04
Appearance	Single-row roll form			
Number of functional units on 1 roll	1,000 pcs. (V720□-D□□P-R1K) and 5,000 pcs. (V720□-D□□P-R5K)			
Sheet length (1,000 pcs./5,000 pcs.)	Approx. 100/500 m	Approx. 50/250 m	Approx. 33/167 m	Approx. 33/167 m
Roll core	Paper core, inner diameter of 3 inches, outer diameter of 5 inches			
Outer diameter of roll (1,000 pcs./5,000 pcs.)	160/260 mm	Consult your OMRON dealer.		
Weight (1,000 pcs./5,000 pcs.)	0.7/2.4 kg	Consult your OMRON dealer.		
Identification of roll	Label on inner core with roll No., date of production, and type			

## ■ Communications Distance (\*1) (Measured at 25°C)

Read Write Antennas	V720-D52P01 V720S-D13P01	V720-D52P02 V720S-D13P02	V720-D52P03	V720-D52P04
V720□-H01	0 to 280 mm	0 to 220 mm	0 to 80 mm	0 to 80 mm
V720S-HMC73□	0 to 45 mm	0 to 45 mm	0 to 18 mm <sup>(*)</sup>	0 to 18 mm <sup>(*)</sup>

\*1: The communications distance may vary depending on surrounding noise and equipment.

\*2: The communications distance for writing is 5 to 18 mm.

**ALL DIMENSIONS SHOWN ARE IN MILLIMETERS.**

To convert millimeters into inches, multiply by 0.03937. To convert grams into ounces, multiply by 0.03527.

Cat. No. S901-E1-03 In the interest of product improvement, specifications are subject to change without notice.

**OMRON Corporation**

RFID Project Group

14th Fl, Gate City Osaki West Tower  
1-11 Osaki, Shinagawa-ku  
Tokyo, 141-0032 Japan  
Tel: (81)3-5435-2016/Fax: (81)3-5435-2017  
E-mail: card@dev.keijo.omron.co.jp  
URL: <http://www.omron.com/card/rfid/>

Printed in Japan  
0802 (0100)

# V720-series Electromagnetic Inductive RFID System CF II I/F Reader/Writer V720S-HMF01



V720S-HMF01

## ■ Product Description

OMRON's V720S-HMF01 CF II I/F Reader/Writer connects to a variety of PDAs (Personal Digital Assistants) to form a handy RFID reader/writer system. Its compact size ensures easy portability for use virtually anywhere.

## ■ Features

- Applies I-Code1 chip and I-Code SLI (ISO/IEC 15693) chip technology from Philips Semiconductors.
- Readily available PDA interface: Compact Flash Type 2 (<http://www.compactflash.org/>).
- Highly versatile functions, such as Read/Write modes, in a compact size.

## ■ Benefits

- Combining the V720S-HMF01 with a PDA costs much less than most handy RFID readers.

## ■ General Specifications

Item	Specifications
Communications frequency	13.56 MHz
Ambient temperature in operation	0 to 50°C (with no icing)
Weight	Approx. 30 g
Supply voltage	3.3 VDC ±5%
Antenna dimensions	52 (W) × 35 (H) × 16 (D) mm (The dimensions of the portion of the antenna extending from the PDA when the Unit is mounted in the PDA)
Current consumption	Approx. 175 mA (oscillating), Approx. 100 mA (not oscillating)
Communications range	30 mm with V720-D52P40
Interface	Compact Flash Type 2 (9,600 bps)

■ Dimensions

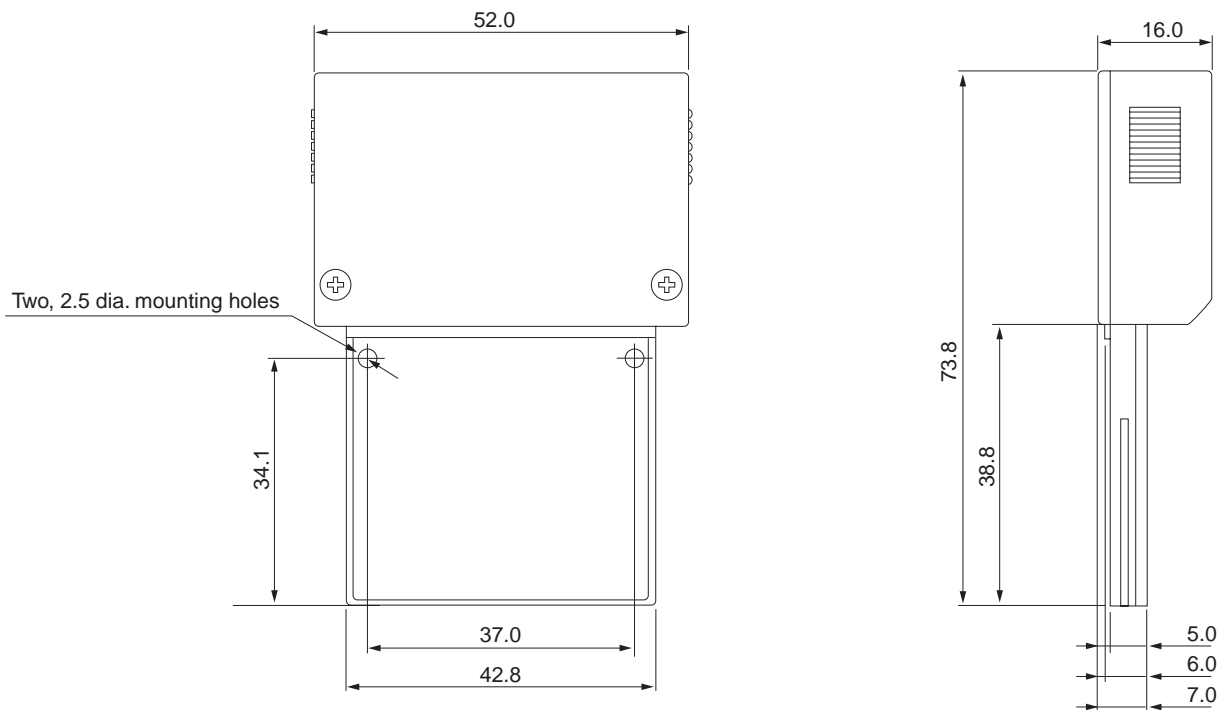

■ Communications Time (Reference Value)

Command	I-Code1	I-Code SLI
Read	$T = 1.3 N + 6.2$	$T = 1.3 N + 6$
Write	$T = 13 N + 13.5$	$T = 13.6 N + 15.5$

\* T = Communications time (msec)

\* N = Number of pages (1 page is 4 byte.)

■ Communications Range

**Communications Range between V720S-HMF01 and I-Code1 Tag Inlet**

Tag Inlet	V720-D52P01	V720-D52P02	V720-D52P03	V720-D52P04
Communications range*1	45	45	3 to 14	3 to 15

**Communications Range between V720S-HMF01 and I-Code SLI Tag Inlet**

Tag Inlet	V720S-D13P01	V720S-D13P02
Communications range*1	45	45

\*1 The communications range depends on the environmental conditions, such as temperature, humidity, electronic noise, etc.

**ALL DIMENSIONS SHOWN ARE IN MILLIMETERS.**

To convert millimeters into inches, multiply by 0.03937. To convert grams into ounces, multiply by 0.03527.

Cat. No. S927-E1-01 In the interest of product improvement, specifications are subject to change without notice.

**OMRON Corporation**

RFID Project Group

14th Fl, Gate City Osaki West Tower  
 1-11 Osaki, Shinagawa-ku  
 Tokyo, 141-0032 Japan  
 Tel: (81)3-5435-2016/Fax: (81)3-5435-2017  
 E-mail: card@dev.keijo.omron.co.jp  
 URL: <http://www.omron.com/card/rfid/>

Printed in Japan  
 0802 (0802)