

Cat. No. Q113-E1-07



**V700-series**

# **Electromagnetic Inductive RFID System**

# **OPERATION MANUAL**

**OMRON**



# **V700-series Electromagnetic Inductive RFID System**

## **Operation Manual**

*Revised March 2008*



## **READ AND UNDERSTAND THIS DOCUMENT**

Please read and understand this document before using the products. Please consult your OMRON representative if you have any questions or comments.

## **WARRANTY**

OMRON's exclusive warranty is that the products are free from defects in materials and workmanship for a period of one year (or other period if specified) from date of sale by OMRON.

OMRON MAKES NO WARRANTY OR REPRESENTATION, EXPRESS OR IMPLIED, REGARDING NON-INFRINGEMENT, MERCHANTABILITY, OR FITNESS FOR PARTICULAR PURPOSE OF THE PRODUCTS. ANY BUYER OR USER ACKNOWLEDGES THAT THE BUYER OR USER ALONE HAS DETERMINED THAT THE PRODUCTS WILL SUITABLY MEET THE REQUIREMENTS OF THEIR INTENDED USE. OMRON DISCLAIMS ALL OTHER WARRANTIES, EXPRESS OR IMPLIED.

## **LIMITATIONS OF LIABILITY**

OMRON SHALL NOT BE RESPONSIBLE FOR SPECIAL, INDIRECT, OR CONSEQUENTIAL DAMAGES, LOSS OF PROFITS OR COMMERCIAL LOSS IN ANY WAY CONNECTED WITH THE PRODUCTS, WHETHER SUCH CLAIM IS BASED ON CONTRACT, WARRANTY, NEGLIGENCE, OR STRICT LIABILITY.

In no event shall responsibility of OMRON for any act exceed the individual price of the product on which liability is asserted.

IN NO EVENT SHALL OMRON BE RESPONSIBLE FOR WARRANTY, REPAIR, OR OTHER CLAIMS REGARDING THE PRODUCTS UNLESS OMRON'S ANALYSIS CONFIRMS THAT THE PRODUCTS WERE PROPERLY HANDLED, STORED, INSTALLED, AND MAINTAINED AND NOT SUBJECT TO CONTAMINATION, ABUSE, MISUSE, OR INAPPROPRIATE MODIFICATION OR REPAIR.

## **SUITABILITY FOR USE**

THE PRODUCTS CONTAINED IN THIS DOCUMENT ARE NOT SAFETY RATED. THEY ARE NOT DESIGNED OR RATED FOR ENSURING SAFETY OF PERSONS, AND SHOULD NOT BE RELIED UPON AS A SAFETY COMPONENT OR PROTECTIVE DEVICE FOR SUCH PURPOSES. Please refer to separate catalogs for OMRON's safety rated products.

OMRON shall not be responsible for conformity with any standards, codes, or regulations that apply to the combination of products in the customer's application or use of the product.

At the customer's request, OMRON will provide applicable third party certification documents identifying ratings and limitations of use that apply to the products. This information by itself is not sufficient for a complete determination of the suitability of the products in combination with the end product, machine, system, or other application or use.

The following are some examples of applications for which particular attention must be given. This is not intended to be an exhaustive list of all possible uses of the products, nor is it intended to imply that the uses listed may be suitable for the products:

- Outdoor use, uses involving potential chemical contamination or electrical interference, or conditions or uses not described in this document.
- Nuclear energy control systems, combustion systems, railroad systems, aviation systems, medical equipment, amusement machines, vehicles, safety equipment, and installations subject to separate industry or government regulations.
- Systems, machines, and equipment that could present a risk to life or property.

Please know and observe all prohibitions of use applicable to the products.

NEVER USE THE PRODUCTS FOR AN APPLICATION INVOLVING SERIOUS RISK TO LIFE OR PROPERTY WITHOUT ENSURING THAT THE SYSTEM AS A WHOLE HAS BEEN DESIGNED TO ADDRESS THE RISKS, AND THAT THE OMRON PRODUCT IS PROPERLY RATED AND INSTALLED FOR THE INTENDED USE WITHIN THE OVERALL EQUIPMENT OR SYSTEM.

## **PERFORMANCE DATA**

Performance data given in this document is provided as a guide for the user in determining suitability and does not constitute a warranty. It may represent the result of OMRON's test conditions, and the users must correlate it to actual application requirements. Actual performance is subject to the OMRON Warranty and Limitations of Liability.

## **CHANGE IN SPECIFICATIONS**

Product specifications and accessories may be changed at any time based on improvements and other reasons.

It is our practice to change model numbers when published ratings or features are changed, or when significant construction changes are made. However, some specifications of the product may be changed without any notice. When in doubt, special model numbers may be assigned to fix or establish key specifications for your application on your request. Please consult with your OMRON representative at any time to confirm actual specifications of purchased products.

## **DIMENSIONS AND WEIGHTS**

Dimensions and weights are nominal and are not to be used for manufacturing purposes, even when tolerances are shown.

## **ERRORS AND OMISSIONS**

The information in this document has been carefully checked and is believed to be accurate; however, no responsibility is assumed for clerical, typographical, or proofreading errors, or omissions.

## **PROGRAMMABLE PRODUCTS**

OMRON shall not be responsible for the user's programming of a programmable product, or any consequence thereof.

## **COPYRIGHT AND COPY PERMISSION**

This document shall not be copied for sales or promotions without permission.

This document is protected by copyright and is intended solely for use in conjunction with the product. Please notify us before copying or reproducing this document in any manner, for any other purpose. If copying or transmitting this document to another, please copy or transmit it in its entirety.

## ***Precautions for Safe Use***

To ensure safety, be sure to follow the following precautions:

1. Do not operate this device in any flammable, explosive, or corrosive gas environment.
2. Do not disassemble, repair, or remodel this device.
3. Tighten the base lock screws and terminal block screws completely.
4. Be sure to use wiring crimp terminals of the specified size.
5. If any cable has a locking mechanism, be sure to check that it has been locked before using it.
6. The DC power supply must meet the following items:
  - (1) The DC power supply must be used for the V700 Series only and must not be connected to any other devices or apparatuses.
  - (2) The voltage of the DC power supply must be within the specified rating (24 VDC+10%–10%).
7. Be sure to follow any other warnings, cautions, and notices given in this manual.
8. In the event that the system gives out a foul smell, is heated abnormally in the main body portion, emits smoke, or exhibits any other abnormal condition, immediately stop using the system and turn off the power.
9. Dispose of this product as industrial waste.

## ***Precautions for Correct Use***

Please observe the following precautions to prevent failure to operate, malfunctions, or undesirable effects on product performance.

### **Installation Site**

Install the product at a location where:

- It is not exposed to corrosive gases, dust, metal chips, or salt.
- The working temperature is within the range stipulated in the specifications.
- There are no sudden variations in temperature (no condensation).
- The relative humidity is within the range stipulated in the specifications.
- No vibration or shock exceeding the values stipulated in the specifications is transmitted directly to the body of the product.
- It is not subject to splashing water, oil, or chemical substances.

### **Installation**

- 125 kHz frequency band to communicate with ID Tags. Some devices, such as some transceivers, motors, inverters, switching power supplies, and monitoring devices, generate electromagnetic waves (i.e., noise) that can affect communications with ID Tags. If any of these devices are nearby, communications with Data Carriers may be affected or Data Carriers may be destroyed. If the product is to be used near such devices, check the effects on communications before using the product.
- To minimize the general influence of noise, follow the following precautions:
  - (1) Ground any metallic material located around this device to 100  $\Omega$  or less.
  - (2) Wire this device keeping the wiring away from high voltage and heavy current.
- Connectors are not waterproof. Do not use the product in a humid environment.
- Do not use any chemical that may affect the materials of the product.

### **Cleaning**

- Do not use any thinner. Resin material and case paint are dissolved by thinner.

© **OMRON, 1998**

All rights reserved. No part of this publication may be reproduced, stored in a retrieval system, or transmitted, in any form, or by any means, mechanical, electronic, photocopying, recording, or otherwise, without the prior written permission of OMRON.

No patent liability is assumed with respect to the use of the information contained herein. Moreover, because OMRON is constantly striving to improve its high-quality products, the information contained in this manual is subject to change without notice. Every precaution has been taken in the preparation of this manual. Nevertheless, OMRON assumes no responsibility for errors or omissions. Neither is any liability assumed for damages resulting from the use of the information contained in this publication.



# TABLE OF CONTENTS

<b>PRECAUTIONS</b> .....	<b>xiii</b>
1 Intended Audience .....	xiv
2 General Precautions .....	xiv
3 Safety Precautions .....	xiv
4 Application Precautions .....	xiv
5 Correct Use .....	xv
6 Standard Conformity .....	xv
<b>SECTION 1</b>	
<b>Characteristics and System Configuration</b> .....	<b>1</b>
1-1 Characteristics .....	2
1-2 System Configuration .....	4
1-3 Outline of Operation .....	6
<b>SECTION 2</b>	
<b>Specifications and Performance</b> .....	<b>7</b>
2-1 Controller .....	8
2-2 Antenna .....	13
2-3 ID Tag .....	16
2-4 Cable .....	19
2-5 External Communications Specifications .....	20
2-6 V700 Communications Specifications .....	20
<b>SECTION 3</b>	
<b>Functions</b> .....	<b>23</b>
3-1 Single, FIFO Read/Write, and Multiple, Simultaneous Access Functions .....	24
3-2 Write Protect Function .....	25
3-3 Memory Check Function .....	25
3-4 Mutual Interference Preventive Function (Synchronous Function) .....	26
3-5 Energy-saving Mode .....	28
3-6 Long-distance Mode and Stable Communications Mode (Communications Distance Setting) .....	28
3-7 Noise Environment Measurement Function .....	29
3-8 Error Logging Function .....	29
<b>SECTION 4</b>	
<b>Setting, Mounting, and Connection Methods</b> .....	<b>31</b>
4-1 Controller .....	32
4-2 Installation of Antenna .....	52
4-3 ID Tag .....	54
<b>SECTION 5</b>	
<b>Communications Functions</b> .....	<b>57</b>
5-1 Commands and Responses .....	58
5-2 Movement of ID Tag and Command .....	59
5-3 Communications Operating Sequence .....	59
5-4 Command and Response Frame Structure .....	67
5-5 Command List .....	69
5-6 List of Options .....	70
5-7 Data Code Designation .....	70
5-8 Explanation of Commands and Responses .....	73
5-9 ACK/NACK Control .....	73

# TABLE OF CONTENTS

5-10 Communications Commands .....	74
5-11 Communications Subcommands .....	84
5-12 Control Commands .....	85
5-13 Host Command .....	86
5-14 Host Subcommands .....	86
5-15 Other Command .....	87
5-16 Response Codes .....	87
5-17 Connecting Commands .....	88
5-18 Communications Programming Example .....	89
<b>SECTION 6</b>	
<b>Programming Console .....</b>	<b>91</b>
6-1 Introduction .....	92
6-2 Nomenclature .....	92
6-3 External Dimensions .....	92
6-4 Connecting the Programming Console .....	93
6-5 Operation .....	95
6-6 Functions .....	96
<b>SECTION 7</b>	
<b>Startup and Full Operation .....</b>	<b>109</b>
7-1 Trial Operation .....	110
7-2 Self-diagnostic Function .....	111
7-3 List of Errors .....	111
7-4 Errors and Remedies .....	112
7-5 Maintenance and Inspection .....	113
7-6 Troubleshooting .....	115
<b>SECTION 8</b>	
<b>Reference Data .....</b>	<b>121</b>
8-1 Maximum Communications Distance .....	122
8-2 Communications Distance Characteristics vs. Ambient Noise .....	123
8-3 Communications Areas .....	125
8-4 Communications Time .....	129
8-5 Influence of Background Metal on Antenna .....	131
8-6 Mutual Interference between Antennas .....	134
8-7 Mutual Interference between Proximity Sensor and Antenna .....	136
8-8 Influence of Background Metal on ID Tag .....	137
8-9 Influence of ID Tag Incline .....	140
8-10 Influence of ID Tag Angle .....	140
8-11 Chemical Resistance of ID Tag .....	141
8-12 Relationship between ID Tag and Metal Sensor .....	142
<b>Appendices</b>	
A ASCII Code .....	143
B Standard Models .....	145
<b>Index .....</b>	<b>147</b>
<b>Revision History .....</b>	<b>151</b>

## ***About this Manual:***

This manual describes the installation and operation of the V700-series Electromagnetic Inductive RFID System and includes the sections described below.

Please read this manual carefully and be sure you understand the information provided before attempting to install and operate the V700-series Electromagnetic Inductive RFID System.

**Section 1** provides the characteristics and system configuration of the V700 System as well as an outline of its operation.

**Section 2** provides the specifications and performance characteristics of each component of the V700 System.

**Section 3** provides the modes and functions in detail.

**Section 4** provides installation information for the V700 System.

**Section 5** provides the communications functions and provides details on communications-related data and commands.

**Section 6** provides the installation and use of the Programming Console in relation to the V700 System.

**Section 7** provides information on trial operation, errors and remedies, and maintenance and troubleshooting.

**Section 8** provides reference data relating to V700 communications, ID Tags, Antennas, and proximity sensors.

The **Appendices** provide an ASCII code table and a list of standard models.



### **WARNING**

Failure to read and understand the information provided in this manual may result in personal injury or death, damage to the product, or product failure. Please read each section in its entirety and be sure you understand the information provided in the section and related sections before attempting any of the procedures or operations given.



# PRECAUTIONS

This section provides general precautions for using the V700-series Electromagnetic Inductive RFID System and related devices.

**The information contained in this section is important for the safe and reliable application of the V700-series Electromagnetic Inductive RFID System. You must read this section and understand the information contained before attempting to set up or operate a V700-series Electromagnetic Inductive RFID System.**

1 Intended Audience .....	xiv
2 General Precautions .....	xiv
3 Safety Precautions .....	xiv
4 Application Precautions .....	xiv
5 Correct Use .....	xv
6 Standard Conformity .....	xv

## 1 Intended Audience

This manual is intended for the following personnel, who must also have knowledge of electrical systems (an electrical engineer or the equivalent).

- Personnel in charge of installing FA systems.
- Personnel in charge of designing FA systems.
- Personnel in charge of managing FA systems and facilities.

## 2 General Precautions

The user must operate the product according to the performance specifications described in the operation manuals.

Before using the product under conditions which are not described in the manual or applying the product to nuclear control systems, railroad systems, aviation systems, vehicles, combustion systems, medical equipment, amusement machines, safety equipment, and other systems, machines, and equipment that may have a serious influence on lives and property if used improperly, consult your OMRON representative.

Make sure that the ratings and performance characteristics of the product are sufficient for the systems, machines, and equipment, and be sure to provide the systems, machines, and equipment with double safety mechanisms.

This manual provides information for installing and operating the V700-series Electromagnetic Inductive RFID System. Be sure to read this manual before attempting to use the System and keep this manual close at hand for reference during operation.

 **WARNING** It is extremely important that a V700-series Electromagnetic Inductive RFID System be used for the specified purpose and under the specified conditions, especially in applications that can directly or indirectly affect human life. You must consult with your OMRON representative before applying the System to the above-mentioned applications.

## 3 Safety Precautions

 **WARNING** Always connect to a class-3 ground (to 100  $\Omega$  or less) when installing the System. Not connecting to a class-3 ground may result in electric shock.

 **WARNING** Do not touch any of the terminals or terminal blocks while the power is being supplied. Doing so may result in electric shock.

 **WARNING** Do not attempt to take any unit apart or touch the inside while the power is being supplied. Doing so may result in electric shock.

## 4 Application Precautions

 **Caution** Be sure to observe the following precautions to ensure safety in installing or operating the System.

- Do not use the System in an environment subject to flammable, explosive, or corrosive gases.
- Do not attempt to take any Units apart, to repair any Units, or to modify any Units in any way.

- Be sure that all the mounting screws, terminal screws, and cable connector screws are tightened to the torque specified in the relevant manuals.
- Use crimp terminals of specified size for wiring.
- Be sure that the items with locking devices are properly locked into place before using the System.
- Be sure that the DC Power Supply Unit exclusively designed for the V700 Series is used and is not connected to any other device.
- Be sure that the power supply voltage is within the rated range of 24 VDC+10% and -15%.
- Do not remove the ferrite cores attached to the V700-H01 and V700-H02.
- Install the ferrite core supplied with the V700-CD1D according to the specified instructions.
- Be sure to observe all warnings, cautions, and safety precautions specified in the manual.

## 5 Correct Use

 **Caution** Do not install the V700-H01, V700-H02 or V700-CD1D System in the following locations:

- Locations subject to direct sunlight.
- Locations subject to condensation as the result of severe changes in temperature.
- Locations subject to corrosive or flammable gases.
- Locations subject to shock or vibration.

 **Caution** Be sure to observe the following wiring precautions:

- Do not wire the lines of the RFID System alongside high-tension or power lines.
- Check the polarity of each terminal and make sure not to make mistakes in polarity.

 **Caution** Be sure to observe the following precaution when cleaning the V700-H01, V700-H02, or V700-CD1D:

- Organic solvents may damage the paint coating on the casing or resin part of the product. Do not use paint thinner or any other organic solvent to clean the product.

## 6 Standard Conformity

1. FCC (U.S. Federal Communications Commission)  
FCC Part 15 Subpart C  
FCC ID: E6CYCIDV7000198

Heed the following precautions when using the product.

- Shielded cables and connectors must be used for connection to the computer and peripheral devices to meet FCC emission limits.
- The included ferrite cores (TDK Type ZCAT2032-0930 or the equivalent) must be attached to the DC power supply line and the D-type ground line to suppress RF interference.
- To suppress RF interference, do not remove the ferrite core (TDK ZCAT2035-0930A-BK) that is attached to the antenna cable.

Heed the following precautions when using the product.

- The V700-CD1D-V3, V700-CD2D-V3, V700-H01, and V700-H02 are not compliant with European radio standards.
- Shielded cables and connectors must be used for connection to the computer and peripheral devices to meet regulated emission limits.
- The included ferrite cores (TDK Type ZCAT2032-0930 or the equivalent) must be attached to the DC power supply line and the D-type ground line to suppress RF interference.
- To suppress RF interference, do not remove the ferrite core (TDK ZCAT2035-0930A-BK) that is attached to the antenna cable.



# SECTION 1

## Characteristics and System Configuration

This section provides the characteristics and system configuration of the V700 System as well as an outline of its operation.

- 1-1 Characteristics ..... 2
- 1-2 System Configuration ..... 4
  - 1-2-1 Example of V700-CD1D-V3 System Configuration ..... 4
  - 1-2-2 Example of V700-CD2D-V3 System Configuration ..... 5
- 1-3 Outline of Operation ..... 6

# 1-1 Characteristics

The V700-series Electromagnetic Inductive RFID System is ideal for the construction of highly functional, long-distance wireless ID systems for material control and logistics.

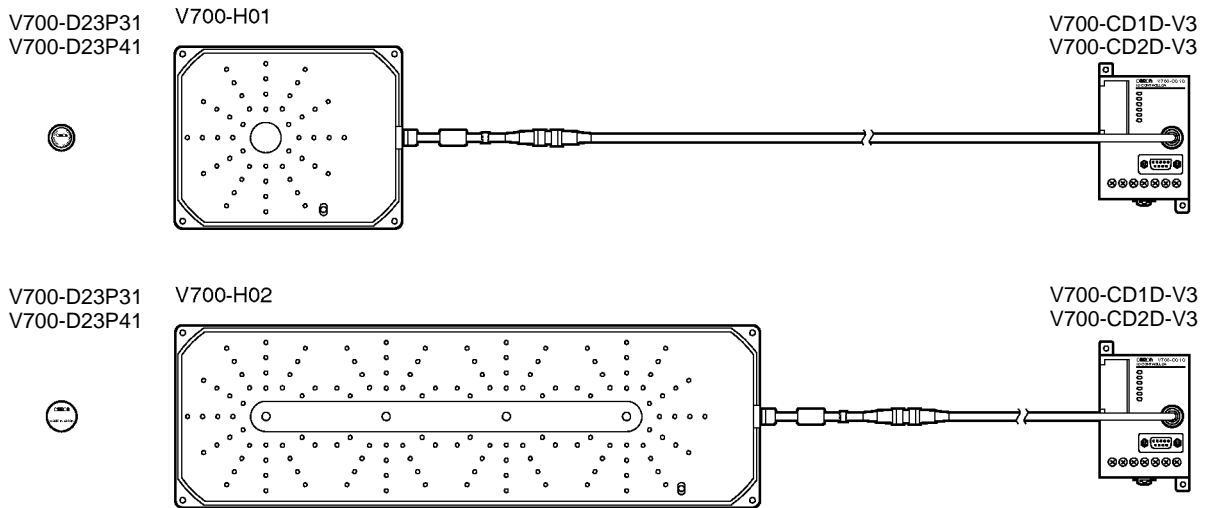

**V700-CD1D-V3/  
V700-CD2D-V3  
(RFID) Controller**

The V700-CD1D-V3/V700-CD2D-V3 incorporates an RS-232C interface, thus connecting to personal computers and Programmable Controllers (PCs) over RS-232C to process large amounts of data flexibly with simple commands.

**V700-H01 and V700-H02  
(RFID) R/W Antennas**

The V700-H01 is a standard antenna that is 250 by 200 mm in size, ideal for long-distance communications, and ensuring a minimum communications distance of 250 mm. The V700-H02 is a wide-field antenna that is 650 by 200 mm in size. Compared with the V700-H01, the V700-H02 provides rough positioning and better communications with ID Tags moving at high-speed.

**V700-D23P31 and  
V700-D23P41 (RFID) Tags**

The V700-D23P31 Data Carrier has a memory capacity of 240 bytes. It is coin-shaped and measures only 20 mm across. It resists water, chemicals, and other elements of harsh environments and can hold data for 200 hours at 180°C. The V700-D23P41 Data Carrier also has a memory capacity of 240 bytes. It is bar-shaped and only 3.9 mm in diameter and 25 mm long. It mounts easily in drill holes or other tight locations, simplifying mounting to machines or products. It holds up under harsh environments and can hold data from -40 to 110°C, is highly resistant to water and can be stored at a wide range of temperatures.

**Highly Functional RFID  
System**

The RFID System operates in either multiple, simultaneous access mode or FIFO (first-in, first-out) read/write mode. In multiple, simultaneous access mode, if there is more than one ID Tag in the communications area, the RFID System reads and writes data from and to the all ID Tags at one time. In FIFO read/write mode, the RD-ID System reads and writes data to one ID Tag after another as they come into the communications area.

**Ease of Use**

The C200H-PRO27-E Programming Console (sold separately) can be connected to the RFID System over the V700-P10 Programming Console Conversion Cable (sold separately). With the Programming Console, the communications condition of the System can be monitored on-line. Furthermore, the error log of the System and the ambient noise measurement in the communications area can be read with ease. All these functions make it possible to start up the System quickly and improve the efficiency of on-site maintenance work on the System.

**Differences between V700-CD1D-V2 and V700-CD1D-V3**

The V700-CD1D-V3 adds the following features to those of the V700-CD1D-V2. They are upwardly compatible with the V700-CD1D-V2, so the V700-CD1D-V2 can be replaced by the V700-CD1D-V3 just as it is.

- 1, 2, 3... 1. Communications Format Settings  
 BBC can be enabled or disabled in the command and response format between the host and the Controller.

**BCC Enabled**

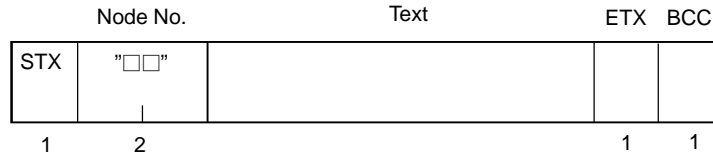

**BCC Disabled**

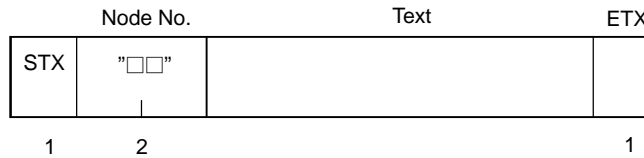

This setting is made at pin 1 of DIP switch SW3.

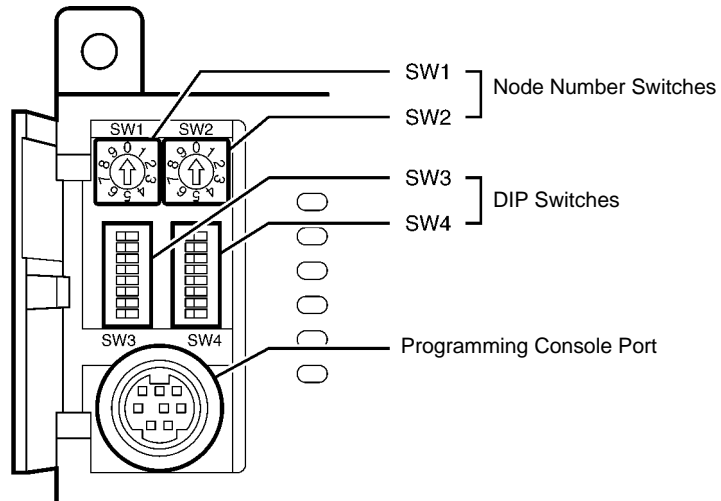

SW3, pin 1	Setting
ON	BCC disabled
OFF	BCC enabled (default)

2. Checking the Communications Format Using the Programming Console  
 The Controller's communications format settings can be checked in the Programming Console's settings display.

**BCC Enabled (Pin 1 Set to OFF)**

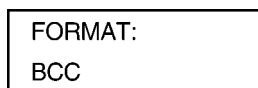

**BCC Disabled (Pin 1 Set to ON)**

FORMAT:  
NO BCC

## 1-2 System Configuration

### 1-2-1 Example of V700-CD1D-V3 System Configuration

The V700-CD1D-V3 has a built-in serial interface conforming to RS-232C, thus making it possible to communicate with personal computers and PCs. The host issues all commands to process all communications with the Tag ID.

**Host**

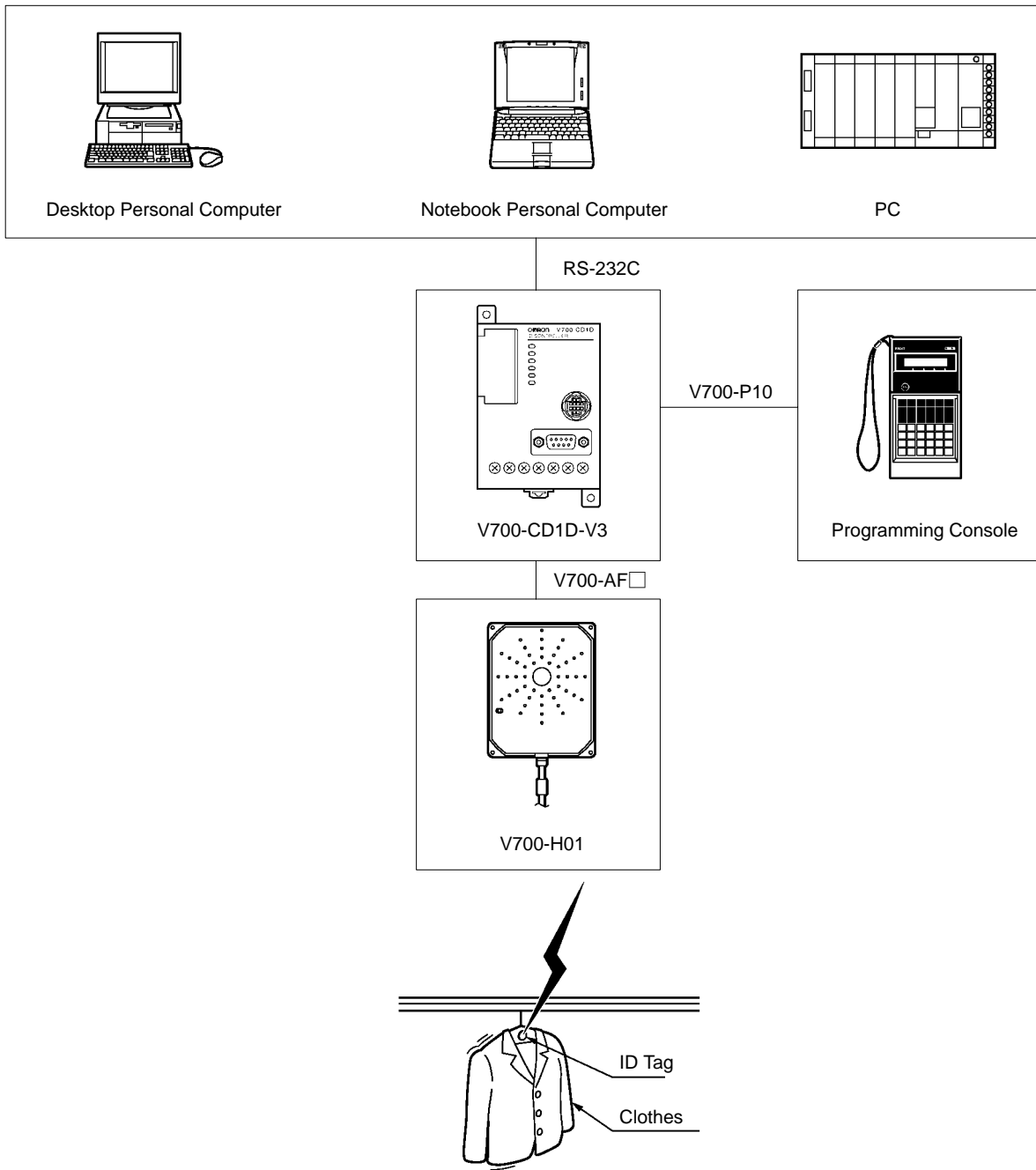

### 1-2-2 Example of V700-CD2D-V3 System Configuration

The V700-CD2D-V3 has a built-in RS-485 interface, so a maximum of 31 RS-485 Controllers can be connected to a single host device such as a personal computer or PC. The maximum total length of the RS-485 cable is 300 meters.

#### Host

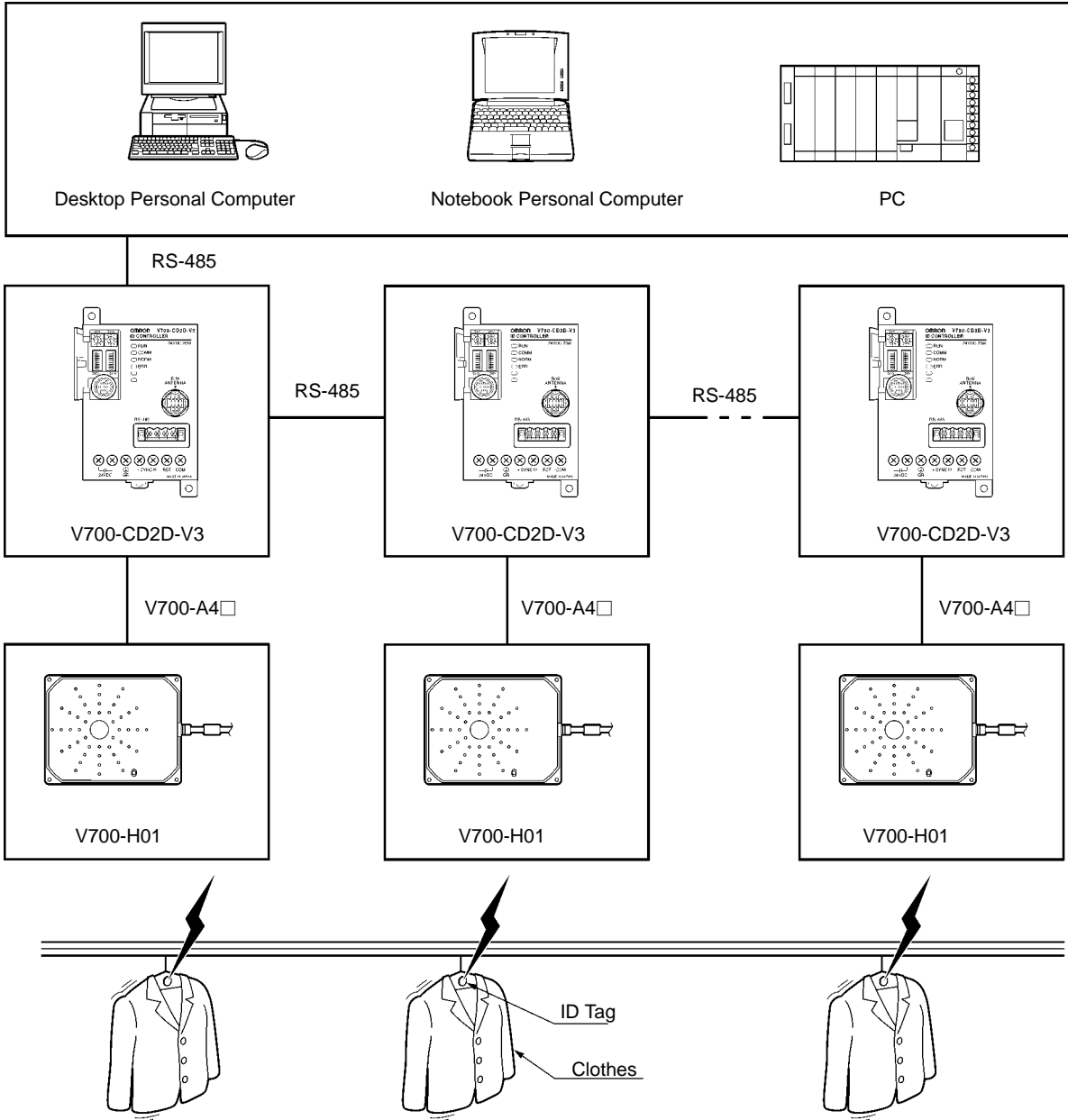

# 1-3 Outline of Operation

The following provides an overview of the operation of the RFID System using an example that sorts items of clothing each attached with an ID Tag.

## Host

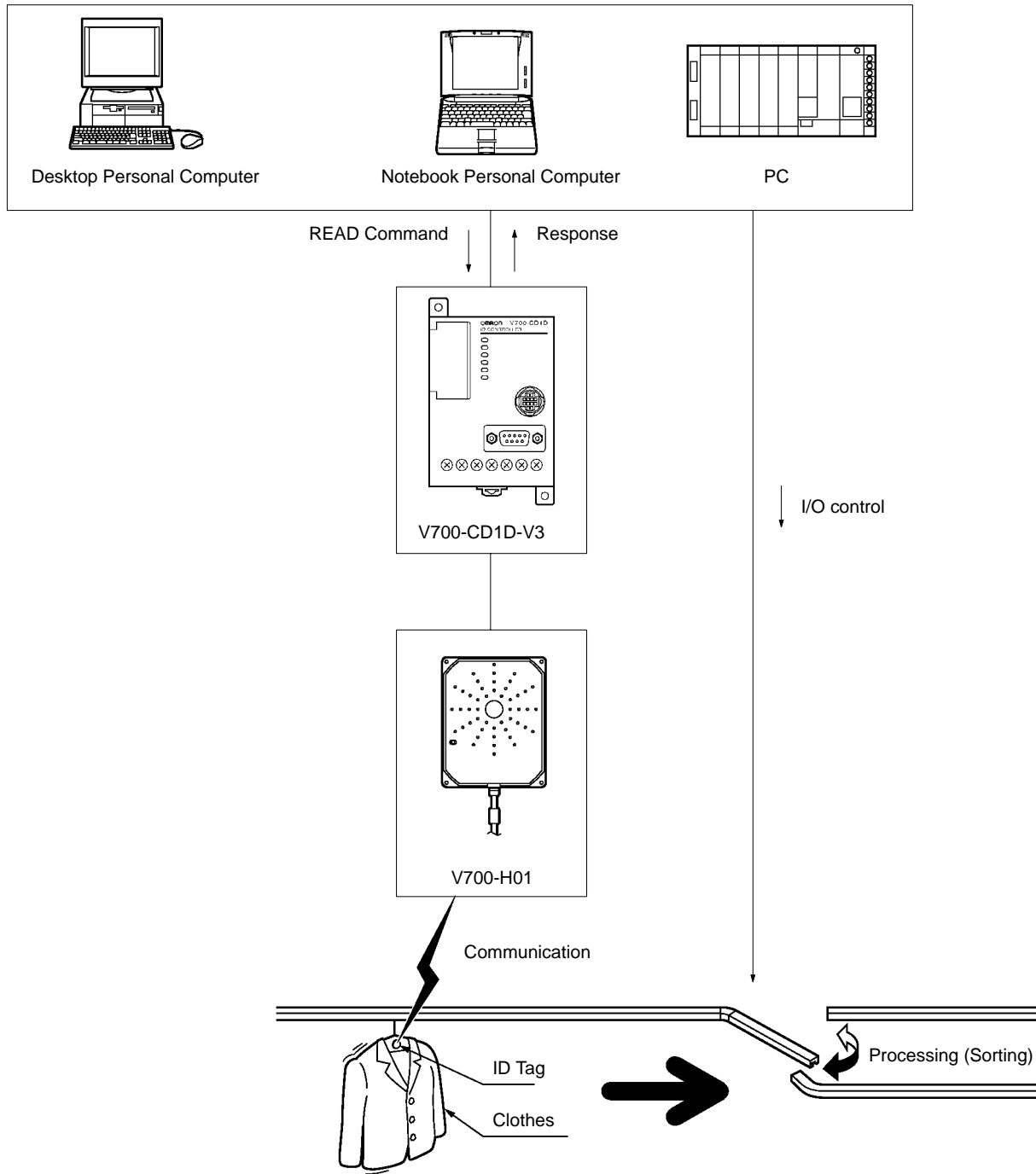

- 1, 2, 3...**
1. When the host sends the command to the Controller, the Antenna stands by for the arrival of the ID Tag.
  2. When the ID Tag arrives in the communications area, the Controller receives data in the memory area of an ID Tag specified by the READ command and sends the data as a response to the host.
  3. The host sorts the clothes on the basis of the data.

# SECTION 2

## Specifications and Performance

This section provides the specifications and performance characteristics of each component of the V700 System.

2-1	Controller .....	8
2-1-1	Nomenclature .....	8
2-1-2	Specifications .....	10
2-1-3	Dimensions .....	13
2-2	Antenna .....	13
2-2-1	Specifications .....	13
2-2-2	Dimensions .....	14
2-3	ID Tag .....	16
2-3-1	Specifications .....	16
2-3-2	Dimensions .....	17
2-3-3	Memory Map .....	18
2-3-4	V700-A80 Attachment (For V700-D□□P31) .....	19
2-4	Cable .....	19
2-4-1	Specifications .....	19
2-4-2	Dimensions .....	20
2-5	External Communications Specifications .....	20
2-6	V700 Communications Specifications .....	20

## 2-1 Controller

### 2-1-1 Nomenclature

#### V700-CD1D-V3

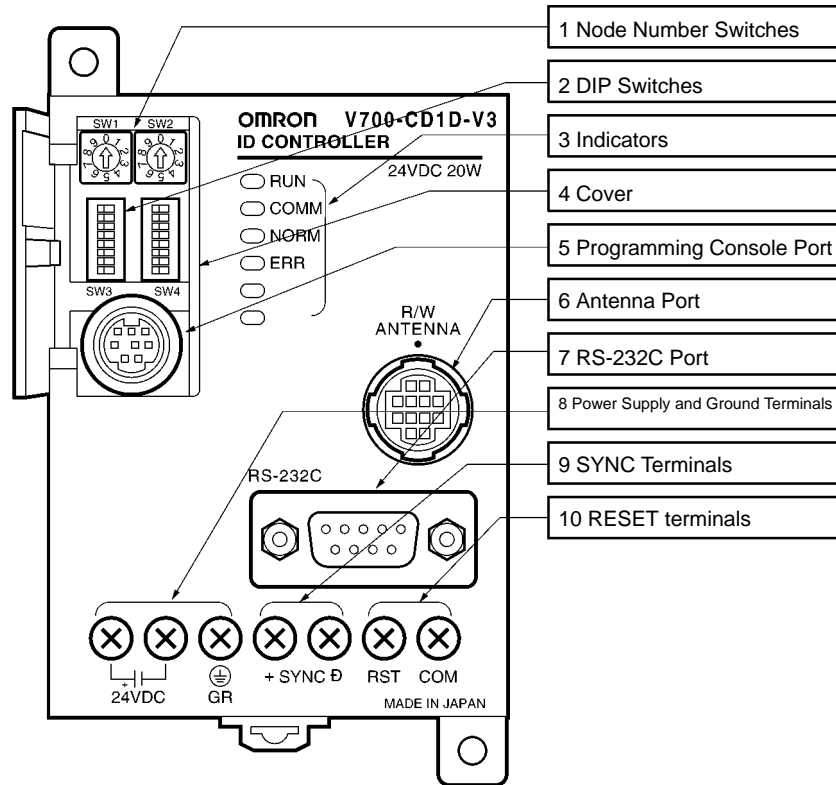

#### V700-CD2D-V3

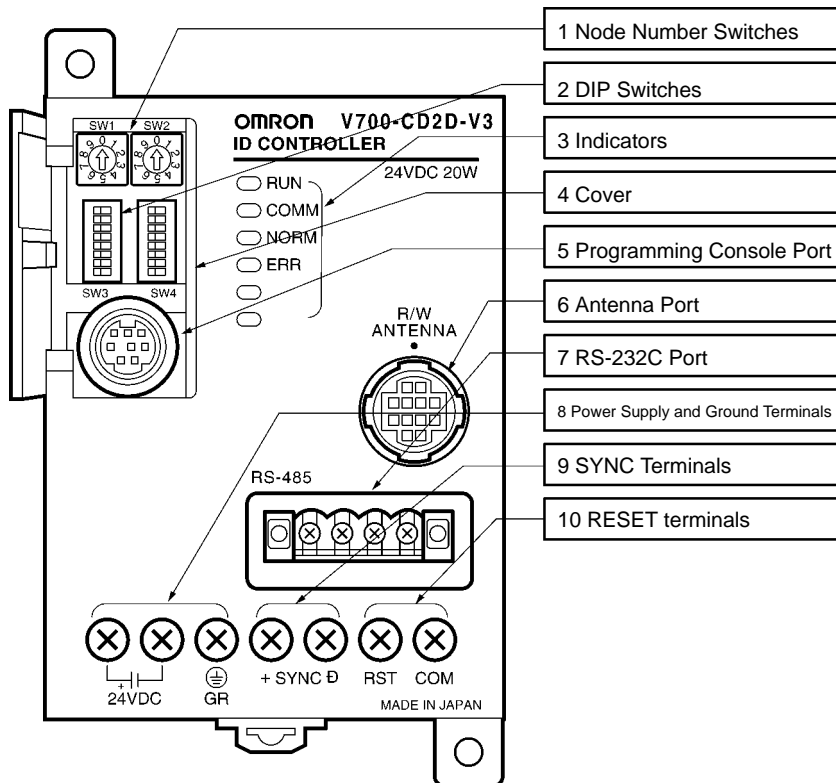



Refer to all sections following this section for the functions of the Controller in detail. Refer to *Section 4 Setting, Mounting and Connection Methods* for the settings and connections of the Controller.

No.	Name	Function	Description
1	Node number switch	Used for node number settings	The node number is used to identify each Controller when a single host computer is connected to a maximum of 32 Controllers.
2	DIP switch	Used for mode settings	Various settings are possible (e.g., communications synchronization, energy-saving, communications distance, terminating resistance, baud rate, data length, parity, stop bit length, communications mode, and time-out settings).
3	Indicator	The following indicators are available.	
	RUN	Green	RUN indicator Turns ON when the Controller is in normal operation.
	COMM	Green	Communications indicator Turns ON when the Controller is in communications with the ID Tag.
	NORM	Green	Normal indicator Turns ON and OFF once when the communications finish with no error.
	ERR	Red	Error indicator Turned ON and OFF once if a communications error results. Turned ON if a system error results.
4	Cover	Protection of SW1 through SW4 and the Programming Console port	Open the cover only when necessary.
5	Programming Console port	Connecting to the Programming Console	OMRON's C200H-PRO27-E Programming Console (sold separately) can be connected through the V700-P10 Programming Console Conversion Cable (sold separately). The V700-P10 is provided with a dedicated key sheet used for the operation of the Programming Console.
6	Antenna Port	Connecting to the Antenna	A single Antenna can be connected through the V700-A4□ Antenna Cable (sold separately). The following Antennas are available. <ul style="list-style-type: none"> <li>• V700-H01 (standard antenna, 250 x 200 mm in size)</li> <li>• V700-H02 (wide-field antenna, 650 x 200 mm in size)</li> </ul>
7	RS-232C port	Connecting to host devices	Personal computers and PCs can be connected over RS-232C.
8	Power supply terminals	Connecting to power supply	
	24 VDC+	Connecting to power supply	Connect 24 VDC.
	24 VDC-		Connect 0 V.
	GR	Connecting to ground	Ground this terminal at a resistance of less than 100Ω.
9	SYNC terminals	Used for synchronization	
	SYNC+	Connecting to synchronous signal	These terminals are used together for synchronizing more than one Controller in order to reduce the distance of mutual interference of each corresponding Antenna.
	SYNC-		
10	RESET terminals	Connecting to RESET signal	
	RST	RESET signal	These terminals are used together in order to use external RESET input.
	COM	COMMON signal	

## 2-1-2 Specifications

### General Specifications

Item	Specification
Supply voltage	24 VDC +10%/−15%
Power consumption	20 W max. including the power consumption of the Antenna (1.1 A at 12 V) and the Programming Console (150 mA at 5 V)
Insulation resistance	20 MΩ min. (at 100 VDC) between the ground and both power supply terminals, both power supply terminals and both I/O terminals, both power supply terminals and casing, both I/O terminals and ground, both I/O terminals and casing, and ground terminal and casing.
Dielectric strength	500 VAC (50/60 Hz) for 1 minute in any of the above combinations.
Vibration resistance	Destruction: 10 to 150 Hz, 0.3-mm double amplitude at 20 m/s <sup>2</sup> in X, Y, and Z directions four times each for 8 minutes
Shock resistance	Destruction: 200 m/s <sup>2</sup> in X, Y, and Z directions 3 times each
Ambient operating temperature	−10°C to 55°C (with no icing)
Ambient operating humidity	35% to 85% (with no condensation)
Ambient storage temperature	−25°C to 65°C (with no icing)
Ground	Ground at a resistance of less than 100 Ω.
Construction	Panel-mounting
Material	PC/ASA resin
Weight	Approx. 290 g
Number of connectable Antennas	1
Applicable standards	EN50081-2, EN50082-2

### Performance Specifications

Item	Specification
Self-diagnostics	CPU, host communications, Controller communications, and synchronous communications errors are checked.

### I/O Specifications

#### External RESET Input

Input voltage	24 VDC +10%/−15% (including ripples)
Input impedance	2.2 kΩ
Input current	10 mA TYP (24 VDC)
ON voltage	19 V min.
OFF voltage	5 V max.
Input response time	70 ms max.

#### Circuit Configuration

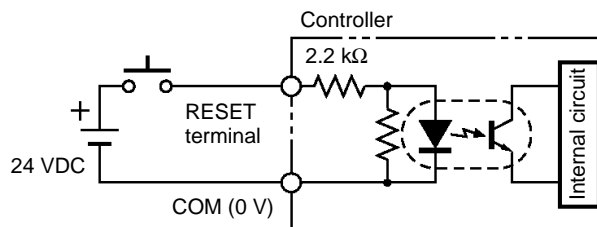

#### SYNC

I/O interface	Conforms to RS-485
---------------	--------------------

Circuit Configuration

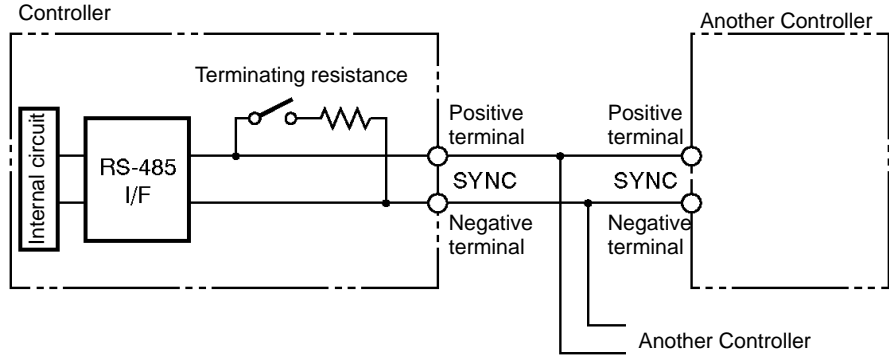

**CAUTION**

The positive SYNC or negative SYNC terminal is not an RS-485 terminal. Do not connect anything other than coaxial cables to these terminals.

**Wiring Example**

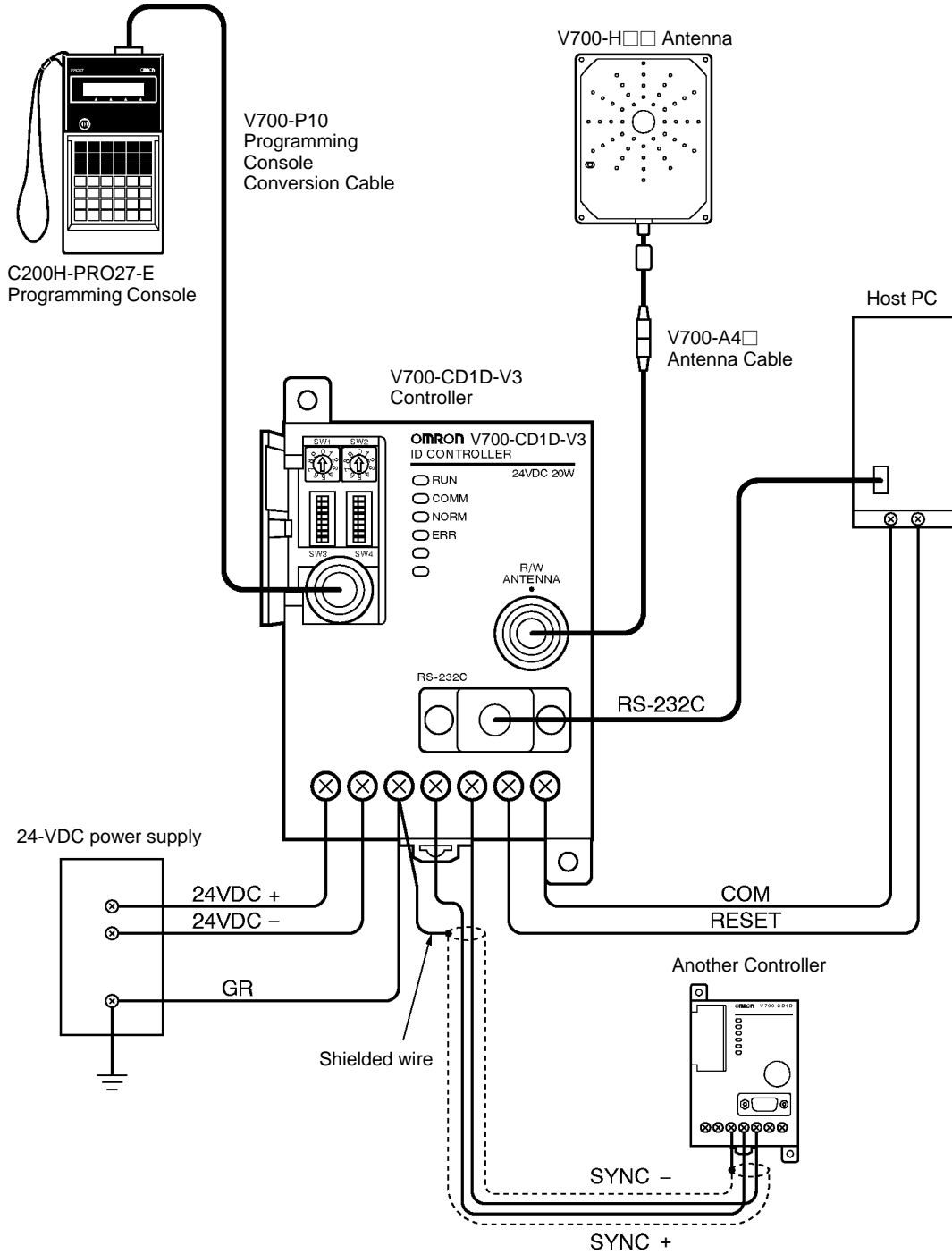

### 2-1-3 Dimensions

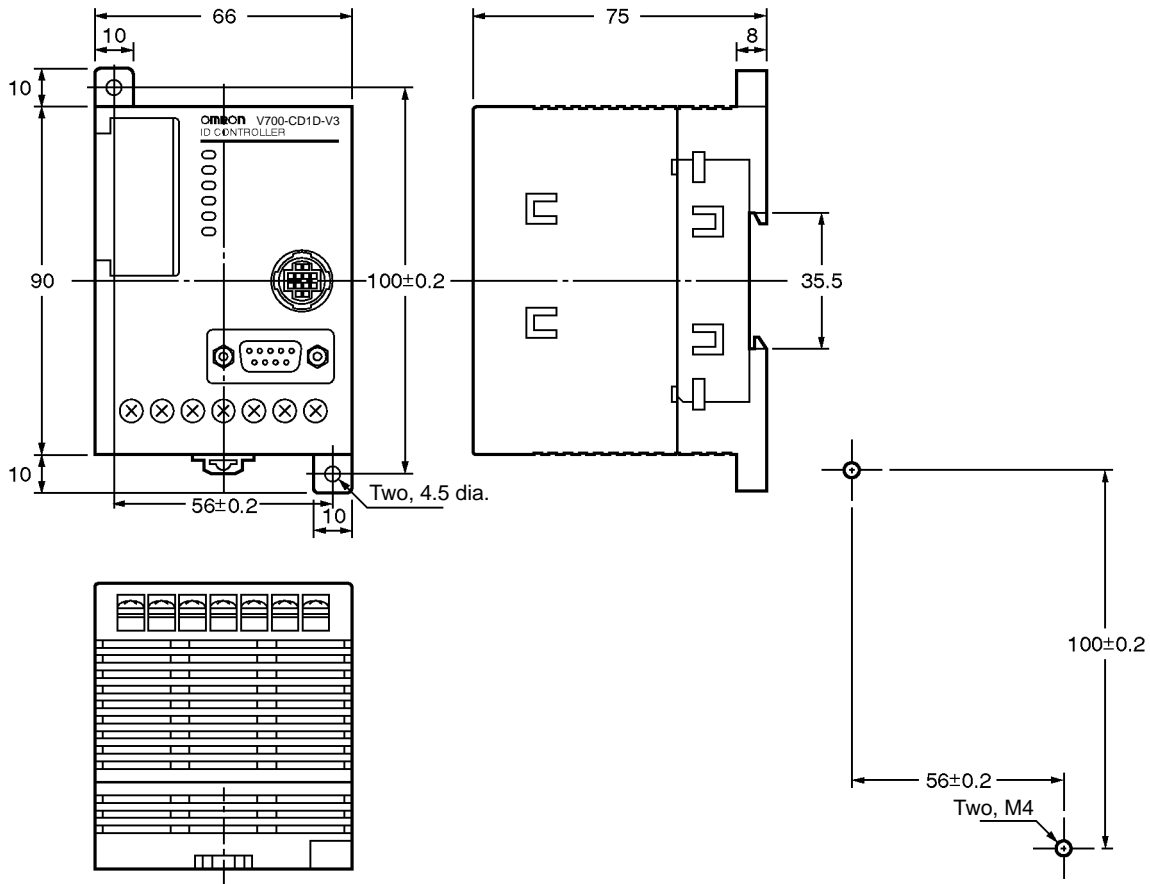

Casing material: PC/ASA resin

## 2-2 Antenna

### 2-2-1 Specifications

Item	Model	
	V700-H01	V700-H02
Oscillation frequency	125 kHz	
Ambient operating temperature	-20°C to 55°C (with no icing)	
Ambient storage temperature	-35°C to 65°C (with no icing)	
Ambient operating humidity	35% to 85% (with no condensation)	
Insulation resistance	50 MΩ min. (500 VDC) between the cable terminal and casing.	
Dielectric strength	1,000 VAC min. (50/60 Hz) between the cable terminal and casing for 1 minute	
Degree of protection	IP40 (except connector)	
Vibration resistance	Destruction: 10 to 150 Hz, 1.5 mm double amplitude at 100 m/s <sup>2</sup> in X, Y, and Z directions twice each for 8 minutes	
Shock resistance	Destruction: 200 m/s <sup>2</sup> three times each in X, Y, and Z directions	
Communications error detection	Bilateral use of CRC (Cyclic Redundancy Check) 16 bits	
Cable length	0.1 m (use an extension cable to connect to the Controller up to 50.1 m)	
LED indication	Power supply: Green Communications: Orange	
Weight	Approx. 800 g	Approx. 1,800 g
Electric field strength	15 μV/m maximum at a distance of λ/2π.	

**! CAUTION**  
 The Connector is not water-resistant. Make sure that the connector is free of water.

### 2-2-2 Dimensions

V700-H01

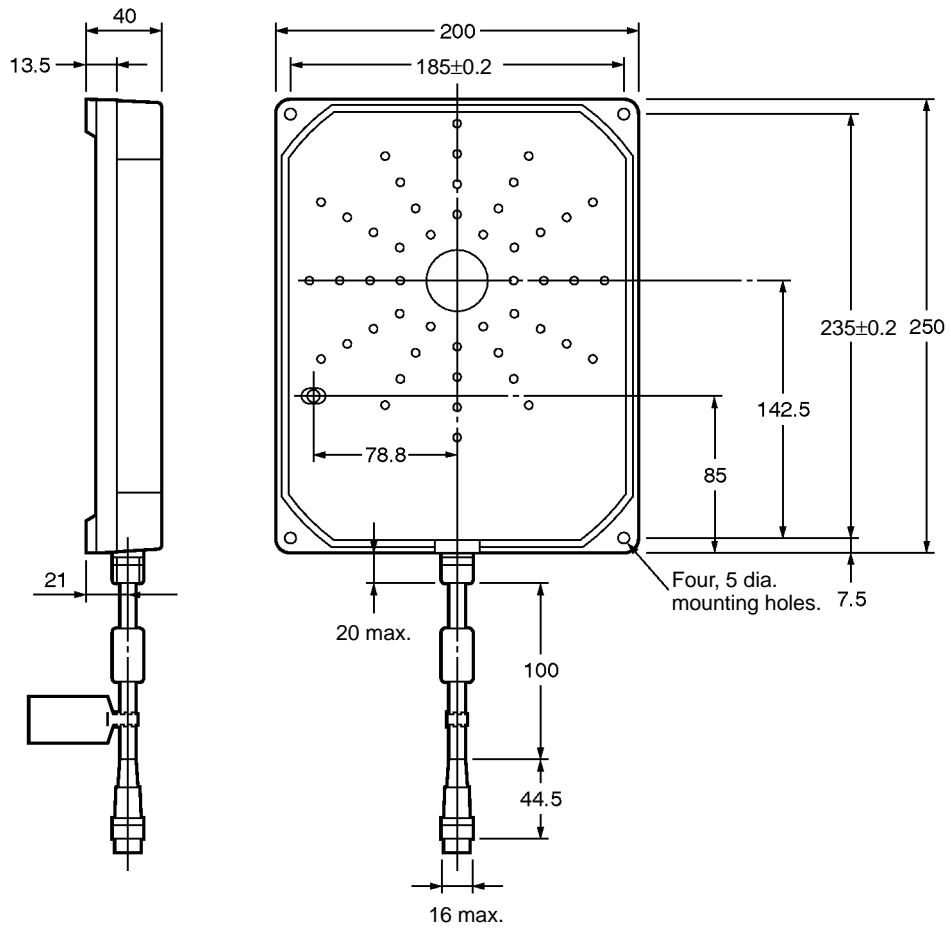

Casing material	PC/ASA resin
Rear panel material	Phenol resin
Cable	PVC

V700-H02

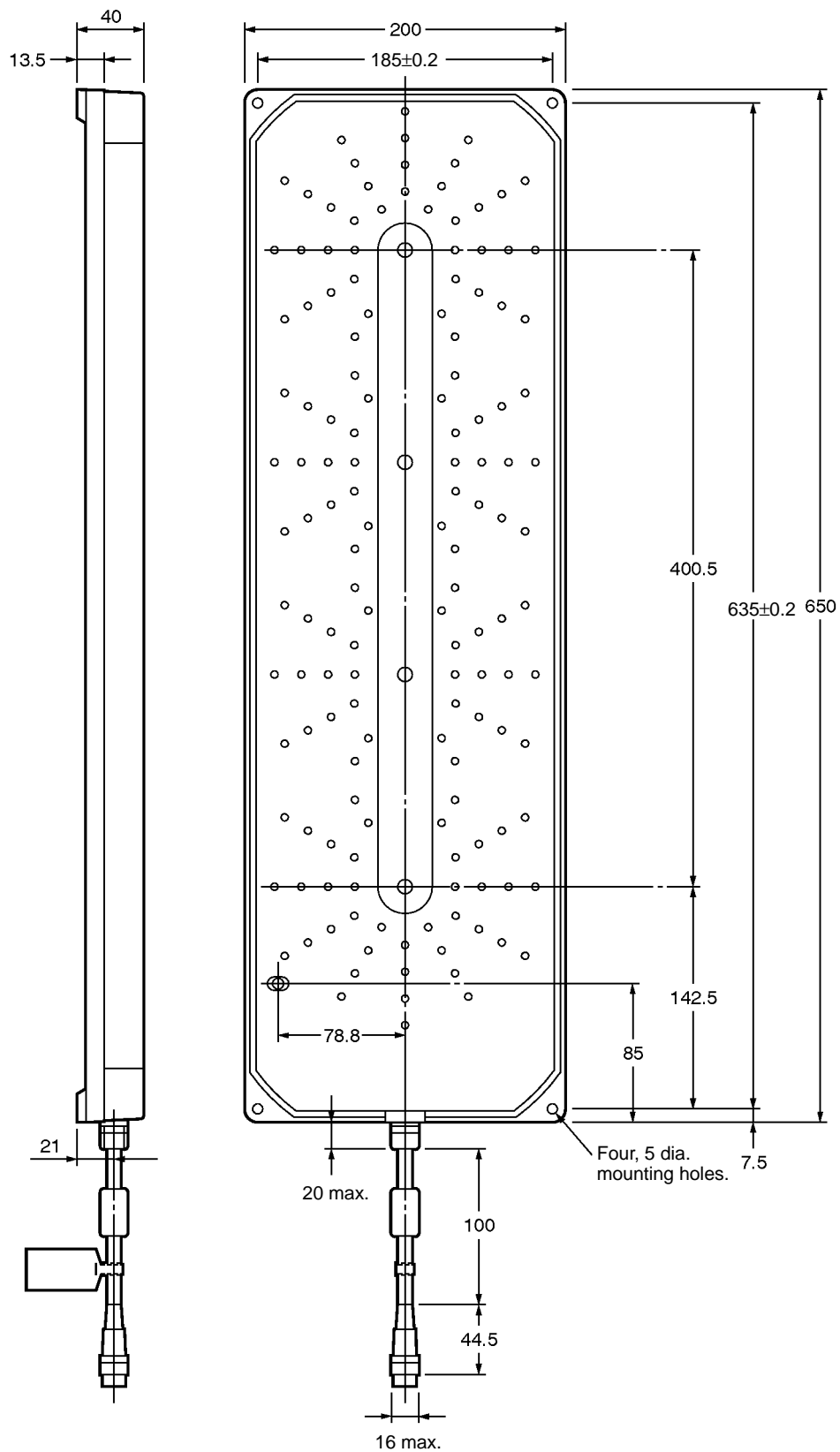

Casing material	PC/ASA resin
Rear panel material	Phenol resin
Cable	PVC

## 2-3 ID Tag

### 2-3-1 Specifications

Item	Model	
	V700-D23P31	V700-D23P41
Memory capacity	User area: 240 bytes	
Type of memory	EEPROM (non-volatile memory)	
Data backup time	10 years	
Data writing times	100,000 times per address	
Communications error detection	Bilateral use of CRC (Cyclic Redundancy Check) 16 bits	
Ambient operating temperature	Communicating: -20°C to 70°C (with no icing)	Communicating: -25°C to 70°C (with no icing)
	Not communicating: -40°C to 110°C (with no icing)	
Ambient storage temperature	-40°C to 110°C (with no icing)	-40°C to 110°C (with no icing)
Ambient operating humidity	No limits	35% to 95% (with no condensation)
Heat resistance	Thermal cycle: 20°C/180°C for 30 minutes each 200 times Constant high temperature: 180°C for 200 hours	The above ambient storage temperature range
Degree of protection	IP68 (IEC60529 standards)	IP67 (IEC60529 standards)
Vibration resistance	Destruction: 10 to 2,000 Hz, 1.5-mm double amplitude at 150 m/s <sup>2</sup> in X, Y, and Z directions ten times each for 15 minutes	
Shock resistance	Destruction: 500 m/s <sup>2</sup> in ±X, ±Y, and ±Z directions 3 times each, 18 times total	
Material	PPS resin	PBT resin with PET resin fill
Weight	Approx. 2 g	Approx. 1 g

**Note** The V700-D23P31 can be stored at a temperature of 180°C for 200 hours. The V700-D23P31 can be, however, in normal operation (i.e., the V700-D23P31 located in the communications area) at a maximum of 70°C. This means the temperature of the ID Tag itself in operation must not exceed 70°C. Before using the ID Tag, conduct some tests and check that the temperature of the ID Tag itself in operation is 70°C maximum. If the temperature of the ID Tag is 180°C, it normally takes a period of one minute for the temperature to drop to 70°C for an ambient temperature of 25°C. Take this into consideration when cooling down the ID Tag.



### 2-3-2 Dimensions

V700-D23P31

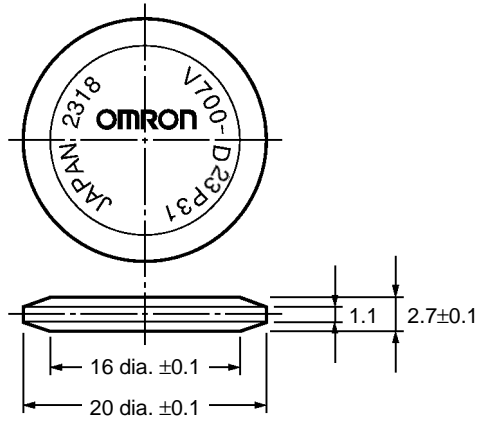

V700-D23P41

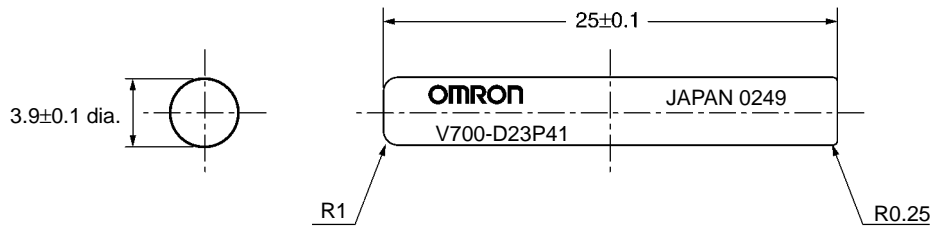

### 2-3-3 Memory Map

The V700-D23P31 has a memory area of 240 bytes, and the V700-D13P21 has a memory area of 112 bytes. One-byte data can be written to a single address. An eight-byte block of memory area is treated as one page.

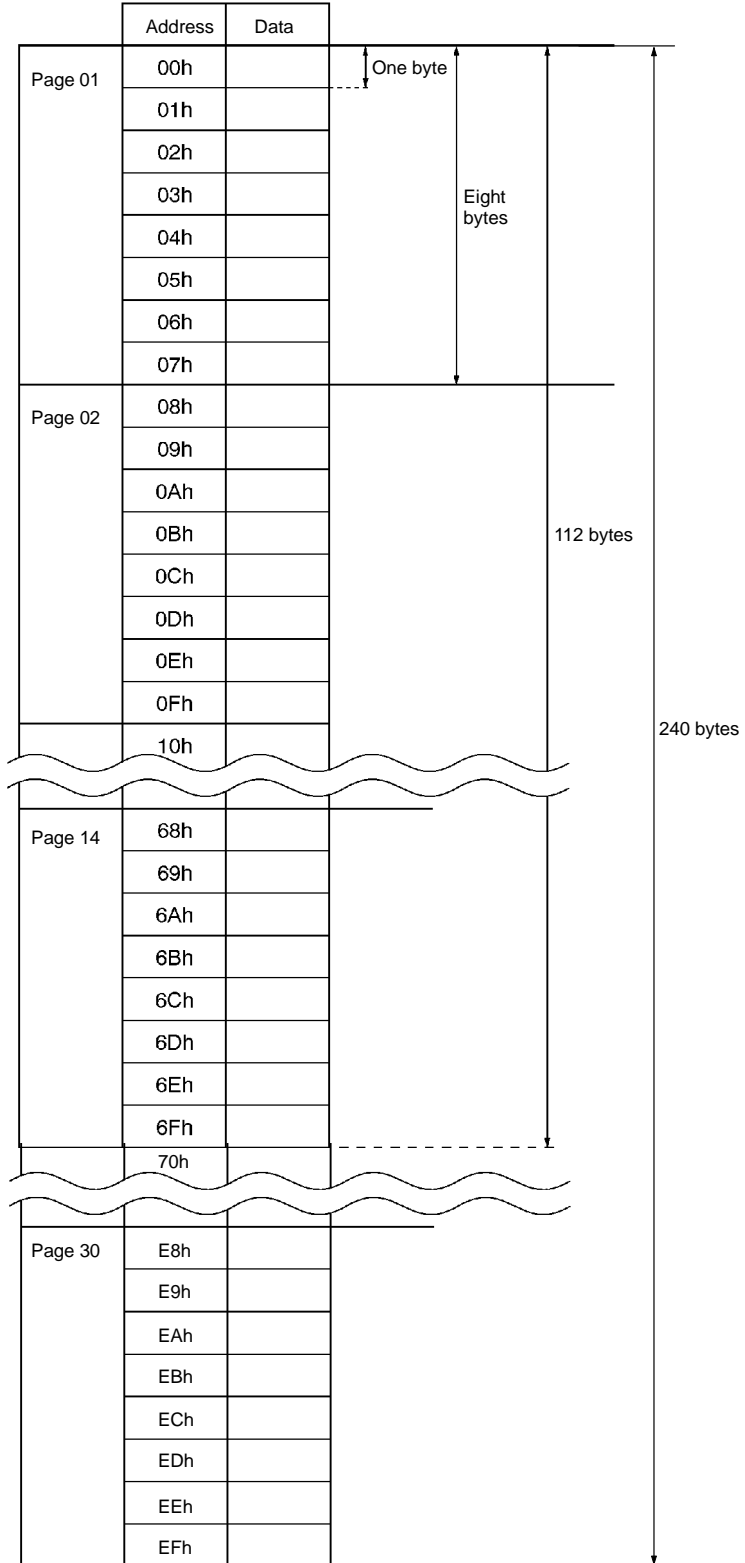

### 2-3-4 V700-A80 Attachment (For V700-D□□P31)

This is a special Attachment for fastening a coin-shaped ID Tag to a workpiece. It can be used with V700-D□□P31 models.

#### External Dimensions

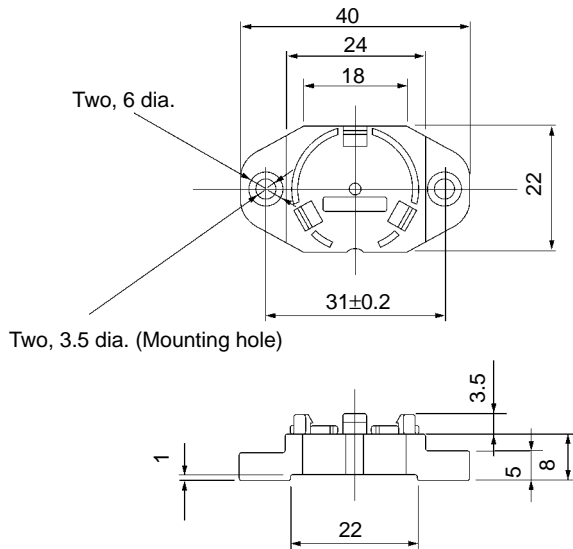

#### Mounting Hole Dimensions

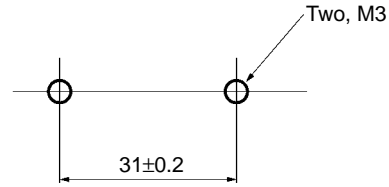

#### Mounting Procedure

- 1, 2, 3... 1. Insert the coin-shaped ID Tag into the Attachment. The coin-shaped ID Tag has no directionality, so it can be faced in any direction.
2. Use M3 screws to fasten the Attachment, and tighten the screws to a torque of 0.3 to 0.5 N•m.

#### General Specifications

Conforming to ID Tag specifications.

#### Influence of Background Metal

When this Attachment is used, the distance between the ID Tag and the workpiece is approximately 8 mm. If the workpiece is made of metal, refer to *8-8 Influence of Background Metal on ID Tag*.

**Note** Do not repeatedly insert and remove the ID Tag from the Attachment. Doing so can loosen the fit of the ID Tag and break the Attachment clasps. In case it should become necessary to remove an ID Tag once it has been inserted, do so by inserting a flat-blade screwdriver into the space between the Attachment and the ID Tag at the bottom of the Attachment. Do not use bare hands to remove the ID Tag, or the ID Tag may be damaged.

## 2-4 Cable

### 2-4-1 Specifications

Item	Model	
	V700-P10	V700-A4□
Number of conductors	8	10
Insulation resistance	50 MΩ min. (at 250 VDC) between conductor and shield	5 MΩ min. (at 500 VDC) between conductor and shield
Dielectric strength	250 VAC 1 min	500 VAC 1 min
Maximum operating temperature	70°C	80°C
Remarks	Connectors are not water resistant.	Connectors are not water resistant.

### 2-4-2 Dimensions

#### V700-P10

Model	V700-P10
Length	Approx. 2 m
Weight	Approx. 110 g

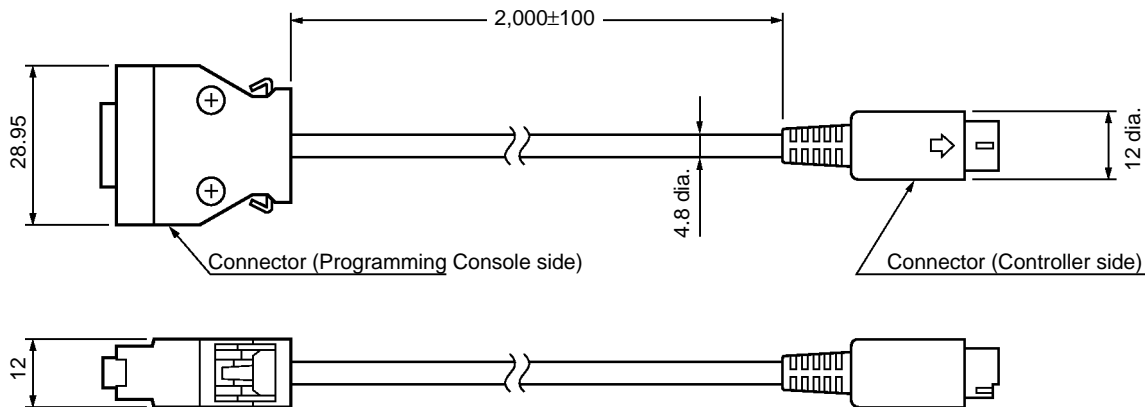

#### V700-A4□

Item	Model					
	V700-A40	V700-A41	V700-A42	V700-A43	V700-A44	V700-A45
Length	Approx. 2 m	Approx. 3 m	Approx. 5 m	Approx. 10 m	Approx. 20 m	Approx. 30 m
Weight	Approx. 150 g	Approx. 220 g	Approx. 360 g	Approx. 700 g	Approx. 1,350 g	Approx. 2,000 g
L1	2,000	3,000	5,000	10,000	20,000	30,000

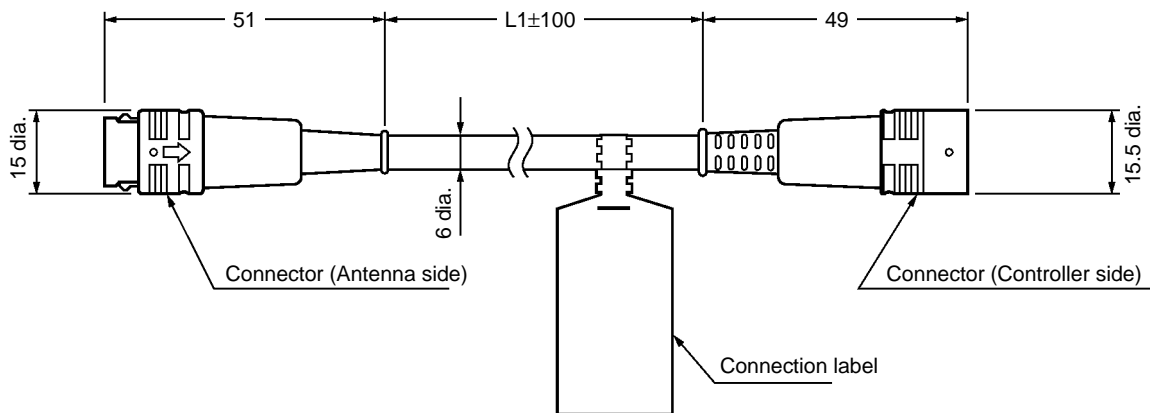

## 2-5 External Communications Specifications

Item	Specification
Communications method	Electromagnetic induction (with no battery)
Modulation method	ASK mode
Transmission frequency	125 kHz
Reception frequency	125 kHz

## 2-6 V700 Communications Specifications

The Controller can be connected to personal computers and PCs over RS-232C.

**V700-CD1D-V3**

Item	Specifications
Conforming standards	RS-232C
Communications method	EIA/TIA-232-E, 1-to-N half duplex
Baud rate	4,800 bps, 9,600 bps, 19,200 bps, 38,400 bps
Sync	Start-stop synchronization with 1 stop bit or 2 stop bits
Transmission code	ASCII7 or JIS8
Max. connectable number of Controllers	32
Error control (see note)	Vertical parity (even, odd, or none) Horizontal parity as BCC
Cable length	15 m max.
Suitable connector	D-sub 9-pin male connector OMRON XM2A-0901 Plug and XM2S-0911 Hood provided with the Controller
Recommended cable	Hitachi Cable CO-MA-VV-SB 5Px28AWG

**V700-CD2D-V3**

Item	Specifications
Conforming standards	RS-485
Communications method	EIA standards, RS-485, 1:N, 2-wire, bi-directional, half-duplex communications
Baud rate	4,800 bps, 9,600 bps, 19,200 bps, 38,400 bps
Sync	Start-stop synchronization with 1 stop bit or 2 stop bits
Transmission code	ASCII7 or JIS8
Max. connectable number of Controllers	31
Error control (see note)	Vertical parity (even, odd, or none) Horizontal parity as BCC
Cable length	300 m max.
Suitable connector	BLZ4CD2D (made by Nihon Weidmiiller Co., Ltd.); one set provided with Controller
Recommended cable	MVVS4CX0.5Sq (made by Tachii Electric Wire Co., Ltd.)

**Note** The DIP switches of the Controller are available to vertical parity settings. Refer to *Section 4 Setting, Mounting, and Connection Methods* for details.

**Precautions**

Be sure to set the baud rate to 9,600 bps or higher when commands are used in repeat mode. Otherwise, all moving ID Tags may not be processed. Refer to *Section 5 Communications Functions* for the commands used in repeat mode.

**Note** Use shielded twisted-pair cable equivalent to AWG20 if the recommended cable (MVVS4CX0.5Sq) for the V700-CD2D-V3 is not used.



## SECTION 3

### Functions

This section provides the modes and functions in detail.

3-1	Single, FIFO Read/Write, and Multiple, Simultaneous Access Functions .....	24
3-2	Write Protect Function .....	25
3-3	Memory Check Function .....	25
3-4	Mutual Interference Preventive Function (Synchronous Function) .....	26
3-5	Energy-saving Mode .....	28
3-6	Long-distance Mode and Stable Communications Mode (Communications Distance Setting) .....	28
3-7	Noise Environment Measurement Function .....	29
3-8	Error Logging Function .....	29

### 3-1 Single, FIFO Read/Write, and Multiple, Simultaneous Access Functions

Three communication modes are available depending on the number or state of Tags in the communication area. Commands can be used for selecting one of them. Refer to *Section 5 Communications Functions* for details.

#### Single Mode

In this mode, only a single ID Tag can be in the communications area, otherwise a communications error will result.

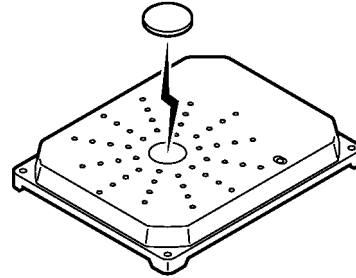

#### FIFO Read/Write Mode

In the FIFO (first-in, first-out) read/write mode, the RFID System reads and writes data to and from each ID Tag coming into the communications area one after another. Since every ID Tag finished with communications is set to access prohibit, communications will be possible if only one ID Tag newly arrives in the communication area of the Antenna where more than one ID Tag exists. An error, however, results if two or more ID Tags arrive in the communications area simultaneously. When the access-prohibited Tag moves out of the communications area, communications will become possible again.

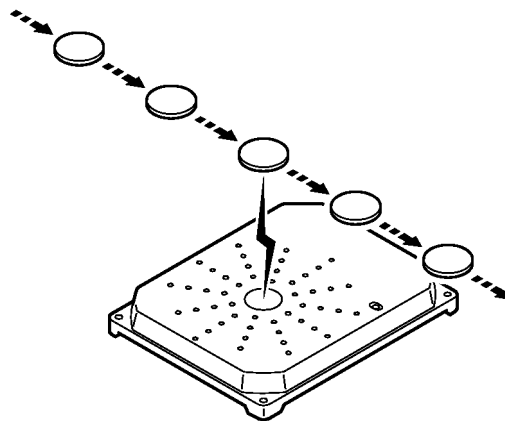

#### Multiple, Simultaneous Access Mode

In this mode, communications with all ID Tags in the communications area can be made on receipt of the command.

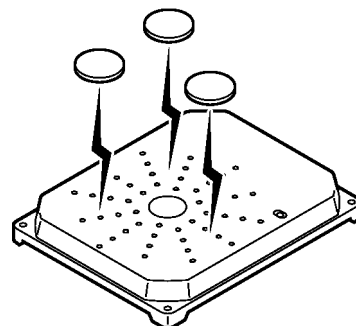



**Note** In FIFO read/write mode, make sure that multiple ID Tags do not arrive in the communications area together, otherwise a communications error will result and further communications will not be possible until there is only a single ID Tag in the communications area.

## 3-2 Write Protect Function

The write protect function is a protective function that is provided to prevent permanent data, such as product information and pallet numbers saved to data carriers from being lost through being accidentally overwritten.

Any areas can be write-protected in page units by setting the protection information in the ID Tag. If a WRITE command is executed for a page that has been set for write protection, a protect error is generated. The data protection area is comprised of one bit per page, for a total of 30 bits. To execute write protection, use the WRITE PROTECT (WP) command to set the bit for the relevant page. In the same way, release the write protection by clearing the bit.

### Protection Information

Protection information																									
b7	b6	b1		b0	b7	b6	b1		b0	b7	b6	b1		b0	b7	b6	b3		b2	b1	b0				
Page 30	Page 29			Page 24	Page 23	Page 22	Page 21			Page 16	Page 15	Page 14	Page 13			Page 8	Page 7	Page 6	Page 5			Page 2	Page 1	Fixed at 0	Fixed at 0

## 3-3 Memory Check Function

By adding check codes to data in ID Tags, it is possible to detect errors in the data contents resulting from accidental causes or deterioration as the EEPROM reaches the end of its service life. For the check code, a CRC code calculated by the generating polynomial  $X^{16} + X^{12} + X^5 + 1$  is used.

A memory check is executed by using the MEMORY CHECK (MC) command to write the check code, and the MEMORY CALCULATE (MK) command to verify the check code. The calculation area is the portion of the check block specified by the first address and the number of bytes excluding the last two bytes. The check code area is the last two-byte portion.

When a command to write a check code is sent, the CRC code of the data in the calculation area is calculated and written to the check code area. When a command to verify the data is sent, the CRC code of the data in the calculation area is calculated and compared with the data in the check code area. If they coincide,

response code 75, which indicates normal data transmission, is returned. If they do not coincide, response code 76 is returned as a warning.

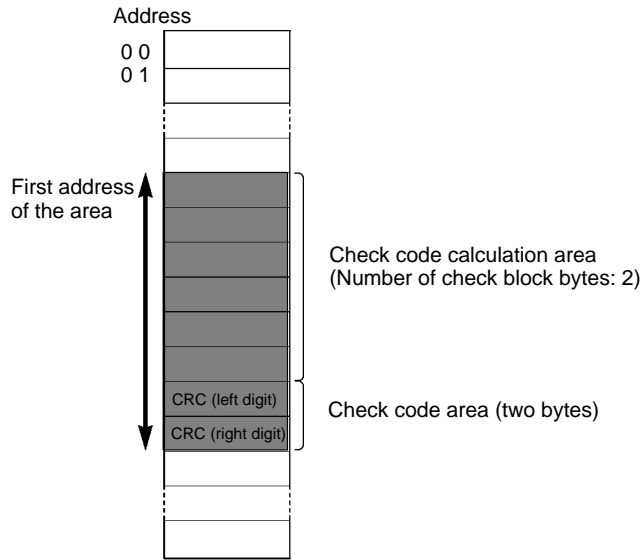

**Method of Operation**

After data is written, use the MEMORY CHECK (MC) command to calculate and write the check code. Then, before reading the data, use the MEMORY CALCULATE (MK) command to verify the check code. This enables damage to inaccessible data in the ID Tag to be detected in advance.

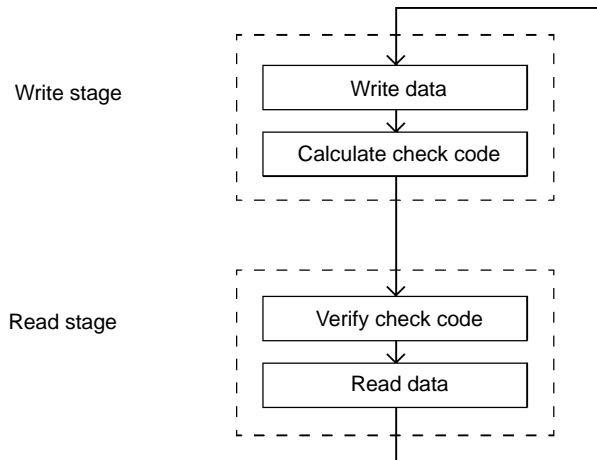

**3-4 Mutual Interference Preventive Function (Synchronous Function)**

This function can reduce the mutual interference distance of each Antenna. If two or more Antennas are close to one another, they will not operate properly due to mutual interference. It is possible to reduce the mutual interference distance of each Antenna by connecting the Controllers together over synchronous cables through the SYNC terminal as shown below. In this example, one of the Controller connected in series is set as the Master and the others are set as Slaves. Be sure to set the terminating resistance of the Controller at each end to ON and that of other Controllers to OFF. A maximum of 32 Controllers including the Master and 31 Slaves can be connected within a total cable distance of 300 m maximum. Refer to page 35, *DIP Switch Settings*, page 44, *SYNC signal*

Wiring, and 8-6 Mutual Interference of Antenna for the settings, cable connections, and mutual interference distance in detail.

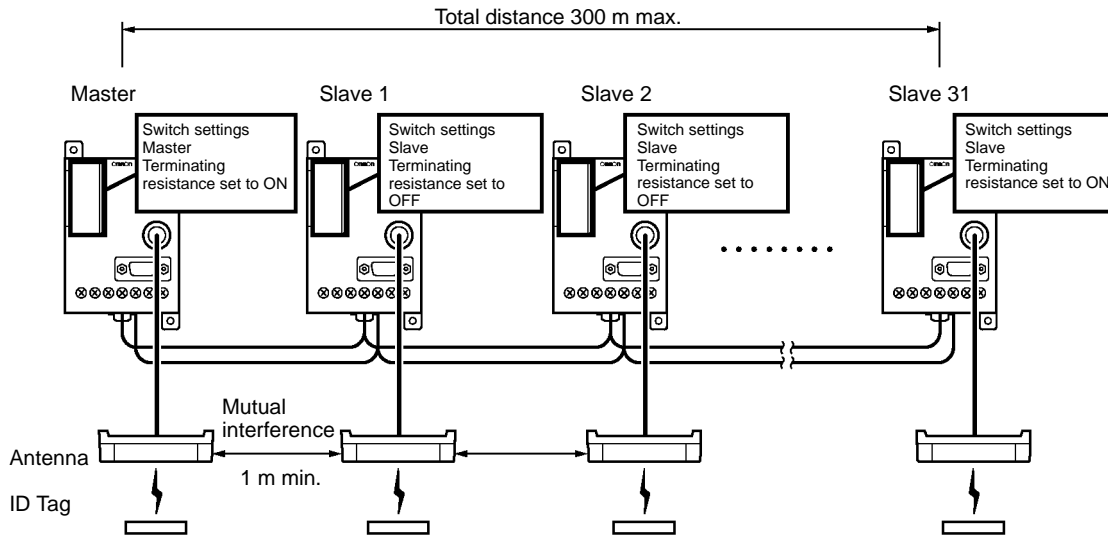

- Note**
1. Be sure to set only one of the Controllers as the Master and other Controllers as Slaves in synchronous operation, otherwise the RFID System will not operate.
  2. Be sure to set the terminating resistance of the Controller at each end to ON and that of any other Controller to OFF, otherwise stable operation of the RFID System will not be possible.

There are two types of synchronous functions to reduce the mutual interference distance of each Antenna. These functions are called R/W (read/write) synchronous and RO (read-only) synchronous functions. Both READ and WRITE commands are available to the R/W synchronous function. Only the READ command is available to the RO synchronous function. The RO synchronous function requires a shorter communications time than the R/W synchronous function. Refer to 8-4 Communications Time and page 35, DIP Switch Settings for details.

Item	Synchronous function		
	RW	RO	No synchronous function
Synchronous cable	To be connected		Not required
Mutual interference distance between Antennas	Short		Long
WRITE command	Possible to use	Not possible to use	Possible to use
Communications time	Long	Slightly long	Short

**Precautions**

Make sure that all Controllers connected are in the same synchronous type (i.e., in R/W synchronous operation, OR synchronous operation, or not in synchronous operation), otherwise the communications of all Controllers may be affected.

## 3-5 Energy-saving Mode

The RFID System can be set to energy-saving mode.

In case commands can be issued only during communications, the Antenna power can be shut down to reduce the total power consumption of the RFID System. In energy-saving mode, the power consumption of the RFID System is approximately 30% of that in normal operation.

If the Controller is set to energy-saving mode, the Antenna will have output only at the time of communications. This mode is available while a communications command is issued to select the single trigger, single auto, or multi-trigger option.

Item	Mode	
	Normal mode	Energy-saving mode
Power consumption	High	Low
Antenna output during communications	ON	
Antenna output during standby periods	ON	OFF
Command A	Available	
Command B	Available	Not available
Other command	Available	

**Note** 1. **Command A**

Single trigger, single auto, and multi-trigger

**Command B**

Single repeat, FIFO trigger, FIFO auto, FIFO repeat, multi-trigger, and multi-repeat

2. Refer to page 35 *DIP Switch Settings* and 5-10 *Communications Command* for details.

**Note** Do not set the Controller to energy-saving mode if the single repeat, FIFO trigger, FIFO auto, FIFO repeat, multi-trigger, or multi-repeat option is selected, otherwise a command error will result.

## 3-6 Long-distance Mode and Stable Communications Mode (Communications Distance Setting)

### Long-distance Mode

In order to perform long-distance communications, the RFID System automatically selects the amplification factor when the Antenna receives signals from the ID Tag. If the ID Tag is far, the amplification factor increases automatically in order to receive the weak signal of the ID Tag.

### Stable Communications Mode

If there is excessive noise (particularly, air-conditioner noise), the automatic selection of the amplification factor should be suppressed. If this automatic selection is suppressed, the RFID System cannot communicate with far ID Tags but the RFID can perform stable communications even under an environment where noise is prevalent.

The RFID System allows a selection of either long-distance mode (automatic selection of amplification factor) or stable-communications mode (no change in amplification factor). Refer to page 35, *DIP Switch Settings* for details.

Item	Mode	
	Long-distance mode	Stable communications mode
Antenna's signal reception amplification factor	Low or high (automatically selectable)	Always low
Communications distance	Very long distance	Long distance
Environmental noise interference	Affected easily	Not affected easily

**Note** Environmental noise can be easily checked with the Programming Console. Refer to *3-7 Noise Environment Measurement Function*. If the noise environment measurement function is executed after the Controller is in long-distance mode, the existing value must not exceed 30. Otherwise, it is recommended that the Controller be used in stable communications mode.

## 3-7 Noise Environment Measurement Function

Noise environment around the location where the Antenna is installed can be checked using the Programming Console.

Use this function to arrange the best location and best direction of the Antenna or to determine whether to set the Controller to long-distance mode or stable communications mode. It is recommended that this function be used to check the noise environment before installing the RFID System.

To use this function, connect the C200H-PRO27-E Programming Console (sold separately) through the V700-P10 Programming Console Conversion Cable (sold separately) to the Controller. Refer to *6-6-8 Noise Environment Check* for details.

## 3-8 Error Logging Function

The error log data of the RFID System can be read on-line through the Programming Console.

Two types of error log data can be read, which makes it possible to analyze system errors.

### 1. Latest Error Log

The Controller keeps a record of errors resulted in RUN mode after the Controller is turned ON. The Programming Console can read information on these errors, thus making it possible to find causes of errors. The Controller keeps a record of a maximum of 30 errors. New errors replace the existing record in chronological order beginning with the oldest error record. The records will be completely lost when the Controller is turned OFF or reset or when it receives a RESET command.

### 2. Statistic Error Log

The Controller classifies and keeps the number of each type of error. The Controller also calculates MCBF (mean cycle between failures) simultaneously. The Controller keeps all these data items until the user turns OFF or resets the Controller.

To use this function, connect the C200H-PRO27-E Programming Console (sold separately) to the Controller through the V700-P10 Programming Console Conversion Cable (sold separately). Refer to *6-6-9 Latest Error Data* and *6-6-10 Statistic Error Data* for details.

**Note** The record of all errors will be lost when the Controller is turned OFF or reset or when it receives a RESET command. Do not turn OFF or reset the Controller in order to keep the records.



# SECTION 4

## Setting, Mounting, and Connection Methods

This section provides installation information for the V700 System.

4-1	Controller .....	32
4-1-1	Switch Settings .....	32
4-1-2	Installation Environment .....	37
4-1-3	Mounting .....	38
4-1-4	Connection and Disconnection of Antenna Connector .....	39
4-1-5	Wiring .....	41
4-1-6	Connection of RS-232C Interface (V700-CD1D-V3) .....	45
4-1-7	RS-485 Interface Connection (V700-CD2D-V3) .....	49
4-2	Installation of Antenna .....	52
4-2-1	Installation Environment .....	52
4-2-2	Mounting the Antenna .....	53
4-3	ID Tag .....	54
4-3-1	Installation Environment .....	54
4-3-2	Mounting Method .....	54

## 4-1 Controller

### 4-1-1 Switch Settings

Open the cover of the Controller to make switch settings.

#### Opening the Cover

A screwdriver is provided with the Controller. Open the cover by inserting the screwdriver into the groove on the left side of the cover.

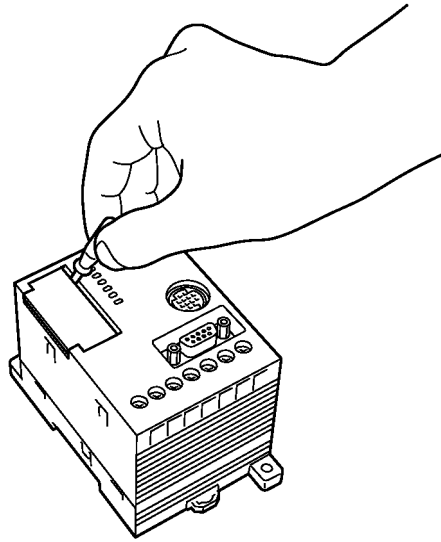

Under the cover, there are two node number switches (SW1 and SW2), two DIP switches (SW3 and SW4), and a port to connect the Programming Console.

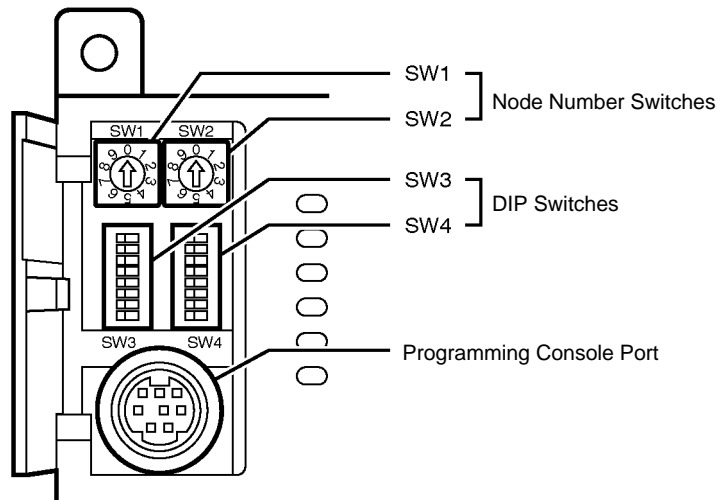



**Settings**

Use the provided screwdriver to make switch settings as shown below.

**Node Number Settings**

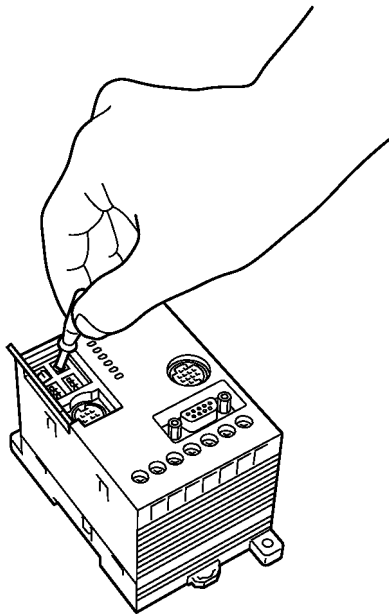

**DIP Switch Settings**

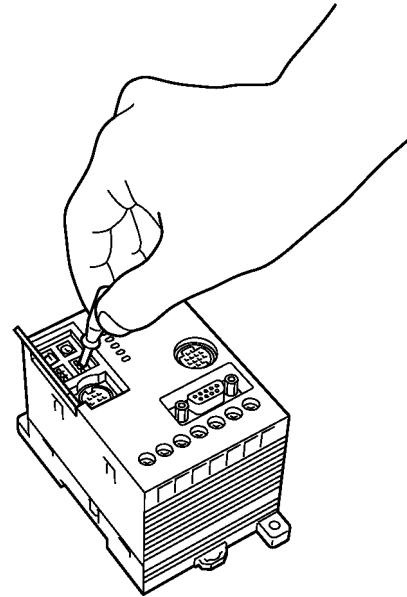

**Default Set Values**

The following table shows default set values.

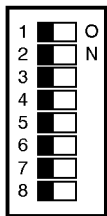
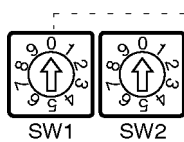

SW3 (left)

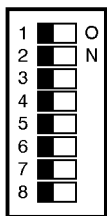

SW4 (right)

	Name	Default set value	Meaning
SW1	Node number (10's digit)	0	Node number 00
SW2	Node number (1's digit)	0	
SW3-1	System reserved pin	OFF	Not used
SW3-2	Communications sync setting	OFF	No sync
SW3-3		OFF	
SW3-4		OFF	
SW3-5	Low power consumption setting	OFF	Normal mode
SW3-6	Communications distance setting	OFF	Long-distance mode
SW3-7	Not used	OFF	Not used
SW3-8	Terminating resistance setting	OFF	No
SW4-1	Baud rate setting	OFF	9,600 bps
SW4-2		OFF	
SW4-3	Data length setting	OFF	7 (ASCII7)
SW4-4	Parity bit setting	OFF	Even
SW4-5		OFF	
SW4-6	Stop bit length setting	OFF	2
SW4-7	Communications mode setting	OFF	No ACK/NACK control
SW4-8	Time-out setting	OFF	See note. (500 ms)

**Note** The pin 8 setting of SW4 will be meaningless if pin 7 is set to OFF.

**Node Number Settings**

**Node Number**

If more than one Controller is connected to a single host through Link Adapters, each Controller needs an ID number so that the host can discriminate each of them. Such an ID number is called node number. Each Controller must have a unique node number.

Each command or response of the Controller includes the node number of the Controller. Communications will not be possible if the node number is wrong. The node number must be correctly set regardless of whether the host is connected to a single or multiple Controllers.

As shown below, SW1 on the left is for 10's digit and SW2 on the right is for 1's digit, which can set numbers within a range between 00 and 31.

SW1	SW2	Node number
10's digit	1's digit	
0	0	0
0	1	1
0	2	2
0	3	3
0	4	4
0	5	5
0	6	6
0	7	7
0	8	8
0	9	9
1	0	10
1	1	11
:	:	:
2	9	29
3	0	30
3	1	31
3	2	Prohibited (See note.)
3	3	Prohibited (See note.)
:	:	:
9	9	Prohibited (See note.)

Setting Examples

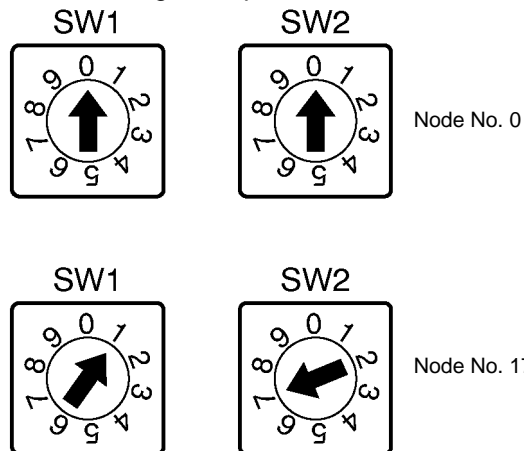

The node number switches are factory-set to 00.

**Note** Do not set the node number within a range between 32 and 99, in which case the node number will automatically be set to 31.

**DIP Switch Settings**

**SW3**

**Pin 1: Communications Format Setting (V700-CD1D-V3/CD2D-V3 Only)**

This pin can be used to enable or disable BCC for the command and response format between the host and the Controller. When BCC is enabled, checking for communication errors between the host and Controller, resulting from factors such as noise, is executed using horizontal parity. Control of communications with the host can be simplified by disabling BCC, but communications error checking will not be executed in communications frame units. It is therefore recommended that the parity bit be set to either even or odd.

Pin 1	Description
ON	BCC disabled
OFF	BCC enabled

**Note** Always set this pin to OFF for the V700-CD1D-V2 or V700-CD2D-V2. They cannot operate normally with this pin set to ON.

**Pins 2, 3, and 4: Communications Sync Setting**

If two or more Antennas are used closely together, the Controllers must operate in synchronous operation in order to prevent mutual interference. Therefore, communications sync settings are required in each Controller. Refer to 3-4 *Mutual Interference Preventive Function (Synchronous Function)* for details.

Pin 2	Pin 3	Pin 4	Description
ON	ON	ON	Slave RO
		OFF	Slave RW
	OFF	ON	Master RO
		OFF	Master RW
OFF	ON	ON	No sync
		OFF	No sync
	OFF	ON	No sync
		OFF	No sync

- Note**
1. Make sure to set only one of the Controllers as the Master and the other Controllers as Slaves in synchronous operation, otherwise the RFID System will not operate.
  2. Make sure that all Controllers in synchronous operation are the same in mode (i.e., RW sync, RO sync, or no sync), otherwise the Controllers will be affected and will not communicate properly.

**Pin 5: Low Power Consumption Setting**

In case commands can be issued at the time of communications only, the Antenna power can be shut down to reduce the total power consumption of the RFID System. In energy-saving mode, the power consumption of the RFID System is approximately 30% of that in normal operation.

If the Controller is set to energy-saving mode, the Antenna will have output only at the time of communications. This mode is available after the communications command is issued to select the single trigger, single auto, or multi-trigger option.

Pin 5	Description
ON	Energy-saving
OFF	Normal mode

**Note** Do not set the Controller to energy-saving mode if the single repeat, FIFO trigger, FIFO auto, FIFO repeat, multi-trigger, or multi-repeat option is selected, otherwise a command error will result.

**Pin 6: Communications Distance**

In order to perform long-distance communications, the RFID System automati-

cally selects the amplification factor when the Antenna receives signals from the ID Tag.

It may, however, be better not to select the automatic amplification factor if multiple commands are used or if there is excessive noise. If this automatic selection is suppressed, the RFID System cannot communicate with far ID Tags but the RFID can perform stable communications.

The RFID System allows a selection of either the long-distance mode (automatic selection of amplification factor) or stable-communications mode (no change in amplification factor).

Pin 6	Description
ON	Stable communications mode
OFF	Long-distance mode

**Note** Environmental noise can be easily checked with the Programming Console by executing the NOISE CHECK command when the Controller is in long-distance mode. Then if the value of noise reads more than 30, it is recommended that the Controller be used in stable communications mode.

**Pin 7 (V700-CD1D-V3): Not used**

Do not use this pin. Always set this pin to OFF.

**Pin 7 (V700-CD2D-V3): RS-485 Terminating Resistance**

When multiple Controllers are connected to a single host, the Controller or host at each end must be connected with terminating resistance to ensure stable operation.

This pin can be used to set the built-in RS-485 terminating resistance to ON or OFF.

Pin 7	Description
ON	RS-485 terminating resistance is ON.
OFF	RS-485 terminating resistance is OFF.

**Note** Of the Controllers and host connected in series, the terminating resistance must be set to ON for the device connected at each end. Set the terminating resistance for all others to OFF. If these settings are made incorrectly, operation will be unstable.

**Pin 8: Synchronous Terminating Resistance**

If two or more Controllers with Antennas are located closely together, the Controllers must be in synchronous operation in order to prevent Antenna mutual interference. In that case, the Controllers must be connected to one another in series through a synchronous cable. The terminating resistance of the Controller at each end must be set to ON for stable communications.

Use this pin to set the terminating resistance to ON or OFF.

Pin 8	Description
ON	Terminating resistance is ON.
OFF	Terminating resistance is OFF.

**Note** The terminating resistance must be set to ON for the Controller connected at each end of the series connection. Set the terminating resistance for all others to OFF. If these settings are made incorrectly, operation will be unstable.

SW4

**Pins 1 and 2: Baud Rate Setting**

Pin 1	Pin 2	Description
ON	ON	38,400 bps
	OFF	19,200 bps
OFF	ON	4,800 bps
	OFF	9,600 bps

**Pin 3: Data Length Setting**

Pin 3	Description
ON	8 bits (JIS 8 bits)
OFF	7 bits (ASCII 7 bits)

**Pins 4 and 5: Parity Bit Setting**

Pin 4	Pin 5	Description
ON	ON	(Even parity)
	OFF	Odd parity
OFF	ON	No parity
	OFF	Even parity

**Pin 6: Stop Bit Length Setting**

Pin 6	Description
ON	1 bit
OFF	2 bits

**Pin 7: Communications Mode Setting**

This setting determines whether or not ACK/NACK control is performed between the host and controller.

Pin 7	Description
ON	ACK/NACK control
OFF	No ACK/NACK control

**Pin 8: Time-out Setting**

This setting determines the time-out period of ACK/NACK control.

This setting will be meaningless unless pin 7 is set to ON.

Pin 8	Description
ON	5 s
OFF	500 ms

**4-1-2 Installation Environment**

The V700-CD1D Controller is a highly reliable control device withstanding tough environments. In order to ensure the full, reliable performance of the RFID system, however, observe the following.

**Installation**

Do not install the Controller under the following conditions.

- The ambient temperature is not within a range between  $-10^{\circ}\text{C}$  and  $55^{\circ}\text{C}$  or there are radical temperature changes resulting in condensation.
- The humidity is not within a range between 35% and 85%.
- There is corrosive gas, flammable gas, dust, salt, or metal powder.
- The Controller is affected by direct vibration or shock.
- The Controller is exposed to direct sunlight.
- Water, oil, or chemical is sprayed onto the Controller.

**Enclosed-mounting Position**

The Controller can be used at an ambient temperature range between  $-10^{\circ}\text{C}$  and  $55^{\circ}\text{C}$ .

- Make sure that the Controller is provided with sufficient ventilation space.
- Do not install the Controller close to heaters, transformers, or resistors that radiate excessive heat.
- If the ambient temperature exceeds  $55^{\circ}\text{C}$ , be sure to install a forced-ventilation fan or cooler to keep the temperature below  $55^{\circ}\text{C}$ .
- If power lines or high-tension lines with large currents are located close to the Controller, be sure to test the Controller carefully and make sure that wires

connected to the Controller are not affected by the noise of power lines or high-tension lines.

**Note** Be sure to abide by the above before installing the Controller and carefully test the Controller.

### 4-1-3 Mounting

The Controller can be mounted to DIN tracks or enclosed-mounted to panels with screws.

#### Enclosed Mounting

Be sure to secure the Controller with M4 screws together with spring washers and flat washers.

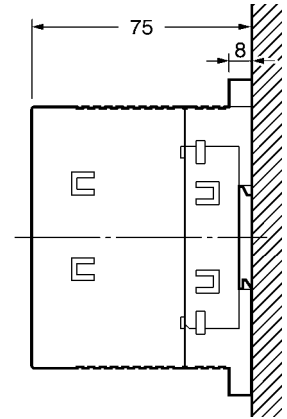
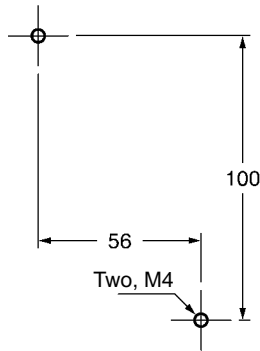

DIN Track Mounting

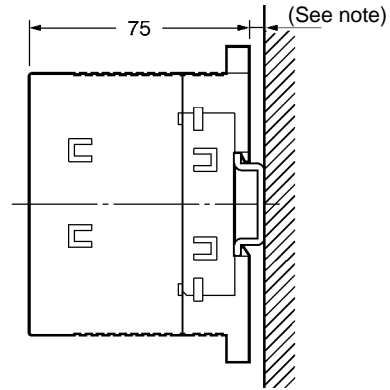
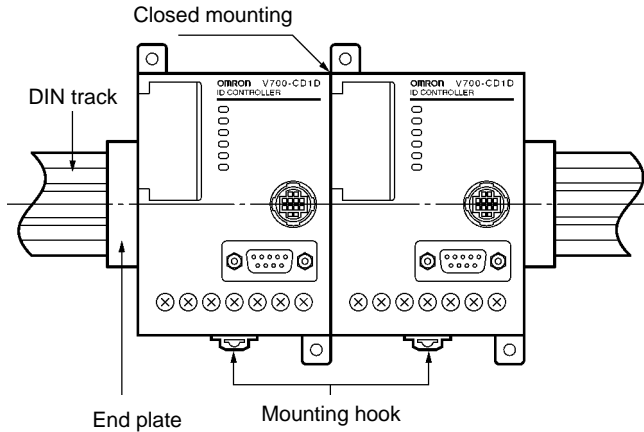

**Note** Take the height of the DIN track into consideration at the time of mounting.

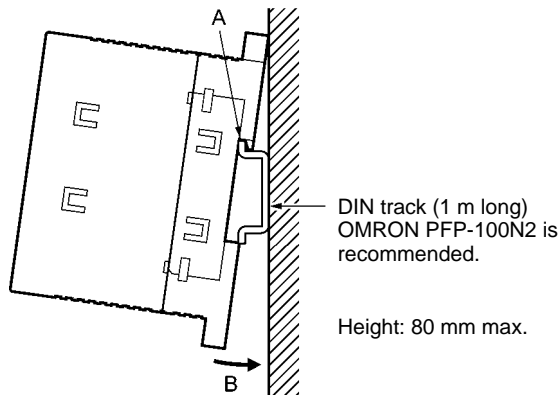

- (1) Hook the Controller to part A. Then press the Controller in direction B to mount the Controller.
- (2) Pull the mounting hook downwards. Then lift the Controller upwards to disconnect the Controller.

PFP-100N2 DIN Track

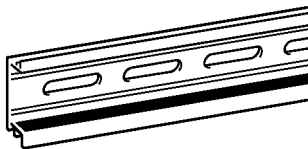

PFP-M End Plate

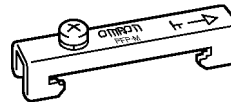

4-1-4 Connection and Disconnection of Antenna Connector

A single antenna can be connected to the Controller through the V700-A4□ Antenna Cable (sold separately), the standard length of which is 30 m maximum. Two Antenna Cables can be connected up to a total length of 50 m. The Antenna is provided with a 0.1-m-long cable. Therefore the length between the Antenna and Controller is 50.1 m in this case.

## Connection of Antenna Connector

### Connection

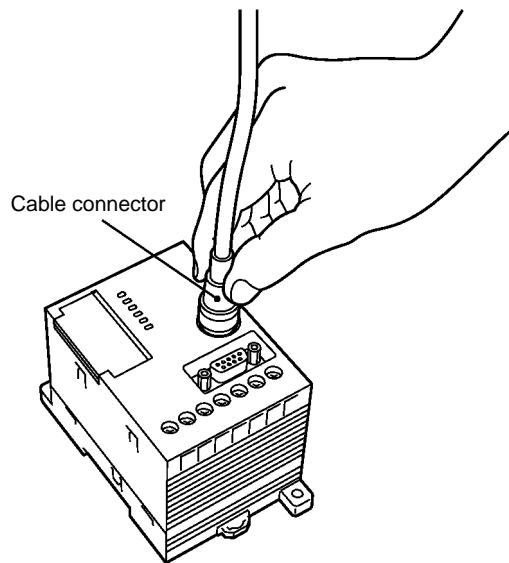

- 1, 2, 3...**
1. Hold and insert the connector into the port so that the point marked in black on the panel of the Controller coincides with the point marked in white on the connector.
  2. Press the connector straight until the connector is locked.

**Note** Do not hold and press the ring of the connector, otherwise the connector is not locked. Be sure to hold the connector.

### Disconnection

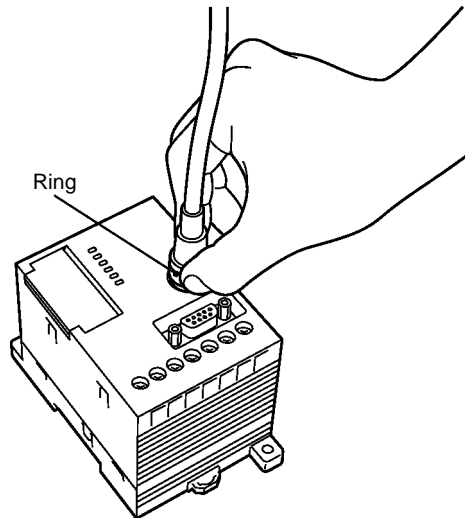

Hold and pull the ring straight upwards.

**Note** Do not hold and pull the connector, otherwise the connector cannot be removed. Be sure to hold the ring.



**CAUTION**

Do not pull the cable, otherwise the cable may break or be damaged.

**Note** Do not connect or disconnect the connector while the Controller is turned ON, otherwise the Controller may malfunction. Do not use more than two cables to connect the Controller to the attached cable of the Antenna.



### 4-1-5 Wiring

Wire the Controller as shown below.

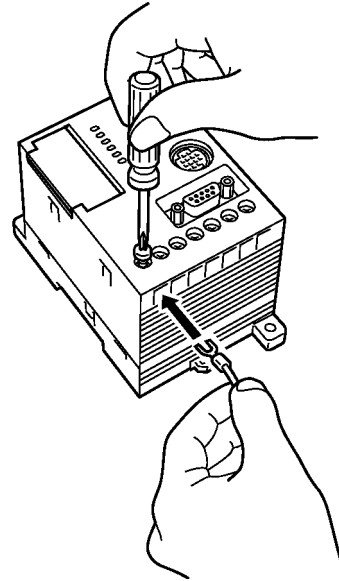

### Power Supply and Ground Wires

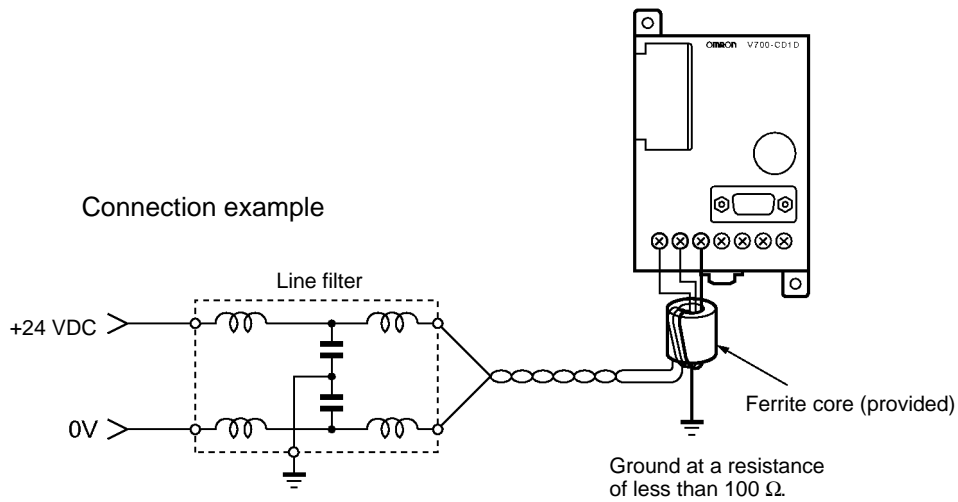

The power supply and ground terminals use M3 set screws. The following type of solderless terminals can be connected to these terminals. Tighten each screw to a torque of approximately 6 kgf • cm.

### Examples of Suitable Solderless Terminals

Manufacturer	Model	Suitable wire	Shape
Nippon Atchaku Tanshi	1.25-N3A	AWG24 to AWG16	Fork-shaped
Nippon Atchaku Tanshi	1.25-Y3A		

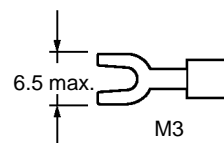

The Controller can internally withstand the noise on the power line. By providing power to the Controller through the noise filter, the noise between the Controller and ground can be greatly reduced.

**Recommended Compact DC Power Supply (OMRON)**

Model	Output	Input voltage
S82K-03024	24 VDC 1.3 A	110/240 V
S82J-0224	24 VDC 1.1 A	110 V
S82H-10024	24 VDC 4.6 A	110/240 V

The maximum power consumption of the Controller is 20 W (i.e., 0.8 A at 24 VDC). An inrush current, however, will flow when the Controller is turned ON. Take this into consideration when preparing the power supply. A power supply with an output of 1.1 A min. at 24 VDC is recommended.

- Note**
1. If the Antenna and power supply are too close, some noise generated from the power supply may interfere the communications of the Antenna. Make sure that there is a distance of 1 m or more between the Antenna and power supply.
  2. If the Controller and Antenna are too close, the Controller may interfere with the communications between the Antenna and ID Tag. Make sure that there is a distance of 80 cm or more between the Controller and Antenna.
  3. Provide 24 VDC to the Controller. The permissible variation of the power supply is between 20.4 and 26.4 VDC (i.e., 24 VDC <sup>-15%</sup>/<sub>+10%</sub>). Make sure that the supply voltage is within this range.
  4. The maximum power consumption of the Controller is 20 W. An inrush current of approximately 30 A at 24 VDC, however, flows when the Controller is turned ON. Take this into consideration when preparing the power supply.
  5. Provide a power wire with a thickness of at least AWG18 in order to prevent the dropping of voltage. It is recommended that twisted-pair wire be used for the power line.
  6. Ground the Controller at a resistance of less than 100 Ω to protect the Controller from noise interference. The thickness of the ground wire must be at least AWG18. If two or more Controllers are connected to one another in synchronous operation, be sure to ground the Controller located at either end of the system at a resistance of less than 100 Ω and connect the ground terminals of other Controllers with the shielded wire of the synchronous cable.

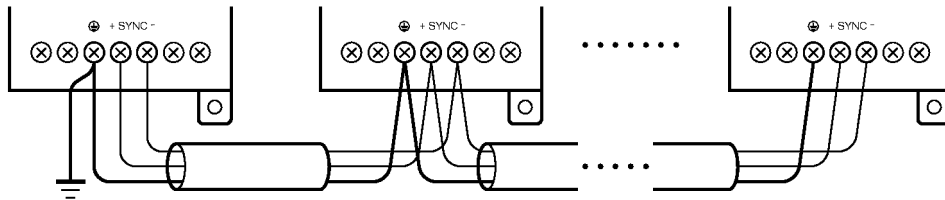

- Use the provided ferrite core for the suppression of noise generation as shown below.

- 1, 2, 3...**
1. Wire the power supply and ground wires.
  2. Wind the power supply and ground wires together around the ferrite core once so that the ferrite core will not move as shown below. The ferrite core must be located within 10 cm of the Controller.

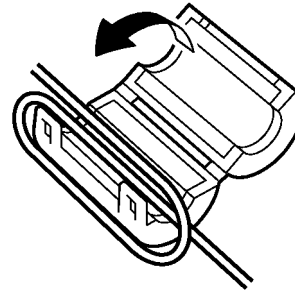

3. Close and press the ferrite core until the ferrite core clicks so that the ferrite core will be locked.

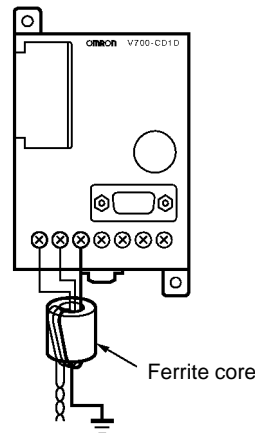

4. If the synchronous cable is used, wind only the power supply wires around the ferrite core as shown below.

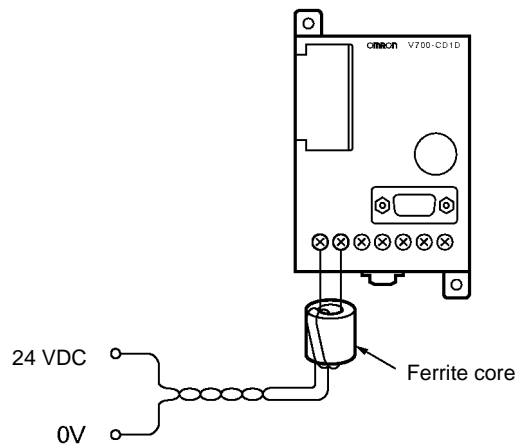

### Wiring RESET Signal

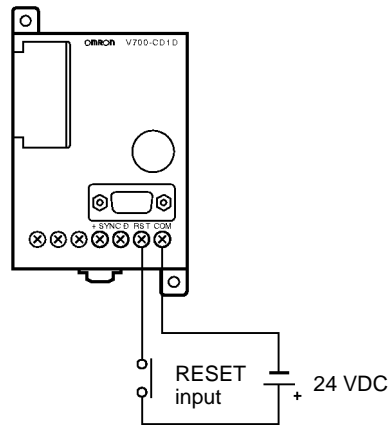

### I/O Solderless Terminal

The I/O terminals use M3 set screws. The following type of solderless terminal can be connected to these terminals

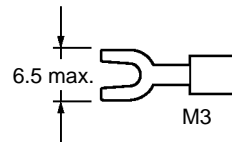

Tighten each screw to a torque of approximately 6 kgf • cm.

- Note**
1. Make sure that the input voltage does not exceed a maximum permissible input voltage of 26.4 V, otherwise the Controller may malfunction.
  2. Separate power lines and high-tension lines from the input line in order to protect the input line from noise interference.

### Wiring SYNC Signal

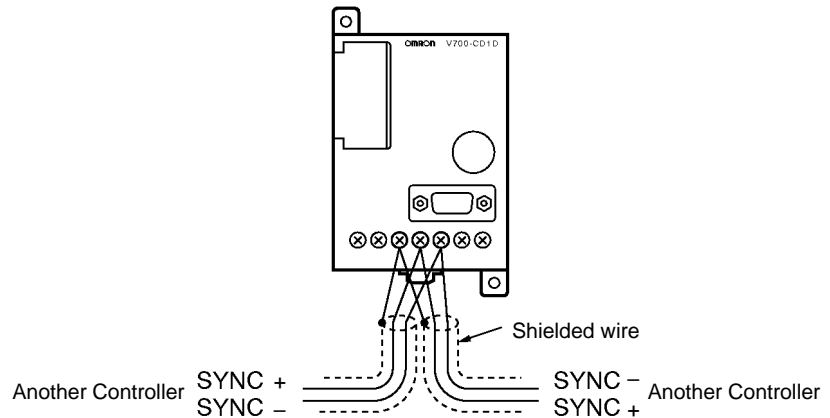

- Connect the SYNC signals of other Controllers operating in synchronization.

- If more than three Controllers operate in synchronization, two solderless terminals must be connected to a single terminal. In that case, insert the solderless terminals by overlapping the flat parts of the solderless terminals as shown below. Then secure the solderless terminals with the screw.

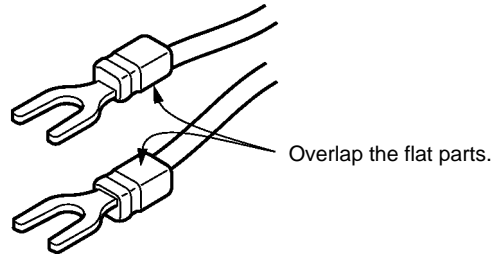

**Note** The SYNC line can be extended up to a total of 300 m.

### 4-1-6 Connection of RS-232C Interface (V700-CD1D-V3)

Signal name	Symbol	Signal direction		Pin number
		Input	Output	
Maintenance ground	GR	---	---	Shield
Signal ground or common retrace line	SG	---	---	5
Send data	SD	---	OK	3
Receive data	RD	OK	---	2
Request send	RS	---	OK	7
Clear to send	CS	OK	---	8

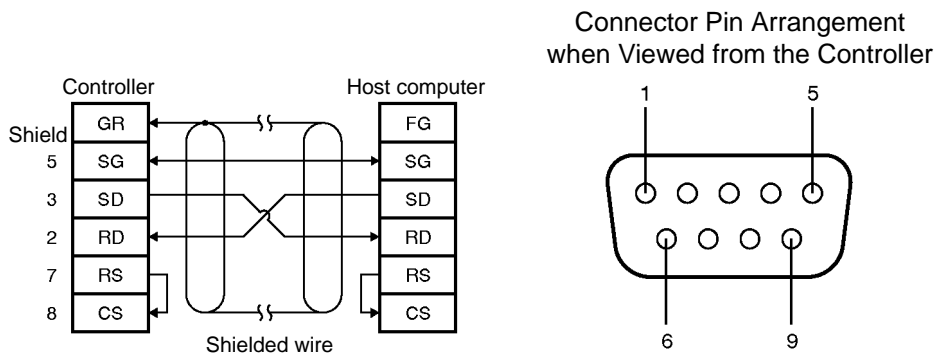

The diagram on the left-hand side indicates that the shielded wire is grounded on the Controller side.

- Note**
1. Ground the shielded wire on either the Controller side or the above host computer side.
  2. Internally short-circuit pins 7 (RS) and 8 (CS).

Connection to Host through IBM PC/AT or Compatible Computer, 9-pin Port

Connector Pin Arrangement when Viewed from the Controller

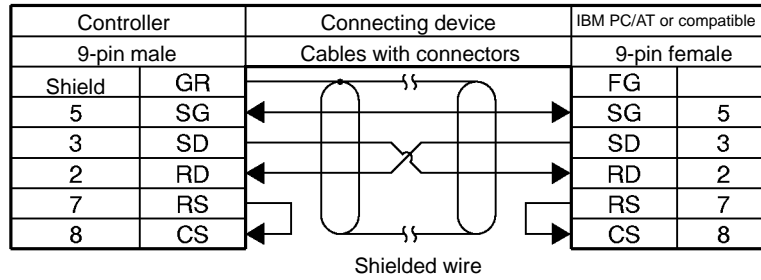

Connection to Host through PC98 or Compatible Computer, 25-pin Port

Connector Pin Arrangement when Viewed from the Controller

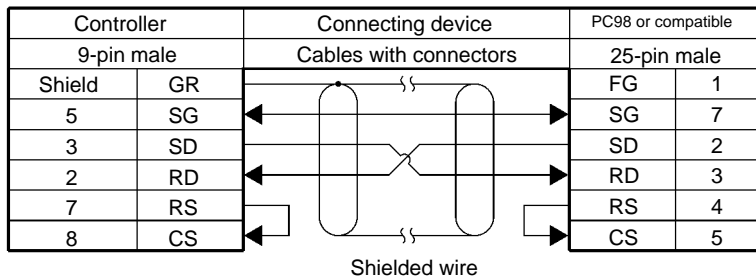
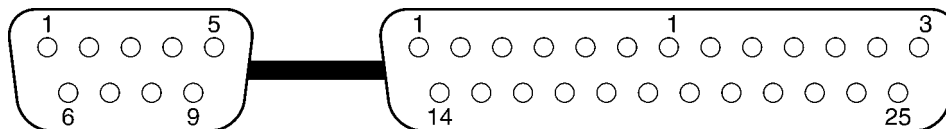

Connecting to OMRON C200H PC

Connector Pin Arrangement when Viewed from the Controller

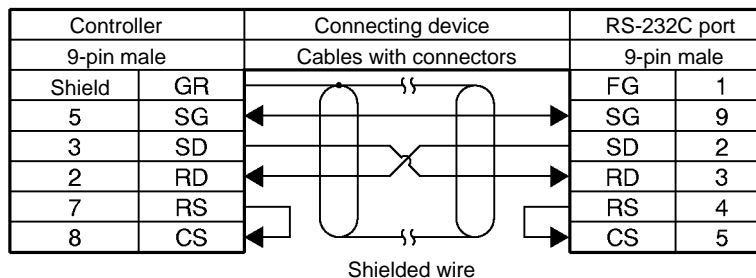

**Assembly and Connection of Communications Connector**

An OMRON communications connector conforming to EMI standards is provided with the Controller. Use this communications connector or an equivalent one.

Prepare a connection cable and a connector for the host computer. Refer to *Appendix B Ordering Information* for details.

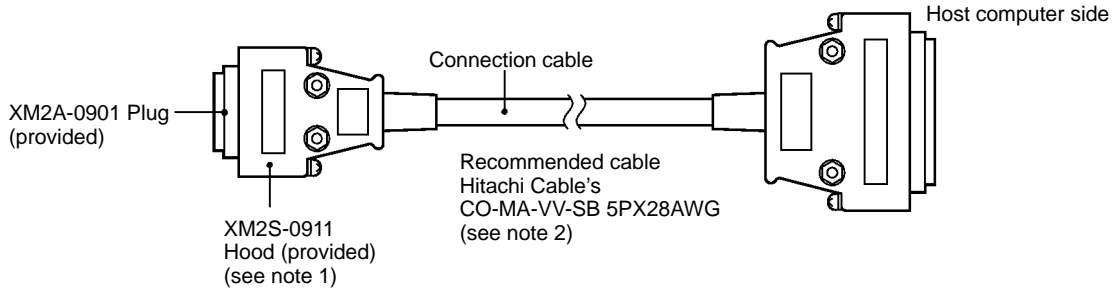

- Note**
1. A connector conforming to EMI standards is provided with the Controller.
  2. Use the above cable or an equivalent one with an external diameter of 7 mm.

**Assembly of Connector**

- 1, 2, 3... 1. Process the end of the cable as shown below.

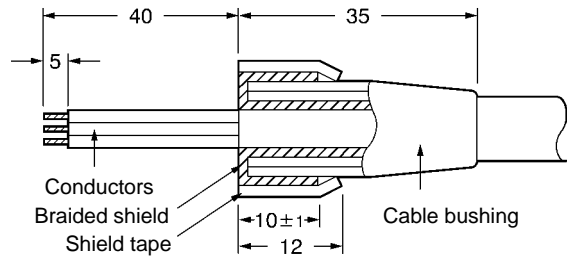

- Insert the cable into the cable bushing.
  - Untangle the braided shield for approximately 10 mm and fold it back on the cable bushing.
  - Apply shield tape to the untangled braided shield.
2. Solder the conductors to the plug pins.

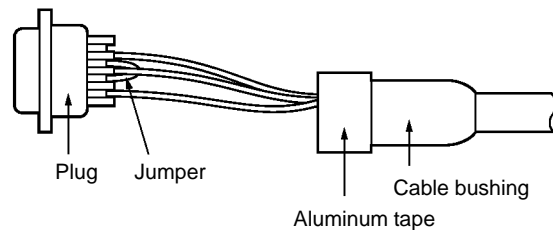

Pin number	Symbol	Name
Shield	GR	Ground
5	SG	Signal ground
3	SD	Send data
2	RD	Receive data
7 (see note)	RS	Request send
8 (see note)	CS	Clear to send

**Note** Short-circuit pins 7 (RS) and 8 (CS) with a jumper.

- Attach housing A2 of the Hood to the Plug and secure the aluminum-taped portion with the cable clamp and two screws.

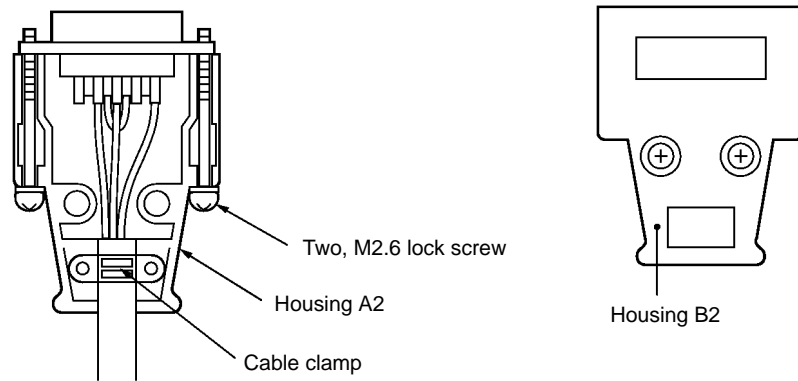

- Put on housing B2 to complete the connector assembly.

**Connection and Disconnection of Connector**

- When connecting the connector, be sure to hold the connector by hand and insert the connector. Then secure the connector with two lock screws.
- When disconnecting the connector, completely loosen the two lock screws. Then hold the protruding part of the connector hood by hand and pull the connector straight out. If the connector is difficult to disconnect, hold the Controller by hand while pulling out the connector.

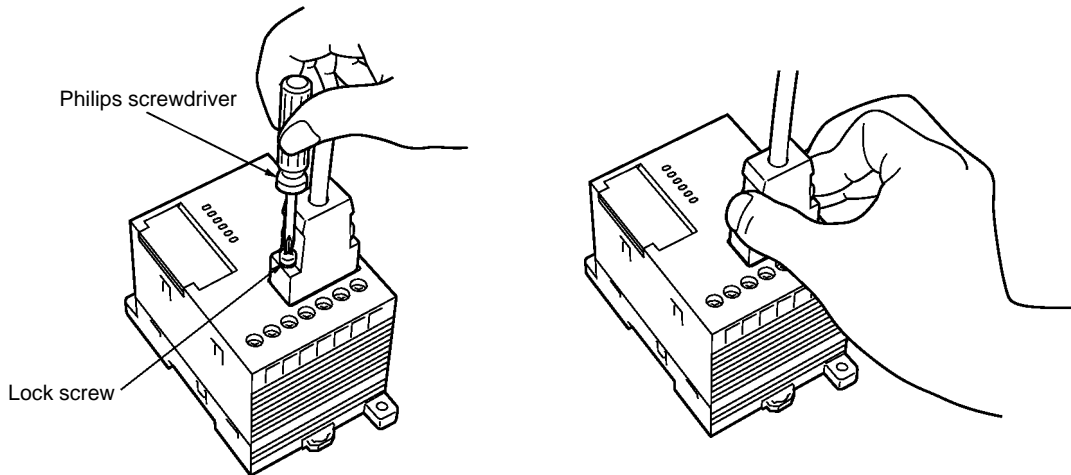

**Note** Example of Grounding from Controller

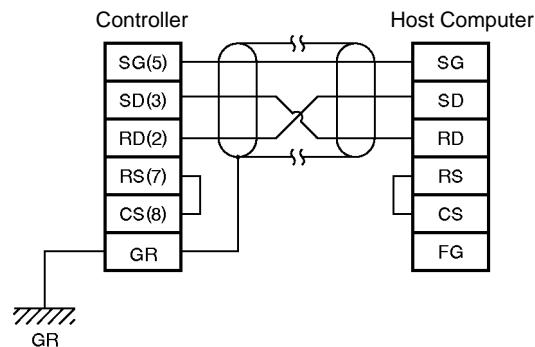

- The shielded wire must be grounded either from the Controller or the host computer for the prevention of system malfunctions. The above is an example of grounding from the Controller.
- Short-circuit the RS and CS pin in the connector.



### 4-1-7 RS-485 Interface Connection (V700-CD2D-V3)

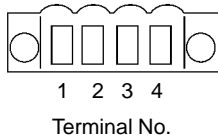

Terminal No.	1	2	3	4
Polarity	+	-	+	-

**Note** Terminals 1 and 3, and terminals 2 and 4, are short-circuited in the RS-485 Controller.

#### 1:N Connection

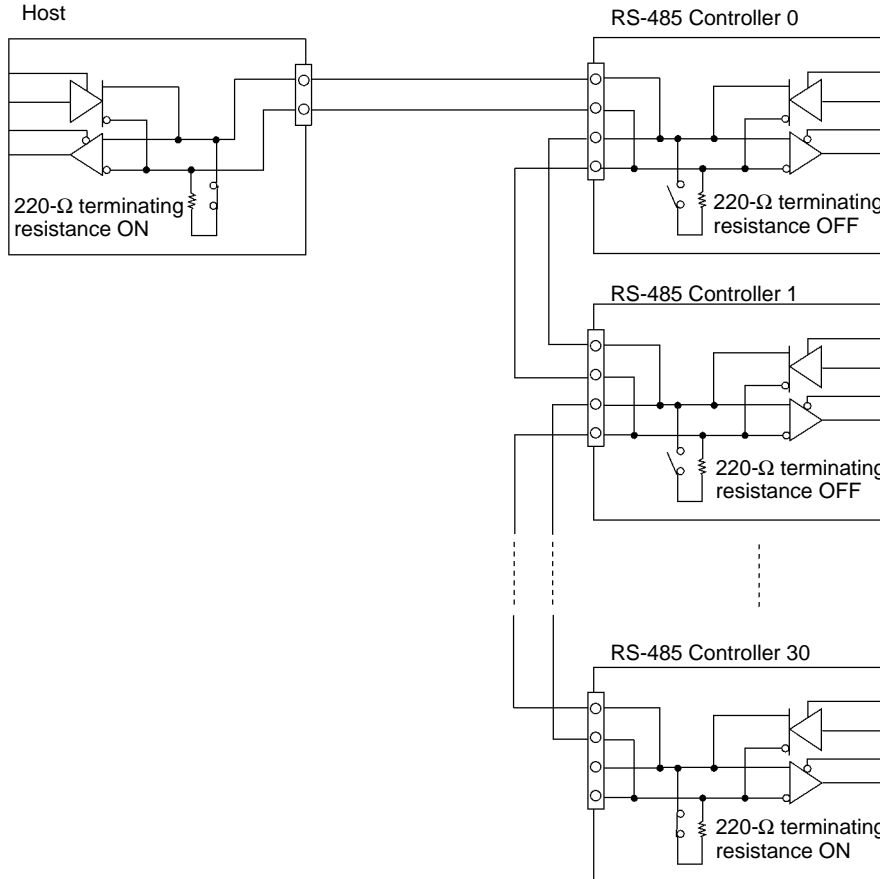

**Note** Have the host check the response from the Controller before sending the next command. If an RS-232C/485 converter is used at the host, make sure that the clear-to-send signal has been received before the command is sent. Then switch to receive status within 20 ms after the command has been fully sent. If not done in this way, it will not be possible to communicate with the Controller.

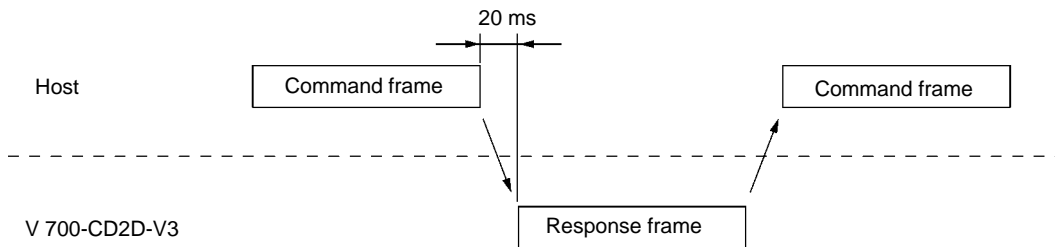

#### Wiring Examples

When using the mutual interference preventive function, use 4-wire shielded cable. Of the four wires, use two for synchronous cable and use the remaining two for RS-485 interface cable. Connect the shield to a ground terminal.

1:N Connection

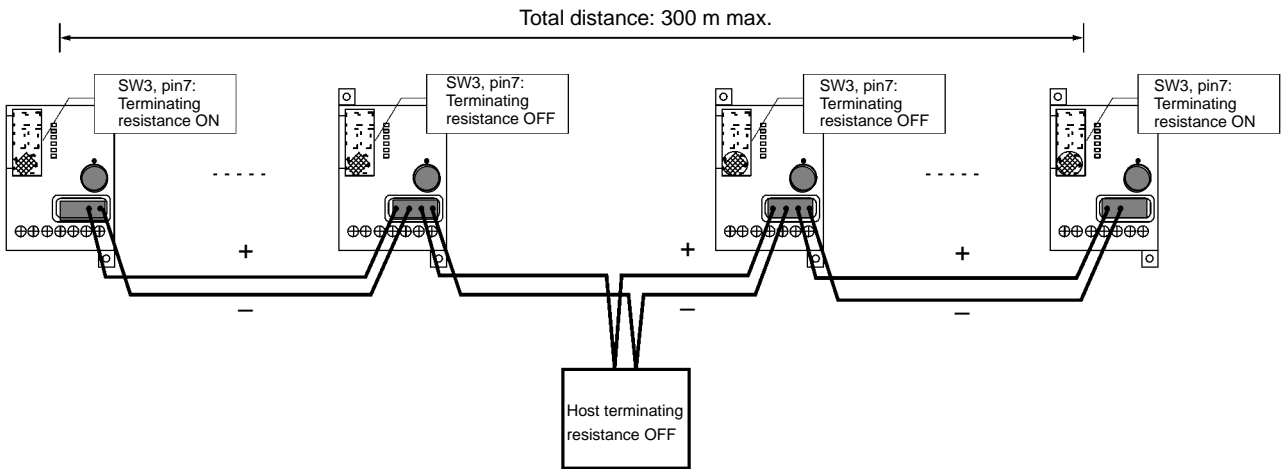
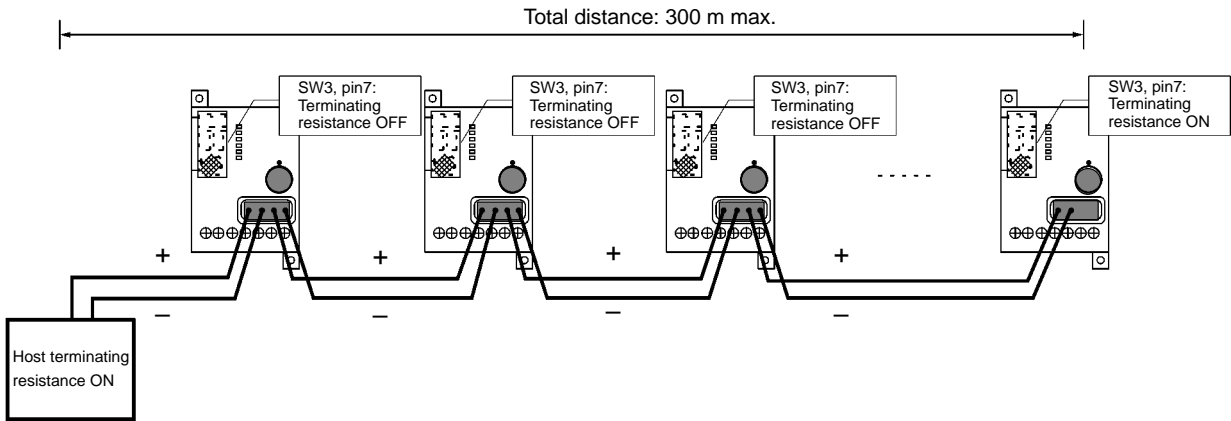

**Note** If the recommended cable is not used, wire a synchronous cable in parallel with the RS-485 interface cable. Even if this done, noise immunity will be reduced if the cable is wired as shown in example 2 or 3 below.

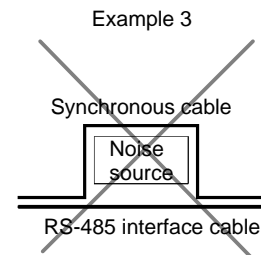
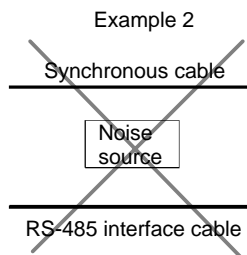
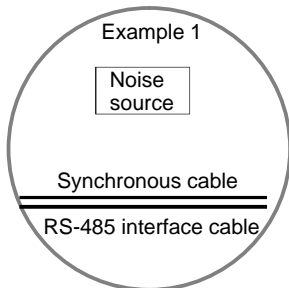

**Note** Noise source: Another device, power supply, AC adapter, etc.

**Connecting and Disconnecting the Connector**

- 1, 2, 3... 1. Attach crimp terminals to the ends of the cables with the insulating covering removed. While paying attention to the direction the connector is facing, insert the cables into the holes. (Use the connector that is provided.) To order connectors, contact Nihon Weidmüller Co., Ltd.

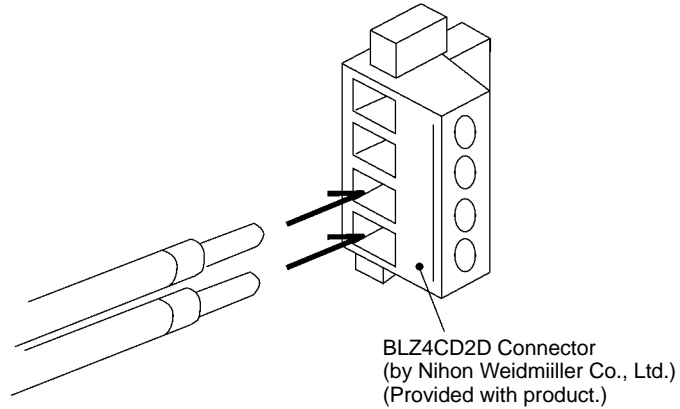

**Recommended Cable**

MVVS 4CX0.5Sq (by Tachii Electric Wire Co., Ltd.)

**Note** Of the four wires, use two for RS-485 interface cable and use the remaining two for synchronous cable. Connect the shield to a ground terminal. (Refer to *Wiring SYNC Signal* on page 44.)

**Recommended Crimp Terminal**

H-slip Series (by Nihon Weidmüller Co., Ltd.)

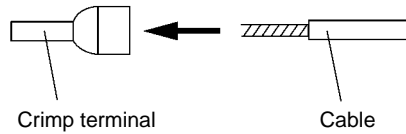

Insert the cable and crimp it.

**Special Crimping Tool**

PZ-series Crimper (by Nihon Weidmüller Co., Ltd.)

For further details, contact Nihon Weidmüller Co., Ltd.

2. Secure each of the cables by tightening the connector screws to a torque of approximately 0.5 N•m. Use a small flat-blade screwdriver (as shown be-

low) with a shaft of uniform thickness. If an ordinary screwdriver that narrows toward the tip is used, it will not fit all the way in.

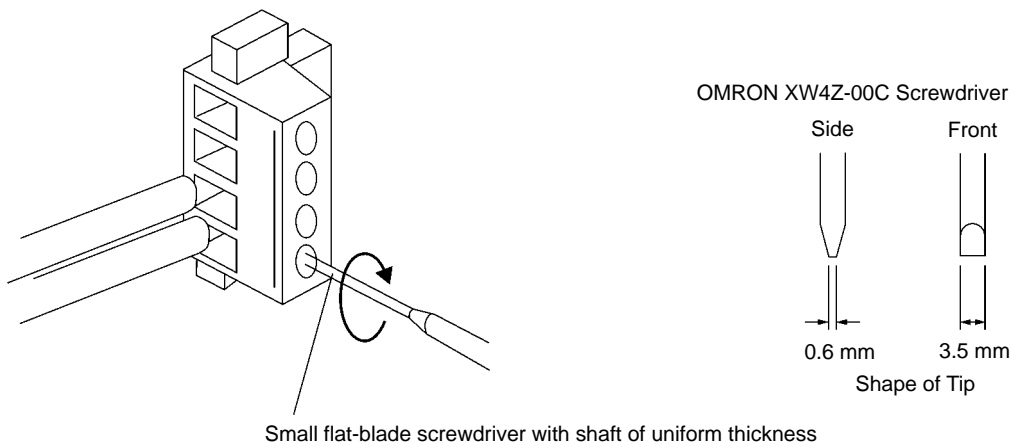

3. With the cable attached, connect the connector to the Controller. Align the cable connector with the connector at the Controller, and firmly push it all the way in. Then tighten the screws to a torque of 0.3 N•m.

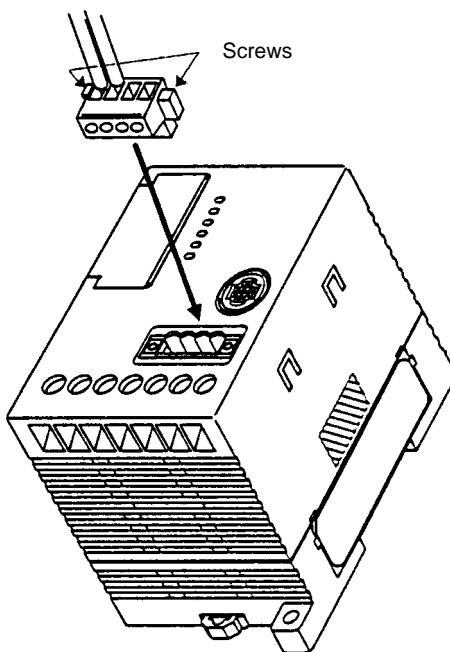

4. To remove the connector, first completely loosen the two screws and then grasp the protruding parts of the connector and pull it straight out. If it is difficult to pull out, then press down on the Controller while pulling on the connector.

**Caution** Do not connect the cable to the connector with the connector already mounted to the Controller.

## 4-2 Installation of Antenna

### 4-2-1 Installation Environment

#### Installation Location

Do not install the Antenna in the following locations.

- The ambient temperature is not within a range between  $-20^{\circ}\text{C}$  and  $55^{\circ}\text{C}$  or locations with radical temperature changes resulting in condensation.
- The humidity is not within a range between 35% and 80%.
- There is corrosive gas, flammable gas, dust, salt, or metal powder.
- The Antenna will be subjected to direct vibration or shock.
- Water, oil, or chemical will be sprayed onto the Antenna.

**Countermeasures Against Noise**

The communications range of the Antenna drops due to ambient noise. Refer to 8-2 *Communications Distance Characteristics vs. Ambient Noise* for details.

The following provides information on countermeasures against ambient noise.

**Power Lines and High-tension Lines**

Do not wire the Antenna cable along with high-tension lines or power lines. Keep the Antenna cable as far away as possible from them.

**Inverters, Motors, and Other Driving Mechanisms**

Be sure to ground the frames of driving mechanisms and keep them as far away as possible from the Antenna.

**Displays of Personal Computers and Programmable Terminals**

Keep the displays of personal computers and Programmable Terminals as far away as possible from the Antenna.

**Switching Power Supplies**

Be sure to ground switching power supplies and keep them as far away as possible from the Antenna.

If the Antenna is still influenced by noise in spite of the above countermeasures taken, the communications range must be reduced.

The Controller in stable communications mode rather than long-distance mode withstands more ambient noise although the communications range decreases.

**Note** Keep the above in mind before installing the Antenna. Before the Antenna is put in actual use, be sure to conduct enough tests of the Antenna.

**4-2-2 Mounting the Antenna**

Be sure to attach the provided bracket to the Antenna and mount the Antenna with four, M4 screws with spring washers and flat washers as shown below.

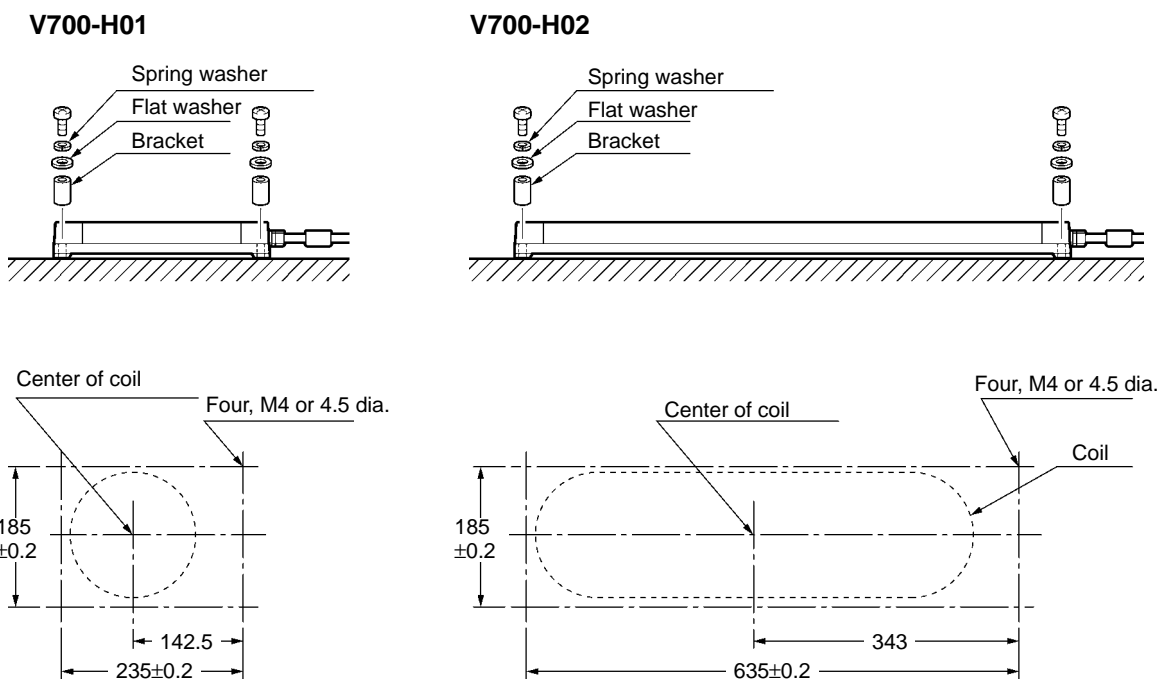

## 4-3 ID Tag

### 4-3-1 Installation Environment

Do not install the V700-D23P31 or V700-D13P21 ID Tag in the following location.

- There is corrosive gas, flammable gas, dust, or metal powder.

Do not install the V700-D13P21 ID Tag in the following locations.

- The ambient temperature is not within a range between  $-10^{\circ}\text{C}$  and  $50^{\circ}\text{C}$  or there are radical changes in temperature resulting in condensation.
- Water, oil, or chemical will be sprayed onto the ID Tag.

### 4-3-2 Mounting Method

Observe the following restrictions during mounting.

- Do not cut or open holes in the ID Tag.
- Do not impose excessive force on the ID Tag,
- Do not mount or attach the ID Tag close to metal objects.

#### V700-D23P31

#### ID Tag Mounting Direction

Mount the ID Tag parallel to the Antenna. There are no differences in characteristics between the front and back surfaces.

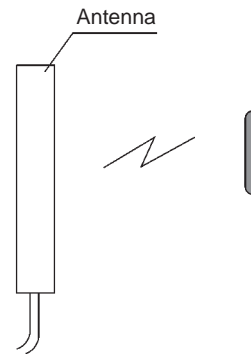

#### Mounting Example (Using Adhesive)

It is recommended that the ID Tag be mounted either by using the special V700-A80 Attachment or by using an adhesive. (For Attachment specifications, refer to 2-3-4 V700-A80 Attachment (For V700-D□□P31))

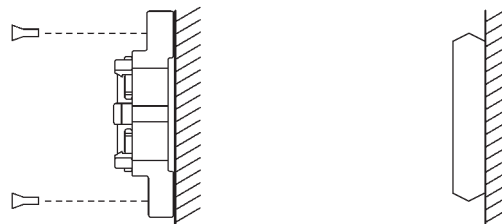

#### Recommended Adhesive

Epoxy-based adhesives are recommended for use with materials such as resin or plastic.

Ambient temperature	Name	Maker
$-40^{\circ}\text{C}$ to $+110^{\circ}\text{C}$	Two-part epoxy resin adhesive	CEMEDINE Co., Ltd.

**Note** If the part to be bonded is made of polyethelene, polypropylene, or a Fluorine Resin-based or silicon-based resin, the above adhesive may not have sufficient

strength. Check the materials in advance, and contact the maker for details on adhesive characteristics.

**V700-D23P41**

**ID Tag Mounting Direction**

If the ID Tag is mounted with the rounder surface facing the Antenna, as shown in the following diagram, the communications distance will be increased. If the ID Tag is faced in the opposite direction, the communications distance will be decreased by approximately 10 mm.

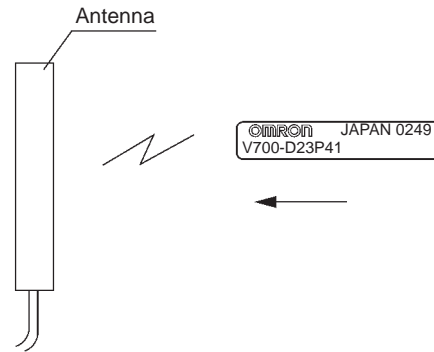

**Mounting Example (Using Adhesive)**

For the ID Tag mounting method, refer to the following diagram. The ID Tag may be damaged if it is pressed in, so it is recommended that it be secured by adhesive.

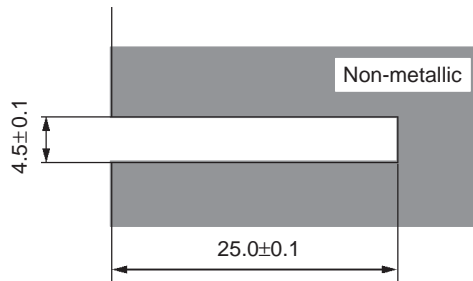

**Note** The diameter of the ID Tag itself is 4 mm. If the ID Tag is mounted using adhesive, the adhesive must fit into the space between the ID Tag and the panel, so the hole diameter should be approximately 4.5 mm.

**Recommended Adhesives**

Epoxy-based adhesives are recommended for use with materials such as resin or plastic. The following adhesives are recommended depending on the ambient temperature in which they are to be used.

Ambient temperature	Name	Maker
-40°C to +70°C	Two-part, epoxy-compound resin 2001 (adhesive) and 2105C (hardener)	Three Bond Co., Ltd.
-40°C to +110°C	One-part, epoxy-compound resin 2285	Three Bond Co., Ltd.

**Note** If the part to be bonded is made of polyethelene, polypropylene, or a Fluorine Resin-based or silicon-based resin, the above adhesive may not have sufficient strength. Check the materials in advance, and contact the maker for details on adhesive characteristics.





# SECTION 5

## Communications Functions

This section provides the communications functions and provides details on communications-related data and commands.

5-1	Commands and Responses	58
5-2	Movement of ID Tag and Command	59
5-2-1	Operating Status of Controller	59
5-3	Communications Operating Sequence	59
5-3-1	Single Trigger Mode	60
5-3-2	Single Automatic Mode	61
5-3-3	Single, FIFO, and Multiple Repeat Mode	61
5-3-4	Polling Auto Mode	63
5-3-5	Multi-trigger and Multi-repeat Modes	64
5-3-6	Selective Access Mode	64
5-4	Command and Response Frame Structure	67
5-5	Command List	69
5-6	List of Options	70
5-7	Data Code Designation	70
5-7-1	ASCII Code Designation: A	70
5-7-2	HEX Code Designation: H	71
5-7-3	Designation Range of First Address and Bytes	71
5-7-4	Example of BCC Calculation	72
5-8	Explanation of Commands and Responses	73
5-9	ACK/NACK Control	73
5-10	Communications Commands	74
5-10-1	READ: RD	74
5-10-2	WRITE: WT	75
5-10-3	ADD: AD	76
5-10-4	SUBTRACT: SB	77
5-10-5	POLLING AUTOREAD: PR	78
5-10-6	POLLING AUTOWRITE: PW	79
5-10-7	MEMORY CHECK: MC	79
5-10-8	MEMORY CALCULATE: MK	80
5-10-9	WRITE PROTECT: WP	82
5-11	Communications Subcommands	84
5-11-1	POLLING CHECK: PC	84
5-11-2	POLLING END: PE	84
5-12	Control Commands	85
5-12-1	STOP: ST	85
5-12-2	RESET: XZ	85
5-13	Host Command	86
5-13-1	TEST: TS	86
5-14	Host Subcommands	86
5-14-1	ACK: AK	86
5-14-2	NACK: NK	86
5-15	Other Command	87
5-15-1	Undefined Command Response	87
5-16	Response Codes	87
5-17	Connecting Commands	88
5-18	Communications Programming Example	89

## 5-1 Commands and Responses

In order to communicate with the ID Tag in the communications area of the Antenna, commands must be selected and used according to the mode and movement of the ID Tag.

### ID Tags in Communications Area

ID Tags operate in single mode, FIFO read/write mode, or multiple, simultaneous access mode according to the number and provided conditions of ID Tags in the communications area.

#### Single Mode

In single mode, only a single ID Tag can exist in the communications area. A communications error will result if there are two or more ID Tags in the communications area.

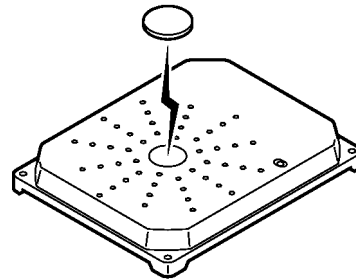

#### FIFO Read/Write Mode

In the FIFO (first-in, first-out) read/write mode, the RD-ID System reads and writes data to and from each ID Tag coming into the communications area one after another. Since every ID Tag finished with communications is set to access prohibit, communications will be possible if only one ID Tag newly arrives in the communication area of the Antenna where more than one ID Tag exists. An error, however, results if two or more ID Tags arrive in the communications area simultaneously. When the access-prohibited Tag moves out of the communications area, communications will become possible again.

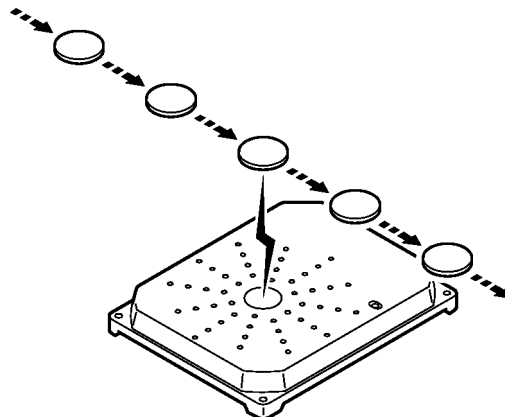

**Multiple, Simultaneous Access Mode**

In this mode, communications with all ID Tags in the communications area can be made on receipt of the command.

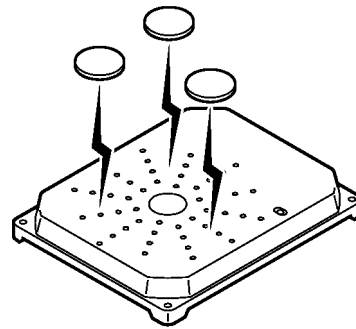

**Note** In FIFO read/write mode, make sure that multiple ID Tags do not arrive in the communications area together, otherwise a communications error will result and further communications will not be possible until there is only a single ID Tag in the communications area.

## 5-2 Movement of ID Tag and Command

The V700-series RF-ID System (1) receives a command from a connected host, and (2) communicates with an ID Tag according to that command. Then (3) the results are returned to the host as a response.

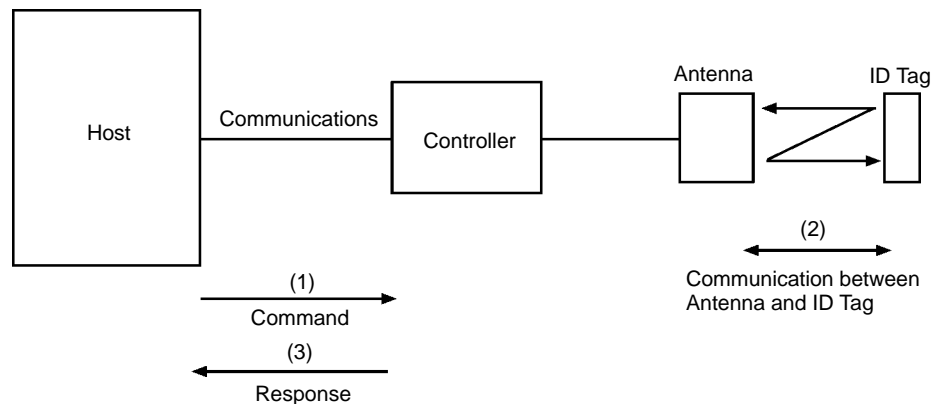

### 5-2-1 Operating Status of Controller

**Ready to Receive Command**

In this state, the Controller has no command in process and the Controller is ready to receive any command other than a subcommand. When a command is received, the Controller starts processing the command.

**Processing Command (Except POLLING AUTOREAD Command)**

After a command is received by the Controller, the Controller ignores the next command until the Controller processes the command and returns a response. The Controller, however, accepts the STOP or RESET command anytime.

## 5-3 Communications Operating Sequence

The sequence for operations such as communicating with ID Tags and the timing for returning responses will vary depending on the instructions in the command. It must be handled according to the status of ID Tags in the Antenna communications area and the form of the connection with the host.

### 5-3-1 Single Trigger Mode

In this mode, the Controller communicates with the ID Tag in the communications area provided that the ID Tag is not moving. Therefore, it is necessary to check that the ID Tag is at a standstill in the communications area. If the ID Tag is not in the communications area, an error response is returned.

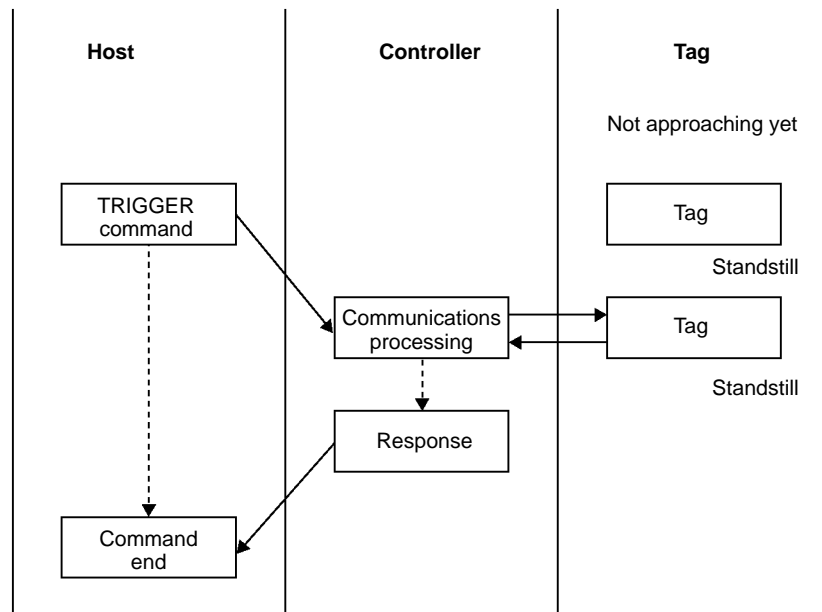

- 1, 2, 3...**
1. The host must send the command after checking that the ID Tag has come to a standstill in the proper position.
  2. The Controller communicates with the ID Tag for data processing according to the command.
  3. After the data is processed, the Controller returns a response indicating that the Controller is finished with data processing. The host receives the response and waits for the next ID Tag to approach.

**Note** When operating the system in single trigger mode, make sure that the ID Tag is in the communications area when sending the command.

### 5-3-2 Single Automatic Mode

In this mode, the Controller waits for the ID Tag to approach the Antenna communications area, and then communicates with the ID Tag.

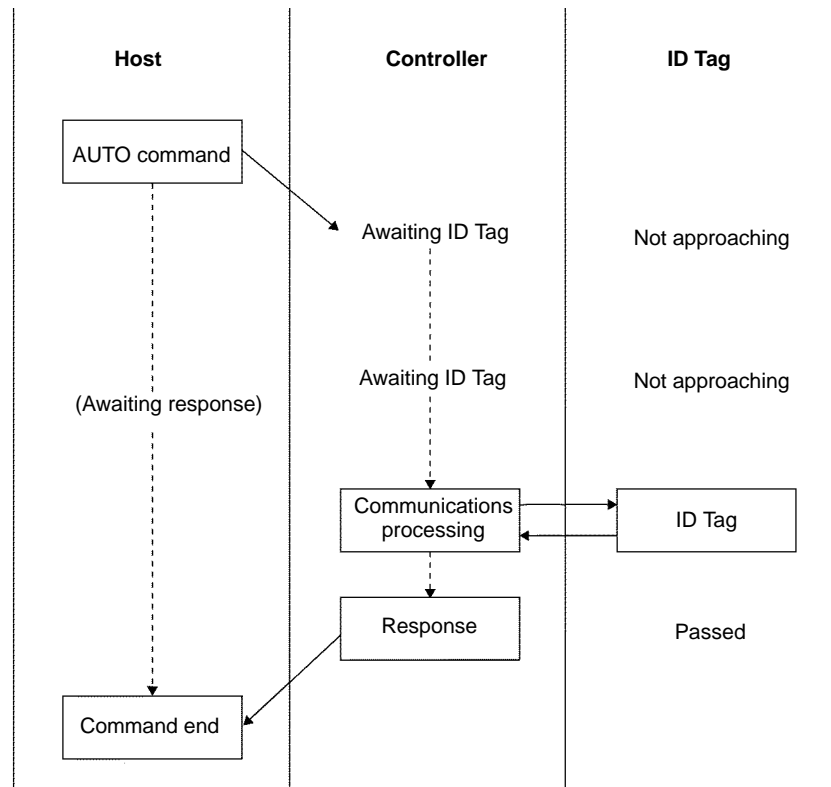

- 1, 2, 3...**
1. The host sends the AUTO command.
  2. The Controller does not return a response while the ID Tag is approaching. During this time the communications path between the host and Controller is kept busy.
  3. When the ID Tag passes in front of the Antenna, the Controller processes the communications data exchanged with the ID Tag according to the command.
  4. After the data is processed, the Controller returns a response to the host indicating that the Controller is finished with data processing.

**Note** In automatic mode, while the communications path between the host and Controller is busy, the host cannot send the next command.

### 5-3-3 Single, FIFO, and Multiple Repeat Mode

In single, FIFO, or multiple repeat mode, when the Controller receives a command from the host, it waits for an ID Tag to approach. Whenever an ID Tag passes through the communications area, the Controller communicates with the ID Tag and returns a response to the host. In this mode, the next command other than the STOP or RESET command is not accepted until the operation of the Controller is stopped or reset with the STOP or RESET command. When the

Controller is stopped or reset, the Controller is ready to receive the next command.

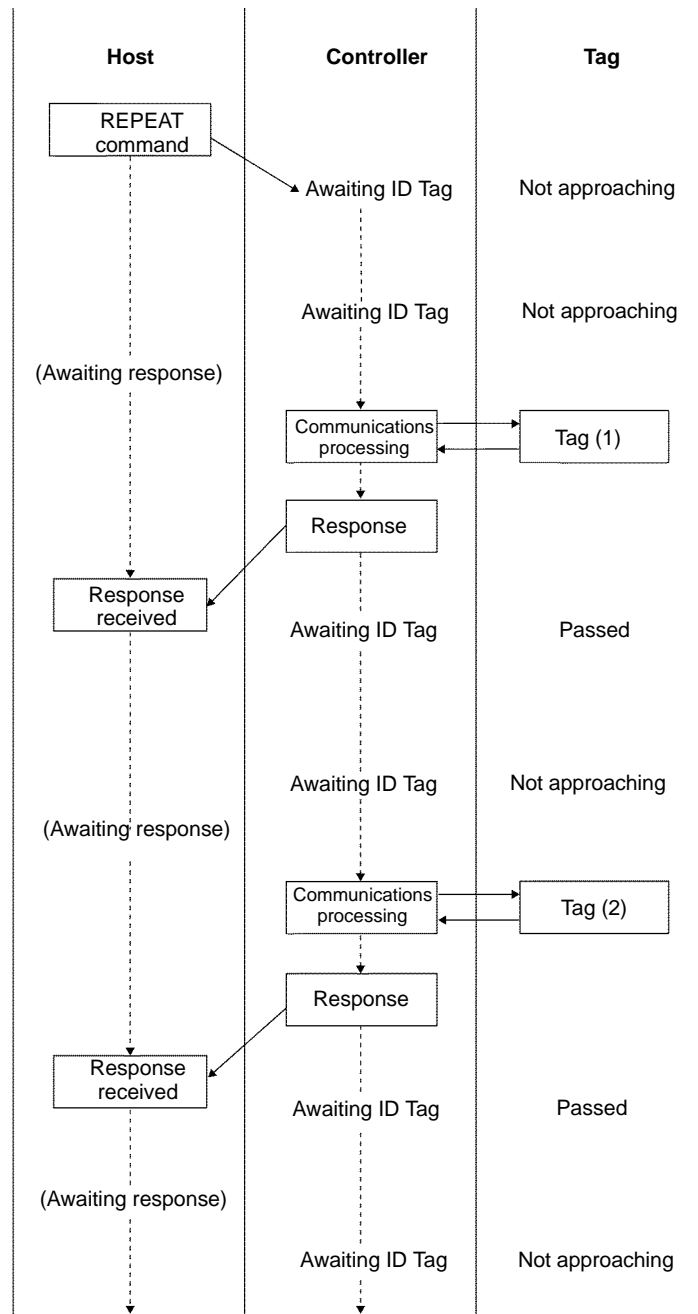

- 1, 2, 3...**
1. The host sends the REPEAT command.
  2. The Controller does not return a response while the ID Tag is approaching, during which the communications path between the host and Controller is kept busy.
  3. When the ID Tag passes through the communications area of the Antenna, the Controller communicates with ID Tag according to the command.
  4. After the data is processed, the Controller returns a response to the host indicating that the Controller is finished with data processing. Then the Controller awaits the next ID Tag.
  5. When the next ID Tag passes through the communications area of the Antenna, the Controller communicates with the ID Tag.

6. After the data is processed, the Controller returns a response to the host indicating that the Controller is finished with data processing.

**Note** In order to send the next command while the Controller is in repeat mode, be sure to execute the STOP or RESET command so that the Controller will stop processing the current command and be ready to receive the next command.

### 5-3-4 Polling Auto Mode

If a normal AUTO command is used while a single host is controlling more than one Controller, responses will be returned when communication with the ID Tag is completed and thus responses will be returned by multiple Controllers simultaneously. However, if the POLLING AUTO command is sent instead, the Controllers will return responses at the request of the host. In this way, responses will not be sent simultaneously and multiple Controllers can be controlled. While the POLLING AUTO command is executed, no command other than the POLLING subcommand, RESET command, or STOP command can be executed.

In the following example, the POLLING AUTO command is executed to two Controllers.

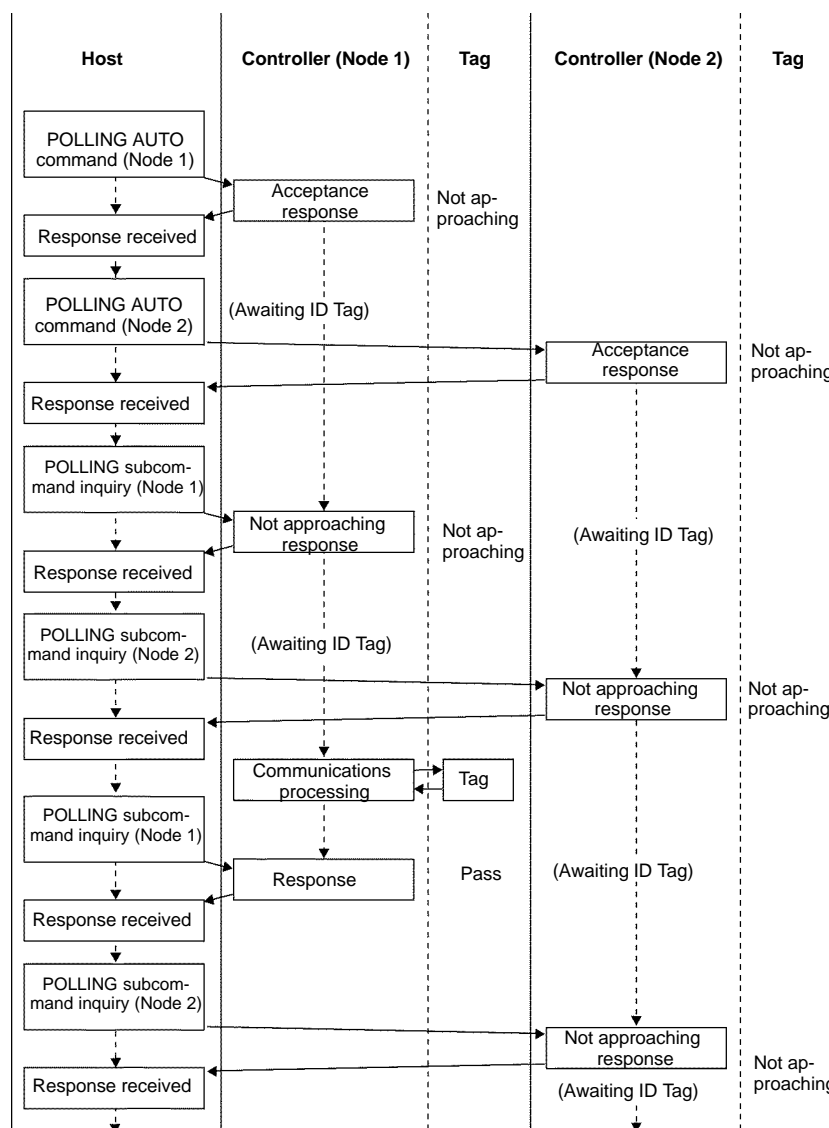

1, 2, 3... 1. The host sends the POLLING AUTO command to node 1.

2. After the command is received, the Controller returns a response to the host indicating the acceptance of the command.
3. The host sends the POLLING AUTO command to node 2.
4. After the command is received, the Controller returns a response to the host indicating the acceptance of the command.
5. The host can use subcommands to check the process of command execution or cancel the execution of the POLLING AUTO processing. If the ID Tag has not approached yet, a response indicating the status is sent in reply to an inquiring subcommand.
6. When the ID Tag passes through the communications area of node 1's Antenna, communication is established.
7. If a subcommand is sent for confirmation to the Controller that has finished processing communications with the ID Tag, the Controller will return a response of a process result.

### 5-3-5 Multi-trigger and Multi-repeat Modes

Data is exchanged with all ID Tags in the communications area. There are two modes used: multi-trigger and multi-repeat. In multi-trigger mode, data is exchanged with all ID Tags in the communications area when a command is received, and a communication completed response is returned when the processing ends. In multi-repeat mode, ID Tags are awaited from the point when a command is received, and communications continue with all ID Tags approaching the communications area. Processing is stopped by a STOP command.

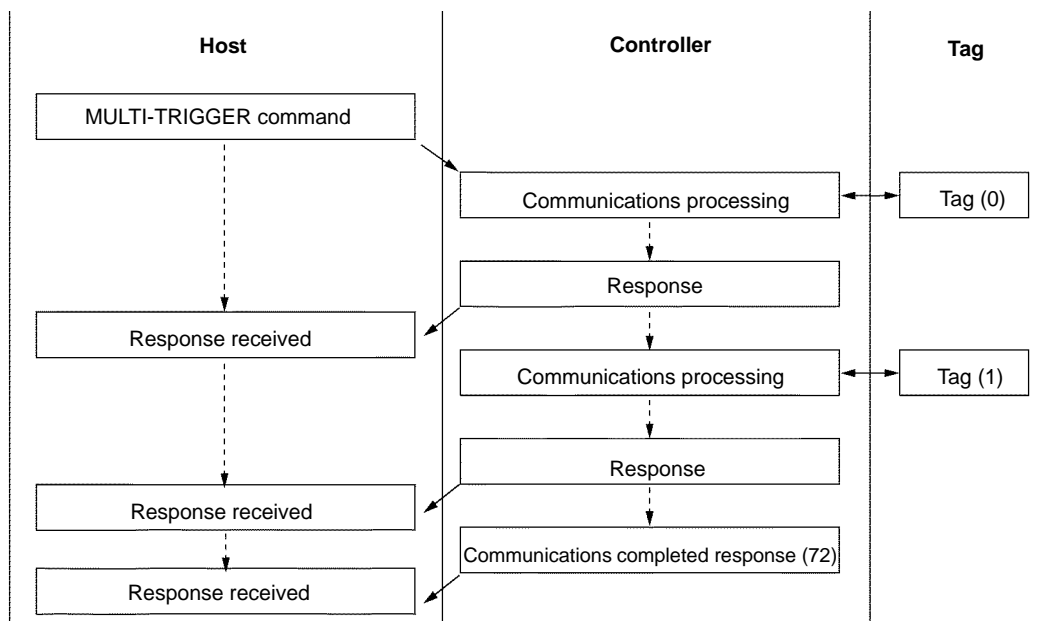

**Note** When using the multi-trigger mode, do not set the Controller to energy-saving mode.

### 5-3-6 Selective Access Mode

In this mode, data is exchanged with specific ID Tags in the communications area. Two commands are used. One is the DETECT TAG command, which assigns simple numbers to ID Tags in the communications area, and the other is



the SPECIFY TAG command, which communicates with specific ID Tags based on the simple numbers that have been assigned.

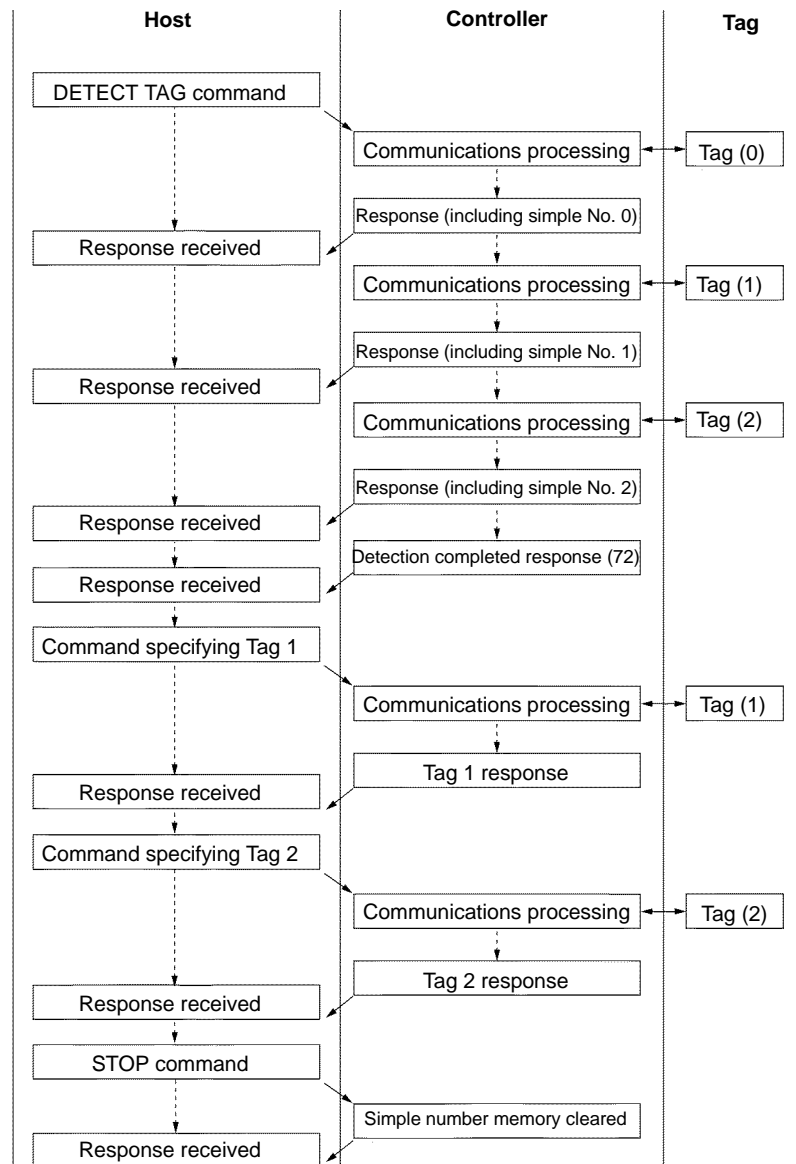

- 1, 2, 3...**
1. The host sends a DETECT TAG command to the Controller.
  2. The Controller communicates with ID Tags in the communications area and saves a maximum of 16 simple numbers (0 to F) in its internal memory. At the same time, the Controller includes those simple numbers in its response to the host. When the Controller has completed communicating with all ID Tags in the communications area, it sends a detection completed response to the host.
  3. The host attaches a SPECIFY TAG command to the simple number of any ID Tag with which it wants to communicate, and then it sends it to the Controller.
  4. The Controller executes the SPECIFY TAG command for the ID Tag corresponding to the simple number.
  5. When the processing has been fully completed, the host sends a STOP command to the Controller. After the Controller receives the STOP command, it clears from its memory the simple numbers that it had saved. (The numbers are not cleared until the STOP command is executed.)

**Note** When using the selective access mode, set the Controller to energy-saving mode.

**Precautions when Using Selective Access Mode**

- 1, 2, 3... 1. When using the selective access function, set pin 5 of the Controller's switch 3 to ON and set the Controller to energy-saving mode. A command error will occur if selective access is used while in the normal oscillation mode.
2. If an ID Tag with the simple number specified by the SPECIFY TAG command does not exist in the communications area, the Controller returns a no Tag error to the host.

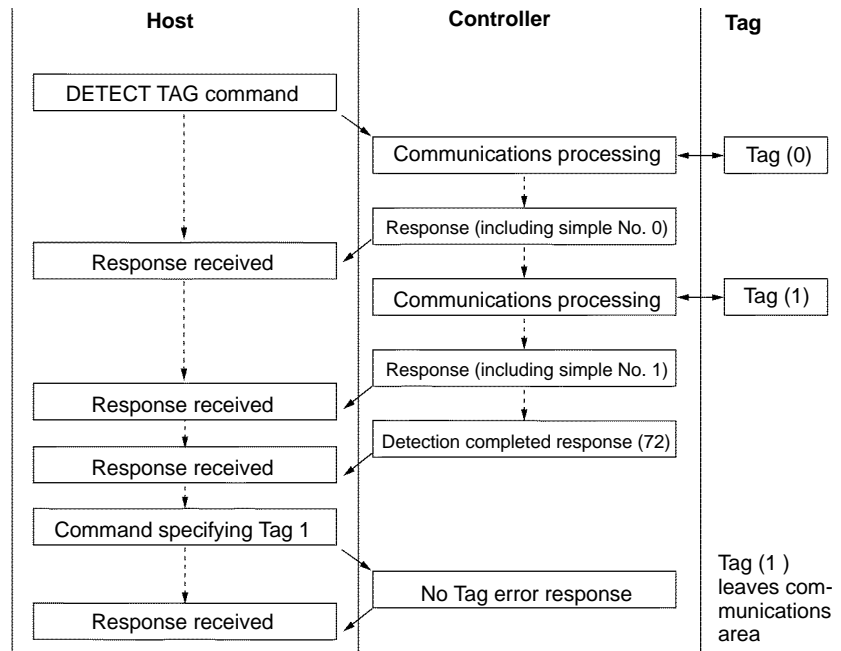

3. If a SPECIFY TAG command specifies a simple number that is not saved in the Controller memory, the Controller returns a no Tag error to the host.

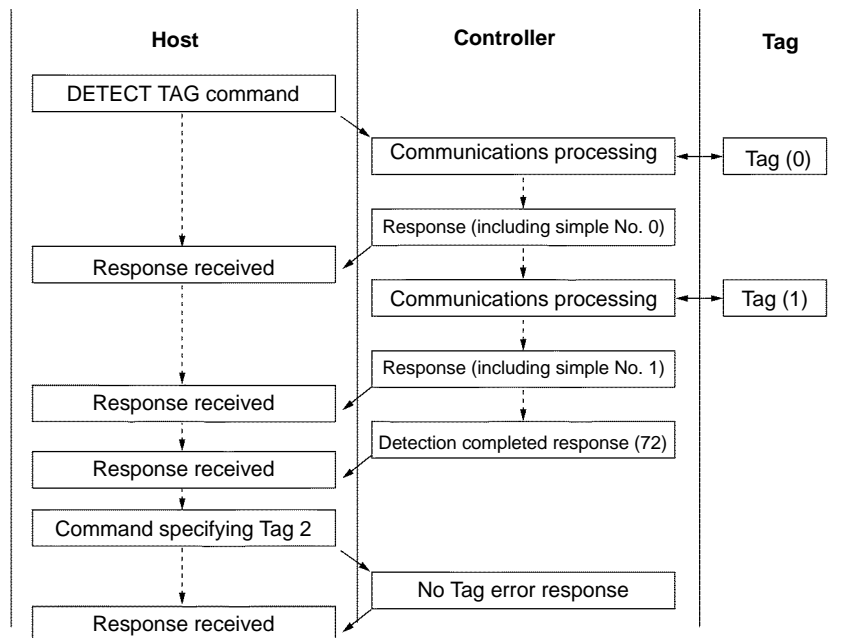

4. If there are 17 or more ID Tags in the communications area when a DETECT TAG command is executed, simple numbers are saved in the Controller

memory for 16 of them and not for the others. The Controller, however, returns a response to the host for all of the ID Tags, with "X" indicated instead of the simple number for all of the ID Tags exceeding 16. If X is specified in a SPECIFY TAG command, the Controller returns a command error to the host.

5. Once the Controller has saved a simple number to memory, that number is not cleared until a STOP command is executed. Until a STOP command is executed, no commands other than selective access commands are accepted (with the exception of RESET (XZ) commands). If the DETECT TAG command is executed again with no new ID Tag entering the communications area, the Controller returns only a detection completed response to the host.
6. If a new ID Tag enters the communications area after a DETECT TAG command has been executed, then, when the DETECT TAG command is next executed, data is exchanged with only that new ID Tag, and the Controller saves the simple number to memory. (If there are already 16 simple numbers saved in the Controller memory, the new ID Tag is handled as described in (4) above.)

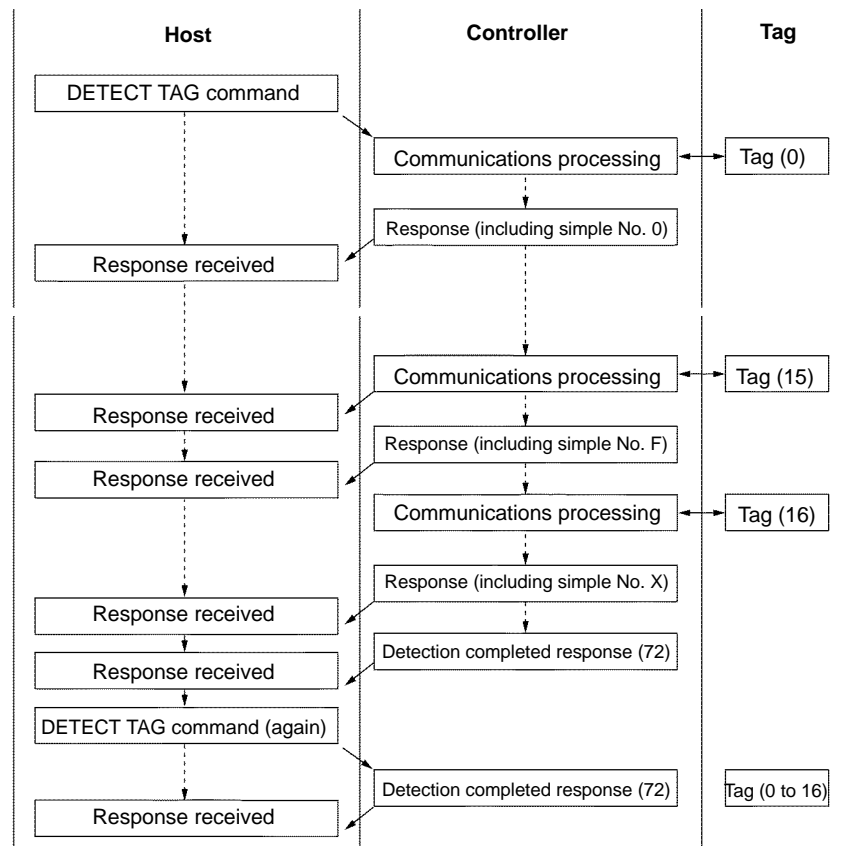

**Note** When using the selective access mode, do not set the Controller to energy-saving mode.

## 5-4 Command and Response Frame Structure

Commands and responses exchanged between the host and Controllers are in the following frame structure.

**BCC Enabled**

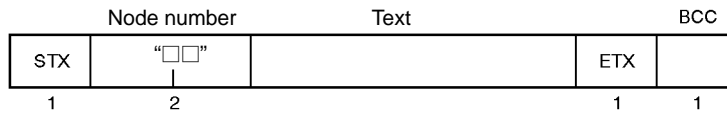

**BCC Disabled**

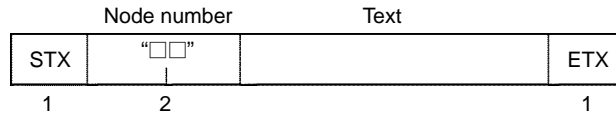

Name	Description
STX	This code indicates the beginning of a communications frame. This code is 02h in ASCII.
Node number	This indicates the node number of the Controller that can be set within a range between 00 and 31 (decimal) on the rotary switches of the of the Controller. If a node number is identically set to one that is set by using the node number setting switch on the Controller, a response will be returned with the same node number.
ETX	This code specifies the end of the command/response. This code is 03h in ASCII.
BCC	This stands for block check character. The results of horizontal parity calculation from just after STX through ETX is displayed with a single character.

**Command**

The text of a command consists of a command code and an option that specifies a variety of data items.

After receiving STX, the Controller receives data up to ETX. Then the Controller will execute the command if the node number in the command is correct. If STX is received again after the first STX is received and before receiving ETX, the first STX will be ignored.

**BCC Enabled**

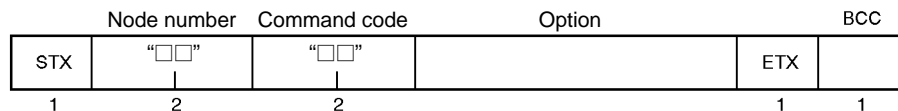

**BCC Disabled**

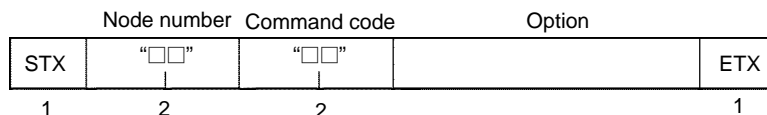

Name	Description
Command code	The command code indicates the command that the Controller executes. Refer to 5-5 List of Commands for all command codes available.
Option	Used to designate specified optional settings or to designate read data or write data. For details, refer to the format of each command.

**Response**

The text of a response consists of a Retry Flag, command code, response code, and text data.

**BCC Enabled**

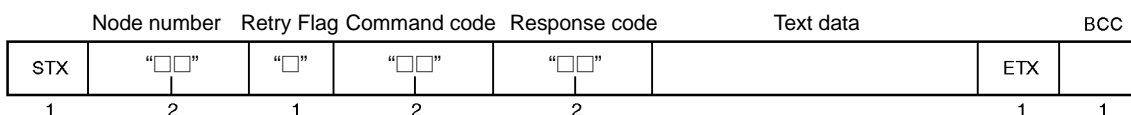

**BCC Disabled**

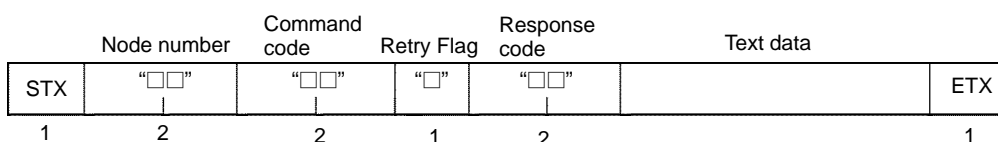

Name	Description
Retry Flag	The Retry Flag is set to 0 if ACK OR NACK control is not used. The Retry Flag is set to 1 and the previous response is returned if no ACK is received within a specified time in ACK/NACK control.
Command code	The executed command code is sent.
Response code	A response code is attached to the result of command execution and sent to the host. Refer to 5-16 List of Response Codes.
Text data	Some commands enable the Controller to send data. Refer to the frame structure of each command for details.

## 5-5 Command List

Commands can be classified into five types.

- 1, 2, 3... 1. Communications Command  
The communications command is used for communications with ID Tags.
2. Communications Subcommand  
The subcommand is used for the inquiry of the results or cancellation of execution when the POLLING AUTO command is used.
3. Controller Control Command  
The Controller control command is used for interrupting communications with ID Tags or resetting the Controller.
4. Host Command  
The host command is used for communications tests of the host and Controllers.
5. Host Subcommand  
The host subcommand is used for ACK/NACK control.

Command type	Command code	Command name	Function
Communications command	RD	READ	Reads memory data from a Tag.
	WT	WRITE	Write data to the memory of a Tag.
	AD	ADD	Adds the specified data to memory data in hexadecimal and writes the results to the memory of a Tag.
	SB	SUBTRACT	Subtracts the specified data from the memory data in hexadecimal and writes the results to the memory of a Tag.
	PR	POLLING AUTO	Performs a single autoread using polling.
	PW	POLLING AUTOWRITE	Performs a single autowrite using polling.
	MC	MEMORY CHECK	Compares check codes in Tag memory.
	MK	MEMORY CALCULATE	Calculates check codes in Tag memory.
	WP	WRITE PROTECT	Sets and releases write protection for each page.
Communications subcommand	PC	POLLING CHECK	Checks polling operation with the Controller.
	PE	POLLING END	Ends polling.
Controller control command	ST	STOP	Ends communications with the ID Tag.
	XZ	RESET	Resets the Controller after receiving the command.
Host command	TS	TEST	Sends the received data to the host.
Host subcommand	AK	ACK	Sends this command to the Controller if a proper response for ACK/NACK control is possible.
	NK	NACK	Sends this command to the Controller if proper response for ACK/NACK control is impossible.

## 5-6 List of Options

The following eight options can be placed in the READ, WRITE, ADD, and SUBTRACT command frame structure to specify communications according to the number of ID Tags in the communications area, their conditions, the movement of the ID Tags, and the operating status of the Controller.

Symbol	Name	Description
ST	Single Trigger	Immediately after receiving a command, the Controller communicates with the Tag and sends a response. After sending a response, the Controller is set to a standby state and waits for a new command. There should be only one Tag within the communications area of the Antenna.
SA	Single Auto	After receiving a command, the Controller waits for an approaching Tag, communicates with the Tag, and sends a response. After sending a response, the Controller is set to a standby state and waits for a new command. There should be only one Tag within the communications area of the Antenna.
SR	Single Repeat	The Controller waits for an approaching Tag, communicates with the Tag, and sends a response. After sending a response, the Controller is set to a standby state and waits for approaching Tags. The Controller repeats this process until it receives a STOP or RESET command. There should be only one Tag within the communications area of the Antenna.
FT	FIFO Trigger	Immediately after receiving a command, the Controller communicates with the Tag and sends a response. After completing communications, the Controller disables Tag operation and is set to a standby state and waits for a command after sending a response. There should be only one operable Tag within the communications area of the Antenna.
FA	FIFO Auto	After receiving a command, the Controller waits for an approaching Tag, communicates with the Tag, and sends a response. After completing communications, the Controller disables Tag operation and is set to a standby state awaiting approaching Tags after sending a response. There should be only one operable Tag within the communications area of the Antenna.
FR	FIFO Repeat	The Controller waits for an approaching Tag, communicates with the Tag, and sends a response. After completing communications, the Controller disables Tag operation and is set to a standby state and waits for approaching Tags after sending a response. The Controller repeats this process until it receives a STOP or RESET command. There should be only one operable Tag within the communications area of the Antenna.
MT	Multi-trigger	Immediately after receiving a command, the Controller communicates with all the Tags within the communications area of the Antenna and sends a response. After completing communications, the Controller disables Tag operation. After sending a response, the Controller is set to a standby state and waits for a new command.
MR	Multi-repeat	The Controller waits for approaching Tags, communicates with all the Tags within the communications area of the Antenna, and sends a response. After completing communications, the Controller is set to a standby state and waits for approaching Tags. The Controller repeats this processing until it receives a STOP or RESET command.
L□ (□: *, 0 to F)	Selective access	The Controller communicates with specified Tags only from among multiple Tags in the communications area.

**Note** Set the Controller to normal mode if the single repeat, FIFO trigger, FIFO auto, FIFO repeat, or multi-repeat options are used. A command error will occur if the energy-saving mode is used in these cases. Set the Controller to energy-saving mode, however, when the selective access mode is used.

## 5-7 Data Code Designation

Specify in the command whether read or write data is handled as ASCII text data or handled as hexadecimal numeric data.

### 5-7-1 ASCII Code Designation: A

A byte of ID Tag data is sent directly as ASCII code or as JIS8 code. A single character sent corresponds to one byte of data in the ID Tag. Character data can be written or read directly. Do not use the CR control code with data that is sent. A command error will occur if CR is specified for write data.

**Writing Example**

If “OMRON” is written to the five bytes beginning with address 10h in the memory, the addresses will be occupied with the following data.

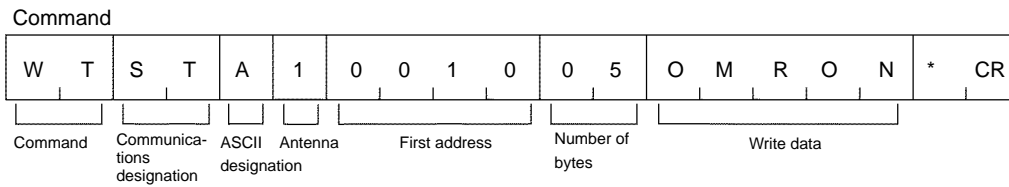

**Reading Example**

When the five bytes of data beginning with address 10h in the memory is read, the word “OMRON” will appear as shown in Fig. 1.

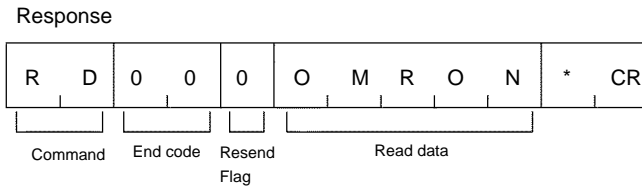

Address	ID Tag Memory		
10h	4	F	“O”
11h	4	D	“M”
12h	5	2	“R”
13h	4	F	“O”
14h	4	E	“N”

Fig. 1

**5-7-2 HEX Code Designation: H**

A single byte of data in the ID Tag is converted to two hexadecimal characters (00 to FF) and sent. Each two characters that are sent correspond to a single byte of data in the ID Tag. Write data must be set in units of two characters (even-numbered) from 00 to FF. A command error will occur if an odd number is set.

**Writing Example**

If “1234” is written to the two bytes beginning with address 20h, the data will be written to the ID Tag memory as shown in Fig. 2.

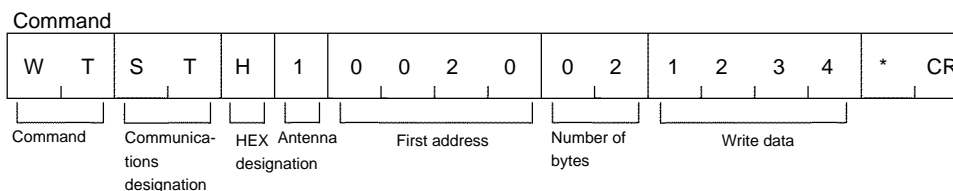

Address	ID Tag Memory	
20h	1	2
21h	3	4

Fig. 2

**Reading Example**

When the two bytes of data beginning with address 20h in the memory is read, the number “1234” will appear as shown in Fig. 2.

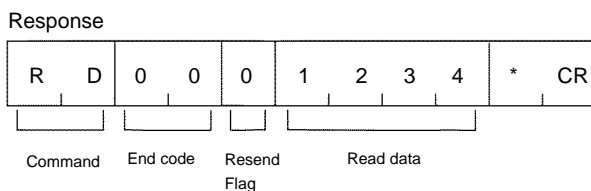

**5-7-3 Designation Range of First Address and Bytes**

The following table provides information on commands that designates the first address and number of bytes along with the designation range of the first address and bytes. A command error will result if a value not within the range is specified.

Command code	Designation range of first address	Designation range of bytes	
		ASCII code	HEX code
READ	00h to EFh	ASCII code	01h to F0h
		HEX code	01h to 80h
WRITE	00h to EFh	ASCII code	01h to F0h
		HEX code	01h to 80h
ADD	00h to EFh	01h to 08h	
SUBTRACT	00h to EFh	01h to 08h	
POLLING AUTO	00h to EFh	ASCII code	01h to F0h
		HEX code	01h to 80h
POLLING AUTOWRITE	00h to EFh	ASCII code	01h to F0h
		HEX code	01h to 80h
MEMORY CHECK	□0h to □5h or □8h to □Dh, provided that □ is between 0 and E.	03h to F0h	
MEMORY CALCULATION	□0h to □5h or □8h to □Dh, provided that □ is between 0 and E.	03h to F0h	

**Note** Addresses and bytes can be specified within the above ranges. If a range exceeding the memory capacity of the ID Tag is designated, an address error or command error will result. Be sure to check the memory capacity of the ID Tag before use.

### 5-7-4 Example of BCC Calculation

BCC is the result of the horizontal parity calculation of the data right after STX up to ETX inclusive. For details, refer to JIS5001 *Transmission Path Character Configuration and Using Horizontal Parity*.

Node number	Command code		Text						BCC				
STX	0	0	R	D	S	T	A	0	0	1	0	ETX	63

Command data	ASCII code data	
0	0011	0000
0	0011	EOR
R	0101	EOR
D	0100	EOR
S	0101	EOR
T	0101	EOR
A	0100	EOR
0	0011	EOR
0	0011	EOR
1	0011	EOR
0	0011	EOR
ETX	0000	0011
Calculation result	0101	0010



## 5-8 Explanation of Commands and Responses

The transmission of a command from the host to the Controller or the transmission of a response from the Controller to the host varies with the type of command and the difference in communications designation.

### No Response

When the Controller receives the RESET command, the Controller is reset without returning a response and waits for the next command.

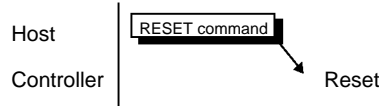

### One to One

If the single trigger, single auto, FIFO trigger, or FIFO auto option is specified for communications with the ID Tag or a command not for communications with the ID Tag is specified, a single response will be returned for a single command.

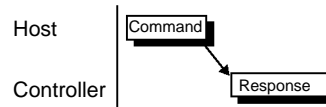

### Multiple Responses

If the single repeat, FIFO repeat, multi-trigger, or multi-repeat option is specified for communications with the ID Tag, multiple responses will be returned for a single command.



## 5-9 ACK/NACK Control

After the Controller receives a command from the host and returns a response, if the host cannot receive the response normally, the host must send the same command to the Controller again for execution. This is possible only if the ID Tag is at a standstill in the communications area of the Antenna or moving slow enough so that the ID Tag can receive the command within the communications area. The system in ACK/NACK control can receive the response without sending the command to the ID Tag.

### Use of ACK/NACK Control

The Controller returns a response for a command sent from the host and the host sends ACK when the response to the command is received. Then the Controller determines that the host has received the response normally and waits for the next command. If the Controller does not receive ACK within a preset timeout period or the Controller receives NACK, the Retry Flag is set and the response is returned to the Controller again. This is repeated at least nine times.

#### The host receives a response normally and sends ACK.

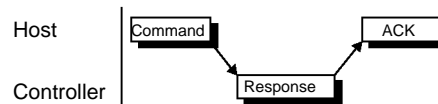

#### The host sends NACK because a response is not received normally.

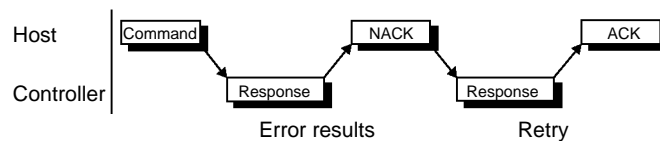

The host does not send ACK/NACK within a preset time-out period.

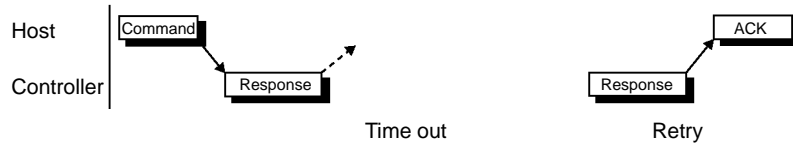

## 5-10 Communications Commands

### 5-10-1 READ: RD

Reads data from a Tag.

#### Command Frame Structure

STX	Node No.	Command code RD	Commu- nications	Data type	Chan- nel	First read address	No. of read bytes	ETX	BCC
1	2	2	2	1	1	2	2	1	1

Communications	Specify the communications method with the Tag. ST: Single trigger SA: Single auto SR: Single repeat FT: FIFO trigger FA: FIFO auto FR: FIFO repeat MT: Multi-trigger MR: Multi-repeat
Data type	Specify whether the data read from the Tag is ASCII or Hex. A: ASCII code H: HEX code
Channel	Always 1.
First read address	Specify in Hex the first address from which data is to be read from the Tag. Setting range: 00h to EFh
No. of read bytes	Specify in Hex the number of bytes to be read from the Tag. Setting range: 01h to F0h (reading ASCII data) 01h to 80h (reading Hex data)

#### Response Frame Structure

STX	Node No.	Retry Flag	Command code RD	Response code 00	Read data	ETX	BCC
1	2	1	2	2	Specified quantity	1	1

Response code	00: Normal end Refer to 5-16 List of Response Codes for other response codes.
Read data	Data read from the ID Tag, which consists of the following characters. ASCII code: Number of bytes to be read HEX code: Number of bytes to be read x 2

**Note** Make sure that the specified data is within the memory capacity of the ID Tag.

### 5-10-2 WRITE: WT

Writes data to a Tag.

#### Command Frame Structure

STX	Node No.	Command code WT	Commu- nications	Data type	Chan- nel	First write address	No. of write bytes	Write data	ETX	BCC
1	2	2	2	1	1	2	2	Specified quantity	1	1

Communications	Specify the communications method with the Tag. ST: Single trigger SA: Single auto SR: Single repeat FT: FIFO trigger FA: FIFO auto FR: FIFO repeat MT: Multi-trigger MR: Multi-repeat
Data type	Specify whether the data written to the Tag is ASCII or Hex. A: ASCII code H: HEX code
Channel	Always 1.
First write address	Specify in Hex the first address to which data is to be written to the Tag. Setting range: 00h to EFh
No. of write bytes	Specify in Hex the number of bytes to be written to the Tag. Setting range: 01h to F0h (writing ASCII data) 01h to 80h (writing Hex data)
Write data	Data written to the ID Tag, which consists of the following characters. ASCII code: Number of bytes to be written HEX code: Number of bytes to be written x 2

#### Response Frame Structure

STX	Node No.	Retry Flag	Command code WT	Response code 00	ETX	BCC
1	2	1	2	2	1	1

Response code	00: Normal end Refer to 5-16 List of Response Codes for other response codes.
---------------	--

**Note** Make sure that the specified data is within the memory capacity of the ID Tag.

### 5-10-3 ADD: AD

The data in the memory of the ID Tag is treated as hexadecimal data, to which AD data is added.

#### Command Frame Structure

STX	Node No.	Command code AD	Commu- nications	Chan- nel	First address of add area	No. of bytes in add area	Add data	ETX	BCC
1	2	2	2	1	2	2	Specified quantity	1	1

Communications	Specify the communications method with the Tag. ST: Single trigger SA: Single auto SR: Single repeat FT: FIFO trigger FA: FIFO auto FR: FIFO repeat MT: Multi-trigger MR: Multi-repeat
Channel	Always 1.
First address of add area	The first address of data to be added in hexadecimal. Setting range: 00h to EFh
No. of bytes in add area	The number of data bytes to be added in hexadecimal. Setting range: 01h to 08h
Add data	Data to be added to the ID Tag. The number of AD data characters is twice as large as the number of AD area bytes.

#### Response Frame Structure

STX	Node No.	Retry Flag	Command code AD	Response code 75	Results data	ETX	BCC
1	2	1	2	2	Specified quantity	1	1

Response code	75: Normal response with no overflow. 76: Normal response with overflow. Refer to 5-16 List of Response Codes for other response codes.
Results data	The result of the addition of data is sent. If overflow results, the previous data is sent.

- Note**
1. Make sure that the AD area is within a single page, otherwise a command error will result.
  2. Make sure that the specified data is within the memory capacity of the ID Tag.

### 5-10-4 SUBTRACT: SB

The data in the memory of the ID Tag is treated as hexadecimal data, to which SB data is subtracted.

#### Command Frame Structure

STX	Node No.	Command code SB	Commu- nications	Chan- nel	First address of subtract area	No. of bytes in subtract area	Subtract data	ETX	BCC
1	2	2	2	1	2	2	Specified quantity	1	1

Communications	Specify the communications method with the Tag. ST: Single trigger SA: Single auto SR: Single repeat FT: FIFO trigger FA: FIFO auto FR: FIFO repeat MT: Multi-trigger MR: Multi-repeat
Channel	Always 1.
First address of subtract area	The first address of data to be subtracted in hexadecimal. Setting range: 00h to EFh
No. of bytes in subtract area	The number of data bytes to be subtracted in hexadecimal. Setting range: 01h to 08h
Subtract data	Data to be added to the ID Tag. The number of SB data characters is twice as large as the number of SB area bytes.

#### Response Frame Structure

STX	Node No.	Retry Flag	Command code SB	Response code 75	Results data	ETX	BCC
1	2	1	2	2	Specified quantity	1	1

Response code	75: Normal response with a result not below 0. 76: Normal response with a result below 0. Refer to 5-16 List of Response Codes for other response codes.
Results data	The result of the subtraction of data is sent. If the result is below 0, the previous data is sent.

- Note**
1. Make sure that the SB area is within a single page, otherwise a command error will result.
  2. Make sure that the specified data is within the memory capacity of the ID Tag.

### 5-10-5 POLLING AUTOREAD: PR

When the host sends POLLING AUTOREAD command to the Controller, the Controller immediately returns a response to the host indicating the acceptance of the command. Then the Controller waits for the approaching ID Tag and reads the data of the ID Tag when the ID Tag is in the communications area of the Antenna. When the Tag is in the communications area, the host can use a POLLING subcommand to check the results of the processing of the command.

#### Command Frame Structure

STX	Node No.	Command code PR	Data type	Channel	First read address	No. of read bytes	ETX	BCC
1	2	2	1	1	2	2	1	1

Data type	Specify whether the data read from the Tag is ASCII or Hex. A: ASCII code H: HEX code
Channel	Always 1.
First read address	Specify in Hex the first address of the data to be read from the Tag. Setting range: 00h to EFh
No. of read bytes	Specify in Hex the number of bytes of data to be read from the Tag. Setting range: 01h to F0h (reading ASCII data) 01h to 80h (reading Hex data)

#### Response Frame Structure

STX	Node No.	Retry Flag	Command code PR	Response code 74	ETX	BCC
1	2	1	2	2	1	1

Response code	74: Command received. Refer to 5-16 List of Response Codes for other response codes.
---------------	---

**Note** Make sure that the specified data is within the memory capacity of the ID Tag.

### 5-10-6 POLLING AUTOWRITE: PW

When the host sends POLLING AUTOWRITE command to the Controller, the Controller immediately returns a response to the host indicating the acceptance of the command. Then the Controller waits for the approaching ID Tag and writes data to the ID Tag. When the Tag is in the communications area, the host can use a POLLING subcommand to check the results of the processing of the command.

#### Command Frame Structure

STX	Node No.	Command code PW	Data type	Chan- nel	First write address	No. of write bytes	Write data	ETX	BCC
1	2	2	1	1	2	2	Specified quantity	1	1

Data type	Specify whether the data written to the Tag is ASCII or Hex. A: ASCII code H: HEX code
Channel	Always 1.
First write address	Specify in Hex the first address to which data is to be written to the Tag. Setting range: 00h to EFh
No. of write bytes	Specify in Hex the number of bytes to be written to the Tag. Setting range: 01h to F0h (writing ASCII) 01h to 80h (writing Hex)
Write data	Data written to the ID Tag, which consists of the following characters. ASCII code: Number of bytes to be written HEX code: Number of bytes to be written x 2

#### Response Frame Structure

STX	Node No.	Retry Flag	Command code PW	Response code 74	ETX	BCC
1	2	1	2	2	1	1

Response code	74: Command received. Refer to 5-16 List of Response Codes for other response codes.
---------------	---

**Note** Make sure that the specified data is within the memory capacity of the ID Tag.

### 5-10-7 MEMORY CHECK: MC

This command uses the generating polynomial  $X^{16} + X^{12} + X^5 + 1$  to calculate the check block designated by the user and to compare the results with the check code attached to the check block.

#### Command Frame Structure

STX	Node No.	Command code MC	Chan- nel	First address of check block	No. of bytes in check block	ETX	BCC
1	2	2	1	2	2	1	1

Channel	Always 1.
First address of check block	Specify in Hex the first address of the check block. Setting range: <input type="checkbox"/> 0h to <input type="checkbox"/> 5h or <input type="checkbox"/> 8h to <input type="checkbox"/> Dh, provided that <input type="checkbox"/> is between 0 and E.
No. of bytes in check block	Specify in Hex the number of bytes in the check block. Setting range: 03h to F0h

**Response Frame Structure**

STX	Node No.	Retry Flag	Command code MC	Response code 75	ETX	BCC
1	2	1	2	2	1	1

Response code	75: The comparison results are correct. 76: The comparison results are not correct. Refer to 5-16 List of Response Codes for other response codes.
---------------	--

**Note** Make sure that the specified data is within the memory capacity of the ID Tag.

**5-10-8 MEMORY CALCULATE: MK**

This command uses the generating polynomial  $X^{16} + X^{12} + X^5 + 1$  to calculate the check block designated by the user and to write the check code to the last three bytes of the check block.

**Command Frame Structure**

STX	Node No.	Command code MK	Channel	First address of check block	No. of bytes in check block	ETX	BCC
1	2	2	1	2	2	1	1

Channel	Always 1.
First address of check block	Specify in Hex the first address of the check block. Setting range: □0h to □5h or □8h to □Dh, provided that □ is between 0 and E.
No. of bytes in check block	Specify in Hex the number of bytes in the check block. Setting range: 03h to F0h

**Response Frame Structure**

STX	Node No.	Retry Flag	Command code MK	Response code 00	ETX	BCC
1	2	1	2	2	1	1

Response code	00: Normal end Refer to 5-16 List of Response Codes for other response codes.
---------------	--

- Note**
1. Do not specify both “set” and “clear” for the same page. When both “set” and “clear” are specified for the same page, the “set” will be executed.
  2. Do not set “1” for “Fixed to 0.” Setting “1” will result in a command error.
  3. Make sure that the specified data is within the memory capacity of the ID Tag.

**Memory Check Function**

By executing the MEMORY CHECK and MEMORY CALCULATE commands, it is possible to check for the accidental overwriting or destruction of memory. The CRC (cyclic redundancy check) code is written or checked with the check block specified by the user. The CRC code is calculated by the generating polynomial  $X^{16} + X^{12} + X^5 + 1$ .

- The calculation area is the portion of the check block specified by the first address and the number of bytes excluding the last two bytes. The check code area is the last two-byte portion. If a command to write a check code is sent, the CRC code of the data in the calculation area is calculated and compared with the data in the check code area. If they coincide, response code 75, which indicate normal data transmission, is returned, otherwise response code 76 is returned as a warning.



- Example of Command Execution  
In the following example, the data in address 10h to 12h is checked.

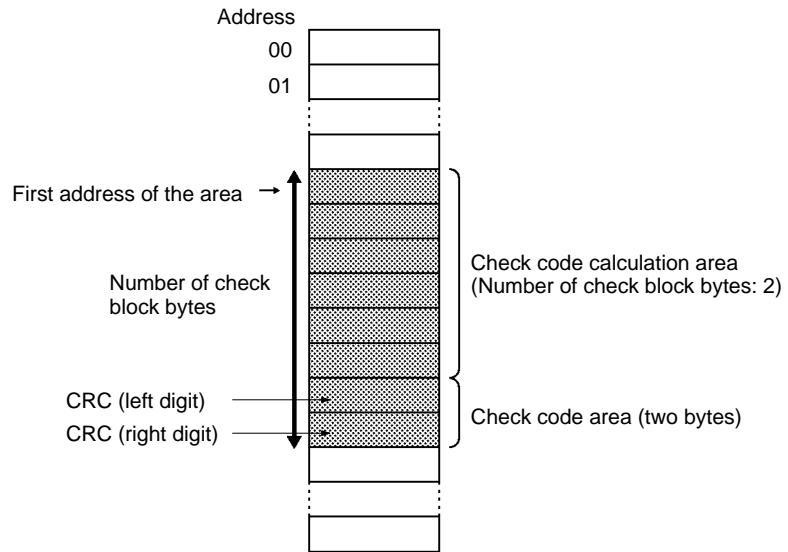

- 1, 2, 3...** 1. In this example, the following data already exists in the memory of the ID Tag.

10h	12h
11h	34h
12h	56h
13h	
14h	

2. Execute MK11005 (the MEMORY CALCULATION command). The CRC code 5CD6 calculated from the data 123456 is written to addresses 13h and 14h.

10h	12h
11h	34h
12h	56h
13h	5Ch
14h	D6h

3. Execute MC11005 (the MEMORY CHECK command). The normal response MC75 will be returned if the data coincides.

10h	12h
11h	34h
12h	56h
13h	5Ch
14h	D6h

4. If the data does not coincide, MC76 (a data error warning) will be returned.

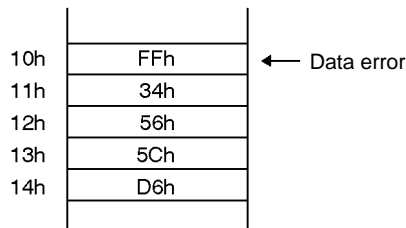

### 5-10-9 WRITE PROTECT: WP

Sets and releases write protection by page.

#### Command Frame Structure

STX	Node No.	Command code WP	Channel	Protection setting information	Protection release information	ETX	BCC
1	2	2	1	8	8	1	1

Channel	Always 1.
Protection setting information	Set the corresponding bits in the following diagram to 1 to write-protect pages.
Protection release information	Set the corresponding bits in the following diagram to 1 to release write protection of pages.

#### Response Frame Structure

STX	Node No.	Retry Flag	Command code WP	Response code	Protection information	ETX	BCC
1	2	1	2	2	8	1	1

Protection information	Write-protect data set in the ID Tag is sent.
------------------------	---

### Protect Data

The protect data item on each page is expressed by single-bit data. Protect data items are arranged in decreasing numerical order beginning with those on page 30. There are protect data items on two zero-fixed pages after the protect data item on page 1.

Three 32-bit data items are considered to be binary data, the hexadecimal conversion of which is used as protect data.

The V700-D23P□□, however, uses the data items on page 1 through 14 only. The data on any other page can be set or released, which has, however, nothing to do with the operation of the V700-D23P□□.

Protection information																					
b7	b6	b1		b0	b7	b6	b1		b0	b7	b6	b1		b0	b7	b6	b3		b2	b1	b0
Page 30	Page 29	Page 24	Page 23	Page 22	Page 21	Page 16	Page 15	Page 14	Page 13	Page 8	Page 7	Page 6	Page 5	Page 2	Page 1	0	0				

- Note**
1. Do not set the write protection and the release of write protection together on the same page. If write protection and the release of write protection are set on the same page, only the write protection setting will be enabled.
  2. Do not set 1 in either of the zero-fixed pages, otherwise an error will result.

**Example of Write Protection Setting and Releasing**

The following is an example of command execution and responses for setting write protection on pages 1 and 6 and releasing write protection on pages 5 and 8 of the ID Tag, provided that pages 2, 5, 8, and 13 the ID Tag are set to write protection.

- 1, 2, 3... 1. The following setting is required to set the write protection on pages 1 and 6.

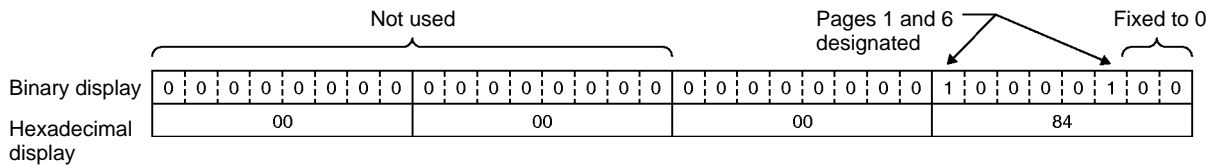

2. The following setting is required to release the write protection on pages 16 and 21.

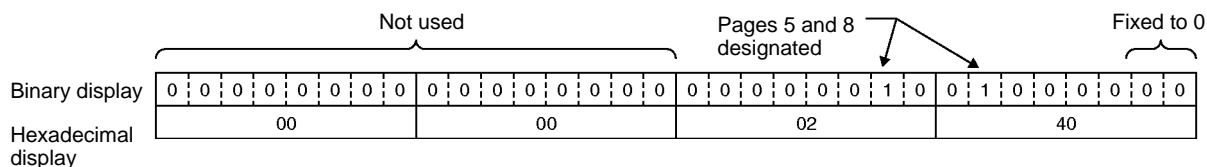

3. The following is the description of the command sent from the host. The data on STX, ETX, BCC, and node number is left out in the following.

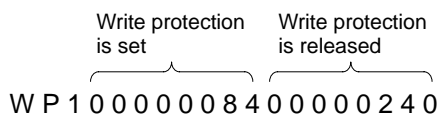

4. Pages 1, 2, 6, and 13 are write-protected. Therefore, the following response is returned. The data on STX, ETX, BCC, and node number is left out in the following.

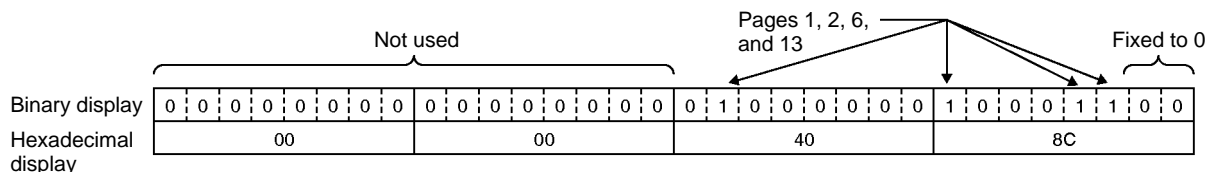
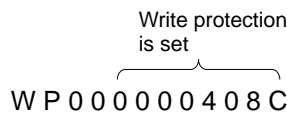

If it is necessary to check the write protect data only, send the following command without designating the data on setting or releasing write protection. The data on STX, ETX, BCC, and node number is left out in the following.

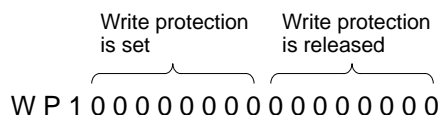

## 5-11 Communications Subcommands

### 5-11-1 POLLING CHECK: PC

This subcommand is used after sending the POLLING AUTO command to check the results of the execution of the POLLING command.

#### Command Frame Structure

STX	Node No.	Command code PC	Chan- nel	ETX	BCC
1	2	2	1	1	1

Channel	Always 1.
---------	-----------

#### Response Frame Structure

The following frame structures are used for the response when the POLLING AUTO command is executed after the completion of communications with ID Tag and before the completion of communications with the ID Tag.

#### 1, 2, 3... 1. POLLING AUTO

STX	Node No.	Retry Flag	Command code PR	Response code 00	Read data	ETX	BCC
1	2	1	2	2	Specified quantity	1	1

#### 2. POLLING AUTOWRITE

STX	Node No.	Retry Flag	Command code PW	Response code 00	ETX	BCC
1	2	1	2	2	1	1

#### 3. Before Completion of Communications with ID Tag

STX	Node No.	Retry Flag	Command code PC	Response code 74	ETX	BCC
1	2	1	2	2	1	1

Response code	00: Normal end 74: Before completion of communications with ID Tag Refer to 5-16 List of Response Codes for other response codes.
Read data	Data read from the ID Tag, which consists of the following characters. ASCII code: Number of bytes to be read HEX code: Number of bytes to be read x 2

### 5-11-2 POLLING END: PE

This subcommand is used after sending the POLLING AUTO command to cancel the execution of the POLLING AUTO command.

#### Command Frame Structure

STX	Node No.	Command code PE	Chan- nel	ETX	BCC
1	2	2	1	1	1

Channel	Always 1.
---------	-----------

**Response Frame Structure**

The following frame structures are used for the response after completing communications with the ID Tag and before completing communications with the ID Tag.

**1, 2, 3...** 1. Before Completion of Communications with Tag

STX	Node No.	Retry Flag	Command code PE	Response code 75	ETX	BCC
1	2	1	2	2	1	1

## 2. After Completion of Communications with Tag

STX	Node No.	Retry Flag	Command code PE	Response code 76	ETX	BCC
1	2	1	2	2	1	1

Response code	75: Before completion of communications with ID Tag 76: After completion of communications with ID Tag Refer to 5-16 List of Response Codes for other response codes.
---------------	---

## 5-12 Control Commands

### 5-12-1 STOP: ST

This command causes the Controller in automatic mode or repeat mode to cancel the processing of communications when this command is received by the Controller. The Controller then waits for the next command.

**Command Frame Structure**

STX	Node No.	Command code ST	Channel	ETX	BCC
1	2	2	1	1	1

Channel	Always 1.
---------	-----------

**Response Frame Structure**

STX	Node No.	Command code ST	Response code	Retry Flag	ETX	BCC
1	2	2	2	1	1	1

Response code	00: Normal end Refer to 5-16 List of Response Codes for other response codes.
---------------	--

### 5-12-2 RESET: XZ

This command resets the Controller in operation. There is no response returned for this command. The Controller then waits for the next command.

**Command Frame Structure**

STX	Node No.	Command code XZ	ETX	BCC
1	2	2	1	1

**Precautions**

It only takes slightly more than a second for the Controller to await the next command after the Controller is reset. Therefore, after executing the above command, wait for approximately two seconds to issue the next command.

## 5-13 Host Command

### 5-13-1 TEST: TS

This command returns test messages sent from the host without changing anything. The test command is used for communications tests between the host and Controller.

#### Command Frame Structure

STX	Node No.	Command code TS	Test message	ETX	BCC
1	2	2		1	1

Test message	The number of characters within a range between 0 and 256 can be used.
--------------	--

#### Response Frame Structure

STX	Node No.	Command code TS	Response code	Test message	Retry Flag	ETX	BCC
1	2	2	2		1	1	1

Response code	00: Normal end Refer to 5-16 List of Response Codes for other response codes.
Test message	Returns the test message sent with the command.

## 5-14 Host Subcommands

### 5-14-1 ACK: AK

The host sends ACK to the Controller when a response from the Controller is normally received by the host. There is no response for ACK/NACK control. A command error will result if the Controller receives this command while the Controller is not awaiting ACK/NACK command.

#### Command Frame Structure

STX	Node No.	Command code AK	ETX	BCC
1	2	2	1	1

### 5-14-2 NACK: NK

The host sends NACK to the Controller when a response from the Controller is not normally received by the host. When the Controller receives NACK, it will return the previous response again. The Controller will try to return it nine times. A command error will result if the Controller receives this command while the Controller is not awaiting ACK/NACK command.

#### Command Frame Structure

STX	Node No.	Command code NK	ETX	BCC
1	2	2	1	1

## 5-15 Other Command

### 5-15-1 Undefined Command Response

If the Controller receives an undefined command, the Controller will return a response for the undefined command to the host.

#### Response Frame Structure

STX	Node No.	Command code IC	ETX	BCC
1	2	2	1	1

## 5-16 Response Codes

The response codes are described in the following table.

Type	Response code	Name	Meaning
Normal end	00	Normal end	No error occurred and the command ended normally.
Host communications error	10	Parity error	A parity error occurred for one of the characters in the command.
	11	Framing error	A framing error occurred for one of the characters in the command.
	12	Overrun error	An overrun error occurred for one of the characters in the command.
	13	BCC error	A received command had an incorrect BCC.
	14	Command error	The command frame structure normally received is incorrect.
	18	Frame length error	ETX was not received in 288 characters or less after STX was received.
Communications error	70	Communications error	An error occurred during communications with a Tag and communications were not completed normally.
	71	Write process error	A write process error occurred during a write.
	72	No Tag error	There was no Tag in front of the Antenna when the command was executed.
	7A	Address error	The address specification is not correct.
	7B	Not write area error	The Tag is in a read-only area.
	7C	No Antenna connected error	No Antenna is connected.
	7D	Protection error	An attempt was made to write to a write-protected area.
	7E	ID system error	An ID system error 1 has occurred.
	7F		
Normal end	74	Polling command received	The POLLING AUTO or POLLING AUTOWRITE command has been received.
	75	Polling process canceled	The polling process was canceled before the completion of communications with the ID Tag.
		Data normal	Data was normal when an MC, MK, AD, or SB command was executed.
	76	Polling process canceled	The polling process was canceled after the start of communications with the ID Tag.
		Data error	Data was not normal when an MC, MK, AD, or SB command was executed.
System error	9A	Sync error	The multiple Controllers used were not synchronized for mutual interference prevention at the time of acceptance of the command.

## 5-17 Connecting Commands

The Controller can use a connecting command function to send only one command to the ID Tag to read and write data from and to the ID Tag.

### Available Commands

Any pair of the following nine commands can be used.

- READ: RD
- WRITE: WT
- ADD: AD
- SUBTRACT: SB
- POLLING AUTOREAD: PR
- POLLING AUTOWRITE: PW
- MEMORY CHECK: MC
- MEMORY CALCULATION: MK
- WRITE PROTECT: WP

### Command and Response Frame Structure

The following frame structure is used when commands are connected with "+". The STX node number, BCC, and ETX are required only once each.

#### Command Frame Structure



#### Response Frame Structure

1, 2, 3... 1. Normal End

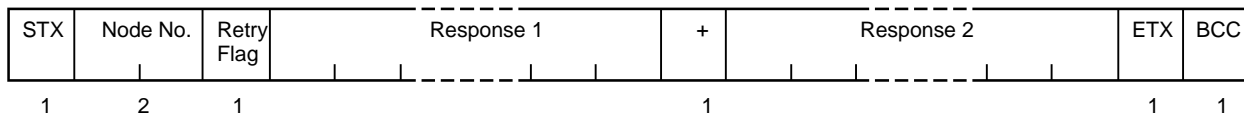

2. Error Resulted

The command code and response code of command 1 are sent.

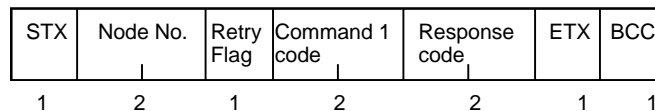

### Communications Specifications

When commands are connected, the communications option specified with command 1 takes precedence. The POLLING AUTOREAD and POLLING AUTOWRITE commands use the single auto option. The MEMORY CHECK, MEMORY CALCULATION, and WRITE PROTECT commands use the single trigger option.

### First Address and Number of Processed Bytes

The memory area of the ID Tag specified by command 1 and that specified by command 2 for data processing must not overlap except for the following cases.

- Connection of READ (RD and PR) commands to WRITE (WT and PW) commands.
- Connection of MEMORY CHECK command to READ, WRITE, WRITE PROTECT, and MEMORY CALCULATION commands.



- Connection of MK command to WT, AD, and SB commands, provided that the write area of each of them is different.

### POLLING Process

In case command 1 is POLLING AUTOREAD or POLLING AUTOWRITE command is specified in command 1, the Controller will perform polling processing.

## 5-18 Communications Programming Example

### BASIC Programming Example

The following is an example of a program for operating the V700-CD1D-V3.

```

10  '***** V700-CD1D SAMPLE PROGRAM *****
20  CLS
30  OPEN "COM:E73NN" AS #1
40  RECV$="":SREC=0
50  *LOOP
60  LINE INPUT "Input TX Data : ",ITD$           Command input
70  IP$=ITD$+CHR$(&H3)
80  SOSUB *BCC                                   BCC calculation
90  PRINT "[TX] : ";ITD$
100 PRINT #1,CHR$(&H2)+ITD$+CHR$(&H3)+OP$       Add STX, ETX, and BCC to
                                                the input data and send.
110 FOR N=0 TO 300                               Repeated until there is no
                                                more receive data.
120 IF LOC(#1)=0 THEN GOTO *NFOR
130   TMP$=INPUT$(1,#1)
140   IF SREC=0 AND TMP$<>CHR$(&H2) THEN GOTO *REC Discard data in status of
                                                not receiving STX.
150   IF SREC=0 AND TMP$=CHR$(&H2) THEN SREC=1:RECV$="":GOTO *NFOR Detecting STX reception
160   IF SREC=1 AND TMP$=CHR$(&H2) THEN SREC=1:RECV$="":GOTO *NFOR Receiving STX again
170   IF SREC=1 AND TMP$=CHR$(&H3) THEN SREC=2:RECV$=RECV$+TMP$:GOTO *NFOR Receiving ETX
180   IF SREC=1 AND TMP$<>CHR$(&H2) AND TMP$<>CHR$(&H3) THEN RECV$=RECV$+TMP$:GOTO *NFOR Receiving data
190   IF SREC=2 THEN RECV$=RECV$+TMP$:N=300:GOSUB *DISP:SREC=0:GOTO *NFOR Receiving BCC, checking
                                                BCC, and displaying the
                                                response
200   *NFOR
210 NEXT N
220 GOTO *LOOP
230 '***** DISPLAY RECEIVE DATA *****
240 *DISP
250 IP$=LEFT$(RECV$,LEN(RECV$)-1)
260 GOSUB *BCC                                   BCC calculation
270 IF OP$=RIGHT$(RECV$,1) THEN PRINT "[RX] : ";LEFT$(RECV$,LEN(RECV$)-2) BCC normal, response
                                                display
280 IF OP$<>RIGHT$(RECV$,1) THEN PRINT "[RX] : BCC ERROR : ";LEFT$(RECV$,LEN(RECV$)-2) BCC error, response display
290 BEEP
300 RETURN
310 '***** CALCULATE BCC *****               BCC calculation routine
320 *BCC
330 K=0
340 FOR III=1 TO LEN(IP$) STEP 1
350   AAA$=MID$(IP$,III,1)
360   JJJ=ASC(AAA$)
370   K=K XOR JJJ
380 NEXT III
390 OP$=CHR$(K)
400 RETURN
410 '
420 END

```



# SECTION 6

## Programming Console

This section provides the installation and use of the Programming Console in relation to the V700 System.

- 6-1 Introduction ..... 92
- 6-2 Nomenclature ..... 92
- 6-3 External Dimensions ..... 92
- 6-4 Connecting the Programming Console ..... 93
  - 6-4-1 Insertion of Keysheet ..... 93
  - 6-4-2 Programming Console Connection Cable ..... 93
- 6-5 Operation ..... 95
- 6-6 Functions ..... 96
  - 6-6-1 Functions of the Programming Console ..... 97
  - 6-6-2 Operation Procedure ..... 98
  - 6-6-3 Set Data Display ..... 100
  - 6-6-4 Address Setting ..... 101
  - 6-6-5 Data Setting ..... 102
  - 6-6-6 Write and Read Data ..... 102
  - 6-6-7 Test ..... 104
  - 6-6-8 Ambient Noise Check ..... 105
  - 6-6-9 Reading Latest Error Log ..... 106
  - 6-6-10 Statistical Error Log ..... 107
  - 6-6-11 RUN Monitor ..... 107

### 6-1 Introduction

OMRON's C200H-PRO27-E Programming Console connects to the V700-CD1D Controller through the V700-P10 Programming Console Conversion Cable, thus making it possible to test the communications between the Controller and ID Tags when starting up the system. Furthermore, the Programming Console makes it possible to check the ambient noise of a location where the Antenna is located, the read and write data of ID Tags, and the settings and error logs in the Controller. The C200H-PRO27-E Programming Console and V700-P10 Programming Console Conversion Cable are sold separately.

### 6-2 Nomenclature

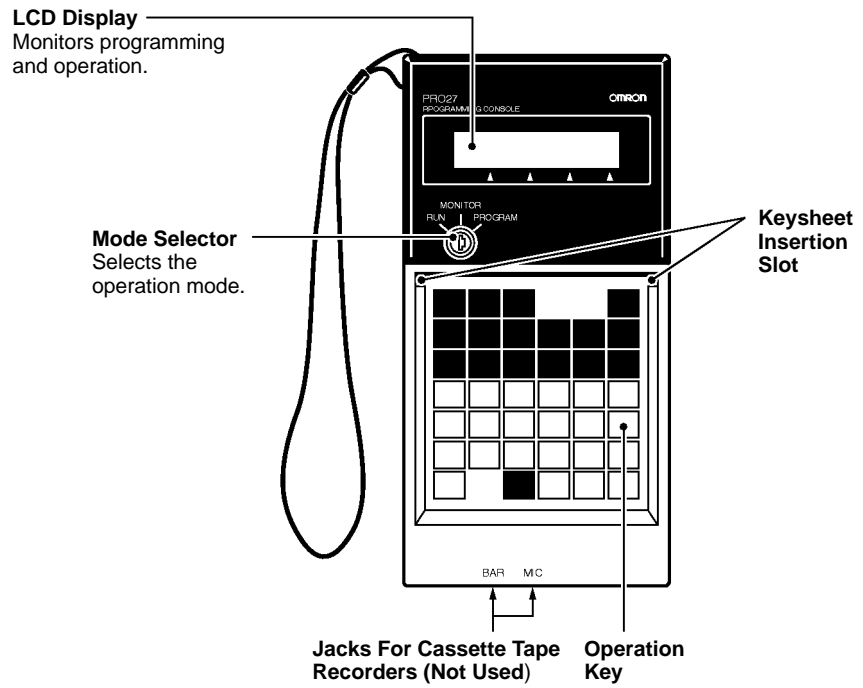

### 6-3 External Dimensions

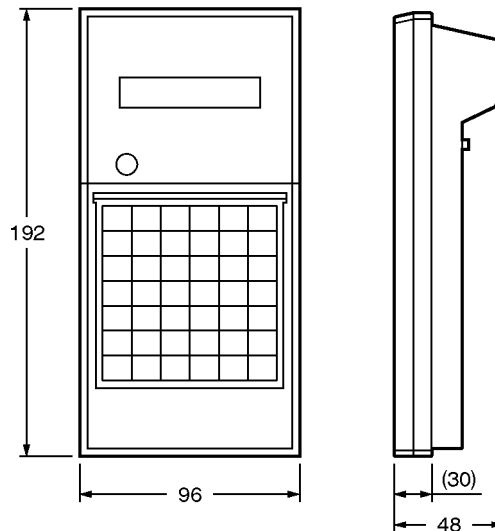

## 6-4 Connecting the Programming Console

The Programming Console can be connected to the Controller through the V700-P10 Programming Console Conversion Cable (sold separately). The V700-P10 is provided with a keysheet.

### 6-4-1 Insertion of Keysheet

As shown in the following illustration, insert the provided keysheet into the insertion slot. Then slide the keysheet downwards by pressing the keysheet with both thumbs. Continue sliding the keysheet until the small holes on the lower part of the keysheet are hidden by the bottom part of the slot of the Programming Console.

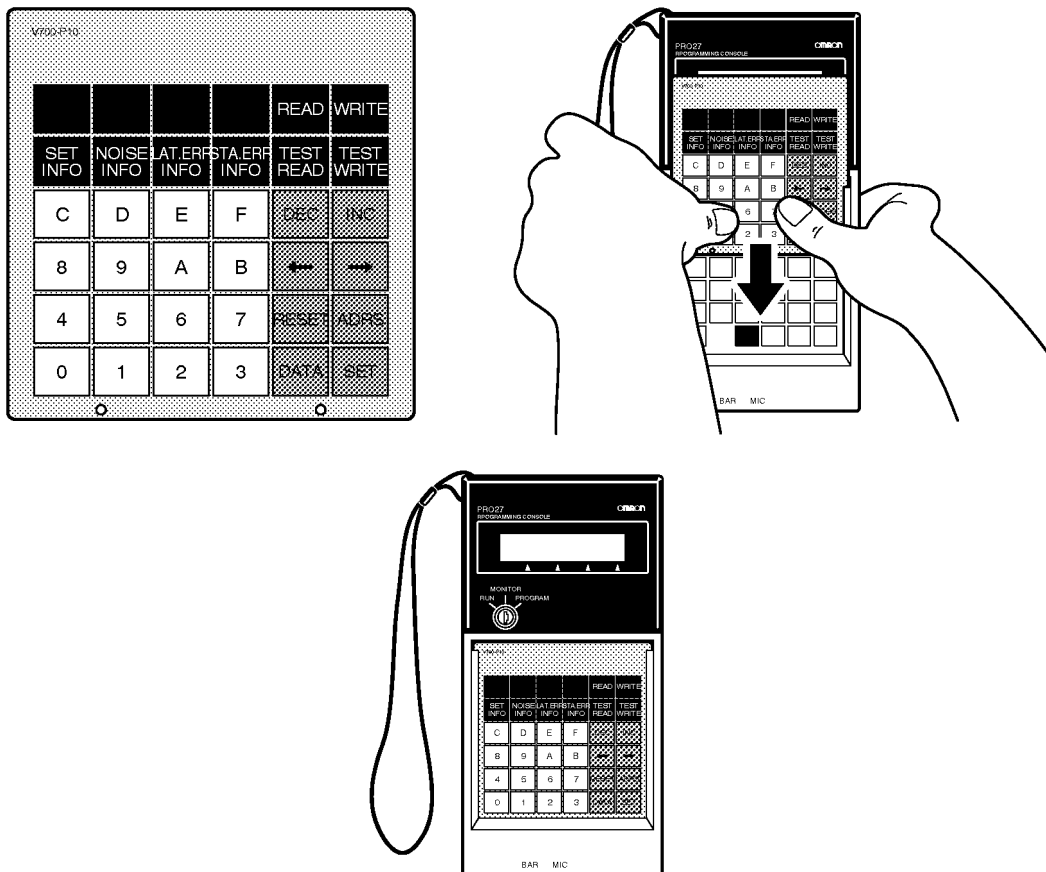

**Note** Be sure to insert the keysheet correctly, otherwise the keys of the Programming Console may not be pressed properly.

### 6-4-2 Programming Console Connection Cable

A square connector and a round connector are attached to the V700-P10 Programming Console Conversion Cable. The square connector connects to the Programming Console and the round connector connects to the Controller.

The connector can be connected or disconnected to or from the Programming Console regardless of whether power is being supplied to the Programming Console.

- 1, 2, 3... 1. Remove the rear-upper cover or rear connector cover of the Programming Console. Be careful not to misplace the removed cover.

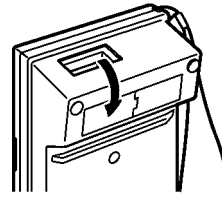

2. Connect the square connector to the Programming Console. Press in the square connector securely until the lock lever clicks.

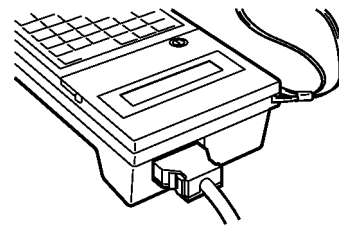

3. Open the front cover of the Controller.
4. There is an arrow mark on the round connector. Make sure that the arrow mark is faced upwards when connecting the round connector to the Programming Console port on the Controller. Press the round connector securely. This connector has no lock mechanism.

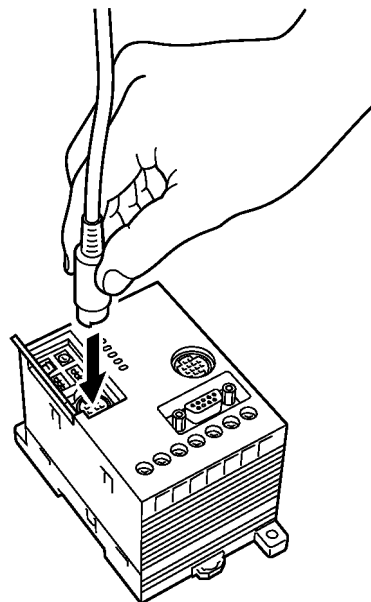

### CAUTION

Do not touch the wires connected to the Controller when connecting or disconnecting the connector while the Programming Console is ON, otherwise an electric shock may be received.

# 6-5 Operation

## Hand-held Operation

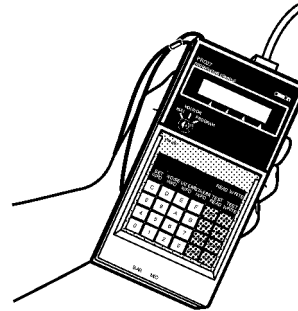

### Panel Mounting

Use the C200H-ATT01 (sold separately) for the panel mounting of the Programming Console.

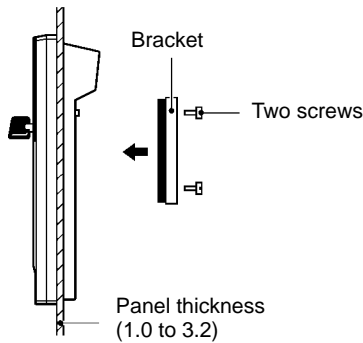

#### Mounting Dimensions

The following standard mounting dimensions conform to DIN43700.

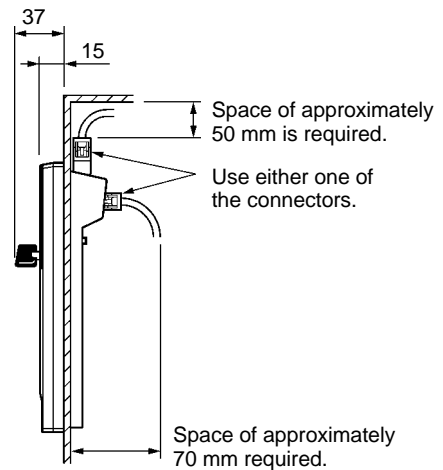
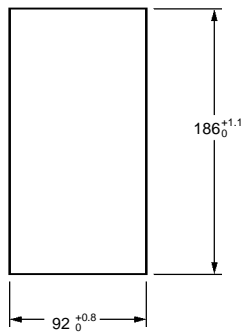

Consider the space required for the cable when mounting the Programming Console to the panel.

In the case of enclosed mounting, make sure that the ambient temperature is within a range between 0°C and 45°C.

- Note** 1. Do not attach a key ring to the mode selection key, otherwise it will be difficult to press the keys of the Programming Console.

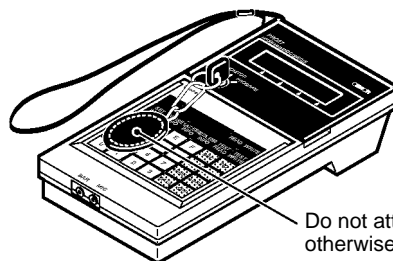

Do not attach a key ring to the mode selection key, otherwise it will be difficult to press the keys.

- The mode selection key can be pulled out in the RUN or MONITOR position but not in the PROGRAM position.

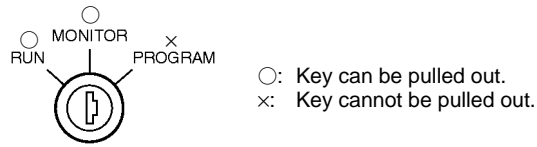

- The V700-series Controller does not operate in PROGRAM mode. Do not set the key to PROGRAM.
- The volume of the buzzer at the time of key input can be lowered by adjusting the lever on the side of the Programming Console upwards.

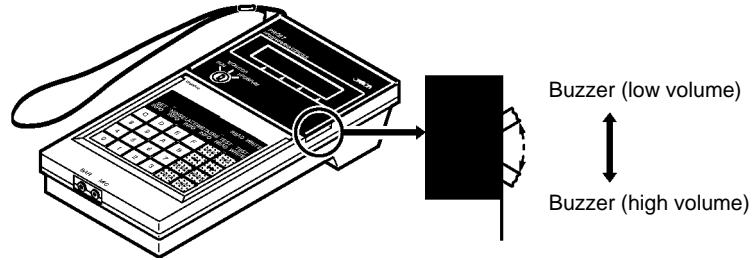

- When disconnecting the cable from the Programming Console, press the lever on each side of the connector and pull out the connector.

## 6-6 Functions

The Programming Console connects to the V700-CD1D Controller, thus making it possible to test the communications between the Controller and ID Tags when starting up the system. Furthermore, the Programming Console makes it possible to check the ambient noise of the Antenna location, the read and write data of ID Tags, and the settings and error logs in the Controller.



### 6-6-1 Functions of the Programming Console

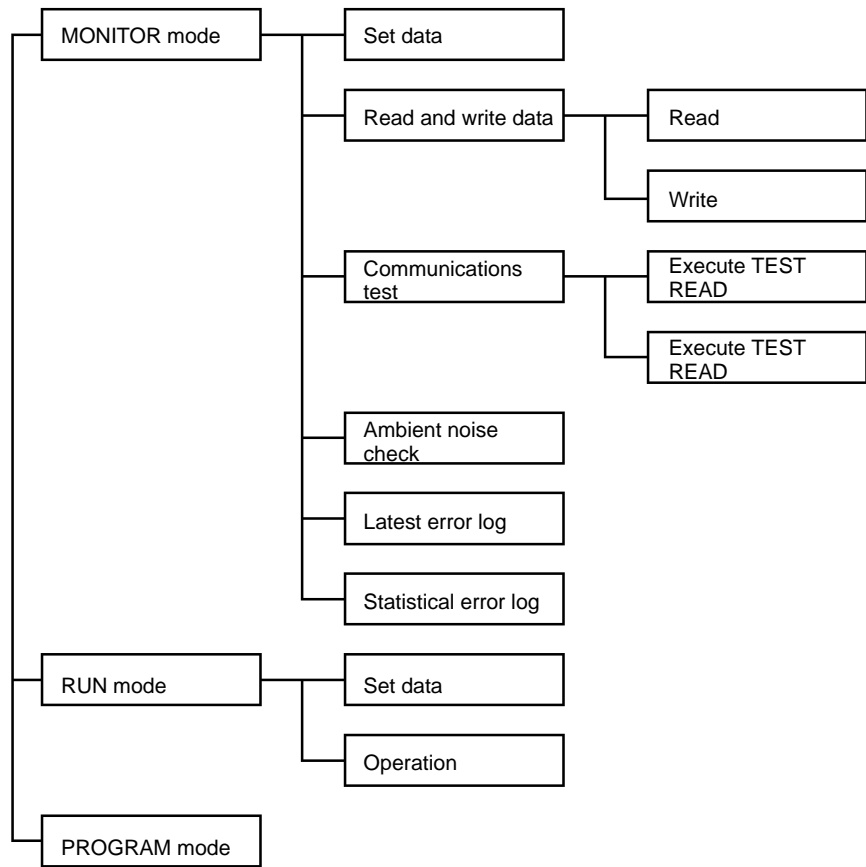

#### MONITOR Mode

- **Set Data Display**  
Displays data that is set with the DIP switch of the Controller.
- **Read and Write Data**  
Reads and writes data from and to ID Tags at a standstill in the communications area of the Antenna.
- **Communications Test**  
Tests communications with ID Tags moving in the communications area.
- **Ambient Noise Check**  
Checks the ambient noise of the Antenna location. The present, average, minimum, and maximum values of noise are displayed along with the elapsed time.
- **Latest Error Log**  
Displays up to 30 errors in descending order starting from the most recent one.
- **Statistical Error Log**  
Classifies all errors recorded after the Controller starts operating according to the response code and displays the number of each type of errors.

#### RUN Mode

- **Set Data Display**  
Displays data that is set with the DIP switch of the Controller.
- **Operation Monitor**  
Displays the commands and responses the Controller receives in real time.

#### PROGRAM Mode

The V700-CD1D Controller does not operate in PROGRAM mode.

## 6-6-2 Operation Procedure

### Password Input Display

The following display will appear when the Programming Console is connected. Press the RESET Key and then SET Key. Then the default state of the operation mode is displayed.

If the password is entered while the Controller is in MONITOR mode, the Controller in operation will be interrupted. In this case the Controller will wait for the next input in MONITOR mode.

ENTER PASSWORD

### Operation Mode Change

By changing the key switch setting of the Programming Console, the operating mode of the Controller will change.

- MONITOR Mode  
In MONITOR mode, communications with ID Tags are possible through the Programming Console. No command control through the host is possible.
- RUN Mode  
In RUN mode, the Programming Console can display the set data in the Controller and the operating condition of the Controller. No other functions are, however, available.
- PROGRAM Mode  
The V700-CD1D Controller does not operate in PROGRAM mode.

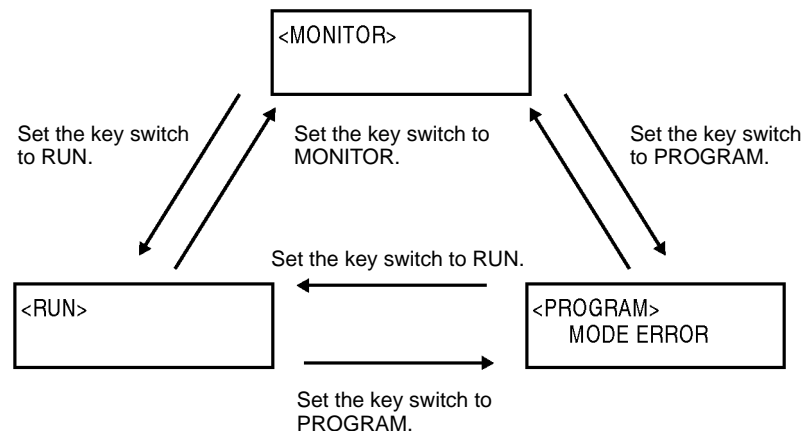

**Key Input in Default Display of MONITOR Mode**

The default display in MONITOR mode appears by setting the key switch to MONITOR. The READ, WRITE, TEST READ, TEST WRITE, NOISE CHECK, LAT.ERR INFO, STA. ERR INFO, and SET INFO Keys will be available. No other keys will be available.

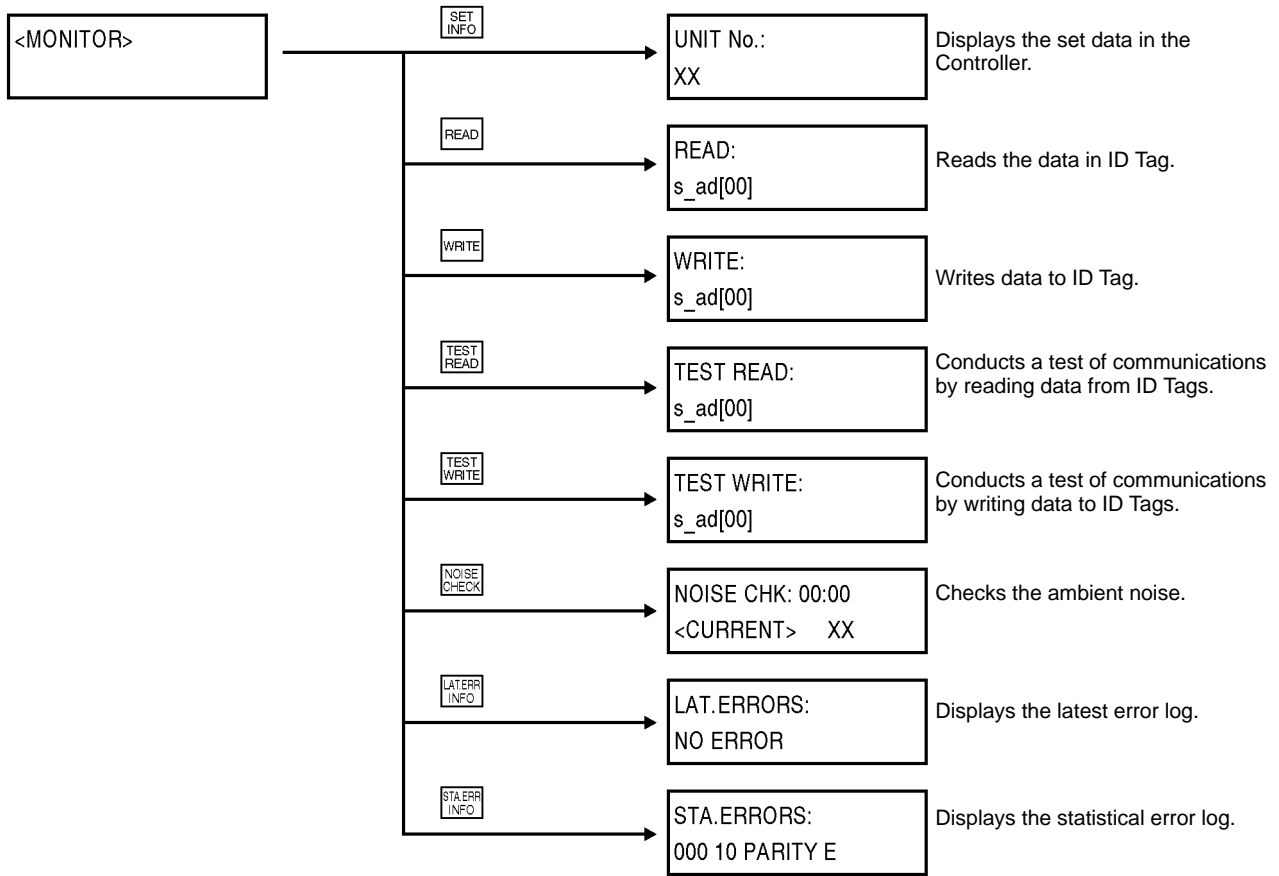

**Note** If the Controller must be kept in operation, do not input the password with the key switch set to MONITOR.

**Key Input in Default Display of RUN Mode**

The default display in RUN mode appears by setting the key switch to RUN. The SET INFO and SET Keys will be available. No other keys will be available.

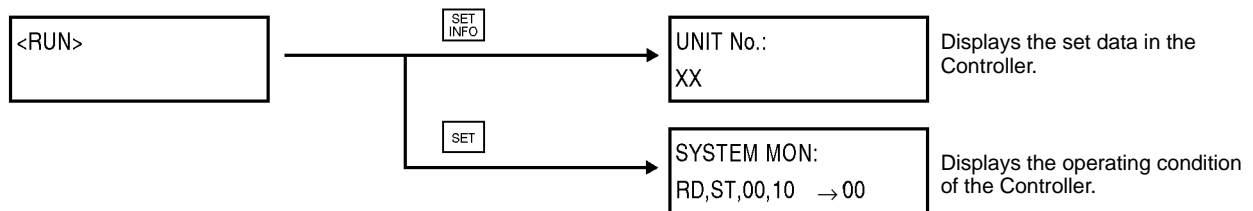

### 6-6-3 Set Data Display

Data that is set with the DIP switch of the Controller is displayed item by item.

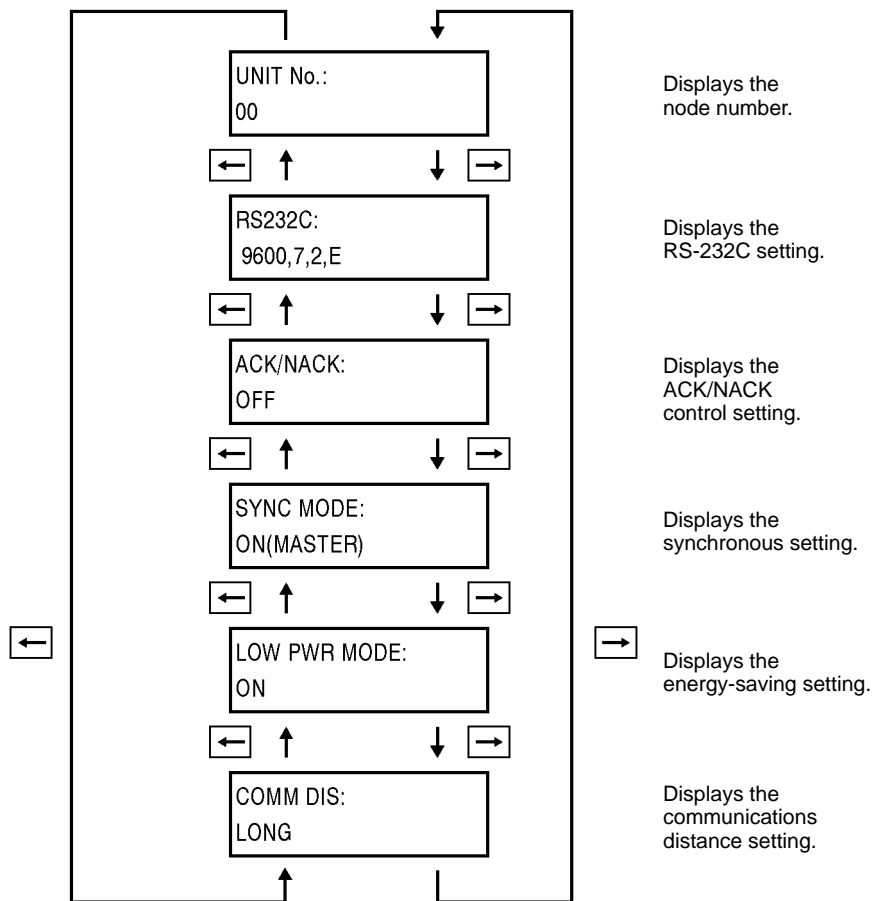

The following data items are displayed for the above.

Item		Display
Node number		00 to 31
RS-232C	Baud rate	4800, 9600, 19200, 38400
	Data length	7, 8
	Stop bits	1, 2
	Parity	Even (E), odd (O), or none (N)
ACK/NACK control		OFF, ON, 5s, ON, 500 ms
Synchronous setting		OFF, ON (Master), ON (Master RO), ON (Slave), ON (Slave RO)
Energy-saving setting		ON, OFF
Communications distance setting		Long (LONG) or short (SHORT) distance

### 6-6-4 Address Setting

Set the start address and end address to determine the area where data is to be read, written, or tests conducted.

#### Read Data

In the following example, the start address is set to 5Ah and the end address is set to 6Fh.

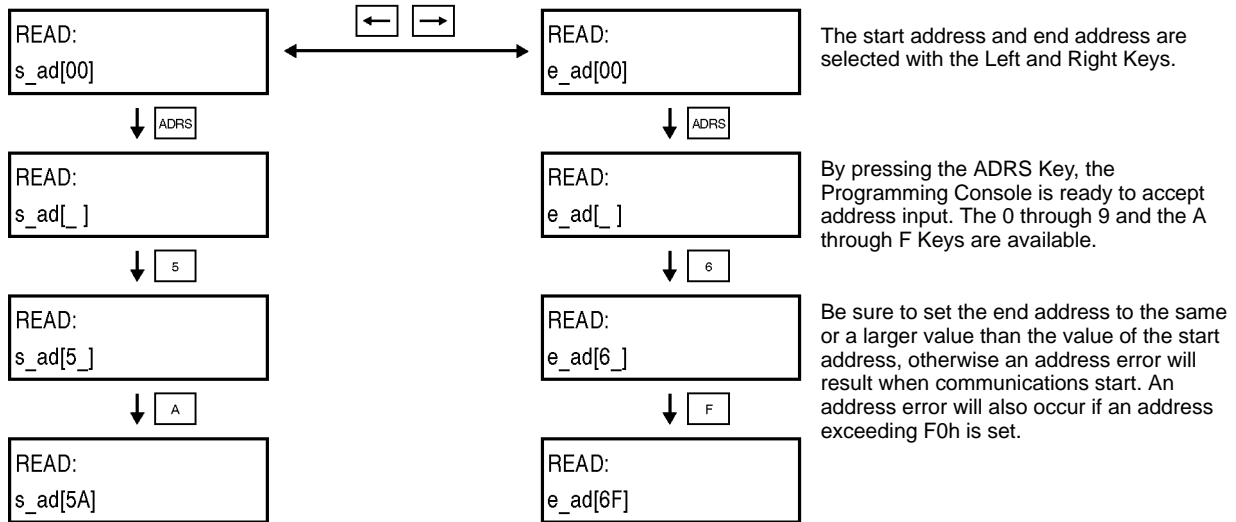

#### Write Data

In the following example, the start address is set to 5Ah and the end address is set to 6Fh.

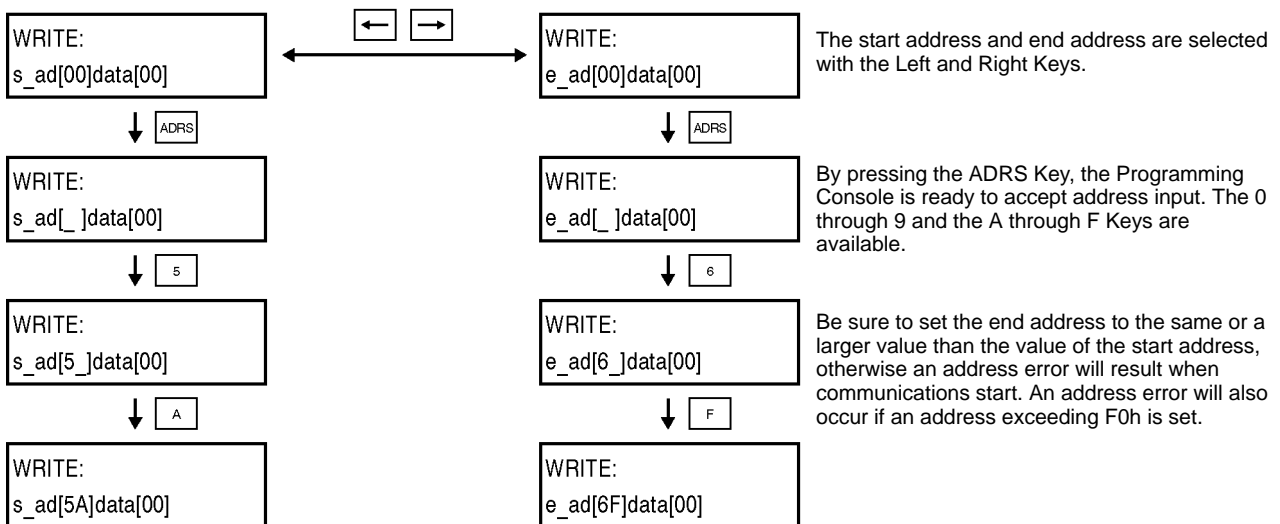

- Note**
1. Be sure to set the end address to the same value or larger value than that of the start address.
  2. Make sure that the specified data is within the memory capacity of the ID Tag.

### 6-6-5 Data Setting

Set the write data in two digits within a range between 00 and FF in hexadecimal. In the following example, the data is set to 1B.

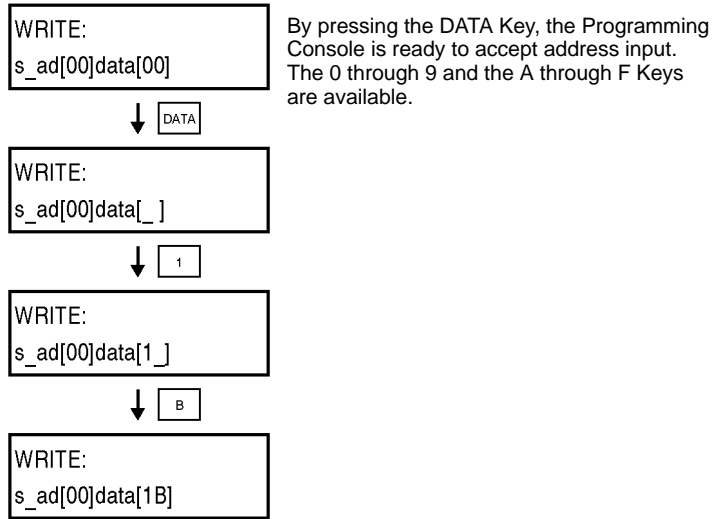

### 6-6-6 Write and Read Data

**Read**

The data of the desired address of the ID Tag is read and displayed.

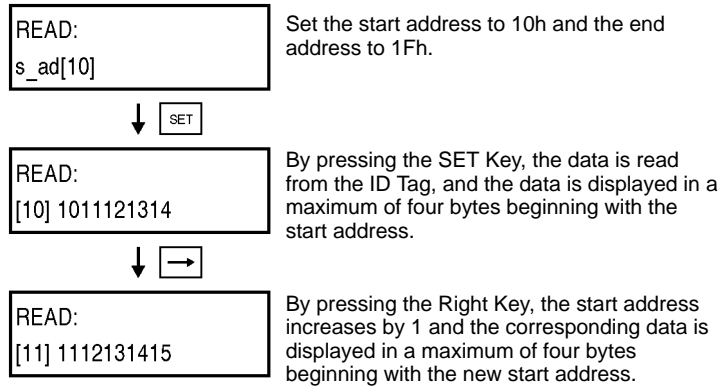

**Note** Make sure that the specified data is within the memory capacity of the ID Tag.

**Read Retry**

After the data is read from the ID Tag, by pressing the SET Key again, the data between the present start address and end address is read gain. By pressing the INC or DEC Key, the start address and end address increase or decrease by 1 each and the corresponding data is read.

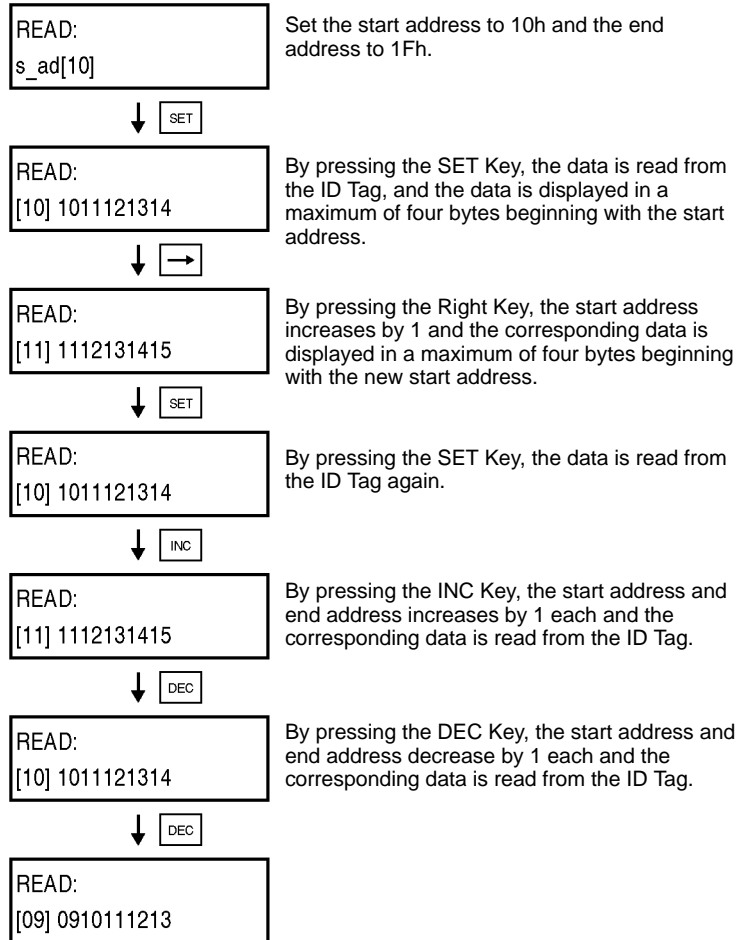

**Write**

Data is written to the desired address of the ID Tag. The same data is written to all the addresses in the designated area.

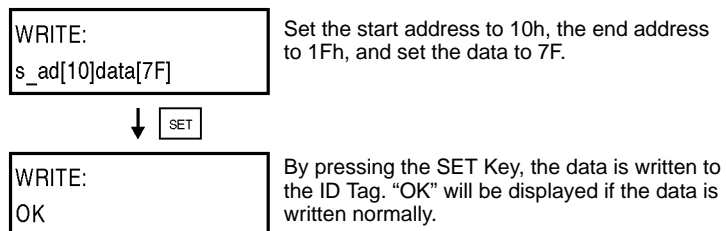

**Write Retry**

After the data is written to the ID Tag, by pressing the SET Key again, the data between the present start address and end address is written to the ID Tag again. By pressing the INC or DEC Key, the start address and end address increase or decrease by 1 each and the corresponding data is written.

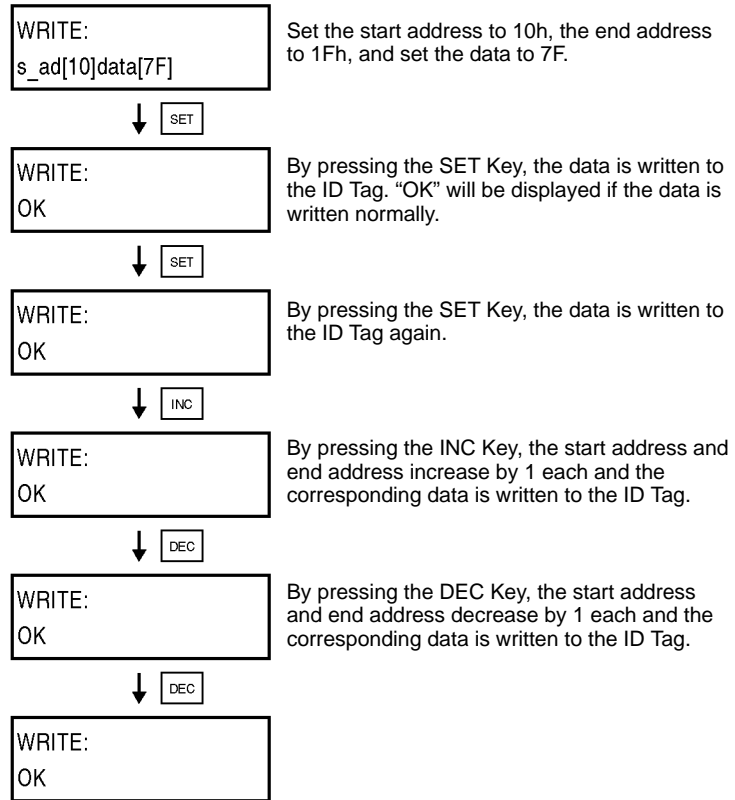

**Note** Make sure that the specified data is within the memory capacity of the ID Tag.

**6-6-7 Test**

If the testing of communications between the Antenna and ID Tag is required, use the test function so that the location of the Antenna and ID Tag and the relative speed of the ID Tag can be checked.

**Communications Mode Setting**

Before executing the TEST READ or TEST WRITE command, set the communications mode.

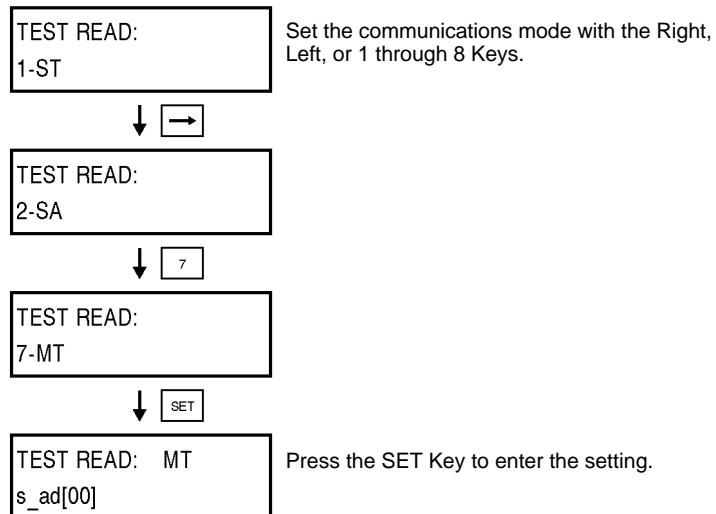



**Test Read**

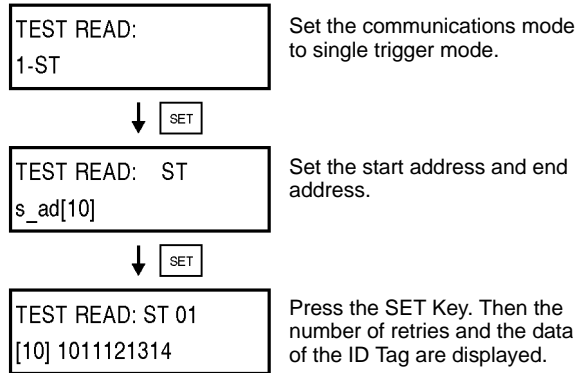

**Test Write**

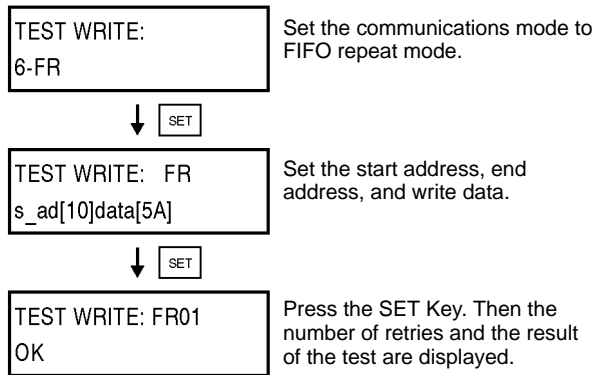

**6-6-8 Ambient Noise Check**

Before the system is in full operation, the installation conditions of the Antenna and ID Tag can be set by checking the ambient noise at the Antenna location.

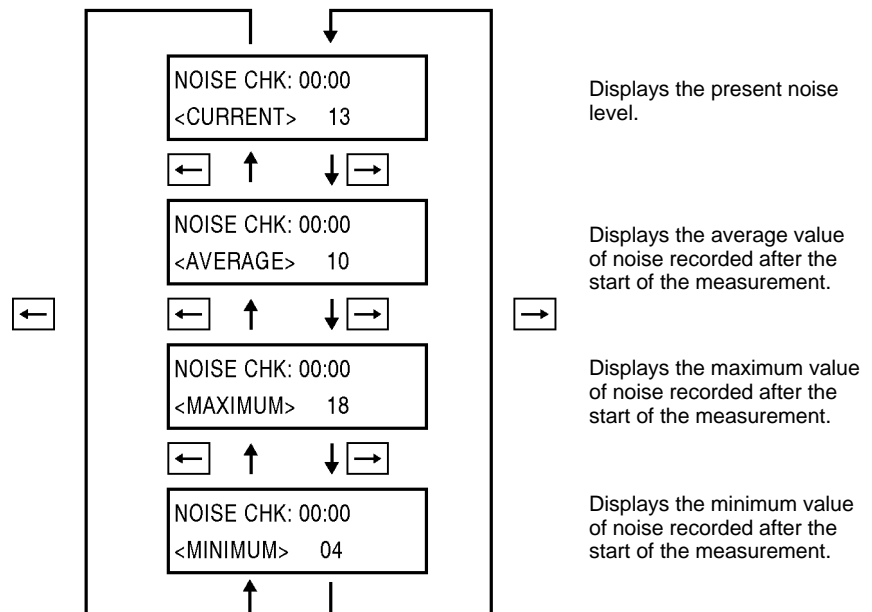

### 6-6-9 Reading Latest Error Log

After the Controller is turned ON, the Controller will keep a record of up to 30 errors in RUN mode if such errors result. If another error results, the Controller will keep it on record by deleting the oldest one from the record, thus always keeping the latest 30 errors.

The whole record is deleted by turning OFF the Controller or resetting the Controller with RESET input.

#### No Error Resulting

```
LAT.ERRORS:  
NO ERROR
```

The message "NO ERROR" will appear if there is no error.

#### Errors Recorded

```
LAT.ERRORS:  
01 RD 70
```



```
LAT.ERRORS:  
02 WT 7D
```



```
LAT.ERRORS:  
03 TS 10
```



```
LAT.ERRORS:  
02 WT 7D
```

If there are errors, the errors will be read in sequence from the latest one. The error log is displayed in chronological order by pressing the Left or Right Key.

This shows the latest error log items indicating the error number, command code, and response code. For the meaning of the response code, refer to 5-16 *List of Response Codes*.

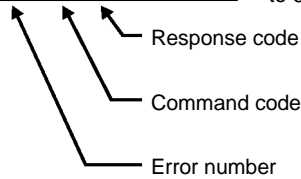

**Note** If the error log must be kept, do not turn OFF or reset the Controller.

### 6-6-10 Statistical Error Log

The Controller classifies all errors recorded after the Controller starts operating according to the response code and displays the number of each type of errors. At the same time, the Controller performs MCBF (i.e., the total number of host commands divided by the total number of errors recorded) calculation. All these data items are kept on record. The whole record is deleted by turning OFF the Controller or resetting the Controller with RESET input.

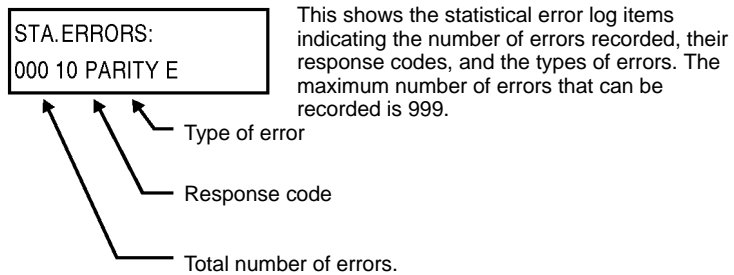
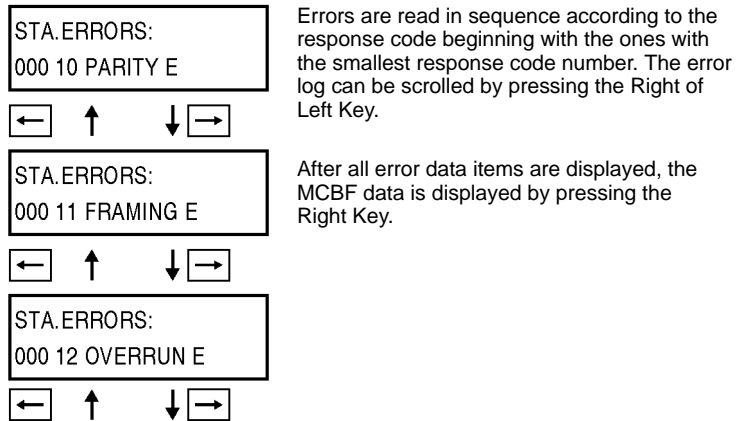

**Note** If the error log must be kept, do not turn OFF or reset the Controller.

### 6-6-11 RUN Monitor

The command received by the Controller and the results of the execution of the command can be monitored in RUN mode.

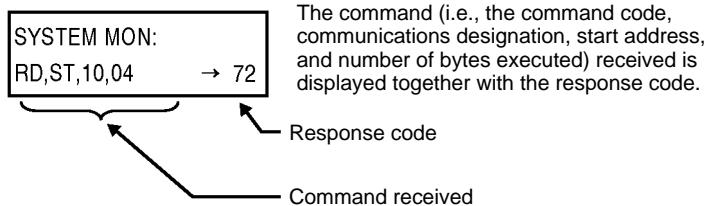



# SECTION 7

## Startup and Full Operation

This section provides information on trial operation, errors and remedies, and maintenance and troubleshooting.

7-1	Trial Operation .....	110
7-2	Self-diagnostic Function .....	111
7-3	List of Errors .....	111
7-4	Errors and Remedies .....	112
7-5	Maintenance and Inspection .....	113
7-6	Troubleshooting .....	115

# 7-1 Trial Operation

## Check Items

Check the following on the RD-ID System before the trial operation of the whole system.

Items	Detail	Page
Power supply and I/O lines	<ul style="list-style-type: none"> <li>• Are the power supply and I/O lines properly wired?</li> <li>• Are all the terminal screws tightened securely?</li> </ul>	41
DIP switch settings	<ul style="list-style-type: none"> <li>• Is the node number set correctly?</li> <li>• Are the communications specifications set correctly?</li> <li>• Is the communications distance mode set correctly?</li> <li>• Is the energy-saving mode set correctly?</li> </ul>	35 to 37
Antenna	Is the Antenna connected properly?	39
Host	Is the RS-232C connector connected properly?	45
Location of Antenna and ID Tag	Are the Antenna and ID Tag located properly?	Section 8

## Procedure for Trial Operation

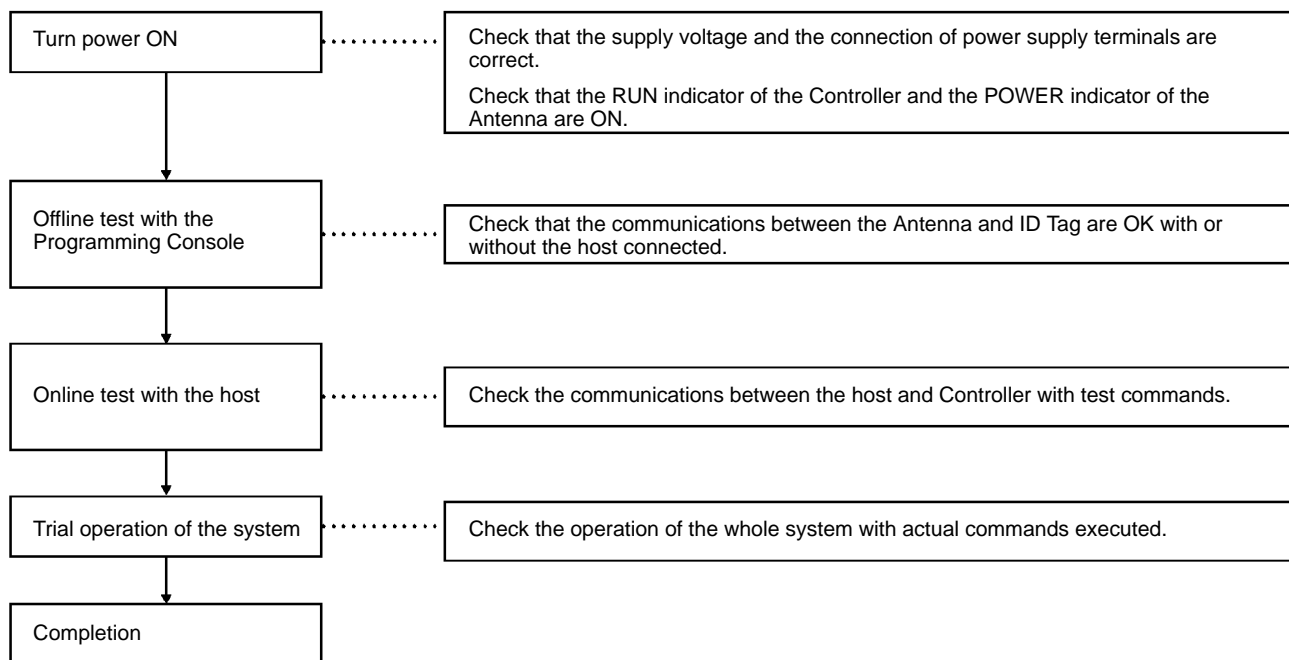

### Offline Test with Programming Console

By using the Programming Console, the communications between the Antenna and ID Tag can be tested without the host connected. This test allows checking of the mounting position of the Antenna and the movement speed of the ID Tag before the trial operation of the whole system. Refer to *Section 6 Programming Console* for details.

### Communications Test with Host

By using test commands, the communications between the Controller and host can be tested. This test allows the checking of the cable connection and the processing operation of communications before the trial operation of the whole system.

- Prepare a simple communications program on the host and transmit test commands.
- If the communications line is normal, the Controller returns the data received.

## 7-2 Self-diagnostic Function

The Controller has a self-diagnostic function to check a variety of items in order to reduce the downtime of the system that may result due to operational failures. If an error results, the details of the error may be read through the Programming Console.

### Details of Errors

Errors detected by the Controller can be classified into “fatal errors” and “nonfatal errors.”

#### Fatal Errors

If the hardware of the Controller fails, the operation of the CPU will be interrupted and the ERROR indicator will turn ON.

#### Nonfatal Errors

If there is a communications error between the Controller and host or the Antenna and ID Tag, the ERROR indicator will turn ON. The Controller will keep a record of up to 30 errors in RUN mode if such errors result. If another error should result, the Controller will keep it on record by deleting the oldest one from the record, thus always keeping the most recent 30 errors. The Programming Console makes it possible to read the details of these errors and the number of each type of errors classified.

Error type	Item	Indicator			
		RUN	COMM	NORM	ERROR
Normal operation	Awaiting command	ON	OFF	OFF	OFF
	Communicating with ID Tag	ON	ON	OFF	OFF
	Normal completion of communications with ID Tag	ON	ON	ON	OFF
Fatal error	CPU error	OFF	OFF	OFF	ON
Nonfatal error	Communications error between Antenna and ID Tag	ON	OFF	OFF	ON
	Communications error between Controller and host	ON	OFF	OFF	ON
	System error	ON	OFF	OFF	ON

## 7-3 List of Errors

### Communications Error between Controller and Host

Response code	Name	Error message	Meaning
10	Parity error	PARITY E	An error occurred during communications between the host and Controller.
11	Framing error	FRAMING E	<ul style="list-style-type: none"> <li>• There was a setting mistake in the communications frame.</li> <li>• There was a malfunction due to noise.</li> </ul>
12	Overrun error	OVERRUN E	
13	BCC error	BCC E	
14	Format error	FORMAT E	<p>The command frame was not correct.</p> <ul style="list-style-type: none"> <li>• An illegal command was received in energy-saving mode.</li> <li>• A subcommand was received while awaiting a command.</li> <li>• The address and number of bytes specified were beyond the permissible ranges.</li> </ul>
18	Frame length error	FRAME E	The command received exceeded 288 characters.

The details of the above errors are kept on record in the Controller, the error codes and error messages of which can be read through the Programming Console.

## Communications Error between Controller and ID Tag

Response code	Name	Error message	Meaning
70	Communications error	COM.DC E	An error occurred during communications between the Controller and ID Tag. <ul style="list-style-type: none"> <li>• There was a setting mistake in the passing speed or sensing distance of ID Tag.</li> <li>• There was a malfunction due to an obstacle.</li> <li>• There was a malfunction due to noise.</li> </ul>
71	Verification error	VERIFY E	A verification error occurred during a write.
72	No Tag error	NO DC E	There was no ID Tag in the communications area of the Antenna when the command was executed.
7A	Address error	ADRS E	The specified address exceeds the memory area of the ID Tag.
7B	Not write area error	WT AREA E	The ID Tag is in a read-only area.
7C	No Antenna connected error	ANT E	No Antenna is connected.
7D	Protection error	PROTECT E	An attempt was made to write to a write-protected area.
7E	ID system error	ID SYS1 E	An ID system error has occurred.
7F			

The details of the above errors are kept on record in the Controller, the error codes and error messages of which can be read through the Programming Console.

Warning code	Name	Meaning
76	Data error	Data was not normal when an MC, MK, AD, or SB command was executed.

The details of this warning are not kept on record in the Controller.

## System Error

Response code	Name	Error message	Meaning
9A	Sync error	SYNC E	The multiple Controllers used were not synchronized for mutual interference prevention at the time of acceptance of the command.

The details of the above error are kept on record in the Controller, the error code and error message of which can be read through the Programming Console.

**Note** If a communications error or verification error results in the execution of a write command, the address data specified by the command may be partly or completely overwritten by something other than expected data. There is, however, no influence on any data other than the specified address data.

## 7-4 Errors and Remedies

The following are considered to be main causes of system breakdowns.

- Noise interference      Take appropriate countermeasures against noise.
- Failures in peripheral devices      Repairs are required.
- Failures in the Controller      Repairs are required.
- Failures in the Antenna      Repairs are required.
- Failures in the cable      Repairs are required.
- Failures in the ID Tag      Repairs are required.
- Other failures      Repairs are required.



**Noise Interference**

If the system malfunctions due to noise, refer to the following and take appropriate countermeasures.

Circumstance of failure	Probably cause	Remedy
Occurs when a heavy-duty motor, transformer, or capacitor is turned ON.	An instantaneous voltage drop due to inrush current to the heavy load.	Increase the capacity of the power supply and that of the power cable.
	Common mode noise caused by the above cause.	<ul style="list-style-type: none"> <li>• Provide the power through a 1-to-1 non-grounded insulating transformer.</li> <li>• Independently ground the Controller at a resistance less than 100 Ω.</li> </ul>
Occurs irregularly	Noise on power line	<ul style="list-style-type: none"> <li>• Provide the power through a 1-to-1 non-grounded insulating transformer or noise filter.</li> <li>• Independently ground the Controller at a resistance less than 100 Ω.</li> </ul>
	Ambient noise	<p>If more than one Controller is used and any two of the Antennas are located within a distance of 20 m, make sure that the Controllers are in synchronous operation.</p> <p>Separate the following devices at least 1 m away from the Antenna.</p> <ul style="list-style-type: none"> <li>• Personal computers, AC adapters for personal computers, switching regulators, Programmable Terminals, motors, and proximity sensors.</li> </ul>

**Improvement in Grounding**

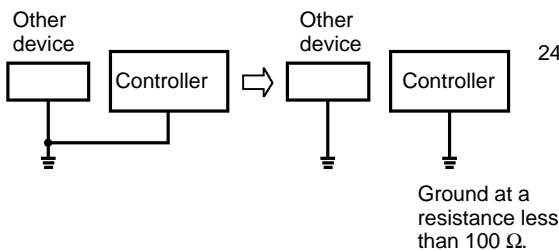

**Countermeasures Against Noise on Power Line**

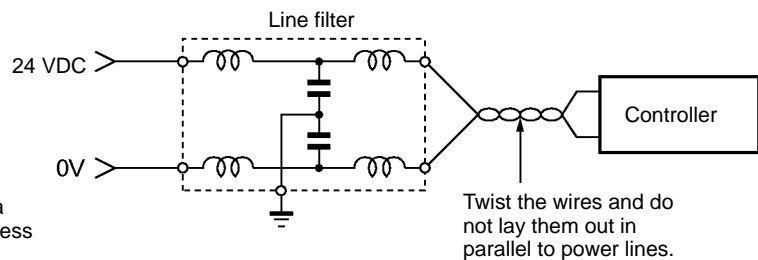

- Note**
1. It is recommended that the ambient noise check function be used to check the influence of ambient noise.
  2. Separate the Antenna by at least 1 m (reference value) from the origin of ambient noise.

## 7-5 Maintenance and Inspection

The V700 Series must be inspected on a daily or regular basis so that the functions of the V700 Series can be used in good condition.

The V700 Series consists of semiconductors that last almost indefinitely. The following malfunctions may, however, result due to the operating environment and conditions.

- 1, 2, 3...**
1. Element deterioration due to overvoltage or overcurrent.
  2. Element deterioration due to continuous stress caused by high ambient temperature.
  3. Connector contact faults or insulation deterioration due to humidity and dust.
  4. Connector contact faults or element corrosion due to corrosive gas.

Inspection Items

Item	Detail	Criteria	Remarks
Supply voltage fluctuation	Check that the supply voltage fluctuation at the power supply terminal block is within the permissible range.	Supply voltage rating	Multimeter
	Check that there is no frequent instantaneous power failures or radical voltage drops.	Within permissible voltage fluctuation range	Power supply analyzer
Environment (1) Ambient temperature (2) Ambient humidity (3) Vibration and shock (4) Dust (5) Corrosive gas	(1) and (2) Check that the ambient temperature and humidity are within the specified ranges.  (3) Check that no vibration or shock is transmitted from any machines.  (4) Check that the system is free of dust accumulation.  (5) Check that no metal part of the system is discolored or corroded.	(1), (2) and (3) Check that the ambient temperature and humidity are within the specified ranges.  (4) The ambient temperature, humidity, vibration, and shock must be within the specified ranges.  (5) The system must be free of dust accumulation. No metal part of the system is discolored or corroded.	Maximum and minimum thermometer Hygrometer
Panel condition (1) Ventilation (2) Packing for any enclosed construction	(1) Check that the system is ventilated properly with natural ventilation, forced ventilation, or cooling air.  (2) Check that the packing is properly attached with no damage.	(1) The interior temperature must be within a range between -10°C and 55°C with proper ventilation.  (2) The packing has no damage.	---
I/O power supply (1) Voltage fluctuation (2) Ripple	Check on the I/O terminal block that the voltage fluctuation and ripple are within the permissible ranges.	The voltage fluctuation and ripple must be within the permissible ranges.	Multimeter Oscilloscope
Mounting condition	Check that each device is securely mounted.	There must be no loose screws.	---
	Check that each connector is securely connected.	Each connector is locked or securely tightened with screws	---
	Check that no screw of the terminal block is loosened.	There must be no loose screws.	---
	Check that no wire is broken or nearly broken.	There must be no wire that is broken or nearly broken.	---
	Check that the distance between the ID Tag and Antenna is within the specified range.	The distance between the ID Tag and Antenna must be within the specified range.	---
	Check that the GR terminal is grounded.	The terminal must be grounded to a resistance of 100 Ω or less.	---
Error logging	Check the details of error logs.	---	---

# 7-6 Troubleshooting

If an error results, fully check the whole situation, determine the relationship between the system and any other device, and refer to the following flowcharts for troubleshooting.

## Main Check Flowchart

Use the following main check flowchart to determine the cause of the error.

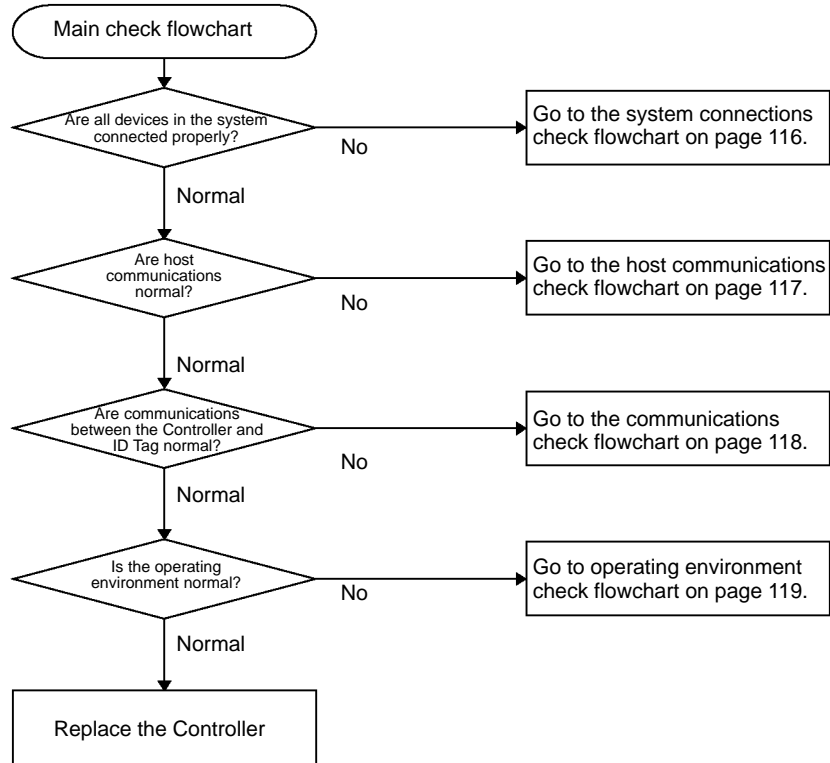

System Connections Check Flowchart

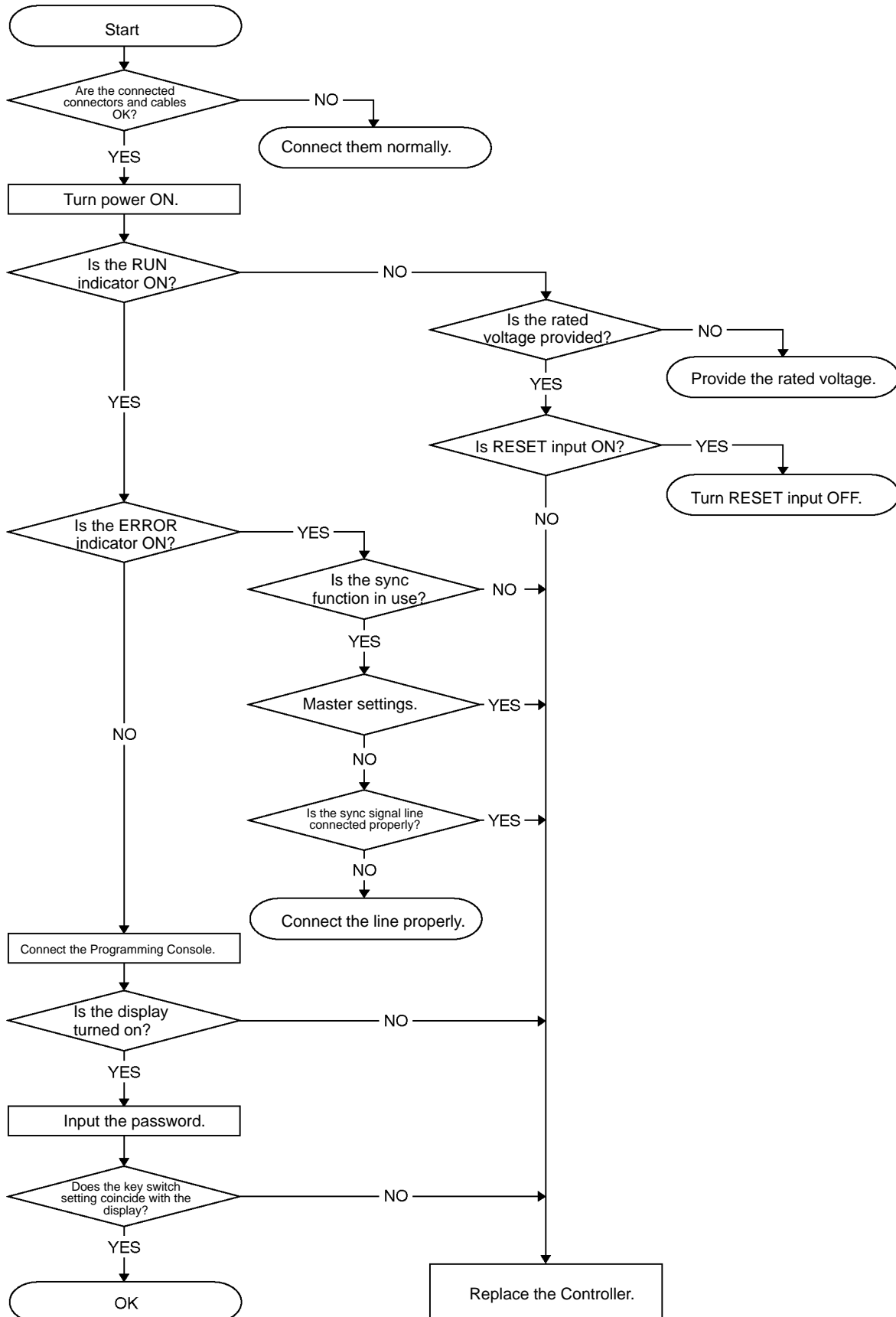

Host Communications Check Flowchart

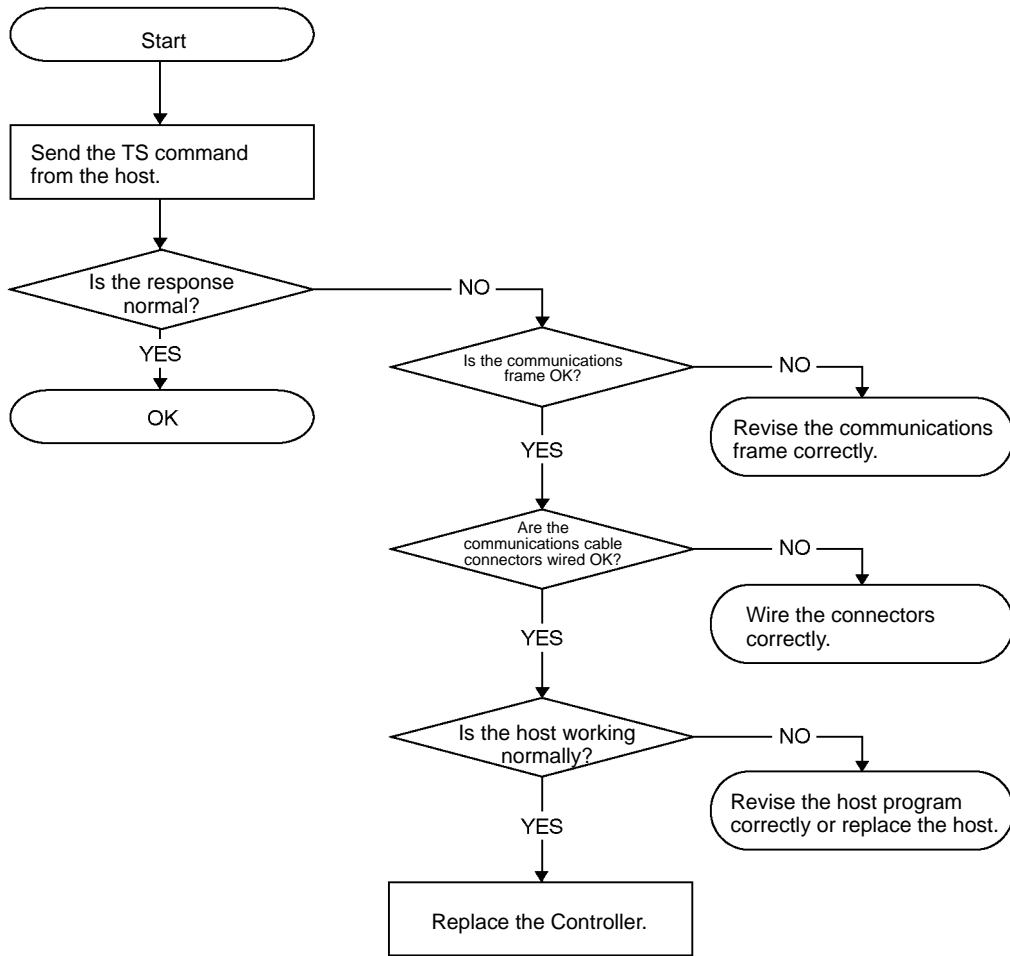

Communications Check Flowchart

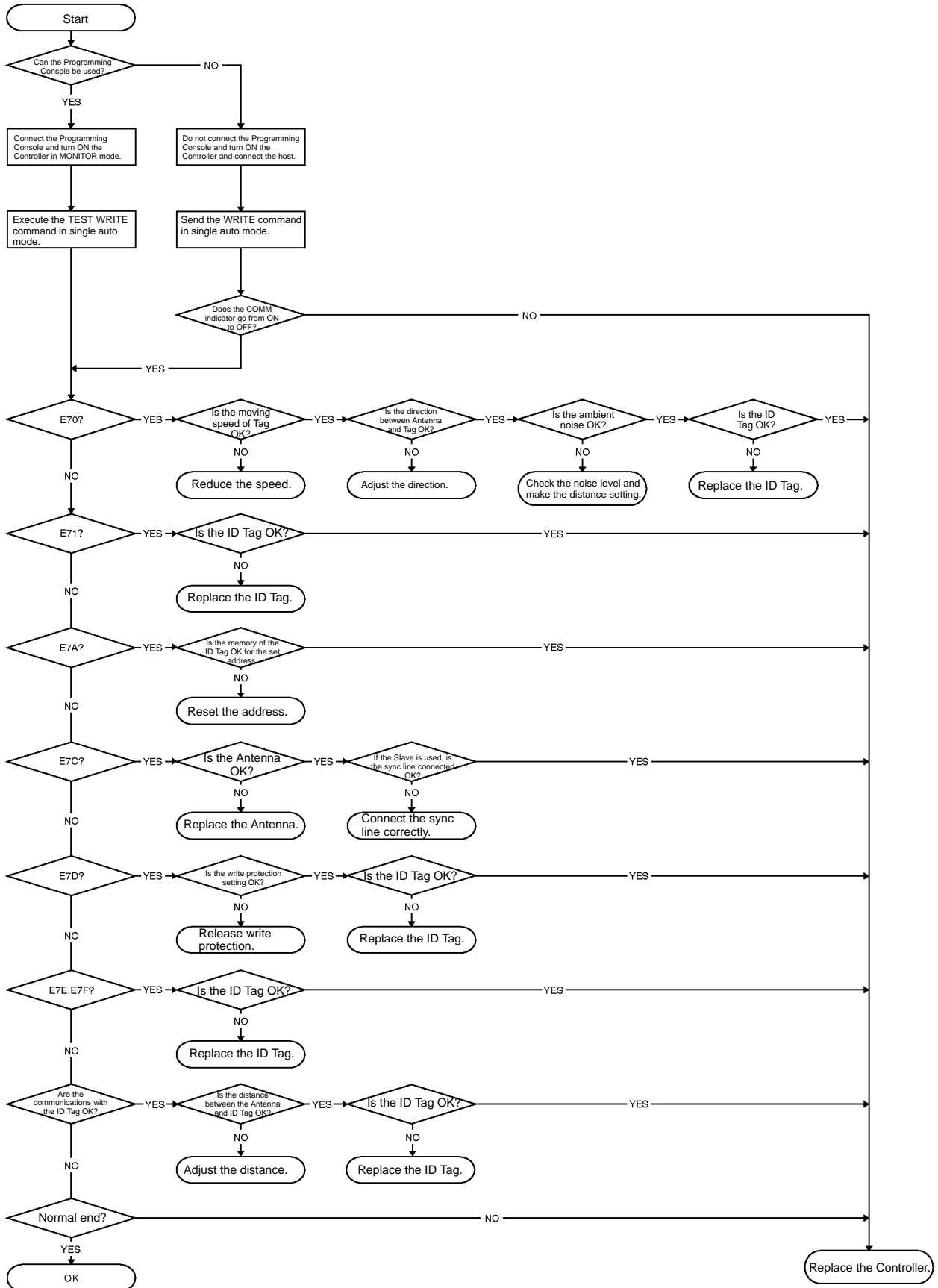

Operating Environment Check Flowchart

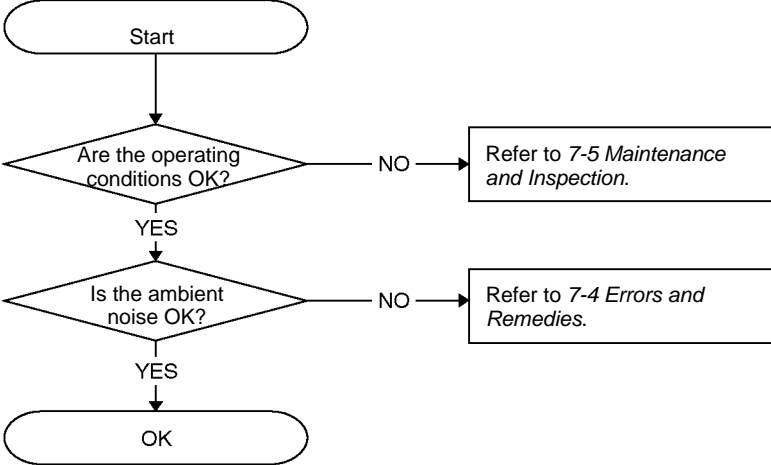





# SECTION 8

## Reference Data

This section provides reference data relating to V700 communications, ID Tags, Antennas, and proximity sensors.

8-1	Maximum Communications Distance .....	122
8-2	Communications Distance Characteristics vs. Ambient Noise .....	123
8-3	Communications Areas .....	125
8-4	Communications Time .....	129
8-5	Influence of Background Metal on Antenna .....	131
8-6	Mutual Interference between Antennas .....	134
8-7	Mutual Interference between Proximity Sensor and Antenna .....	136
8-8	Influence of Background Metal on ID Tag .....	137
8-9	Influence of ID Tag Incline .....	140
8-10	Influence of ID Tag Angle .....	140
8-11	Chemical Resistance of ID Tag .....	141
8-12	Relationship between ID Tag and Metal Sensor .....	142

## 8-1 Maximum Communications Distance

The maximum communications distance varies with the installation and environmental conditions. Be sure to check the required conditions carefully.

### Maximum Communications Distance in Long-distance Mode

ID Tag			Antenna	
			V700-H01	V700-H02
V700-D23P31	Max. communications distance		250 mm (typ)	280 mm (typ)
	Recommended set distance	Tag not moving	0 to 200 mm	0 to 200 mm
		Tag moving	100 to 200 mm	100 to 200 mm
V700-D23P41	Max. communications distance		220 mm (typ)	240 mm (typ)
	Recommended set distance	Tag not moving	0 to 200 mm	0 to 200 mm
		Tag moving	45 to 200 mm	45 to 200 mm

### Maximum Communications Distance in Stable Communications Mode

ID Tag			Antenna	
			V700-H01	V700-H02
V700-D23P31	Max. communications distance		200 mm (typ)	250 mm (typ)
	Recommended set distance	Tag not moving	0 to 160 mm	0 to 160 mm
		Tag moving	80 to 160 mm	80 to 160 mm
V700-D23P41	Max. communications distance		180 mm (typ)	180 mm (typ)
	Recommended set distance	Tag not moving	0 to 150 mm	0 to 150 mm
		Tag moving	45 to 150 mm	45 to 150 mm

## 8-2 Communications Distance Characteristics vs. Ambient Noise

The communications distance characteristics may deteriorate due to the ambient noise at the Antenna location. Before installing the Antenna, use the noise check function, measure the noise level in the installation environment, and set the communications distance by referring to the following.

### V700-H01 (V700-D23P31)

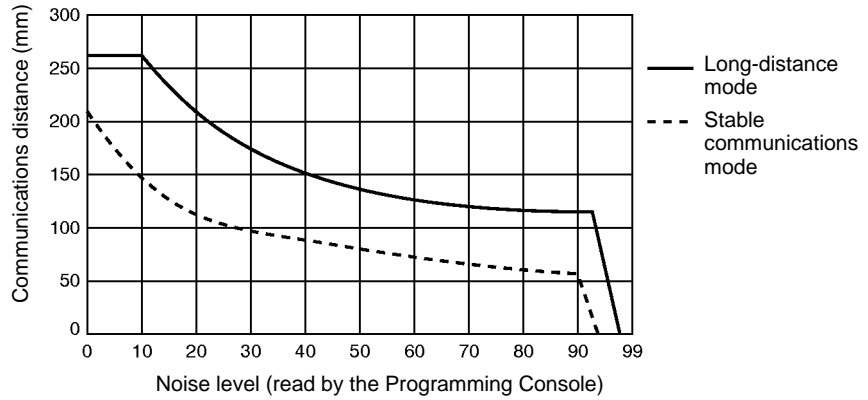

### V700-H02 (V700-D23P31)

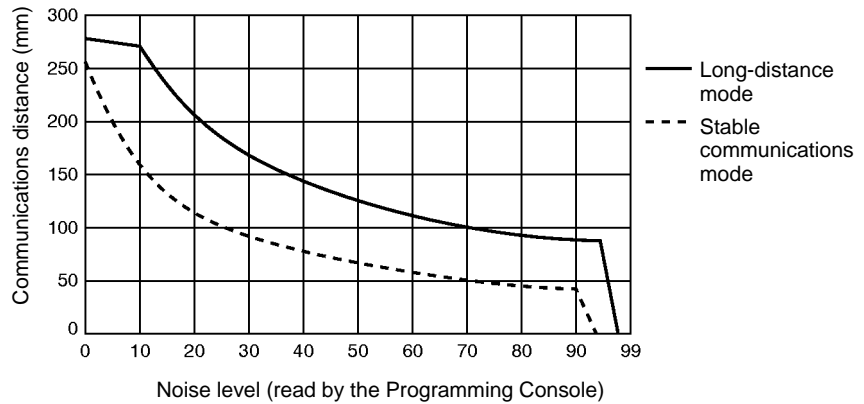

V700-H01 (V700-D23P41)

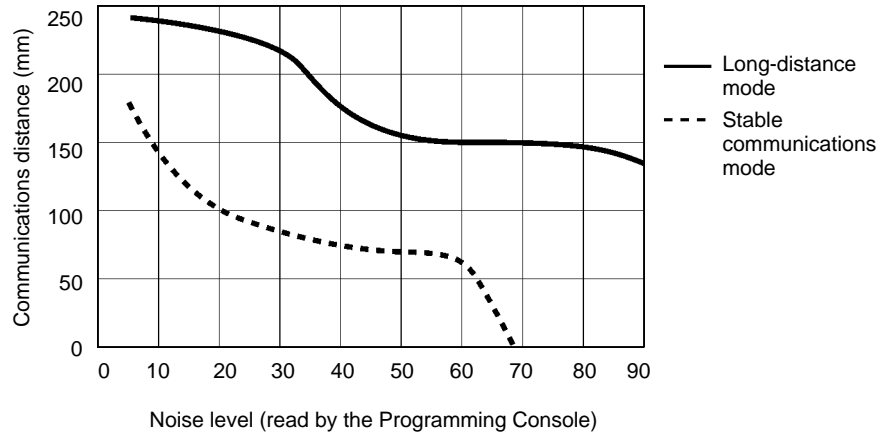

V700-H02 (V700-D23P41)

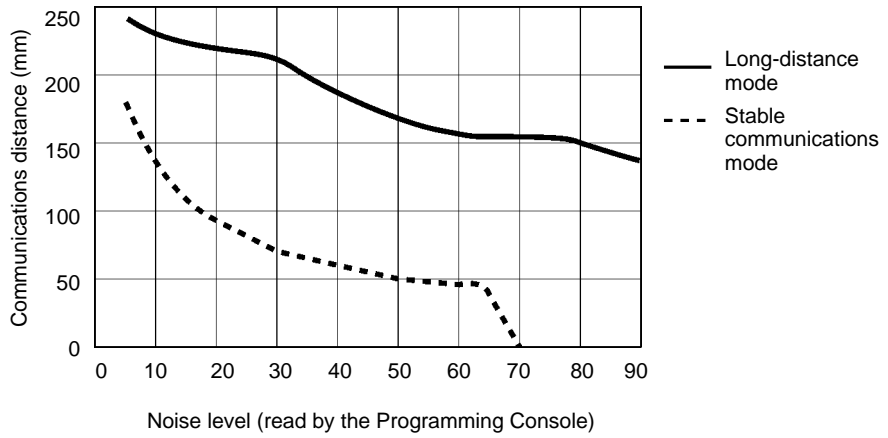

### 8-3 Communications Areas

#### Communications Areas in Long-distance Mode

**V700-H01 (V700-D23P31)**

The following is the planer communications area of the V700-H01 when the Tag passes through the center of the Antenna and perpendicular to the Antenna surface.

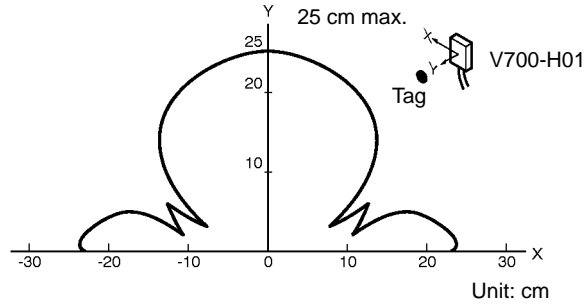

**V700-H02 (V700-D23P31)**

The following are the communications areas of the V700-H02 in the X and Y directions, provided that each range in the Y direction is checked at the center of the Antenna and 20 cm away from the Antenna.

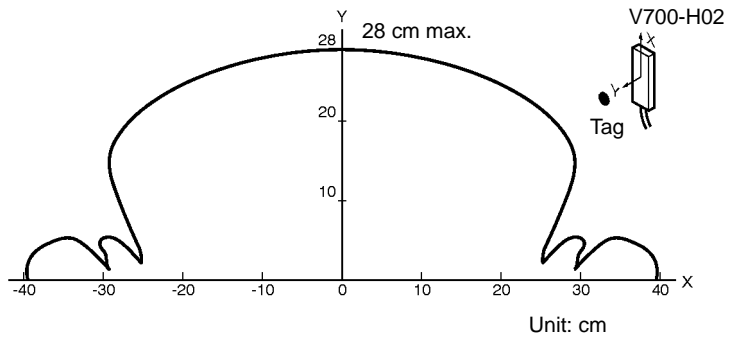
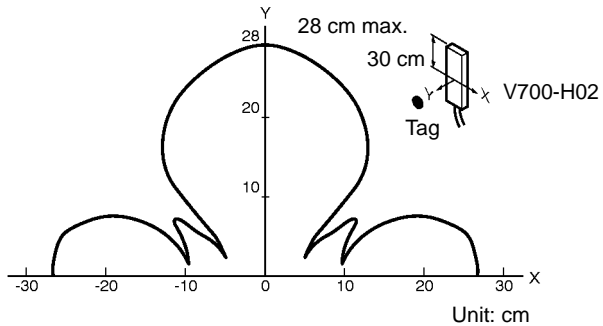
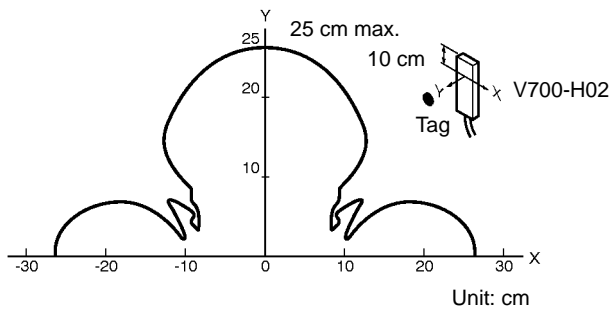

**Communications Areas in Stable Communications Mode**

**V700-H01 (V700-D23P31)**

The following is the planer communications area of the V700-H01 when the Tag passes through the center of the Antenna and perpendicular to the Antenna surface.

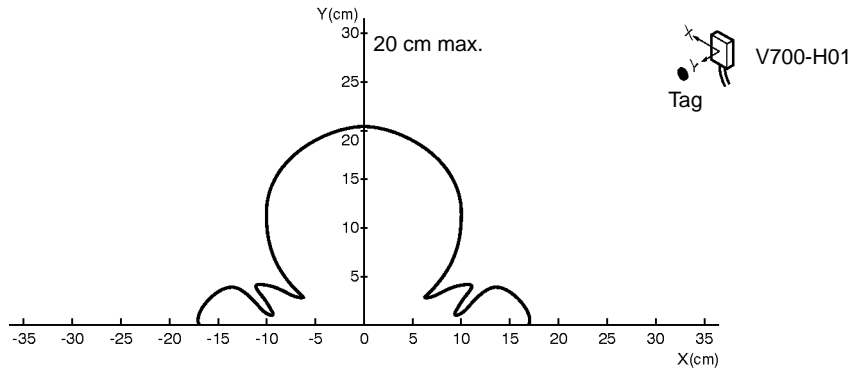

**V700-H02 (V700-D23P31)**

The following are the communications areas of the V700-H02 in the X and Y directions, provided that each range in the Y direction is checked at the center of the Antenna and 20 cm away from the Antenna.

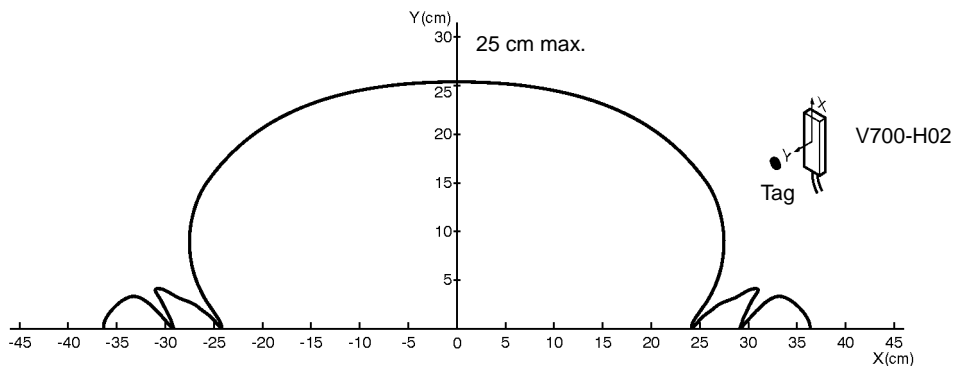
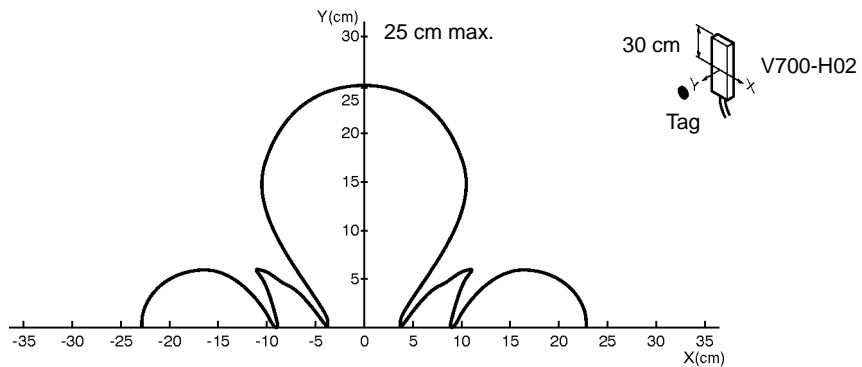
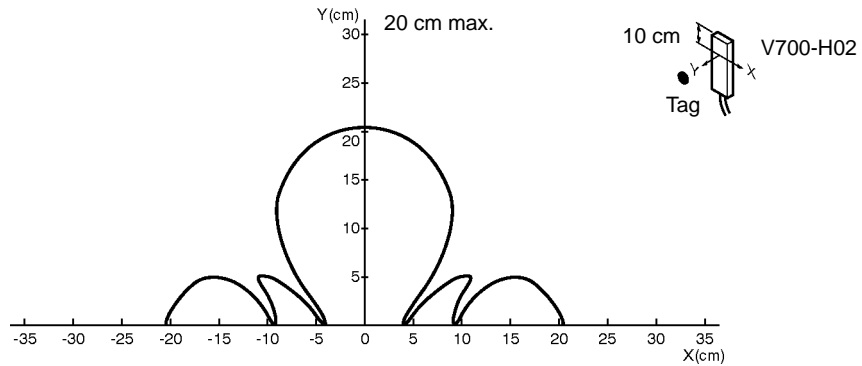

**Communications Areas in Long-distance Mode**

**V700-H01 (V700-D23P41)**

The following is the planer communications area of the V700-H01 when the Tag passes through the center of the Antenna and perpendicular to the Antenna surface.

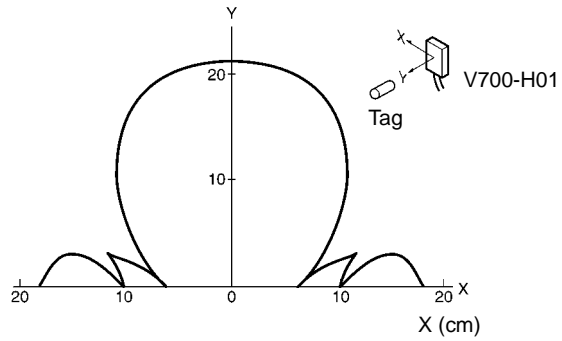

**V700-H02 (V700-D23P41)**

The following are the communications areas of the V700-H02 in the X and Y directions.

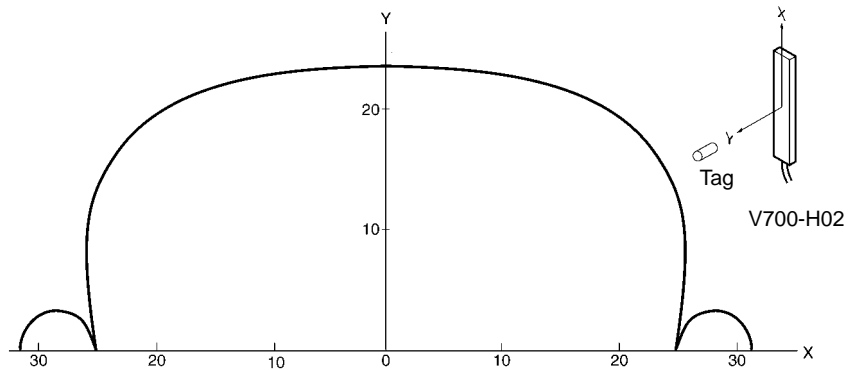
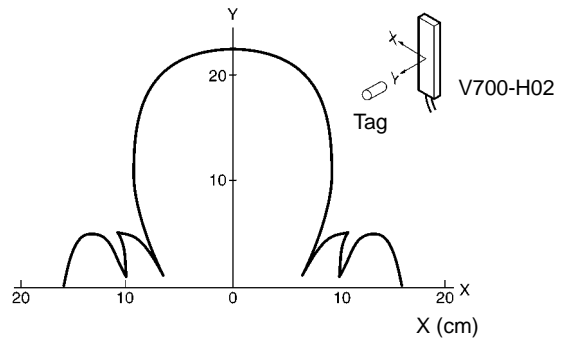

**Communications Areas in Stable Communications Mode**

**V700-H01 (V700-D23P41)**

The following is the planer communications area of the V700-H01 when the Tag passes through the center of the Antenna and perpendicular to the Antenna surface.

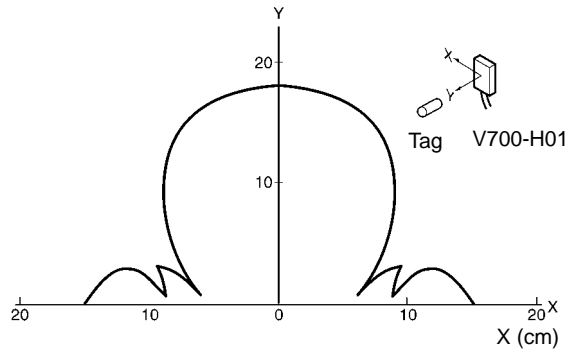

**V700-H02 (V700-D23P41)**

The following are the communications areas of the V700-H02 in the X and Y directions.

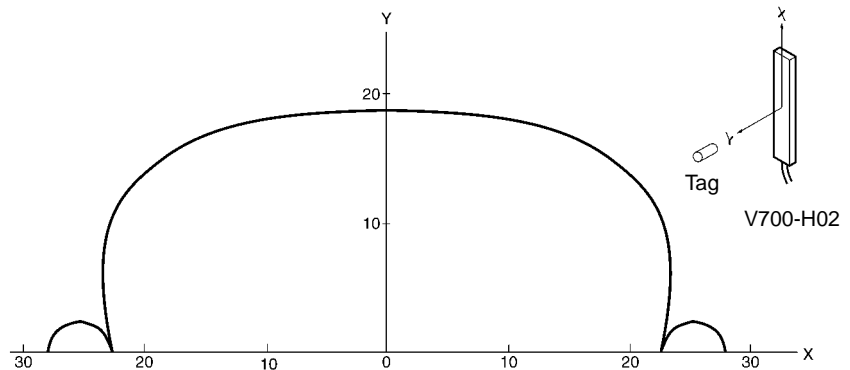
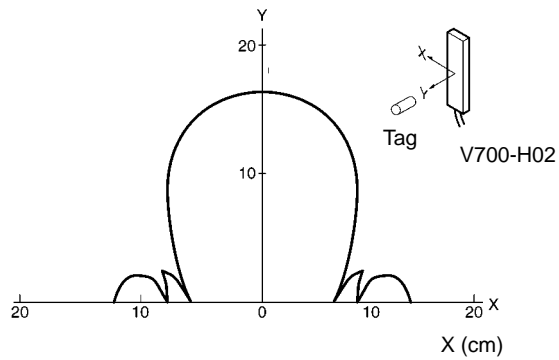



## 8-4 Communications Time

The V700-series Controller reads or writes eight-byte data per page from or to addresses X0h through X7h or X8h through XFh. In order to minimize the communications time, therefore, specify the address and the number of bytes so as to minimize the number of pages.

- The following chart specifies the TAT (turn-around time) and actual communications time. (TAT is the communications time between the host and Tag.)
- The actual communications time varies with the sync setting of the Controller.
- The actual communications time in the following chart is the time required for communications between the Antenna and ID Tag, not including communications with the host. Use this for calculating the speed of the ID Tag for the execution of auto commands.

Example

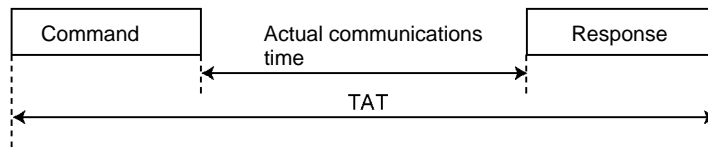

### No Sync

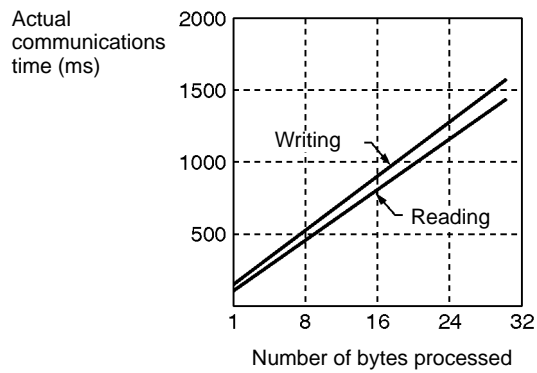
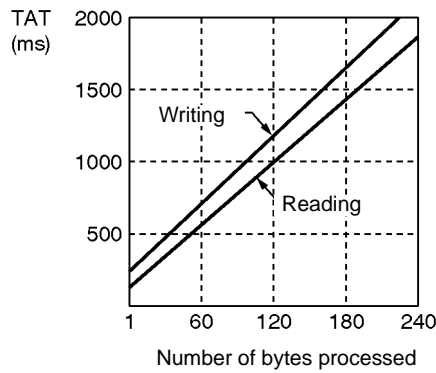

### Calculation Formula

Operation	Actual communications time (msec)
Reading	$T = 46.7N + 60.7$
Writing	$T = 52.8N + 113.5$

**Note** N: Number of pages processed

### Read-only Sync

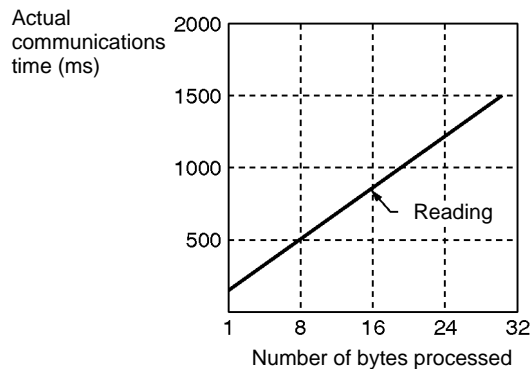
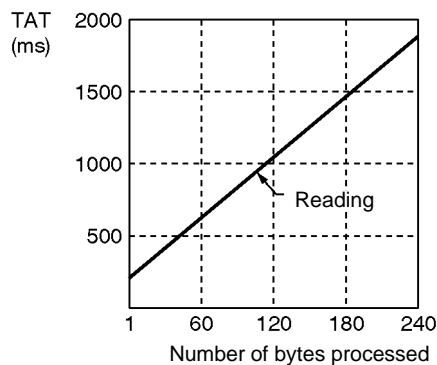

Calculation Formula

Operation	Actual communications time (msec)
Reading	$T = 46.7N + 107.4$

**Note** N: Number of pages processed

Read/Write Sync

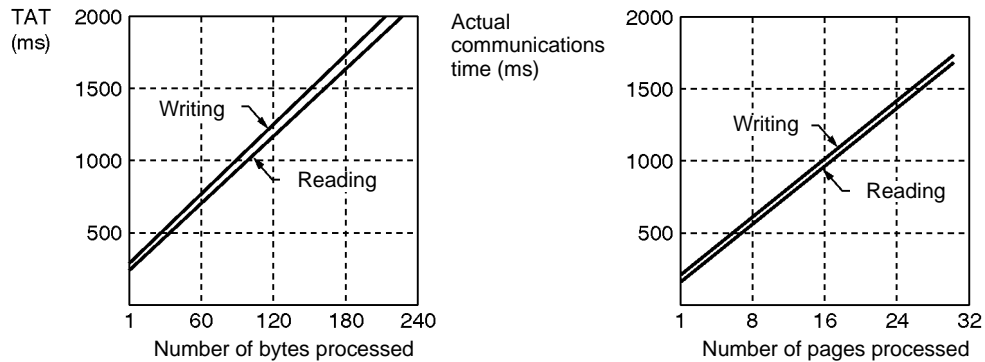

Calculation Formula

Operation	Actual communications time (msec)
Read	$T = 52.8N + 119.6$
Write	$T = 52.8N + 172.4$

**Note** N: Number of pages processed

**Actual Communications Time in Multiple, Simultaneous Access Mode**

The actual communications time between the Controller and ID Tag with multiple, simultaneous access mode varies with the operating conditions, such as the number of ID Tags in the communications area and the ID code combination of each ID Tag as well as the number of bytes to be processed.

The following table lists average values of communications time as reference values on condition that the ID codes are used at random.

Number of ID Tags	8 bytes to be read (ms)	8 bytes to be written (ms)
5	579	873
10	1,191	1,547
15	1,857	2,275
20	2,523	3,002
30	3,853	4,455
50	6,344	7,192

- Note**
1. The provided TAT data is an example in which the V700-CD1D Controller is used under the following conditions for host communications:  
The data is continuously sent with no space between characters, a baud rate of 9,600 bps, and a data length of 7 bits with 2 stop bits and even parity.
  2. The number of bytes in TAT data is the number of code-specified bytes in ASCII.

**Note** In actual operation, allow at least a 10% margin for the communications time when auto commands are used, otherwise a communications error may result.

### 8-5 Influence of Background Metal on Antenna

The Antenna is influenced by background metal.

The communications area of the Antenna will be reduced if there is metal behind the Antenna as shown below.

#### V700-H01 (V700-D23P31)

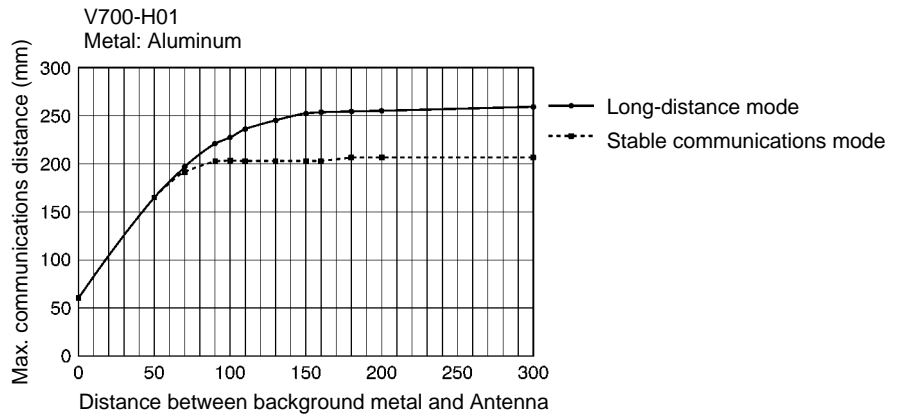
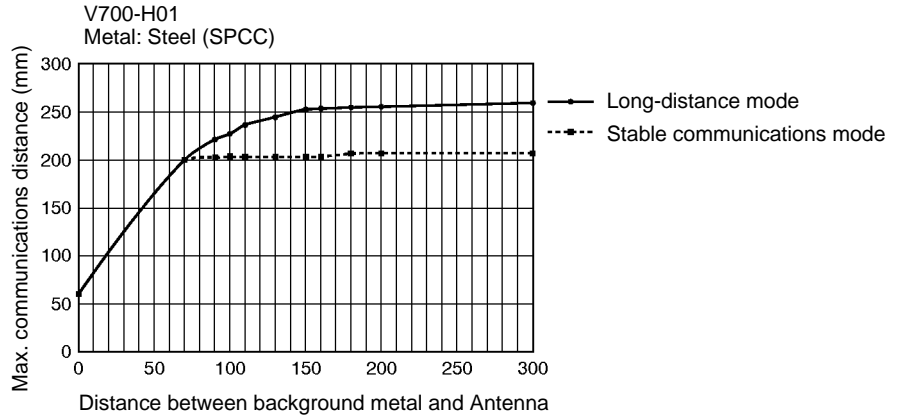

**V700-H02 (V700-D23P31)**

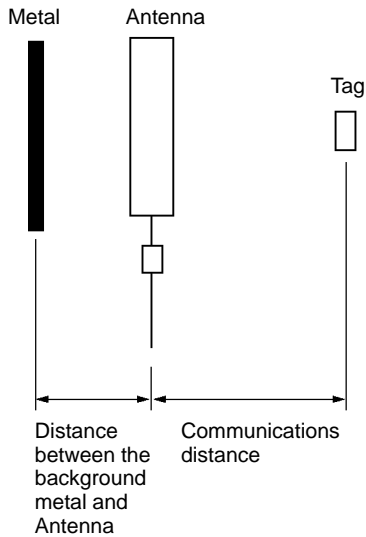
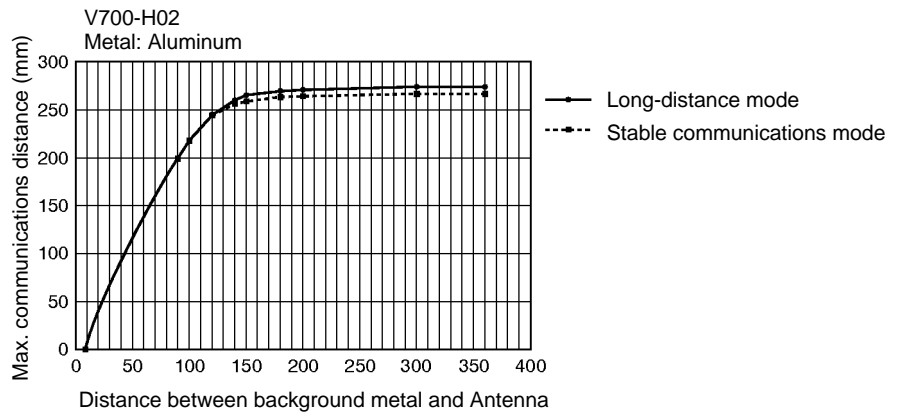
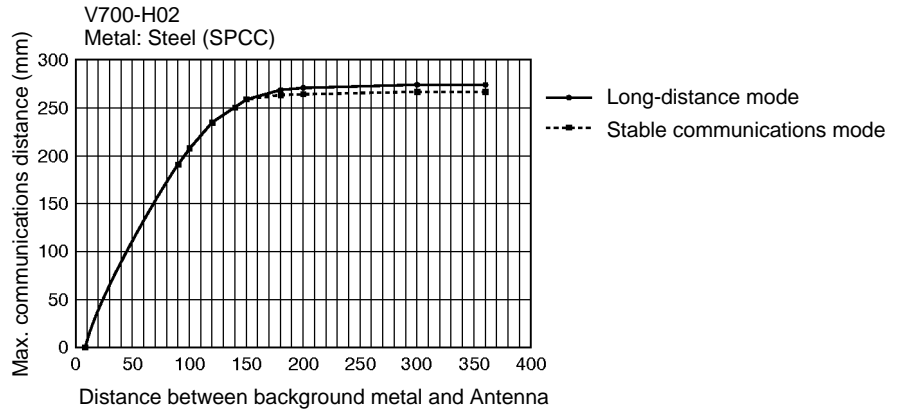

V700-H01 (V700-D23P41)

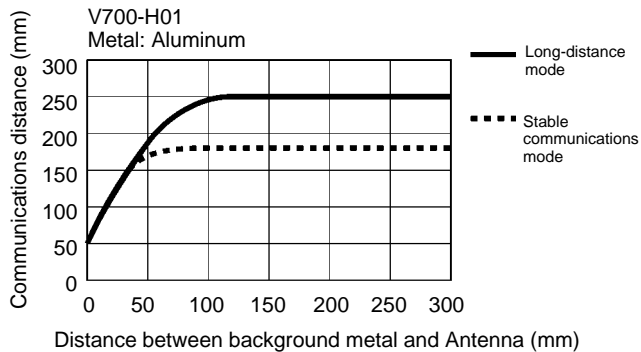
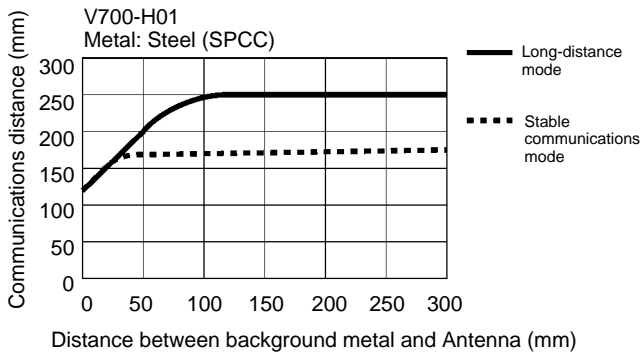

V700-H02 (V700-D23P41)

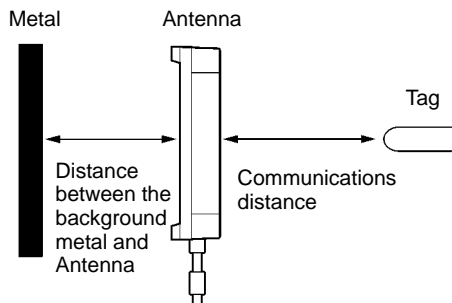
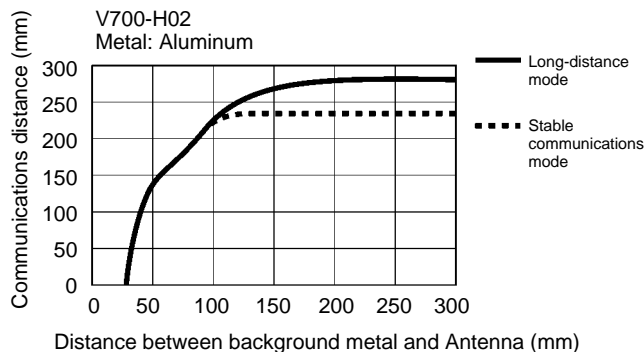
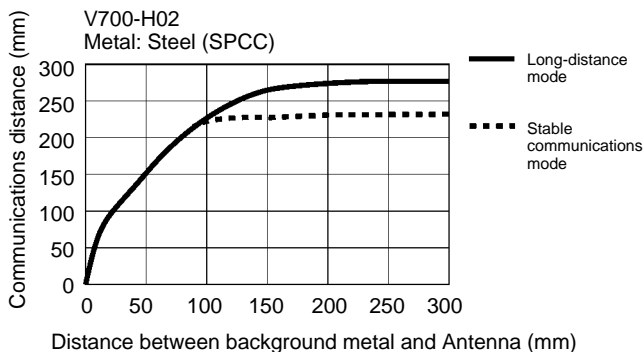

# 8-6 Mutual Interference between Antennas

If more than one Antenna is used, be sure to keep the Antennas away from each other as shown below.

## Synchronous Operation

**V700-H01**

Located Face-to-face

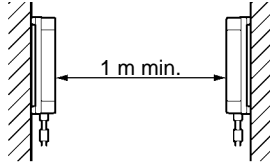

**V700-H02**

Located Face-to-face

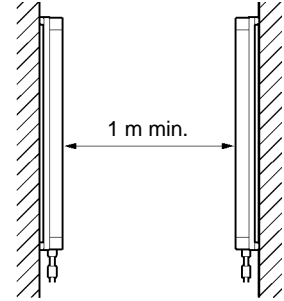

Located in Parallel

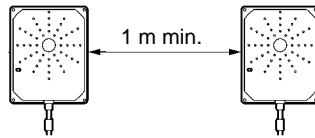

Located in Parallel

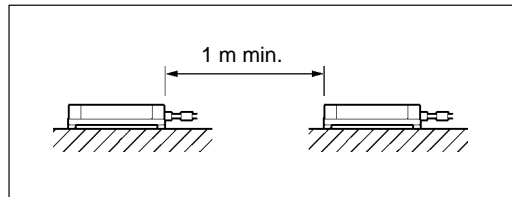
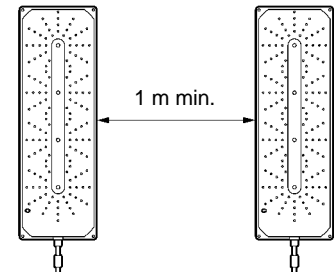

Asynchronous Operation

V700-H01

Located Face-to-face

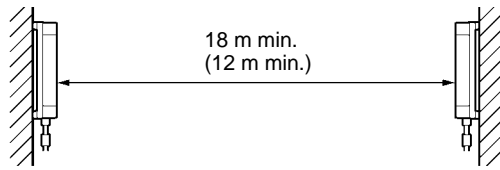

V700-H02

Located Face-to-face

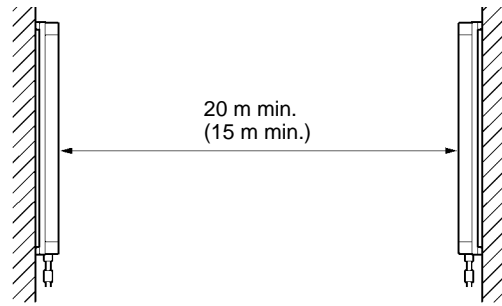

Located in Parallel

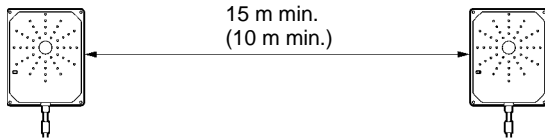

Located in Parallel

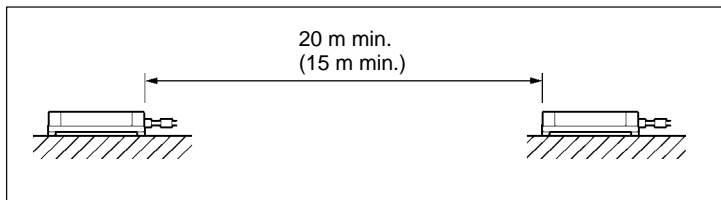
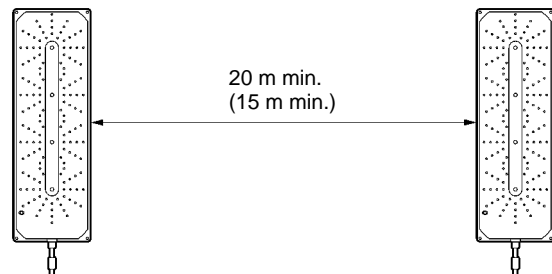

Values in parentheses are applicable in stable communications mode.

# 8-7 Mutual Interference between Proximity Sensor and Antenna

The V700 Series employs electromagnetic induction at a frequency of 125 kHz. Therefore, if the Antenna and proximity sensor are installed close to each other, the Antenna and proximity sensor may malfunction due to mutual interference. The Antenna and proximity sensor will most probably operate without malfunctioning if they are kept away from each other as shown below. However, be sure to conduct a test to make sure that they operate normally, before they are put in actual operation.

## V700-H01

Keep them away from each other as shown below.

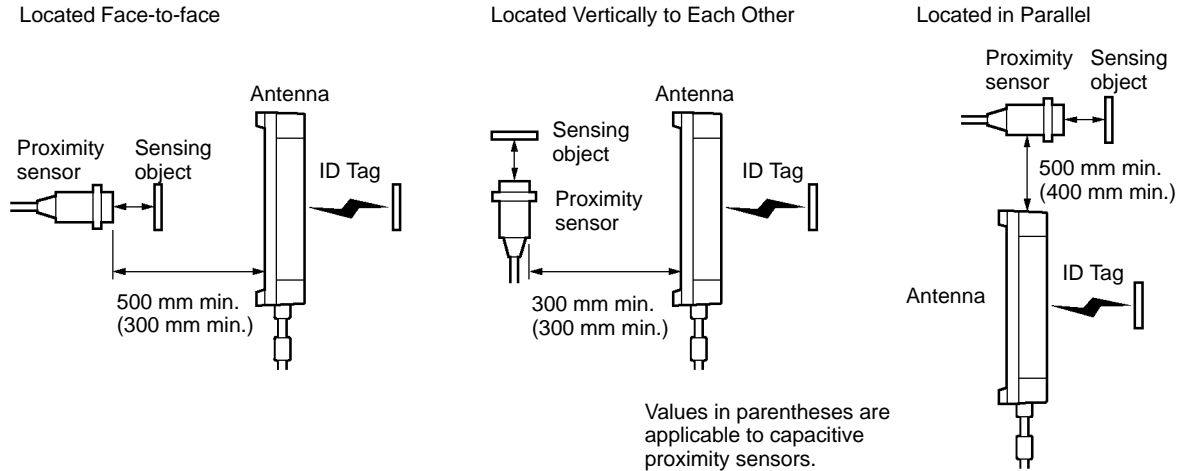

## V700-H02

Keep them away from each other as shown below.

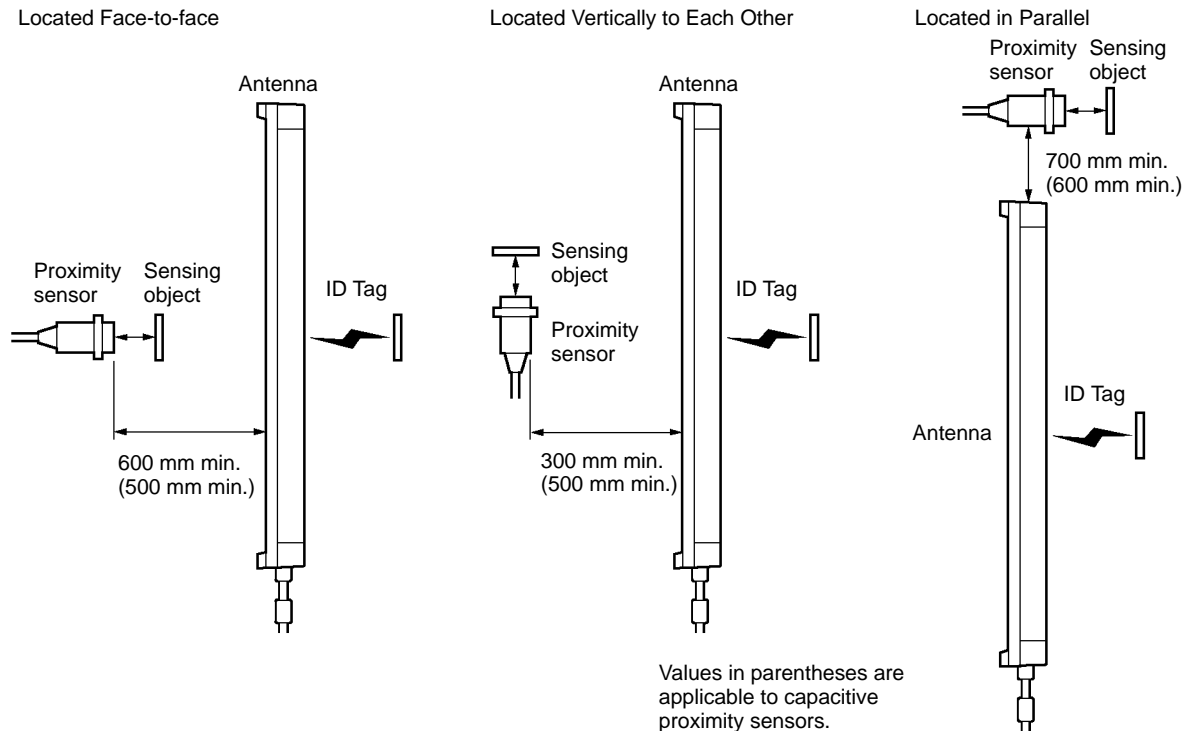



### 8-8 Influence of Background Metal on ID Tag

The ID Tag is influenced by background metal.

The communications distance of the ID Tag will decrease if there is metal behind the ID Tag as shown below.

#### V700-H01 (V700-D23P31)

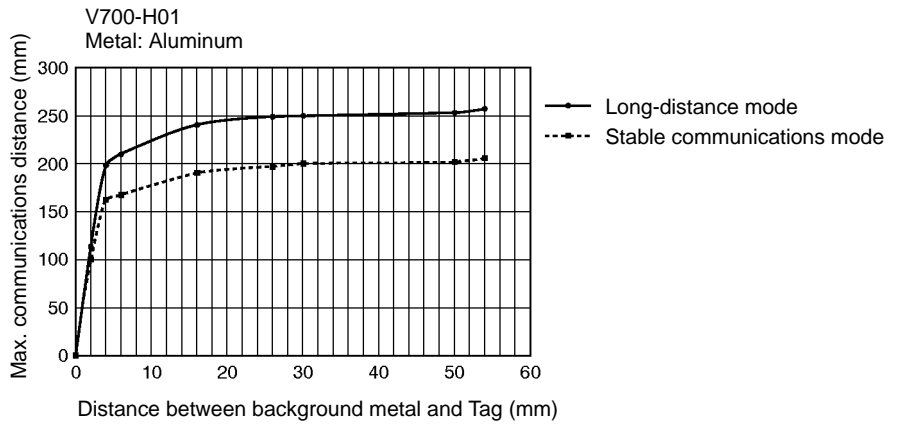
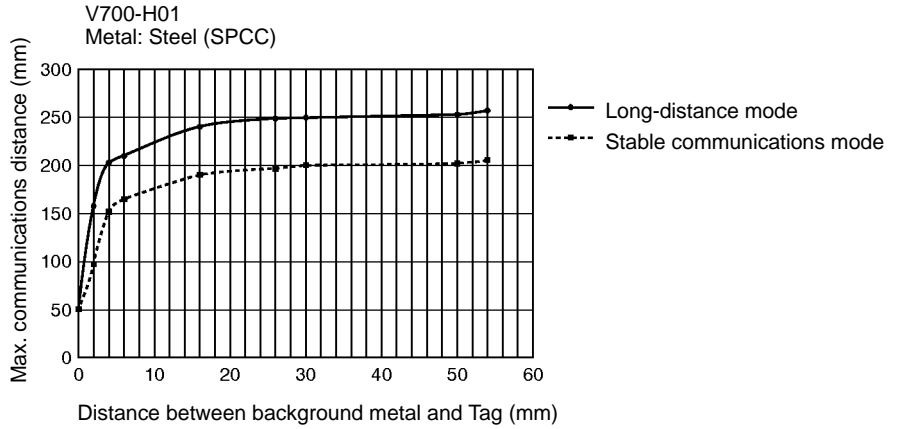

V700-H02 (V700-D23P31)

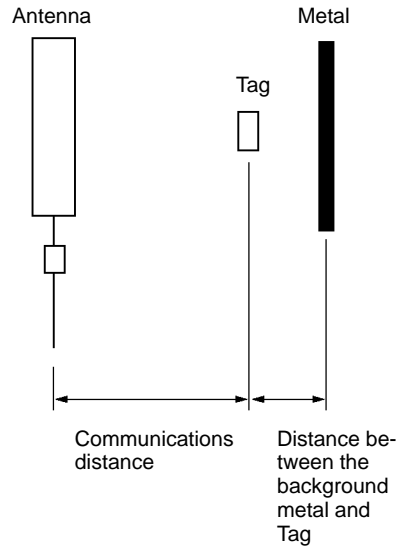
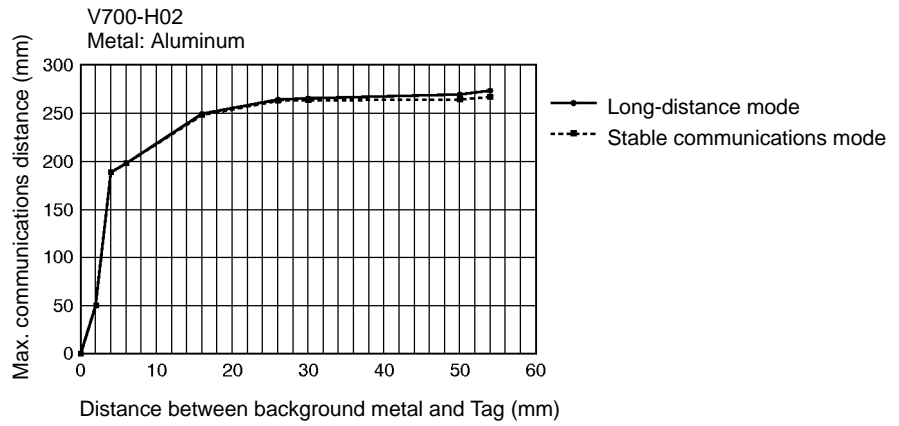
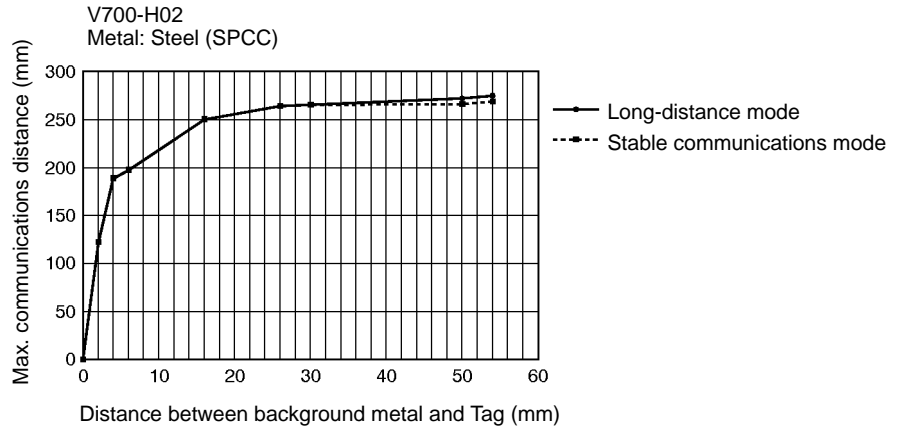

**V700-H01 (V700-D23P41)**

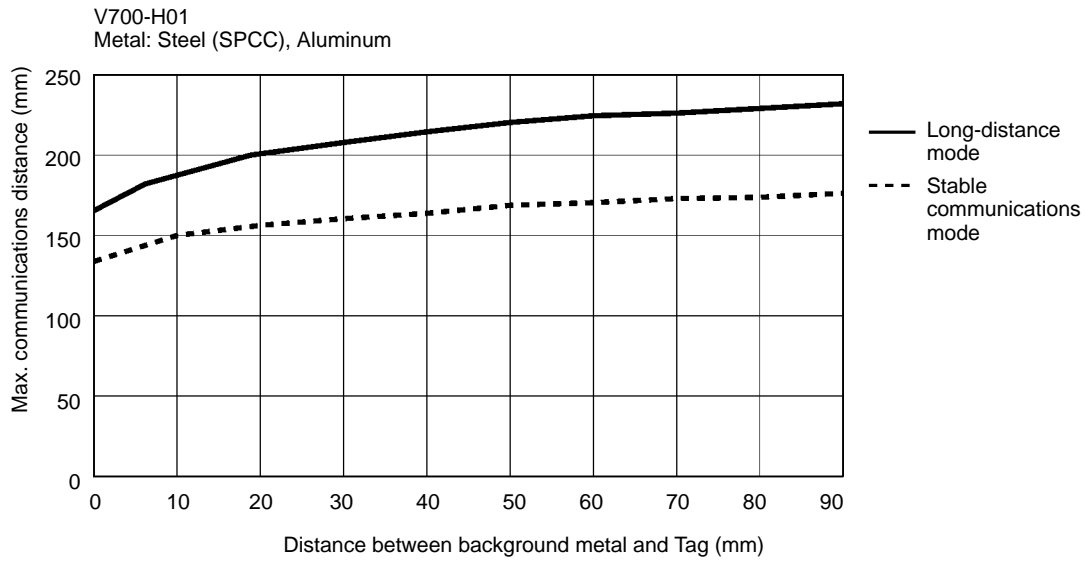

**V700-H02 (V700-D23P41)**

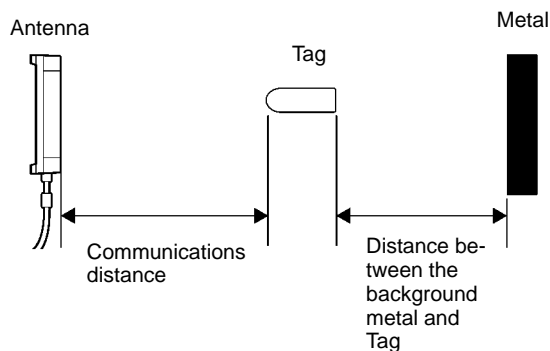
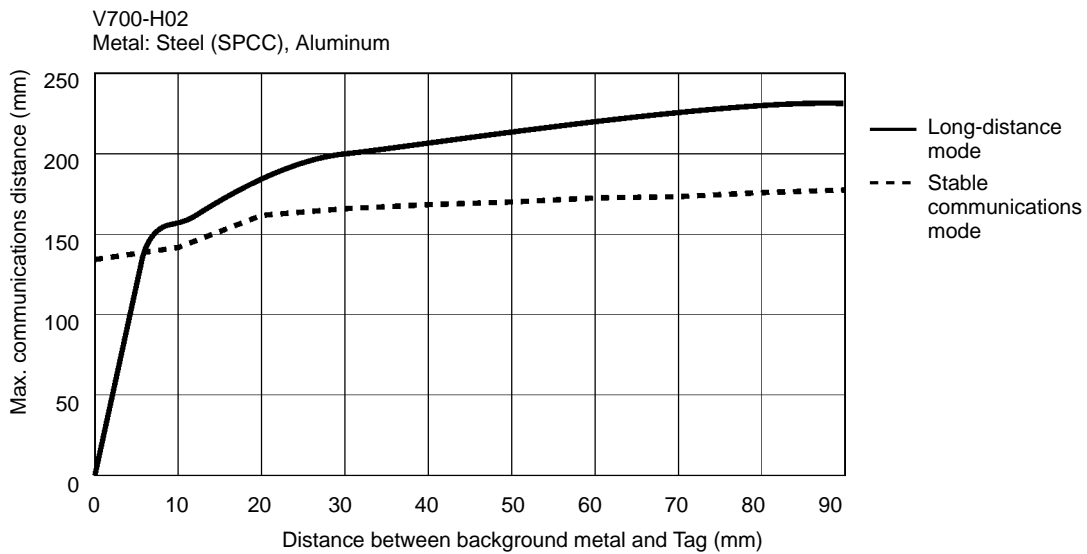

### 8-9 Influence of ID Tag Incline

When mounting an ID Tag, the maximum communications distance is obtained when the ID Tag surface is parallel with the Antenna surface. Therefore the influence of ID Tag incline must be taken into account.

If the ID Tag is mounted at an incline, the communications distance is shortened as shown in the tables below.

#### V700-D23P31

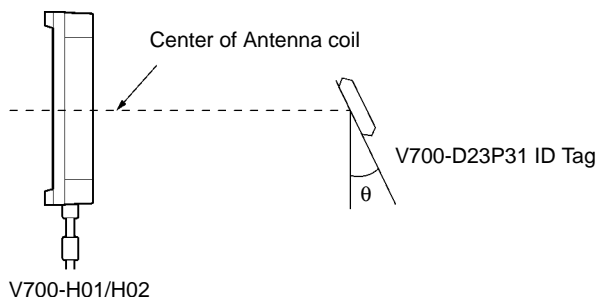

Rate of Decrease in Communications Distance

$\theta^\circ$	H01	H02
0	0%	0%
10	1%	1%
20	4%	4%
30	9%	12%
40	18%	21%
60	39%	39%

#### V700-D23P41

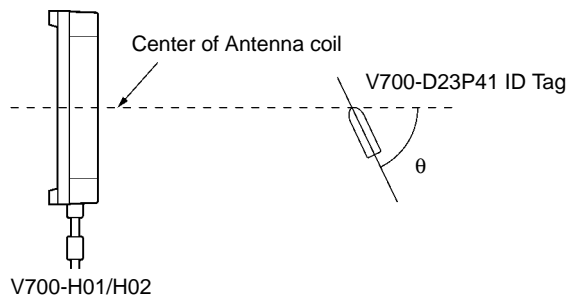

Rate of Decrease in Communications Distance

$\theta^\circ$	H01	H02
0	0%	0%
10	1.5%	1.5%
20	2.5%	3.5%
30	6.5%	10%
40	13%	18%
60	29%	31%

### 8-10 Influence of ID Tag Angle

The maximum communications distance between the Antenna and ID Tag will be available if the Antenna and ID Tag are located in parallel to each other. Take the angle of the ID Tag into consideration when mounting the ID Tag. The communications distance will be reduced if the ID Tag is not located in parallel to the Antenna as shown below.

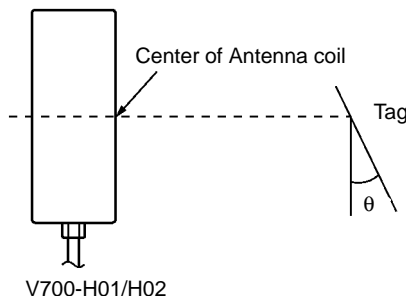

Reduction of  
Communications  
Distance

$\theta^\circ$	H01	H02
0	0%	0%
10	1%	1%
20	4%	4%
30	9%	12%
40	18%	21%
60	39%	39%

## 8-11 Chemical Resistance of ID Tag

The V700-D23P31 ID Tag uses PPS resin. Refer to the following and be sure not to use any chemical that has a bad influence on PPS resin.

Chemical		Room temperature	90°C	Chemical		Room temperature	90°C
Hydrochloric acid	37%	A	A	Sodium dichromate solution		A	A
	10%	A	A	Phenol solution	5%	A	A
Sulfuric acid	98%	A	B	Glacial acetic acid		A	A
	50%	A	A	Acetic acid		A	A
	30%	A	A	Oleate		A	A
	3%	A	A	Methanol (Methyl alcohol)	95%	A	A
Nitric acid	60%	B	C	Methanol (Methyl alcohol)	95%	A	A
	40%	A	B	Acetic ether		A	A
	10%	A	A	Diethyl hexyl sebacate		A	A
Hydrogen fluoride aqueous solution	40%	A	A	Acetone		A	A
Chromic acid	40%	A	A	Diethyl ether		A	A
Hydrogen peroxide aqueous solution	28%	A	B	n-heptane		A	A
	3%	A	A	2, 2, 4 trimethyl pentane		A	A
NaOH aqueous solution	60%	A	A	Benzene		A	A
	10%	A	A	Toluene		A	A
	1%	A	A	Aniline		A	A
Aqueous ammonia	28%	A	B	Mineral oil		A	A
	10%	A	B	Gasoline		A	A
Sodium chloride	10%	A	A	Insulation oil		A	A
Sodium carbonate	20%	A	A	Dichloroethylene		A	A
	2%	A	A	Carbon tetrachloride		A	A

- Note**
1. A: No influence  
B: May discolor or melt PPS resin  
C: Deform or cracks PPS resin
  2. The table provides information on changes in PS resin that are kept in the chemical at room temperature and 90°C. If the actual operating conditions of the system is different from the table data in temperature, chemical type, or chemical viscosity, conduct a test under the actual conditions before the system goes into actual operation.
  3. The V700-D13P21 ID Tag is not chemical, oil, or water resistant.

## 8-12 Relationship between ID Tag and Metal Sensor

If a metal sensor is used for the detection of metal objects and each object is on a non-metal base attached with the V700-D23P31 or V700-D13P21 ID Tag, the ID Tag will not affect the metal sensor in sensing operation. This cannot be done with conventional tags because they are detectable by the metal sensor.

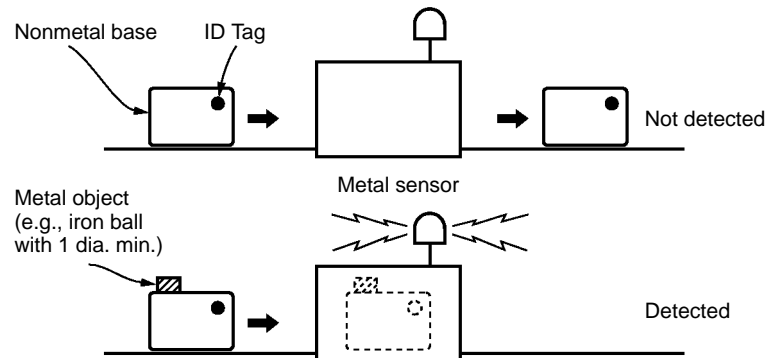

The ID Tag will not be detected by the metal sensor if its sensitivity is set to a normal level (i.e., the sensitivity is set for the detection of iron balls each of which is 1 mm or more in diameter). The ID Tag will not have a negative influence on the functions of the metal sensor, either.

If the sensitivity of the metal sensor is set to a high level (i.e., the sensitivity is set for the detection of iron balls that are 0.5 mm each in diameter) or the metal sensor can detect non-ferrous metals, the metal sensor may detect ID Tags that are too close to one another. It is recommended that a test be conducted before actual operation of the system.

# Appendix A

## ASCII Code

Rightmost 4 bits Leftmost 4 bits	b8 to b5	0000	0001	0010	0011	0100	0101	0110	0111	1000	1001	1010	1011	1100	1101	1110	1111				
	b4 to b1 Row Line	0	1	2	3	4	5	6	7	8	9	10	11	12	13	14	15				
	0	NUL	TC <sub>7</sub> (DLE)	(SP)	0	@	P	`	p	↑	↑	Unde- fined	ー	タ	ミ	↑	↑				
	1	TC <sub>1</sub> (SOH)	DC <sub>1</sub>	!	1	A	Q	a	q	↑	↑	。	ア	チ	ム	↑	↑				
	2	TC <sub>2</sub> (STX)	DC <sub>2</sub>	"	2	B	R	b	r	↑	↑	「	イ	ツ	メ	↑	↑				
	3	TC <sub>3</sub> (ETX)	DC <sub>3</sub>	#	3	C	S	c	s	↑	↑	」	ウ	テ	モ	↑	↑				
	4	TC <sub>4</sub> (EOT)	DC <sub>4</sub>	\$	4	D	T	d	t	↑	↑	、	エ	ト	ヤ	↑	↑				
	5	TC <sub>5</sub> (ENQ)	TC <sub>8</sub> (NAK)	%	5	E	U	e	u	↑	↑	.	オ	ナ	ユ	↑	↑				
	6	TC <sub>6</sub> (ACK)	TC <sub>9</sub> (SYN)	&	6	F	V	f	v	↑ Undefined	↑ Undefined	ヲ	カ	ニ	ヨ	↑ Undefined	↑ Undefined				
	7	BEL	TC <sub>10</sub> (ETB)	'	7	G	W	g	w			↑	↑	ァ	キ			ヌ	ラ	↑	↑
	8	FE <sub>0</sub> (BS)	CAN	(	8	H	X	h	x			↑	↑	ィ	ク			ネ	リ	↑	↑
	9	FE <sub>1</sub> (HT)	EM	)	9	I	Y	i	y	↑	↑	ウ	ケ	ノ	ル	↑	↑				
	10	FE <sub>2</sub> (LF)	SUB	*	:	J	Z	j	z	↑	↑	エ	コ	ハ	レ	↑	↑				
	11	FE <sub>3</sub> (VT)	ESC	+	;	K	[	k	{	↑	↑	オ	サ	ヒ	ロ	↑	↑				
	12	FE <sub>4</sub> (FF)	IS <sub>4</sub> (FS)	,	<	L	¥			↑	↑	ヤ	シ	フ	フ	↑	↑				
	13	FE <sub>5</sub> (CR)	IS <sub>3</sub> (GS)	-	=	M	]	m	}	↑	↑	ユ	ス	ヘ	ン	↑	↑				
	14	S0	IS <sub>2</sub> (RS)	.	>	N	^	n	~	↑	↑	ヨ	セ	ホ	。	↑	↑				
	15	S1	IS <sub>1</sub> (US)	/	?	O	_	o	DEL	↓	↓	ッ	ソ	マ	。	↓	↓ Unde- fined				

**Note** The character in row 5, line 12 is “\” in ASCII.







# Appendix B

## Standard Models

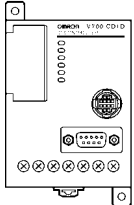
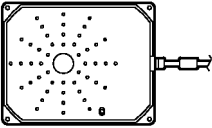
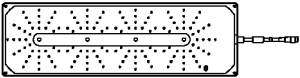
### Controller and System Components

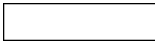
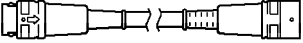
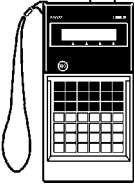
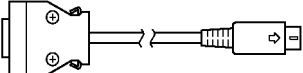
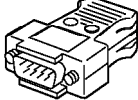
Name	Specification	Model	Remarks
Controller 	RS-232C interface Supply voltage: 24 VDC	V700-CD1D	---
Antenna 	External dimensions: 250 x 200	V700-H01	Standard antenna
Antenna 	External dimensions: 650 x 200	V700-H02	Wide-field antenna
ID Tag 	256-byte memory (240 bytes are available to the user)	V700-D23P31	Coin-shaped, environment-resistant model
ID Tag 	128-byte memory (112 bytes are available to the user)	V700-D13P21	Thin model
ID Tag 	256-byte memory (240 bytes are available to the user)	V700-D23P41	Bar-shaped
Connection Cable 	2 m	V700-A40	Used for connecting the Controller and Antenna.
	3 m	V700-A41	
	5 m	V700-A42	
	10 m	V700-A43	
	20 m	V700-A44	
	30 m	V700-A45	
Programming Console 	---	C200H-PRO27-E	---
Programming Console Conversion Cable 	2 m	V700-P10	A dedicated keysheet is provided.
Communications Connector 	Connector Plug	XM2A-0901	One set is provided with the V700-CD1D.
	Connector Hood	XM2S-0911	



# Index

## A–B

ACK/NACK control, 73

Antenna

- dimensions, 14
- effect of nearby metal, 131
- installation, 52
- interference between antennas, 134
- interference with Proximity Sensors, 136
- specifications, 13

Antenna Cable, 39

Antenna Connector, 39

Antenna Port, 9

ASCII code, table, 143

automatic mode, 61

Baud Rate Setting, 36

BCC calculation, example, 72

## C

C200H PC, connecting, 46

Cable

- dimensions, 20
- specifications, 19

characteristics, 2

chemicals, effects on ID Tags, 141

command set

- ADD, 76
- MEMORY CALCULATE, 80
- MEMORY CHECK, 79
- POLLING AUTOREAD, 78
- POLLING AUTOWRITE, 79
- READ, 74
- RESET, 85
- STOP, 85
- SUBTRACT, 77
- TEST, 86
- WRITE, 75
- WRITE PROTECT, 82

commands

- command list, 69
- frame structure, 67

communications

- commands and responses, 58
- communication modes, 24
- communications areas, 125
- communications time, 129
- errors, 112
- external, 20
- frame structure, 67
- max. distance, 122
- troubleshooting, 117, 118

V700, 20

communications areas, 125

Communications Connector, assembly, 47

Communications Distance Setting, 35

Communications Mode Setting, 77

Communications Sync Setting, 35

communications time, 129

computer, connecting, 46

Controller

- dimensions, 13
- Nomenclature, 8
- operating condition, 59
- specifications, 10
- standard models, 145

## D

data code designation, 70

Data Length Setting, 37

dimensions

- Antenna, 14
- Cable, 20
- Controller, 13
- ID Tag, 17
- Programming Console, 92

DIP switch, 9

- settings, 33, 35

## E–H

energy-saving mode, 28

error log, 29

- reading from Programming Console, 106

errors

- communications errors, 112
- diagnosing errors, 111
- due to noise, 113
- list of errors, 111
- troubleshooting, 115

FIFO Read/Write Mode, 24, 58

ground terminal, 41

HEX code, 71

Host Communications, troubleshooting, 117

## I–L

ID Tag  
communications modes, 58  
dimensions, 17  
effect of nearby metal, 137  
effects of chemicals, 141  
installation, 54  
orientation, 140  
specifications, 16

indicators, LED indicators, 9

inspection, 113

installation  
Antenna, 52  
DIN track, 39  
enclosed, 38  
environment, 37, 52

interference  
from a Proximity Sensor, 136  
from another antenna, 134  
from metal, 131, 137

Long–distance Mode, 28

Low Power Consumption Setting, 35

## M

maintenance, 113

metal sensors, 142

Multiple, Simultaneous Access Mode, 24, 59

mutual interference, prevention, 26

## N

node number settings, 33, 34

Node number switch, 9

noise  
effect on communications distance, 123  
measuring, 29  
preventing, 43, 53, 113

nomenclature, Controller, 8

nomenclature, Programming Console, 92

## O

operation  
outline of operation, 6  
trial operation, 110

options, list, 70

## P

Parity Bit Setting, 37

polling auto mode, 63

power consumption, reducing, 28

Power supply terminals, 9

power supply terminals, 41

precautions, general, xiii

Programming Console  
checking noise conditions, 105  
connection, 93  
dimensions, 92  
displaying data, 100  
functions, 96  
monitoring operation, 107  
nomenclature, 92  
operation, 95  
reading error log, 106  
reading/writing data, 102  
setting addresses, 101  
setting data, 102  
testing communications, 104

Programming Console port, 9

Proximity Sensor, interference with Antennas, 136

## R

reference data, 121

repeat mode, 61

RESET Signal, wiring, 44

RESET terminals, 9  
circuit configuration, 10

response codes, 87

responses  
frame structure, 67  
response codes, 87

RS–232C, interface, 45

RS–232C interface, 4

RS–485 interface, 5

RS–232C port, 9

## S

serial interface, 4, 45

Single Mode, 24, 58

specifications  
Antenna, 13  
Cable, 19  
Controller, 10  
ID Tag, 16

Stable Communications Mode, 28

standard models, 145

Stop Bit Length Setting, 37  
subcommand set  
  ACK, 86  
  NACK, 86  
  POLLING CHECK, 84  
  POLLING END, 84  
switch settings, 32  
SYNC Signal, wiring, 44  
SYNC terminals, 9  
  circuit configuration, 11  
synchronous function, 26  
system configuration, 4

## **T–W**

Time-out Setting, 37  
  
trial operation, 110  
  
trigger mode, 60  
  
troubleshooting, 115  
  
wiring, Controller, 12, 41



## Revision History

A manual revision code appears as a suffix to the catalog number on the front cover of the manual.

Cat. No. Q113-E1-07

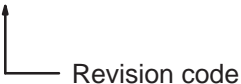

The following table outlines the changes made to the manual during each revision. Page numbers refer to the previous version.

Revision code	Date	Revised content
1	July 1998	Original production
02	August 2003	<b>Page v:</b> Added warranty and other PL-related information. <b>Pages 10, 13, 15, 36, and 80:</b> Changed caution symbols.
03	April 2004	<b>Page v:</b> Programmable Products information removed from the bottom of the page. <b>Page viii:</b> Information on Standard Conformity added.
04	June 2004	<b>Pages xviii, 2, 15, 16, 45, 69, 108, 121, 122, and 125:</b> ID Tag model numbers changed. <b>Pages 15 and 125:</b> Memory capacity changed. <b>Page 17:</b> First sentence and graphic changed.
05	April 2006	V700-CD1D changed to V700-CD1D-V3 and V700-CD2D-V3 added throughout the manual. V700-D23P21 changed to V700-D23P31 and V700-D23P41 added throughout the manual. <b>Page v:</b> Warranty and Limitations of Liability modified. <b>Pages 2 and 3:</b> Descriptions of characteristics added. <b>Pages 4 and 5:</b> System configuration information changed. <b>Page 8:</b> Nomenclature changed. <b>Page 15:</b> Specifications changed. <b>Page 16:</b> Dimensions for V700-D23P41 replaced. <b>Page 18:</b> Information added on V700-A80 Attachment. <b>Page 19:</b> Specifications for V700-CD2D-V3 added. <b>Page 23:</b> Information added on write protect and memory protect functions. <b>Pages 31 and 32:</b> DIP switch settings changed. <b>Page 41:</b> Information added on RS-232C interface. <b>Page 43:</b> Information added on RS-485 interface. <b>Page 45:</b> Information added on mounting ID Tags. <b>Page 49:</b> Information added on commands and ID Tags. <b>Page 50:</b> Information changed on single trigger mode. <b>Page 51:</b> Information changed on single automatic mode. <b>Page 51:</b> Information changed on repeat mode. <b>Page 53:</b> Information changed on polling auto mode. <b>Page 54:</b> Information added on multi-trigger and multi-repeat modes. <b>Page 54:</b> Information added on selective access mode. <b>Page 55:</b> Headings changed (BCC). <b>Pages 57 and 58:</b> Information on data codes added. <b>Pages 109 to 111:</b> Information on communications areas added. <b>Page 116:</b> Information on influence of background metal added. <b>Page 120:</b> Information on influence of ID Tag incline added.
06	May 2008	<b>Page xvi:</b> Added V700-H01. <b>Pages 2, 4 to 6, 8, 12, 13, 39, 41, 43, 44, and 145:</b> Removed CE mark from product diagram.
07	April 2012	<b>Page 54:</b> Information changed on Recommended Adhesive. <b>Page 55:</b> Information changed on Recommended Adhesive.



**OMRON Corporation**  
Industrial Automation Company

**Sensing Devices Division H.Q.**  
**Industrial Sensors Division**  
Shiokoji Horikawa, Shimogyo-ku,  
Kyoto, 600-8530 Japan  
Tel: (81)75-344-7022/Fax: (81)75-344-7107

**Regional Headquarters**

**OMRON EUROPE B.V.**  
**Sensor Business Unit**  
Carl-Benz-Str. 4, D-71154 Nufringen,  
Germany  
Tel: (49) 7032-811-0/Fax: (49) 7032-811-199

**OMRON ELECTRONICS LLC**  
One Commerce Drive Schaumburg,  
IL 60173-5302 U.S.A.  
Tel: (1) 847-843-7900/Fax: (1) 847-843-7787

**OMRON ASIA PACIFIC PTE. LTD.**  
No. 438A Alexandra Road # 05-05/08 (Lobby 2),  
Alexandra Technopark, Singapore 119967  
Tel: (65) 6835-3011/Fax: (65) 6835-2711

**OMRON (CHINA) CO., LTD.**  
Room 2211, Bank of China Tower,  
200 Yin Cheng Zhong Road,  
PuDong New Area, Shanghai, 200120, China  
Tel: (86) 21-5037-2222/Fax: (86) 21-5037-2200

**Authorized Distributor:**