

**SYSMAC CJ-series
CJ1W-CTL41-E**

4-Channel Counter Unit



OPERATION MANUAL

OMRON

Notice:

OMRON products are manufactured for use according to proper procedures by a qualified operator and only for the purposes described in this manual.

The following conventions are used to indicate and classify precautions in this manual. Always pay attention to the information provided with them. Failure to comply with the precautions can result in injury to people or damage to the product.

 DANGER	Indicates an imminently hazardous situation which, if not avoided, will result in death or serious injury.
 WARNING	Indicates a potentially hazardous situation which, if not avoided, could result in death or serious injury.
 Caution	Indicates an potentially hazardous situation which, if not avoided, may result in minor or moderate injury, or property damage.

OMRON Product References

All OMRON products are capitalised in this manual. The word “Unit” is also capitalised when it refers to an OMRON product, regardless of whether or not it appears in the proper name of the product.

The abbreviation “Ch,” which appears in some displays and on some OMRON products, often means “word” and is abbreviated “Wd” in documentation in this sense.

The abbreviation “PLC” means Programmable Logic Controller and is not used as an abbreviation for anything else.

Visual Aids

The following headings appear in the left column of the manual to help you locate different types of information.

Note	Indicates information of particular interest for efficient and convenient operation of the product.
1, 2, 3...	Indicates lists of one sort or another, such as procedures, checklists, etc.

© OMRON, 2004

All rights reserved. No part of this publication may be reproduced, stored in a retrieval system, or transmitted, in any form, or by any means, mechanical, electronic, photocopying, recording, or otherwise, without the prior written permission of OMRON.

No patent liability is assumed with respect to the use of the information contained herein. Moreover, because OMRON is constantly striving to improve its high-quality products, the information contained in this manual is subject to change without notice. Every precaution has been taken in the preparation of this manual. Nevertheless, OMRON assumes no responsibility for errors or omissions. Neither is any liability assumed for damages resulting from the use of the information contained in this publication.

TABLE OF CONTENTS

PRECAUTIONS	ix
1 Intended Audience	x
2 General Precautions	x
3 Safety Precautions	x
4 Operating Environment Precautions	xi
5 Application Precautions	xii
6 EC Directives	xv
SECTION 1	
Introduction	1
1-1 Features and Functions	2
1-2 Basic Configuration	4
1-3 Specifications and Characteristics	5
1-4 Quick Start Up Reference Guide	9
1-5 Operating Procedure Guidelines	11
1-6 Application Areas	13
SECTION 2	
Components, Installation and Wiring	15
2-1 Components and Switch Settings	16
2-2 Installation	19
2-3 Wiring	21
SECTION 3	
Operation and Configuration	27
3-1 Overview	28
3-2 Counter Types	29
3-3 Input Signal Types	33
3-4 Controlling a Counter	36
3-5 Output Control	38
3-6 Reset Signals	53
3-7 Extra Functions	54
SECTION 4	
Exchanging Data with CPU	57
4-1 Overview	58
4-2 Memory Allocation	61
4-3 IOWR-Instruction	77
4-4 IORD-Instruction	79
4-5 Supported IOWR/IORD-Instructions	81
4-6 Interrupts	88

TABLE OF CONTENTS

SECTION 5

Error Processing, Maintenance and Inspection 91

5-1 Error Indicators 92

5-2 Error codes 93

5-3 Maintenance and Inspection 99

Appendices

A Using Input Terminal Block Units 101

B Assigning External Interrupt Tasks to Outputs 103

C Application Restrictions 105

D Comparison between CJ1W-CTL41-E and other Counter Units 107

Index 111

Revision History 115

About this Manual:

This manual describes the installation and operation of the CJ1W-CTL41-E Counter Unit and includes the sections described below. Please read this manual carefully and be sure you understand the information provided before attempting to install or operate the CJ1W-CTL41-E Counter Unit.

Be sure to read the precautions provided in the following sections.

Section 1 introduces the CJ1W-CTL41-E Counter Unit and describes the features, functions, and specifications. It gives short instructions on how to operate the Unit.

Section 2 provides information about components, wiring and installation of the CJ1W-CTL41-E Counter Unit.

Section 3 provides information about configuration and operation of the CJ1W-CTL41-E Counter Unit.

Section 4 provides information on the data-exchange and the communication interface between the CJ1W-CTL41-E Counter Unit and the PLC CPU.

Section 5 provides details of the CJ1W-CTL41-E Counter Unit's errors, error -codes and indicators and guidelines for troubleshooting.

The **Appendices** describe a comparison with CQM1-CBT41 and CJ1W-CTL41-E Counter Units, the use of Terminal Block Units, and the numbering of External Interrupt Tasks to Outputs.

All through this manual where a double word is defined as for instance "n+2, n+3" this must be interpreted as follows:

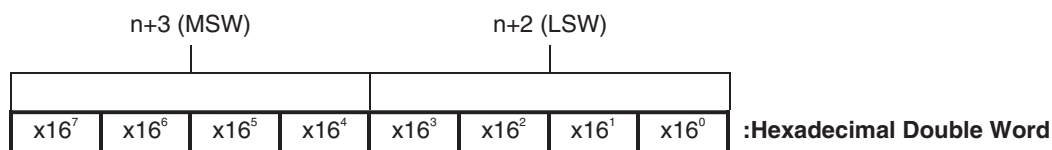
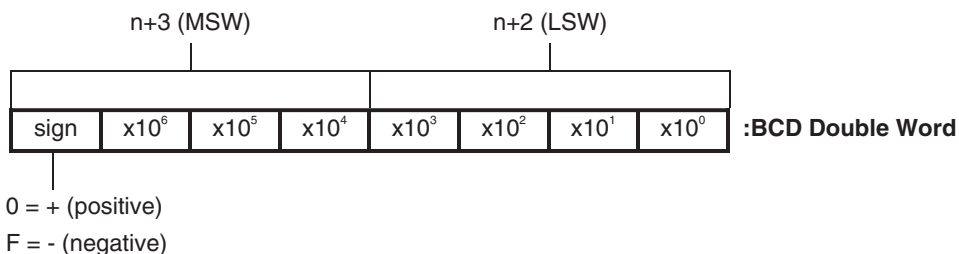

LSW = Least Significant Word

MSW = Most Significant word

WARNING

Failure to read and understand the information provided in this manual may result in personal injury or death, damage to the product, or product failure. Please read each section in its entirety and be sure you understand the information provided in the section and related sections before attempting any of the procedures or operations given.

PRECAUTIONS

This section provides general precautions for using the Programmable Controller (PLC) and the Counter Unit.

The information contained in this section is important for the safe and reliable application of the Counter Unit. You must read this section and understand the information contained before attempting to set up or operate a Counter Unit and PLC system.

1	Intended Audience	x
2	General Precautions	x
3	Safety Precautions	x
4	Operating Environment Precautions	xi
5	Application Precautions	xii
6	EC Directives	xv

1 Intended Audience

This manual is intended for the following personnel, who must also have knowledge of electrical systems (an electrical engineer or the equivalent).

- Personnel in charge of installing FA systems.
- Personnel in charge of designing FA systems.
- Personnel in charge of managing FA systems and facilities.

2 General Precautions

The user must operate the product according to the performance specifications described in the operation manuals.

Before using the product under conditions which are not described in the manual or applying the product to nuclear control systems, railroad systems, aviation systems, vehicles, combustion systems, medical equipment, amusement machines, safety equipment, and other systems, machines, and equipment that may have a serious influence on lives and property if used improperly, consult your OMRON representative.

Make sure that the ratings and performance characteristics of the product are sufficient for the systems, machines, and equipment, and be sure to provide the systems, machines, and equipment with double safety mechanisms.

This manual provides information for installing and operating OMRON Counter Units. Be sure to read this manual before operation and keep this manual close at hand for reference during operation.

WARNING







It is extremely important that a PLC and all PLC Units be used for the specified purpose and under the specified conditions, especially in applications that can directly or indirectly affect human life. You must consult with your OMRON representative before applying a PLC system to the above mentioned applications.

3 Safety Precautions



WARNING

The CPU Unit refreshes I/O even when the program is stopped (i.e., even in PROGRAM mode). Confirm safety thoroughly in advance before changing the status of any part of memory allocated to I/O Units, Special I/O Units, or CPU Bus Units. Any changes to the data allocated to any Unit may result in unexpected operation of the loads connected to the Unit. Any of the following operation may result in changes to memory status.

- Transferring I/O memory data from a Programming Device to the CPU Unit.
- Changing present values in memory with a Programming Device.
- Force-setting/-resetting bits with a Programming Device.
- Transferring I/O memory files from a Memory Card or EM file memory to the CPU Unit.
- Transferring I/O memory from a host computer or from another PLC on a network.

-  **WARNING** Do not attempt to take any Unit apart while the power is being supplied. Doing so may result in electric shock.
-  **WARNING** Do not touch any of the terminals or terminal blocks while the power is being supplied. Doing so may result in electric shock.
-  **WARNING** Do not attempt to disassemble, repair, or modify any Units. Any attempt to do so may result in malfunction, fire, or electric shock.
-  **Caution** Execute online edit only after confirming that no adverse effects will be caused by extending the cycle time. Otherwise, the Input signals may not be readable.
-  **Caution** Confirm safety at the destination node before transferring a program to another node or changing contents of the I/O memory area. Doing either of these without confirming safety may result in injury.
-  **Caution** Tighten the screws on the terminal block of the AC Power Supply Unit to the torque specified in the operation manual. Loose screws may result in burning or malfunction.

4 Operating Environment Precautions

-  **Caution** Do not operate the control system in the following locations:
- Locations subject to direct sunlight.
 - Locations subject to temperatures or humidity outside the range specified in the specifications.
 - Locations subject to condensation as the result of severe changes in temperature.
 - Locations subject to corrosive or flammable gases.
 - Locations subject to dust (especially iron dust) or salts.
 - Locations subject to exposure to water, oil, or chemicals.
 - Locations subject to shock or vibration.
-  **Caution** Take appropriate and sufficient countermeasures when installing systems in the following locations:
- Locations subject to static electricity or other forms of noise.
 - Locations subject to strong electromagnetic fields.
 - Locations subject to possible exposure to radioactivity.
 - Locations close to power supplies.
-  **Caution** The operating environment of the PLC System can have a large effect on the longevity and reliability of the system. Improper operating environments can lead to malfunction, failure, and other unforeseeable problems with the PLC System. Be sure that the operating environment is within the specified conditions at installation and remains within the specified conditions during the life of the system.

5 Application Precautions

Observe the following precautions when using the Counter Unit or the PLC.

WARNING

Failure to comply with the following precautions could lead to serious or possibly fatal injury. Always follow these precautions.

- Always ground the system with 100 Ω or less when installing the system, to protect against electrical shock.
- Always turn OFF the power supply to the PLC before attempting any of the following. Performing any of the following with the power supply turned ON may lead to electrical shock
- Mounting or removing any Units (e.g., I/O Units, CPU Unit, etc.) or memory cassettes.
- Assembling any devices or racks.
- Connecting or disconnecting any connectors, cables or wiring.
- Setting DIP switch or rotary switches.

Caution

Failure to comply with the following precautions could lead to faulty operation of the PLC or the system, or could damage the PLC or PLC Units. Always follow these precautions.

- Fail-safe measures must be taken by the customer to ensure safety in the event of incorrect, missing, or abnormal signals caused by broken signal lines, momentary power interruptions, or other causes.
- Interlock circuits, limit circuits, and similar safety measures in external circuits (i.e., not in the Programmable Controller) must be provided by the customer.
- If the IOM Hold Bit is turned ON, the outputs from the PLC will not be turned OFF and will maintain their previous status when the PLC is switched from RUN or MONITOR mode to PROGRAM mode. Make sure that the external loads will not produce dangerous conditions when this occurs. (When operation stops for a fatal error, including those produced with the FALS instruction, all outputs from Output Unit will be turned OFF and only the internal output status will be maintained.)
- Use the Units only with the power supplies and voltages specified in the operation manuals. Other power supplies and voltages may damage the Units.
- Take appropriate measures to ensure that the specified power with the rated voltage and frequency is supplied. Be particularly careful in places where the power supply is unstable. An incorrect power supply may result in malfunction.
- Install external breakers and take other safety measures against short-circuiting in external wiring. Insufficient safety measures against short-circuiting may result in burning.
- Do not apply voltages to Input sections in excess of the rated Input voltage. Excess voltages may result in burning.
- Do not apply voltages or connect loads in excess of the maximum switching capacity to output sections. Excess voltage or loads may result in burning.

 **Caution**

- Install the Units properly as specified in the operation manuals. Improper installation of the Units may result in malfunction.
- Be sure that all the mounting screws, terminal screws, and cable connector screws are tightened to the torque specified in the relevant manuals. Incorrect tightening torque may result in malfunction.
- Leave the label attached to the Unit when wiring. Removing the label may result in malfunction if foreign matter enters the Unit.
- Remove the label after the completion of wiring to ensure proper heat dissipation. Leaving the label attached may result in malfunction.
- Use crimp terminals for wiring. Do not connect bare stranded wires directly to terminals. Connection of bare stranded wires may result in burning.
- Double-check all the wiring and the connectors before turning ON the power supply. Incorrect wiring or bad connections may result in burning or malfunction.
- Be sure that the terminal blocks, Memory Units, expansion cables, and other items with locking devices are properly locked into place. Improper locking may result in malfunction.
- Check switch settings, the contents of the DM Area, and other preparations before starting operation. Starting operation without the proper settings or data may result in an unexpected operation.
- Check the user program for proper execution before actually running it on the Unit. Not checking the program may result in an unexpected operation.
- Confirm that no adverse effect will occur in the system before attempting any of the following. Not doing so may result in an unexpected operation.
 - Changing the operating mode of the PLC.
 - Force-setting/force-resetting any bit in memory.
 - Changing the present value of any word or any set value in memory.
- Do not pull on the cables or bend the cables beyond their natural limit. Doing either of these may break the cables.
- Do not place objects on top of the cables or other wiring lines. Doing so may break the cables.
- When replacing parts, be sure to confirm that the rating of a new part is correct. Not doing so may result in malfunction or burning.
- Before touching a Unit, be sure to first touch a grounded metallic object in order to discharge any static built-up. Not doing so may result in malfunction or damage.
- Do not touch circuit boards or the components mounted to them with your bare hands. There are sharp leads and other parts on the boards that may cause injury if handled improperly.
- Provide proper shielding when installing in the following locations:
 - Locations subject to static electricity or other sources of noise.
 - Locations subject to strong electromagnetic fields.
 - Locations subject to possible exposure to radiation.
 - Locations near power supply lines.
- Do not attempt to take any Units apart, to repair any Units, or to modify any Units in any way.
- After connecting Power Supply Units, CPU Units, I/O Units, Special I/O Units, or CPU Bus Units together, secure the Units by sliding the sliders at the top and bottom of the Units until they click into place. Correct operation may not be possible if the Units are not securely properly. Be sure to attach the end cover pro-

vided with the CPU Unit to the right most Unit. CJ-series PLCs will not operate properly if the end cover is not attached.

6 EC Directives

6-1 Applicable Directives

- EMC Directives
- Low Voltage Directive

6-2 Concepts

EMC Directives

OMRON devices that comply with EC Directives also conform to the related EMC standards so that they can be more easily built into other devices or the overall machine. The actual products have been checked for conformity to EMC standards (see the following note). Whether the products conform to the standards in the system used by the customer, however, must be checked by the customer.

EMC-related performance of the OMRON devices that comply with EC Directives will vary depending on the configuration, wiring, and other conditions of the equipment or control panel on which the OMRON devices are installed. The customer must, therefore, perform the final check to confirm that devices and the overall machine conform to EMC standards.

Note Applicable EMC (Electromagnetic Compatibility) standards are as follows:
EMS (Electromagnetic Susceptibility):EN61000-6-2
EMI (Electromagnetic Interference):EN61000-6-4
(Radiated emission: 10-m regulations)
Low Voltage Directive
Always ensure that devices operating at voltages of 50 to 1,000 VAC and 75 to 1,500 VDC meet the required safety standards for the PLC (EN61131-2).

6-3 Conformance to EC Directives

6-3-1 Applicable Directives

- EMC Directives
- Low voltage directive

6-3-2 Concepts

EMC Directives

OMRON Units complying with EC Directives also conform to related EMC standards making them easier to incorporate in other Units or machines. The actual products have been checked for conformity to EMC standards. (See the following note.) Whether the products conform to the standards in the system used by the customer, however, must be checked by the customer.

EMC-related performance of OMRON Units complying with EC Directives will vary depending on the configuration, wiring, and other conditions of the equipment or control panel in which OMRON devices are installed. The customer must, therefore, perform final checks to confirm that units and the overall system conforms to EMC standards.

Note Applicable EMS (Electromagnetic Susceptibility) and EMI (Electromagnetic Interference) standards in the EMC (Electromagnetic Compatibility) standards are as follows:

Unit	EMS	EMI
CJ1W-CTL41-E	EN 61000-6-2:2001	EN 61000-6-4:2001

6-3-3 Conformance to EC Directives

Units that meet EC directives also meet the common emission standard (EN61000-6-4). The measures necessary to ensure that the standard is met will vary with the overall configuration. You must therefore confirm that EC directives are met for the overall configuration, particularly any radiated emission requirement (10 m).

SECTION 1

Introduction

This section gives specifications of the CJ1W-CTL41-E and a brief description of the functions and features of the Unit and the areas of application.

1-1	Features and Functions	2
1-2	Basic Configuration	4
1-3	Specifications and Characteristics	5
1-3-1	General Specifications	5
1-3-2	Functional Specifications	6
1-3-3	Input Specifications	7
1-4	Quick Start Up Reference Guide	9
1-4-1	Configuring the Counter Unit	10
1-5	Operating Procedure Guidelines	11
1-6	Application Areas	13

1-1 Features and Functions

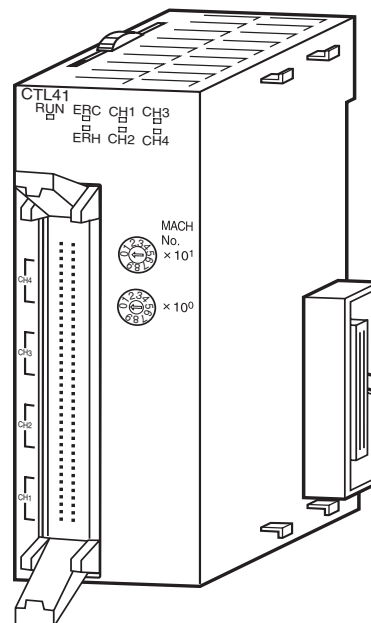

CJ1W-CTL41-E

The CJ1W-CTL41-E, a Special I/O Unit for CJ-series PLC-systems, is a freely configurable Counter Unit. Depending on the requirements of your application, the specific behaviour of the Unit can be adjusted by changing the configuration settings.

CJ1W-CTL41-E Counters

The CJ1W-CTL41-E Counter Unit is equipped with 4 Counters and counts over a maximum binary range of 32-bits. Accepting input pulse frequencies of up to 100 kHz allows precise control of fast motions. The Unit's bi-directional counting ability allows movement detecting in either direction. Each Counter of the Unit can be configured independently. The Unit is equipped with 32 Software Outputs, each of which can be linked to Counter events. The Unit can generate interrupts to the PLC CPU, to allow immediate CPU action upon Counter events.

Counter Type

Configuring the Unit starts with choosing one out of two Counter Types:

- Circular Counter (refer to section 3-2-1 *Circular Counter*)
- Linear Counter (refer to section 3-2-2 *Linear Counter*)

By default each Counter is set to Circular Counter. For all Counter Types the full counting range is available. Circular and Linear Counters can be fully (DM-) configured according to the application that is to be controlled.

Input Signal Type

Depending on the type of input signal your application requires, every Counter allows a choice out of three input signal types:

- Phase Differential Inputs (multiplication by either 1, 2 or 4) (refer to section 3-3-1 *Phase Differential*)
- Up/Down Pulse Inputs (refer to section 3-3-2 *Up & Down*)
- Pulse & Direction Inputs (refer to section 3-3-3 *Pulse & Direction*)

Output Control Modes

To control the Software Outputs the Unit can be configured in one of the two following Output Control Modes:

- Range Mode (refer to section 3-5-1 *Range Mode*)
- Comparison Mode (refer to section 3-5-2 *Comparison Mode*)

In Range Mode, a configurable number of up to 4 Ranges can be applied to individual Counters. Every Range can control up to a maximum of 32 Soft-

ware Outputs. An Output is turned ON when the Counter is in the corresponding Range.

In Comparison Mode a configurable number of up to 8 Comparison Values can be applied to individual Counters. Depending on the direction of counting, an Output can be set or reset (configurable) on reaching the Comparison Value. Every Comparison Value can control up to maximum 32 Outputs.

Resetting Counter Value

Resetting of the Counter Value can be configured depending on the application needs. The following sources can trigger a reset:

- CIO bit in the PLC
- Z-Input

To enable resetting a Counter Value, the Software Enable Reset bit can be used (refer to section 3-6 *Reset Signals*).

Hysteresis

For Counters in Range Mode a hysteresis can be configured [1 to 255 counts], to prevent Outputs from toggling due to unwanted oscillating of encoding equipment (e.g. rotary incremental encoder). Refer to section 3-7-1 *Hysteresis*.

Noise Filtering

For the purpose of suppressing noise on the signal lines A, B of every Counter, noise filters are provided. The cut-off frequencies for all signal lines A and B are fixed to 100 kHz.

Run-time Configurable

Configuration settings of the Unit can be changed at Run-time by using the IOWR-instruction to be able to quickly adjust to changing application needs without the need of restarting the Unit or stopping the Counters. Care, however, must be taken when changing configuration settings. Refer to section 3-5 *Output Control* for information.

Interrupt Support

All Outputs can be configured to generate interrupts to the PLC. Generating interrupts is only possible when the Counter Unit is mounted in a CPU-rack.

Support Software

The Unit can be configured by using CX-Programmer Support Software or a Programming Console.

Quick Start Up Reference Guide

For a quick overview of all the features and functions the Counter Unit offers, refer to section 1-4 *Quick Start Up Reference Guide*. This section also contains references to the particular section(s) in the Manual where more detailed information about specific features and functions of the Counter Unit can be found.

1-2 Basic Configuration

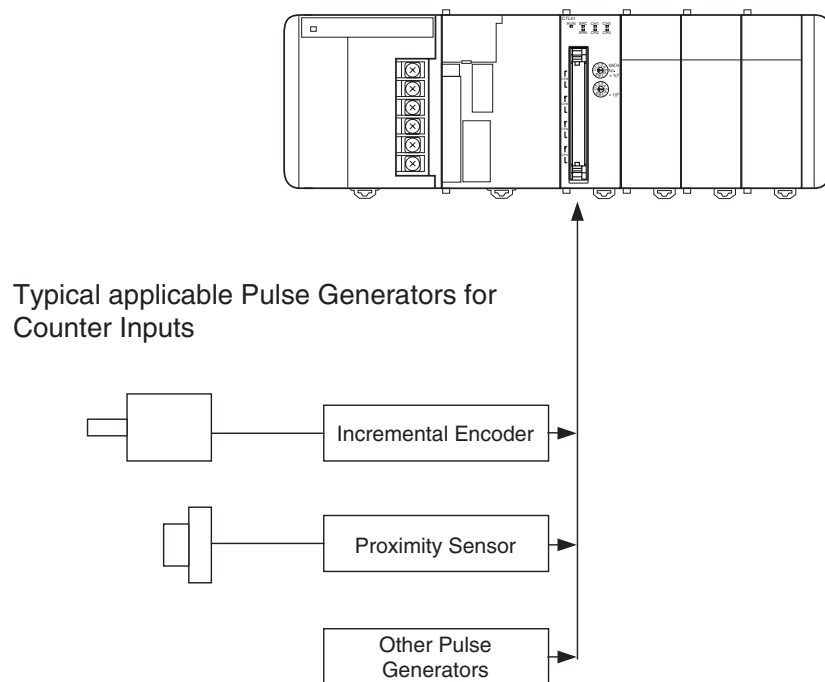

Mounting Restrictions

The CJ1W-CTL41-E Counter Unit is a Special I/O Unit belonging to the CJ Series. A CJ1W-CTL41-E Counter Unit can be mounted to either a CJ CPU Rack or CJ Expansion Rack.

- Note**
1. In case of a CJ1-H CPU Unit, the Counter Unit must be in one of the five positions immediately to the right of the CJ1-H CPU Unit on the CPU Rack, in order to allow the CJ1W-CTL41-E Counter Unit to generate interrupts which activate interrupt tasks in a CJ1-H CPU Unit.
 2. In case of a CJ1M CPU Unit, the Counter Unit must be in one of the three positions immediately to the right of the CJ1M CPU Unit on the CPU Rack, in order to allow the CJ1W-CTL41-E Counter Unit to generate interrupts which activate interrupt tasks in a CJ1M CPU Unit
 3. No interrupt tasks can be activated in CJ1-H or CJ1M CPU Units if the CJ1W-CTL41-E Counter Unit is in any other position (i.e., 6th Unit position or further away from the CJ1-H CPU Unit, or 4th Unit position or further away from the CJ1M CPU Unit), or if it is on a CJ-series Expansion Rack.

Maximum Number of CJ1W-CTL41-E Units

The maximum number of CJ1W-CTL41-E Counter Units which can be mounted to a CJ CPU Rack or CJ Expansion Rack is equal to the number of slots of the Rack. In a configuration with multiple Racks the maximum number of CJ1W-CTL41-E Counter Units is limited to 24.

Furthermore, the number of Counter Units that can be mounted to one Rack (i.e., a CPU Rack or Expansion Rack) depends on the maximum supply current from the Power Supply Unit that supplies the Rack and the current consumption of other Units on the Rack.

I/O Connection Methods

To connect the Input signal wires to the Unit two methods are available:

- Directly connecting the wires by soldering them to the external connector.
- Indirectly connecting the wires by connecting them to screwless terminals on an XW2G-40G7-E Input Terminal Block Unit. This Input Terminal Block Unit allows connection of Line Driver or 24 V Encoder signals. The XW2G-40G7-E is connected to the Unit via standard available OMRON I/O-cables (XW2Z-xxxK).
- Indirectly connecting the wires by connecting them to screw terminals on a standard XW2B-40G4, XW2B-40G5 or XW2D-40G6 OMRON Terminal Block Unit, i.e. the Terminal Block Unit is connected to the Unit via standard available OMRON I/O-cables (XW2Z-xxxK).

Refer to section 2-3-2 *Connector Wiring Methods* for more details.

1-3 Specifications and Characteristics

1-3-1 General Specifications

Item	CJ1W-CTL41-E
Unit type	CJ-series Special I/O Unit
General Specifications	Conform to general specifications for SYSMAC CJ-series
Operating Temperature	0 to 55 °C
Storage Temperature	-20 to 70 °C
Humidity	10% to 90% without condensation
Internal Current Consumption	320 mA (at 5 V)
Dimensions (mm)	31 x 90 x 65 (W x H x D)
Weight	100 g
Mounting Position	CJ-series CPU Rack or CJ-series Expansion Rack
Maximum Number of CTL41-E Units per Rack	Equal to the number of slots of the Rack (see Note 1)
Maximum Number of CTL41-E Units per basic CJ PLC	24
Data Exchange with CPU Unit	<ul style="list-style-type: none"> • I/O Refresh Data Area: CIO-words 2000 to 2959. See Note 2. • Special I/O Unit DM-Area: D-words 20000 to 29599: 90 DM-words per Unit are transmitted from the CPU to the Unit at Power Up or when the Unit is restarted. See Note 3.

- Note**
1. The maximum number of Units per Rack also depends on the maximum supply current of the Power Supply Unit and the current consumption of other Units on the Rack.
 2. The CJ1W-CTL41-E Special I/O Unit allocates space for 33 words in the Special I/O Unit (CIO) Area (refer to section 4-2-3 *CIO-Memory Mapping*).
 3. For a CJ1W-CTL41-E Special I/O Unit the same space as for 4 Units in the Special I/O Unit DM Area are reserved. However, only the first 90 words are used to make the DM-settings. The remaining 310 words can be used as work-words (refer to section 4-2-4 *DM-Memory Mapping*).

1-3-2 Functional Specifications

Item	CJ1W-CTL41-E
Number of Counters	4
Counter Type	<ul style="list-style-type: none"> • Circular Counter (refer to section 3-2-1 <i>Circular Counter</i>) • Linear Counter (refer to section 3-2-2 <i>Linear Counter</i>) The Counter Type can be selected using the appropriate DM bits (refer to section 4-2-4 <i>DM-Memory Mapping</i>).
Maximum Input Frequency	100 kHz, refer to section 1-3-3 <i>Input Specifications</i> for details
Signals per Counter	Phase A, B and Z
Input Signal Types	<ul style="list-style-type: none"> • Phase Differential (multiplication x1), (multiplication x2) and (multiplication x4) (refer to section 3-3-1 <i>Phase Differential</i>) • Up/Down (refer to section 3-3-2 <i>Up & Down</i>) • Pulse & Direction (refer to section 3-3-3 <i>Pulse & Direction</i>)
Counter Control using CIO-software bits	<ul style="list-style-type: none"> • Open Gate / Start Counter: Counter is enabled to count pulses • Close Gate / Stop Counter: Counter is disabled to count pulses • Preset Counter: Preset Value can be set in CIO • Reset Counter to zero • Capture Counter Value: Captured Counter Value can be read using IORD-instruction (refer to section 4-5-3-1 <i>Captured Counter Value</i>)
Output Control Mode	<ul style="list-style-type: none"> • Automatic Output Control in: • Range Mode (Refer to section 3-5-1 <i>Range Mode</i>) • Comparison Mode (Refer to section 3-5-2 <i>Comparison Mode</i>)
Reset Signals	Every Counter can be reset to zero by (a combination of) the following sources: <ul style="list-style-type: none"> • Software Counter Reset Bit • Z-Input Refer to section 3-6 <i>Reset Signals</i> .
Extra Functions	<ul style="list-style-type: none"> • Hysteresis: To prevent Outputs from being switched On and Off by very small fluctuations in the Counter Value around Range Limits, for every Counter an Hysteresis-value [1, 255] can be defined (the Unit must in Range Mode). Refer to section 3-7-1 <i>Hysteresis</i>.
Noise Filtering Counter Inputs	To suppress noise on the signal lines of the Counter Inputs (A, B) a fixed Noise Filter is provided: <ul style="list-style-type: none"> • Counter Inputs A and B: 100 kHz
Initial Counter Value	<ul style="list-style-type: none"> • The Initial Counter Value is transferred to the Unit when the Unit is Powered Up or Restarted. The Initial Counter Value is very useful to overcome problems in case of power failure. Refer to section 3-7-2 <i>Initial Counter Value</i>.
IORD- and IOWR-instructions	Run-time configuration (See Note 2) and operation of the Counter Unit is possible by using IORD- and IOWR-instructions. The following data can be read or written: <ul style="list-style-type: none"> • DM-configuration data (refer to section 4-5-1 <i>DM-data</i>). • Range- and Comparison Data (refer to section 4-5-2 <i>Range- and Comparison data</i>). • Captured Counter Value (refer to section 4-5-3-1 <i>Captured Counter Value</i>) • Counter Value (refer to section 4-5-3-2 <i>Counter Value</i>) • (Re) Configure Counter Unit (refer to section 4-5-3-3 <i>(Re) Configure Unit</i>). • Error Clear (refer to section 4-5-3-4 <i>Error Clear Command</i>)
Interrupts of Outputs	The Soft Outputs of the Unit Output Pattern can all be configured to generate interrupts to the CJ1-H/CJ1M CPU Unit. Refer to section 4-6-1 <i>Outputs Generating Interrupts</i> . See also Note 1.
Error History Log Function	Stores up to 30 error log records (refer to section 5-2 <i>Error codes</i>)

- Note**
1. A CJ1G-CPU□□H, CJ1H-CPU□□H or CJ1M-CPU□□ CPU Unit must be used. The older CJ1G-CPU□□ CPU Units (without H suffix) do not support external interrupt tasks. To activate external interrupt tasks in a CJ1G-H/ CJ1H-H CPU Unit, the CJ1W-CTL41-E Counter Unit must be in one of

the five positions immediately to the right of the CPU Unit. For CJ1M CPU Units, the CJ1W-CTL41-E Counter Unit must be in one of the three positions immediately to the right of the CJ1M CPU Unit. No external interrupt tasks can be activated if the Unit is in any other position (i.e., 6th Unit position or further away from the CJ1-H CPU Unit, or 4th Unit position or further away from the CJ1M CPU Unit), or if it is on a CJ-series Expansion Rack.

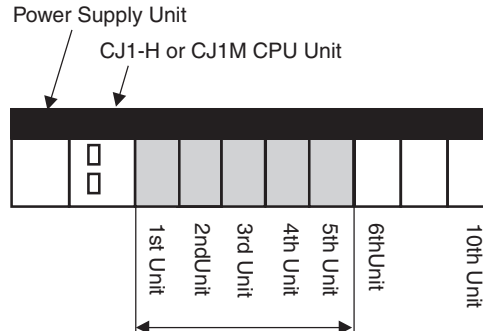

For CJ1-H CPU Units: External interrupt tasks can be activated only from these Units.



For CJ1M CPU Units: External interrupt tasks can be activated only from these Units.

2. If an IOWR- or IORD-instruction is used during operation, comparison will stop during instruction execution. Care must be taken, therefore, with the timing of executing instructions. (Refer to section 3-5 *Output Control* for details.)

1-3-3 Input Specifications

Item	Counter Inputs A, B and Z
Input Voltage	Line Driver
Input Current (typical)	11 mA
Voltage levels	Connectable to RS-422 compatible Line Drivers.

Note The Counter Inputs (A, B, Z) are insulated from each other. All Counter Inputs are reverse polarity protected and insulated from the I/O-bus.

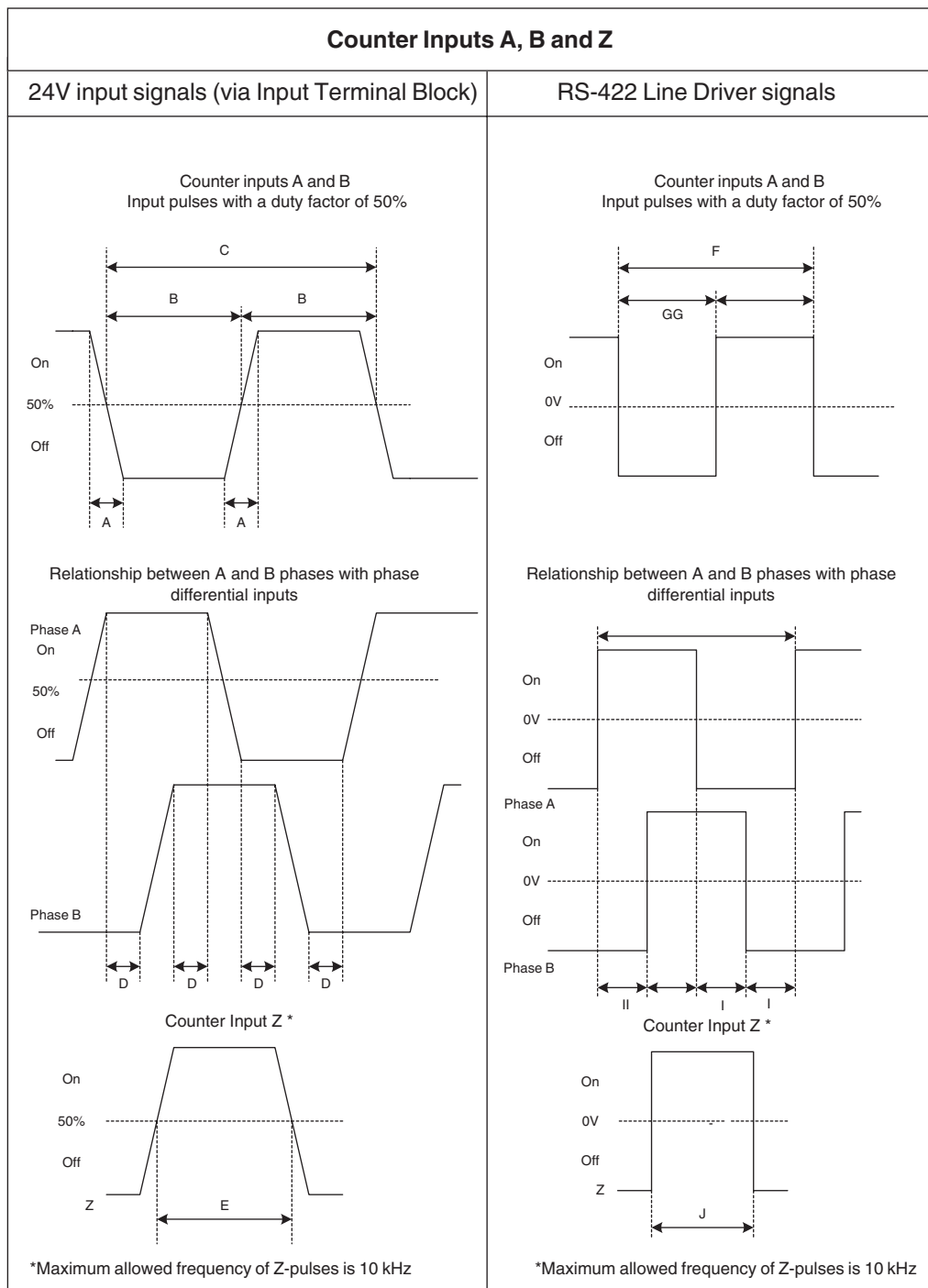

Timing requirement [μs]									
A	B	C	D	E	F	G	H	I	J
<3	>50	>100	>23	>10	>100	>50	>100	>23	>10
<3	>10	>20	>4.5	>10	>20	>10	>20	>4.5	>10
<3	>2	>4	>1	>10	>2	>1	>4	>1	>10

Note As a general guideline it can be stated that if you want the timing requirements for the Counter Inputs to satisfy the above mentioned specifications, you must pay attention to the type of output driver of the encoder being used, the length of the encoder cable and the frequency of the count pulses generated. For

example, if you use an Open Collector encoder (e.g. E6B2-CWZ6C) at 24 V with 10 m cable, you can typically generate count pulses up to 20 kHz. Therefore, if you want to generate count pulses with higher frequencies, you should use a different type of encoder (e.g. E6B2-CWZ1X with Line Driver output or a fast push-pull 24 V encoder, e.g. E6C2-CWZ5GH) or reduce the length of the encoder cable.

1-4 Quick Start Up Reference Guide

Operation and Configuration

Each individual Counter of the Counter Unit can be configured as Circular or Linear Counter (refer to section the section 1-5 *Operating Procedure Guidelines* for quick start up information).

The diagram below shows the functions the Unit has available to operate and configure the Unit (refer to SECTION 3 *Operation and Configuration*). The numbers in grey refer to section the table on page 16.

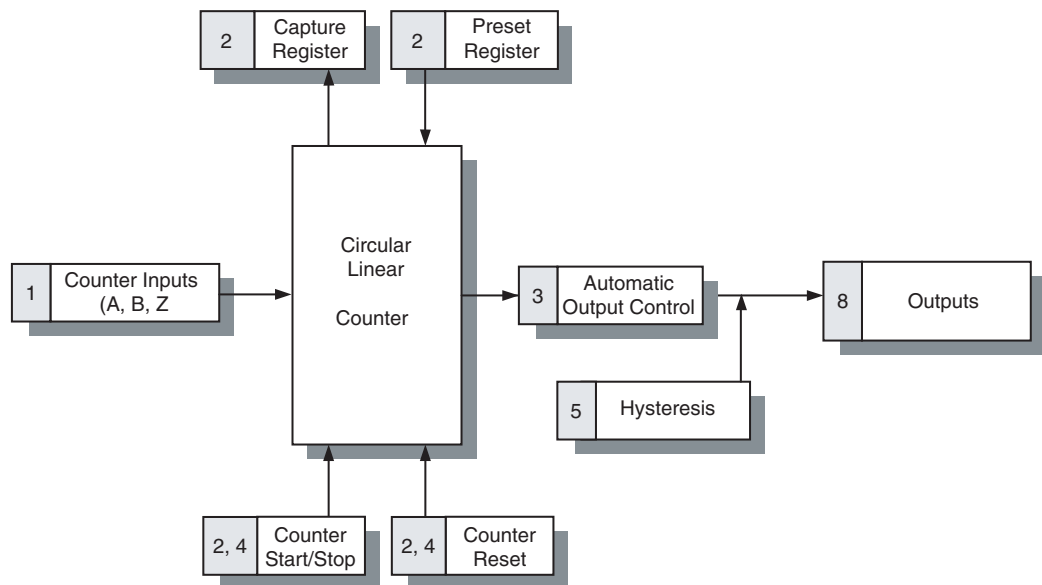

Exchanging data with CPU

The diagram below shows the functions the Unit provides to exchange data with the CPU (refer to section SECTION 4 *Exchanging Data with CPU*).

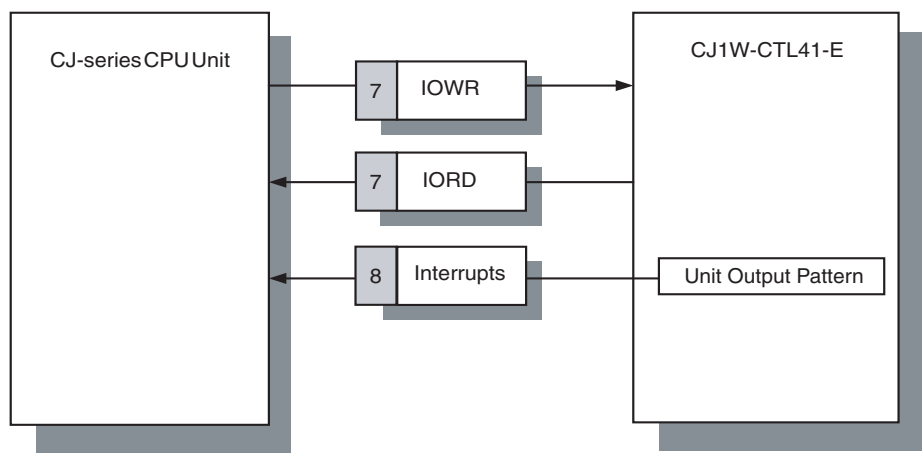

Ref	Item	Circular/Linear Counter	Reference section
1	Input Signal types	Phase Differential (x1, x2, x4)	3-3-1
		Up & Down	3-3-2
		Pulse & Direction	3-3-3
2	Counter control	<ul style="list-style-type: none"> • Open Gate / Start Counter • Close Gate / Stop Counter • Preset Counter • Reset Counter • Capture Counter Value 	3-4
3	Output control	• Range Mode	3-5-1
		• Comparison Mode	3-5-2
4	Counter reset	<ul style="list-style-type: none"> • Software Reset Bit • Z-signal 	3-6
5	Hysteresis	Yes	3-7-1
6	Initial counter values	Yes	3-7-2
7	Supported IORD / IOWR-instructions	Captured Counter Value	4-5-3-1
		Counter Value	4-5-3-2
		Error Clear	4-5-3-4
		DM-data	4-5-1
		Range- and Comparison Data	4-5-2
		(Re) Configure Unit	4-5-3-3
8	Interrupts of Outputs	Yes	4-6-1

1-4-1 Configuring the Counter Unit

Configuring the Counter Type

Configuring each Counter starts with choosing the Counter Type, i.e. it must be configured for Circular or Linear Counter (refer to section 3-2-1 *Circular Counter*, section 3-2-2 *Linear Counter* and section 1-5 *Operating Procedure Guidelines* for details).

Configuring the Input Type

Next, the Input Type (Phase Differential, Up/Down, or Pulse & Direction) for every Counter has to be defined. During operation of the Counter, the Counter can be Started, Stopped, Reset, Captured or Preset by using the corresponding bits in CIO.

Configuring the Output Mode

In order to link the Units Software Outputs to Counter events, the Output Control Mode (Range or Comparison Mode) must be selected. Furthermore, an additional Hysteresis mechanism is available to control the Outputs. Refer to section 3-5 *Output Control*.

Indirect Addressing for Circular and Linear Counters

The CJ1W-CTL41-E Counter Unit allocates 90 DM-words in the Special I/O Unit DM-Area and a block of 34 CIO-words in the Special I/O Unit Area of the PLC. The configuration of the Unit is done by making the appropriate DM-settings in the Special I/O Unit DM-Area allocated to the Unit.

The Special I/O Unit DM-Area is divided in an area of 10 words to make the General Unit Settings and 4 blocks of 20 DM-words each to make the Counter Specific Settings, which are unique for every Counter.

Depending on the Output Control Mode, Counter Range or Comparison Data can be set. For each Counter, up to a maximum of 4 Ranges or 8 Comparison Values can be assigned. You can set the Range or Comparison Data in a part of DM or EM which is not being used. If you only intend to use a limited number of Ranges or Comparison Values then it is also possible to use the work-words of the Special I/O Unit DM-Area to store the Range or Comparison Data (287 work-words for the CJ1W-CTL41-E are available). Therefore, at the end of every block with Counter Specific Settings, you can specify an Indirect Address. This Indirect Address points to the actual memory location where the Range- or Comparison Settings of that specific Counter are stored.

For a detailed description about the CIO- and DM-Memory Allocation refer to section 4-2 *Memory Allocation*.

Note During operation of the Unit, for Circular and Linear Counters run-time configuration is possible by using the IOWR-instruction from the PLC Ladder Program (refer to section 4-5 *Supported IOWR/IORD-Instructions*). Additionally, Outputs can be configured to generate interrupts to the PLC by setting the appropriate Interrupt Masks in DM. (refer to section 4-6 *Interrupts*)

1-5 Operating Procedure Guidelines

In order to setup the Counter, follow the steps outlined below.

- 1, 2, 3...
1. Set the Machine Number to assign the start addresses of the allocated CIO and DM areas. Refer to section 2-1-3 *Machine Number Switch* for further details.

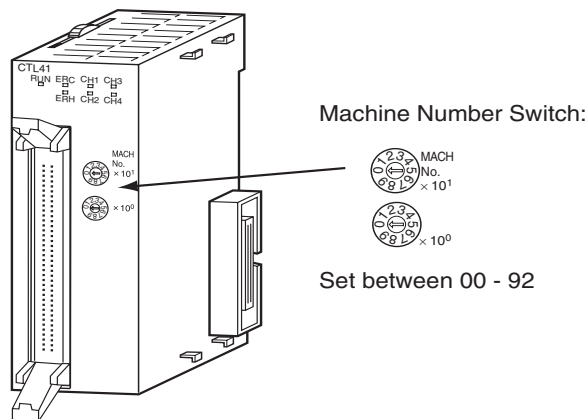

2. Install and wire the Unit. Refer to section 2-2 *Installation* and 2-3 *Wiring* for further details.

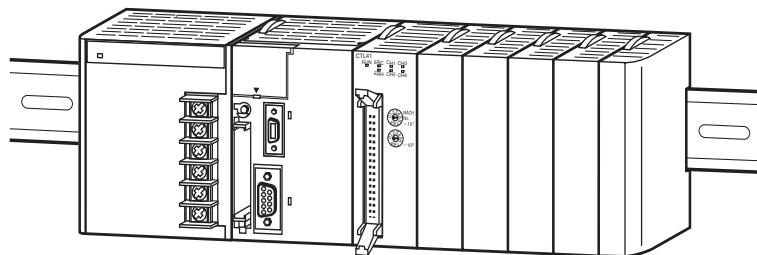

3. Turn ON the Power to the PLC.

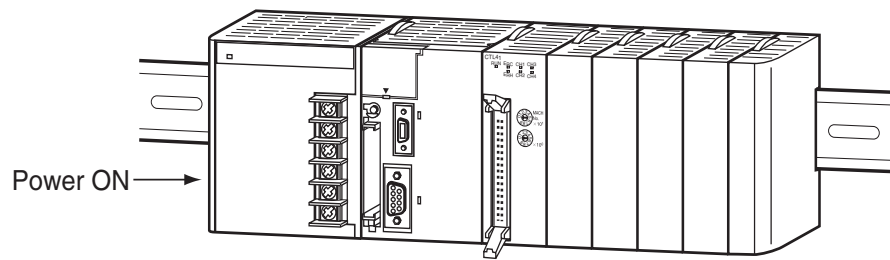

4. Create the I/O table. The I/O table can be created by using CX-Programmer Support Software or a Programming Console.

CX-Programmer

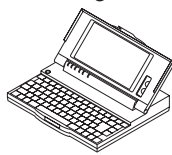

Programming Console

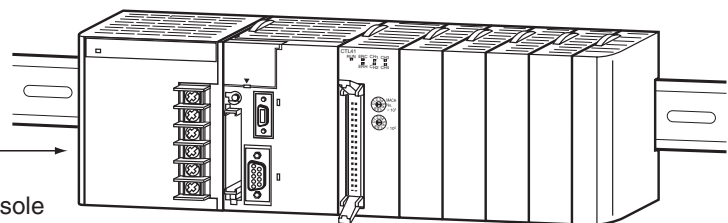
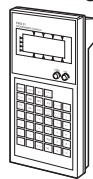

Unit Configuration

After the I/O table is created in step 4, you have to configure the Unit by making the appropriate DM-settings. The Unit can be configured by using CX-Programmer Support Software or a Programming Console. Two Programming Consoles can be used with the CJ-series CPU Units: the C200H-PRO27-E and the CQM1-PRO01-E. The CS1W-KS001 Key Sheet must be used for both.

- 1, 2, 3...
 1. Every Counter can now be separately (DM-) configured. The configuration of the Counter Type (Linear or Circular Counter) is done by DM-setting. Refer to section *SECTION 3 Operation and Configuration* for detailed information about configuring the Unit.
 2. Power up the PLC again or turn the Special I/O Unit Restart Bit to ON (to transfer the DM-settings). All data related to Circular /Linear Counters is now being exchanged between the PLC and the Unit in CIO-memory and available for usage in the Ladder Program.
 3. Create and RUN a Ladder Program in the PLC. Refer to section *SECTION 4 Exchanging Data with CPU* for details on the interface between the CJ-series Counter Unit and the CPU. Refer to section sections 6-2 to 6-5 for application examples using Circular and Linear Counters.

Refer to section *3-2-1 Circular Counter* and *3-2-2 Linear Counter* for more details about both Counter Types. Refer to section *4-1-2 Special I/O Units Restart bits* for more information about restarting the Unit.

1-6 Application Areas

The main application areas of the Counter Unit are where signals with high frequencies are counted and high-speed responses have to be triggered at predefined Counter Values. Application areas include:

- Packaging and Sorting plants
- Dosing or proportioning plants
- Process Industry

Typical applications in which the CJ1W-CTL41-E can be used:

- (CAM)-Positioning
- Position Monitoring
- Length Measurement
- Flow Control
- Energy Measurement

SECTION 2

Components, Installation and Wiring

This section provides details of the components, switch settings and other information required to install and operate CJ1W-CTL41-E Counter Units.

2-1	Components and Switch Settings	16
2-1-1	Components	16
2-1-2	Indicators	16
2-1-3	Machine Number Switch	17
2-2	Installation	19
2-2-1	Installation Precautions	19
2-2-2	Installing Units	19
2-3	Wiring	21
2-3-1	Connector Pin-layout	21
2-3-2	Connector Wiring Methods	22
2-3-3	Important Wiring Considerations	23
2-3-4	Internal Circuitry	24
2-3-5	Counter Input Configuration	24

2-1 Components and Switch Settings

2-1-1 Components

Front and Side View

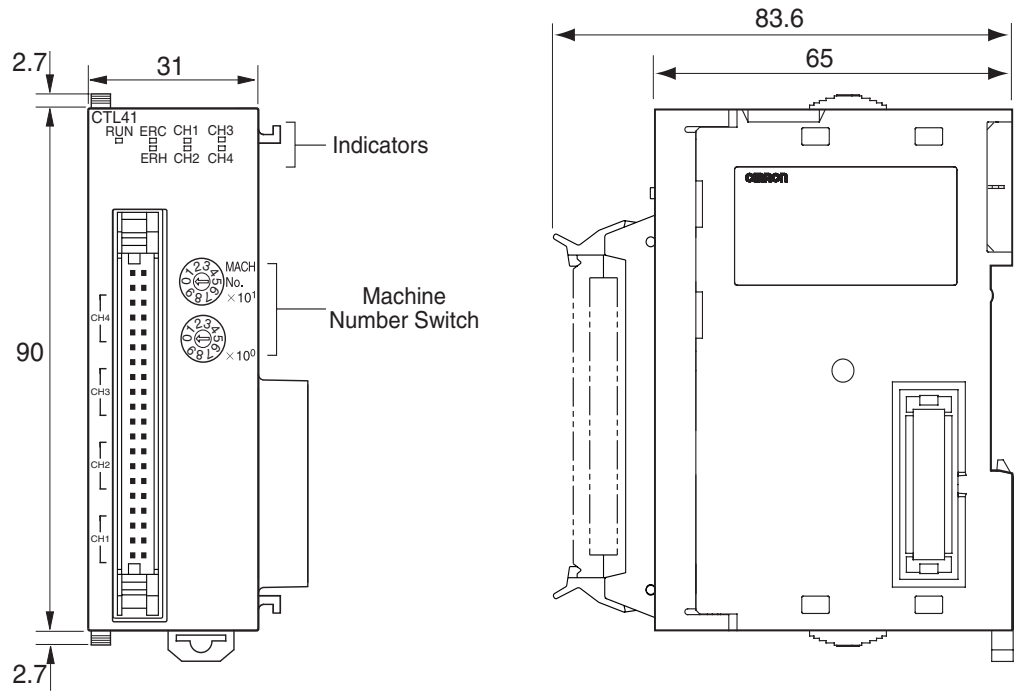

Units in mm

2-1-2 Indicators

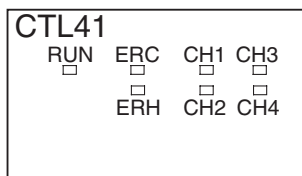

The indicators on the LED-display show the operating status of the Unit. The following table shows the meaning of the indicators.

LED	Colour	State	Description
RUN	Green	ON	Unit is in operation (i.e. Unit has initialised normally after (re-) starting the Unit).
		OFF	Unit is not in operation (i.e. Unit was not able to initialise normally after (re-) starting the Unit or the power to the Unit is switched OFF).
ERC	Red	ON	Unit has operational failure due to a detected error. (For a list of all the errors that can cause an operational failure, see 5-2 <i>Error codes</i> .)
		OFF	Unit has no operational failure.

LED	Colour	State	Description
ERH	Red	ON	CPU Unit has operational failure. (For a list of all the errors that can occur at the CPU Unit see 5-1 <i>Error Indicators</i>)
		OFF	CPU Unit has no operational failure.
CH1	Yellow	ON	Counter 1 is counting, i.e. the corresponding counting gate is enabled and at least one pulse has been detected.
		OFF	Counter 1 is not counting, i.e. the corresponding counting gate is closed or no pulses have been detected.
CH2	Yellow	ON	Counter 2 is counting, i.e. the corresponding counting gate is enabled and at least one pulse has been detected.
		OFF	Counter 2 is not counting, i.e. the corresponding counting gate is closed or no pulses have been detected.
CH3	Yellow	ON	Counter 3 is counting, i.e. the corresponding counting gate is enabled and at least one pulse has been detected.
		OFF	Counter 3 is not counting, i.e. the corresponding counting gate is closed or no pulses have been detected.
CH4	Yellow	ON	Counter 4 is counting, i.e. the corresponding counting gate is enabled and at least one pulse has been detected.
		OFF	Counter 4 is not counting, i.e. the corresponding counting gate is closed or no pulses have been detected.

2-1-3 Machine Number Switch

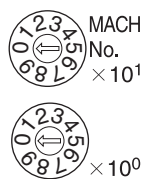

The CPU Unit and the Counter Unit exchange data via the Special I/O Unit Area (CIO) and the Special I/O Unit DM Area. The Counter Unit is allocated 34 CIO words and 90 DM words, starting at the addresses for this Machine number. The Machine Number is set by using the two Machine Number rotary switches on the front panel of the Unit.

As a result of this amount of allocated words, the subsequent 3 Machine Number addresses cannot be used by other Special I/O Units, as their allocations would overlap with this data.

Always turn OFF the power before setting the Machine Number. Use a flat-blade screwdriver, being careful not to damage the switch. Be sure not to leave the switch midway between settings.

Note The Machine Number determines which words in the CPU Unit's Special I/O Unit Area (CIO 2000 to CIO 2959 and DM 20000 to DM 29599) are allocated to the Counter Unit. The CJ1W-CTL41-E Unit occupies 4 Special I/O Unit Areas, i.e. the next Special I/O Unit Machine Number must at least be set to this Unit's Machine Number plus 4. The Machine Number can only be set between 00 and 92. The Machine Numbers 93, 94 and 95 can not be set.

Switch Setting	Machine Number	I/O Refresh Data Area Addresses	Special I/O Unit DM Area Addresses
0	#0	CIO 2000 to CIO 2039	D20000 to D20399
1	#1	CIO 2010 to CIO 2049	D20100 to D20499
2	#2	CIO 2020 to CIO 2059	D20200 to D20599
3	#3	CIO 2030 to CIO 2069	D20300 to D20699
4	#4	CIO 2040 to CIO 2079	D20400 to D20799
5	#5	CIO 2050 to CIO 2089	D20500 to D20899
6	#6	CIO 2060 to CIO 2099	D20600 to D20999
7	#7	CIO 2070 to CIO 2109	D20700 to D21009
8	#8	CIO 2080 to CIO 2119	D20800 to D21199
9	#9	CIO 2090 to CIO 2129	D20900 to D21299
10	#10	CIO 2100 to CIO 2139	D21000 to D21399
...
n	#n	CIO 2000 + (n * 10) to CIO 2000 + (n * 10) + 39	D 20000 + (n * 100) to D 20000 + (n * 100) + 399
...
92	#92	CIO 2920 to CIO 2959	D29200 to D 29599
93	Cannot be set	Not Applicable	Not Applicable
94			
95			

- Note**
1. If two or more Special I/O Units are assigned the same Machine Number, a fatal error "Unit No. Duplication Error" (in the PLC-CPU) will be generated (A40113 will turn ON) and the PLC will not operate.
 2. The Counter Unit is allocated the words for 4 Units. If you use Special I/O Units that are allocated more than 100 DM-words and 10 CIO-words, like the CJ1W-CTL41-E Counter Unit, you should make sure that no memory overlapping occurs. If the Machine Number for the Counter Unit is set to 'n' the Machine Numbers 'n+1' through 'n+3' cannot be used on other units. In case two or more Special I/O Units have set Machine Numbers causing an overlap of allocated memory, a fatal error "Unit No. Duplication Error" (in the PLC-CPU) will be generated (A40113 will turn ON) and the PLC will not operate.
 3. Besides the memory that is allocated to the Counter Unit in the Special I/O Unit DM Area, for every Counter additional memory can be allocated in DM/EM. This extra allocated amount of memory is used to make the Counter Specific Settings related to Range or Comparison Mode. Memory is allocated by specifying an Indirect Address for every Counter in the Special I/O Unit DM Area. For details about Indirect Addressing refer to section 4-2-2 *Indirect Addressing*.

2-2 Installation

2-2-1 Installation Precautions

When installing the CJ1W-CTL41-E Counter Unit on the PLC system, observe the following handling precautions

- Always turn OFF the power supply to the PLC before mounting or dismantling a Unit or connecting or disconnecting cables.
- Provide separate conduits or ducts for the I/O lines to prevent noise from high-tension lines or power lines.
- Leave the label on top of the Unit attached when wiring. Removing the label prior to wiring may result in malfunction if foreign matter enters the Unit.
- Remove the label after the completion of wiring to ensure proper heat dissipation. Leaving the label attached may result in malfunction.

Up to 24 Units can be connected for each PLC (CPU Unit), with a maximum of 10 on each Rack (CPU Rack and Expansion Racks).

Note The Unit must be mounted to one of the five positions immediately to the right of the CJ1-H CPU Unit (when facing the PLC) to generate interrupts to the CPU Unit to execute external interrupt tasks. Interrupts are not supported from any other location on the CPU Rack and are not supported at all from Expansion Rack. They are also not supported by CJ1G-CPU44 and -45, without 'H' suffix.

2-2-2 Installing Units

Caution Be sure to turn OFF the power supply to the PLC before installing or removing Units or connecting or disconnecting connectors.

Use the following procedure to install CJ1W-CTL41-E Counter Units. Connect the Units before mounting them to DIN-rail.

- 1, 2, 3...** 1. Align the connectors and hooks accurately and press the Units together firmly when connecting them.

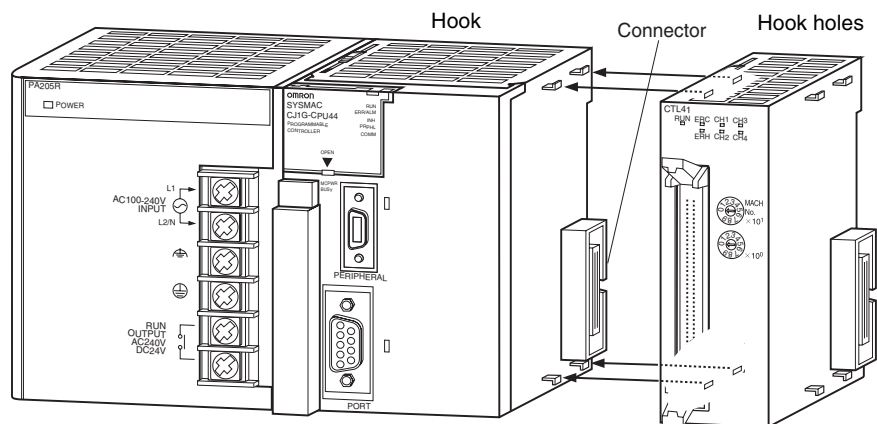

- Slide the yellow sliders on the top and bottom of the Units until they click into place, firmly locking the Units together.

Slide the sliders toward the back until they click into place.

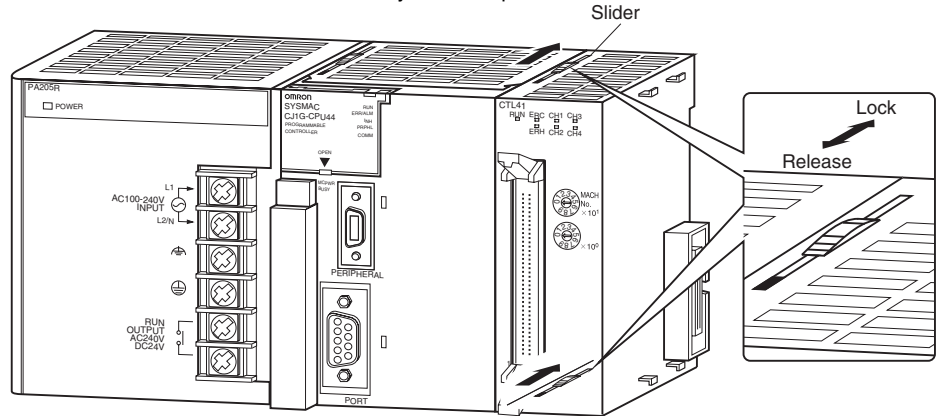

- Attach an End Plate to the Unit on the right end of the Rack.

Note The Units may not function properly if the sliders are not locked into place. Always connect the End Plate to the rightmost Unit. The CJ-series PLC will not function properly without the End Plate connected. The End Plate is provided with the CPU Unit.

2-3 Wiring

2-3-1 Connector Pin-layout

The 40-pin connector on the front of the Unit is divided in two rows, each row containing 20-pins as indicated in the figure below. The Counter Inputs of the Unit are logically grouped together and allocated to the pins of the connector. The following table lists the allocation of the external signals to the respective pins.

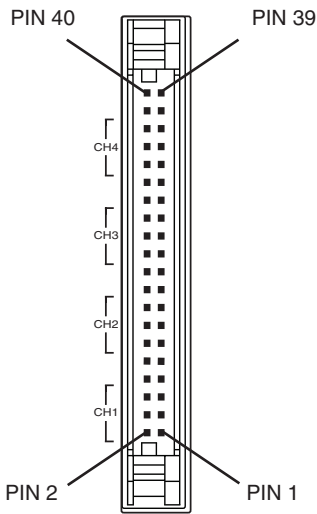

	Pin No.	Signal	Pin No.	Signal
	40	Not Connected	39	Not Connected
	38		37	
Channel 4	36	Z-	35	Z+
	34	B-	33	B+
	32	A-	31	A+
	30	Not Connected	29	Not Connected
	28		27	
Channel 3	26	Z-	25	Z+
	24	B-	23	B+
	22	A-	21	A+
	20	Not Connected	19	Not Connected
	18		17	
Channel 2	16	Z-	15	Z+
	14	B-	13	B+
	12	A-	11	A+
	10	Not Connected	9	Not Connected
	8		7	
Channel 1	6	Z-	5	Z+
	4	B-	3	B+
	2	A-	1	A+

Counter Inputs

To the Counter Inputs of the Counter Unit signals can be applied originating from one of the following driver types:

- RS-422 Line Driver, either directly connected to the connector on the front of the Unit or through a separate Input Terminal Block, e.g. the OMRON XW2G-40G7-E or XW2D-40G6.
- 24 Vdc signals from NPN- or PNP Drivers, only through the separate OMRON XW2G-40G7-E Input Terminal Block.

2-3-2 Connector Wiring Methods

⚠ Caution Be sure that all the connectors are wired correctly and properly connected to the Counter Unit, to prevent the Unit from malfunctioning.

To wire the CJ1W-CTL41-E in order to connect the external signals three methods are available:

1. Directly connecting the wires and cables to an external connector. Recommended connectors are 40-pin MIL-C-83503 (or DIN 41651 or IEC 60603-1) compatible 40-pole connectors.
2. Indirectly connecting the wires and cables to the screw terminals of an XW2B-40Gx Terminal Block Unit, which is connected to the Unit with a standard XW2Z I/O cable. Both parts can be ordered separately.
3. Indirectly connecting the wires and cables to the screw-less terminals of an XW2G-40G7-E Terminal Block Unit, which is connected to the Unit with a standard XW2Z I/O cable. Both parts can be ordered separately.

The figures below show the XW2B-40Gx and XW2G-40G7-E Input Terminal Blocks.

Terminal Block Unit

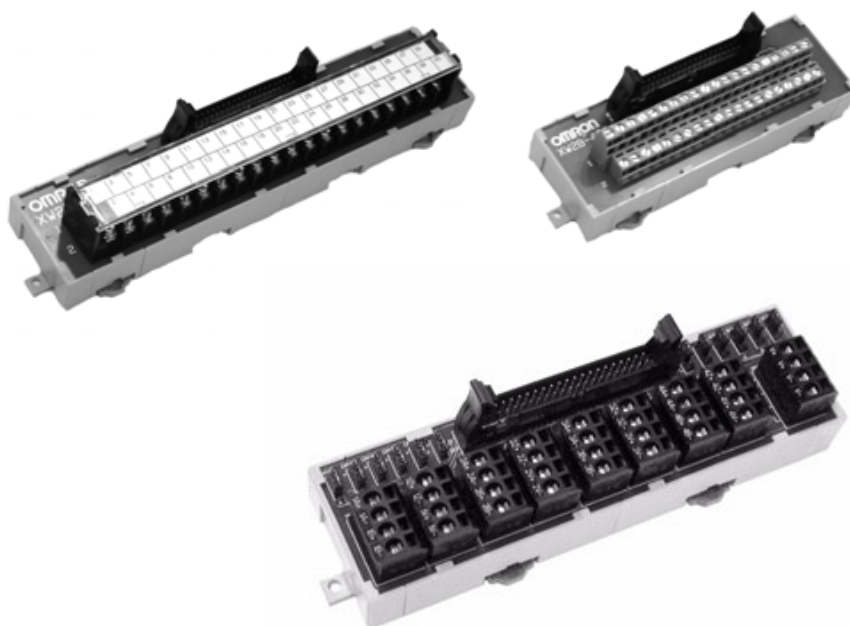

The following Terminal Block Units are recommended for using together with the CJ1W-CTL41-E Counter Unit:

Item	Description	Input type supported
XW2B-40G4	40 screw terminals (M2.4)	Line driver only
XW2B-40G5	40 screw terminals (M3.5)	Line driver only
XW2D-40G6	40 screw terminals, compact	Line driver only
XW2G-40G7-E	36 screwless terminals	Line driver / 24 Vdc

These Terminal Block Units can be mounted to a DIN-rail or to a flat surface using screws. The connector on front of the Unit must be connected to a Terminal Block Unit through a standard (40 wire) cable. For this purpose you can use the standard available cables with product-number XW2Z-xxxK. The length of the cable is indicated by 'xxx' in centimetres. The following cables are available:

- XW2Z-050K (0.5 m)
- XW2Z-100K (1 m)
- XW2Z-150K (1.5 m)
- XW2Z-200K (2 m)
- XW2Z-300K (3 m)
- XW2Z-500K (5 m)

The next figure shows how to use the Terminal Block Unit in a typical configuration together with the CJ1W-CTL41-E Counter:

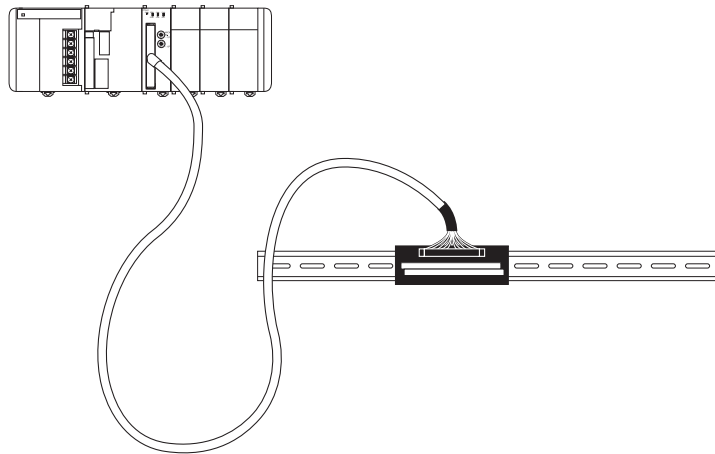

Refer to section Appendix A *Using Input Terminal Block Units* for information on the numbering of the screw-terminals. You need this information in case you want to connect the external signals via Terminal Block Units to the Counter Unit.

2-3-3 Important Wiring Considerations

Use the following guidelines when planning the system wiring of the Unit:

- Disconnect the power to the PLC-system before wiring the Unit.
- Make sure the PLC-system is properly grounded.
- Use shielded, twisted pair cables and ground the shield when wiring the Counter Inputs (A, B, Z). When grounding the shield at the side of the Unit, use the same reference as the ground terminal of the PLC-Power Supply is connected to.
- Make the wiring for the Counter Inputs A, B and Z as short as possible and do not route the wires parallel to lines that produce a lot of noise, such as high-voltage power lines.
- Use a separate stabilised Power Supply for the Counter Unit and another Power Supply for other Units.

2-3-4 Internal Circuitry

Counter Input Circuitry

The figure below shows the internal input circuitry for all three input signals for each of the four Counter channels.

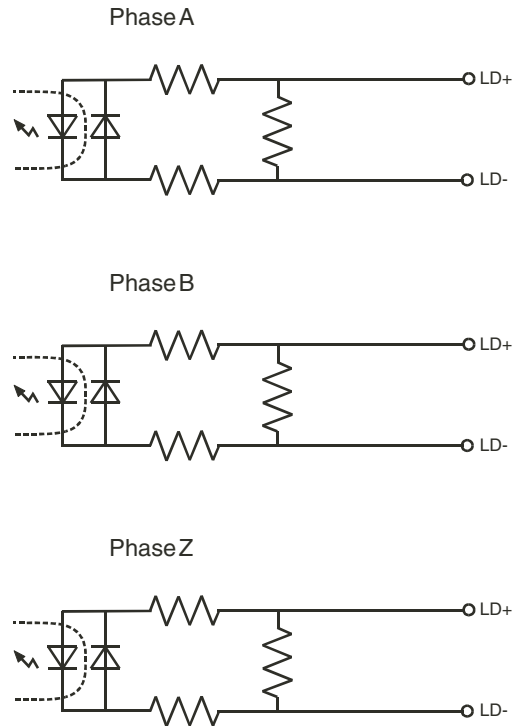

2-3-5 Counter Input Configuration

The following example illustrates how to wire the Counter Inputs in a typical configuration according to the output-driver of the encoder or proximity switch being used. In the example Counter channel 1 is used. The configuration shown here, related to a specific output-driver, can also be referred to in case other pulse generating equipment with similar output-drivers is being used.

Line Driver (RS422)

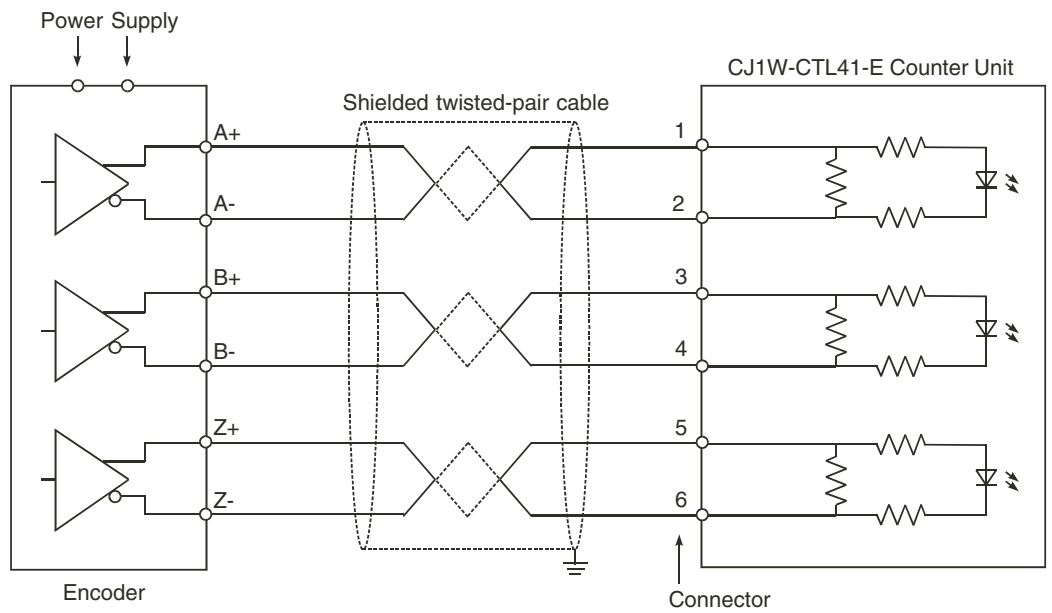
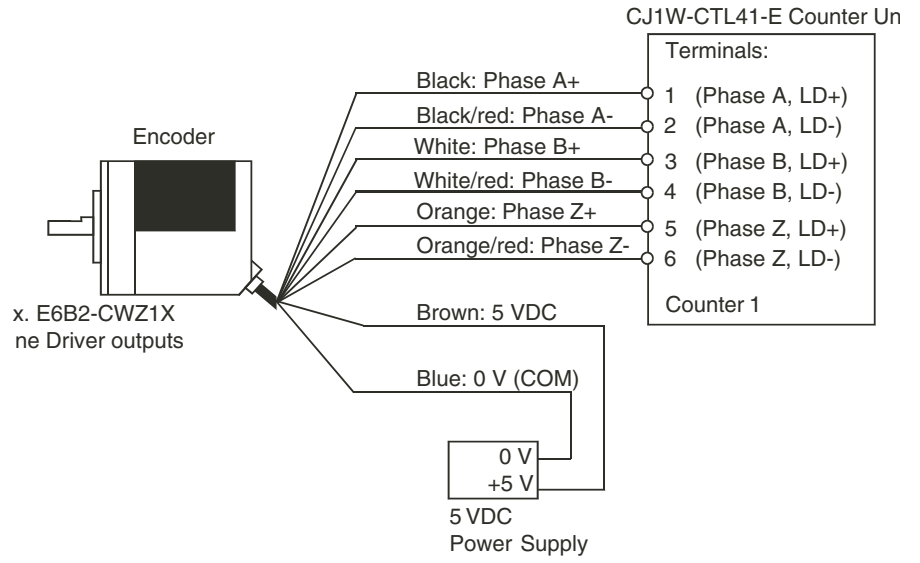

SECTION 3

Operation and Configuration

This section describes how to configure the CJ1W-CTL41-E Counter Unit and how to operate the Unit according to the specific requirements of your application.

3-1	Overview	28
3-2	Counter Types	29
3-2-1	Circular Counter	30
3-2-2	Linear Counter	31
3-3	Input Signal Types	33
3-3-1	Phase Differential	33
3-3-2	Up & Down	34
3-3-3	Pulse & Direction	35
3-4	Controlling a Counter	36
3-5	Output Control	38
3-5-1	Range Mode	40
3-5-2	Comparison Mode	46
3-6	Reset Signals	53
3-7	Extra Functions	54
3-7-1	Hysteresis	54
3-7-2	Initial Counter Value	55

3-1 Overview

After you have installed and wired the CJ1W-CTL41-E Counter Unit as described in Section 2-2 *Installation* and Section 2-3 *Wiring*, you have to configure the Unit by making DM-settings.

In this section you will learn how to configure the CJ1W-CTL41-E Counter Unit in order to adjust the behaviour of the Unit according to the specific requirements of your application (refer to section Section 1-4 *Quick Start Up Reference Guide* for an overview of the configuration items for every Counter). Also throughout this section, the CIO-words that are relevant to operate the Unit from the PLC ladder program are mentioned (refer to section Section 4-2-3 *CIO-Memory Mapping* for an overview). For an overview of all the DM-settings that can be made refer to section Section 4-2-4 *DM-Memory Mapping*.

All the features and functions that the Counter Unit offers are (DM-) configurable. In the Special I/O Unit DM-area which is allocated to the Counter after the Unit has been properly installed (see Section 1-5 *Operating Procedure Guidelines*), all the available features and functions of the Unit are represented by their corresponding DM-words. You are free to choose the sequence in which you configure the different functions. However, it is recommended to follow the sequence of configuring the features and functions in the order as described in this section.

- Note**
1. Throughout this section for the DM- and CIO- addresses an offset is defined with respect to the physical address of the first word of the block that is allocated to the Counter Unit (N = Machine Number):
 - $m = DM20000 + (N \times 100)$, address of the first word of the block of 90 DM-words reserved for the Unit
 - $n = CIO2000 + (N \times 10)$, address of the first word of the block of 34 CIO-words reserved for the Unit
 - Example: $m+2$ indicates the DM-word located at $DM20000 + (N \times 100) + 2$.
 2. Double words are indicated as for example “ $n+22, n+23$ ” (double word in CIO) or “ $m+57, m+58$ ” (double word in DM). How to distinguish between the least and most significant words (LSW and MSW) within double words, you should refer to section the section called “*About this Manual*” at the beginning of this Manual.

3-2 Counter Types

Every single Counter of the Counter Unit can be set independently to one of the following Counter Types:

- Circular Counter (refer to section Section 3-2-1 *Circular Counter*)
- Linear Counter (refer to section Section 3-2-2 *Linear Counter*)

Each Counter can be configured Circular or Linear Counter by giving the corresponding word in DM the appropriate setting:

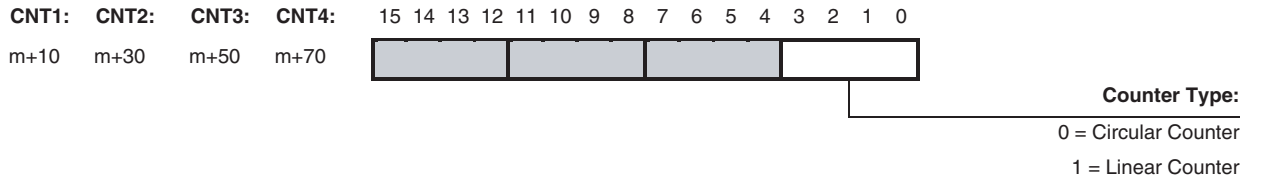

For Circular and Linear Counters all the functions and features of the Counter Unit are available and configurable.

Counter Value

For all Counter Types the 32-bit Counter Value is reflected in CIO.

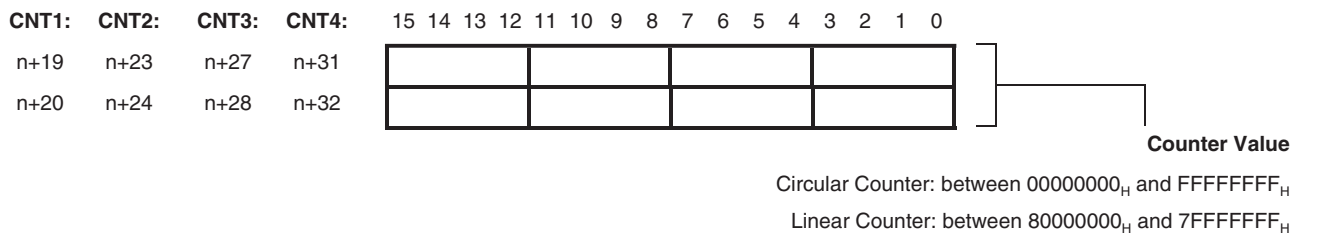

3-2-1 Circular Counter

Note All of the functions listed in Section 1-3-2 *Functional Specifications* can be used if a Circular Counter is configured.

Configuring Circular Counters

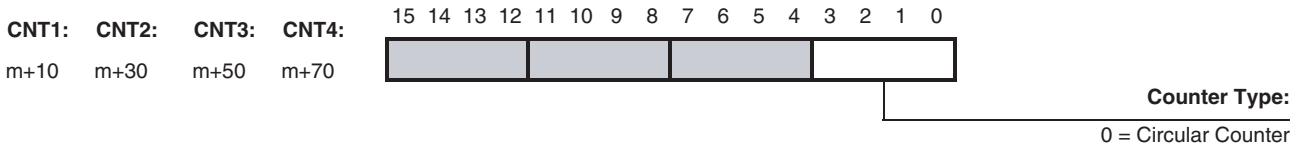

A Circular Counter has 32-bits (the full counting range) available to count up- or downwards over the positive counting range between 0 and the Upper Count Limit.

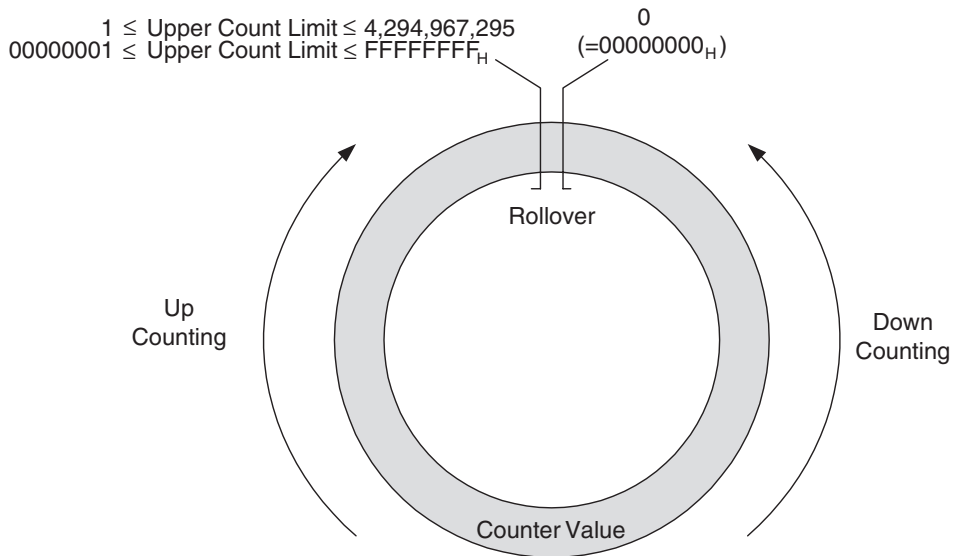

Configuring Upper Count Limit

The Upper Count Limit can be configured between 1 and 4,294,967,295 (=FFFFFFF_H). By default the Upper Count Limit is equal to the maximum possible count limit of FFFFFFFF_H.

For Circular Counters the Counter automatically rolls over to 0 if the Counter Value exceeds the Upper Count Value and continues counting. If the Counter Value goes below 0 the Counter rolls over to the Upper Count Value and continues counting.

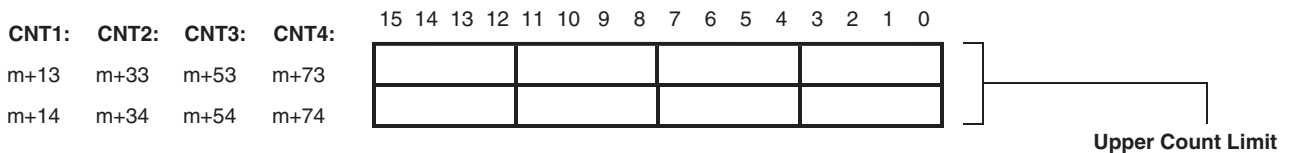

Set Upper Count Limit for Circular Counters between 00000001_H and FFFFFFFF_H.
Per default (=00000000_H) the Upper Count Limit is equal to FFFFFFFF_H.

Configuring Error-Code Generation

To configure Overflow/Underflow Error Code Generation for a Linear Counter refer to section the following:

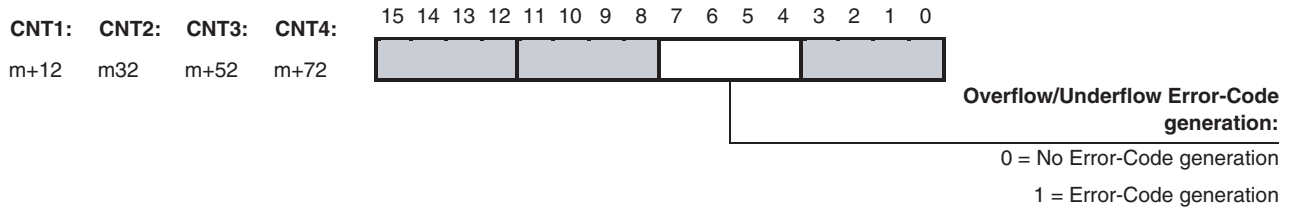

Reporting Overflow and Underflow

An Overflow or Underflow of a Linear Counter is reported in the corresponding bits in CIO.

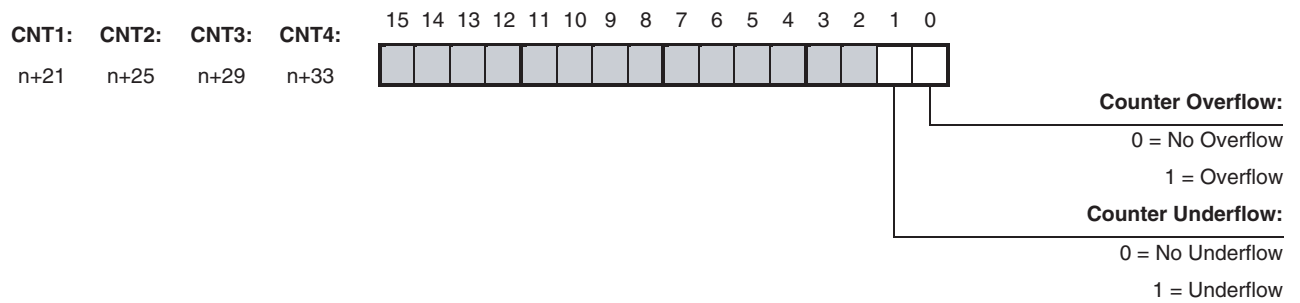

3-3 Input Signal Types

The type of input you require for your application is selected by means of four bits in the Signal Type Word in DM. For every Counter the Signal Type can be selected individually.

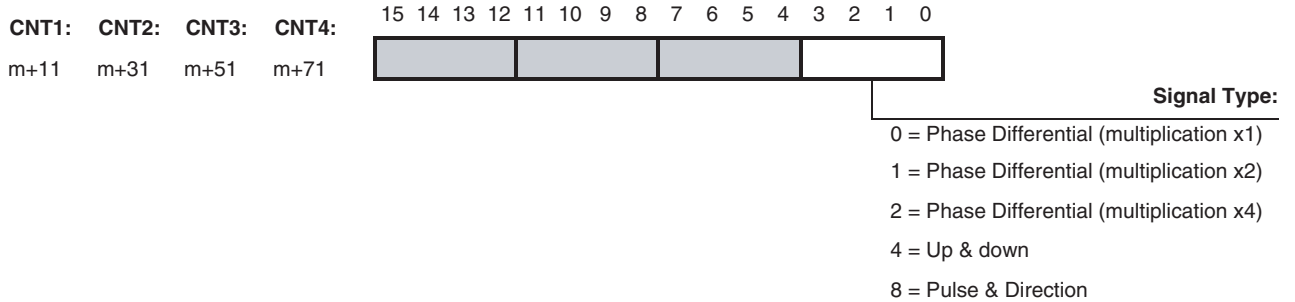

3-3-1 Phase Differential

Phase Differential Signals are connected to the inputs A, B and Z of every Counter. The count direction is determined by the phase angle between input A and input B. If signal A leads to B, the counter increments. If signal B leads to A, the counter decrements.

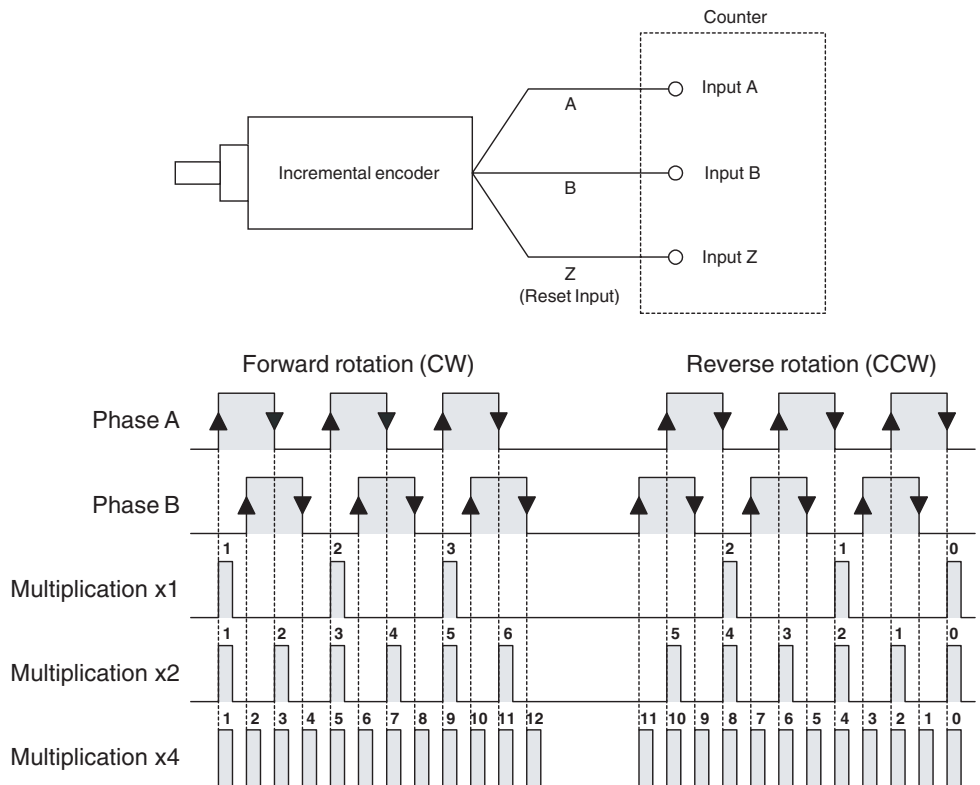

Multiplication x1

By default the Counter is configured for Multiplication by 1. If the counter is up-counting (signal A leads to signal B) pulses are taken into account by the Counter on the rising edges of signal A. If the Counter is down-counting pulses are taken into account on the falling edges of input A.

Multiplication x2

To increase the resolution of the incremental encoder the Counter can be configured for Multiplication by 2. If the Counter is up-counting (signal A leads to signal B) pulses are taken into account by the Counter on the rising- and falling edges of signal A. If the Counter is down-counting pulses are also taken into account on the rising- and falling edges of signal A.

Multiplication x4

To further increase the resolution of the incremental encoder Multiplication *4 should be selected. If the Counter is up-counting (signal A leads to signal B) pulses are taken into account by the Counter on the rising- and falling edges of signal A and signal B. If the counter is down-counting pulses are also taken into account on the rising- and falling edges of signal A and B.

Note For Counter Reset options (Z-input included) refer to section Section 3-6 *Reset Signals*.

3-3-2 Up & Down

With this Signal Type the Counter increments on the rising edge of pulses applied to input A and decrements on the rising edge of pulses applied to input B.

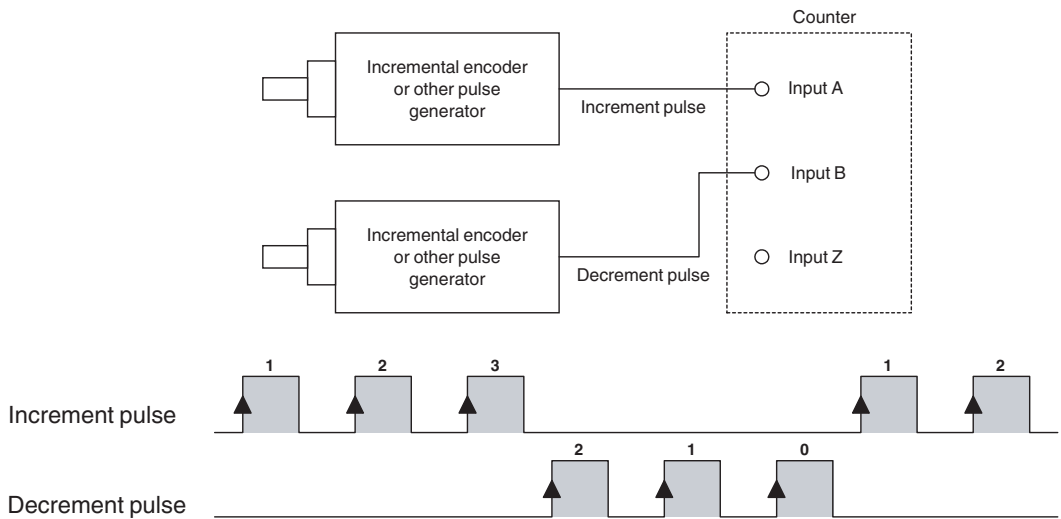

Note For Counter Reset options refer to section Section 3-6 *Reset Signals*.

3-3-3 Pulse & Direction

In this configuration, count pulses are applied to input A. The direction of counting is controlled by the level of the signal applied to input B. If input B is high, the Counter increments on the rising edges of input A. If input B is low, the Counter decrements on the rising edges of input A.

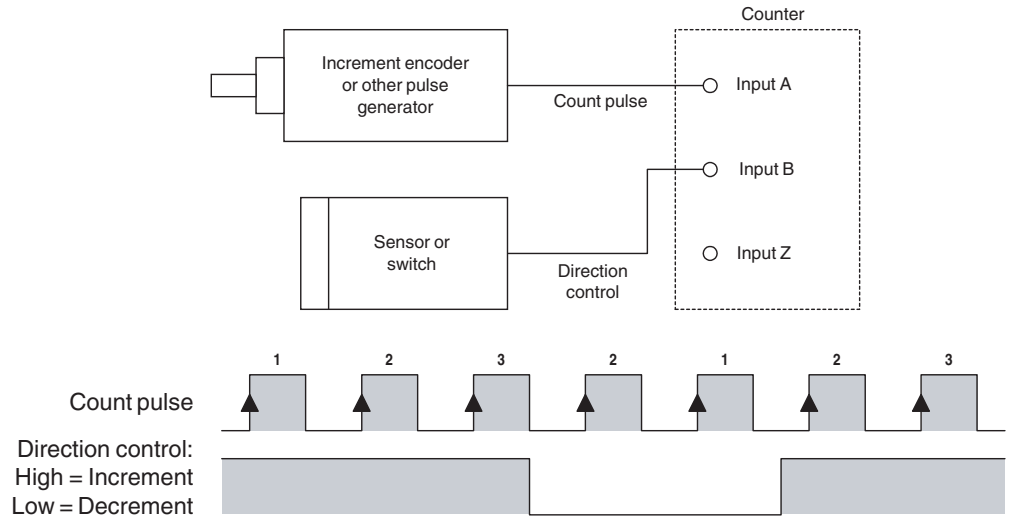

Note For Counter Reset options refer to section Section 3-6 *Reset Signals*.

3-4 Controlling a Counter

Each Counter Input contains a gate through which the counting function can be enabled or disabled. When disabled, the gate will block incoming counter signals. The Gate of a Counter can be enabled and disabled by using the "Open Gate Bit" and "Close Gate Bit" in CIO.

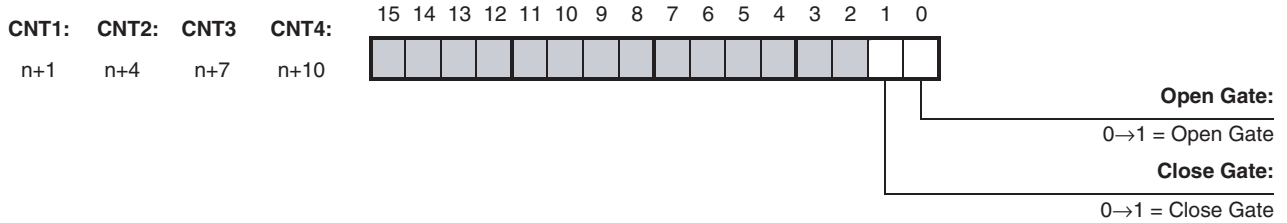

A rising edge of the "Open Gate Bit" opens the Gate regardless of the state of the "Close Gate Bit". A rising edge of the "Close Gate Bit" closes the Gate regardless of the state of the "Open Gate Bit". At a simultaneous rising edge of both bits, the state of the Gate is unchanged.

Note Initially, at power up or restart of the Unit, for both counter types (i.e. Circular-, and Linear Counters) the Gate is closed and counting is disabled. In order to enable counting you must open the Gate first.

Preset Function

The Unit is equipped with a Preset Register for every Counter that contains the Preset Value. To change the Preset Value you can change the (32-bits) Preset Value in CIO of the corresponding Counter. The Counter Value is overwritten with the Preset Value at a rising edge of the Preset Counter Bit of the corresponding Counter.

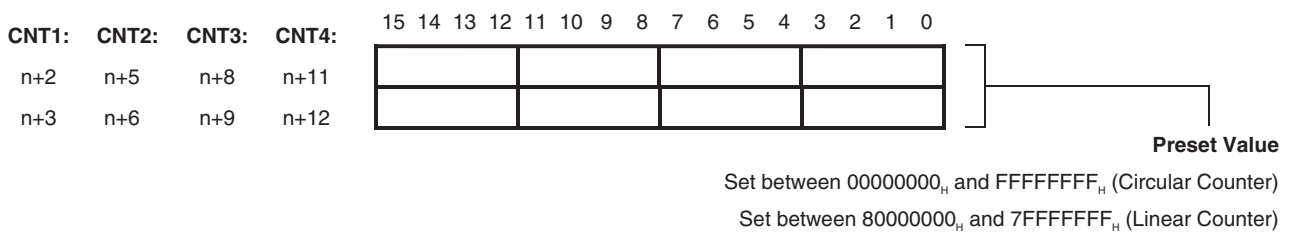
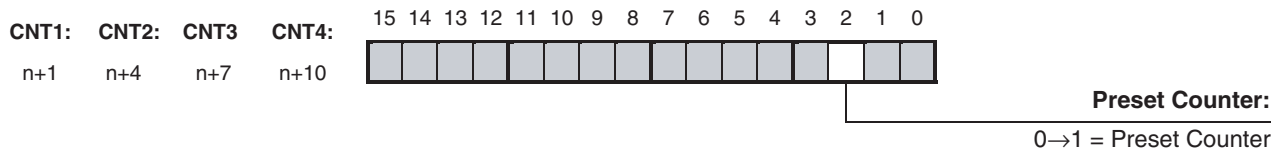

Reset Function

To reset a Counter, through a signal pulse on the corresponding Z-input, the Z-input Reset Enable bit must be set to 1. A Counter can also be reset by using the "Software Reset Bit" in CIO. Setting this bit to '1' causes a forced reset of the corresponding Counter. Refer to section Section 3-6 *Reset Signals* for detailed information about resetting Counters.

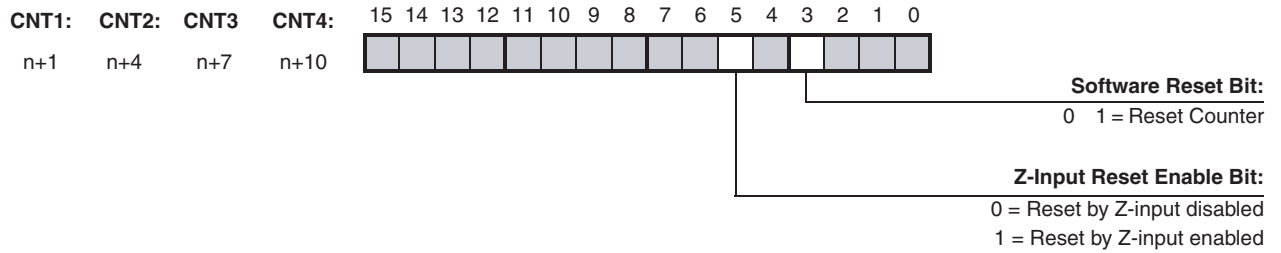

Capture Function

The Unit is equipped with a Capture Register for every Counter, which will contain an actual Counter Value captured at a user defined moment in time. Every time a Counter Value is captured, the contents of the Capture Register is overwritten with the new Captured Value and the old Captured Value is lost. The Counter Value can be captured by using the “Capture Counter Value Bit” in CIO.

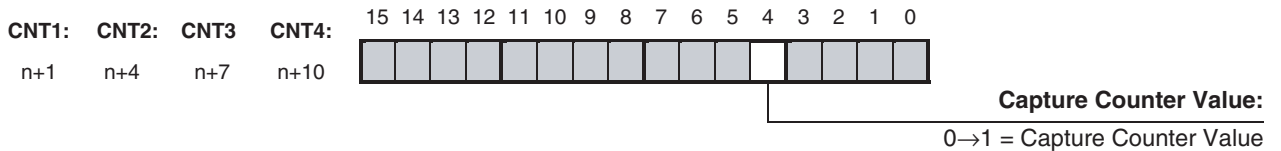

If you want to use the Captured Value in your Ladder Program, you must use the IORD-instruction to obtain the value. This instruction reads the Captured Value from the Unit into a specified location in the memory of the PLC. For more details on using the IORD-instruction and reading the Captured Value refer to section Section 4-4 *IORD-Instruction*.

Note The Open Gate Bit, Close Gate Bit, Preset Counter Bit, Reset Bit, or the Counter Capture Bit in CIO may not be executed if turned ON for only one PLC cycle. Always keep these bits turned ON until the execution status changes for the corresponding flags in n+21, n+25, n+29 or n+33.

Z-Input Status

For each counter the Z-input status is reflected in CIO. The bit is ON for exactly one PLC-cycle-time after the Z-input has been activated.

Counting Direction

For every Counter the (up or down) counting direction is indicated and can be used in the Ladder Program.

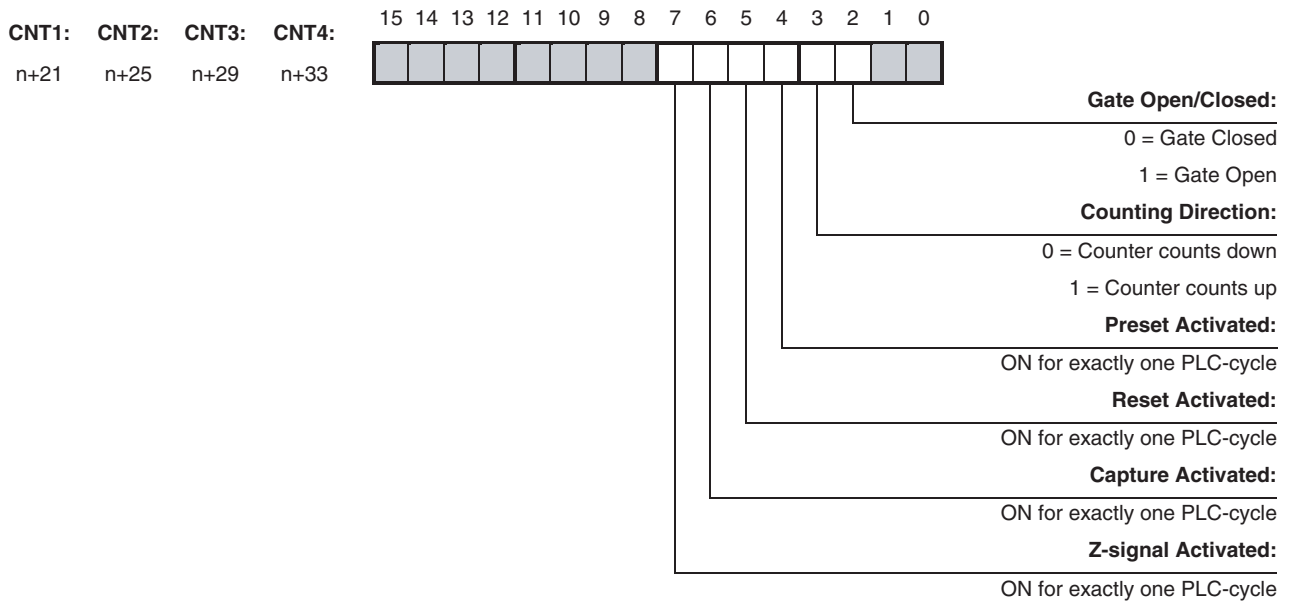

The Reset, Preset, Capture and Z-signal Activated Bits are ON for exactly one PLC-cycle after the occurrence of a (short) pulse which was detected since the previous I/O Refresh.

3-5 Output Control

Output Control Mode

The 32 Outputs of the Counter Unit can be controlled automatically in two ways:

- **Range Mode**
 In Range Mode you can define up to a maximum of 4 Ranges per Counter. The Outputs are controlled according to the Counter Value being within Range Limits. For a detailed description about Range Mode refer to section 3-5-1 Range Mode.
- **Comparison Mode**
 In Comparison Mode you can define up to a maximum of 8 Comparison Values per Counter. The Outputs are controlled according to the direction in which the Counter Value crosses the Comparison Value. For a detailed description about Comparison Mode refer to section 3-5-2 Comparison Mode.

If the Unit is configured for Range Mode all Counters will operate in Range Mode. If the Unit is configured for Comparison Mode all Counters will operate in Comparison Mode.

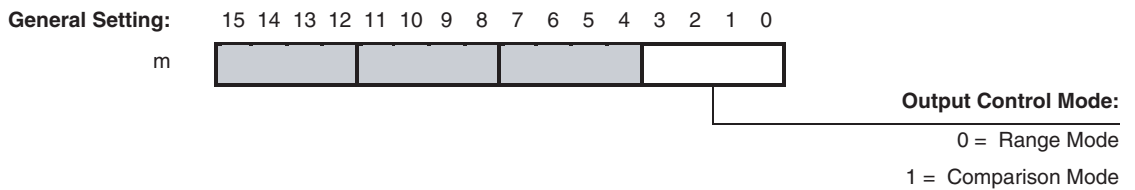

3-5-1 Range Mode

If the Unit is configured to control the Outputs in Range Mode, this Mode can be applied to Circular Counters or Linear Counters (refer to section Section 3-2-1 *Circular Counter* and Section 3-2-2 *Linear Counter* for more information).

Example Range Mode with Linear Counter

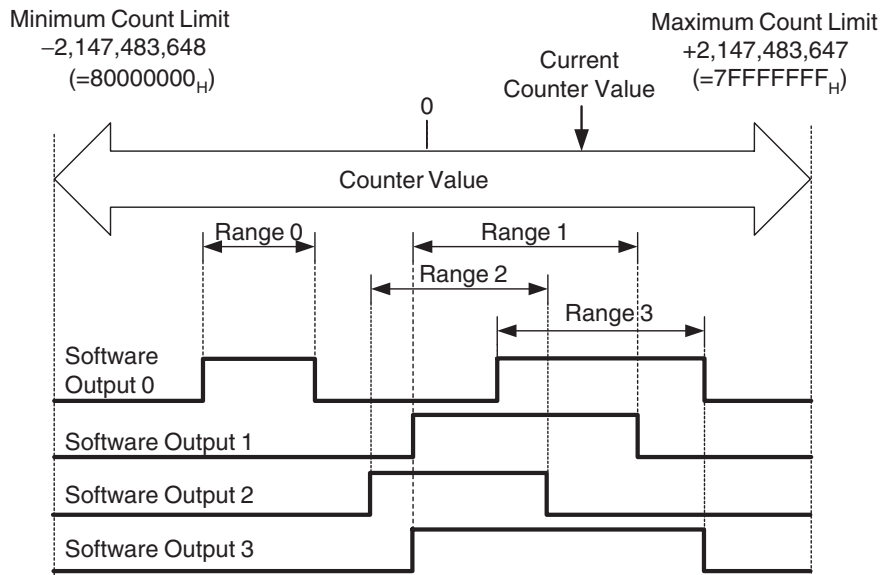

Range	Lower Range Limit	Upper Range Limit	Output ON
0	-20,000	-10,000	0
1	-1,000	+19,000	1, 3
2	-5,000	11,000	2
3	6,000	+25,000	0, 3

In this example four Ranges are specified. The configuration data of the Counter shows that:

- Software Output 0 must be ON for Counter Values within Range 0.
- Software Output 1 and 3 must be ON for Counter Values within Range 1.
- Software Output 2 must be ON for Counter Values within Range 2.
- Both the Software Outputs 0 and 3 must be ON for Counter Values within Range 3.

In the above example the Counter Value is within Range 1 and 3 and consequently the Outputs 0, 1 and 3 are turned ON.

Example Range Mode with Circular Counter

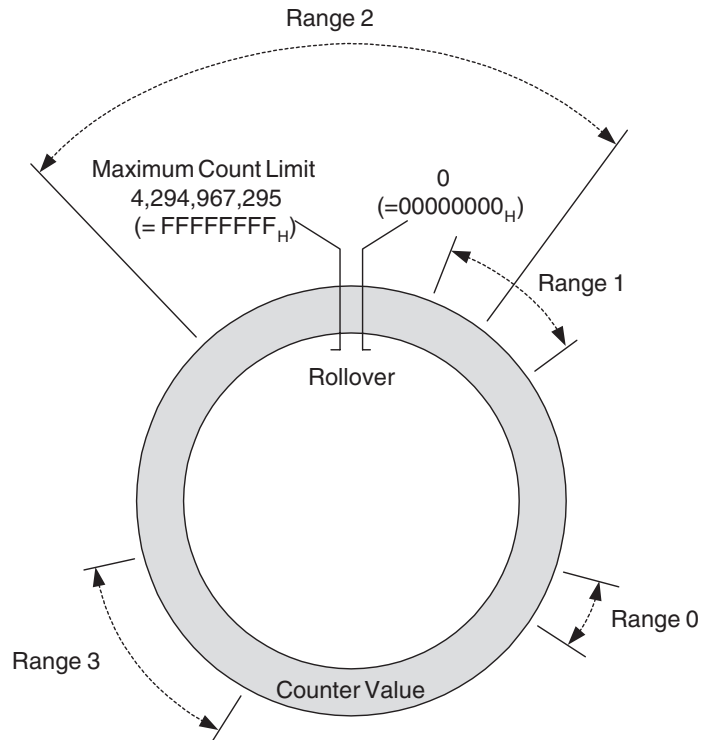

Range	Lower Range Limit	Upper Range Limit	Output ON
0	60,000	80,500	0
1	500	45,000	1, 3
2	37,000,000	6,000	2
3	99,000	150,000	0, 3

This example shows the Range Mode applied to a Circular Counter.

3-5-1-1 Range Mode Overview

The following figure gives an overview on configuring Counters in Range Mode.

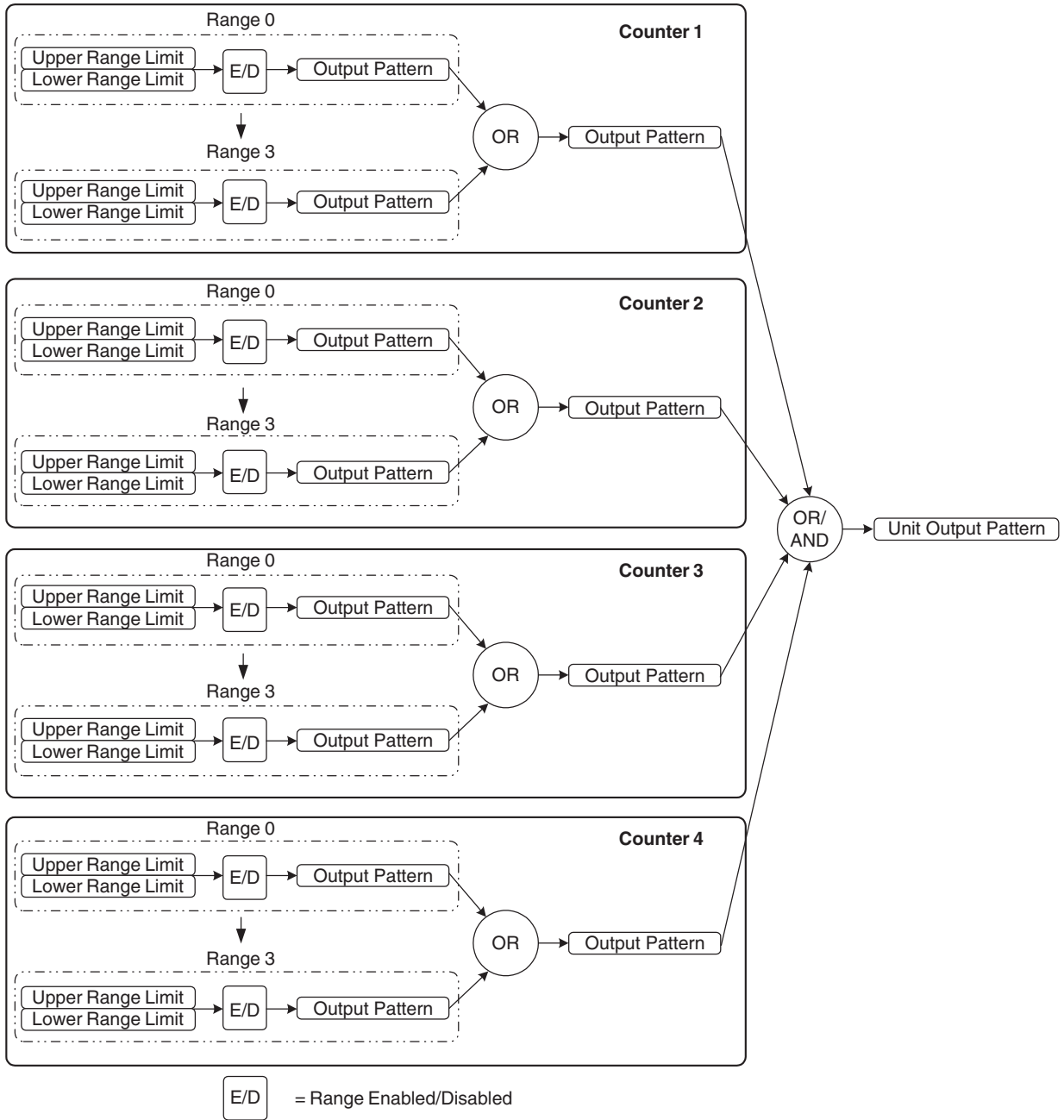

How to configure Counters in Range Mode is described on the next pages.

3-5-1-2 Configuration and operation in Range Mode

Specifying Range-Data

In Range Mode every Counter can be assigned up to a maximum of 4 Ranges. The Data of every Range is contained by 3 double words:

- Lower Range Limit, specifying the Lower Limit of the Range
- Upper Range Limit, specifying the Upper Limit of the Range
- Output Pattern, specifying which Outputs have to be activated when that Range is active

The Counter Type (Circular or Linear) determines the range in which the Upper and Lower Limits can be set. For Circular Counters this range is 00000000_H-FFFFFFF_H and for Linear Counters this range is 80000000_H-7FFFFFFF_H. For Linear Counters the Upper Range Limit must be greater than the Lower Range Limit. The Unit will generate an error if the Upper Range Limit \leq Lower Range Limit (refer to section Section 5-2 *Error codes* for more details). For Circular Counters, the Upper Range Limit can be set lower than the Lower Range Limit.

To configure a Counter in Range Mode for every Range that you want to use the Range-Data must be set. Each data-item is specified by two words (=32 bits). For the exact memory location to set the Range-Data refer to section Section 4-2-1 *Memory Mapping*.

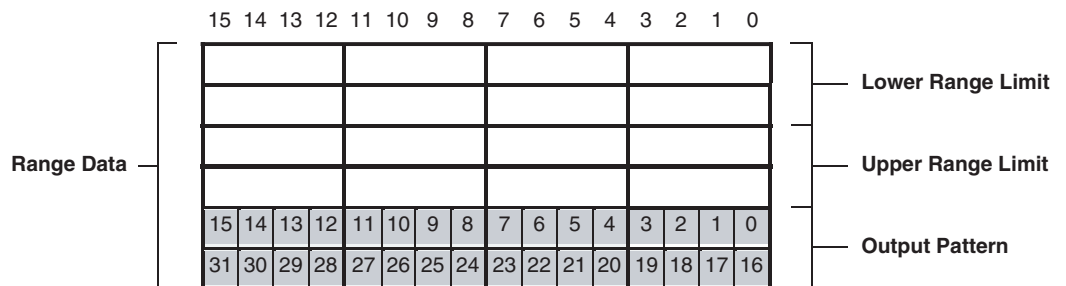

In the Output Pattern the Outputs are represented by:

= Soft Outputs 0-31

In the Output Pattern of the Range every single Output can be configured to turn ON when that Range is active. To configure an Output to turn ON you must set the corresponding bit to 1. If multiple Ranges of a Counter are active at the same time, the Output Patterns of those Ranges are logically OR'ed to become the Output Pattern of that Counter.

- Note**
1. If Range Mode is used with Ring Counter Mode, a maximum ring value of 3 or more should be set up. Note that a value of 1 or 2 will not generate an error message.
 2. The Counter Range-Data can also be changed during actual operation using the IOWR-instruction. Refer to section *Section 4-3 IOWR-Instruction* for more details.
 3. In Range Mode it is possible to apply Hysteresis to Ranges in order to prevent Outputs from toggling due to unwanted oscillating of an encoder. Refer to section Section 3-7-1 *Hysteresis* for detailed information.
 4. Precautions When Setting Range Data

- Comparison Stoppage during Comparison of Ranges

The comparison operation stops for 1.5 ms from when the Counter Value falls within the Upper Range Limit or Lower Range Limit for the Range Data. However, the comparison does not stop for other Counters.

Set the Range Data considering the time when the comparison is stopped. For example, for the Range table shown in the following diagram, approximately 4.8 counts occur during 1.5 ms when a 3.2 kHz pulse is input. This means that comparison does not occur for Counter Values 101, 102, 103, and 104. During this period, the Output set under the Output Pattern does not turn ON even if the Counter Value is within the Range Data range. Comparison starts again after this 1.5 ms has elapsed.

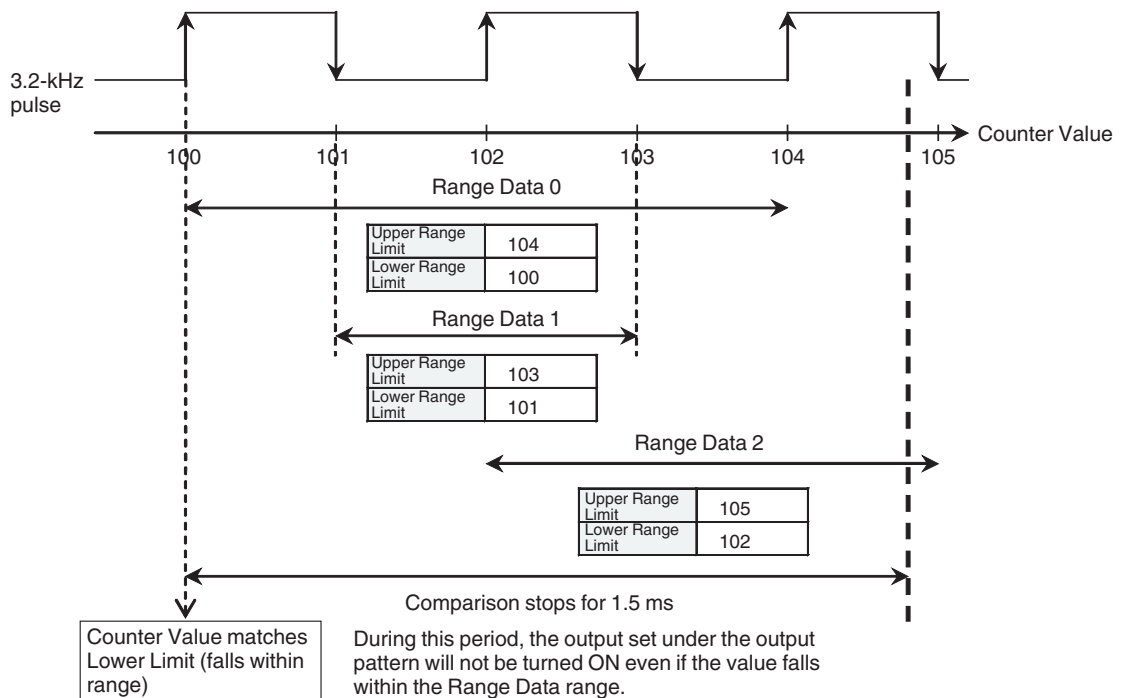

- Comparison Stoppage When IOWR and IORD-instructions Executed

Comparison is stopped during the execution of IOWR/IORD-instructions and remains stopped until the processing of the instruction has been completed. The Data Transfer Busy bit is ON during this time.

This stopping of comparison during the execution of IOWR/IORD-instructions affects Counter comparisons for all counters.

Set the Range Data considering that comparisons are stopped by execution of IOWR/IORD-instructions.

Refer to section Section Appendix D *Comparison between CJ1W-CTL41-E and other Counter Units* for information on execution times for IOWR/IORD-instructions.

Reflecting Active / Not Active Ranges

A Range becomes active if: Lower Range Limit ≤ Counter Value ≤ Upper Range Limit. Whether or not a Range is active is reflected in CIO for each Counter.

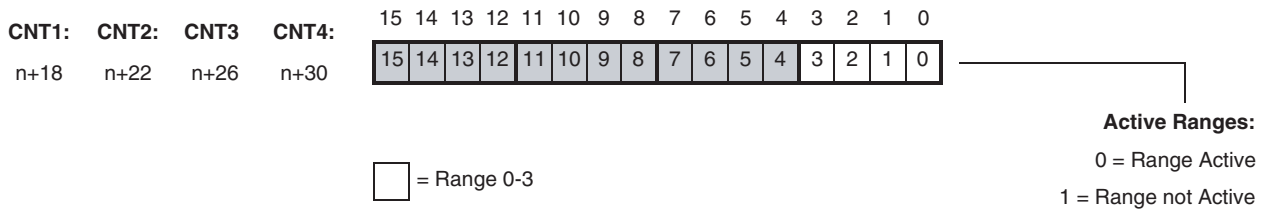

Range Active: Lower Range Limit ≤ Counter Value ≤ Upper Range Limit
 Range not Active: Counter Value < Lower Range Limit
 Counter Value > Upper Range Limit

Note Lower Range Limit = Upper Range Limit can be set under the Range conditions.

Enabling and Disabling of Ranges

Every single Range can be enabled or disabled. If a Range is disabled (by default) its Output Pattern will be ignored in the Unit Output Pattern calculation. If a Range is enabled the Output Pattern of that Range will be applied to the Output Pattern of the corresponding Counter when that Range becomes active. To Enable/Disable Ranges of Counters refer to section the following:

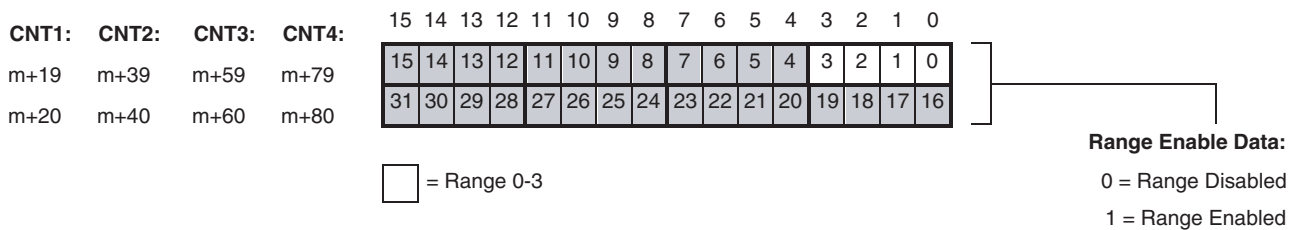

Note Enabling/Disabling of Ranges can also be done on the fly by using IOWR-instructions. Refer to section Section 4-3 *IOWR-Instruction* for more details.

Logically AND/OR Counter Output Patterns

If the Unit is in Range mode, the Output Patterns of the two Counters are (by default) logically OR'd and consecutively applied to the Unit Output Pattern. Depending on the requirements of your application you can also choose to AND the Counter Output Patterns before they are applied to the Unit Output Pattern.

If multiple Counters are used together to control an application, you have the option to logically AND or OR the Counter Output Patterns to become the Unit Output Pattern. In this way it is possible to turn Outputs ON or OFF depending on Ranges being active of multiple Counters. For instance, it is possible to turn an Output ON when both a Range of Counter 1 and a Range of Counter 2 are active. To configure the Unit to AND the Counter Output Patterns refer to section the following.

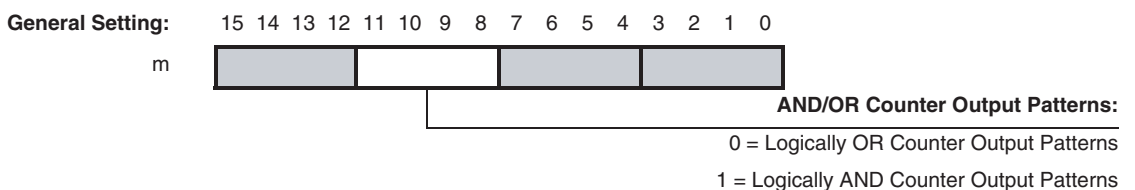

Note The Counter Output Patterns of Counters which are configured to use no (i.e. zero) Ranges, are ignored in the AND-calculation of the Unit Output Pattern. Like this, Counters that you do not want to use, do not influence the AND-calculation of the Unit Output Pattern. If both the Counters are configured to use no Ranges, the output patterns for both outputs will be all OFF.

3-5-2 Comparison Mode

If the Unit is configured to control the Outputs in Comparison Mode, this Mode can be applied to Circular Counters or Linear Counters (refer to section Section 3-2-1 *Circular Counter* and Section 3-2-2 *Linear Counter* for more information).

Example Comparison Mode with Linear Counter

Minimum Count Limit
-2,147,483,648
(=80000000_H)

Maximum Count Limit
+2,147,483,647
(=7FFFFFFF_H)

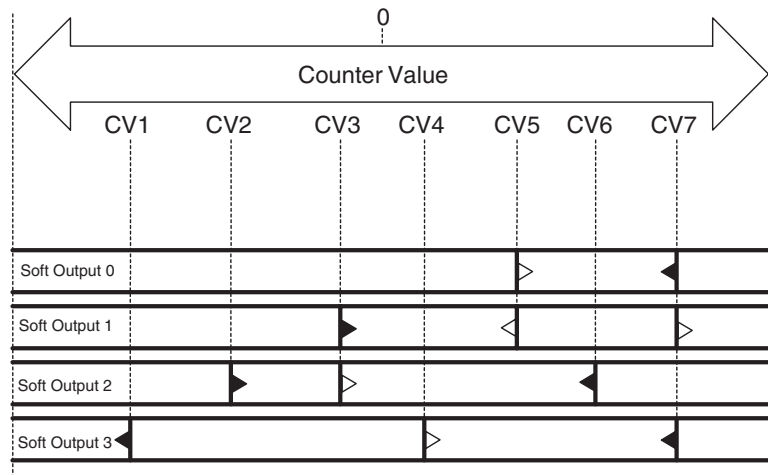

▷ = Set in positive (+) direction ▷ = Reset in positive (+) direction
 ◁ = Set in negative (-) direction ◁ = Reset in negative (-) direction

CV	Value	CV crossing	Soft0	Soft1	Soft2	Soft3
1	-87,000	+CV crossing				
		-CV crossing				R
2	-56,000	+CV crossing			R	
		-CV crossing				
3	-15,000	+CV crossing		R	S	
		-CV crossing				
4	+18,000	+CV crossing				S
		-CV crossing				
5	+46,000	+CV crossing	S			
		-CV crossing		S		
6	+70,000	+CV crossing				
		-CV crossing			R	
7	+108,000	+CV crossing				
		-CV crossing	R	S		R

In this example 7 Comparison Values are specified. On reaching a Comparison Value an Output can be Set or Reset depending on the crossing direction. If the

CV is crossed in the positive counting direction (+CV crossing) or negative counting direction (-CV crossing), one or multiple Outputs can be Set (S) or Reset (R). For example Output 0 is Set on crossing CV5 in the positive counting direction and Reset on crossing CV7 in the negative counting direction. The crossing of CV3 in the positive counting direction results in the Setting of Output 2 and the Resetting of Output 1.

Example Comparison Mode with Circular Counter

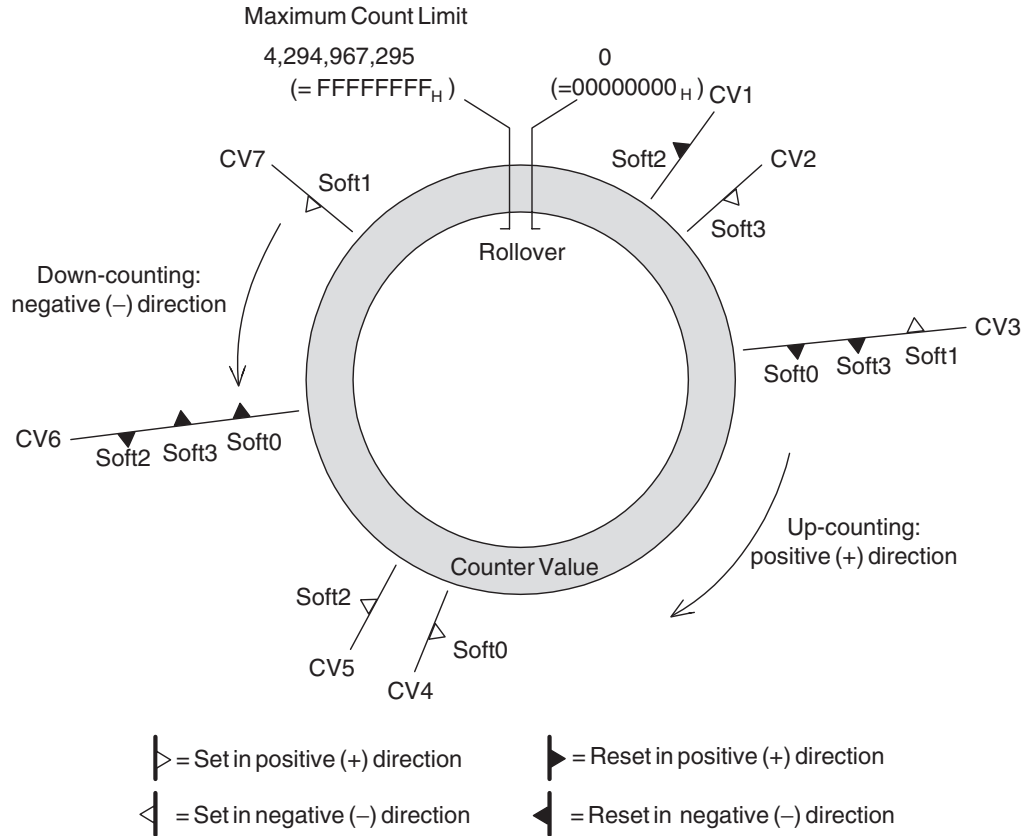

CV	Value	CV crossing	Soft0	Soft1	Soft2	Soft3
1	750	+CV crossing				
		-CV crossing			R	
2	1,800	+CV crossing				S
		-CV crossing				
3	59,000	+CV crossing	R			R
		-CV crossing		S		
4	85,000	+CV crossing				
		-CV crossing	S			
5	90,000	+CV crossing			S	
		-CV crossing				
6	108,000	+CV crossing	R			R
		-CV crossing			R	
7	125,000	+CV crossing				
		-CV crossing		S		

This example shows the Comparison Mode applied to a Circular Counter.

3-5-2-1 Comparison Mode Overview

The following figure gives an overview on configuring Counters in Comparison Mode.

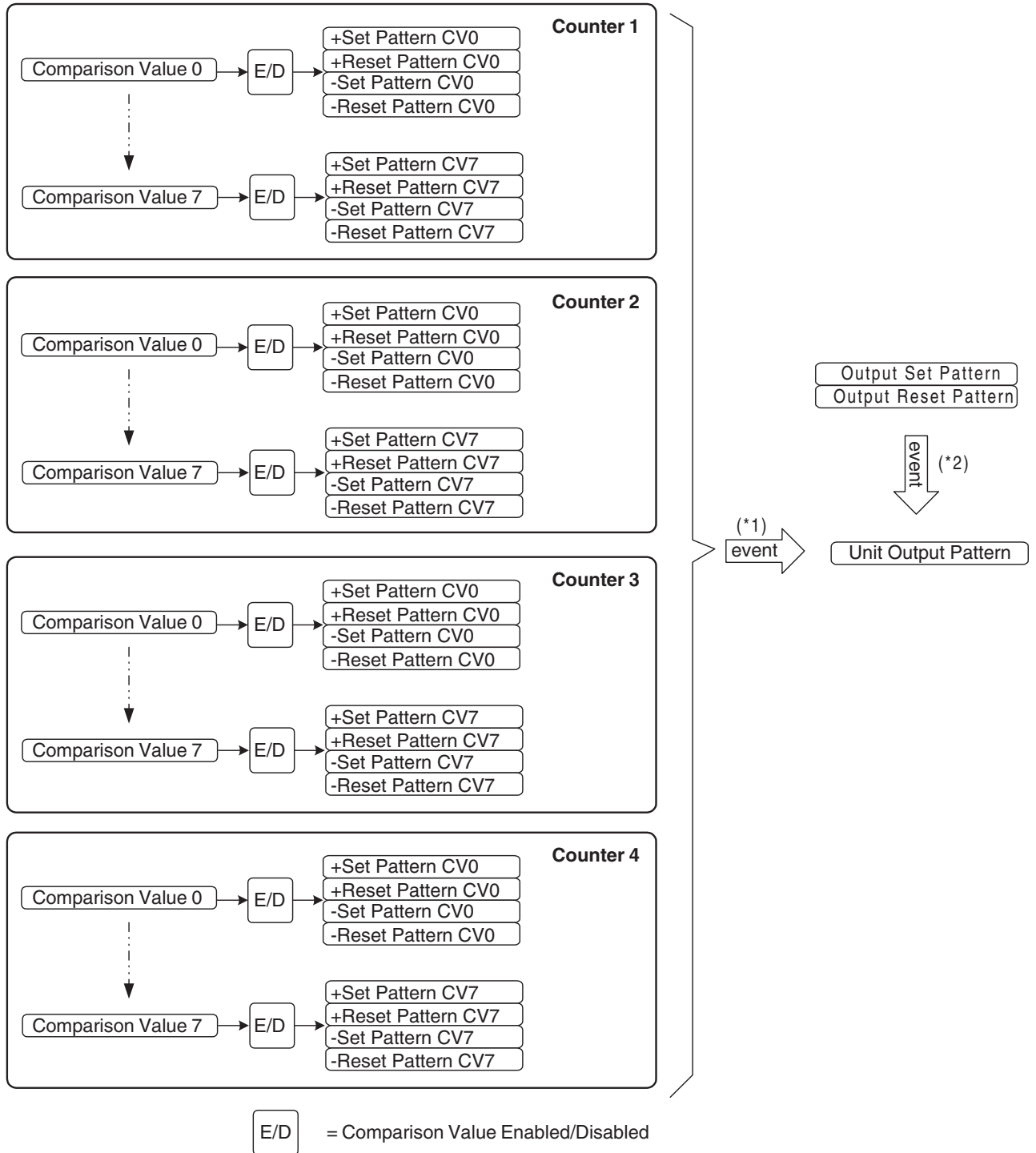

(*1) Event = Crossing of Comparison Value
 (*2) Event = Preset or Reset Action

How to configure Counters in Comparison Mode is described on the next pages.

3-5-2-2 Configuration and operation in Comparison Mode

Specifying Comparison-Data

In Comparison Mode every Counter can be assigned up to a maximum of 8 Comparison Values. The Data of every Comparison Value (CV-Data) is contained by 5 double words:

- Comparison Value (can be set between 80000000_H – 7FFFFFFF_H for a Linear Counter and between 00000000_H – FFFFFFFF_H for a Circular Counter)
- Output Set Pattern for the positive counting direction (+Set Pattern CV'n'), specifying which Outputs must be Set on reaching that CV in the positive counting direction (0 = No Change, 1 = Set Output)
- Output Reset Pattern for the positive counting direction (+Reset Pattern CV'n'), specifying which Outputs must be Reset on reaching that CV in the positive counting direction (0 = No Change, 1 = Reset Output)
- Output Set Pattern for the negative counting direction (-Set Pattern CV'n'), specifying which Outputs must be Set on reaching that CV in the negative counting direction (0 = No Change, 1 = Set Output)
- Output Reset Pattern for the negative counting direction (-Reset Pattern CV'n'), specifying which Outputs must be Reset on reaching that CV in the negative counting direction (0 = No Change, 1 = Reset Output)

To configure a Counter in Comparison Mode for every Comparison Value that you want to use the CV-Data must be set. Each data-item is specified by two words (=32 bits). For the exact memory location of the CV-Data, refer to section *Section 4-2-1 Memory Mapping*.

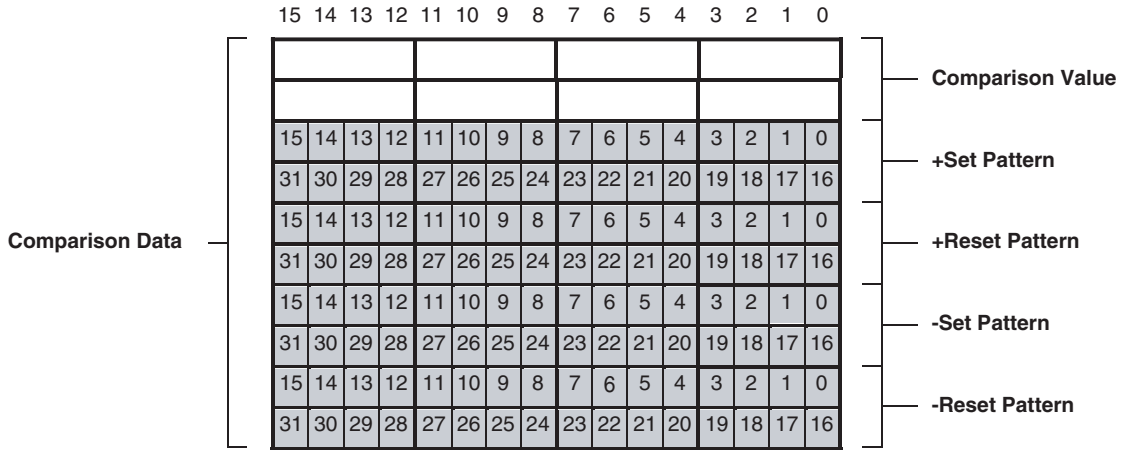

In the +/- Set and Reset Patterns the Outputs are represented by:

= Soft Outputs 0-31

On reaching the Comparison Value:

+ and – Set Patterns:	+ and – Reset Patterns:
0 = No Change	0 = No Change
1 = Set Output	1 = Reset Output

Note Precautions When Setting Comparison Data

- Comparison Stoppage When Comparison Target Reached
When the Counter Value reaches the target value for Comparison Data,

comparison stops for 1.5 ms. However, comparison for other counters does not stop.

Set the Comparison Data considering the time when the comparison is stopped.

For example, for the Comparison table shown in the following diagram, approximately 4.8 counts occur during 1.5 ms when a 3.2 kHz pulse is input. This means that comparison does not occur for Counter Values 101, 102, 103, and 104. During this period, the Output set under the Output Pattern does not turn ON.

Comparison starts again after this 1.5 ms has elapsed.

At this time, the processing returns to the stoppage period and Comparison Data 1 and 2 are executed at the same time.

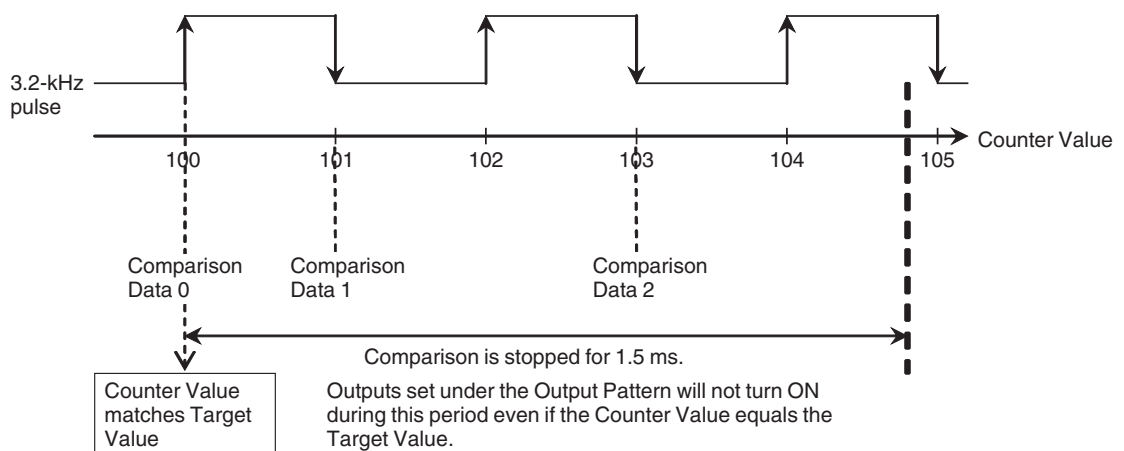

- **Comparison Stoppage for IOWR- and IORD-instruction Execution**
Comparison is stopped during the execution of IOWR/IORD-instructions and remains stopped until the processing of the instruction has been completed. The Data Transfer Busy bit is ON during this time. This stopping of comparison during the execution of IOWR/IORD-instructions affects Counter comparisons for all counters. In contrast to Range Data, comparison occurs once during the stoppage period after the Data Transfer Busy bit turns OFF. However, when Comparison Data is rewritten using an IOWR-instruction, the Comparison Result is refreshed using the new Comparison Data and the current Counter Value, which means the result of the comparison during the stoppage is not reflected.

Refer to section Section Appendix D *Comparison between CJ1W-CTL41-E and other Counter Units* for information on execution times for IOWR/IORD-instructions.

- Note**
1. If Comparison Mode is used with Ring Counter Mode, a maximum Ring Value 2 or more should be set up. Note that a value 1 will not generate an error message.
 2. Multiple Comparison Values of a specific Counter may not have the same value. The Unit will generate an error if multiple CV's have the same value (refer to section Section 5-2 *Error codes* for more details).
 3. CV-Data can also be changed on the fly. Refer to section Section 4-3 *IOWR-Instruction* for more details.
 4. The Outputs are Set/Reset in the chronological order of reaching the CV's. After reaching a (new) CV the (old) Unit Output Pattern is updated.

5. In case for a CV both a Set and a Reset in one and the same counting direction for a specific Output are defined, the Reset has priority.
6. The output can be set to Set, Reset, or *No Change* when a target value is reached both for incrementing and decrementing. Each time, the output pattern for both counters will change in the order targets are reached.
7. Do not change the counting direction quickly near a target value. If the direction is changed near a CV, the direction in which the target was reached (incrementing or decrementing) may be incorrectly detected.

Reflecting Active / Not Active Comparison Values

A Comparison Value becomes active if the Counter Value is greater than or equal to that Comparison Value. Whether or not a CV is active is reflected in CIO for each Counter.

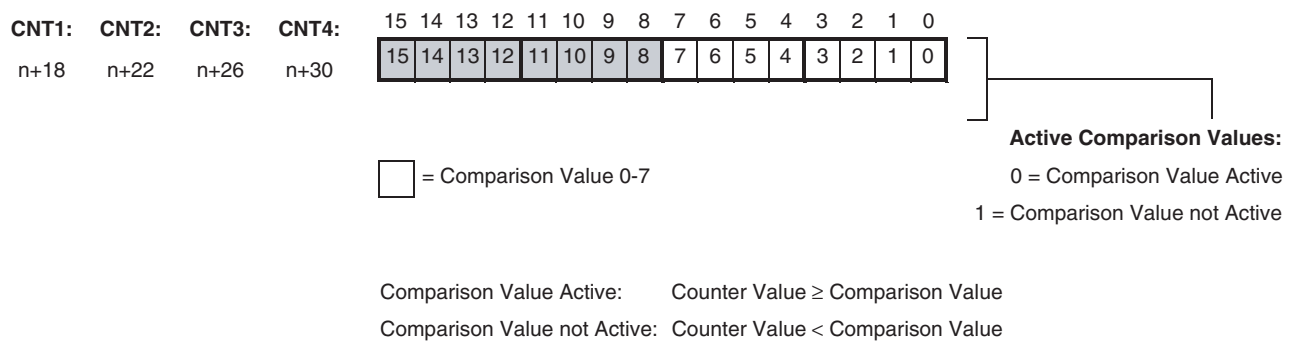

Note Each time a CV is crossed (in positive or negative counting direction) an Output can be Set, Reset or remain Unchanged. In this way, every Counter is able to change the Unit Output Pattern. Therefore, the Unit Output Pattern is updated by all four Counters in the chronological order of crossing the CV's.

Enable / Disable Comparison Values

Every single CV can be enabled or disabled. If a CV is disabled (by default) no action will be taken on reaching that CV. If a CV is enabled, depending on the direction of counting, the Set/Reset Output Patterns will be applied to the Unit Output Pattern on reaching that CV. To Enable/Disable CV's of Counters refer to section the following:

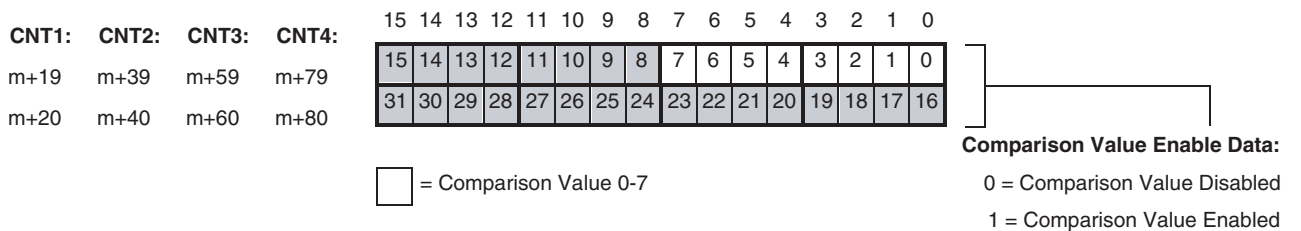

Note Enabling/Disabling of CV's can also be done on the fly by using IOWR-instructions. Refer to section Section 4-3 *IOWR-Instruction* for more details.

Updating Unit Output Pattern with Preset or Reset Action

Besides by crossing CV's the Unit Output Pattern can also be updated by a Preset or a Reset action. To trigger a Preset or Reset action refer to section *Section 3-4 Controlling a Counter* and Section 3-6 *Reset Signals*. Every Preset or Reset Action will then update the Unit Output Pattern according to the pre-defined Output Set and Output Reset Patterns. You can define an Output to be Set, Reset or remain Unchanged (similar as on reaching a Comparison Value).

CNT1:	CNT2:	CNT1:	CNT2:	15	14	13	12	11	10	9	8	7	6	5	4	3	2	1	0
m+21	m+41	m+61	m+81	15	14	13	12	11	10	9	8	7	6	5	4	3	2	1	0
m+22	m+42	m+62	m+82	31	30	29	28	27	26	25	24	23	22	21	20	19	18	17	16
m+23	m+43	m+63	m+83	15	14	13	12	11	10	9	8	7	6	5	4	3	2	1	0
m+24	m+44	m+64	m+84	31	30	29	28	27	26	25	24	23	22	21	20	19	18	17	16

Output Set Pattern

Output Reset Pattern

 = Soft Outputs 0-31

On triggering a Preset or Reset action:

Output Set Pattern:	Output Reset Pattern:
0 = No Change	0 = No Change
1 = Set Output	1 = Reset Output

Note In case for a Preset or Reset action for a specific Output both a Set and a Reset is defined the Reset has priority.

3-6 Reset Signals

For every Counter a reset of the Counter Value to zero can be triggered by the following Sources:

- Software Reset Bit
- Z-signal

In order for the Z-Signal to trigger a Reset this must be enabled by the Software Reset Enable Bit.

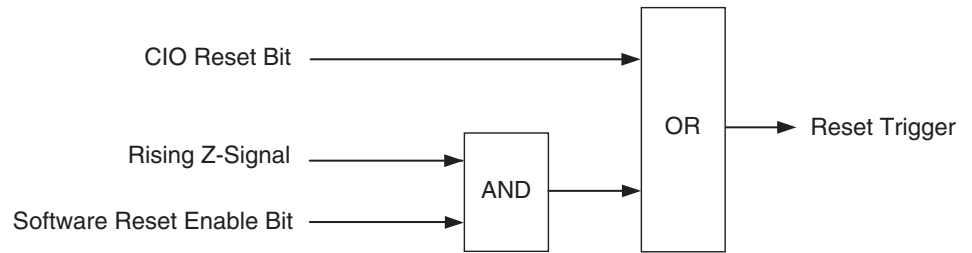

Software Reset Bit as Reset Source

For every Counter the Software Reset Bit can be used to trigger a Reset. The Software Reset Bit has priority over all other Reset Sources. Setting the Software Reset Bit triggers a Reset in the next I/O Refresh Cycle.

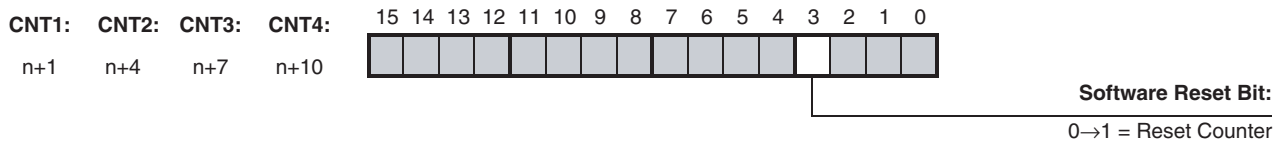

Z-Input Signal as Reset Source

If you want to use the Z-Signal of an incremental encoder as a Reset Source this must first be enabled in DM. Using the Z-Signal can be enabled for every Counter.

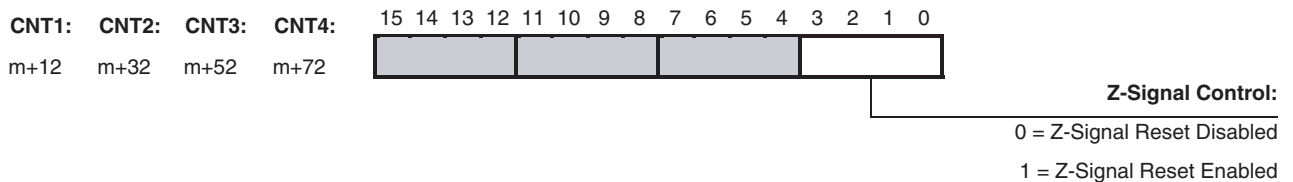

Software Reset Enable Bit as Reset Enable Source

Resetting the Counter Value to zero by Z-Signal must be enabled. Enabling can be done by setting the Software Reset Enable Bit in CIO for the corresponding Counter to 1.

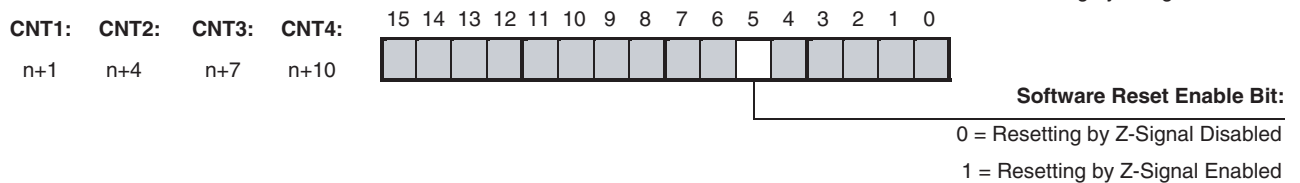

3-7 Extra Functions

3-7-1 Hysteresis

An encoder can come to rest at a particular position and then “oscillate” around this position. This state means that the Counter Value fluctuates around a particular value. If, for example, a Range Limit is in this area of fluctuation, the corresponding Range would become active and inactive in the rhythm of these fluctuations. To prevent outputs from being switched ON and OFF by very small fluctuations, the Counter Unit offers the Hysteresis Function that can be configured for every Counter separately. You can assign Hysteresis in a range from 1 to 255 counts (= 0001_H – 00FF_H) from which the Counter treats the fluctuation in the Counter Input Signal as a real change and outputs can be controlled accordingly.

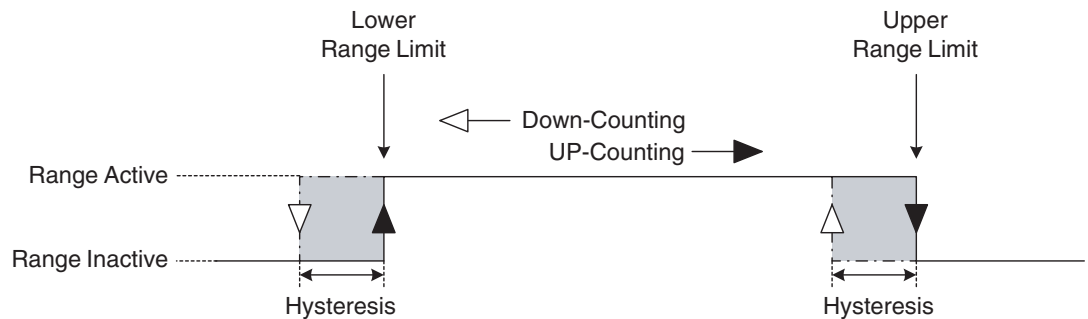

Configuring Hysteresis

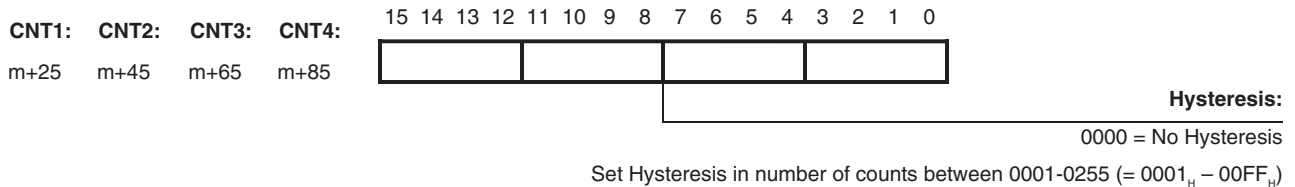

- Note**
1. The Hysteresis can only be applied to Units in Range Mode. If the Unit is in Comparison Mode you are able to configure Hysteresis yourself using Comparison Values.
 2. Do not set the origin (i.e., a present value of 0) within the Hysteresis-Area.
 3. If the Counter is Preset, turn OFF the Hysteresis. If the Counter is Preset in the Hysteresis-Area, the Outputs will not be controlled correctly.

3-7-2 Initial Counter Value

Every Counter is equipped with the Initial Counter Value (double word) in DM. At a transfer of the DM-settings from the CPU to the Unit (triggered by a Power Up or Restart of the Unit) the Initial Counter Value is also transferred. The Initial Counter Value overwrites the Counter Value and becomes the new Counter Value.

The Initial Counter Value is very useful in case the Power of the PLC-system fails. If the Power of the PLC-system fails, the application that is controlled by the Counter Unit will come to rest, and the Counter Values will be reset to zero. After the system has been Powered Up again, the application has to be reset, since it has lost the position data with the resetting of the Counter Values.

To overcome this trouble, the Power OFF Interrupt Task of the PLC can be used to detect the failing system Power. You can use this Power OFF Interrupt Task to program a transfer of the Counter Values of every Counter (in CIO) to the corresponding Initial Counter Value of that Counter in DM. The data in DM is retained when the Power is OFF. Therefore, Powering Up the system again, results in a transfer of the DM-settings from the CPU to the Unit and the Counter Value is overwritten by the Initial Counter Value, allowing your application to continue from where it was at the moment of failing Power.

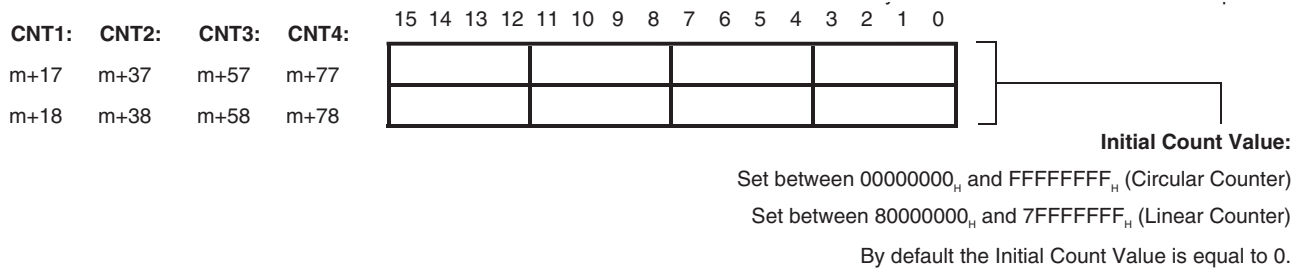

- Note**
1. The Power OFF Interrupt Task that takes care of saving the Counter Values to the Initial Counter Values can also be used to detect a Power OFF that has been done on purpose.
 2. The Initial Counter Value can also be set, independent of a Power Failure, to load the Counter Value with an Initial Value instead of zero.
 3. The Present Value stored by the interrupt task must be used considering the possibility of a power interrupt to the Encoder and interrupt processing execution timing.

SECTION 4

Exchanging Data with CPU

This section provides information on exchanging data between CJ1W-CTL41-E High Speed Counter Units and CJ-series CPU Units.

4-1	Overview.....	58
4-1-1	Basic Setup.....	58
4-1-2	Special I/O Units Restart bits.....	60
4-2	Memory Allocation.....	61
4-2-1	Memory Mapping.....	61
4-2-2	Indirect Addressing.....	62
4-2-3	CIO-Memory Mapping.....	65
4-2-4	DM-Memory Mapping.....	69
4-2-5	Range Memory Mapping.....	74
4-2-6	Comparison Memory Mapping.....	75
4-3	IOWR-Instruction.....	77
4-4	IORD-Instruction.....	79
4-5	Supported IOWR/IORD-Instructions.....	81
4-5-1	DM-data.....	81
4-5-2	Range- and Comparison data.....	83
4-5-3	Special data.....	86
4-6	Interrupts.....	88
4-6-1	Outputs Generating Interrupts.....	88

4-1 Overview

4-1-1 Basic Setup

The status information of the Counter Unit is exchanged with the CPU every cyclic I/O Refresh via the Special I/O Unit Area (CIO). The Unit configuration data is exchanged at Power ON or after the Unit has been restarted or after issuing the IOWR-instruction "(Re) Configure Unit" (refer to section 4-5-3-3 "(Re) Configure Unit"). The Unit configuration data consists of the configuration data in the Special I/O Unit DM Area and the Range/Comparison Data.

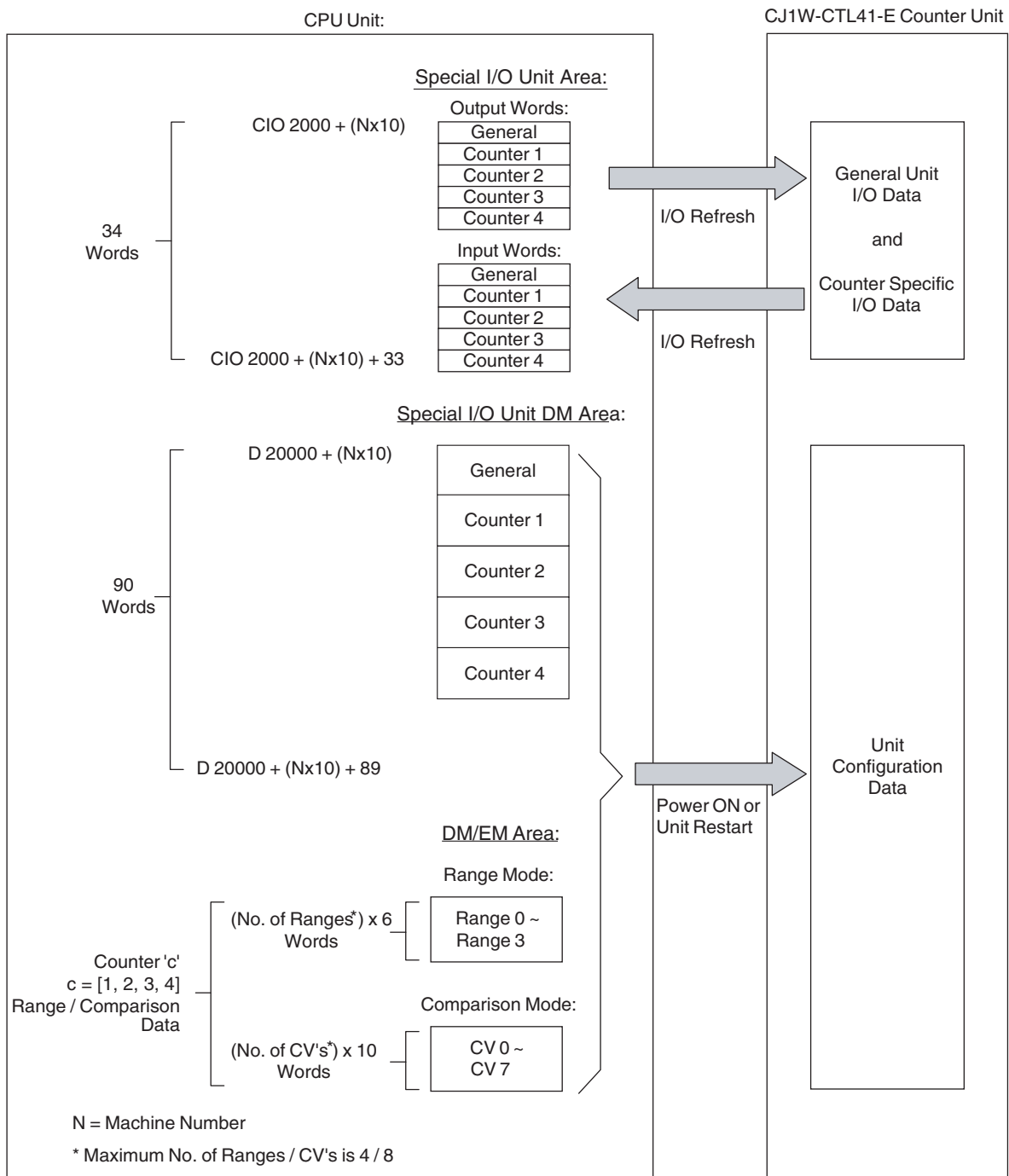

Special I/O Unit Area and Special I/O Unit DM Area

The Special I/O Unit Area and the Special I/O Unit DM Area are reserved for the Unit according to the Machine Number (=N) set. For the Special I/O Unit Area 34 CIO words are allocated and for the Special I/O Unit DM Area 90 DM words are allocated. For more information on the exact memory location of the Special I/O Unit and Special I/O Unit DM Areas and the Machine Numbers that can be set, refer to section 2-1-3 "*Machine Number Switch*".

Unit Status Data

The Special I/O Unit Area contains the status information of the Counter Unit in CIO and is divided in an area with output words and an area with input words. Both areas are divided in three parts: a general part and two Counter specific parts, and these are updated cyclically every I/O refresh.

Unit Configuration Data

The Unit configuration data is located in the Special I/O Unit DM Area, which is allocated to the Counter Unit, and the Range/Comparison Data. The Mode for which the Unit is configured determines if you have to set Range or Comparison Data (refer to section 3-5-1 "*Range Mode*" and 3-5-2 "*Comparison Mode*" for more information). The location of the Range/Comparison Data is indicated by an Indirect Address that you have to specify for every Counter (refer to section 4-2-2 "*Indirect Addressing*" for detailed information).

The Special I/O Unit DM Area contains the configuration settings of the Counter Unit. It is divided in three parts: a general part and two Counter specific parts. The general part contains the settings that are relevant for the whole Unit and the Counter specific parts contain the settings that are relevant to the specific Counters.

The Unit Configuration Data is transferred to the Counter Unit at Power Up or after the Unit has been restarted (refer to section 4-1-2 "*Special I/O Units Restart bits*").

Note

- The Unit configuration data can also be transferred during actual operation of the Unit, by issuing an IOWR-instruction (refer to section 4-5-3-3 "*(Re) Configure Unit*").
- I/O Refresh will not occur while the Data Transfer Busy bit (CIO n+17, bit 02) is ON. For example, the Counter Value will not be refreshed while the bit is ON.

4-1-2 Special I/O Units Restart bits

By turning the Unit Restart Bit from OFF to ON the Unit can be restarted. Restarting the Unit can be used to transfer the Unit configuration settings (e.g. after correction of an error) from the CPU to the Unit.

Bit	Function	
A50200	Unit No. 0 Restart Bit	Restarts the Unit when turned from OFF to ON.
A50201	Unit No. 1 Restart Bit	
~	~	
A50215	Unit No. 15 Restart Bit	
A50300	Unit No. 16 Restart Bit	
~	~	
A50715	Unit No. 95 Restart Bit	

The Unit can also be restarted by turning the Power from OFF to ON.

4-2 Memory Allocation

4-2-1 Memory Mapping

The following figure shows how the 34 words in the Special I/O Unit Area (CIO) and the 90 reserved words in the Special I/O unit DM Area (DM) are mapped in the memory of the CPU-Unit.

An Indirect Address at the end of every Counter specific block in DM specifies where the Range or Comparison Data of the corresponding Counter is allocated.

CIO Memory Mapping Output Words
(Refer to 4-2-3 for details)

General	n
Counter 1	n+1 n+3
Counter 2	n+4 n+6
Counter 3	n+7 n+9
Counter 4	n+10 n+12

CIO Memory Mapping Input Words
(Refer to 4-2-3 for details)

General	n+13 n+17
Counter 1	n+18 n+21
Counter 2	n+22 n+25
Counter 3	n+26 n+29
Counter 4	n+30 n+33
Not used	n+34 n+39

$n = \text{CIO } 2000 + (N \times 10)$
N = Machine Number

Range Memory Mapping (Refer to 4-2-5 for details)
Comparison Memory Mapping (Refer to 4-2-6 for details)

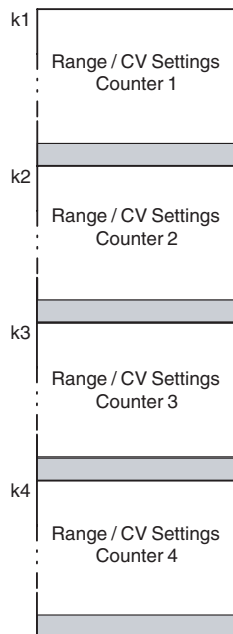

DM-Memory Mapping
(Refer to 4-2-4 for details)

General	m m+9
Counter 1	m+10 Indirect Address k1 m+29 m+30
Counter 2	Indirect Address k2 m+49 m+50
Counter 3	Indirect Address k3 m+69 m+70
Counter 4	Indirect Address k4 m+89 m+90
Free DM	m+399

$m = D \ 20000 + (N \times 100)$
N = Machine Number
k1, k2, k3, k4 = Any available address in DM/EM
(Refer to 4-2-2 for more details about Indirect Addressing)

Note The Range/Comparison Data blocks that are allocated to the Counters do not necessarily have to be consecutive and can be in any area of DM/EM. In case they overlap the Unit reports this in CIO as a warning, but does not generate an error. This makes it possible to define only one block with Range/Comparison data and to use this data for all Counters by using two identical indirect addresses ($k_1=k_2=k_3=k_4$).

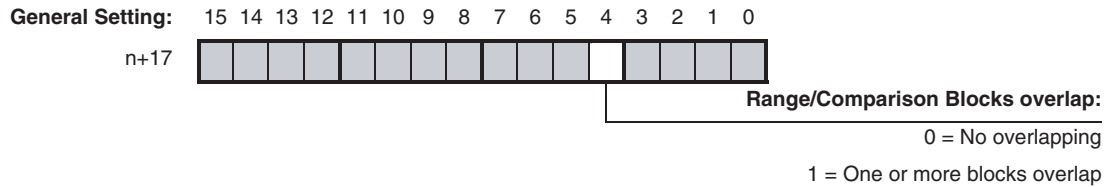

4-2-2 Indirect Addressing

The Counter Unit can be in Range Mode or Comparison Mode (refer to section 3-5-1 "Range Mode" and 3-5-2 "Comparison Mode" for more information). The Range or Comparison Data is allocated in the Extended Memory Area (EM) or in the Data Memory Area (DM). An Indirect Address, that you can set for every Counter in the Special I/O Unit DM Area, points to the actual memory location in DM or EM where the Range or Comparison Data of that Counter is stored.

Note It is also possible to use the free DM, in the Special I/O Unit DM Area that is allocated to the Counter Unit, to store the Range/Comparison Data. There are 309 free DM-words (=399-90).

Unit in Range Mode

In Range Mode Indirect Addressing can be used to define the Ranges per Counter that you want to use. The number of Ranges (M) defines the size of the Range Data block (size = M x 6 words). If you want to use multiple Ranges you are recommended to use consecutive Ranges starting from Range 0 (i.e. Range 0, 1, 2, 3 → M - 1) in order to save memory occupation.

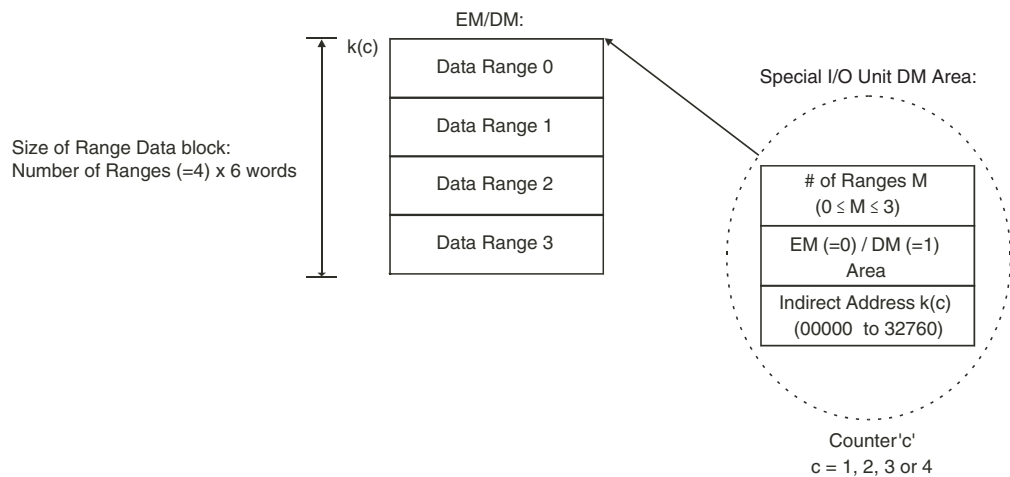

* Assumed that M ≠ 0. By default M = 0 which means that no Ranges will be used

Note If you do not want the Ranges to be consecutive and only intend to use two Ranges (e.g. Range 0 and Range 3) then you still have to define the number of Ranges (M) to be 4. In order to prevent configuration errors from happening you should make sure that the data of Ranges 2 to 3 is also valid, although you do not intend to use Range 2 and 3.

Unit in Comparison Mode

In Comparison Mode Indirect Addressing can be used to define the Comparison Values per Counter that you want to use. The number of CV's (M) defines the size of the CV Data block (size = M x 10 words). If you want to use multiple CV's you are recommended to use consecutive CV's starting from CV 0 (i.e. CV 0, 1, 2, 3 → M - 1) in order to save memory occupation.

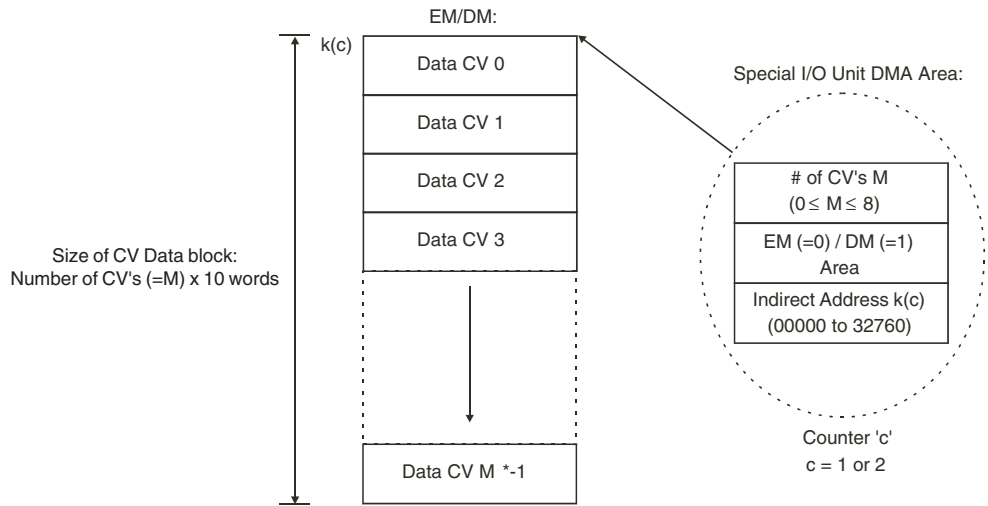

* Assumed that M ≠ 0. By default M=0 which means that no CV's will be used

Note If you do not want the Comparison Values to be consecutive and only intend to use two CV's (e.g. CV 0 and CV 7) then you still have to define the number of CV's (M) to be 8. In order to prevent configuration errors from happening you should make sure that the data of CV's 1 to 6 is also valid, although you do not intend to use CV 1 to 6.

Configuring Indirect Addressing

Indirect Addressing with the Unit in Range or Comparison Mode is specified in the Special I/O Unit DM Area for every Counter. You must specify the memory area (EM/DM) and the address (00000 to 32760) of the first word where the Range/CV data is to be stored. Like this you are able to specify any address that is available in EM or DM. By specifying the number of Ranges or Comparison Values per Counter you determine the number of words with Range/CV data that are allocated for every Counter. For every Range 6 words and for every Comparison Value 10 words are allocated.

The Range/Comparison Data, as part of the Unit configuration data, is transferred to the Unit at Power Up or after the Unit has been restarted.

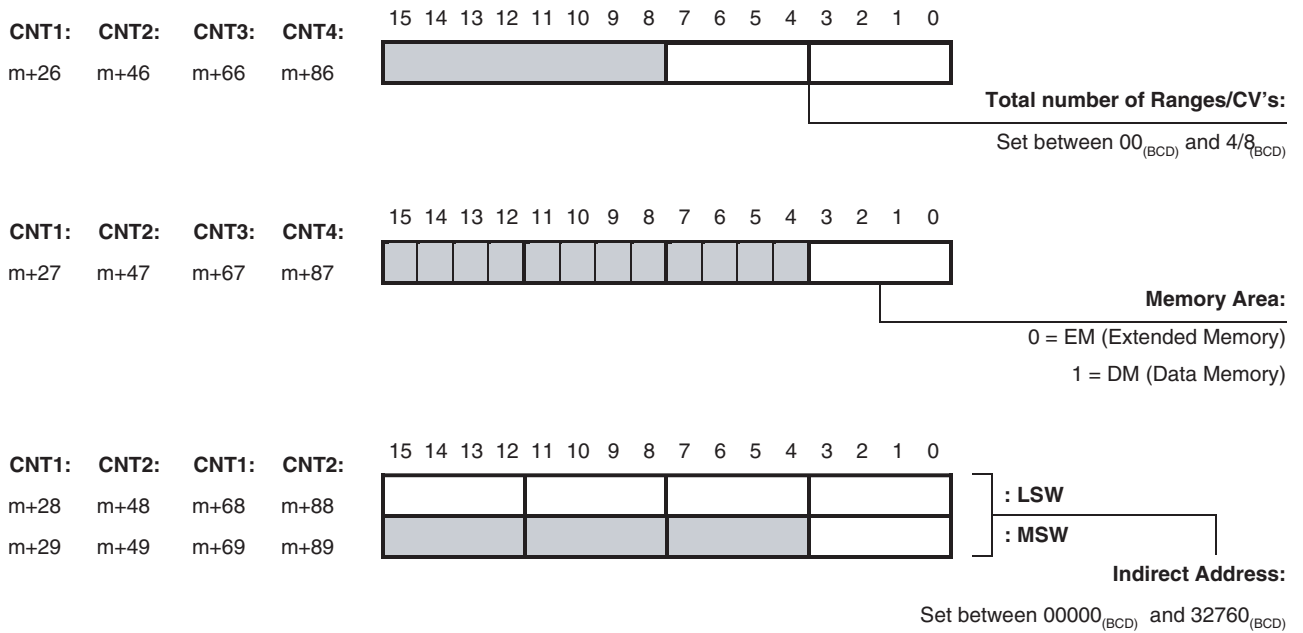

The least significant word (LSW) of the Indirect Address contains the four least significant digits and the most significant word (MSW) contains the most significant digit of the Indirect Address (refer to section the examples on the following pages).

Example Range Mode

Unit is in Range Mode. You want to use 3 Ranges (Range 0 to Range 2) for Counter 1 and want to allocate them in Data Memory starting from D1850.

CNT1:	15	14	13	12	11	10	9	8	7	6	5	4	3	2	1	0	
m+26													0	3	3 Ranges		
m+27													1		Memory Area is DM		
m+28	1				8				5				0				Indirect Address is 1850
m+29													0				

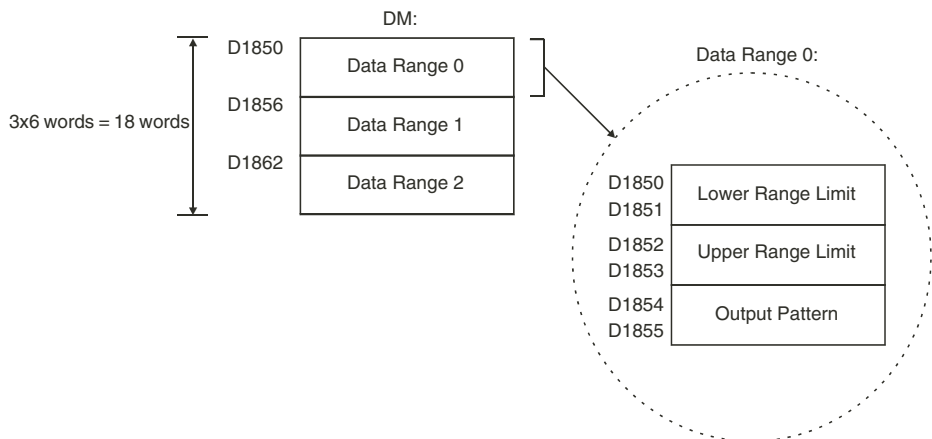

For an overview all addresses related to Range Data refer to section 4-2-5 "Range Memory Mapping".

Example Comparison Mode

Unit is in Comparison Mode. You want to use 5 Comparison Values (CV 0 to Range 4) for Counter 1 and want to allocate them in Extended Memory starting from EM520.

CNT1:	15	14	13	12	11	10	9	8	7	6	5	4	3	2	1	0
m+26												0	5	5 Comparison Values Memory Area is EM Indirect Address is 520		
m+27												0				
m+28	0			5			2			0						
m+29												0				

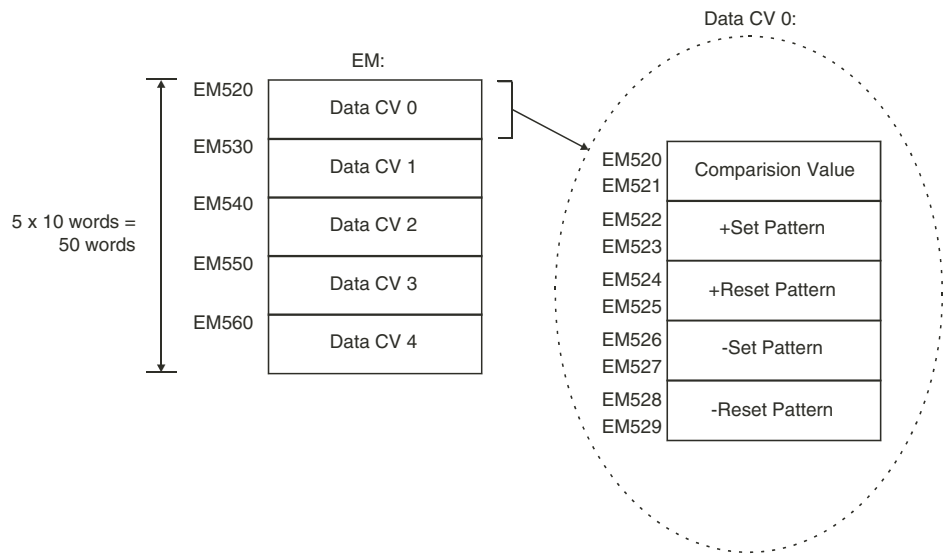

For an overview of all addresses related to Comparison Data refer to section 4-2-6 "Comparison Memory Mapping".

4-2-3 CIO-Memory Mapping

The Counter Unit is allocated 34 Words in CIO. These 34 Words are divided in 13 Output Words (n to n+13) and 21 Input Words (n+13 to n+34).

Note Double words in CIO are indicated as for example "n+3, n+4". How to distinguish between the least- and most significant words (LSW and MSW) within double words, you should refer to section the section called "About this Manual" at the beginning of this Manual.

CIO Output Words

The 14 Output Words (n to n+12) are divided in 5 groups: General, Counter 1, Counter 2, Counter 3 and Counter 4.

	Word (output)	Bit	Item	Function
General	n	00	Read Next Error	Read next error at the rising edge (from the error list in the Counter Unit). The error code can be read from CIO-words n+17 and n+18.
		01 – 15	---	Not used
Counter 1	n+1	00	Open Gate	Open Gate (0→1) See Note 1 and 2
		01	Close Gate	Close Gate (0→1) See Note 1 and 2
		02	Preset	Load Preset Value (0→1) See Note 2
		03	Reset	Reset Counter (Forced Reset) to zero (0→1) See Note 2
		04	Capture	Capture Counter Value (0→1) See Note 2
		05	Reset Enable	Enable Resetting for Z-signal
	06-15	---	Not used	
	n+2, n+3	00-15	Preset Value	Preset Value
Counter 2	n+4	00	Open Gate	Open Gate (0→1) See Note 1 and 2
		01	Close Gate	Close Gate (0→1) See Note 1 and 2
		02	Preset	Load Preset Value (0→1) See Note 2
		03	Reset	Reset Counter (Forced Reset) to zero (0→1) See Note 2
		04	Capture	Capture Counter Value (0→1) See Note 2
		05	Reset Enable	Enable Resetting for Z-signal
	06-15	---	Not used	
	n+5, n+6	00-15	Preset Value	Preset Value
Counter 3	n+7	00	Open Gate	Open Gate (0→1) See Note 1 and 2
		01	Close Gate	Close Gate (0→1) See Note 1 and 2
		02	Preset	Load Preset Value (0→1) See Note 2
		03	Reset	Reset Counter (Forced Reset) to zero (0→1) See Note 2
		04	Capture	Capture Counter Value (0→1) See Note 2
		05	Reset Enable	Enable Resetting for Z-signal
	06-15	---	Not used	
	n+8, n+9	00-15	Preset Value	Preset Value
Counter 4	n+10	00	Open Gate	Open Gate (0→1) See Note 1 and 2
		01	Close Gate	Close Gate (0→1) See Note 1 and 2
		02	Preset	Load Preset Value (0→1) See Note 2
		03	Reset	Reset Counter (Forced Reset) to zero (0→1) See Note 2
		04	Capture	Capture Counter Value (0→1) See Note 2
		05	Reset Enable	Enable Resetting for Z-signal
	06-15	---	Not used	
	n+11, n+12	00-15	Preset Value	Preset Value

- Note**
- Initially, after power-up or restart of the Unit, the Gate is closed. To enable counting pulses, first open the Gate by setting the “Open Gate” bit of the corresponding counter to ‘1’.
 - These bits may not be executed if they are ON for only one PLC cycle. Always keep these bits turned ON until the execution status changes in the corresponding flags in n+24 or n+29.

CIO Input Words

The 26 Input Words (n+13 to n+39) are divided in 5 groups: General, Counter 1, Counter 2, Counter 3 and Counter 4.

	Word (input)	Bit	Item	Function
General	n+13, n+14	00-15	Output Status	Current status of Soft Outputs n+13, bits 00-15: Soft Outputs 0 to 15 n+14, bits 00-15: Soft Outputs 16 to 31
	n+15, n+16	00-15	Error Code	The type of error is represented as follows: n+15 = error code 1 n+16 = error code 2 Refer to section 5-2 "Error codes" for more information
	n+17	00	Global Error	Indication that one or more errors have occurred and that their error code(s) are included in the error list of the Unit
		01	Interrupts Pending	Interrupts Pending (=1); m 1 interrupt(s) in FIFO-queue See note 1
		02	Data Transfer Busy	Data Transfer Busy (=1), Unit is busy completing the IORD/IOWR-instruction or is being initialized (See note 4)
		03	Data Transfer Completed	Toggled every time Data Transfer is completed
		04	IA Blocks overlap	Indication that IA blocks overlap in PLC memory (See note 2)
05-15	---	Not used		
Counter 1	n+18	00-07	Ranges / Comparison Values active	Ranges Active (=1) / Inactive (=0) / Comparison Values Active (=1) / Inactive (=0) See note 1
	n+19, n+20	00-15	Counter Value	Counter Value
	n+21	00	Counter Overflow	Counter Overflow (=1), Upper Count Limit of Linear Counter is reached
		01	Counter Underflow	Counter Underflow (=1), Lower Count Limit of Linear Counter is reached
		02	Counter Running / Gate Open	Counter Running/Gate Open (=1), Counter Stopped/Gate Closed (=0)
		03	Counting Direction	Counting Direction, Down (=0) / Up (=1)
		04	Preset Activated	Preset Activated (=1) See note 2
		05	Reset Activated	Reset Activated (=1) See note 2
		06	Capture Activated	Capture Activated (=1) See note 2 and 3
		07	Z-signal Activated	Z-signal Activated (=1) See note 2
08-15	---	Not used		
Counter 2	n+22	00-07	Ranges / Comparison Values active	Ranges Active (=1) / Inactive (=0) / Comparison Values Active (=1) / Inactive (=0) See note 1
	n+23, n+24	00-15	Counter Value	Counter Value
	n+25	00	Counter Overflow	Counter Overflow (=1), Upper Count Limit of Linear Counter is reached
		01	Counter Underflow	Counter Underflow (=1), Lower Count Limit of Linear Counter is reached
		02	Counter Running / Gate Open	Counter Running/Gate Open (=1), Counter Stopped/Gate Closed (=0)
		03	Counting Direction	Counting Direction, Down (=0) / Up (=1)
		04	Preset Activated	Preset Activated (=1) See note 2
		05	Reset Activated	Reset Activated (=1) See note 2
		06	Capture Activated	Capture Activated (=1) See note 2 and 3
		07	Z-signal Activated	Z-signal Activated (=1) See note 2
08-15	---	Not used		

	Word (input)	Bit	Item	Function
Counter 3	n+26	00-07	Ranges / Comparison Values active	Ranges Active (=1) / Inactive (=0) / Comparison Values Active (=1) / Inactive (=0) See note 1
	n+27, n+28	00-15	Counter Value	Counter Value
	n+29	00	Counter Overflow	Counter Overflow (=1), Upper Count Limit of Linear Counter is reached
		01	Counter Underflow	Counter Underflow (=1), Lower Count Limit of Linear Counter is reached
		02	Counter Running / Gate Open	Counter Running/Gate Open (=1), Counter Stopped/Gate Closed (=0)
		03	Counting Direction	Counting Direction, Down (=0) / Up (=1)
		04	Preset Activated	Preset Activated (=1) See note 2
		05	Reset Activated	Reset Activated (=1) See note 2
		06	Capture Activated	Capture Activated (=1) See note 2 and 3
		07	Z-signal Activated	Z-signal Activated (=1) See note 2
08-15	---	Not used		
Counter 4	n+30	00-07	Ranges / Comparison Values active	Ranges Active (=1) / Inactive (=0) / Comparison Values Active (=1) / Inactive (=0) See note 1
	n+31, n+32	00-15	Counter Value	Counter Value
	n+33	00	Counter Overflow	Counter Overflow (=1), Upper Count Limit of Linear Counter is reached
		01	Counter Underflow	Counter Underflow (=1), Lower Count Limit of Linear Counter is reached
		02	Counter Running / Gate Open	Counter Running/Gate Open (=1), Counter Stopped/Gate Closed (=0)
		03	Counting Direction	Counting Direction, Down (=0) / Up (=1)
		04	Preset Activated	Preset Activated (=1) See Note 2
		05	Reset Activated	Reset Activated (=1) See Note 2
		06	Capture Activated	Capture Activated (=1) See Note 2 and 3
		07	Z-signal Activated	Z-signal Activated (=1) See Note 2
08-15	---	Not used		
n+34 to n+39	00-15	---	Not used	

- Note**
1. These bits have no function for Simple Counters.
 2. The Reset, Preset, Capture, and Z-signal Activated Bits turn ON for at least one CPU Unit-cycle after the occurrence of a pulse that was detected since the previous I/O Refresh.
 3. The Capture Bit turns ON once automatically after the power is turned ON and after restart.
 4. During initialization, the Data Transfer Busy bit turns ON for approximately 120 ms.

4-2-4 DM-Memory Mapping

The Counter Unit allocates 90 Words in DM. These 90 Words are divided in 10 General DM-words (m to m+9) and 20 Counter Specific words for every Counter (Counter 1 = m+10 to m+29, Counter 2 = m+30 to m+49, Counter 3= m+50 to m+69, Counter 4= m+70 to m+89).

Note Double words in DM are indicated as for example “m+2, m+3”. On how to distinguish between the least- and most significant words (LSW and MSW) within double words, refer to section the section *About this Manual* at the beginning of this Manual.

	Word	Bit	Item	Function
General	m	00-07	Output Control Mode	Output Control Mode: 00 = Range Mode (=default) 01 = Comparison Mode
		08-15	AND/OR Counter Output Patterns	In case of Range Mode, define if the output patterns of the Counters should be logically AND-ed (01) or OR-ed (00)
	m+1	00-15	Interrupt Task Offset (Outputs)	Define Offset [0, 192(BCD)] to execute External Interrupt Tasks [0, 255] corresponding to Outputs [0-31]
	m+2, m+3	00-15	Interrupt Enable Data Outputs	Enable (=1) or Disable (=0) Interrupts in the Unit corresponding to Outputs [0, 31]
	m+4 - m+9	00-15	---	Not used

	Word	Bit	Item	Function
Counter 1	m+10	00-15	Counter Type	Counter Type: 0 = Circular (default) 1 = Linear
	m+11	00-03	Signal Type	Signal Type: 0 = Phase Differential (x1) (=default) 1 = Phase Differential (x2) 2 = Phase Differential (x4) 4 = Up & Down Pulse 8 = Pulse & Direction
		04-15	---	Not used
	m+12	00-03	Z-reset Mode	Functionality of Z input signal: 0 = No function (=default, only mapped in CIO) 1 = Reset (Counter at rising edge)
		04-07	Overflow/Underflow error-code generation	Generate error-code at Overflow/Underflow: 0 = No error-code generation (only report with Overflow/Underflow-bits and outputs keep last state) 1 = Error-code generation (report error-code and turn OFF all outputs)
		08-15	---	Not used
	m+13, m+14	00-15	Upper Count Limit Circular/Linear	Circular/Linear Counter: Upper Count Limit
	m+15, m+16	00-15	Lower Count Limit Linear	Linear Counter: Lower Count Limit
	m+17, m+18	00-15	Initial Count Value	Initial Counter Value after transfer of Unit configuration data
	m+19, m+20	00-15	Range / Comparison Enable Data	Enable Ranges / Comparison Values (1=Enabled, 0=Disabled) (depending on Unit in Range / Comparison Mode). Bits set for non-existing ranges or CV's will be ignored
	m+21, m+22	00-15	Output Set Pattern	Output [0-31] Set Pattern for Comparison Mode 1= set, 0 = no change
	m+23, m+24	00-15	Output Reset Pattern	Output [0-31] Reset Pattern for Comparison Mode 1= reset, 0 = no change
	m+25	00-15	Hysteresis	Define required Hysteresis (0000 to 00FF Hex) ($0 \leq \text{Hysteresis} \leq 255$ counts). Hysteresis (=0) means Hysteresis is OFF.
	m+26	00-07	# Ranges / Comparison Values	Set number of Ranges [0, 4 _(BCD)] Set number of Comparison Values [0, 8 _(BCD)]
		08-15	---	Not used
	m+27	00-03	Memory Area	Memory Area where Range / Comparison Data is stored: 0 = EM (=default) 1 = DM Note In case the Unit is used on a CJ1M CPU, DM must be selected.
		04-15	---	Not used
m+28, m+29	00-15	Memory Address	Beginning Address (in EM/DM) where first Range / Comparison Data is stored [00000, 32760 _(BCD)]	

	Word	Bit	Item	Function
Counter 2	m+30	00-15	Counter Type	Counter Type: 0 = Circular (default) 1 = Linear
	m+31	00-03	Signal Type	Signal Type: 0 = Phase Differential (x1) (=default) 1 = Phase Differential (x2) 2 = Phase Differential (x4) 4 = Up & Down Pulse 8 = Pulse & Direction
		04-15	---	Not used
	m+32	00-03	Z-reset Mode	Functionality of Z input signal: 0 = No function (=default, only mapped in CIO) 1 = Reset (Counter at rising edge)
		04-07	Overflow/Underflow error-code generation	Generate error-code at Overflow/Underflow: 0 = No error-code generation (only report with Overflow/Underflow-bits and outputs keep last state) 1 = Error-code generation (report error-code and turn OFF all outputs)
		08-15	---	Not used
	m+33, m+34	00-15	Upper Count Limit Circular/Linear	Circular/Linear Counter: Upper Count Limit
	m+35, m+36	00-15	Lower Count Limit Linear	Linear Counter: Lower Count Limit
	m+37, m+38	00-15	Initial Count Value	Initial Counter Value after transfer of Unit configuration data
	m+39, m+40	00-15	Range / Comparison Enable Data	Enable Ranges / Comparison Values (1=Enabled, 0=Disabled) (depending on Unit in Range / Comparison Mode). Bits set for non-existing ranges or CV's will be ignored
	m+41, m+42	00-15	Output Set Pattern	Output [0-31] Set Pattern for Comparison Mode 1= set, 0 = no change
	m+43, m+44	00-15	Output Reset Pattern	Output [0-31] Reset Pattern for Comparison Mode 1= reset, 0 = no change
	m+45	00-15	Hysteresis	Define required Hysteresis (0000 to 00FF Hex) ($0 \leq \text{Hysteresis} \leq 255$ counts). Hysteresis (=0) means Hysteresis is OFF.
	m+46	00-07	# Ranges / Comparison Values	Set number of Ranges [0, 4 _(BCD)] Set number of Comparison Values [0, 8 _(BCD)]
		08-15	---	Not used
	m+47	00-03	Memory Area	Memory Area where Range / Comparison Data is stored: 0 = EM (=default) 1 = DM Note In case the Unit is used on a CJ1M CPU, DM must be selected.
		04-15	---	Not used
m+48, m+49	00-15	Memory Address	Beginning Address (in EM/DM) where first Range / Comparison Data is stored [00000, 32760 _(BCD)]	

	Word	Bit	Item	Function
Counter 3	m+50	00-15	Counter Type	Counter Type: 0 = Circular (default) 1 = Linear
	m+51	00-03	Signal Type	Signal Type: 0 = Phase Differential (x1) (=default) 1 = Phase Differential (x2) 2 = Phase Differential (x4) 4 = Up & Down Pulse 8 = Pulse & Direction
		04-15	---	Not used
	m+52	00-03	Z-reset Mode	Functionality of Z input signal: 0 = No function (=default, only mapped in CIO) 1 = Reset (Counter at rising edge)
		04-07	Overflow/Underflow error-code generation	Generate error-code at Overflow/Underflow: 0 = No error-code generation (only report with Overflow/Underflow-bits and outputs keep last state) 1 = Error-code generation (report error-code and turn OFF all outputs)
		08-15	---	Not used
	m+53, m+54	00-15	Upper Count Limit Circular/Linear	Circular/Linear Counter: Upper Count Limit
	m+55, m+56	00-15	Lower Count Limit Linear	Linear Counter: Lower Count Limit
	m+57, m+58	00-15	Initial Count Value	Initial Counter Value after transfer of Unit configuration data
	m+59, m+60	00-15	Range / Comparison Enable Data	Enable Ranges / Comparison Values (1=Enabled, 0=Disabled) (depending on Unit in Range / Comparison Mode). Bits set for non-existing ranges or CV's will be ignored
	m+61, m+62	00-15	Output Set Pattern	Output [0-31] Set Pattern for Comparison Mode 1= set, 0 = no change
	m+63, m+64	00-15	Output Reset Pattern	Output [0-31] Reset Pattern for Comparison Mode 1= reset, 0 = no change
	m+65	00-15	Hysteresis	Define required Hysteresis (0000 to 00FF Hex) ($0 \leq \text{Hysteresis} \leq 255$ counts). Hysteresis (=0) means Hysteresis is OFF.
	m+66	00-07	# Ranges / Comparison Values	Set number of Ranges [0, 4 _(BCD)] Set number of Comparison Values [0, 8 _(BCD)]
		08-15	---	Not used
	m+67	00-03	Memory Area	Memory Area where Range / Comparison Data is stored: 0 = EM (=default) 1 = DM Note In case the Unit is used on a CJ1M CPU, DM must be selected.
		04-15	---	Not used
	m+68, m+69	00-15	Memory Address	Beginning Address (in EM/DM) where first Range / Comparison Data is stored [00000, 32760 _(BCD)]

	Word	Bit	Item	Function
Counter 4	m+70	00-15	Counter Type	Counter Type: 0 = Circular (default) 1 = Linear
	m+71	00-03	Signal Type	Signal Type: 0 = Phase Differential (x1) (=default) 1 = Phase Differential (x2) 2 = Phase Differential (x4) 4 = Up & Down Pulse 8 = Pulse & Direction
		04-15	---	Not used
	m+72	00-03	Z-reset Mode	Functionality of Z input signal: 0 = No function (=default, only mapped in CIO) 1 = Reset (Counter at rising edge)
		04-07	Overflow/Underflow error-code generation	Generate error-code at Overflow/Underflow: 0 = No error-code generation (only report with Overflow/Underflow-bits and outputs keep last state) 1 = Error-code generation (report error-code and turn OFF all outputs)
		08-15	---	Not used
	m+73, m+74	00-15	Upper Count Limit Circular/Linear	Circular/Linear Counter: Upper Count Limit
	m+75, m+76	00-15	Lower Count Limit Linear	Linear Counter: Lower Count Limit
	m+77, m+78	00-15	Initial Count Value	Initial Counter Value after transfer of Unit configuration data
	m+79, m+80	00-15	Range / Comparison Enable Data	Enable Ranges / Comparison Values (1=Enabled, 0=Disabled) (depending on Unit in Range / Comparison Mode). Bits set for non-existing ranges or CV's will be ignored
	m+81, m+82	00-15	Output Set Pattern	Output [0-31] Set Pattern for Comparison Mode 1= set, 0 = no change
	m+83, m+84	00-15	Output Reset Pattern	Output [0-31] Reset Pattern for Comparison Mode 1= reset, 0 = no change
	m+85	00-15	Hysteresis	Define required Hysteresis (0000 to 00FF Hex) ($0 \leq \text{Hysteresis} \leq 255$ counts). Hysteresis (=0) means Hysteresis is OFF.
	m+86	00-07	# Ranges / Comparison Values	Set number of Ranges [0, 4 _(BCD)] Set number of Comparison Values [0, 8 _(BCD)]
		08-15	---	Not used
	m+87	00-03	Memory Area	Memory Area where Range / Comparison Data is stored: 0 = EM (=default) 1 = DM Note In case the Unit is used on a CJ1M CPU, DM must be selected.
		04-15	---	Not used
m+88, m+89	00-15	Memory Address	Beginning Address (in EM/DM) where first Range / Comparison Data is stored [00000, 32760 _(BCD)]	

4-2-5 Range Memory Mapping

	Word	Bit	Item	Function
Counter 1	k1, k1+1	00-15	Lower Limit Range 0	Lower Limit Range 0
	k1+2, k1+3	00-15	Upper Limit Range 0	Upper Limit Range 0
	k1+4, k1+5	00-15	Output Pattern Range 0	Output Pattern Range 0
	k1+6 to k1+11	00-15	Range Data Range 1	Lower/Upper Limit and Output Pattern Range 1
	k1+12 to k1+17	00-15	Range Data Range 2	Lower/Upper Limit and Output Pattern Range 2
	k1+18 to k1+23	00-15	Range Data Range 3	Lower/Upper Limit and Output Pattern Range 3
Counter 2	k2, k2+1	00-15	Lower Limit Range 0	Lower Limit Range 0
	k2+2, k2+3	00-15	Upper Limit Range 0	Upper Limit Range 0
	k2+4, k2+5	00-15	Output Pattern Range 0	Output Pattern Range 0
	k2+6 to k2+11	00-15	Range Data Range 1	Lower/Upper Limit and Output Pattern Range 1
	k2+12 to k2+17	00-15	Range Data Range 2	Lower/Upper Limit and Output Pattern Range 2
	k2+18 to k2+23	00-15	Range Data Range 3	Lower/Upper Limit and Output Pattern Range 3
Counter 3	k3, k3+1	00-15	Lower Limit Range 0	Lower Limit Range 0
	k3+2, k3+3	00-15	Upper Limit Range 0	Upper Limit Range 0
	k3+4, k3+5	00-15	Output Pattern Range 0	Output Pattern Range 0
	k3+6 to k3+11	00-15	Range Data Range 1	Lower/Upper Limit and Output Pattern Range 1
	k3+12 to k3+17	00-15	Range Data Range 2	Lower/Upper Limit and Output Pattern Range 2
	k3+18 to k3+23	00-15	Range Data Range 3	Lower/Upper Limit and Output Pattern Range 3
Counter 4	k4, k4+1	00-15	Lower Limit Range 0	Lower Limit Range 0
	k4+2, k4+3	00-15	Upper Limit Range 0	Upper Limit Range 0
	k4+4, k4+5	00-15	Output Pattern Range 0	Output Pattern Range 0
	k4+6 to k4+11	00-15	Range Data Range 1	Lower/Upper Limit and Output Pattern Range 1
	k4+12 to k4+17	00-15	Range Data Range 2	Lower/Upper Limit and Output Pattern Range 2
	k4+18 to k4+23	00-15	Range Data Range 3	Lower/Upper Limit and Output Pattern Range 3

4-2-6 Comparison Memory Mapping

	Word	Bit	Item	Function
Counter 1	k1, k1+1	00-15	Comparison Value 0	Comparison Value 0
	k1+2, k1+3	00-15	+Set Pattern	Output Set Pattern crossing CV0 in + direction
	k1+4, k1+5	00-15	+Reset Pattern	Output Reset Pattern crossing CV0 in + direction
	k1+6, k1+7	00-15	-Set Pattern	Output Set Pattern crossing CV0 in - direction
	k1+8, k1+9	00-15	-Reset Pattern	Output Reset Pattern crossing CV0 in - direction
	k1+10 to k1+19	00-15	CV Data CV1	CV1 and Output Set/Reset patterns +/- direction
	k1+20 to k1+29	00-15	CV Data CV2	CV2 and Output Set/Reset patterns +/- direction
	k1+30 to k1+39	00-15	CV Data CV3	CV3 and Output Set/Reset patterns +/- direction
	k1+40 to k1+49	00-15	CV Data CV4	CV4 and Output Set/Reset patterns +/- direction
	k1+50 to k1+59	00-15	CV Data CV5	CV5 and Output Set/Reset patterns +/- direction
	k1+60 to k1+69	00-15	CV Data CV6	CV6 and Output Set/Reset patterns +/- direction
k1+70 to k1+79	00-15	CV Data CV7	CV7 and Output Set/Reset patterns +/- direction	
Counter 2	k2, k2+1	00-15	Comparison Value 0	Comparison Value 0
	k2+2, k2+3	00-15	+Set Pattern	Output Set Pattern crossing CV0 in + direction
	k2+4, k2+5	00-15	+Reset Pattern	Output Reset Pattern crossing CV0 in + direction
	k2+6, k2+7	00-15	-Set Pattern	Output Set Pattern crossing CV0 in - direction
	k2+8, k2+9	00-15	-Reset Pattern	Output Reset Pattern crossing CV0 in - direction
	k2+10 to k2+19	00-15	CV Data CV1	CV1 and Output Set/Reset patterns +/- direction
	k2+20 to k2+29	00-15	CV Data CV2	CV2 and Output Set/Reset patterns +/- direction
	k2+30 to k2+39	00-15	CV Data CV3	CV3 and Output Set/Reset patterns +/- direction
	k2+40 to k2+49	00-15	CV Data CV4	CV4 and Output Set/Reset patterns +/- direction
	k2+50 to k2+59	00-15	CV Data CV5	CV5 and Output Set/Reset patterns +/- direction
	k2+60 to k2+69	00-15	CV Data CV6	CV6 and Output Set/Reset patterns +/- direction
k2+70 to k2+79	00-15	CV Data CV7	CV7 and Output Set/Reset patterns +/- direction	
Counter 3	k3, k3+1	00-15	Comparison Value 0	Comparison Value 0
	k3+2, k3+3	00-15	+Set Pattern	Output Set Pattern crossing CV0 in + direction
	k3+4, k3+5	00-15	+Reset Pattern	Output Reset Pattern crossing CV0 in + direction
	k3+6, k3+7	00-15	-Set Pattern	Output Set Pattern crossing CV0 in - direction
	k3+8, k3+9	00-15	-Reset Pattern	Output Reset Pattern crossing CV0 in - direction
	k3+10 to k3+19	00-15	CV Data CV1	CV1 and Output Set/Reset patterns +/- direction
	k3+20 to k3+29	00-15	CV Data CV2	CV2 and Output Set/Reset patterns +/- direction
	k3+30 to k3+39	00-15	CV Data CV3	CV3 and Output Set/Reset patterns +/- direction
	k3+40 to k3+49	00-15	CV Data CV4	CV4 and Output Set/Reset patterns +/- direction
	k3+50 to k3+59	00-15	CV Data CV5	CV5 and Output Set/Reset patterns +/- direction
k3+60 to k3+69	00-15	CV Data CV6	CV6 and Output Set/Reset patterns +/- direction	
k3+70 to k3+79	00-15	CV Data CV7	CV7 and Output Set/Reset patterns +/- direction	

	Word	Bit	Item	Function
Counter 4	k4, k4+1	00-15	Comparison Value 0	Comparison Value 0
	k4+2, k4+3	00-15	+Set Pattern	Output Set Pattern crossing CV0 in + direction
	k4+4, k4+5	00-15	+Reset Pattern	Output Reset Pattern crossing CV0 in + direction
	k4+6, k4+7	00-15	-Set Pattern	Output Set Pattern crossing CV0 in - direction
	k4+8, k4+9	00-15	-Reset Pattern	Output Reset Pattern crossing CV0 in - direction
	k4+10 to k4+19	00-15	CV Data CV1	CV1 and Output Set/Reset patterns +/- direction
	k4+20 to k4+29	00-15	CV Data CV2	CV2 and Output Set/Reset patterns +/- direction
	k4+30 to k4+39	00-15	CV Data CV3	CV3 and Output Set/Reset patterns +/- direction
	k4+40 to k4+49	00-15	CV Data CV4	CV4 and Output Set/Reset patterns +/- direction
	k4+50 to k4+59	00-15	CV Data CV5	CV5 and Output Set/Reset patterns +/- direction
	k4+60 to k4+69	00-15	CV Data CV6	CV6 and Output Set/Reset patterns +/- direction
	k4+70 to k4+79	00-15	CV Data CV7	CV7 and Output Set/Reset patterns +/- direction

4-3 IOWR-Instruction

IOWR(223)
C
S
D

@IOWR(223)
C
S
D

C Control Code.

The IOWR-instruction enables you to send messages to the Counter Unit. The high-byte (=CC1) and the low-byte (=CC2) of the Control Code specify the type of message that is to be send.

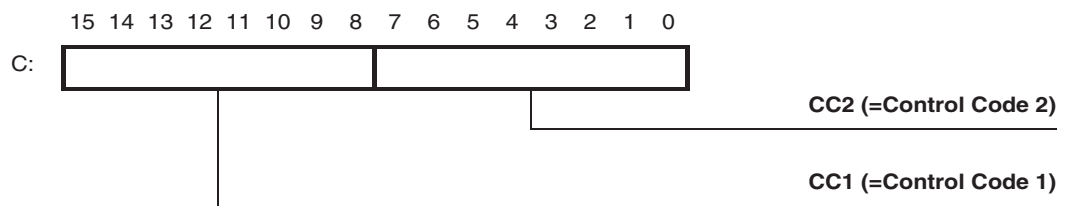

S First Source Word.

The PLC memory address of the first word to be transferred.

D Destination Machine Number (D) and number of words (D+1) to be transferred.

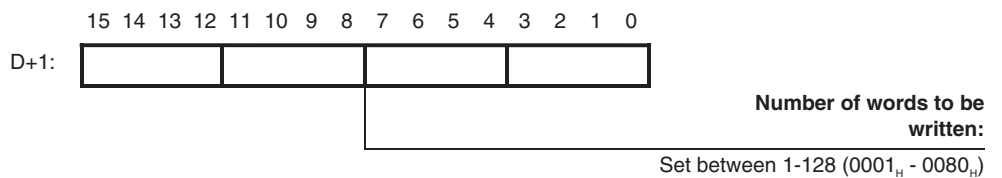
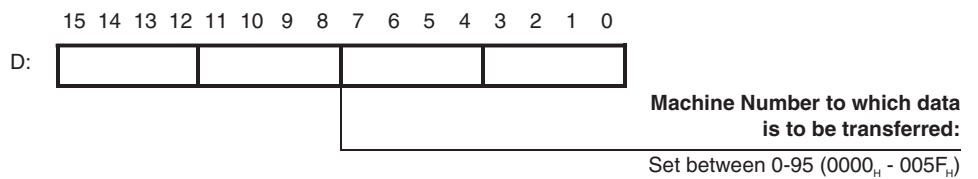

Example ladder program

Refer to section the following structure for the ladder program if you want to use the IOWR-instruction. For an overview of the supported IOWR-instructions and how to set the C-, S- and D-operands, refer to section 4-5 "Supported IOWR/IORD-Instructions".

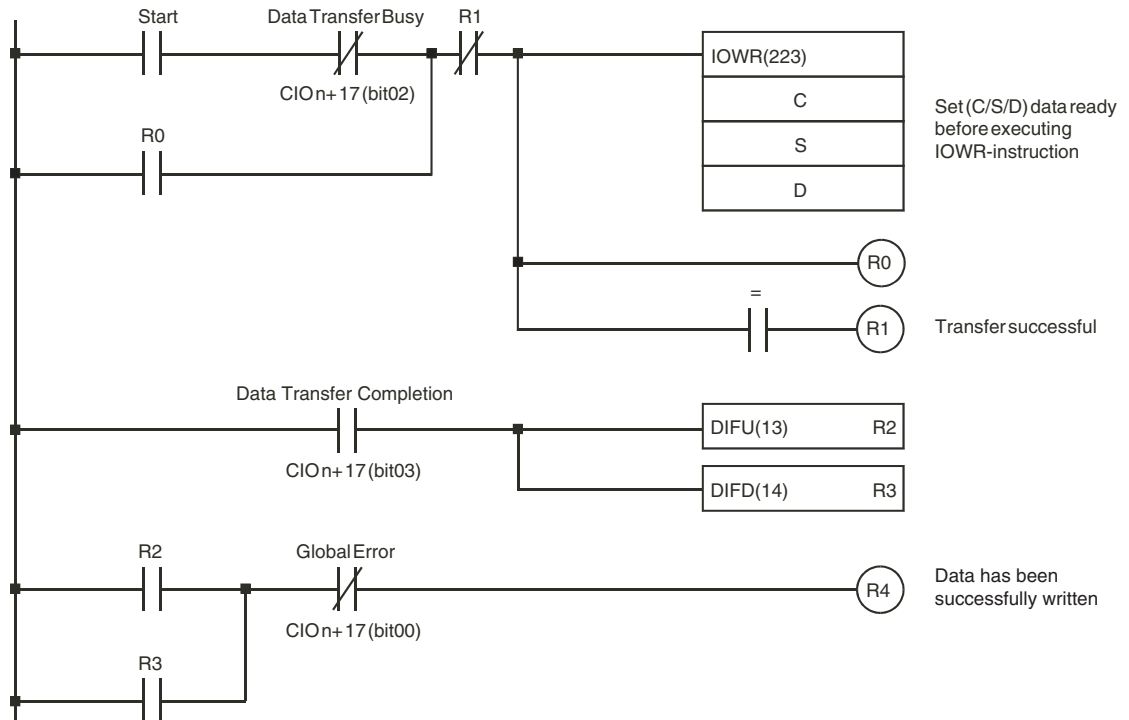

The Data Transfer Busy bit (CIO n+17, bit 02) is ON when the Unit is busy completing an IOWR/IORD-instruction or being initialised. When this bit is OFF the Unit is ready to execute the IOWR-instruction. If an error occurs during the execution of the IOWR-instruction the ER-flag turns ON. The Data Transfer Completion bit (CIO n+17, bit 03) is toggled every time that data transfer is completed. The Global Error bit (CIO n+17, bit 00) turns ON when the Unit detects any error that causes this bit to be set (refer to section 5-2 "Error codes").

- Note**
1. If you omit to include the Data Transfer Busy bit (CIO n+17, bit 02) in the ladder instruction and you start issuing an IOWR-instruction while another IOWR/IORD-instruction is in progress the ER-flag turns ON. Therefore, to guarantee correct execution of IOWR-instructions, you should always use the ladder diagram structure as shown above.
 2. The processing time for IOWR instructions can range up to 55 ms, depending on the command issued.
 3. The response time for bits allocated to outputs (e.g., Open Gate Bit) will be delayed while the Data Transfer Busy bit (CIO n+17, bit 02) is ON (e.g., when time is required to process IOWR or when a Unit is reset). In any case, the bit allocated to the output will be processed as soon as the Data Transfer Busy bit turns OFF.
 4. Comparison stops while the Data Transfer Busy bit (CIO n+17, bit 02) is ON. Refer to section 3-5-1-2 "Configuration and operation in Range Mode" and 3-5-2-2 "Configuration and operation in Comparison Mode" for details.

4-4 IORD-Instruction

IORD(222)	
C	
S	
D	

@IORD(222)	
C	
S	
D	

C Control Code.

The IORD-instruction enables you to read data from the Counter Unit. The high-byte (=CC1) and the low-byte (=CC2) of the Control Code specify the type of data that is to be read.

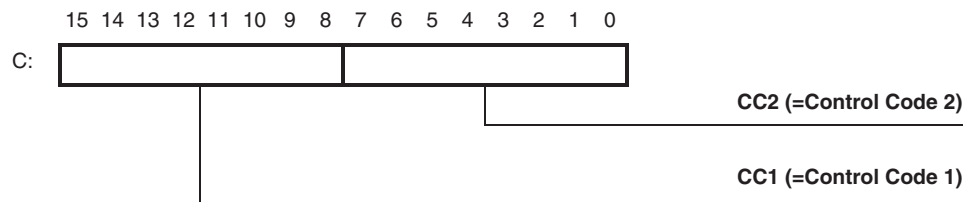

S First Source Word.

Source Machine Number (S) and the number of words (S+1) to be read.

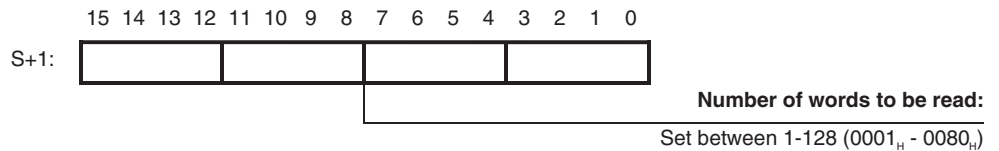
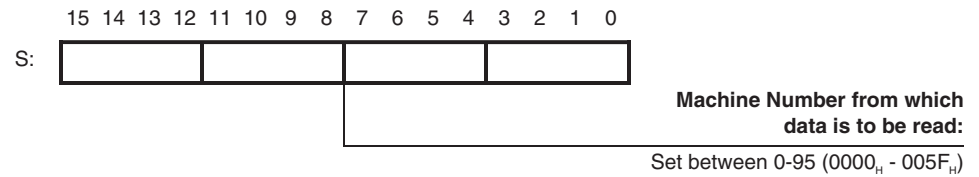

D First Destination Word.

The PLC memory address of the first word where the read data is to be written.

Example ladder program

Refer to section the following structure for the ladder program if you want to use the IORD-instruction. For an overview of the supported IORD-instructions and how to set the C-, S- and D-operands, refer to section 4-5 "Supported IOWR/IORD-Instructions".

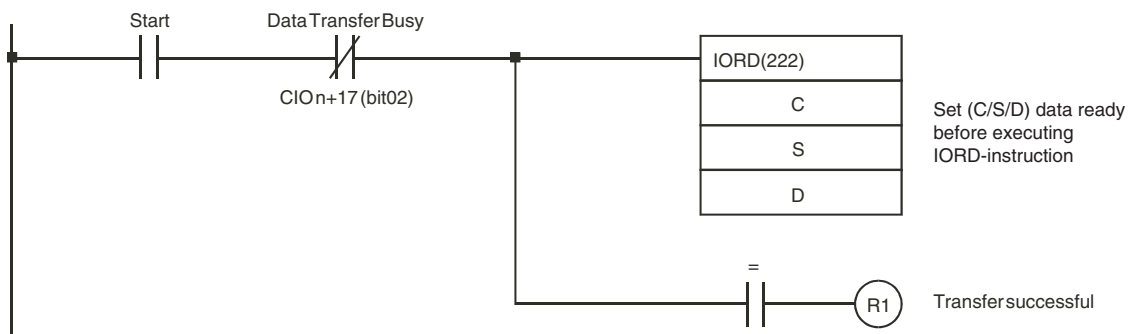

The Data Transfer Busy bit (CIO n+17, bit 02) is ON when the Unit is busy completing an IOWR/IORD-instruction or being initialised. When this bit is OFF the Unit is ready to execute the IORD-instruction. If an error occurs during the execution of the IORD-instruction the ER-flag turns ON.

- Note**
1. If you omit to include the Data Transfer Busy bit (CIO n+17, bit 02) in the ladder instruction and you start issuing an IORD-instruction while another IOWR/IORD-instruction is in progress the ER-flag turns ON. Therefore, to guarantee correct execution of IORD-instructions, you should always use the ladder diagram structure as shown above.
 2. The processing time for IORD instructions can range up to 0.8 ms, depending on the command issued.
 3. The response time for bits allocated to outputs (e.g., Open Gate Bit) will be delayed while the Data Transfer Busy bit (CIO n+17, bit 02) is ON (e.g., when time is required to process IORD or when a Unit is reset). In any case, the bit allocated to the output will be processed as soon as the Data Transfer Busy bit turns OFF.
 4. Comparison stops while the Data Transfer Busy bit (CIO n+17, bit 02) is ON. Refer to section 3-5-1-2 "*Configuration and operation in Range Mode*" and 3-5-2-2 "*Configuration and operation in Comparison Mode*" for details.

4-5 Supported IOWR/IORD-Instructions

4-5-1 DM-data

4-5-1-1 DM-words Used for IOWR/IORD

	Memory Location	Item	IOWR	IORD	Control Code		No. of Words
					CC1	CC2	
General	m	Output Control Mode	N	N	---	---	---
		AND/OR Counter Output Patterns	N	N	---	---	---
	m+1	Interrupt Task Offset (outputs)	N	N	---	---	---
	m+2, m+3	Interrupt Mask Outputs	Y	Y	0B	01	2
	m+4 to m+9	Not used	---	---	---	---	---
Counter 1	m+10	Counter Type	N	N	---	---	---
	m+11	Signal Type	N	N	---	---	---
	m+12	Z-reset Mode	Y	Y	1E	01	1
		Overflow/Underflow error-code generation	N	N	---	---	---
	m+13, m+14	Max. Count Value Circular/Linear	Y	Y	1C	03	2
	m+15, m+16	Min. Count Value Linear	Y	Y	1C	04	2
	m+17, m+18	Power On Preset Value	N	N	---	---	---
	m+19, m+20	Range / Comparison Enable Data	Y	Y	1B	03	2
	m+21, m+22	Output (P)reset Set Pattern	N	N	---	---	---
	m+23, m+24	Output (P)reset Reset Pattern	N	N	---	---	---
	m+25	Hysteresis	N	N	---	---	---
	m+26	# Ranges / # Comparison Values	N	N	---	---	---
	m+27	Memory Area	N	N	---	---	---
m+28, m+29	Memory Address	N	N	---	---	---	
Counter 2	m+30	Counter Type	N	N	---	---	---
	m+31	Signal Type	N	N	---	---	---
	m+32	Z-reset Mode	Y	Y	2E	01	1
		Overflow/Underflow error-code generation	N	N	---	---	---
	m+33, m+34	Max. Count Value Circular/Linear	Y	Y	2C	03	2
	m+35, m+36	Min. Count Value Linear	Y	Y	2C	04	2
	m+37, m+38	Power On Preset Value	N	N	---	---	---
	m+39, m+40	Range / Comparison Enable Data	Y	Y	2B	03	2
	m+41, m+42	Output (P)reset Set Pattern	N	N	---	---	---
	m+43, m+44	Output (P)reset Reset Pattern	N	N	---	---	---
	m+45	Hysteresis	N	N	---	---	---
	m+46	# Ranges / # Comparison Values	N	N	---	---	---
	m+47	Memory Area	N	N	---	---	---
m+48, m+49	Memory Address	N	N	---	---	---	

	Memory Location	Item	IOWR	IORD	Control Code		No. of Words
					CC1	CC2	
Counter 3	m+50	Counter Type	N	N	---	---	---
	m+51	Signal Type	N	N	---	---	---
	m+52	Z-reset Mode	Y	Y	3E	01	1
		Overflow/Underflow error-code generation	N	N	---	---	---
	m+53, m+54	Max. Count Value Circular/Linear	Y	Y	3C	03	2
	m+55, m+56	Min. Count Value Linear	Y	Y	3C	04	2
	m+57, m+58	Power On Preset Value	N	N	---	---	---
	m+59, m+60	Range / Comparison Enable Data	Y	Y	3B	03	2
	m+61, m+62	Output (P)reset Set Pattern	N	N	---	---	---
	m+63, m+64	Output (P)reset Reset Pattern	N	N	---	---	---
	m+65	Hysteresis	N	N	---	---	---
	m+66	# Ranges / # Comparison Values	N	N	---	---	---
	m+67	Memory Area	N	N	---	---	---
m+68, m+69	Memory Address	N	N	---	---	---	
Counter 4	m+70	Counter Type	N	N	---	---	---
	m+71	Signal Type	N	N	---	---	---
	m+72	Z-reset Mode	Y	Y	4E	01	1
		Overflow/Underflow error-code generation	N	N	---	---	---
	m+73, m+74	Max. Count Value Circular/Linear	Y	Y	4C	03	2
	m+75, m+76	Min. Count Value Linear	Y	Y	4C	04	2
	m+77, m+78	Power On Preset Value	N	N	---	---	---
	m+79, m+80	Range / Comparison Enable Data	Y	Y	4B	03	2
	m+81, m+82	Output (P)reset Set Pattern	N	N	---	---	---
	m+83, m+84	Output (P)reset Reset Pattern	N	N	---	---	---
	m+85	Hysteresis	N	N	---	---	---
	m+86	# Ranges / # Comparison Values	N	N	---	---	---
	m+87	Memory Area	N	N	---	---	---
m+88, m+89	Memory Address	N	N	---	---	---	

4-5-1-2 Data Used for IOWR/IORD

Item	IOWR	IORD	Control Code		No. of Words
			CC1	CC2	
Data Range 00 – Data Range 03	Y	Y	cA	00-03	6 x M ^{*1}
Data Comparison Value 00 – Data Comparison Value 07	Y	Y	cA	00-07	10 x M ^{*2}
Captured Count Value	N	Y	cC	02	2
Counter Value	Y	Y	cC	01	2
(Re) Configure Unit	Y	N	0D	01	1
Clear Error(s)	Y	N	EC	00	1

c = Counter Number (1, 2, 3 or 4)

^{*1} M = Number of Ranges, 1 ≤ M ≤ 4^{*2} M = Number of Comparison Values, 1 ≤ M ≤ 8

Note Data written with the IOWR instruction is valid only until the Unit is restarted or the power supply is turned OFF. The settings in the DM and EM Area in the CPU Unit will be used after the next time the Unit is restarted or power is turned ON. If the settings made with IOWR instruction need to be used after the Unit is restarted or power is cycled, write the same settings to the DM and EM Area in the CPU Unit.

Example:

The Counter Unit is assigned Machine Number 6. You want to change the Maximum Count Value of Circular Counter 2. The new Maximum Count Limit consists of 2 words, is located in Data-Memory at address D0050 and D0051 and is equal to 2710_H (=10,000 decimal).

IOWR(223)	
#2C03	CC1= 2C (= Counter 2), CC2= 03
D0050	S= D0050 (first word with new Maximum Count Value)
#00020006	D= #0006 (Machine Number) and D+1= #0002 (# words)

Example:

The Counter Unit is in Range Mode and is assigned Machine Number 3. You want to read the Range Enable Data of Counter 2 and write it to D1800 in the PLC memory.

IORD(222)	
#2B03	CC1= 2B (= Counter 2), CC2= 03
#00020003	S= #0003 (Machine Number) and S+1= #0002 (# words)
D1800	D= D1800 (write Range Enable Data to D1800 and D1801)

4-5-2 Range- and Comparison data

The Unit can be in Range or Comparison Mode (refer to section 3-5-1 "Range Mode" and 3-5-2 "Comparison Mode"). IOWR- and IORD-instructions can be used respectively to change Range/Comparison Data inside the Unit or to read Range/Comparison Data from the Unit, during actual operation. Depending on the mode of the Unit (Range or Comparison mode) the Control Code is interpreted accordingly by the Counter Unit.

Item	IOWR	IORD	Control Code		No. of Words
			CC1	CC2	
Data Range 00 – Data Range 03	Y	Y	cA	00-03	6 x M ^{*1}
Data Comparison Value 00 – Data Comparison Value 07	Y	Y	cA	00-07	10 x M ^{*2}

c = Counter Number (1, 2, 3 or 4)

*¹ M = Number of Ranges, 1 ≤ M ≤ 4

*² M = Number of Comparison Values, 1 ≤ M ≤ 8

Note When transferring new Comparison Values to the Unit, be sure that the same Comparison Value is not used more than once in the same Counter. If the same Comparison Value exists more than once in the same Counter, an error will

occur when the IOWR-instruction is executed. Refer to section 3-5-2-2 "Configuration and operation in Comparison Mode" and 5-2-2 "IOWR/IORD-instruction errors" for details.

Range Data

If the Unit is in Range Mode for each Counter the Range Data of one or multiple Ranges can be read from the Unit or written to the Unit. For every Range the Range Data is contained in 6 words. Per IORD- or IOWR-instruction you can read or write Range Data of up to a maximum of 4 Ranges.

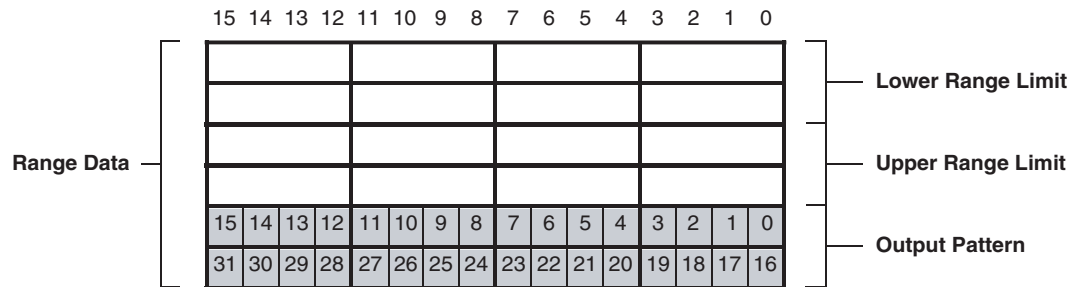

In the Output Pattern the Outputs are represented by:

= Soft Outputs 0-31

In the Control Code CC1, c specifies the Counter number (c = 1, 2, 3 or 4) from which the Range Data is to be read or written. CC2 specifies the first Range number (00-03). Depending on the number of Ranges that you want to read the Range Data from or overwrite with new Range Data, you have to specify the number of words to be transferred. This number of words is equal to the number of Ranges x 6.

Example:

The Counter Unit, with Machine Number 1, operates in Range Mode and Counter 2 uses 4 Ranges (Range 00 to Range 03). You want to change the Range Data of Ranges 02 and 03. The new Range Data, consisting of 12 words (= 6 words x 2 Ranges), is located in Data-Memory starting from D0100.

IOWR(223)	
#2A02	CC1= 2A (= Counter 2), CC2= 02 (= first Range Number)
D0100	S= D0100 (first word with new Range Data)
#000C0001	D= #0001 (Machine Number) and D+1= #000C (# words)

Comparison Data

If the Unit is in Comparison Mode for every Counter the Comparison Data of one or multiple Comparison Values can be read or written. For every Comparison Value the CV Data is contained in 10 words. Per IORD- or IOWR-instruction you can read or write CV Data of up to a maximum of 8 Comparison Values.

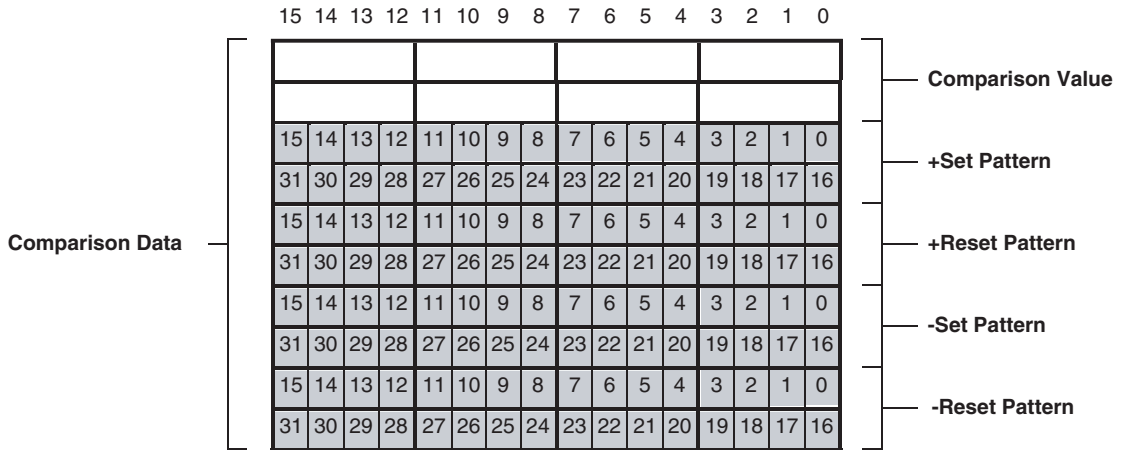

In the +/- Set and Reset Patterns the Outputs are represented by:

= Soft Outputs 0-31

On reaching the Comparison Value:

+ and - Set Patterns: **+ and - Reset Patterns:**

0 = No Change 0 = No Change

In the Control Code CC1, c specifies the Counter number (1,2, 4 or 4) from which the CV Data is to be read or written. CC2 specifies the first CV number (00-03). Depending on the number of CV's that you want to read the CV Data from or overwrite with new CV Data, you have to specify the number of words to be transferred. This number of words is equal to the number of CV's x 10.

Example:

The Counter Unit, with Machine Number 3, operates in Comparison Mode and Counter 1 uses 4 Comparison Values (CV 00 to CV 03). You want to change the Comparison Data of CV 00. The new Comparison Data, consisting of 10 words (= 10 words x 1 CV), is located in Data-Memory starting from D0200.

IOWR(223)
#1A00
D0200
#000A0003

CC1= 1A (= Counter 1), CC2= 00 (= first CV Number)

S= D0200 (first word with new CV Data)

D= #0003 (Machine Number) and D+1= #000A (# words)

4-5-3 Special data

4-5-3-1 Captured Counter Value

The Counter Value can be captured into the Capture Register by using the "Capture Counter Value bit" in CIO (refer to section 3-4 "Controlling a Counter" for more information). For this purpose every Counter is equipped with a Capture Register inside the Counter Unit. If you want to use the captured Counter Value in the PLC ladder program you have to use the IORD-instruction that reads the value from the Capture Register of the specific Counter.

Item	IOWR	IORD	Control Code		No. of Words
			CC1	CC2	
Captured Counter Value	N	Y	cC	02	2

c = Counter Number (1, 2, 3 or 4)

Example:

The Counter Unit is assigned Machine Number 8. You want to read the Captured Counter Value of Counter 1 and write it to D0300 in the PLC memory.

IORD(222)	
#1C02	CC1= 1C (= Counter 1), CC2= 02
#00020008	S= #0008 (Machine Number) and S+1= #0002 (# words)
D0300	D= D0300 (write Captured Counter Value to D0300 and D0301)

4-5-3-2 Counter Value

The Counter Value of every Counter can be overwritten and read by using the IOWR- and IORD-instructions, during actual operation of the Unit.

Item	IOWR	IORD	Control Code		No. of Words
			CC1	CC2	
Counter Value	Y	Y	cC	01	2

c = Counter Number (1, 2, 3 or 4)

Example:

The Counter Unit is assigned Machine Number 5. You want to overwrite the Counter Value of Counter 2 with 500 (= 01F4 (hex)).

IOWR(223)	
#2C01	CC1= 2C (= Counter 2), CC2= 01
D0100	S= D0100 (= new Counter Value = #000001F4)
#00020005	D= #0005 (Machine Number) and D+1 = #0002 (# words)

4-5-3-3 (Re) Configure Unit

During operation of the Unit (PLC is in RUN/MONITOR-mode), the Unit can be configured by using the IOWR-instruction from the PLC ladder program. Issuing the IOWR-instruction from the PLC ladder program results in transferring all the Unit configuration data to the Unit. The Unit configuration data consists of the data in the Special I/O Unit DM Area and the Range/Comparison Data.

Item	IOWR	IORD	Control Code		No. of Words
			CC1	CC2	
(Re) Configure Unit	Y	N	0D	01	1

Example:

The Counter Unit is assigned Machine Number 2. You want to (re) configure the Unit by transferring all the configuration settings to the Unit (the PLC is in RUN/MONITOR-mode).

IOWR(223)	
#0D01	CC1= 0D, CC2= 01
-	S=Not relevant (fill in valid constant, e.g. D0300 containing #0000)
#00010002	D= #0002 (Machine Number) and D+1= #0001 (# words)

1. The configuration settings can also be transferred to the Unit by Powering Up the CJ-series PLC system or by restarting the Unit.
2. The Counter Values remain unchanged after the "(Re) Configure Unit" instruction has been sent to the Unit.



Caution

Before you make your ladder program operational, make sure that the IOWR-instruction "(Re) Configure Unit" uses valid configuration data. If the Unit configuration data contains invalid settings the Unit will *stop* operating and report the error(s).

4-5-3-4 Error Clear Command

The error-codes of errors occurring at the Counter Unit are stored in the Unit and are available to you as a Error History Log File (refer to section 5-2 "Error codes" for more details about the error categories that can be distinguished and filing errors).

The error-codes generated by IORD/IOWR-instruction errors and Interrupt FIFO Full errors can be cleared by issuing the Error Clear command ("EC") with the IOWR-instruction. After the errors have been cleared, they are still available to you from the Error History Log File. To troubleshoot errors from other categories refer to section 5-2 "Error codes" for the applicable remedy.

Item	IOWR	IORD	Control Code		No. of Words
			CC1	CC2	
Clear Error(s)	Y	N	EC	00	1

Example:

The Counter Unit is assigned Machine Number 2. You want to clear all IOWR/IORD-instruction errors by issuing the IOWR-instruction with the Error Clear command.

IOWR(223)	
#EC00	CC1= EC, CC2= 00
-	S=Not relevant (fill in valid constant, e.g. D0400 containing #0000)
#00010002	D= #0002 (Machine Number) and D+1= #0001 (# words)

4-6 Interrupts

The status information of the 32 Outputs is exchanged with the CJ-series CPU Unit every I/O refresh via the Special I/O Unit Area. The I/O refresh is executed cyclically at the end of the Ladder Program or can be forced by I/O refresh instruction. In both cases the CJ-series CPU Unit takes the initiative for a data-exchange. In order for the Counter Unit to be able to report the status information of the 32 Outputs to the CJ-series CPU Unit, independent from the I/O Refresh, all Outputs can be configured to generate interrupts. Important events, indicated by a status change of the Outputs, can thus be reported as quickly as possible to the CJ-series CPU Unit.

Note External interrupts are supported only by CJ1-H and CJ1M CPU Units. They are not supported by CJ1G-CPU44 and -45 (without 'H' suffix). If you want the Counter Unit to generate interrupts to activate external interrupt tasks in a CJ1-H CPU Unit, the Counter Unit must be in one of the five positions immediately to the right of the CJ1-H CPU Unit on the CPU Rack. If you want the Counter Unit to generate interrupts to activate external interrupt tasks in a CJ1M CPU Unit, the Unit must be in one of the three positions immediately to the right of the CJ1M CPU Unit on the CPU Rack.

No external interrupt tasks can be activated for CJ1-H or CJ1M CPU Units if the CJ1W-CTL41-E Counter Unit is in any other position (i.e., 6th Unit position or further away from the CJ1-H CPU Unit, or 4th Unit position or further away from the CJ1M CPU Unit), or if it is on a CJ-series Expansion Rack. All external interrupt tasks will be disabled in these cases.

4-6-1 Outputs Generating Interrupts

Enabling / Disabling Interrupts

The 32 Outputs, can all be configured to generate interrupts to the CJ-series CPU Unit. If an Output is configured to generate interrupts, an interrupt is issued to the CJ-series CPU Unit at a rising and at a falling edge of the corresponding bit in the Unit Output Pattern. For this purpose two external interrupt tasks in the CJ-series CPU Unit are assigned to every Output. In the external interrupt task you should write an appropriate (ladder) program that takes the required action on the occurrence of an interrupt.

You can configure an Output to generate interrupts by setting the corresponding bit in the Interrupt Enable Data of the Outputs. The Interrupt Enable Data of the

Outputs consists of 32 bits representing the 32 Outputs. By default Outputs are disabled to generate interrupts.



= Soft Outputs 0-31

0 = Interrupts Disabled
1 = Interrupts Enabled

External Interrupt Task Offset

Every Output that is enabled to generate interrupts is assigned two External Interrupt Tasks in the CJ-series CPU Unit. For this purpose all 32 Outputs are assigned in sequential order to consecutive External Interrupt Tasks starting from Output 0. By defining an Offset you determine the External Interrupt Task numbers of the (first two) External Interrupt Tasks that are assigned to Output 0. The remaining 31 Outputs are assigned to the respective External Interrupt Task numbers in increasing order starting from "Offset + 2".

Output	Assigned External Interrupt Task Number	Interrupt executed at rising/falling edge*
0	Offset	Rising
	Offset + 1	Falling
1	Offset + 2	Rising
	Offset + 3	Falling
2	Offset + 4	Rising
	Offset + 5	Falling
3	Offset + 6	Rising
	Offset + 7	Falling
4	Offset + 8	Rising
	Offset + 9	Falling
~	~	~
31	Offset + 62	Rising
	Offset + 63	Falling

* The assigned External Interrupt Task number is executed at a rising/falling edge of the corresponding Output bit in the Unit Output Pattern.

For every Output the assigned External Interrupt Task number can be calculated with the following formula ('O' = Output):

Assigned External Interrupt Task Number to the

- rising edge of the Output bit is equal to: Offset + 2xO
- falling edge of the Output bit is equal to: Offset + 2xO+1

For a complete overview of all External Interrupt Task numbers to be assigned to the Outputs, refer to section Appendix B *Appendix B "Assigning External Interrupt Tasks to Outputs"*.

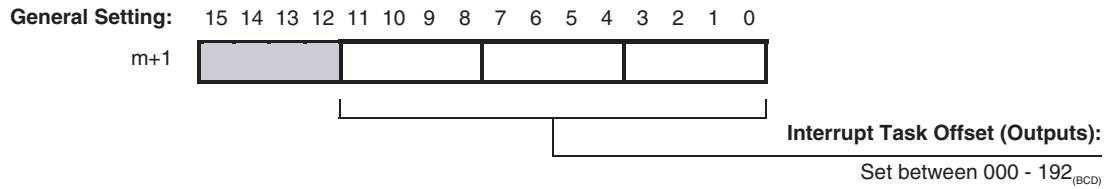

Since there are 256 External Interrupt Tasks available (numbered 0 to 255) the Offset can be maximum 192. With an Offset of 192 the last Output (31) will be assigned the last available External Interrupt Task 255 (=192+2x31+1).

Example

An Offset of 10 ($m+1 = 0010_{(BCD)}$), with all 32 Outputs enabled to generate interrupts ($m+2$ and $m+3 = FFFF_H$), means that the rising edge of the corresponding bit of Output 0 in the Unit Output Pattern is assigned to External Interrupt Task Number 10 and the falling edge to External Interrupt Task 11. The rising edge of Output 1 to External Interrupt Task Number 12 and the falling edge to External Interrupt Task Number 13 and so on. For Output 31 the two External Interrupt Tasks 72 and 73 are assigned. Now you have External Interrupt Tasks 10 to 73 available. In every Task you should write an appropriate (ladder) program which is to be executed at the Outputs' corresponding rising or falling edge.

SECTION 5

Error Processing, Maintenance and Inspection

This section provides details of the CJ1W-CTL41-E Counter Unit's error indicators and error codes and guidelines for maintenance and inspection of the Unit.

5-1	Error Indicators	92
5-1-1	Errors during initial processing	92
5-1-2	Errors during normal operation	92
5-2	Error codes	93
5-2-1	DM-configuration errors	94
5-2-2	IOWR/IORD-instruction errors	95
5-2-3	Overflow/Underflow errors	96
5-2-4	Preset error	96
5-2-5	Interrupt FIFO full error	97
5-2-6	System Errors	98
5-3	Maintenance and Inspection	99
5-3-1	Cleaning	99
5-3-2	Routine Inspections	99

5-1 Error Indicators

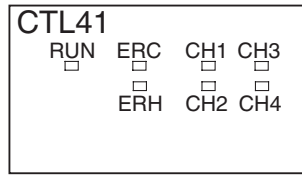

The RUN-, ERC-, and ERH-LEDs, at the front panel of the Counter Unit, display the following errors.

5-1-1 Errors during initial processing

RUN	ERC	ERH	Error	Probable cause	Remedy
OFF	OFF	ON	Setup error	Incorrect Unit number Cyclic initial error	Set correct Unit number and turn ON the power again
OFF	ON	OFF	DM-configuration error	Invalid DM-setting(s)	Check the Error Code(s) in CIO (words n+15, n+16), correct the invalid DM-setting(s) and turn ON the power again. Refer to section 5-2 "Error codes" for more information on error codes and how to clear them.
			Unit error	An error occurred in the Unit's EEPROM, RAM or CPU or a system software error occurred	Turn OFF and then ON the power again. If errors reoccurs, then replace the Counter Unit
OFF	ON	ON	Unit classification error	The Unit classification was set incorrectly	Replace the Counter Unit
OFF	OFF	OFF	Watch Dog Timer time-out error	The Unit's Watch Dog Timer has timed out	Turn OFF and then ON the power again. If errors reoccurs, then replace the Counter Unit

5-1-2 Errors during normal operation

RUN	ERC	ERH	Error	Probable cause	Remedy
ON	ON	OFF	Unit error	Invalid operands specified in IOWR-instruction Overflow or underflow of Simple or Linear Counter Preset error Unit interrupt FIFO is full	Check the Error Code(s) in CIO (words n+15, n+16). Apply appropriate remedy according to the cause of the error. Refer to section 5-2 "Error codes" for more information on error codes and how to clear them.
ON	OFF	ON	System error	PLC Watch Dog Timer error Fatal error Non-fatal error Cyclic Monitor error I/O Bus error	If cyclic refreshing is disabled, program the PLC so that a refresh using the IORF-instruction is executed every 11 or fewer seconds or remove the cause of the fatal or non-fatal error. If the error reoccurs, then replace the CJ-series CPU Unit. Refer to section 5-2-6 "System Errors" for more information.

5-2 Error codes

Reporting errors

The errors that can occur at the Unit are divided in 6 categories: DM-configuration errors, IOWR-instruction errors, overflow/underflow errors, Preset error, Interrupt-FIFO full error and System errors. Every error is assigned a unique error code. The *error code* consists of two words (error code 1 and error code 2). At the occurrence of an error:

- the corresponding *error code* is transferred to words n+15 (=error code 1) and n+16 (=error code 2) of the Special I/O Unit Area in CIO-memory
- the corresponding *error code* is stored inside the Counter Unit
- the Global Error bit in CIO is set (n+17 / bit 00)
- the ERC-LED is turned ON

General Setting:

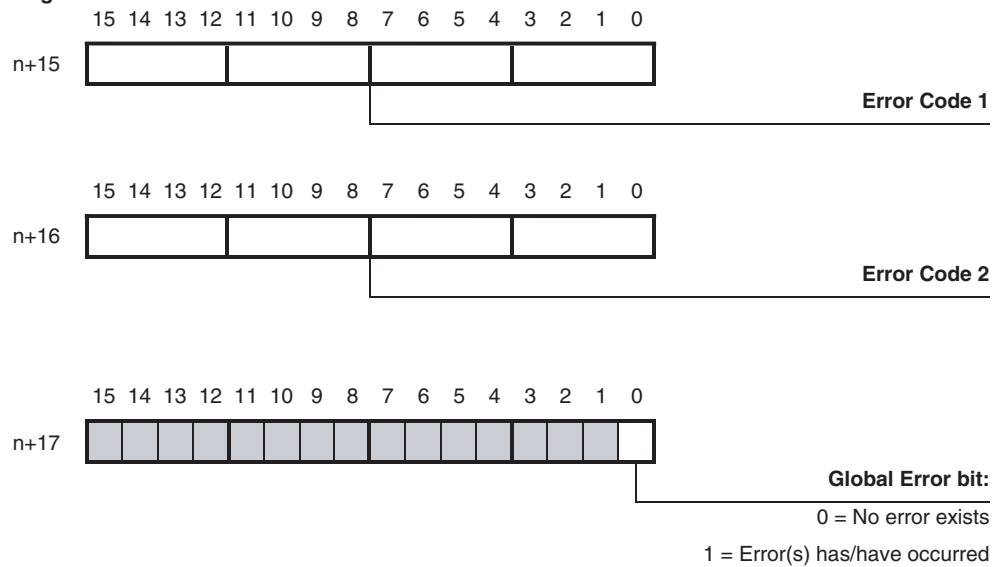

After you have cleared the error:

- words n+15 (=error code 1) and n+16 (=error code 2) are reset
- the Global Error bit in CIO is reset (n+17 / bit 00)
- the ERC-LED is turned OFF

Every error category requires its own unique action to clear them (refer to section the next sections for information on clearing errors of different categories).

Error History Log File

Up to a maximum of 30 errors can be logged in chronological order inside the Counter Unit, constituting the Error History Log File. If multiple errors are active at the same time every error (-code) can be read sequentially into CIO (n+15, n+16) by using the Read Next Error bit. Every next error is read from the Error History Log File at the rising edge of the Read Next Error bit. If you attempt to read an error after the last error in the list has been read, the value of zero will be returned. Now you can scroll through the same error list again from the next rising edge of the Read Next Error bit.

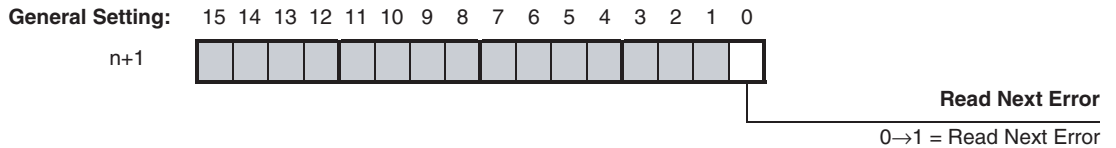

5-2-1 DM-configuration errors

DM-configuration errors are detected during initialisation after the Unit has been powered up or restarted. DM-configuration errors can also be detected after the IOWR-instruction “(Re) Configure Unit” has been issued (refer to section 4-5-3-4 “(Re) Configure Unit”). In case a DM-configuration error is detected the Unit will report the error and stop operating. The error(s) can be read in CIO using the “Read Next Error” bit.

Error Code 1	Error Code 2	Error	Description	
0300	Offset (BCD)	Out of Range	The DM-setting located at $D20000 + (Nx100) + \underline{Offset}$ is Out of Range (N = Machine Number).	
0310	Offset (BCD)	Invalid BCD-code	The DM-setting located at $D20000 + (Nx100) + \underline{Offset}$ is an invalid BCD-code (N = Machine Number). (The range of a valid BCD-code for a digit is 0-9. If one or more digits is within range A-F an invalid BCD-code is specified).	
0311	Offset (BCD)	Invalid Initial Counter Value	The Initial Counter Value located at $D20000 + (Nx100) + \underline{Offset}$ is outside the counting range that is set for that Counter (N = Machine Number).	
0320	Counter No.	Range No. (BCD)	Invalid Range Limits	Upper Range Limit < Lower Range Limit. <u>Counter No.</u> indicates the Linear Counter number and <u>Range No.</u> indicates the Range number.
0330	Counter No.	Range No. (BCD) / CV No. (BCD)	Invalid Range Limit(s) / Comparison Value	If the Unit is in Range Mode: Lower and/or Upper Range Limit is/are outside Counting Range. <u>Counter No.</u> indicates the Counter number and <u>Range No.</u> indicates the Range number. If the Unit is in Comparison Mode: Comparison value is outside Counting Range. <u>Counter No.</u> indicates the Counter number and <u>CV No.</u> indicates the Comparison Value number. (The counting range of Circular and Linear Counters can be specified, refer to section 3-2-1 “Circular Counter” and 3-2-2 “Linear Counter” for more information).
0331	Counter No.	CV No. (BCD)	Comparison Values are equal	For the Counter, with the <u>Counter Number</u> as reported in Error Code 2, one or more Comparison Values are equal. <u>CV No.</u> indicates the Comparison Value number.

Clearing DM-configuration errors

DM-configuration errors can be cleared by correcting the faulty settings in Data Memory and consecutively transferring the new configuration data again to the Unit. To transfer the configuration data you can choose from one out of two possibilities:

- Turn the power of the CJ-series PLC system ON.
- Restart the Counter Unit (refer to section 4-1-2 "Special I/O Units Restart bits").

5-2-2 IOWR/IORD-instruction errors

IOWR/IORD-instruction errors are detected by the Unit after they have been issued from the ladder program to the Counter Unit. IOWR-instructions are used to change Counter settings of the Unit. In case you specify faulty operands in the IOWR-instruction the Unit reports this as an error. IORD-instructions only generate an error in case an invalid Control Code or an invalid number of words is specified.

Error Code 1	Error Code 2		Error	Description
0350	Invalid Control Code		Invalid Control Code	The Control Code, specified in the IOWR/IORD-instruction is not supported by the Counter Unit. The <u>Invalid Control Code</u> is reported in Error Code 2.
0360	Control Code		Invalid number of words	The number of words that is specified in the IOWR/IORD-instruction is faulty. The <u>Control Code</u> of the instruction for which the invalid number of words is specified is reported in Error Code 2.
0400	Counter No.	000	Z-Reset Mode Out of Range	Two problems can cause this error. The Z-Reset Mode that you specified is not in the valid range (0-1). It is also possible that you issued an IOWR-instruction to change the Maximum or Minimum Count Value of a Circular or Linear Counter, causing one or more of the already defined Range Limits or Comparison Values to be outside the new Counting Range. <u>Counter No.</u> indicates the number of the Counter.
0412	Counter No.	000	Invalid Counting Range	The Lower Count Limit of the Counter is not a negative value and/or the Upper Count Limit is not a positive value.
0413	Counter No.	000	Invalid Current Counter Value	The Counter Value issued with the IOWR-instruction is outside the counting range of the Counter. <u>Counter No.</u> indicates the number of the Counter.
0420	Counter No.	Range No.	Invalid Range Limits	Upper Range Limit < Lower Range Limit. <u>Counter No.</u> indicates the Linear Counter number and <u>Range No.</u> indicates the Range number.

Error Code 1	Error Code 2	Error	Description
0430	Counter No. Range No. (BCD) / CV No. (BCD)	Invalid Range Limit(s) / Comparison Value	If the Unit is in Range Mode: Lower and/or Upper Range Limit is/are outside Counting Range. <u>Counter No.</u> indicates the Counter number and <u>Range No.</u> indicates the Range number. If the Unit is in Comparison Mode: Comparison value is outside Counting Range. <u>Counter No.</u> indicates the Counter number and <u>CV No.</u> indicates the Comparison Value number. (The counting range of Circular and Linear Counters can be specified, refer to section 3-2-1 "Circular Counter" and 3-2-2 "Linear Counter" for more information).
0431	Counter No. CV No. (BCD)	Comparison Values are equal	For the Counter with the <u>Counter Number</u> as reported in Error Code 2 one or more Comparison Values are equal. <u>CV No.</u> indicates the Comparison Value number.

Clearing IOWR-instruction errors

IOWR-instruction errors can be cleared by issuing the IOWR-instruction with the Error Clear ("EC") command (refer to section 4-5-3-4 "Error Clear Command" for more information).

5-2-3 Overflow/Underflow errors

Over- and underflow errors are reported only for Linear Counters assuming that they have been configured to generate error codes (refer to section 3-2-2 "Linear Counter").

Error Code 1	Error Code 2	Error	Description
0450	Counter No.	Overflow	The Linear Counter with the <u>Counter No.</u> as reported in Error Code 2 generated overflow.
0460	Counter No.	Underflow	The Linear Counter with the <u>Counter No.</u> as reported in Error Code 2 generated underflow.

Clearing overflow/underflow errors

Overflow- and underflow errors can be cleared by resetting or presetting the Counter that generated over- or underflow. To reset a Counter refer to section 3-6 "Reset Signals". To preset a Counter refer 3-4 "Controlling a Counter".

5-2-4 Preset error

A Preset error is generated if a Circular or Linear Counter is preset with an invalid Preset Value (refer to section 3-4 "Controlling a Counter" for more information about presetting). The Preset Value is invalid if it is outside the counting range of the Circular or Linear Counter.

Error Code 1	Error Code 2	Error	Description
0470	Counter No.	Invalid Preset Value	The Linear Counter with the <u>Counter No.</u> as reported in Error Code 2 is preset with an invalid Preset Value.

Clearing Preset error

A Preset error can be cleared by resetting or by presetting the Counter that generated a Preset error, with a valid Preset Value. To reset a Counter refer to section 3-6 "Reset Signals". To preset a Counter refer to section 3-4 "Controlling a Counter".

5-2-5 Interrupt FIFO full error

Every interrupt you want to use, is assigned to an external interrupt task number (0-255). This number corresponds with the external interrupt task in the CJ-series CPU Unit that is to be executed when the assigned interrupt is activated (refer to section 4-6 "Interrupts").

Multiple interrupts, will be queued in FIFO-order inside the Counter Unit, for as long as the current active interrupt is not executed. The FIFO-buffer stores up to 30 interrupt requests. If the FIFO-buffer is full the Unit will report an error to the CJ-series CPU Unit. All interrupts generated by the Unit, after the "Interrupt FIFO full" error has occurred will be ignored and will not generate additional errors. Error Code 2 contains the external interrupt task number of the corresponding interrupt that was excluded from the full FIFO-queue.

Error Code 1	Error Code 2	Error	Description
0480	External Interrupt Task No. (BCD)	Interrupt-FIFO full	The interrupt-FIFO inside the Counter Unit is full and the interrupt assigned to <i>External Interrupt Task</i> could not be executed.

Clearing Interrupt FIFO error

If the speed with which the Counter Unit generates interrupts is higher than the speed with which the CJ-series CPU Unit executes the interrupts, the FIFO-buffer inside the Unit runs full and the "Interrupt FIFO full" error is generated. The error can be cleared by issuing the IOWR-instruction with the Error Clear ("EC") command (refer to section 4-5-3-4 "Error Clear Command" for details).

The error indicates that the load of interrupts on the CJ-series CPU Unit is too high. Clearing the error as mentioned before most probably needs additional measures to be taken in order to prevent this error from happening in the future:

- Mask one or more interrupts of the Unit, which caused the error.
- Mask one or more interrupts of other Units in the system, which are generating interrupts as well.
- Reduce the execution time of the assigned External Interrupt Tasks.

External interrupt requests from the Counter Unit will not reach the CPU Unit if the CPU Unit is not a CJ1-H or CJ1M CPU Unit (CJ1 CPU Units which do not support external interrupts), or the Unit is mounted at an incorrect position.

Make sure that the Counter Unit is installed in the correct position. It must be installed in one of the five positions adjacent to the CPU Unit if a CJ1-H CPU Unit is used, or in one of the three positions adjacent the to CPU Unit if a CJ1M CPU Unit is used.

5-2-6 System Errors

When errors occur in the CJ-series CPU Unit or on the I/O Bus the ERH-LED is turned ON. At the occurrence of an I/O Bus error an error code (see n+17, n+18) is generated as well.

Error Code 1	Error Code 2	Error	Description
000E	0000	I/O Bus error	An error has occurred on the I/O Bus causing the Counter Unit to be in an undefined state. On occurrence of an I/O Bus error you can configure the Outputs to keep their last state or to have a pre-defined state (refer to section 3-6 "Reset Signals").
0002	Time-Out in milliseconds	Time-Out error	A cyclic refresh time-out error was generated caused by a PLC system error or you have chosen to disable the Cyclic Refresh of the Counter Unit in the CJ-series PLC settings. This error will be cleared as soon as Cyclic Refresh will take place again. The IORF ladder instruction has no influence on this behaviour.

Clearing System errors

Turn ON the power supply again or restart the system. If the error persists, then replace the CJ-series CPU Unit.

5-3 Maintenance and Inspection

This section describes the routine cleaning and inspection recommended as regular maintenance.

5-3-1 Cleaning

Clean the Counter Unit regularly as described below in order to keep it in its optimal operating condition.

- Wipe the Unit with a dry, soft cloth for regular cleaning.
- When a spot cannot be removed with a dry cloth, dampen the cloth with a neutral cleanser, wring out the cloth, and wipe the Unit.
- A smudge may retain on the Unit from gum, vinyl, or tape that was left on for a long time. Remove the smudge when cleaning.

 **Caution** Never use volatile solvents such as paint thinner or benzene or chemical wipes. These substances could damage the surface of the Unit.

5-3-2 Routine Inspections

In order for your Counter Unit to continue operating at optimum condition, periodic inspections are necessary. Be sure to inspect the system periodically to keep it in its optimal operating condition. In general, inspect the system once every 6 to 12 months, but inspect more frequently if the system is used with high temperature or humidity or under dirty / dusty conditions.

Inspection Equipment

Prepare the following equipment before inspecting the system.

Required Equipment:

Have a standard and Phillips-head screwdriver, multimeter, alcohol, and a clean cloth.

Equipment that could be needed:

Depending on the system conditions, a synchroscope, oscilloscope, thermometer, gas sensor or hygrometer (to measure humidity) might be needed.

Inspection Procedure

Check the items in the following table and correct any items that are not according to the criteria.

Item		Criteria	Equipment
Environmental conditions	Ambient temperature	0° C to 55° C	Thermometer
	Ambient humidity	10% to 90%	Hygrometer
	Dust/dirt accumulation	None	---
	Is the Unit exposed to any spray of water, oil, or chemicals?	None	---
	Is the Unit exposed to corrosive or flammable gases?	None	Gas sensor
	Is the Unit exposed to shock or vibration?	None	
Installation	Is the Unit installed securely?	No looseness	---
	Are the external connectors securely mounted?	No looseness	---
	Is all external wiring securely connected?	No looseness	---
	Are the external connectors fully inserted?	No looseness	---
	Are the connecting cables undamaged?	No damage	---

Appendix A

Using Input Terminal Block Units

The XW2G-40G7-E, XW2B-40G4, XW2B-40G5 and XW2D-40G6 Input Terminal Blocks provide an easy connection of input signals to the CJ1W-CTL41-E via standard OMRON I/O cables (XW2Z-xxxK).

The Table below lists the Input signals and the pin numbers on these Input Terminal Blocks. Refer to the Manual on Input Terminal Blocks for more details (X074-E1-01)

		XW2G-40G7-E		XW2B-40G4 / XW2B-40G5		XW2D-40G6	
		Signal	Pin No.	Signal	Pin No.	Signal	Pin No.
Channel 1	A	LD+ / 24V+	1A+	LD+	1	LD+	A1
		LD- / 24V-	1A-	LD-	2	LD-	B1
	B	LD+ / 24V+	1B+	LD+	3	LD+	A2
		LD- / 24V-	1B-	LD-	4	LD-	B2
	Z	LD+ / 24V+	1Z+	LD+	5	LD+	A3
		LD- / 24V-	1Z-	LD-	6	LD-	B3
		---		Not connected	7 ~ 10	Not connected	A4, B4, A5, B5
Channel 2	A	LD+ / 24V+	2A+	LD+	11	LD+	A6
		LD- / 24V-	2A-	LD-	12	LD-	B6
	B	LD+ / 24V+	2B+	LD+	13	LD+	A7
		LD- / 24V-	2B-	LD-	14	LD-	B7
	Z	LD+ / 24V+	2Z+	LD+	15	LD+	A8
		LD- / 24V-	2Z-	LD-	16	LD-	B8
		---		Not connected	17 ~ 20	Not connected	A9, B9, A10, B10
Channel 3	A	LD+ / 24V+	3A+	LD+	21	LD+	A11
		LD- / 24V-	3A-	LD-	22	LD-	B11
	B	LD+ / 24V+	3B+	LD+	23	LD+	A12
		LD- / 24V-	3B-	LD-	24	LD-	B12
	Z	LD+ / 24V+	3Z+	LD+	25	LD+	A13
		LD- / 24V-	3Z-	LD-	26	LD-	B13
		---		Not connected	27 ~ 30	Not connected	A14, B14, A15, B15
Channel 4	A	LD+ / 24V+	4A+	LD+	31	LD+	A16
		LD- / 24V-	4A-	LD-	32	LD-	B16
	B	LD+ / 24V+	4B+	LD+	33	LD+	A17
		LD- / 24V-	4B-	LD-	34	LD-	B17
	Z	LD+ / 24V+	4Z+	LD+	35	LD+	A18
		LD- / 24V-	4Z-	LD-	36	LD-	B18
		---		Not connected	37 ~ 40	Not connected	A19, B19, A20, B20

Appendix B

Assigning External Interrupt Tasks to Outputs

The following table shows which External Interrupt Task Numbers are assigned to rising- and falling edges of the corresponding Output bits in the Unit Output Pattern. Two External Interrupt Tasks are assigned to every Output if that Output has been enabled to generate interrupts. An output can be enabled to generate interrupts by setting the corresponding bit in the Output Interrupt Enable Data (refer to section 4-6-1 "Outputs Generating Interrupts").

Output	Assigned External Interrupt Task Number	Interrupt executed at rising/falling edge*
0	Offset	Rising
	Offset + 1	Falling
1	Offset + 2	Rising
	Offset + 3	Falling
2	Offset + 4	Rising
	Offset + 5	Falling
3	Offset + 6	Rising
	Offset + 7	Falling
4	Offset + 8	Rising
	Offset + 9	Falling
5	Offset + 10	Rising
	Offset + 11	Falling
6	Offset + 12	Rising
	Offset + 13	Falling
7	Offset + 14	Rising
	Offset + 15	Falling
8	Offset + 16	Rising
	Offset + 17	Falling
9	Offset + 18	Rising
	Offset + 19	Falling
10	Offset + 20	Rising
	Offset + 21	Falling
11	Offset + 22	Rising
	Offset + 23	Falling
12	Offset + 24	Rising
	Offset + 25	Falling
13	Offset + 26	Rising
	Offset + 27	Falling
14	Offset + 28	Rising
	Offset + 29	Falling
15	Offset + 30	Rising
	Offset + 31	Falling

* The assigned External Interrupt Task number is executed at a rising/falling edge of the corresponding Output bit in the Unit Output Pattern.

Output	Assigned External Interrupt Task Number	Interrupt executed at rising/falling edge*
16	Offset + 32	Rising
	Offset + 33	Falling
17	Offset + 34	Rising
	Offset + 35	Falling
18	Offset + 36	Rising
	Offset + 37	Falling
19	Offset + 38	Rising
	Offset + 39	Falling
20	Offset + 40	Rising
	Offset + 41	Falling
21	Offset + 42	Rising
	Offset + 43	Falling
22	Offset + 44	Rising
	Offset + 45	Falling
23	Offset + 46	Rising
	Offset + 47	Falling
24	Offset + 48	Rising
	Offset + 49	Falling
25	Offset + 50	Rising
	Offset + 51	Falling
26	Offset + 52	Rising
	Offset + 53	Falling
27	Offset + 54	Rising
	Offset + 55	Falling
28	Offset + 56	Rising
	Offset + 57	Falling
29	Offset + 58	Rising
	Offset + 59	Falling
30	Offset + 60	Rising
	Offset + 61	Falling
31	Offset + 62	Rising
	Offset + 63	Falling

* The assigned External Interrupt Task number is executed at a rising/falling edge of the corresponding Output bit in the Unit Output Pattern.

Appendix C

Application Restrictions

The following restrictions apply when using CJ1W-CTL41-E Counter Units.

Restriction	Reference
The Open Gate Bit, Close Gate Bit, Preset Counter Bit, Reset Bit, or the Counter Capture Bit in CIO may not be executed if turned ON for only one PLC-cycle. Always keep these bits turned ON until the execution status changes in the corresponding flag in n+21, n+25, n+29 and n+33.	3-4 "Controlling a Counter" 4-2 "Memory Allocation"
The comparison operation stops for 1.5 ms from when the Counter Value falls within the Upper Range Limit or Lower Range Limit for the Range Data. However, the comparison does not stop for other counters. This time should be taken in consideration when making settings for Range Data.	3-5-1-2 "Configuration and operation in Range Mode"
When the Counter Value reaches the target value for Comparison Data, comparison stops for 1.5 ms. However, comparison for other counters does not stop. This time should be taken in consideration when making settings for Comparison Data.	3-5-2-2 "Configuration and operation in Comparison Mode"
Comparison is stopped during the execution of IOWR/IORD-instructions and remains stopped until the processing of the instruction has been completed. The Data Transfer Busy bit is ON during this time. This stopping of comparison during the execution of IOWR/IORD-instructions affects counter comparisons for all counters. Set Range Data and Comparison Data considering that comparisons are stopped by execution of IOWR/IORD-instructions.	3-5-1-2 "Configuration and operation in Range Mode" 3-5-2-2 "Configuration and operation in Comparison Mode"
The I/O Refresh will not occur while the Data Transfer Busy bit (CIO n+17, bit 02) is ON, and the Counter Value will not be refreshed while this bit is ON.	4-1-1 "Basic Setup"
The Unit's Data Transfer Busy bit (n+17, bit 02) will turn ON for approximately 120 ms at restart and when the power is turned ON.	4-2-3 "CIO-Memory Mapping"
When using the IOWR-instruction to write Comparison Data to the Unit, check that the target value being written will not be duplicated in the same Counter. If a target value already set to the Unit is transferred, set the Comparison Data so that the same value will be overwritten for the existing target value.	4-5 "Supported IOWR/IORD-Instructions"
A CJ1G-CPU□□H, CJ1H-CPU□□H or CJ1M-CPU□□ CPU Unit is required to use external interrupt tasks. CJ1G-CPU□□ CPU Units (Without the H suffix) do not support external interrupt tasks. There are also restrictions on the position of the Unit on the Rack. Refer to the section given in the right column for information on the restrictions.	4-6 "Interrupts"
The External Interrupt Task buffer can store up to 30 requests.	5-2-5 "Interrupt FIFO full error"

Appendix D

Comparison between CJ1W-CTL41-E and other Counter Units

This appendix provides a functional comparison between the CJ1W-CTL41-E, CS1W-CT041 and CQM1-CTB41 Counter Units.

	CJ1W-CTL41-E	CQM1-CTB41	CS1W-CT041
Product name	4-Channel Counter Unit for CJ1	High-speed Counter Board for CQM1	4-Channel High-speed Counter Unit for CS1
Number of Counters	4	4	4
Input signal levels	<ul style="list-style-type: none"> • RS-422A Line Driver • 24 V (via XW2G-40G7-E Input Terminal Block) 	<ul style="list-style-type: none"> • RS-422A Line Driver • 24 V 	<ul style="list-style-type: none"> • RS-422A Line Driver • 24 V • 12 V • 5 V
Counter Type	<ul style="list-style-type: none"> • Circular Counter • Linear Counter 	<ul style="list-style-type: none"> • Circular Counter • Linear Counter 	<ul style="list-style-type: none"> • Simple Counter • Circular Counter • Linear Counter
Maximum Input Frequency	100 kHz	500 kHz	500 kHz
Signals per Counter	Phase A, B and Z	Phase A, B and Z	Phase A, B and Z
Input Signal Types	<ul style="list-style-type: none"> • Phase Differential (1x / 2x / 4x) • Up/Down • Pulse/Direction 	<ul style="list-style-type: none"> • Phase Differential (1x / 2x / 4x) • Up/Down • Pulse/Direction 	<ul style="list-style-type: none"> • Phase Differential (1x / 2x / 4x) • Up/Down • Pulse/Direction
Counter Control using PLC Control bits	<ul style="list-style-type: none"> • Open Gate / Start Counter • Close Gate / Stop Counter • Preset Counter (Preset Value set in CIO) • Reset Counter • Capture Counter Value 	<ul style="list-style-type: none"> • Reset Counter 	<ul style="list-style-type: none"> • Open Gate / Start Counter • Close Gate / Stop Counter • Preset Counter (Preset Value set in CIO) • Reset Counter • Capture Counter Value
Output Control Mode	Automatic Output Control in: <ul style="list-style-type: none"> • Range Mode Up to 4 Ranges can be configured • Comparison Mode Up to 8 Comparison values per channel can be configured 	Automatic Output Control in: <ul style="list-style-type: none"> • Range Mode Up to 16 Ranges can be configured • Comparison Mode Up to 48 Comparison values can be configured 	Automatic Output Control in: <ul style="list-style-type: none"> • Range Mode Up to 32 Ranges can be configured • Comparison Mode Up to 32 Comparison values per channel can be configured
Reset Signals	<ul style="list-style-type: none"> • Software Counter Reset Bit • Z-Input 	<ul style="list-style-type: none"> • Software Counter Reset Bit • Z-Input 	<ul style="list-style-type: none"> • Software Counter Reset Bit • Z-Input • Digital Input

	CJ1W-CTL41-E	CQM1-CTB41	CS1W-CT041
Extra Functions	<ul style="list-style-type: none"> Programmable Hysteresis (range [1, 255]) 	--	<ul style="list-style-type: none"> Programmable Hysteresis (range [1, 255]) Programmable Output Pulse (Applies to Digital Outputs) Rate Measurement (Pulse rate measurement based on programmable time window) Programmable Digital Inputs functions to control individual Counters
Noise Filtering Counter Inputs	<ul style="list-style-type: none"> Counter Inputs A and B: 100 kHz (Fixed) 	<ul style="list-style-type: none"> Counter Inputs A and B: 10 kHz, 50 kHz, 500 kHz (Programmable) 	<ul style="list-style-type: none"> Counter Inputs A and B: 25 kHz, 50 kHz, 250 kHz, 500 kHz (Programmable)
Initial Counter Value	<ul style="list-style-type: none"> Can be set in PLC The Initial Counter Value is transferred to the Unit upon Power-Up/Restart. 	<ul style="list-style-type: none"> Not supported 	<ul style="list-style-type: none"> Can be set in PLC The Initial Counter Value is transferred to the Unit upon Power-Up/Restart.
IORD- and IOWR-instructions	<p>Run-time configuration:</p> <ul style="list-style-type: none"> DM-configuration data Range- and Comparison Data (Re) Configure Counter Unit <p>Run-time operation:</p> <ul style="list-style-type: none"> Read Counter Value Error Clear 	Not supported	<p>Run-time configuration:</p> <ul style="list-style-type: none"> DM-configuration data Range- and Comparison Data (Re) Configure Counter Unit <p>Run-time operation:</p> <ul style="list-style-type: none"> Read Counter Value Error Clear
Digital Inputs	--	--	4 Digital Inputs (24 V, NPN or PNP)
Digital Outputs	--	4 Digital Outputs (5 to 24 V)	4 Digital Outputs (12 to 24 V, NPN or PNP)
Interrupts	<p>Interrupt generation to PLC CPU:</p> <ul style="list-style-type: none"> By Software Outputs 	Not supported	<p>Interrupt generation to PLC CPU:</p> <ul style="list-style-type: none"> By Software Outputs Digital Inputs
Error History Log Function	Storage of up to 30 error records	Not supported	Storage of up to 30 error records

Index

A

Allocating Memory 61
Application Areas 13
Automatic Output Control 38

B

Basic Configuration 4

C

Captured Counter Value, reading with IORD 86
Capturing 37
CIO-Memory Mapping, Input Words 67
CIO-Memory Mapping, Output Words 66
Circular Counter 30
Comparison Memory Mapping 75
Comparison Mode 46
 Configuration and operation 49
 Example with Circular Counter 47
 Example with Linear Counter 46
 Overview 48
Comparison Value 49
Comparison-Data
 Allocation 63, 75
 Configuration 49
 Examples 65
Components 16
Configuring the Counter Unit 10, 28
 Counter Types 29
 Circular Counter 30
 Linear Counter 31
 Hysteresis 54
 Initial Counter Value 55
 Input Signal Types 33
 Phase Differential Signals (x1, x2, x4) 33
 Pulse & Direction Signals 35
 Up & Down Signals 34
 Output Control 38
 Comparison Mode 46
 Range Mode 40
 Resetting 53
Connector 21
 Pin-layout 21
 Wiring Methods 22
 Terminal Block Unit 22
Counter Input Circuitry

 Example Line Driver (RS422) 25
Counter Inputs 24
 Configuring Driver Type 21
 Example Line Driver (RS422) 25
 Specifications 7
Counter Types 29
 Circular Counter 30
 Linear Counter 31
Counter Value 29
Counting Direction 38
Counting Range
 Circular Counter 30
 Linear Counter 31

D

Data Exchange, between CPU and CJ1W-CTL41-E 58
Dimensions 16
Direction of Counting 38
DM-configuration 28
DM-configuration errors 94
DM-data, changing at run-time using IOWR/IORD 81
DM-Memory Mapping 69
Driver Types
 Counter Inputs 21

E

EC Directives
 Low voltage, EN 61131-2:1994+A12:2000 XV
EMC Directives
 EMI directive XVI
 EMS directive XVI
Enable Reset 53
ERC-indicator 16, 92
ERH-indicator 16, 17, 92
Error Categories
 DM-configuration errors 94
 Interrupt FIFO full error 97
 IOWR/IORD-instruction errors 95
 Overflow/Underflow errors 96
 Preset errors 96
Error Clear Command 87
Error codes 93
Error History Log File 94
Error Indicators
 During Initial processing 92

During Normal processing 92

Error Processing 95

Errors, clearing

DM-configuration errors 94

Interrupt FIFO full error 97

IOWR/IORD-instruction errors 95

Overflow/Underflow errors 96

Example, Comparison Mode

Comparison Mode with Circular Counter 47

Comparison Mode with Linear Counter 46

Example, configuring Comparison-Data 63

Example, configuring Range-Data 62

Example, Range Mode

Range Mode with Circular Counter 41

Range Mode with Linear Counter 40

Extra Functions

Hysteresis 54

Initial Counter Value 55

F

Features and Functions 2

Functional Specifications 6

G

General specifications 5

H

Hysteresis 54

I

Indicators 16

ERC 16

ERH 17

RUN 16, 92

Indirect Addressing 62

Initial Counter Value 55

Input Drivers 21

Input Functionality

Capture Function 37

Preset Function 36

Reset Function 36

Input Signal Types 33

Phase Differential Signals (x1, x2, x4) 33

Pulse & Direction Signals 35

Up & Down Signals 34

Input specifications 7

Inspection 99

Installing High-speed Counter Unit

Components 16

Indicators 16

Installation 19

Switch settings 17

Machine Number Switch 17

Interrupt Task 89

Interrupts

Outputs Generating Interrupts 88

IORD-Instruction 79

IOWR/IORD-Instructions 81

(Re) Configure Unit 87

Captured Counter Value 86

Counter Value 86

DM-data 81

Error Clear Command 87

Range- and Comparison data 83

IOWR-Instruction 77

L

Linear Counter 11, 31

Logically AND/OR Counter Output Patterns 43

Low voltage directive XV

M

Machine Number Switch 17

Maintenance 99

Memory Allocation 61

CIO-Memory Mapping 65

Comparison Memory Mapping 75

DM-Memory Mapping 69

Indirect Addressing 62

Memory Mapping 61

Range Memory Mapping 74

Memory Mapping 61

Mounting the Unit 19

O

Offset 89

Operating High-speed Counter Unit 9, 11

Output Control 38

Comparison Mode 46

Range Mode 40
Output Pattern
 Logically AND/OR Counter Output Patterns 45
 Unit Output Pattern 39
Output Status 39
Outputs
 Status Information 39
Outputs Generating Interrupts 88
Overflow 32
Overflow Error-Code Generation 32
Overlapping, of Range/Comparison Data 61, 62

P

Phase Differential Signals (x1, x2, x4) 33
Physical Outputs 39
Pin-layout Connector 21
Power OFF detection 55
Presetting 36
Pulse & Direction Signals 35

Q

Quick Start Up Information 9

R

Range 40
Range Memory Mapping 74
Range Mode 40
 Configuration and Operation 43
 Example with Circular Counter 41
 Example with Linear Counter 40
 Logically AND/OR Counter Output Patterns 45
 Overview 42
Range-Data
 Allocation 64, 74
 Changing at run-time, using IORD/IOWR 83
 Configuration 43
 Examples 64
Re-configure Unit, using IOWR 87
Reset Signals
 Reset Enable 53
 Software Reset Bit 53
 Z-Signal 53
Resetting 36, 53
Restarting the Unit 60

RUN-indicator 16, 92

S

Soft Outputs 39
Software Reset Bit 53
Special I/O Unit CIO Area 59
Special I/O Unit DM Area 59
Special I/O Unit Restart bits 60
Specifications 5
 Functional 6
 General 5
 Input 7
Starting Up
 Quick Start Up Reference Guide 9
Status Outputs 39
Status Z-Inputs 37
Switches 17
 Machine Number Switch 17

T

Terminal Block Unit 22, 101
Troubleshooting 93

U

Underflow 32
Underflow Error-Code Generation 32
Unit Output Pattern 39
Up & Down Signals 34

W

Wiring 21
 Connector Pin-layout 21
 Connector Wiring Methods 22
 Terminal Block Unit 22
 Counter Input Circuitry
 Example Line Driver 24
 Line Driver (RS422) 25
 Important Wiring Considerations 23

Z

Z-signal, resetting by 53

Revision History

A manual revision code appears as a suffix to the catalog number on the front cover of the manual.

Cat. No. W02E-EN-01

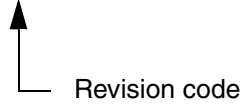

The following table outlines the changes made to the manual during each revision. Page numbers refer to section the previous version.

Revision code	Date	Revised content
01	September 2004	Original production