

CJ-series High-speed Counter Unit

CJ1W-CT021

CSM_CJ1W-CT_DS_E_3_1

High-Speed, Flexible Control With A Wide Array of Features

- Equipped with 2 Counters and counts over a maximum binary range of 32-bits.
- Accepting input pulse frequencies of up to 500 kHz allows precise control of fast motions.
- The Unit is equipped with 2 Digital Inputs, 2 Digital Outputs and 30 Soft Outputs.
- A maximum response time of 0.5 ms guarantees high-speed closed loop control of applications.



CJ1W-CT021

Features

- Input frequencies to 500 kHz.
- 32-bit counting range.
- Digital variable noise filter provided.
- 5, 12, 24 V line driver inputs available.
- Supports simple, ring, and linear counting modes.
- Supports two external control inputs, and a total of 16 functions can be set: open gate, close gate, preset, reset, capture, stop/capture/reset combinations, reset enable, and more.
- One Unit supports two external outputs and 30 internal outputs with counter value zone comparisons, target comparisons, delays, holds, programmable outputs, and hysteresis settings.
- Pulse rate measurement function and data logging.
- Counter outputs and external control inputs can be used to trigger interrupt tasks in the CPU.

System Configuration

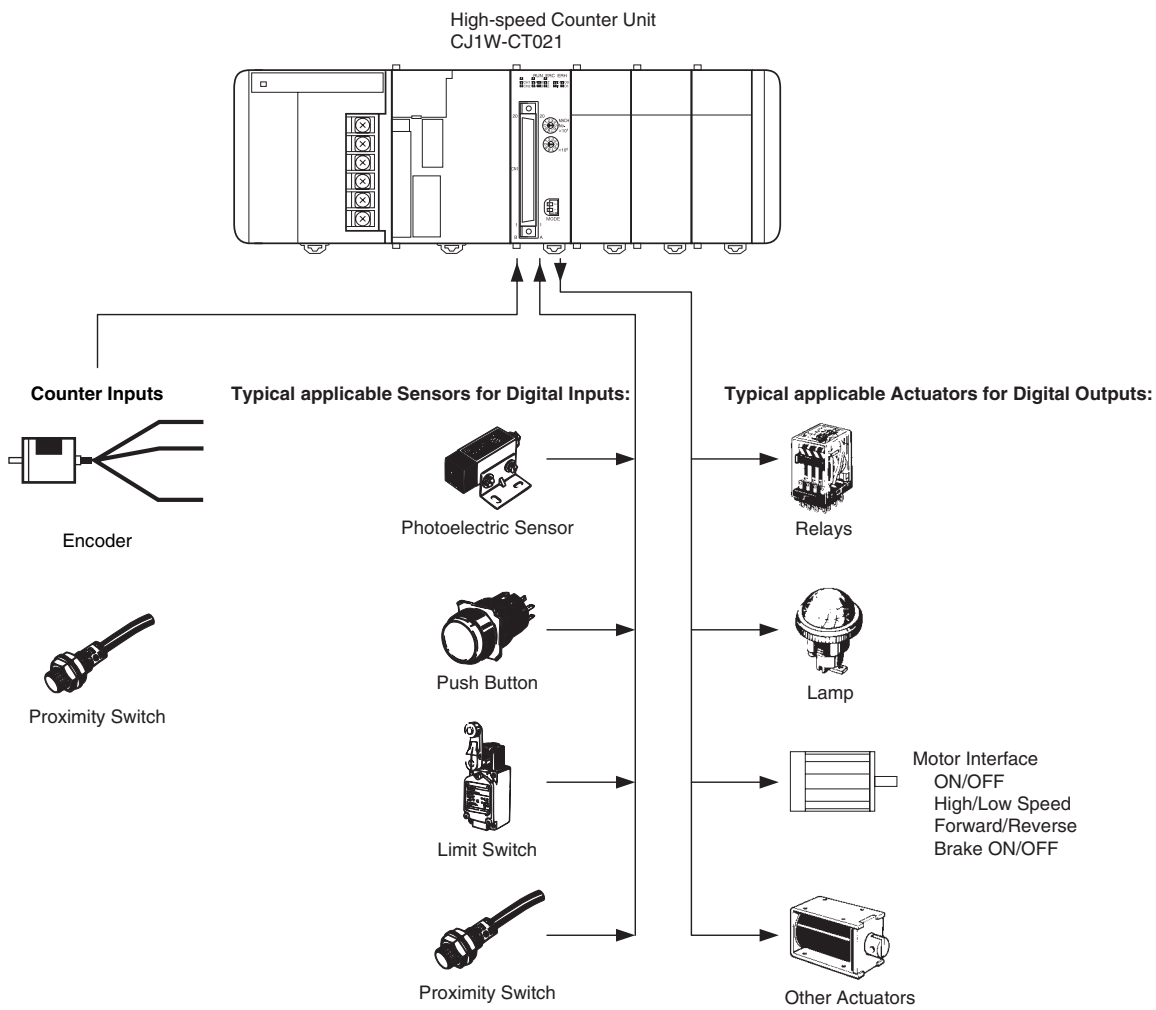

Ordering Information

International Standards

- The standards are abbreviated as follows: U: UL, U1: UL (Class I Division 2 Products for Hazardous Locations), C: CSA, UC: cULus, UC1: cULus (Class I Division 2 Products for Hazardous Locations), CU: cUL, N: NK, L: Lloyd, and CE: EC Directives.
- Contact your OMRON representative for further details and applicable conditions for these standards.

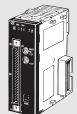
Unit type	Product name	Specifications			No. of unit numbers allocated	Current consumption (A)		Model	Standards
		Countable channels	Encoder A and B inputs, pulse input Z signals	Max. counting rate		5 V	24 V		
CJ1 Special I/O Units		2	Open collector Input voltage: 5 VDC, 12 V, or 24 V (5 V and 12 V are each for one axis only.)	50kHz	4	0.28	-	CJ1W-CT021	UC1, N, L, CE
			RS-422 line driver	500kHz					





Note: The following functions become unavailable when it is used with the NJ-series CPU unit.

- Counter value capture using allocation area (CIO)
- The capture, Stop/capture/continue, Stop/capture/reset/continue, and Capture/reset functions using External Control Input Function
- Pulse rate range control using Output Control Mode
- The pulse rate measurement function
- Because the NJ Series has no power OFF interrupt task, operation cannot be restarted from the position at which the power was interrupted.
- The IORD/IOWR instruction
- Starting of External Interrupt Task by Output and External Control Input

Accessories

The High-Speed Counter Unit includes the 40-pin solder-type connectors C500-CE404 (socket: Fujitsu FCN-361J040-AU, cover: Fujitsu FCN-360C040-J2).

Applicable Connectors

Name	Connection	Specifications	Model
40-pin Connectors	Soldered 	FCN-361J040-AU Connector FCN-360C040-J2 Connector Cover Right angle type, included with Unit	C500-CE404
	Crimped 	FCN-363J040 Housing FCN-363J-AU Connector FCN-360C040-J2 Connector Cover Right angle type	C500-CE405
	Pressure welded 	FCN-367J040-AU/F, w/o connector cover	C500-CE403
	Soldered 	40-pin, soldered, w/connector cover	C500-CE401
	Crimped 	40-pin, crimped w/connector cover	C500-CE402

Connector-Terminal Conversion Unit and Connection Cables

Product Name		Specifications		Model
For Connecting with Terminal Block	Connecting Cables	Normal wiring	Cable length: 0.5m	XW2Z-050B
			Cable length: 1.0m	XW2Z-100B
			Cable length: 1.5m	XW2Z-150B
			Cable length: 2.0m	XW2Z-200B
			Cable length: 3.0m	XW2Z-300B
			Cable length: 5.0m	XW2Z-500B
	Connector-Terminal Conversion Unit	Through	40-pin M2.4 screw terminals	XW2B-40G4
			40-pin M3.5 screw terminals	XW2B-40G5
		Slim	40-pin M3 screw terminals	XW2D-40G6

Mountable Racks

Model	NJ system		CJ system (CJ1, CJ2)		CP1H system	NSJ system	
	CPU Rack	Expansion Rack	CPU Rack	Expansion Backplane	CP1H PLC	NSJ Controller	Expansion Backplane
CJ1W-CT021	10 Units	10 Units (per Expansion Rack)	10 Units	10 Units (per Expansion Backplane)	2 Units *	Not supported	8 Units

* A CP1W-EXT01 CJ Unit Adaptor is required.

Specifications

General Specifications

Item	CJ1W-CT021
Unit type	CJ-series Special I/O Unit
General Specifications	Conform to general specifications for CJ/NJ-series
Ambient Operating Temperature	0 to 55 °C
Ambient Storage Temperature	-20 to 75 °C
Ambient Operating Humidity	10% to 90% without condensation
Internal Current Consumption	280 mA (at 5 V)
Dimensions	31 × 90 × 65 mm (W × H × D)
Weight	100 g
Mounting Position	CJ-series CPU Rack or CJ-series Expansion Rack *1, NJ-series CPU Rack or NJ-series Expansion Rack
Maximum Number of CT021 Units per Rack	Equal to the number of slots of the Rack *2
Maximum Number of CT021 Units per basic CJ/NJ system	24
Data Exchange with CPU Unit	<ul style="list-style-type: none"> I/O Refresh Data Area (CIO-bits 200000 to 255915, CIO-words 2000 to 2959): *3 Special I/O Unit DM-Area (D-words 20000 to 29599): 400 DM-words per Unit are transmitted from the CPU to the Unit at Power Up or when the Unit is restarted *4

- *1. The Unit must be in one of the five positions immediately to the right of the CJ1-H CPU Unit or in one of the three positions immediately to the right of the CJ1M CPU Unit to activate external interrupt tasks. No external interrupt tasks can be activated if the Unit is in any other position (i.e., 6th Unit position or further away from the CJ1-H CPU Unit, or 4th Unit position or further away from the CJ1M CPU Unit), or if it is on a CJ-series Expansion Rack.
- *2. The maximum number of Units per Rack is also depending on the maximum supply current of the Power Supply Unit and the current consumption of other Units on the Rack.
- *3. The CJ1W-CT021 Special I/O Unit is allocated words for 40 words in the Special I/O Unit (CIO) Area.
- *4. The CJ1W-CT021 Special I/O Unit is allocated words for 4 Units in the Special I/O Unit DM Area. From the 400 DM words that are allocated, the first 113 words are used to make the DM-settings and the remaining 287 words can be used as work-words.

Functional Specifications

Item	CJ1W-CT021
Number of Counters	2
Counter Type	<ul style="list-style-type: none"> Simple Counter Circular Counter Linear Counter The Counter Type can be chosen by DIP switch at the front of the Unit. By default the Counters are set to Simple Counter.
Maximum Input Frequency	500 kHz
Maximum Response Time	0.5 ms (refer to High-speed counter Unit Operation Manual (Cat. No.W401))
Signals per Counter	Phase A, B and Z
Digital I/O	<ul style="list-style-type: none"> 2 Digital Inputs (I0 and I1): Every Digital Input can be assigned to a Counter. In this way one Counter can be controlled by a maximum of 2 Digital Inputs. 2 Digital Outputs (O0 and O1): The Unit Output Pattern represents the 2 Digital Outputs and 30 Soft Outputs.
Input Signal Types	<ul style="list-style-type: none"> Phase Differential (multiplication ×1), (multiplication ×2) * 1 and (multiplication ×4) * 1 Up/Down * 1 Pulse & Direction * 1
Counter Control using CIO-software bits *4	<ul style="list-style-type: none"> Open Gate / Start Counter: Counter is enabled to count pulses Close Gate / Stop Counter: Counter is disabled to count pulses Preset Counter: Preset Value can be set in CIO Reset Counter to zero Capture Counter Value: Captured Counter Value can be read using IORDInstruction
Digital Input Functionality	<ul style="list-style-type: none"> Gate * 1 Reset * 1 Preset * 1 Capture * 1 Stop/Capture-Continue * 1* 4 Stop/Capture-Reset/Continue * 1* 4 Capture/Reset * 1* 4 Enable Reset * 1 Disable Reset * 1 For every Function the corresponding action can be triggered on a rising- or on a falling edge.
Output Control Mode	<ul style="list-style-type: none"> Automatic ON/OFF output according to the following three modes: Range Mode * 1 Comparison Mode * 1 Rate Range * 1* 4 Manual output control
Output State Control	On changing the Operating Mode of the controller from RUN/MONITOR → PROGRAM, an I/O Bus Error or an Overflow/Underflow Error, the Digital Outputs can be configured to: <ul style="list-style-type: none"> Continue automatic updating Output States Freeze Output States * 1 Predefine Output States * 1
Output Driver Configuration	The Output Driver of every Digital Output can be configured as: <ul style="list-style-type: none"> NPN PNP * 1

Item	CJ1W-CT021
Reset Signals	Every Counter can be reset to zero by (a combination of) the following sources: <ul style="list-style-type: none"> • Software Counter Reset Bit • Digital Input * 1 • Z-Input * 1
Extra Functions	<ul style="list-style-type: none"> • Programmable Output Pulse * 1: To every Digital Output an ON-delay and/or a Pulse Duration [1 to 9999 ms] can be applied. • Rate Measurement * 1 * 4: For every Counter the Pulse Rate can be measured by defining a Time-Window [1 to 9999 ms]. Up to a maximum of 64 Rate Values are stored in the Rate History Log File. Rate Values from the Rate History Log File can be read using the IORD-instruction. Additionally for every Counter two Rate Ranges can be defined that control the Outputs according to the measured Rate Value. • Hysteresis * 1: To prevent Outputs from being switched On and Off by very small fluctuations in the Counter Value around Range Limits, for every Counter an Hysteresis-value [1 to 255] can be defined (the Unit must in Range Mode).
Noise Filtering Counter Inputs and Digital Inputs	To suppress noise on the signal lines of the Counter Inputs (A and B) and the Digital Inputs (I0 and I1) a Noise Filter can be configured: <ul style="list-style-type: none"> • 10 kHz * 1 • 50 kHz (default) • 500 kHz * 1 For the Digital Inputs the 500 kHz filter can not be selected. The Z-Input Signals of every Counter are filtered with a fixed Noise Filter of 1 kHz.
Initial Counter Value *4	<ul style="list-style-type: none"> • The Initial Counter Value * 1 is transferred to the Unit when the Unit is Powered Up or Restarted. The Initial Counter Value is very useful to overcome problems in case of power failure.
IORD- and IOWR-instructions *4	Run-time * 3 configuration and operation of the High-speed Counter Unit is possible by using IORD- and IOWR-instructions. The following data can be read or written: <ul style="list-style-type: none"> • DM-configuration data * 1 • Range- and Comparison Data * 1 • Captured Counter Value • Rate History Log File Data * 1 • Counter Value • (Re) Configure High-speed Counter Unit * 1 • Error Clear
Interrupts of Outputs *4	<ul style="list-style-type: none"> • The Digital Outputs and the Soft Outputs of the Unit Output Pattern can all be configured to generate interrupts to the CJ1-H/CJ1M CPU Unit * 1 * 2.
Interrupts of Digital Inputs *4	<ul style="list-style-type: none"> • The Digital Inputs can all be configured to generate interrupts to the CJ1-H/ CJ1M CPU Unit * 2.
Error History Log Function	<ul style="list-style-type: none"> • Stores up to 30 error log records

- *1. This specification item is only supported for Circular and Linear Counters (not for Simple Counters). For a complete overview of the differences between Simple and Circular/Linear Counters refer to High-speed Counter Unit Operation Manual (Cat. No. W401).
- *2. To activate external interrupt tasks, a CJ1-H or CJ1M CPU Unit must be used. CJ1 CPU Units do not support external interrupt tasks. To activate external interrupt tasks in a CJ1-H CPU Unit, the CJ1W-CT021 High-speed Counter Unit must be in one of the five positions immediately to the right of the CJ1-H CPU Unit. For CJ1M CPU Units, the CJ1W-CT021 High-speed Counter Unit must be in one of the three positions immediately to the right of the CJ1M CPU Unit. No external interrupt tasks can be activated if the Unit is in any other position (i.e., 6th Unit position or further away from the CJ1-H CPU Unit, or 4th Unit position or further away from the CJ1M CPU Unit), or if it is on a CJ-series Expansion Rack.

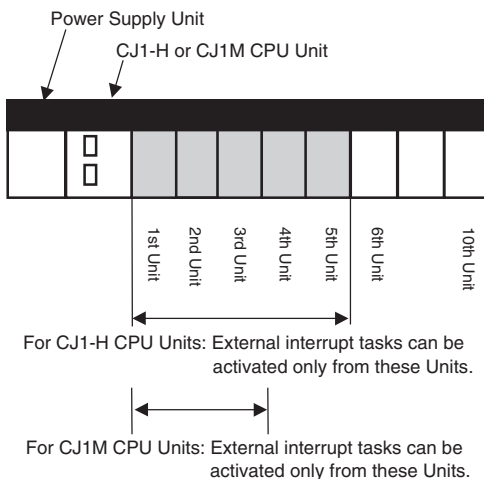

- *3. If an IOWR- or IORD-instruction is used during operation, comparison will stop during instruction execution. Care must be taken, therefore, with the timing of executing instructions.
- *4. This specification item cannot be used with N J-series CPU units.

Input Specifications

Item	Counter Inputs A and B				Digital Inputs (I0 and I1)
	24 VDC (19.6 to 26.4 V)	12 VDC (9.8 to 13.2 V)	5 VDC (4.5 to 5.5 V)	Line Driver	24 VDC (19.6 to 26.4 V)
Input Voltage	24 VDC (19.6 to 26.4 V)	12 VDC (9.8 to 13.2 V)	5 VDC (4.5 to 5.5 V)	Line Driver	24 VDC (19.6 to 26.4 V)
Input Current (typical)	8 mA	8 mA	7 mA	11 mA Connectable to RS-422 compatible Line Drivers.	7.6 mA
ON Voltage (min.)	19.6 V	9.8 V	4.5 V		19.6 V
OFF Voltage (max.)	4 V	2.5 V	1.5 V		4 V

Item	Counter Input Z			
	24 VDC (18.6 to 26.4 V)	12 VDC (9.8 to 13.2 V)	5 VDC (4.5 to 5.5 V)	Line Driver
Input Voltage	24 VDC (18.6 to 26.4 V)	12 VDC (9.8 to 13.2 V)	5 VDC (4.5 to 5.5 V)	Line Driver
Input Current (typical)	7.3 mA	6.6mA	6 mA	11 mA Connectable to RS-422 compatible Line Drivers.
ON Voltage (min.)	18.6 V	9.8V	4.5 V	
OFF Voltage (max.)	4 V	2.5V	1.5 V	

- Note: 1.** The Counter Inputs (A, B, Z) are insulated from each other and from the Digital Inputs. The Digital Inputs are also insulated from each other. All Counter Inputs and Digital Inputs are reverse polarity protected and insulated from the I/O-bus.
- 2.** A noise filter can be configured (10 kHz or 50 kHz (default)) for the Digital Inputs. Every Z-Input has a defined noise filter of 1 kHz.
- 3.** If the 50-kHz noise filter is configured for External Control Inputs, signals of 10 μs or longer can be read.

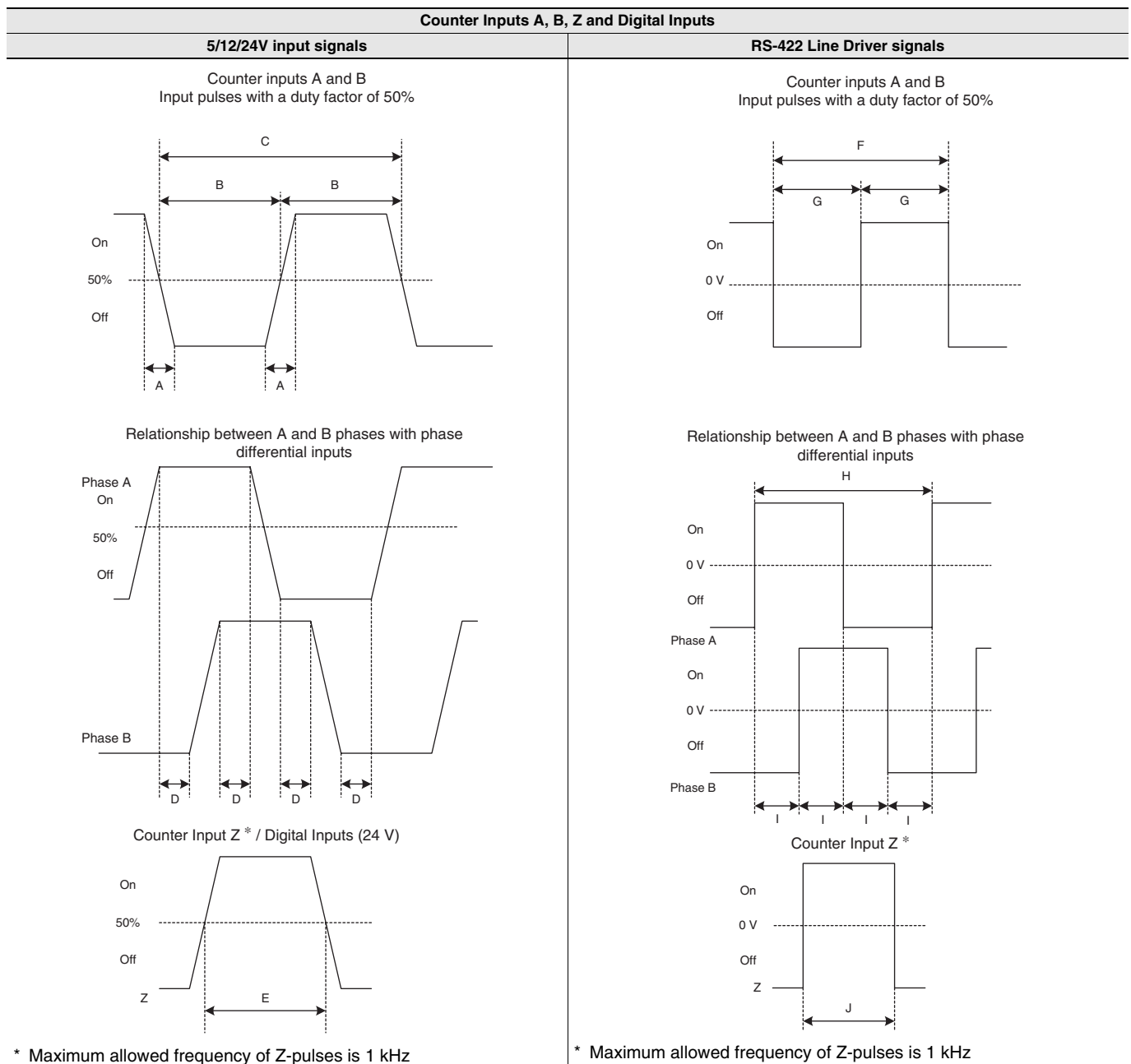

Filter Selection	Timing requirement (μs)									
	A	B	C	D	E	F	G	H	I	J
10 kHz	<3	>50	>100	>23	>10	>100	>50	>100	>23	>10
50 kHz	<3	>10	>20	>4.5	>10	>20	>10	>20	>4.5	>10
500 kHz	–	–	–	–	–	>2	>1	>4	>1	>10

Note: As a general guideline it can be stated that if you want the timing requirements for the Counter Inputs to satisfy the above mentioned specifications, you must pay attention to the type of output driver of the encoder being used, the length of the encoder cable and the frequency of the count pulses generated. For example, if you use an Open Collector encoder (e.g. E6B2-CWZ6C) at 24 V with 10 m cable, you can typically generate count pulses up to 20 kHz. Therefore, if you want to generate count pulses with higher frequencies, you should use a different type of encoder (e.g. E6B2-CWZ1X with Line Driver output or a fast push-pull 24 V encoder, e.g. E6C3-CWZ5GH (Complementary output)) or reduce the length of the encoder cable.

Output Specifications

Item	Specification
Driver Type	Open Collector (NPN/PNP selectable)
Operating Voltage Range	12 to 24 V (10.2 to 26.4 V) 30 mA max. at 26.4 VDC (for PNP output, without load current)
Maximum Switching Capacity	46 mA at 10.2 V to 100 mA at 26.4 V (200 mA maximum/common) (see picture below)
Minimum Switching Current	5 mA
Output ON-delay	100 μs max.
Output OFF-delay	100 μs max.
Leakage Current	0.1 mA max.
Residual Voltage	1.5 V max.
Short Circuit Protection	No

- Note:**
- Every Digital Output has 2 Output drivers available: NPN and PNP (available as separate pins on the front connectors). Every Output can be separately (DM-) configured for NPN or PNP. By default the Outputs are configured as NPN-output.
 - The Digital Outputs are insulated from the I/O-bus but not from each other. They are not short circuit protected.
 - The Output current must not exceed 200 mA per common (i.e. per 2 Digital Outputs) otherwise the unit will be damaged.
 - The Outputs can be automatically or manually controlled (DM-setting) by using Manual Output Control in CIO.
 - The state control of the Outputs, in case the operating mode of the CPU-Unit is changed from RUN/MONITOR \rightarrow PROGRAM, an I/O Bus error or an Overflow/Underflow error occurs, can be configured.

Maximum Switching Capacity

The maximum switching current depends upon the power supply voltage, as shown below.

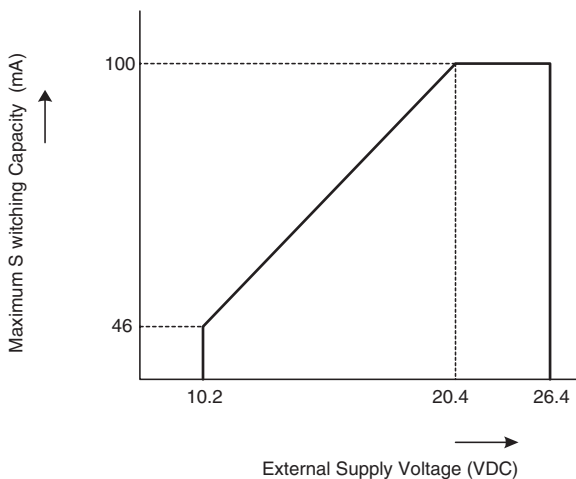

External Interface

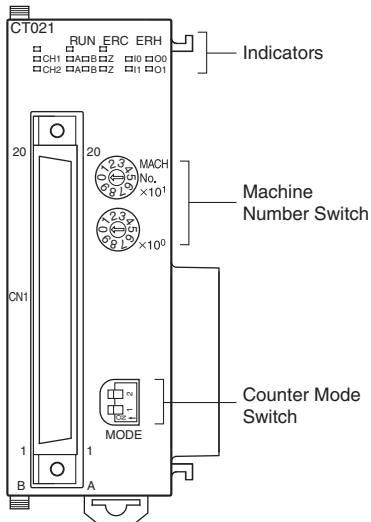

Indicators



CT021						
	RUN	ERC	ERH			
CH1	A	B	Z	I0	O0	
CH2	A	B	Z	I1	O1	

The indicators on the LED-display show the operating status of the Unit. The following table shows the meaning of the indicators.

LED	Color	State	Description
RUN	Green	ON	Unit is in operation (i.e. Unit has initialised normally after (re-) starting the Unit).
		OFF	Unit is not in operation (i.e. Unit was not able to initialise normally after (re-) starting the Unit or the power to the Unit is switched OFF).
ERC	Red	ON	Unit has operational failure due to a detected error.
		OFF	Unit has no operational failure.
ERH	Red	ON	CPU Unit has operational failure.
		OFF	CPU Unit has no operational failure.
CH1/2	Green	ON	Channel 1/2 (i.e. Counter 1/2) is ready to count (the corresponding counting gate is open).
		OFF	Counter 1/2 is not ready to count (the corresponding counting gate is closed).
A/B/Z	Yellow	ON	Physical Input A/B/Z has turned ON. (Every Counter is characterised by the signals A/B/Z.)
		OFF	Physical Input A/B/Z is turned OFF.
I0/I1	Yellow	ON	Digital Input (I0/I1) is turned ON.
		OFF	Digital Input (I0/I1) is turned OFF.
O0/O1	Yellow	ON	Digital Output (O0/O1) is turned ON.
		OFF	Digital Output (O0/O1) is turned OFF.

Using Connector-Terminal Conversion Unit

Wiring requires the dedicated connection cables. Connector-Terminal Conversion Unit and Connection Cables are sold separately.

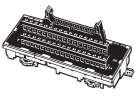
Model	Connection Cable	Connector-Terminal Conversion Unit
 CJ1W-CT021	 XW2Z-□□□B	 XW2B-40G4 (40-pin M2.4 screw terminals) XW2B-40G5 (40-pin M3.5 screw terminals) XW2D-40G6 (40-pin M3 screw terminals)

Dimensions

(Unit : mm)

CJ1W-CT021

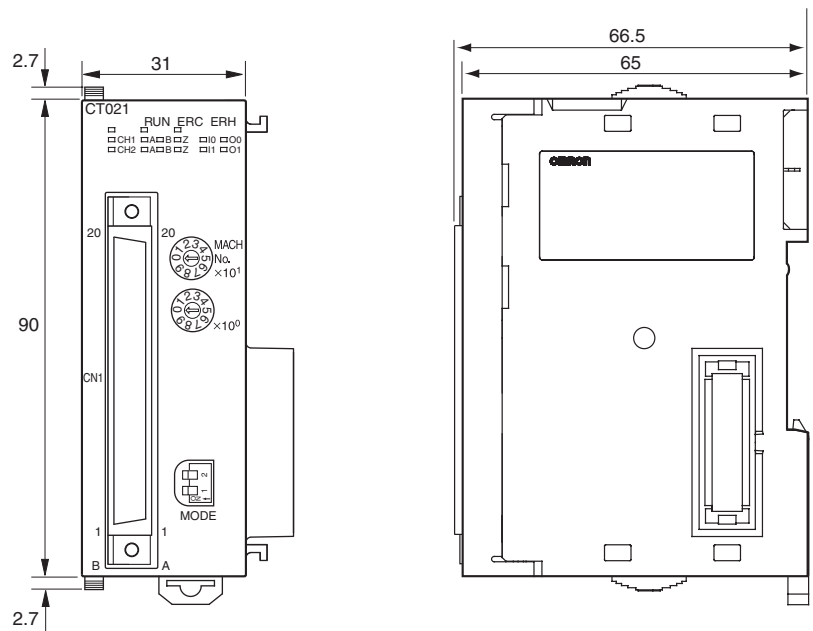

Dimensions with Connector

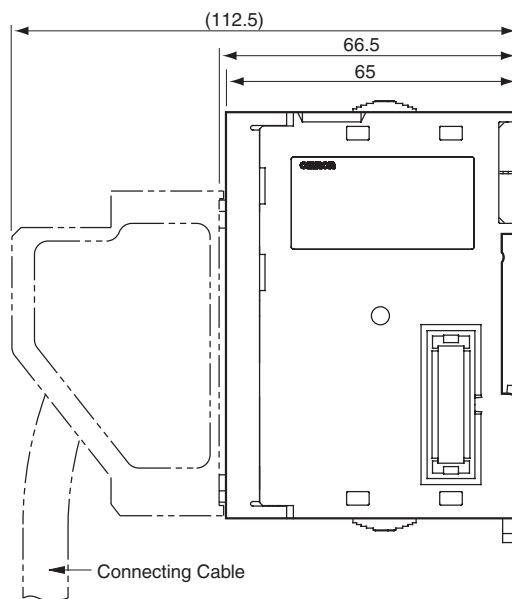

Related Manuals

Cat. No.	Model	Name	Contents
W401	CJ1W-CT021	High-speed Counter Units Operation Manual	Provides information on operating and installing High-speed Counter Units, including details. On basic settings, memory operation, direct operation from CPU and other functions.
W492	CJ1W-CT021	CJ-series High-speed Counter Units Operation Manual for NJ-series CPU Unit	The methods and precautions for using CJ-series High-speed Counter Units with an NJ501 CPU Unit are described, including access methods and programming interfaces. Use these manuals together with the NJ-series CPU Unit Hardware User's Manual (Cat. No. W500) and NJ-series CPU Unit Software User's Manual (Cat. No. W501).

Read and Understand This Catalog

Please read and understand this catalog before purchasing the products. Please consult your OMRON representative if you have any questions or comments.

Warranty and Limitations of Liability

WARRANTY

OMRON's exclusive warranty is that the products are free from defects in materials and workmanship for a period of one year (or other period if specified) from date of sale by OMRON.

OMRON MAKES NO WARRANTY OR REPRESENTATION, EXPRESS OR IMPLIED, REGARDING NON-INFRINGEMENT, MERCHANTABILITY, OR FITNESS FOR PARTICULAR PURPOSE OF THE PRODUCTS. ANY BUYER OR USER ACKNOWLEDGES THAT THE BUYER OR USER ALONE HAS DETERMINED THAT THE PRODUCTS WILL SUITABLY MEET THE REQUIREMENTS OF THEIR INTENDED USE. OMRON DISCLAIMS ALL OTHER WARRANTIES, EXPRESS OR IMPLIED.

LIMITATIONS OF LIABILITY

OMRON SHALL NOT BE RESPONSIBLE FOR SPECIAL, INDIRECT, OR CONSEQUENTIAL DAMAGES, LOSS OF PROFITS OR COMMERCIAL LOSS IN ANY WAY CONNECTED WITH THE PRODUCTS, WHETHER SUCH CLAIM IS BASED ON CONTRACT, WARRANTY, NEGLIGENCE, OR STRICT LIABILITY.

In no event shall the responsibility of OMRON for any act exceed the individual price of the product on which liability is asserted.

IN NO EVENT SHALL OMRON BE RESPONSIBLE FOR WARRANTY, REPAIR, OR OTHER CLAIMS REGARDING THE PRODUCTS UNLESS OMRON'S ANALYSIS CONFIRMS THAT THE PRODUCTS WERE PROPERLY HANDLED, STORED, INSTALLED, AND MAINTAINED AND NOT SUBJECT TO CONTAMINATION, ABUSE, MISUSE, OR INAPPROPRIATE MODIFICATION OR REPAIR.

Application Considerations

SUITABILITY FOR USE

OMRON shall not be responsible for conformity with any standards, codes, or regulations that apply to the combination of products in the customer's application or use of the products.

At the customer's request, OMRON will provide applicable third party certification documents identifying ratings and limitations of use that apply to the products. This information by itself is not sufficient for a complete determination of the suitability of the products in combination with the end product, machine, system, or other application or use.

The following are some examples of applications for which particular attention must be given. This is not intended to be an exhaustive list of all possible uses of the products, nor is it intended to imply that the uses listed may be suitable for the products:

- Outdoor use, uses involving potential chemical contamination or electrical interference, or conditions or uses not described in this catalog.
- Nuclear energy control systems, combustion systems, railroad systems, aviation systems, medical equipment, amusement machines, vehicles, safety equipment, and installations subject to separate industry or government regulations.
- Systems, machines, and equipment that could present a risk to life or property.

Please know and observe all prohibitions of use applicable to the products.

NEVER USE THE PRODUCTS FOR AN APPLICATION INVOLVING SERIOUS RISK TO LIFE OR PROPERTY WITHOUT ENSURING THAT THE SYSTEM AS A WHOLE HAS BEEN DESIGNED TO ADDRESS THE RISKS, AND THAT THE OMRON PRODUCTS ARE PROPERLY RATED AND INSTALLED FOR THE INTENDED USE WITHIN THE OVERALL EQUIPMENT OR SYSTEM.

PROGRAMMABLE PRODUCTS

OMRON shall not be responsible for the user's programming of a programmable product, or any consequence thereof.

Disclaimers

CHANGE IN SPECIFICATIONS

Product specifications and accessories may be changed at any time based on improvements and other reasons.

It is our practice to change model numbers when published ratings or features are changed, or when significant construction changes are made. However, some specifications of the products may be changed without any notice. When in doubt, special model numbers may be assigned to fix or establish key specifications for your application on your request. Please consult with your OMRON representative at any time to confirm actual specifications of purchased products.

DIMENSIONS AND WEIGHTS

Dimensions and weights are nominal and are not to be used for manufacturing purposes, even when tolerances are shown.

PERFORMANCE DATA

Performance data given in this catalog is provided as a guide for the user in determining suitability and does not constitute a warranty. It may represent the result of OMRON's test conditions, and the users must correlate it to actual application requirements. Actual performance is subject to the OMRON Warranty and Limitations of Liability.

ERRORS AND OMISSIONS

The information in this document has been carefully checked and is believed to be accurate; however, no responsibility is assumed for clerical, typographical, or proofreading errors, or omissions.

2011.11

In the interest of product improvement, specifications are subject to change without notice.

OMRON Corporation
Industrial Automation Company

<http://www.ia.omron.com/>

(c)Copyright OMRON Corporation 2011 All Right Reserved.