

C-series Optical Fiber Cables

Installation Guide

Revised, May 1991

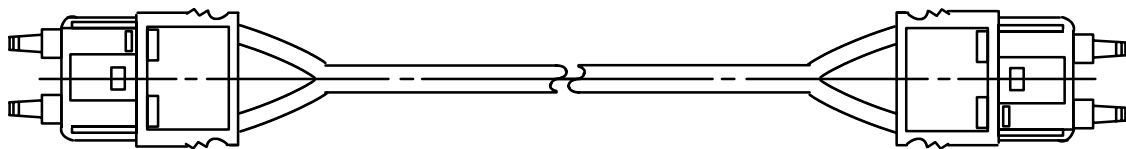

Notice:

OMRON products are manufactured for use according to proper procedures by a qualified operator and only for the purposes described in this manual.

The following conventions are used to indicate and classify warnings in this manual. Always heed the information provided with them.

DANGER! Indicates information that, if not heeded, could result in loss of life or serious injury.

Caution Indicates information that, if not heeded, could result in minor injury or damage to the product.

OMRON Product References

All OMRON products are capitalized in this manual. The word "Unit" is also capitalized when it refers to an OMRON product, regardless of whether or not it appears in the proper name of the product.

The abbreviation "Ch," which appears in some displays and on some OMRON products, means "word" and is abbreviated "Wd" in documentation.

The abbreviation "PC" means Programmable Controller and is not used as an abbreviation for anything else.

Visual Aids

The following headings appear in the left column of the manual to help you locate different types of information.

Note Indicates information of particular interest for efficient and convenient operation of the product.

1, 2, 3... Indicates lists of one sort or another, such as procedures, precautions, etc.

© OMRON, 1990

All rights reserved. No part of this publication may be reproduced, stored in a retrieval system, or transmitted, in any form, or by any means, mechanical, electronic, photocopying, recording, or otherwise, without the prior written permission of OMRON.

No patent liability is assumed with respect to the use of the information contained herein. Moreover, because OMRON is constantly striving to improve its high-quality products, the information contained in this manual is subject to change without notice. Every precaution has been taken in the preparation of this manual. Nevertheless, OMRON assumes no responsibility for errors or omissions. Neither is any liability assumed for damages resulting from the use of the information contained in this publication.

TABLE OF CONTENTS

SECTION 1

Introduction	1
1-1 Introduction to the Cord and Cable	2
1-2 Indoor Optical Fiber Cable	2
1-3 Indoor/Outdoor Optical Fiber Cable (PCF)	3
1-4 Plastic Optical Fiber Cable for Indoor Use (APF)	4

SECTION 2

Assembling Plastic Optical Fiber Cable	7
2-1 Pre-assembly Precautions	8
2-2 Optical Connector Polarity	8
2-3 Assembly Procedure	9

SECTION 3

Optical Fiber Cable Installation	11
3-1 Preparation of PCF Optical Fiber Cable for Indoor Use	12
3-2 Pre-installation Precautions	12
3-3 Environmental Considerations	13
3-4 Installation Methods	15

Appendices

A Standard Models	17
B Specifications	23
C Ordering Information	25

Glossary	27
-----------------------	-----------

Index	29
--------------------	-----------

Revision History	35
-------------------------------	-----------

About this Manual:

This manual explains the basics of the Optical Fiber Cables used with the SYSMAC C-series PC Systems. A basic introduction to the characteristics of optical fibers is presented.

An explanation of installation procedures is also given.

Section 1 Introduction provides an introduction to Optical Fiber Cables.

Section 2 Assembling Plastic Optical Fiber Cable contains information on how to assemble the Optical-Fiber Cables.

Section 3 Optical Fiber Cable Installation explains installation procedures.

SECTION 1

Introduction

1-1	Introduction to the Cord and Cable	2
1-2	Indoor Optical Fiber Cable	2
1-3	Indoor/Outdoor Optical Fiber Cable (PCF)	3
1-4	Plastic Optical Fiber Cable for Indoor Use (APF)	4

1-1 Introduction to the Cord and Cable

On the outside, Optical Fiber Cords and Cables look like electrical cords and cables. However, instead of metal wires carrying electrical signals, Optical Fiber Cords and Cables both consist of glass fibers and fillers. Optical signals travel through the glass fiber for distances up to 1 km. Though the filler protects the glass fiber, Optical Fiber Cords and Cables require much greater care during handling and installation than traditional electrical cords and cables. It is very important to protect the cord and cable from impact, and care should be taken to avoid excessive bending or twisting of the cord and cable. The Optical Fiber Cords are intended for indoor use while the Optical Fiber Cables are intended for outdoor use.

The cord and cable are supplied from a drum, and a reel stand should be used to hold the drum above the ground so that either the cord or cable can unwind easily and at a consistent speed.

1-2 Indoor Optical Fiber Cable

The following diagram shows the physical elements of indoor Optical Fiber Cable.

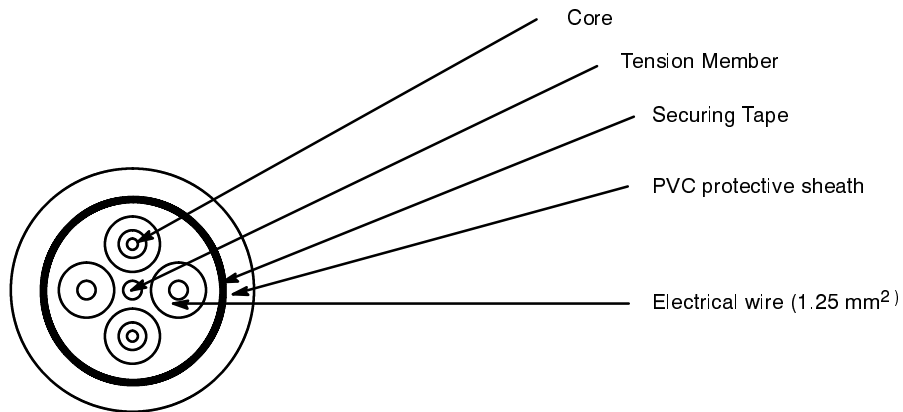

Optical Connector

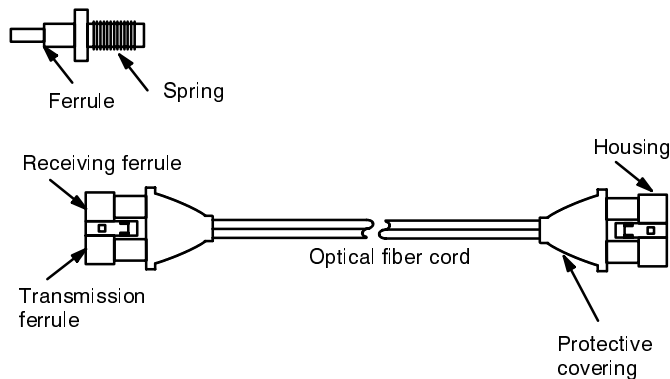

1-3 Indoor/Outdoor Optical Fiber Cable (PCF)

This Cable may be used indoors or outdoors, when lengths exceeding 50 m are needed, or when considerable force is required to feed the Cable through conduit.

B500-OF002

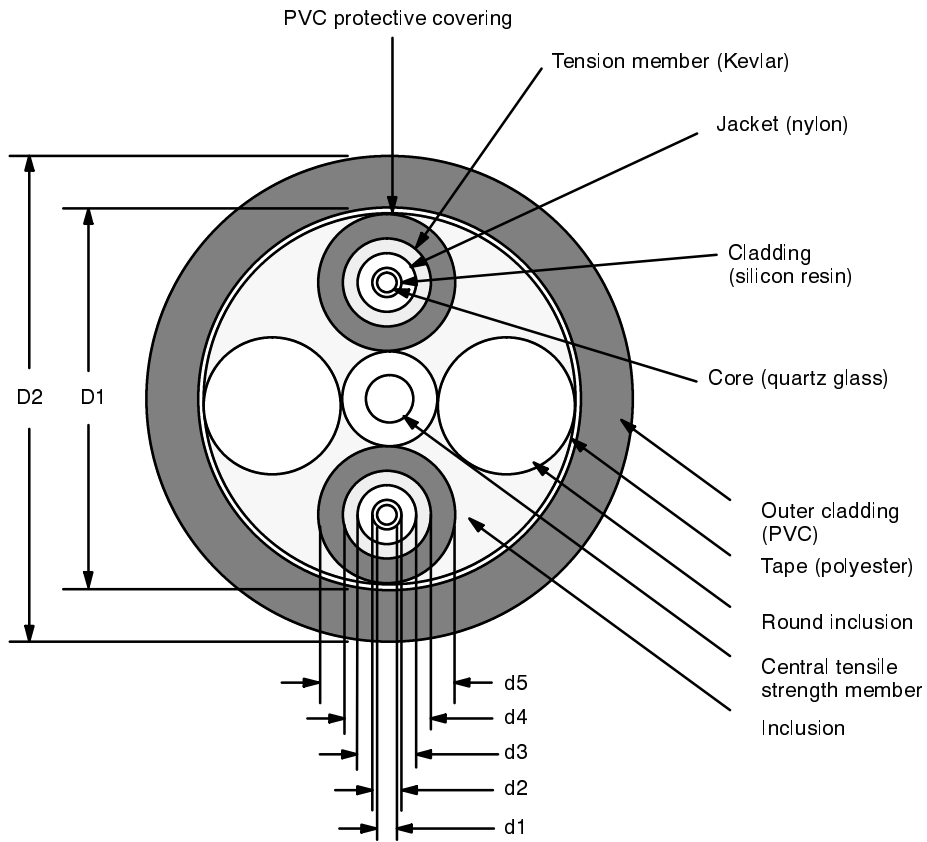

Dimensions

d1	Optical fiber core diameter	0.25 mm
d2	Optical fiber cladding diameter	0.35 mm
d3	Jacket diameter	0.9 mm
d4	Inner-covering diameter	1.3 mm
d5	Outer-covering diameter	3.0 mm
D1	Inner sheath diameter	9.5 mm
D2	Outer sheath diameter (cable dia.)	12.5 mm

Optical Connector Outside Measurements

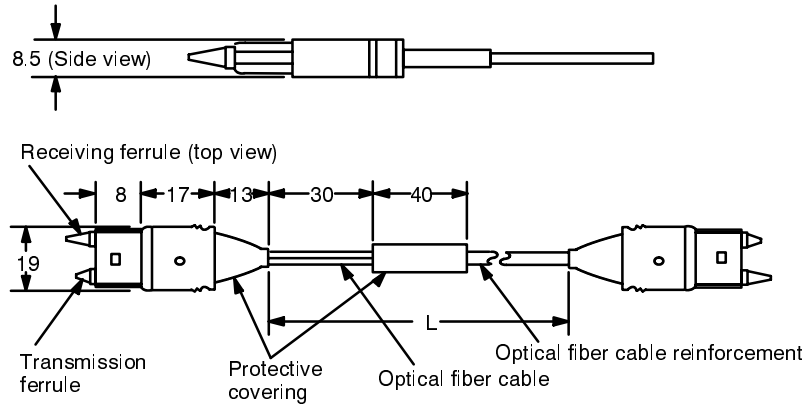

1-4 Plastic Optical Fiber Cable for Indoor Use (APF)

The large core diameter makes plastic (polymethyl methacrylate resin) Optical Fiber Cable easier to handle than other Optical Fiber Cable. However, care must be taken when ordering components, as the kind of Connector used will vary depending on the length of the cable to be assembled. Cables and Connectors are sold individually and require assembly (refer to *Section 2 Assembling PCF Optical Fiber Cable*).

3G5A2-PF101

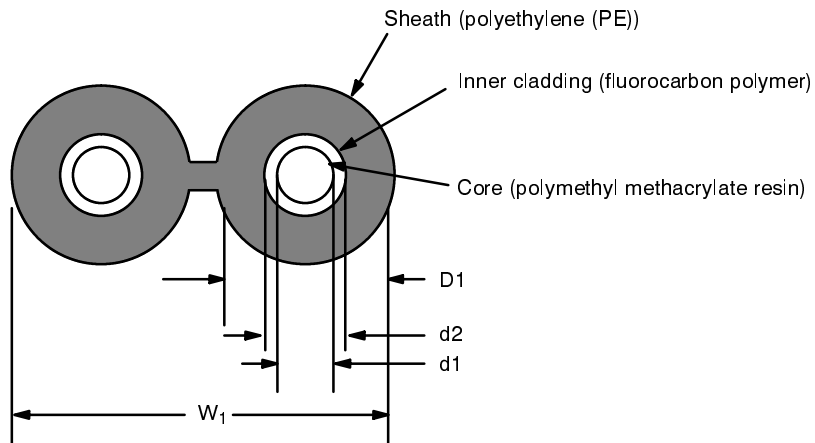

Dimensions

d1	Optical fiber core diameter	0.98 mm
d2	Optical fiber cladding diameter	1.00 mm
D1	Outer sheath diameter	2.2 mm
W1	Sheath	4.5 mm

Cable Length and Connectors

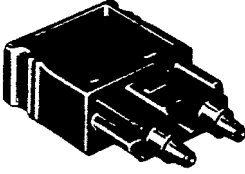
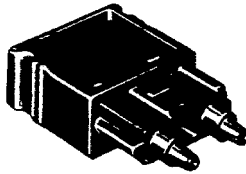
Cable length	10 cm to 10 m	8 to 20 m
Name	Optical connector A	Optical connector B
Appearance		
Model	3G5A2-CO001	3G5A2-CO002
Color	Brown	Black

Note Cables must be assembled in accordance with the above table. If the assembly is performed incorrectly, transmission will not be possible.

Optical Connector

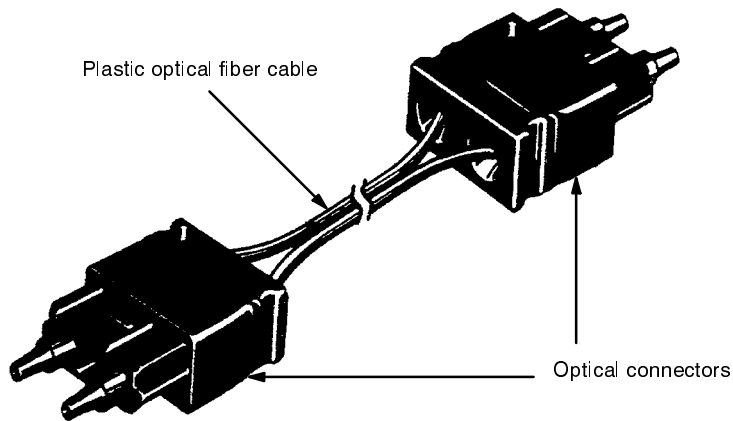

Optical Connector Outside Measurements

Side View

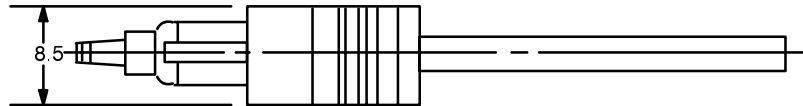

Top View

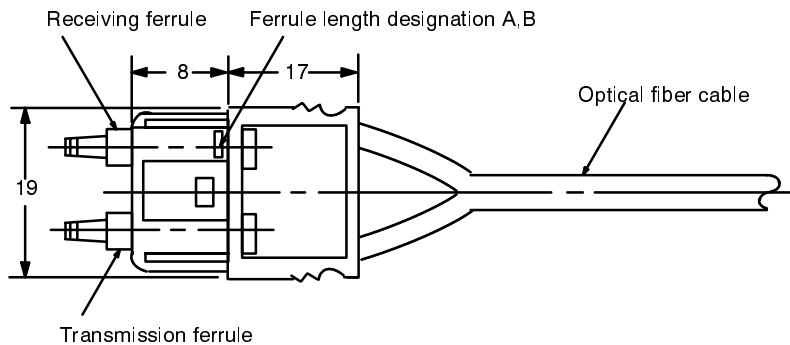

All units are in mm unless otherwise noted.

SECTION 2

Assembling Plastic Optical Fiber Cable

PCF Optical Fiber Cables can be assembled simply by using special nippers. Adhesives and grinding are not required. Just follow the directions below.

H-PCF Optical Fiber Cables require an optical connector assembly tool kit. For information on assembling the connector, please refer to the manual included in the optical connector assembly tool kit.

2-1	Pre-assembly Precautions	8
2-2	Optical Connector Polarity	8
2-3	Assembly Procedure	9

2-1 Pre-assembly Precautions

The appropriate Optical Connector depends on the length of cable to be assembled.

Refer to *Section 1-4 Plastic Optical Fiber Cable for Indoor Use*.

Note that connector types can be distinguished by color.

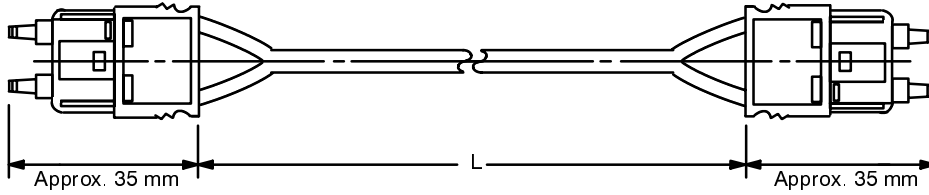

2-2 Optical Connector Polarity

The Optical Connector has two sides, T for transmit and R for receive, designated by **T** and **R** on the Optical Connector.

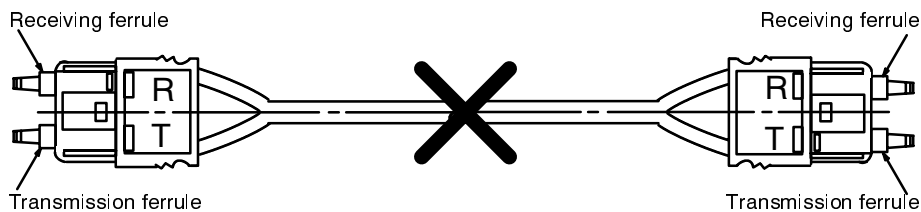
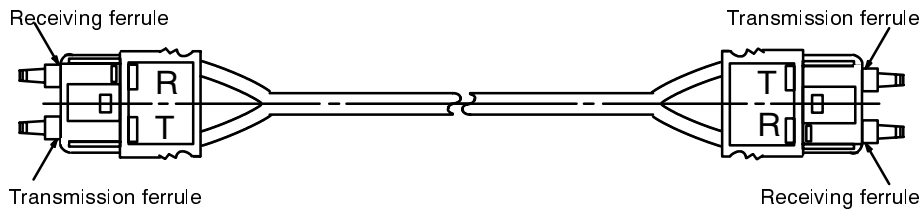
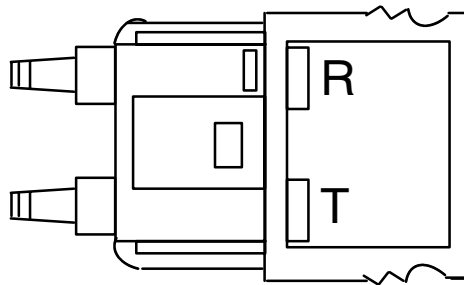

T and T and R and R are improperly connected.

A Cable with one end connected to (T) of one Connector must be connected with (R) of the other Connector. If two Ts or two Rs are connected, transmission will not be possible.

Each Cable has two fibers, one of which is marked with a blue stripe to distinguish it from the other.

2-3 Assembly Procedure

- 1, 2, 3... 1. Separate the Optical Fiber Cable.

Split the Cable tip with the nippers and pull it apart by hand to separate the two fibers.

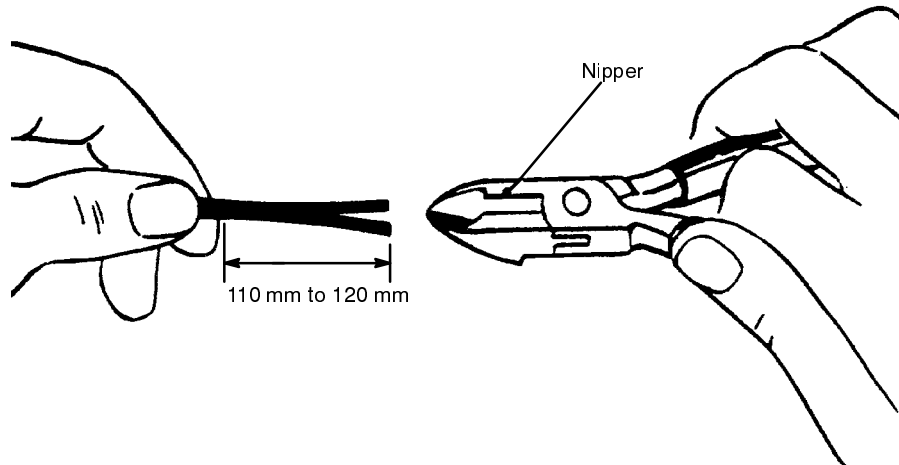

2. Strip off the sheath.

Remove 15 to 20 mm of the sheath using the nippers.

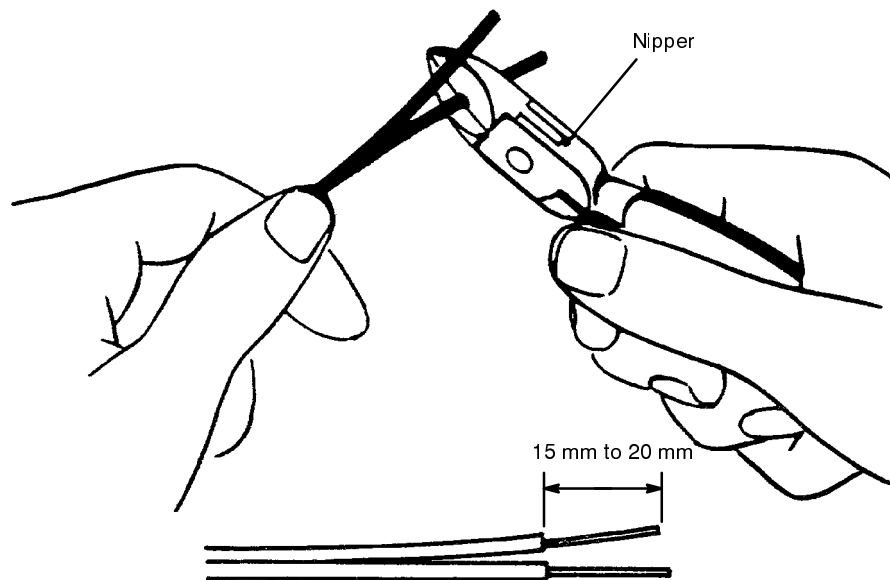

3. Using tweezers lift the fiber clamp of the Optical Connector and insert the Clamp until it protrudes approximately 5 mm from the tip of the ferrule.
4. Using the nipper handle, press the clamp until the Cable is securely fastened.

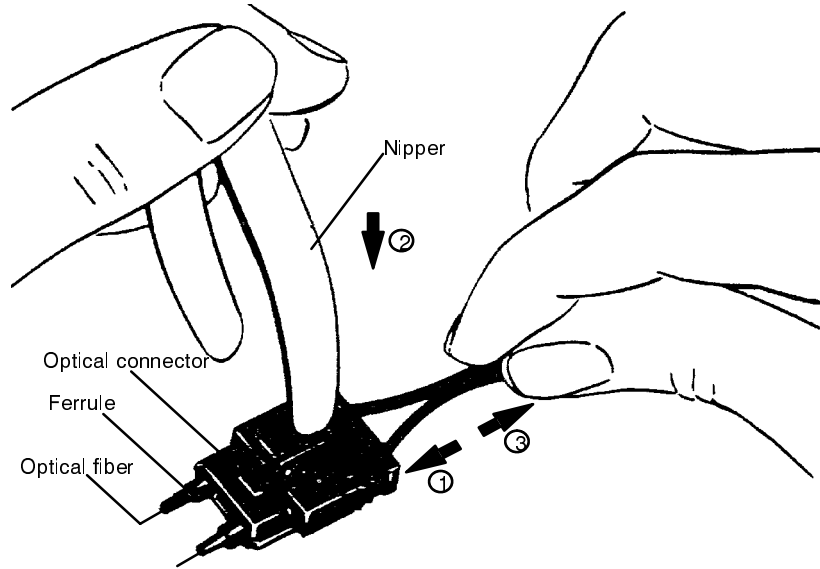

- 5. Pull lightly on the Optical Fiber Cable to confirm that the cable is securely held.

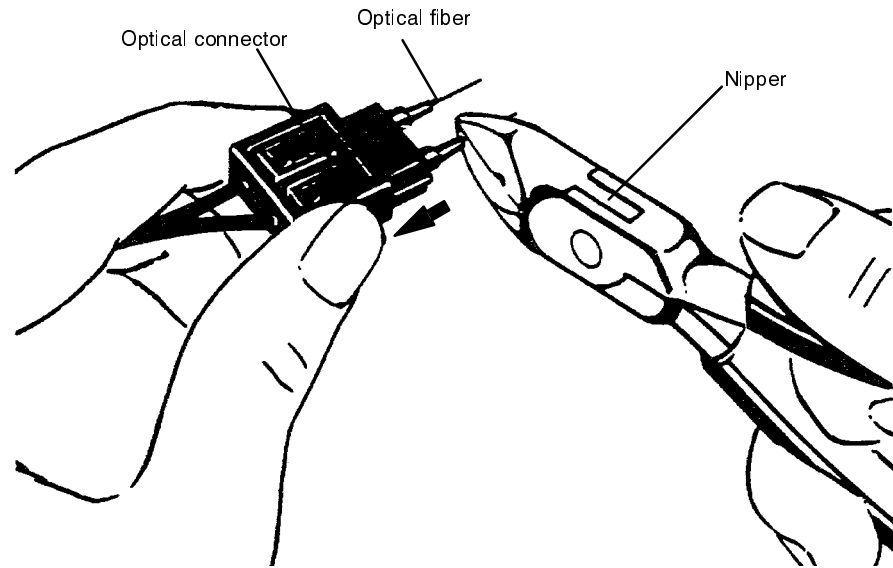

SECTION 3

Optical Fiber Cable Installation

This section describes installation and various factors to consider when installing the cable.

3-1	Preparation of PCF Optical Fiber Cable for Indoor Use	12
3-2	Pre-installation Precautions	12
3-3	Environmental Considerations	13
3-4	Installation Methods	15
3-4-1	Installing Optical Fiber Cable in Conduit	15
3-4-2	Aerial Installation	15
3-4-3	Fastening the Cable to Poles or Walls	16

3-1 Preparation of PCF Optical Fiber Cable for Indoor Use

Fasten the Connector and a portion of the Cable to a cable grip (commercially available), or fashion a similar device from wire. A rigid tension member may also be used. Tape this section of the Cable to the cable grip or tension member as shown in Fig. 1 and 2 below.

When installing, apply tension only to the Cable grip or tension member. If tension must be applied directly to the Optical Fiber Cable, use indoor/outdoor Cable.

The tensile force caused by installation must be relieved regardless of the variety of Cable used.

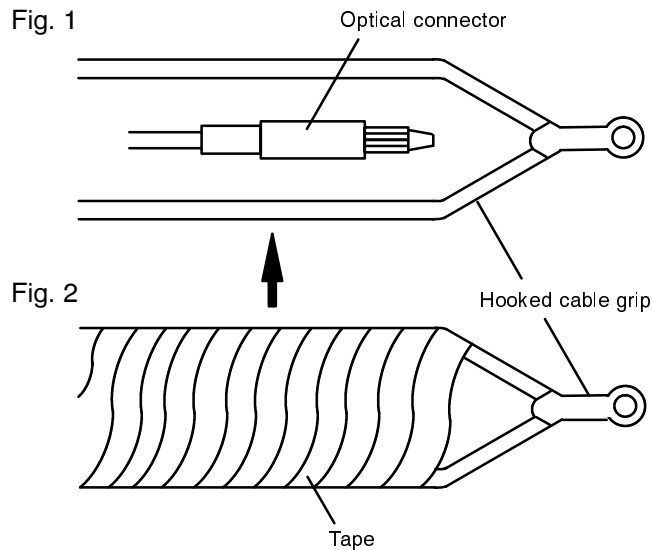

When passing the Cable through narrow pipe, detach the ferrule and the Connector for reassemble after feeding the cable. Avoid narrow pipe where possible.

3-2 Pre-installation Precautions

Optical Fiber Cable, particularly indoor Cable, is not very strong. Do not apply excessive pressure to it. When connecting or disconnecting the Cable, hold the Connector and not the Cable.

Prior to connecting the Cable to a PC, fasten the Cable securely a short distance from the Connector so as not to strain the connection.

If the Optical Fiber Cable is to be coiled after installation, be sure the cable is coiled in a large diameter so that transmission is not impaired. As a general rule, a minimum diameter of 100 mm should present no problem. The risk of transmission impairment increases as the coil diameter decreases.

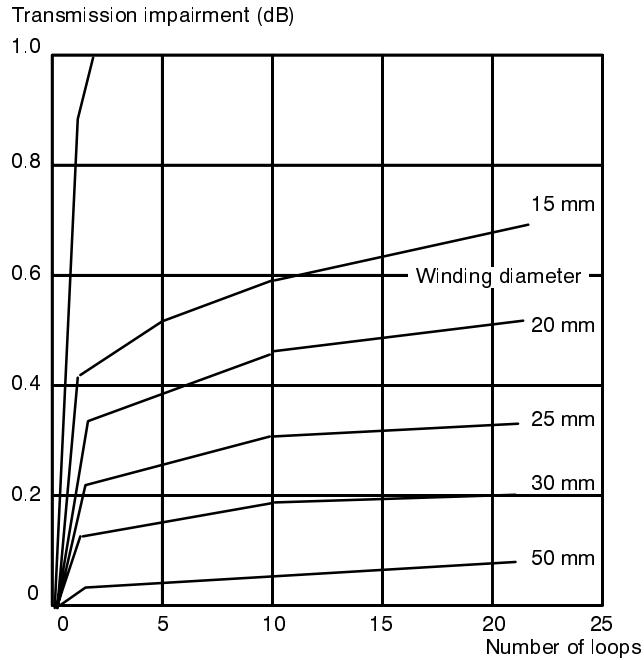

Prevent the ends of the Optical Connector from becoming soiled. Should this occur, clean them lightly with a cotton swab soaked in ethyl alcohol. Organic solvents other than ethyl alcohol should not be used.

When Optical Fiber Cable is used at less than the recommended operating temperature, the maximum transmission distance (without a Repeater) decreases.

3-3 Environmental Considerations

Care should be taken to avoid certain environmental conditions which are detrimental to Cable longevity. Avoid the following situations when installing Optical Fiber Cable:

- Extended exposure to direct sunlight (with the exception of indoor/outdoor-type Cable)
- Exposure to high temperatures (e.g., furnaces), sparks, or flames
- Continual contact with oil or harmful chemicals, or exposure to seawater
- Uneven external pressure (e.g., places where the Cable could be crushed, or inadvertently come into contact with sharp objects)

Resistance to Oil and Chemicals

Type of oil or chemical		Resistance	
		B500-OF002	OF001 to OF511
Ethylene oxide		Poor	Poor
Methanol		Poor	Excellent
Acetone		None	Excellent
Benzene		None	Good
Toluene		Poor	Good
Xylene		Poor	Good
Cyclohexanone		None	Poor
Phenol		Poor	Good
Gasoline		Good	Good
Transmission oil		Good	Good
Heavy oil		Good	Good
Ammonia liquid		Good	Good
Carbon disulfide		None	Excellent
Creosote		Poor	Good
Caustic soda		Good	Excellent
Coal tar		None	Good
Nitric acid	Conc.	Good	Poor
	5%	Good	Excellent
Sulfuric acid	Conc.	Good	Excellent
	5%	Good	Excellent
Acetic acid	30%	Poor	Good
Potassium carbonate solution		Poor	Excellent
Ethylene glycol		Good	Good
Hydrochloric acid	Conc.	Good	Excellent
	1%	Good	Excellent

Resistance to Environment

Environment		Resistance	
		B500-OF002, OF011 to OF511	B500-PF002
Sunlight	Ultraviolet	Excellent	Excellent
Salt damage	Corrosion	Excellent	Excellent
Chemicals	Inorganic chemicals	Excellent	Excellent
	Organic chemicals	Excellent	Good
	Gas	Poor	Poor
Oil		Good	Good
Flame	Flame	Poor	None
	Spreading fire	Poor	None
	Flammability	Self-extinguishing	Burns a little

Note Chemical resistance data is given at normal temperatures where the chemical concentration is 85% or greater, unless otherwise indicated.

B500-0F002 and B500-0F011 through 0F511 are encased in polyvinyl chloride (PVC). B500-PF002 is encased in polyethylene (PE).

3-4 Installation Methods

3-4-1 Installing Optical Fiber Cable in Conduit

When installing Optical Fiber Cable in conduit, use only unthreaded conduit a minimum of 250 mm in diameter.

For indoor Optical Fiber Cable, use a flexible messenger approximately 5 mm in diameter and 50 m in length. Indoor/outdoor Cable is more rigid; a narrow metal wire may be used instead. A thin application of Vaseline will reduce any friction encountered along the conduit. Avoid pulling or pushing the Cable backwards and keep the Cable taut, but do not exceed the tensile strength of the Cable used. When feeding a Cable longer than 10 m, deliver the Cable from the top side of a spooling device at the speed it is pulled.

Use a pull-box approximately every 20 m along the conduit route.

Conduit and Tubing Cable Exit

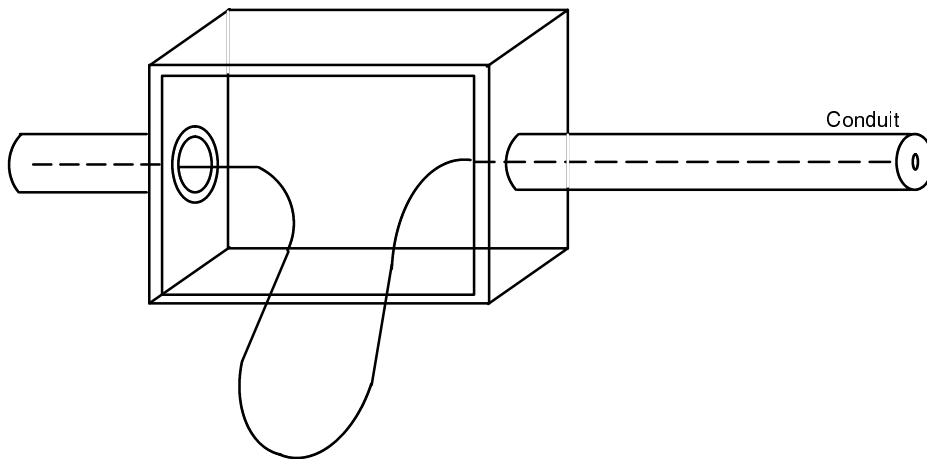

3-4-2 Aerial Installation

Aerial installation methods differ depending on the Cable used. Tensile as well as bending stress must be considered at each supporting point. For indoor Cable, provide a distance of approximately 5 m between supporting points. This distance may be lengthened if a bending radius of 100 mm or more is assured at each supporting point.

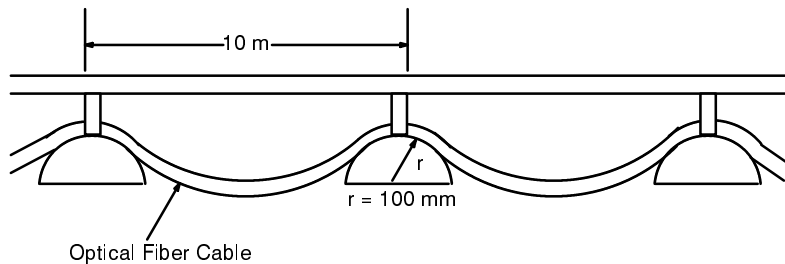

Since indoor/outdoor Cable is more rigid and larger in diameter, hang the Cable using a specially constructed 30-mm² pole and 25-mm supporting rings.

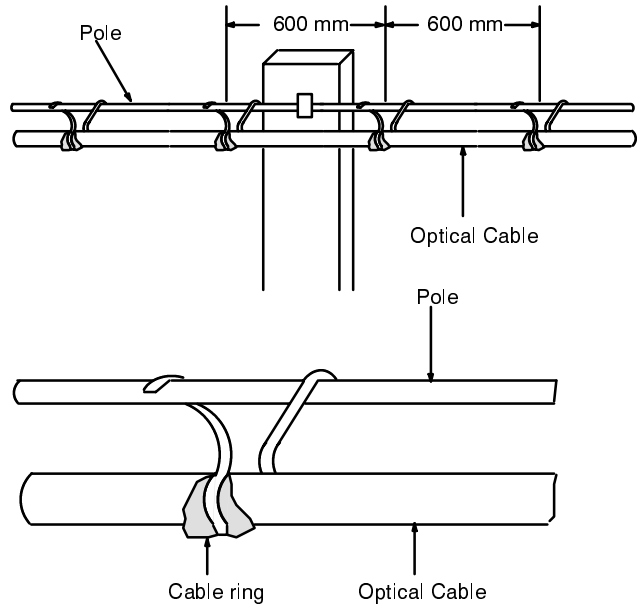

3-4-3 Fastening the Cable to Poles or Walls

When fastening the Cable to a pole, wrap the portion of the cable to be fastened with tape, and then secure it to the pole with band tape or vinyl binding string.

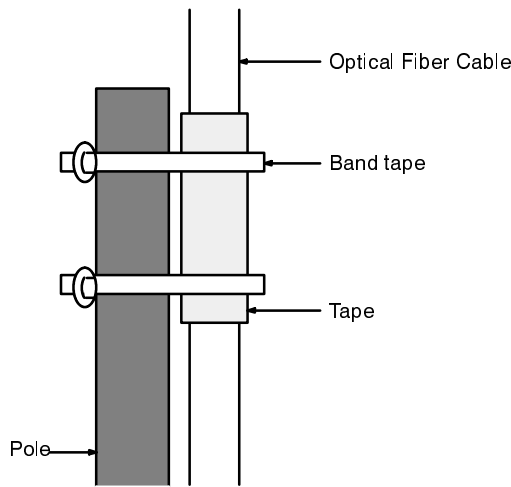

The tape used for wrapping should be vinyl insulating tape. The band tape should be a wide nylon variety.

If the Cable is to be wall-mounted, tape the Cable in a similar fashion as above, and secure it with a saddle or similar hardware.

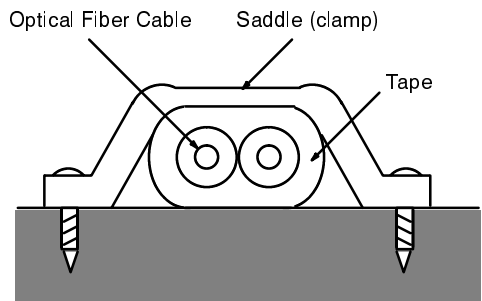

Appendix A Standard Models

Item	Available lengths	Operating temperature	Model number
Optical Fiber Cable (Indoor) PCF	0.1-m cable with connector attached	-10% to 70°C	3G5A2-OF011
	1-m cable with connector attached		3G5A2-OF101
	2-m cable with connector attached		3G5A2-OF201
	3-m cable with connector attached		3G5A2-OF301
	5-m cable with connector attached		3G5A2-OF501
	10-m cable with connector attached		3G5A2-OF111
	20-m cable with connector attached		3G5A2-OF211
	30-m cable with connector attached		3G5A2-OF311
	40-m cable with connector attached		3G5A2-OF411
	50-m cable with connector attached		3G5A2-OF511
Optical Fiber Cable (Indoor/outdoor) PCF	1-m to 500-m cable with connector attached (Order in increments of 1 m within the above limits.)	-10% to 70°C	3G5A2-OF002
	500-m to 800-m cable with connector attached (Order in increments of 10 m within the above limits.)	0% to 55°C If not exposed to direct sunlight.	
All Plastic Optical Fiber Cable APF	Cable only (no connector) 5 m to 100 m (Order in increments of 5 m within the above limits). Also available in lengths of 200 m and 500 m. The cable must be less than 20 m when used.	N/A	3G5A2-PF002
	Optical Connector A. For cable lengths between 10 cm and 10 m. 2 connectors included (brown).	N/A	3G5A2-CO001
	Optical Connector B. For cable lengths between 8 and 20 m. 2 connectors included (black).	N/A	3G5A2-CO001

Note

The Cable lengths in the previous table do not include the lengths of the attached Connectors, which add an additional 70 mm (2 x 35 mm) to the total length. Also, some additional length should be ordered as Optical Fiber Cable is not easily spliced.

H-PCF Optical Fiber Cords and Cables

Cable type	Cable color	Cable length	Model
With feeder	Black	10 meters	S3200-HCLB101
		50 meters	S3200-HCLB501
		100 meters	S3200-HCLB102
		500 meters	S3200-HCLB502
		1,000 meters	S3200-HCLB103
	Orange	10 meters	S3200-HCLO101
		50 meters	S3200-HCLO501
		100 meters	S3200-HCLO102
		500 meters	S3200-HCLO502
		1,000 meters	S3200-HCLO103
Without feeder	Black	10 m	S3200-HCCB101
		50 m	S3200-HCCB501
		100 m	S3200-HCCB102
		500 m	S3200-HCCB502
		1,000 m	S3200-HCCB103
	Orange	10 m	S3200-HCCO101
		50 m	S3200-HCCO501
		100 m	S3200-HCCO102
		500 m	S3200-HCCO502
		1,000 m	S3200-HCCO103
Without feeder or tension member (for FIT10)	Black	10 m	S3200-HCCB101N
		50 m	S3200-HCCB501N
		100 m	S3200-HCCB102N
		500 m	S3200-HCCB502N
Two-core optical cord	Black	10 m	S3200-HBCB101
		50 m	S3200-HBCB501
		100 m	S3200-HBCB102
		500 m	S3200-HBCB502
		1,000 m	S3200-HBCB103

Note

We will also continue to accept orders for conventional cable models S3200-FH-L-C22T and B500-OF__.

System Compatibility with Optical Cords/Cables

System	With feeder	Without feeder	Two-core cord
SYSMAC NET	Excellent	Good	Poor environmental resistance
SYSMAC BUS	Poor compatibility when laying cable	Outdoor	Indoor

Optical Power Tester Sets

Name	Model
SYSMAC NET Optical Characteristics Measurement Power Tester for NSB, NSU, and Bridges	S3200-CAT3200
SYSMAC NET Optical Characteristics Measurement Power Tester for C200H	S3200-CAT2000
SYSMAC BUS Optical Characteristics Measurement Power Tester	S3200-CAT2820

Head Sets (Light Source Unit and Connector Adaptor)

Name	Model
SYSMAC NET Optical Power Tester Head Set for NSB, NSU, and bridges	S3200-CAT3202
SYSMAC NET Optical Power Tester Head Set for C200H	S3200-CAT2002
SYSMAC BUS Optical Power Tester Head Set	S3200-CAT2822

Optical Connector Assembly Tool Sets

Application	Applicable connector	Model
Connection of SYSMAC NET node connectors	S3200-COCH62M S3200-COCF62M S3200-COCF62F	S3200-CAK62
Connection of SYSMAC NET C200H connectors	S3200-COCF2511	S3200-CAK1010

Note

An Optical Connector Assembly Tool Set does not contain tools for SYSMAC BUS Remote I/O Systems. In addition, one of two conventional assembly tool sets and the Optical Fiber Cutter are required. If this product is being purchased for the first time, the S3200-CAK1010 is recommended. This is because the C-series SYSMAC LINK System (optical) and the CV-series Communication Bus (optical) are compatible with the S3200-CAK1010.

Optical Fiber Cutters

Name	Model
SYSMAC NET Optical Fiber Cutter for NSB, NSU, and Bridges	S3200-FC4511
SYSMAC NET Optical Fiber Cutter for C200H	S3200-FC7155
SYSMAC BUS Optical Fiber Cutter	S3200-FC8211*

*An accessory for the Optical Connector Assembly Tool and not included with this tool.

Master Fiber Sets

Name	Model
SYSMAC NET Optical Power Tester Master Fiber for NSB, NSU, and Bridges	S3200-CAT3201
SYSMAC NET Optical Power Tester Master Fiber for C200H	S3200-CAT2001H
SYSMAC BUS Optical Power Tester Master Fiber	S3200-CAT2821

Optical Connectors

Name	Model
SYSMAC NET node connector	S3200-COCH62M
SYSMAC NET (conventional type) node and relay (M) connector	S3200-COCF62M
SYSMAC NET relay (F) connector (must be paired to relay (M) connector)	S3200-COCF62F
SYSMAC NET C200H connector	S3200-COCF2511
SYSMAC BUS connector	S3200-COCH82

Placement of Node and Relay Connectors

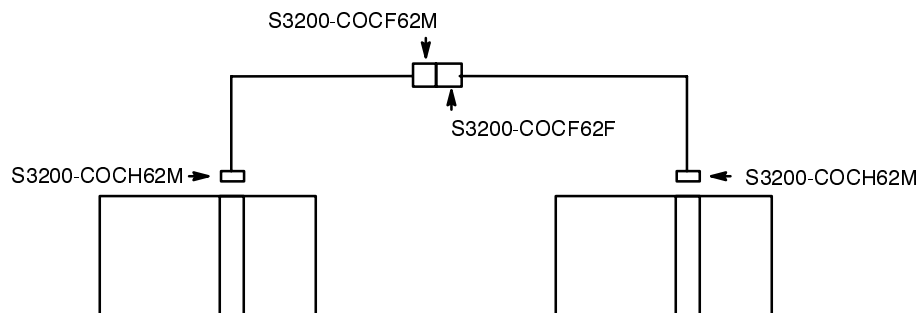

Optical Connector Compatible with Units

Connector	Unit
SYSMAC NET node connector S3200-COCH62M	NSU, NSB, FX-9200, FC-985, C500 SYSMAC NET Link Unit
SYSMAC NET C200H connector S3200-COCF2511	C200H-SNT31 only
SYSMAC BUS connector S3200-COCH82	All Optical Remote I/O Master/Slave Units, all Optical Host Link Units, Link Adaptors

Items Required for Assembly and Measurement of H-PCF

The following table is designed to tell what assembly and measurement tools are required to lay and maintain H-PCF cable and cord depending on the Systems desired. "Yes" indicates that you need assembly and measurement tools for that System. "Have" indicates that you already have the tools for that system and the column show the tools need to added the ability to support another System.

If "1" and "2" are listed under a column for certain products, either the "1" models or the "2" models will suffice. (For example the S3200-CAK62 can be used with the S3200-FC7155 or the S3200-CAK1010 can be used with the S3200-FC4511.)

If a box is left blank, either that tool is not required or that model of tool cannot be used.

System(s) to be installed/maintained	SYSMAC NET with C200H	Yes			Yes		Have	Have	Yes (add)	
	SYSMAC NET without C200H		Yes			Yes	Yes (add)		Have	Have
	SYSMAC BUS			Yes	Yes	Yes		Yes (add)		Yes (add)
Cord/Cable	Select from the Optical Fiber (H-PCF) Cable Model List in Appendix A									
Connector	S3200-COCH62M	Need	Need		Need	Need	Need		Need	
	S3200-COCF2511	Need			Need				Need	
	S3200-COCH82			Need	Need	Need		Need		Need
Assembly Tool	S3200-CAK62	1	Need		1	Need				
	S3200-CAK1010	2		Need	2					
Fiber Cutter	S3200-FC4511	2			2					
	S3200-FC7155	1			1				Need	
	S3200-FC8211			Need	Need	Need		Need		Need
Power Tester	S3200-CAT3200	1	Need		1	Need				
	S3200-CAT2000	2			2					
	S3200-CAT2820			Need						
Head Set	S3200-CAT3202	2			2					
	S3200-CAT2002	1			1				Need	
	S3200-CAT2822				Need	Need		Need		Need
Master Fiber	S3200-CAT3201	Need	Need		Need	Need				
	S3200-CAT2001H	Need			Need				Need	
	S3200-CAT2821			Need	Need	Need		Need		Need

Optical Fiber Tester Set: S3200-CAT3200

Item	Main unit	Connector adapter	Light Source (Note 1)	AC adapter
Quantity	1	1 pair (to transmit/receive)	1	1
Remarks	---	Applicable Optical Connector CH-62-M (Note 2)	---	---

Batteries and housing are included as accessories.

This set is the same as the CAT-3200 (from Sumitomo)

- Note**
1. Be sure to use the specified Light Source. If another light source which has a similar nominal wavelength is used, the nominal value may significantly differ from the actual value.
 2. This assumes the optical connector is directly engaged using the press and cut method. If the Master Fiber for measurement—described in the following section—is also used, all the fibers with connectors for the CH-62-M and CF-62-M/F can be measured.

Master Fiber Set for Measurement: S3200-CAT3201

Component	Model	Quantity
CH42-MM-1 Master Fiber	DCV-HC-20/07	3
Joint Housing	IAT-42	2
Sleeve (spare)	Sleeve M-FF	2
Case	---	1

This set is the same as the CAT-3201 (from Sumitomo).

Components of Optical Connector Assembly Tool Set: S3200-CAK62

Number	Name	Model	Quantity
1	Ferrule application tool	VJM7209	1
2	Cutter knife	VJM7211	1
3	Scissors	VJM7235	1
4	Nipper	VJM7212	1
5	Optical fiber cutter	FC-4511	1
6	Holder A	VJM7213	1
7	Holder B	VJM7214	1
8	Holder C	VJM7215	1
9	Optical fiber stripper	VJM7070	1
10	Scale	VJM7105	1
11	Case	VJM7227	1
12	Instruction manual	---	1

Components other than number 5 are the same as those for the conventional assembly tool for PCF.

This model is the same as the CAK-62 (from Sumitomo).

Appendix B Specifications

Indoor Optical Fiber Cable (PCF)

Materials	Core material: SiO ₂ , other Cladding: Silicon resin, other
Communication mode	Multi-mode step type
Core diameter	50 to 80 mm
Advantages	Easy to use; Core diameter easily enlarged.
Disadvantages	Unstable
Application	Medium distance transmission
Weight	16.3 kg/km
Tensile strength*	Optical connector/cable: 5 kg Cable: 25 kg
Minimum bending radius	15 mm
Cable length (L)	0.17 to 50 m
Ambient temperature	Operating: -10% to 70°C Storage: -20% to 70°C

Indoor/Outdoor Optical Fiber Cable (PCF)

Weight	103 kg/km
Tensile strength*	Optical connector/cable: 5 kg Cable: 150 kg
Minimum bending radius	25 mm
Cable length (L)	10 to 800 m
Ambient temperature	Operating: -10% to 70°C (to 500 m); 0% to 55°C (510 to 800 m) Storage: -20% to 70°C (to 500 m); -20% to 55°C (510 to 800 m)

Plastic Optical Fiber Cable (With Connector Attached) (APF)

Materials	Acrylic resin , Fluorine compounds
Communication mode	Multi-mode step type
Core diameter	500 to 2,000 mm
Advantages	Easy to use; Large core diameter .
Disadvantages	High loss; Unstable.
Application	Short-distance transmission
Weight	7.8 kg/km
Tensile strength*	Optical connector/cable: 5 kg Cable: 25 kg
Minimum bending radius	15 mm (absolute minimum during installation); 25 mm (actual use)
Cable length (L)	10 cm to 20 m (User can assemble cable to desired length)
Ambient temperature	Operating: -10% to 70°C Storage: -20% to 70°C

*These values refer to the allowable tensile force during installation. Tensile force must be relieved after installation.

**Drum-spoiled Cable should be stored at less than 45°C.

Storage

Store unused Cable above ground in a large loops approximately 10 times its external diameter and place it safely in an area where the ambient temperature is between -20% and $70\%C$. An area where a constant temperature can be maintained is preferable.

Tester

A/D Conversion	Drift-compensated dual slope integration type
Measurement period	Approx. 2 measurements per sec.
Display	Type 3 1/2 digit LCD (maximum display value: 1999) Polarity Automatic(-) for negative values only Overflow display OL Indicator
Analog signal output	1 mVDC/count (maximum 1.999 mV)
Operating temperature	0% to 40% C (80% or less, no condensation)
Storage temperature	-20% to 60% C (70% or less, no condensation)
Power supply	Four AA batteries or AC Adapter (Model DP-1005)
Power consumption	Approx. 36 mW (with LED off)
Battery life	LED off: Approx. 120 hr LED on: Approx. 20 hr
Battery low alarm	When the battery voltage drops below the minimum operating voltage, BL mark appears in the display.
Outer dimensions	90 x 165 x 40 (WxHxD)
Weight	Approx. 450 g (including batteries)
Accessories	Hard carrying case 1 piece 180-TC (TC connector adapter) 2 pieces Analog signal output plug 1 piece AA batteries 4 pieces Instruction manual 1 piece

Appendix C

Ordering Information

Indoor Plastic Optical Fiber Cable

Plastic Optical Fiber Cable and Optical Connectors are sold as separate components and must be user-assembled. Place orders only after determining the Cable length, type of Connector, and number of pieces needed.

Plastic Optical Fiber Cable and Optical Connectors

Name	Specifications	Model number
Plastic Optical Fiber Cable	Cable only (connector excluded). Order in 5 m increments ranging from 5 to 100 m, or in 200 or 500 m lengths. (See note below.)	3G5A2-PF002
Optical Connector A	Brown; two pieces. (10 cm to 10 m cable)	3G5A2-CO001
Optical Connector B	Black; two pieces. (8 to 20 m cable)	3G5A2-CO002
Plastic Optical Fiber Set	One-meter cable with connector A attached at both ends	3G5A2-PF101

Note Add an additional 70 mm to Cable length for Connectors (approx. 35 mm ea.) attached to either end.

Cable Length and Connector

The following example below illustrates proper component selection for the system described.

Cable length: 20 m + 15 m + (5 m x 5 pieces) = 60 m + approx. 10 % of the total length.

Connector A: 5 sets (10 pieces) + spare (used for 5-m Cable)

Connector B: 2 sets (4 pieces) + spare (used for 15-m and 20-m Cable.)

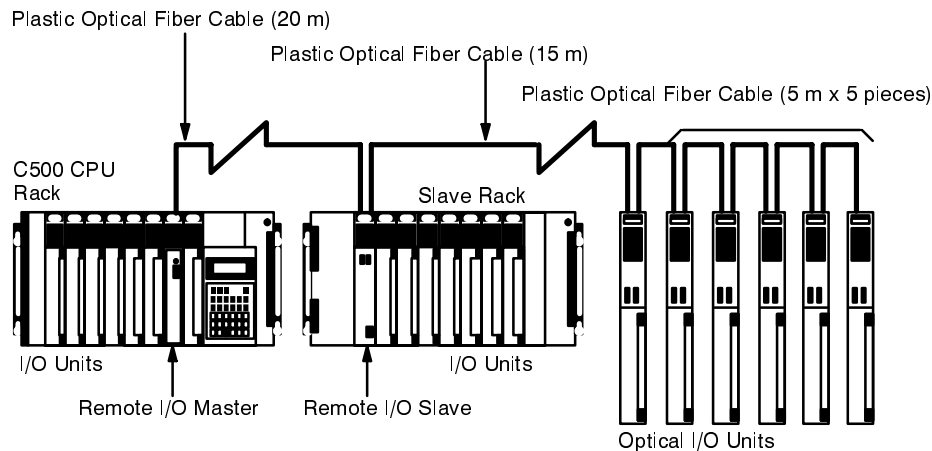

Indoor/Outdoor PCF Optical Fiber Cable

PCs with -P at the end of the model number are to be used for cable lengths under 200 m; those without -P in the model number may be used for cable lengths up to 800 m.

Note The Cable lengths in the previous table do not include the lengths of the attached Connectors, which add an additional 70 mm (2 x 35 mm) to the total length. Also, some additional length should be ordered as Optical Fiber Cable is not easily spliced.

Indoor/Outdoor Optical Fiber Cable

Use indoor Optical Fiber Cable only for lengths under 50 m. For lengths exceeding 50 m, for installation in conduits where the Cable must be pulled, or where external protection is needed, use indoor/outdoor Cable with plastic cladding.

Since indoor/outdoor Cable is not a standard stock item, order well in advance. The minimum order for indoor/outdoor Optical Fiber Cable is 50 m. When ordering, specify the model number and Cable length.

Glossary

central strength member	A steel wire running through an optical fiber cable. It is used to give the cable longitudinal strength.
ferrule	A short tube which is attached to the end of an optical fiber and is part of the optical fiber connector.
pull box	A device which is used to pull optical fiber cable through conduit.
dBm	A unit for expressing power level in decibels, relative to a reference level of one milliwatt.
PVC	Polyvinyl chloride. The outer layer or sheath on the optical fiber cable.

Index

A

assembly, 7

C

cladding, 3, 4
coil diameter, 12
conduit, 15
connectors, 5
core, 3, 4

F

ferrule, 4, 5

G

grip,cable, 12

I

impairment, transmission, 12

J

jacket, 3

N

nippers, 9

P

pipe, 12
polarity, 8

S

solvents, 13
spiral coil, 13

T

tensile force, 12

W

wall, 16

Revision History

A manual revision code appears as a suffix to the catalog number on the front cover of the manual.

Cat. No. W152-E1-3

↑
Revision code

The following table outlines the changes made to the manual during each revision. Page numbers refer to previous version.

Revision code	Date	Revised content
1	February 1989	Original production
2	July 1989	Redundancies removed, and general cleaning of text and graphics.
3	October 1990	Added information on APF, PCF and H-PCF. Put in new template. Some corrections.