



CJ Series
General-purpose Serial
Connection Guide
(RS-232C)

OMRON Corporation
V400-R2 Series
Ultra Small Multi-code Reader

About Intellectual Property Rights and Trademarks

Microsoft product screen shots reprinted with permission from Microsoft Corporation.
Windows is a registered trademark of Microsoft Corporation in the USA and other countries.
Company names and product names in this document are the trademarks or registered trademarks of their respective companies.

Table of Contents

1. Related Manuals	1
2. Terms and Definitions	2
3. Precautions	3
4. Overview	5
5. Applicable Devices and Device Configuration	6
5.1. Applicable Devices	6
5.2. Device Configuration	7
6. Serial Communications Settings	9
6.1. Serial Communications Settings	9
6.2. Cable Wiring Diagram	10
6.3. Example of Connection Check	12
7. Connection Procedure	13
7.1. Work Flow	13
7.2. Setting UP the Code Reader	14
7.3. Setting Up the PLC	15
7.4. Checking the Serial Communications	34
8. Initialization Method	42
8.1. Initializing the PLC	42
8.2. Initializing the Code Reader	43
9. Program	44
9.1. Overview	44
9.2. Communications Sequence	48
9.3. Error Detection Processing	49
9.4. Memory Maps	50
9.5. Ladder Program	53
9.6. Protocol Macro Data	59
9.7. Timing Charts	66
9.8. Error Processing	67
10. Revision History	68

1. Related Manuals

The table below lists the manuals related to this document.

To ensure system safety, make sure to always read and heed the information provided in all Safety Precautions, Precautions for Safe Use, and Precaution for Correct Use of manuals for each device which is used in the system.

Man.No.	Model	Manual name
W472	CJ2H-CPU6[]-EIP CJ2H-CPU6[] CJ2M-CPU[][]	CJ-series CJ2 CPU Unit Hardware User's Manual
W473	CJ2H-CPU6[]-EIP CJ2H-CPU6[] CJ2M-CPU[][]	CJ-series CJ2 CPU Unit Software User's Manual
W336	CJ1W-SCU[]1-V1 CJ1W-SCU[]2	CJ-series Serial Communications Boards and Serial Communications Units Operation Manual
W446	-	CX-Programmer Operation Manual
W344	-	CX-Protocol Operation Manual
W474	CJ2[]-CPU[][]	CJ Series Instructions Reference Manual
Z333	V400-R2 Series	Ultra Small Multi-code Reader V400-R2 Series User's Manual

2. Terms and Definitions

Term	Explanation and Definition
Protocol macro	A protocol macro is a function that stores a data send/receive procedure (protocols) in a Serial Communications Board or Serial Communications Unit to exchange data with general-purpose external devices by executing the PMCR instruction on the CPU Unit.
Protocol	A unit of independent communication processing with a specific general-purpose device. A protocol includes a data send/receive procedure. A protocol consists of multiple sequences.
Sequence	A unit of the independent communication processing which can be started by executing the PMCR instruction of a ladder program. A sequence that is started will execute steps registered in its own sequence.
Step	A unit to execute any one of the followings: message send processing, message receive processing, message send/receive processing, clear receive buffer, or step wait. Up to 15 steps can be set per sequence.
Send message	A communication frame (command) sent to the external general-purpose device. A send message is read from the step in the sequence, and sent to the external general-purpose device.
Receive message	A communication frame (response) sent from the external general-purpose device. A receive message is read from the step in the sequence and is compared with data received from the general-purpose external device.
Matrix	A matrix is used when a general-purpose external device sends multiple types of communications frames (responses). More than one communication frame can be registered in one matrix.
Case	A unit to register multiple communication frames (response) to a matrix. One communication frame is registered as one case. Up to 15 types of cases can be registered per matrix.

3. Precautions

- (1) Understand the specifications of devices which are used in the system. Allow some margin for ratings and performance. Provide safety measures, such as installing safety circuit in order to ensure safety and minimize risks of abnormal occurrence.
- (2) To ensure system safety, always read and heed the information provided in all Safety Precautions, Precautions for Safe Use, and Precaution for Correct Use of manuals for each device used in the system.
- (3) The user is encouraged to confirm the standards and regulations that the system must conform to.
- (4) It is prohibited to copy, to reproduce, and to distribute a part or the whole of this document without the permission of OMRON Corporation.
- (5) The information contained in this document is current as of September 2013. It is subject to change without notice for improvement.

The following notations are used in this document.



WARNING

Indicates a potentially hazardous situation which, if not avoided, will result in minor or moderate injury, or may result in serious injury or death. Additionally there may be significant property damage.



Caution

Indicates a potentially hazardous situation which, if not avoided, may result in minor or moderate injury or property damage.



Precautions for Safe Use

Precautions on what to do and what not to do to ensure safe usage of the product.



Precautions for Correct Use

Precautions on what to do and what not to do to ensure proper operation and performance.



Additional Information

Additional information to read as required.

This information is provided to increase understanding or make operation easier.

Symbol



The triangle symbol indicates precautions (including warnings).
The specific operation is shown in the triangle and explained in text.
This example indicates a general precaution.



The filled circle symbol indicates operations that you must do.
The specific operation is shown in the circle and explained in text.
This example shows a general precaution for something that you must do.

4. Overview

This document describes the procedure for connecting OMRON Corporation's Ultra Small Multi-code Reader (V400-R2 series) (hereinafter referred to as the Code Reader) with CJ-series Programmable Controller (hereinafter referred to as the PLC) via serial communications, and describes the procedure for checking their connection.

Refer to the serial communications settings described in 6. *Serial Communications Settings* and 7. *Connection Procedure* to understand the setting method and key points to connect the devices via serial communications.

The user program in the prepared CX-Programmer project file and the protocol macro data in the CX-Protocol project file are used to check the serial connection by executing the "Reading Trigger" command on the Code Reader.

Prepare the latest CX-Programmer project file and the CX-Protocol project file beforehand. To obtain the files, contact your OMRON representative.

Name	File name	Version
CX-Programmer project file (extension: cxp)	OMRON_V400-R2_PMCR232C_EV100.cxp	Ver.1.00
CX-Protocol project file (extension: psw)	OMRON_V400-R2_PMCR_EV100.psw	Ver.1.00

* Hereinafter, the CX-Programmer project file is referred to as the "project file".

The user program in the project file is referred to as the "ladder program" or "program".

The CX-Protocol project file is called the "Protocol macro data".

Caution

This document aims to explain the wiring method and communications settings necessary to connect the corresponding devices and provide the setting procedure. The program used in this document is designed to check if the connection was properly established, and is not designed to be constantly used at a site. Therefore, functionality and performances are not sufficiently taken into consideration. When you construct an actual system, please use the wiring method, communications settings and setting procedure described in this document as a reference and design a new program according to your application needs.



5. Applicable Devices and Device Configuration

5.1. Applicable Devices

The applicable devices are as follows:

Manufacturer	Name	Model
OMRON	CJ2 CPU Unit	CJ2[]-CPU[]
OMRON	Serial Communications Unit	CJ1W-SCU[]1-V1 CJ1W-SCU[]2
OMRON	Ultra Small Multi-code Reader	V400-R2CF[]



Precautions for Correct Use

As applicable devices above, the devices with the models and versions listed in Section 5.2. are actually used in this document to describe the procedure for connecting devices and checking the connection.

You cannot use devices with versions lower than the versions listed in Section 5.2.

To use the above devices with versions not listed in Section 5.2 or versions higher than those listed in Section 5.2, check the differences in the specifications by referring to the manuals before operating the devices.



Additional Information

This document describes the procedure to establish the network connection. Except for the connection procedure, it does not provide information on operation, installation or wiring method. It also does not describe the functionality or operation of the devices. Refer to the manuals or contact your OMRON representative.

5.2. Device Configuration

The hardware components to reproduce the connection procedure of this document are as follows:

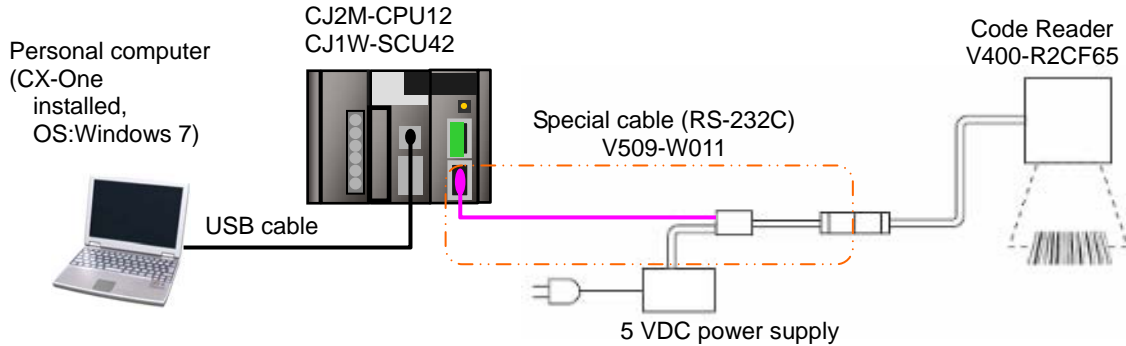

Manufacturer	Name	Model	Version
OMRON	Serial Communications Unit	CJ1W-SCU42	Ver.2.0
OMRON	CPU Unit	CJ2M-CPU12	Ver.2.0
OMRON	Power Supply Unit	CJ1W-PA202	
OMRON	CX-One	CXONE-AL[]C-V4 /AL[]D-V4	Ver.4.[]
OMRON	CX-Programmer	(Included in CX-One.)	Ver.9.43
OMRON	CX-Protocol	(Included in CX-One.)	Ver.1.97
OMRON	CX-Programmer project file (ladder program)	OMRON_V400-R2_PMC R232C_EV100.cxp	Ver.1.00
OMRON	CX-Protocol project file (Protocol macro data)	OMRON_V400-R2_PMC R_EV100.psw	Ver.1.00
-	Personal computer (OS: Windows7)	-	
-	USB cable (USB 2.0 type B connector)	-	
OMRON	Ultra Small Multi-code Reader	V400-R2CF65	
OMRON	Special cable (RS-232C)	V509-W011	
-	5 VDC power supply	-	



Precautions for Correct Use

Prepare the latest project file and protocol macro data in advance.
To obtain the files, contact your OMRON representative.



Precautions for Correct Use

Update the CX-Programmer and CX-Protocol to the versions specified in this section or higher versions using the auto update function. If a version not specified in this section is used, the procedures described in Section 7 and subsequent sections may not be applicable. In that case, use the equivalent procedures described in the *CX-Programmer Operation Manual* (Cat. No. W446) and the *CX-Protocol Operation Manual* (Cat. No. W344).



Additional Information

It may not be possible to reproduce the same operation with different devices or versions. Check the configuration, model and version. If they are different from your configuration, contact your OMRON representative.



Additional Information

For information on the special cable (V509-W011), refer to *Cable for programmable controller connection made by OMRON (V509-W011)* in *Specifications and External Dimension* in *Section 5 Appendix* of the *Ultra Small Multi-code Reader V400-R2 Series User's Manual* (Cat. No. Z333).



Additional Information

The system configuration in this document uses USB for the connection to the PLC. For information on how to install the USB driver, refer to *A-5 Installing the USB Driver* of the *CJ-series CJ2 CPU Unit Hardware User's Manual* (Cat. No. W472)

6. Serial Communications Settings

This section describes the specifications such as communication parameters and wiring that are set in this document.



Additional Information

To perform communications without using the settings described in this section, you need to modify the program. For information on the program, refer to *Section 9. Program*.

6.1. Serial Communications Settings

The serial communications settings are shown below.

Setting item	Serial Communications Unit	Code Reader
Unit number	0	-
Communications (connection) port	Port 2 (RS-232C)	-
Serial communications mode	Protocol macro	-
Data length	8 bits	8 bits (Default)
Stop bit	1 bit	1 bit (Default)
Parity	None	None (Default)
Transmission rate (Baud rate)	9,600 bps (Default)	9,600 bps (Default)
Protocol macro transmissions	Full-duplex	-
Header	-	None (Default)
Footer	-	<CR> (Default)
Number of digit output	-	None (Default)
RS/CS control	-	None (no protocol system) (Default)
CS waiting time	-	Not limited (Default)
ACK/NAK waiting time	-	Not limited (Default)



Precautions for Correct Use

This document describes the setting procedure of the CJ1W-SCU42 Serial Communications Unit with unit number 0 and communications (connection) port 2. To connect devices under different conditions, change the control word of the CIO area and the PMCR instruction used in the program. Refer to *Section 9. Program* for details.

6.2. Cable Wiring Diagram

Refer to *Section 3. Installation and Wiring of the CJ Series Serial Communications Boards, Serial Communications Units Operation Manual* (Cat. No. 336) for details on cable wiring.

Check the connector configuration and pin assignment before wiring.

You do not need to make a cable when you use the special cable (V509-W011).

■ Connector configuration and pin assignment

<CJ1W-SCU42> Applicable connector: D-sub 9 pin

Pin	Abbreviation	Signal name	I/O
1	FG	Shield	---
2	SD	Send data	Output
3	RD	Receive data	Input
4	RTS (RS)	Request to send	Output
5	CTS (CS)	Clear to send	Input
6	5V	Power supply	---
7	DSR (DR)	Data set ready	Input
8	DTR (ER)	Data terminal ready	Output
9	SG	Signal ground	---
Hood	FG	Shield	---

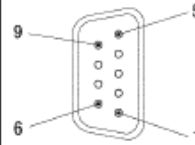

<V400-R2CF65> Applicable connector: DIN 8 pin

Pin No.	Signal name	Function
1	SD	Transmission data
2	RD	Received data
3	RS	Transmission request
4	CS	Transmission allowed
5	TRIG	External trigger signal
6	NC	Not connected
7	S.GND	0 V
8	VCC	Power supply

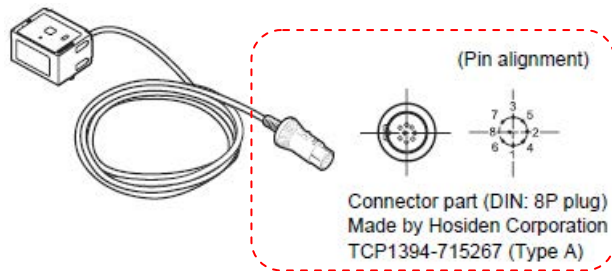

■ Cable/Pin assignment

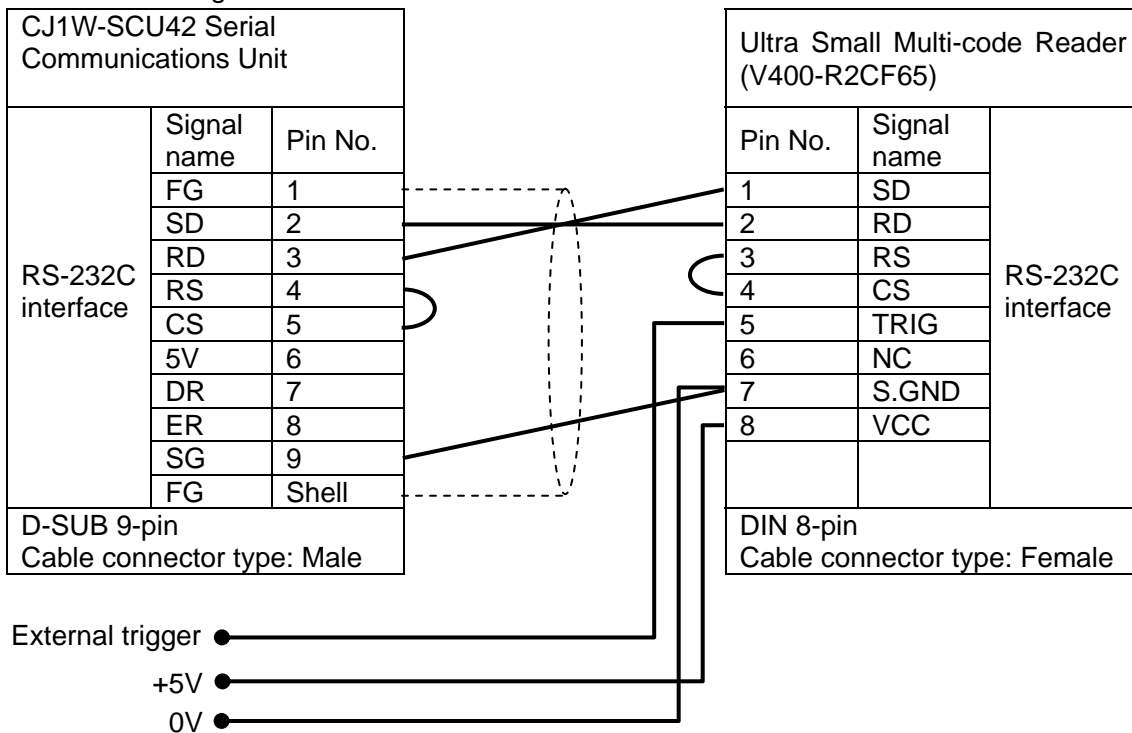

*The external trigger is not used in this document. Insulate it from other cables.
 *Connect +5V and 0V to the external power supply.

■ Recommended parts for the connector

When you make a connection cable, use the following connectors to connect it to the connector of the Code Reader.

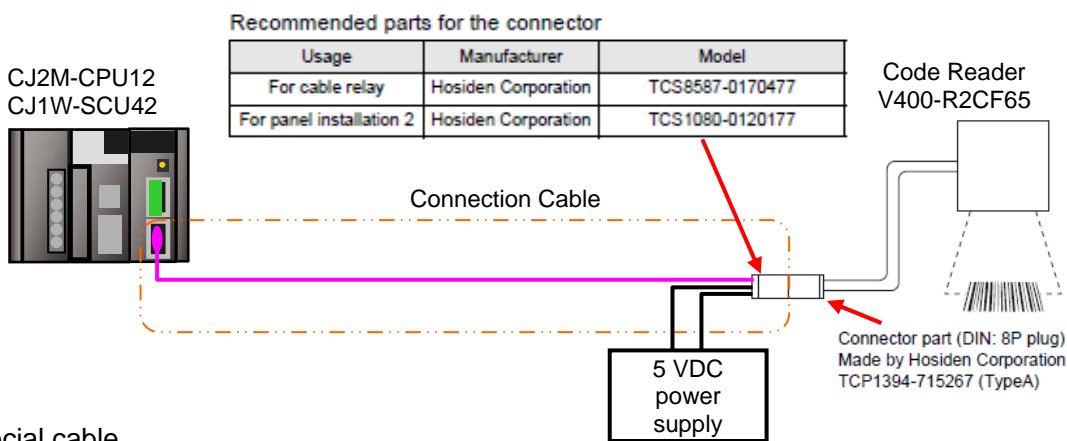

■ Special cable

The special cable (V509-W011) is used in this document.

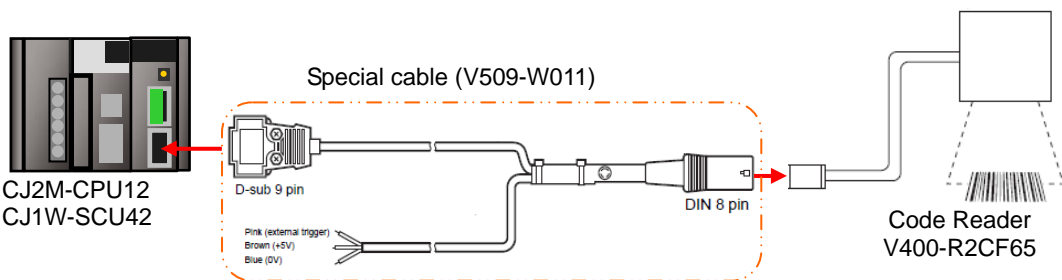

*The external trigger is not used in this document. Insulate it from other cables.
 *Connect +5V and 0V to the external power supply.

6.3. Example of Connection Check

This document uses an example of the ladder program and protocol macro data in which the PLC sends/receives a message to/from the Code Reader.

The PLC and the Code Reader send and receive the message of "Reading Trigger (sequence No. 900)". The following figure outlines the sequence operation.

- Overview of sequence operation

- (1) The ladder program executes the protocol macro instruction (PMCR instruction) for which sequence No. 900 of protocol macro data is specified
- (2) The Reading Trigger command (sequence No. 900) is selected from the protocol macro data, and it is sent to the Code Reader
- (3) The Code Reader executes the command according to the send data from the PLC
- (4) The PLC receives the result of the command executed by the Code Reader, and then stores in the specified address

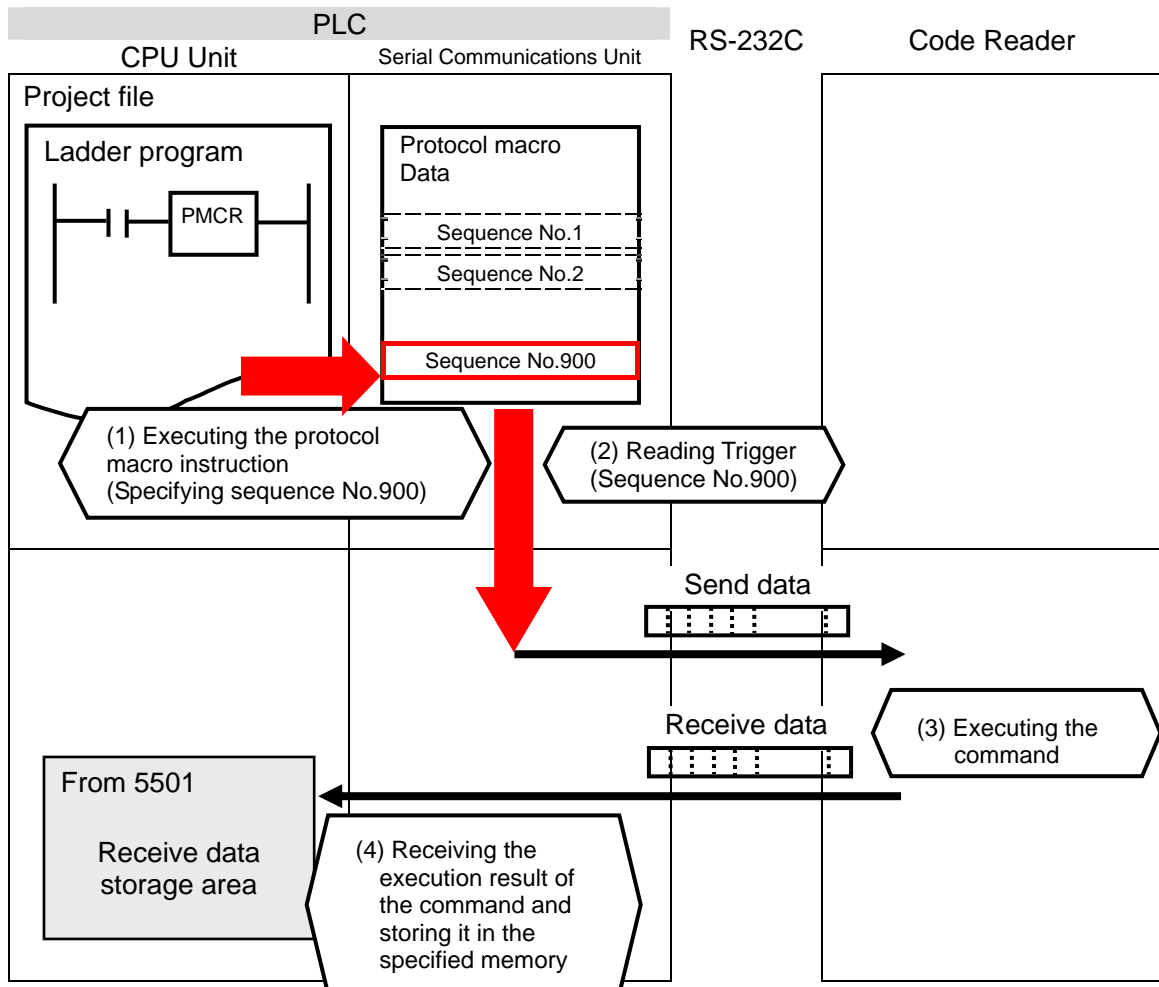

7. Connection Procedure

This section describes the procedure for connecting the Code Reader to the PLC via serial communications.

This document explains the procedures for setting up the PLC and the Code Reader from the factory default setting. For the initialization, refer to *Section 8 Initialization Method*.

7.1. Work Flow

Take the following steps to connect the Code Reader to the PLC via serial communications.

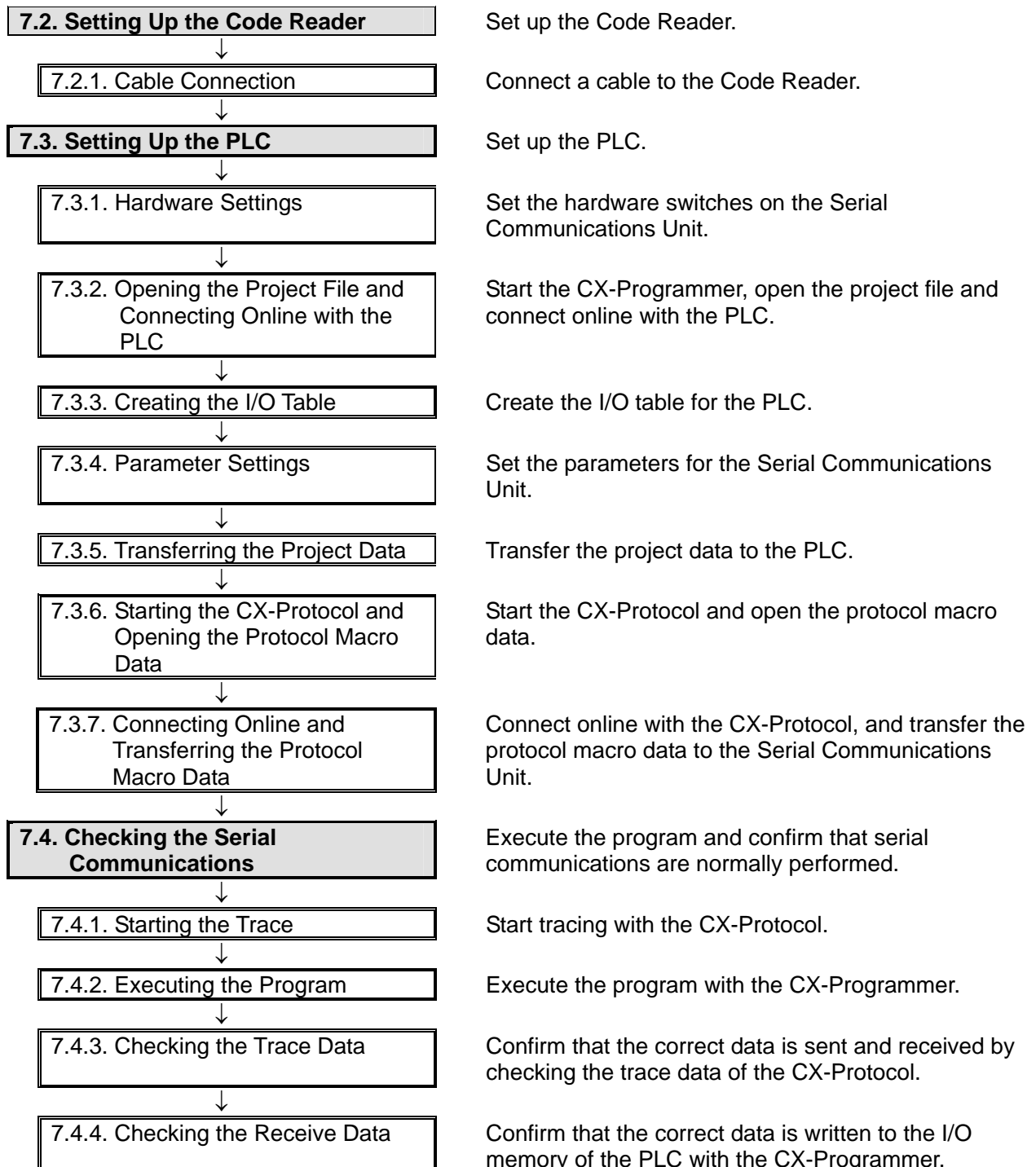

7.2. Setting UP the Code Reader

Set up the Code Reader.

7.2.1. Cable Connection

Connect a cable to the Code Reader.

- 1 Connect the special cable (V509-W011) to the Code Reader. Connect the 5 VDC power supply to the special cable and turn ON the power supply.

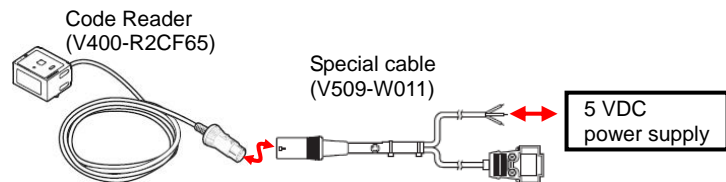

Precautions for Correct Use

This document explains the procedures for setting up the Code Reader from the factory default setting. If the Code Reader was changed from the factory default setting, make sure to initialize by referring to *Section 8.2. Initializing the Code Reader*.



Additional Information

For details on the factory default setting of the Code Reader, refer to *Factory default setting in Return to the factory default setting in Menu Sheet/Command List in Section 4 Setting Method of the Ultra Small Multi-code Reader V400-R2 Series User's Manual (Cat. No. Z333)*.

7.3. Setting Up the PLC

Set up the PLC.

7.3.1. Hardware Settings

Set the hardware switches on the Serial Communications Unit.



Precautions for Correct Use

Make sure that the power supply is OFF when you perform the setting up.

- 1 Make sure that the power supply to the PLC is OFF.

* If the power supply is turned ON, settings may not be applicable as described in the following procedure.

Check the hardware switches located on the front panel of the Serial Communications Unit by referring to the right figure.

Check the connector for Port 2 (RS-232C) by referring to the right figure.

* This setting is required to use Port 2 of the Serial Communications Unit.

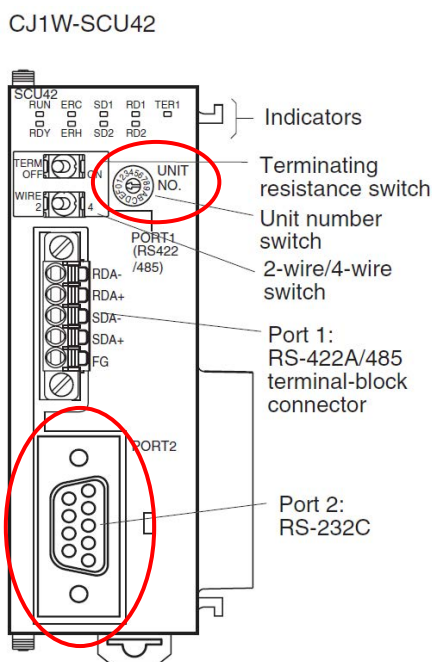

- 2 Set the Unit No. Switch to 0. (The unit number is set to 0 as the factory default setting.)



- 3 Connect the Serial Communications Unit to the PLC as shown on the right. Connect the special cable for the Code Reader to the Serial Communications Unit. Connect the personal computer to the PLC with a USB cable.

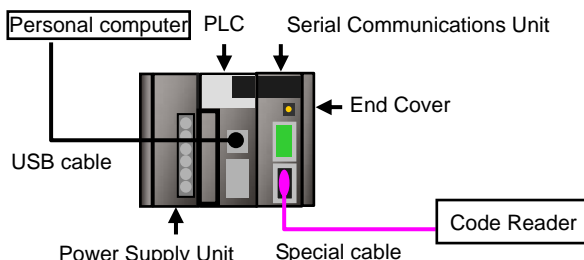

7.3.2. Opening the Project File and Connecting Online with the PLC

Start the CX-Programmer, open the project file and connect online with the PLC.
 Install the CX-Programmer and USB driver in the personal computer beforehand.

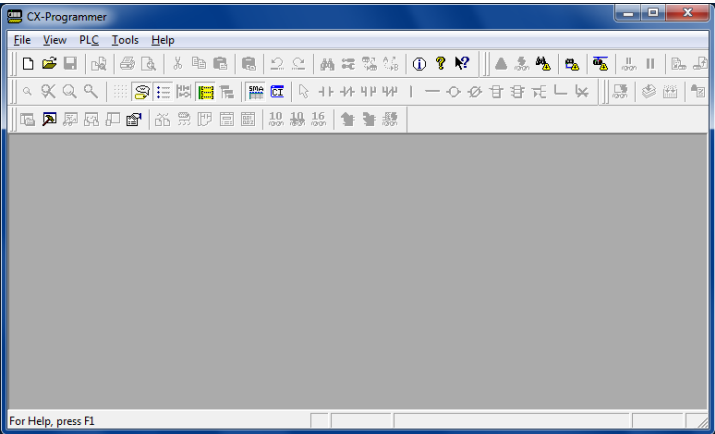
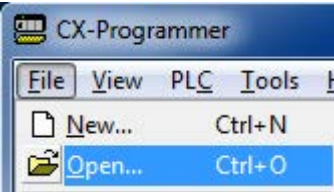
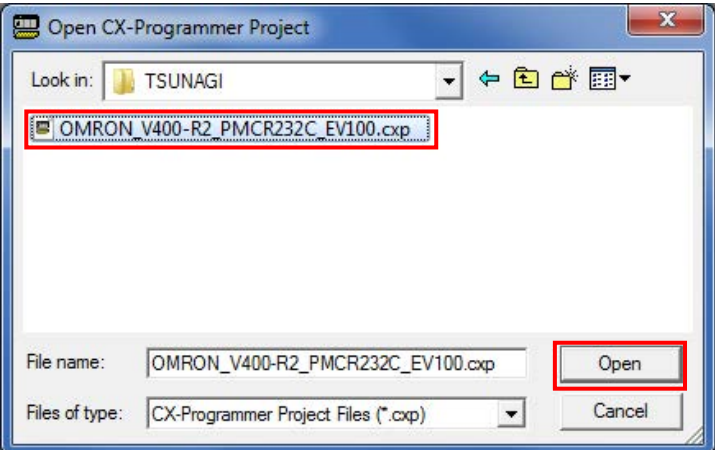
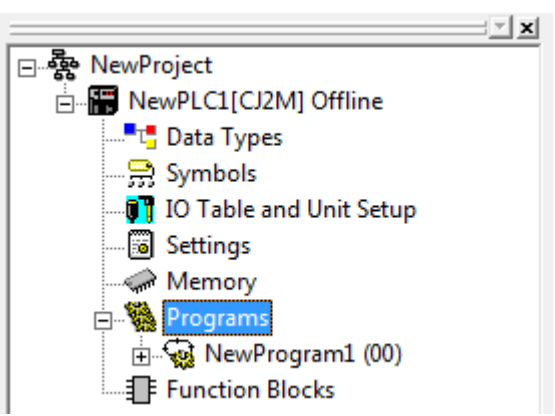
- | | |
|--|---|
| <p>1 Confirm that the personal computer and PLC are connected with the USB cable and turn ON the power supply to the PLC.</p> <p>Start the CX-Programmer.</p> <p>* If a confirmation dialog for an access right is displayed at start, select to start.</p> |  |
| <p>2 Select Open from the File Menu.</p> |  |
| <p>3 On the Open CX-Programmer Project Dialog Box, select OMRON_V400-R2_PMCR232C_EV100.cxp and click the Open Button.</p> <p>* Obtain the project file from OMRON.</p> |  |
| <p>4 After opening the project file, select Programs in the project workspace.</p> |  <p>(Project workspace)</p> |

5 Select **Change Model** from the PLC Menu.

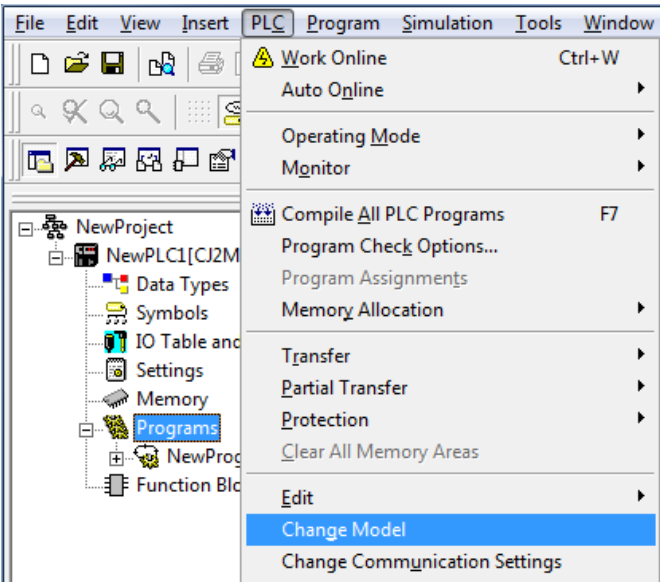

6 The Change PLC Dialog Box is displayed. Select the device type to use from the pull-down list, and click the **Settings** Button.

* CJ2M is used in this document.

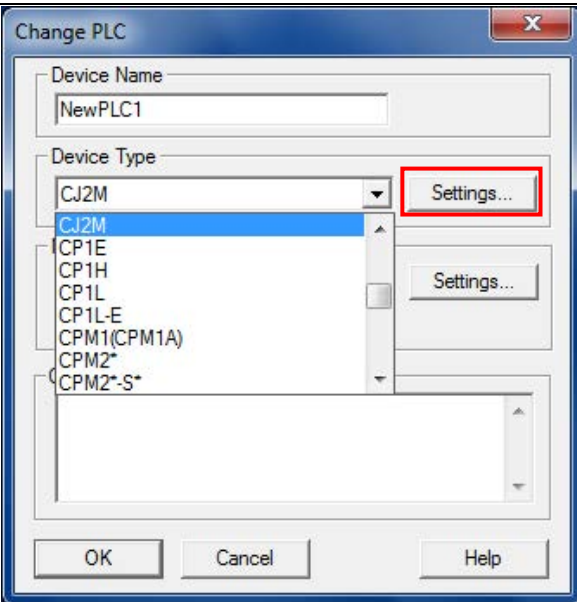

7 The Device Type Settings Dialog Box is displayed. Select the CPU type to use from the pull-down list, and click the **OK** Button.

* CPU12 is used in this document.

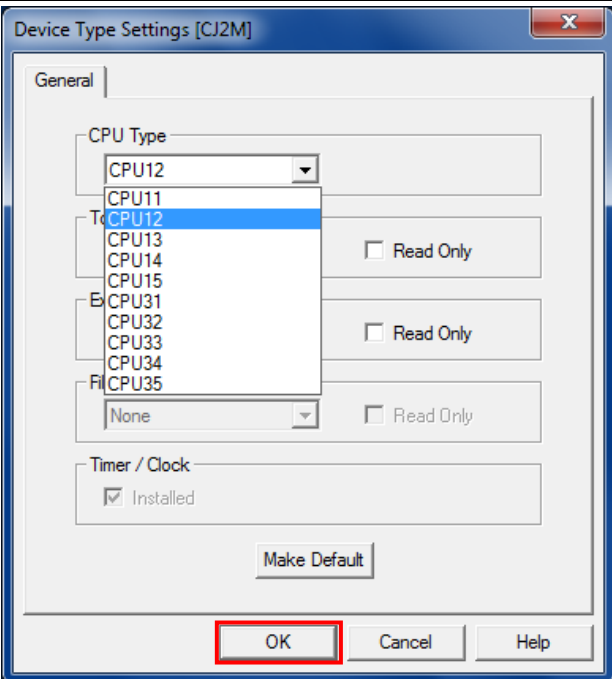

8 Confirm that the Network Type is set to USB on the Change PLC Dialog Box and click the **OK** Button.



* If the Network Type is not set to USB, select *USB* from the pull-down list.

* If you changed the Device Type in step 6 or the CPU Type in step 7, the dialog box on the right is displayed. Confirm that there is no problem and click the **Yes** Button.

Confirm that the program was normally converted ("0 errors" must be shown).

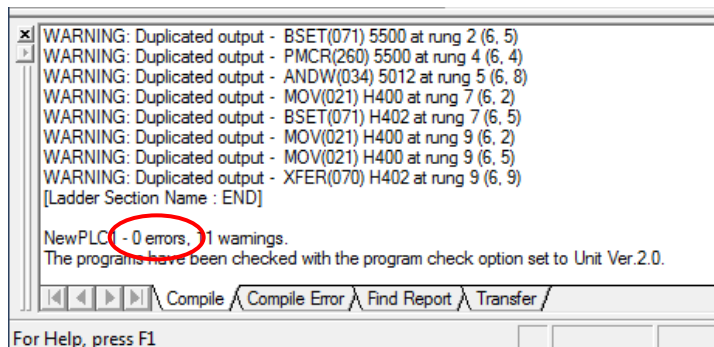
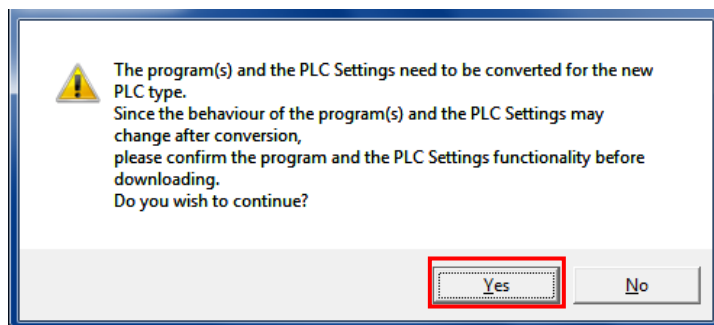
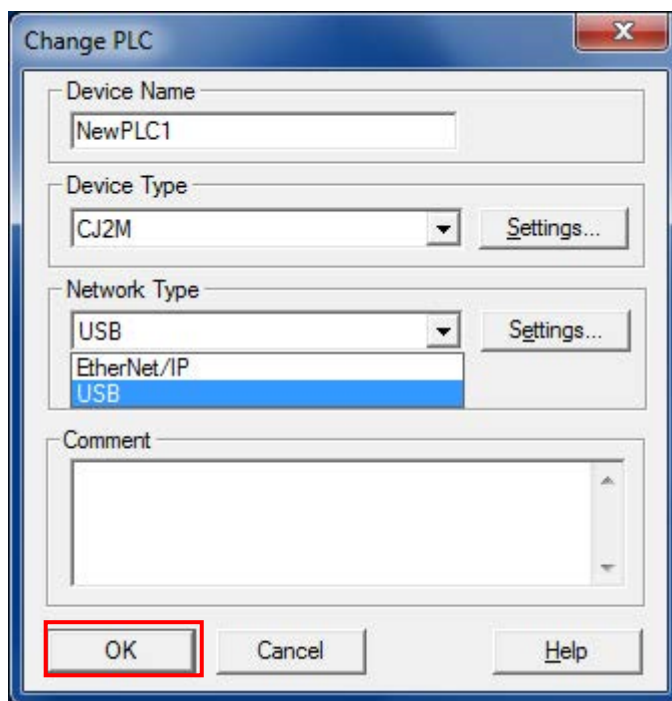
(Although duplicated output warnings were detected in the right dialog, they are not problems.)

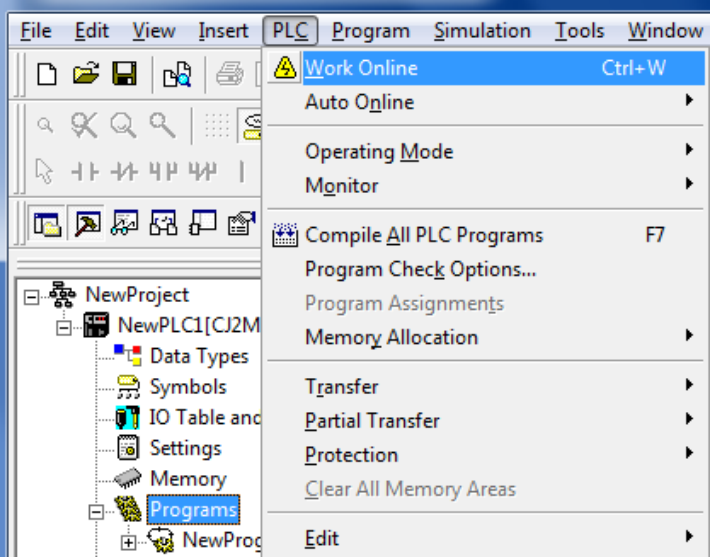
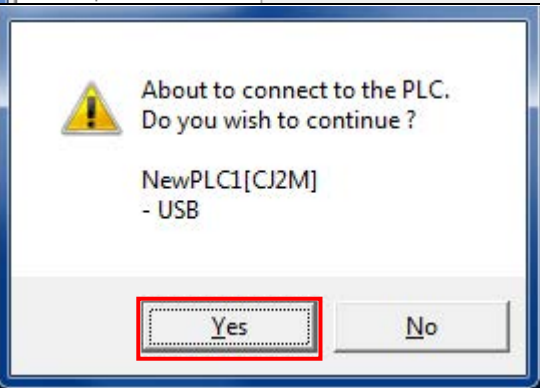

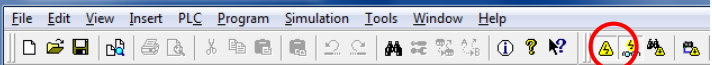
<p>9 Select <i>Programs</i> in the project workspace and select Work Online from the PLC Menu.</p>	
<p>10 The dialog box on the right is displayed. Confirm that there is no problem and click the Yes Button.</p>	
<p>11 Confirm that the CX-Programmer and the PLC are normally connected online.</p> <p>* The  icon is pressed down during online connection.</p>	



Additional Information

If the CX-Programmer and PLC are not connected online, please check the connection of the cable. Or, return to step 5, check the settings in steps 6 to 8 such as the connection type and try again. Refer to *Connecting Directly to a CJ2 CPU Unit Using a USB Cable in Serial Communications (Direct Connection)* in Chapter 3 Communications in PART 3: CX-Server Runtime of the CX-Programmer Operation Manual (Cat. No. W446) for details.



Additional Information

The dialogs explained in this document may not be displayed depending on the environmental setting of CX-Programmer. For details on the environmental setting, refer to *Options and Preferences* in Chapter 3 Project Reference in PART 1: CX-Programmer of the CX-Programmer Operation Manual (Cat. No. W446).

This document explains the setting procedure when the Confirm all operations affecting the PLC Check Box is selected.

7.3.3. Creating the I/O Table

Create the I/O table for the PLC.

1 If the operating mode of the PLC is RUN Mode or Monitor Mode, change it to Program Mode by following the steps below.

(1) Select **Operating Mode - Program** from the PLC Menu of the CX-Programmer.

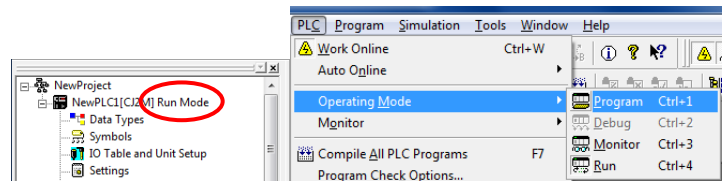

(2) The dialog box on the right is displayed. Confirm that there is no problem and click the **Yes** Button.

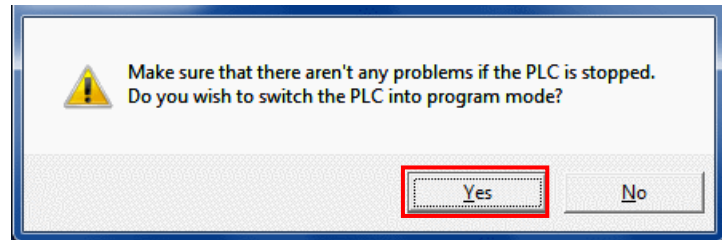

* Refer to *Additional Information* on the previous page for the settings concerning the dialog display.

(3) Confirm that Stop/Program Mode is displayed on the right of the PLC model in the Project Tree.

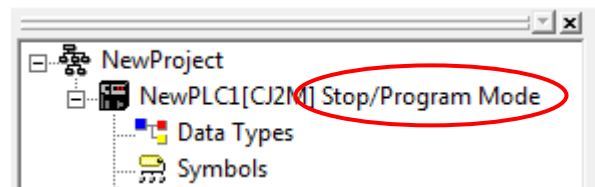

2 Select **Edit - I/O Table and Unit Setup** from the PLC Menu of the CX-Programmer.

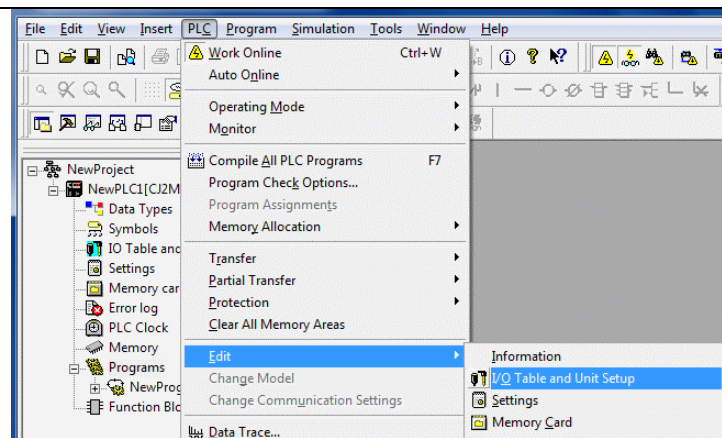

The PLC IO Table Window is displayed.

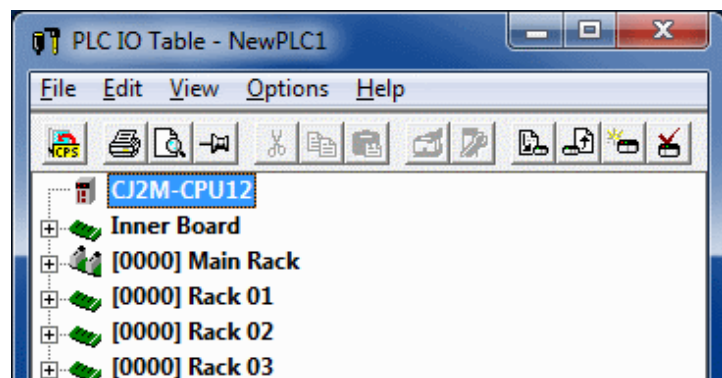

3 Select **Create** from the Options Menu of the PLC IO Table Window.

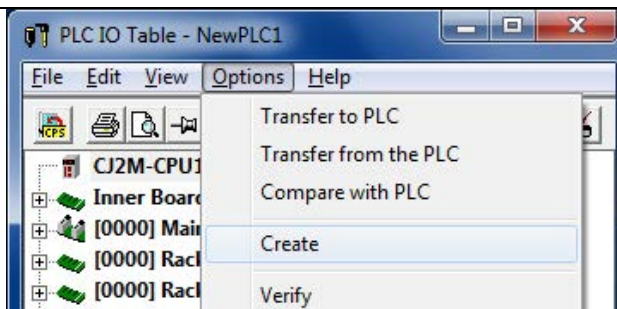

The dialog box on the right is displayed. Confirm that there is no problem and click the **Yes** Button.

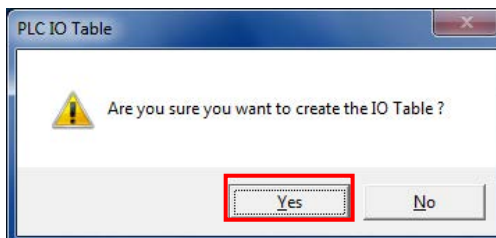

The dialog box on the right is displayed. Confirm that there is no problem and click the **Yes** Button.

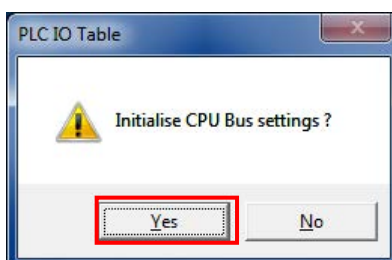

4 The Transfer from PLC Dialog Box is displayed. Select the *I/O Table* Check Box and the *SIO Unit Parameters* Check Box, and click the **Transfer** Button.

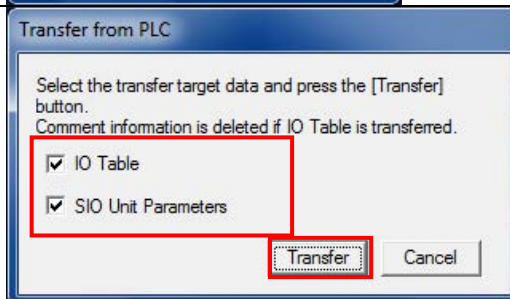

When the transfer is completed, the Transfer Results Dialog Box is displayed. Confirm that the transfer was normally executed by referring to the message in the dialog box.

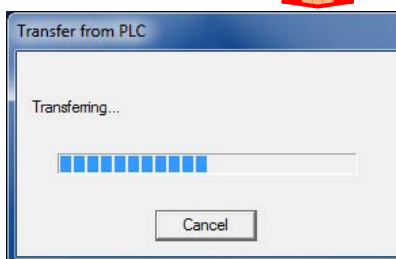

When the I/O table is created normally, the dialog box shows the following:
Transfer Success: 1 Unit
Transfer Unsuccessful: 0 Unit

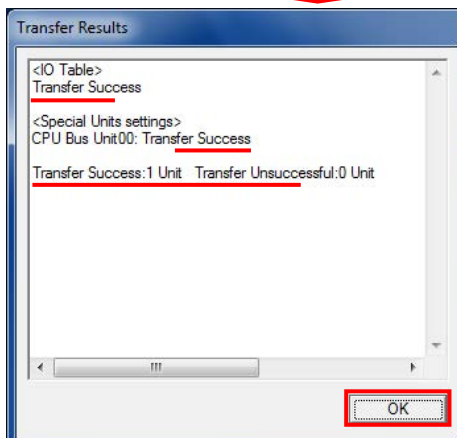

Click the **OK** Button.

7.3.4. Parameter Settings

Set the parameters for the Serial Communications Unit.

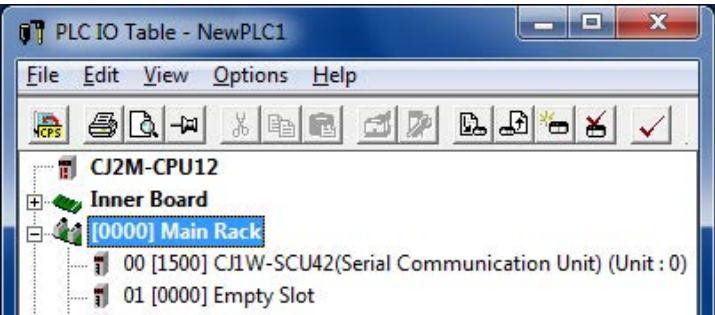
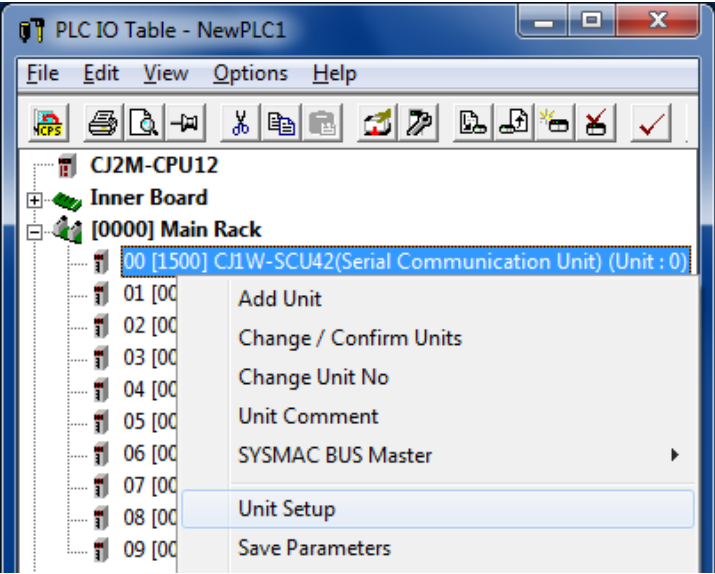
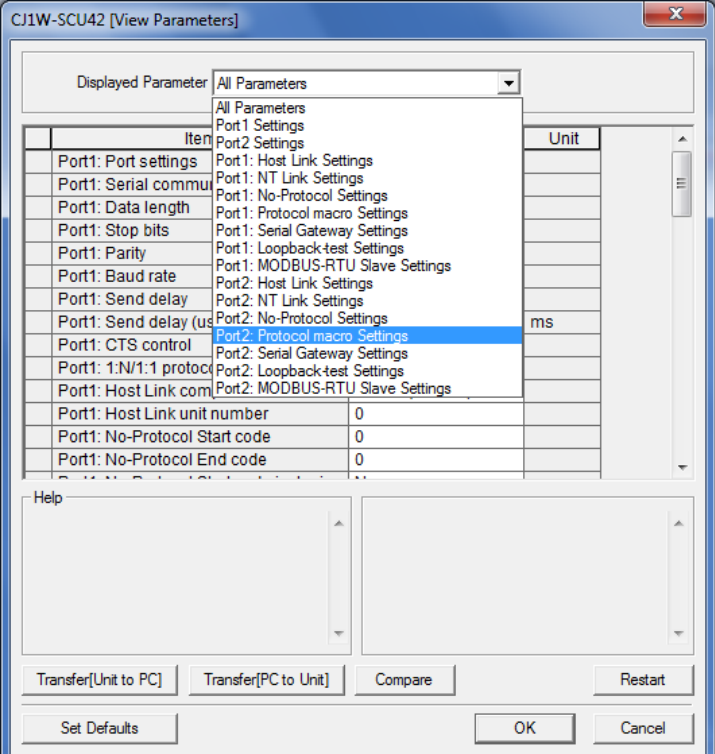
<p>1 Double-click [0000] Main Rack on the PLC IO Table Window to expand the tree.</p>	 <p>The screenshot shows the 'PLC IO Table - NewPLC1' window. The tree structure is expanded to show the 'Inner Board' containing '[0000] Main Rack'. Underneath, two units are listed: '00 [1500] CJ1W-SCU42(Serial Communication Unit) (Unit : 0)' and '01 [0000] Empty Slot'.</p>
<p>2 Right-click 00[1500]CJ1W-SCU42 and select the Unit Setup.</p>	 <p>The screenshot shows the same window as above, but with a right-click context menu open over the '00 [1500] CJ1W-SCU42(Serial Communication Unit) (Unit : 0)'. The menu options include: Add Unit, Change / Confirm Units, Change Unit No, Unit Comment, SYSMAC BUS Master, Unit Setup (highlighted), and Save Parameters.</p>
<p>3 The View Parameters Dialog Box is displayed. Select Port2: Protocol macro Settings for Displayed Parameter.</p> <p>* This setting is required to use Port 2 of the Serial Communications Unit.</p>	 <p>The screenshot shows the 'C1W-SCU42 [View Parameters]' dialog box. The 'Displayed Parameter' dropdown is set to 'All Parameters'. A list of parameters is shown with a dropdown menu open over 'Port2: Protocol macro Settings'. Other parameters include Port1 settings (Host Link, NT Link, No-Protocol, Protocol macro, Serial Gateway, Loopback-test, MODBUS-RTU Slave) and Port2 settings (Host Link, NT Link, No-Protocol, Protocol macro, Serial Gateway, Loopback-test, MODBUS-RTU Slave). At the bottom, there are buttons for 'Transfer[Unit to PC]', 'Transfer[PC to Unit]', 'Compare', 'Restart', 'Set Defaults', 'OK', and 'Cancel'.</p>

4 The setting items of the Port 2: Protocol macro Settings are listed as shown in the right figure. (The figure shows the default values.)

CJ1W-SCU42 [View Parameters]

Displayed Parameter Port2: Protocol macro Settings

Item	Set Value	Unit
Port2: Port settings	Defaults	
Port2: Serial communications mode	Host Link(default)	
Port2: Data length	7 bits	
Port2: Stop bits	2 bits	
Port2: Parity	Even	
Port2: Baud rate	Default(9600bps)	
Port2: Serial Gateway Response timeo	0	ms
Port2: Serial Gateway send start timeo	0	ms
Port2: Protocol macro Transmission m	Half-duplex	
Port2: Clearing/holding the contents of	Clear	
Port2: Link word specification data exc	On-request I/O refre	
Port2: Maximum number of bytes in pro	0	Byte

5 Select *User settings* for Port settings.

CJ1W-SCU42 [View Parameters]

Displayed Parameter Port2: Protocol macro Settings

Item	Set Value	Unit
Port2: Port settings	Defaults	
Port2: Serial communications mode	Defaults	
Port2: Data length	User settings	
Port2: Stop bits	2 bits	
Port2: Parity	Even	
Port2: Baud rate	Default(9600bps)	
Port2: Serial Gateway Response timeo	0	ms
Port2: Serial Gateway send start timeo	0	ms
Port2: Protocol macro Transmission m	Half-duplex	
Port2: Clearing/holding the contents of	Clear	
Port2: Link word specification data exc	On-request I/O refre	
Port2: Maximum number of bytes in pro	0	Byte

6 Set the following parameters in the same way as step 5.

- Serial communications mode :Protocol macro
- Data length :8 bits
- Stop bit :1 bit
- Parity :None
- Baud rate :Default (9600 bps)
- Protocol macro Transmission method :Full-duplex

* Use the default settings for other parameters.

Click the **Transfer [PC to Unit]** Button.

CJ1W-SCU42 [View Parameters]

Displayed Parameter Port2: Protocol macro Settings

Item	Set Value	Unit
Port2: Port settings	User settings	
Port2: Serial communications mode	Protocol macro	
Port2: Data length	8 bits	
Port2: Stop bits	1 bit	
Port2: Parity	None	
Port2: Baud rate	Default(9600bps)	
Port2: Serial Gateway Response timeo	0	ms
Port2: Serial Gateway send start timeo	0	ms
Port2: Protocol macro Transmission m	Full-duplex	
Port2: Clearing/holding the contents of	Clear	
Port2: Link word specification data exc	On-request I/O refre	
Port2: Maximum number of bytes in pro	0	Byte

Help

<Default>Half-duplex
<Address>Word:D30018, Bit:15
<Type>List

Transfer[Unit to PC] **Transfer[PC to Unit]** Compare Restart

Set Defaults OK Cancel

7 The dialog box on the right is displayed. Confirm that there is no problem and click the **Yes** Button.

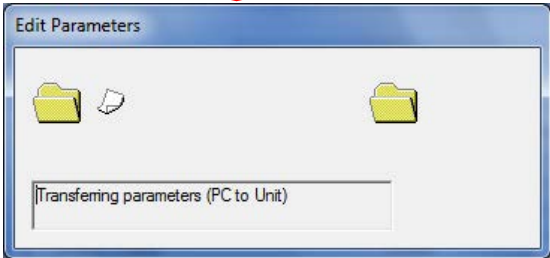
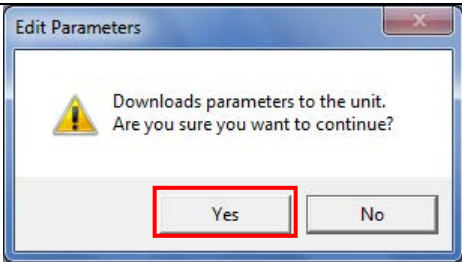

When the transfer is completed, the dialog box on the right is displayed. Click the **Close** Button.

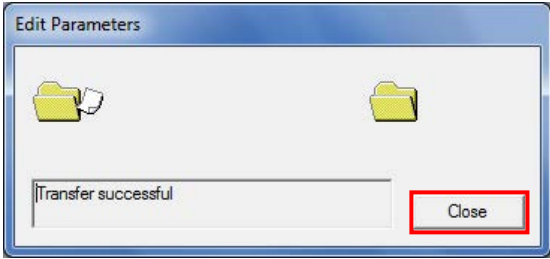

8 A dialog box on the right is displayed. Check the contents and click the **Yes** Button.

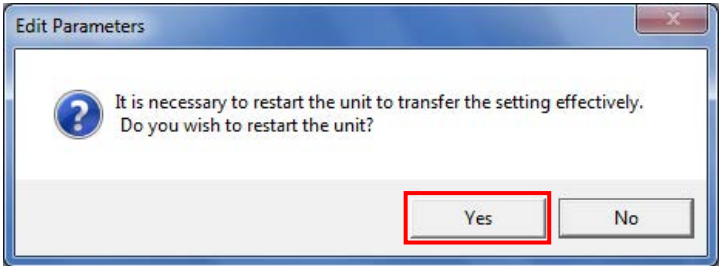

The Select Port Dialog Box is displayed. Select *All ports* and click the **OK** Button.

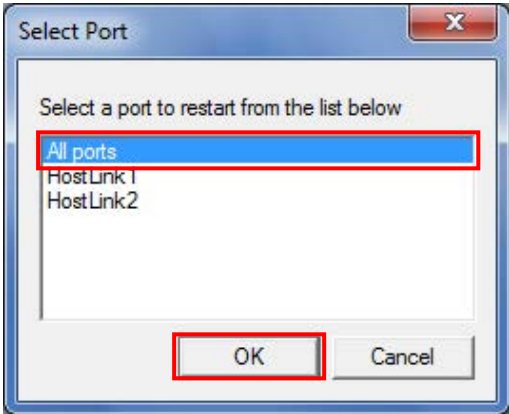

9 The dialog box on the right is displayed. Check the contents and click the **OK** Button.

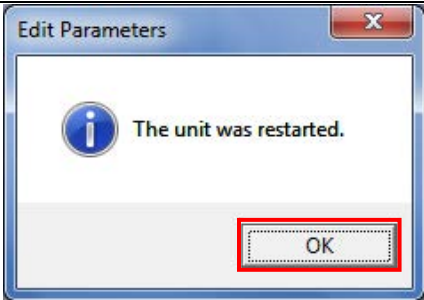

10 Click the **Compare** Button on the View Parameters Dialog Box.

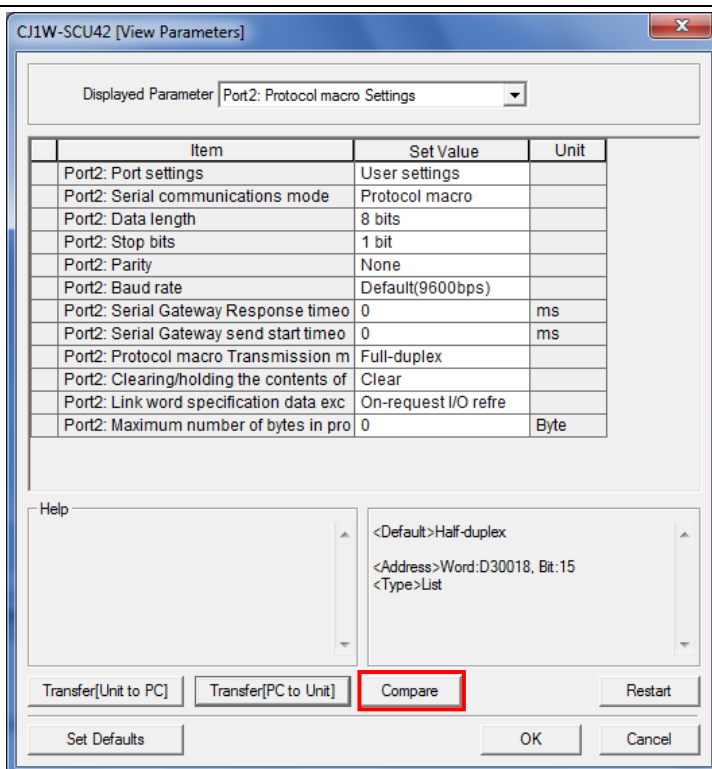

11 The dialog box on the right is displayed when the parameter settings matches. Click the **Close** Button.

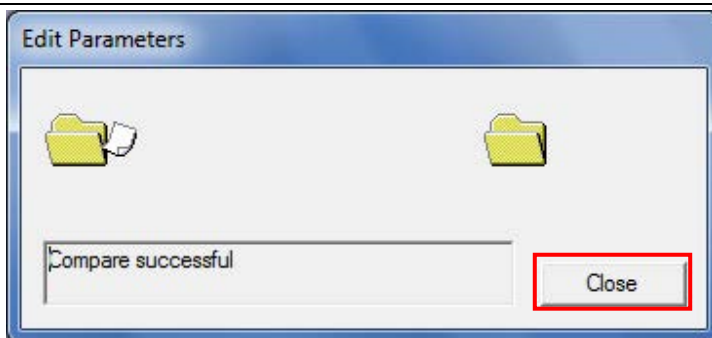

12 Click the **OK** Button on the View Parameters Dialog Box.

Close the Edit Parameters Dialog Box and PLC IO Table Window.

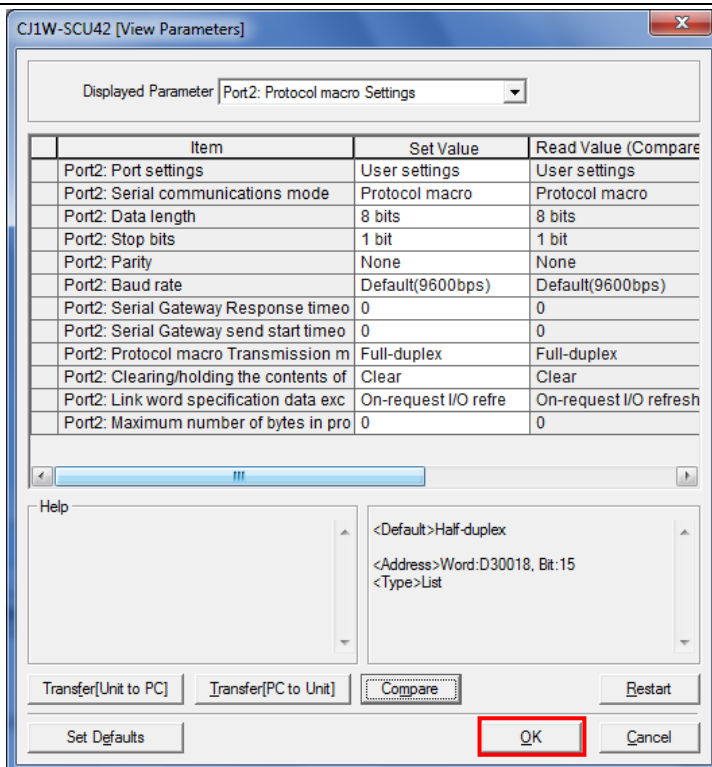

7.3.5. Transferring the Project Data

Transfer the project data to the PLC.

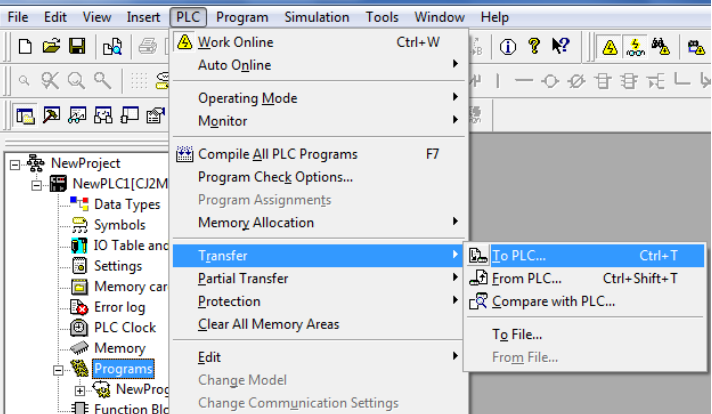
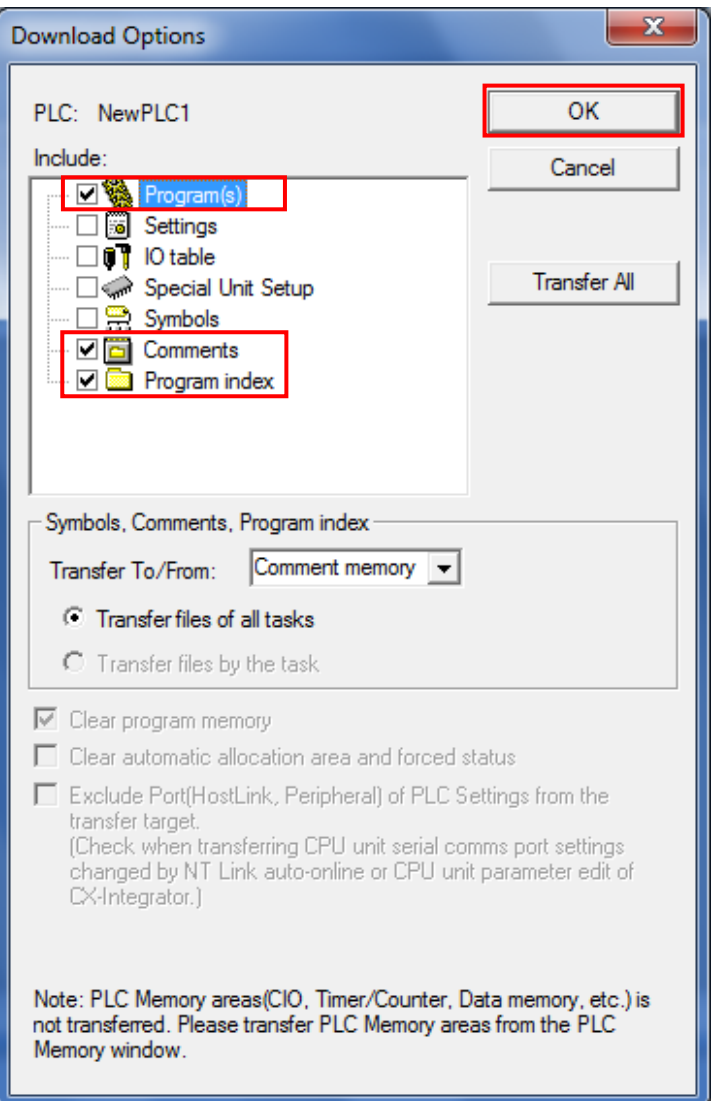
<p>1 Select Programs on the project workspace of the CX-programmer, and select Transfer - To PLC from the PLC Menu.</p>	
<p>2 Select the <i>Program(s)</i> Check Box, <i>Comments</i> Check Box, and <i>Program index</i> Check Box, and click the OK Button.</p> <p>* Transferring the I/O table and Special Unit Setup is unnecessary here, because they were set in Section 7.3.3 and Section 7.3.4.</p> <p>* The Comments Check Box and the Program index Check Box may not be displayed depending on the device type. In such a case, select the <i>Program(s)</i> Check Box only and transfer the project data.</p>	 <p>PLC: NewPLC1</p> <p>Include:</p> <ul style="list-style-type: none"> <input checked="" type="checkbox"/> Program(s) <input type="checkbox"/> Settings <input type="checkbox"/> IO table <input type="checkbox"/> Special Unit Setup <input type="checkbox"/> Symbols <input checked="" type="checkbox"/> Comments <input checked="" type="checkbox"/> Program index <p>Symbols, Comments, Program index</p> <p>Transfer To/From: Comment memory</p> <p><input checked="" type="radio"/> Transfer files of all tasks</p> <p><input type="radio"/> Transfer files by the task</p> <p><input checked="" type="checkbox"/> Clear program memory</p> <p><input type="checkbox"/> Clear automatic allocation area and forced status</p> <p><input type="checkbox"/> Exclude Port(HostLink, Peripheral) of PLC Settings from the transfer target. (Check when transferring CPU unit serial comms port settings changed by NT Link auto-online or CPU unit parameter edit of CX-Integrator.)</p> <p>Note: PLC Memory areas(CIO, Timer/Counter, Data memory, etc.) is not transferred. Please transfer PLC Memory areas from the PLC Memory window.</p>

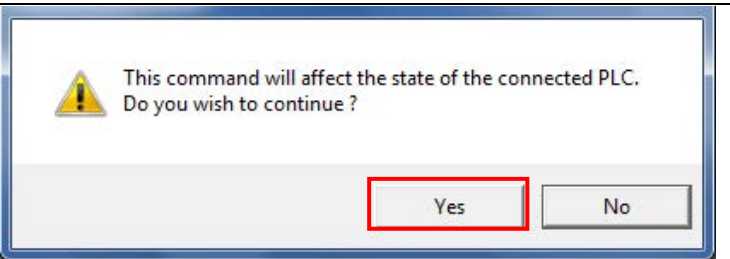
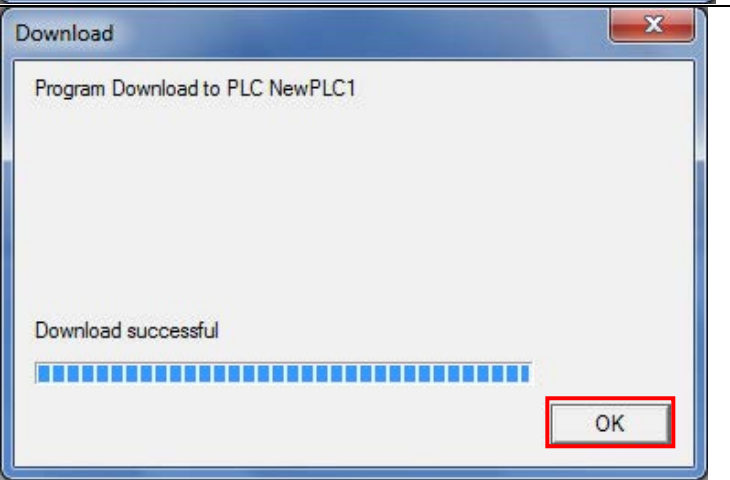
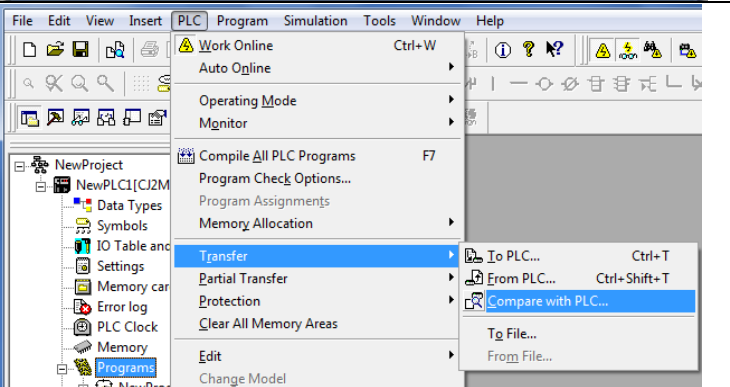
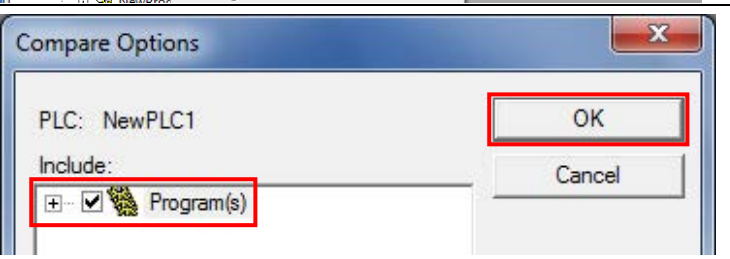
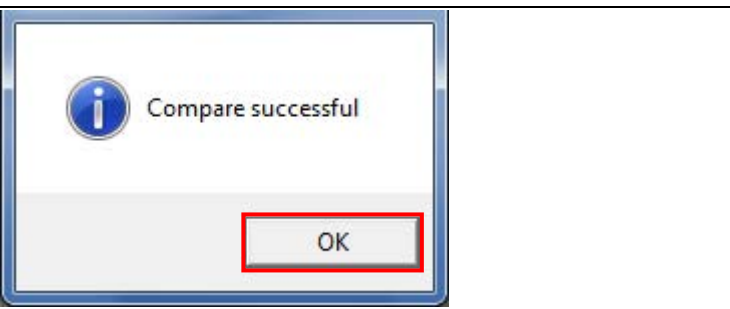
<p>3 The dialog box on the right is displayed. Confirm that there is no problem and click the Yes Button.</p>	
<p>4 The dialog box on the right is displayed (stating "Download successful") when the transfer is completed. Click the OK Button.</p>	
<p>5 Select <i>Programs</i> in the project workspace, and select Transfer - Compare with PLC from the PLC Menu.</p>	
<p>6 Select the <i>Program(s)</i> Check Box and click the OK Button.</p>	
<p>7 Confirm that a message stating "Compare successful" is displayed, and click the OK Button.</p>	

7.3.6. Starting the CX-Protocol and Opening the Protocol Macro Data

Start the CX-Protocol and open the protocol macro data.

- 1 Start the CX-Protocol.

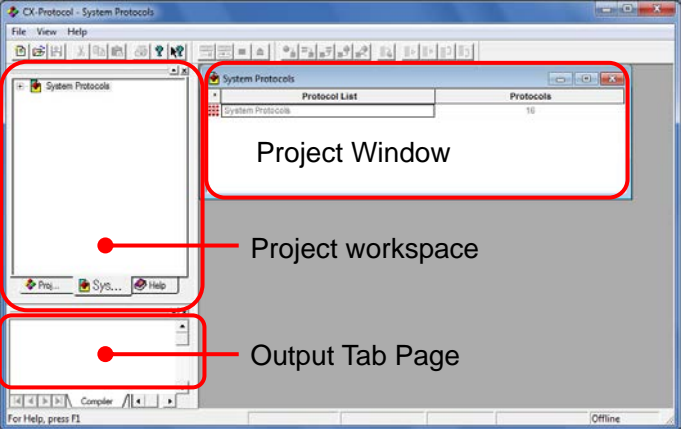

(CX-Protocol)
- 2 Select **Open** from the File Menu.

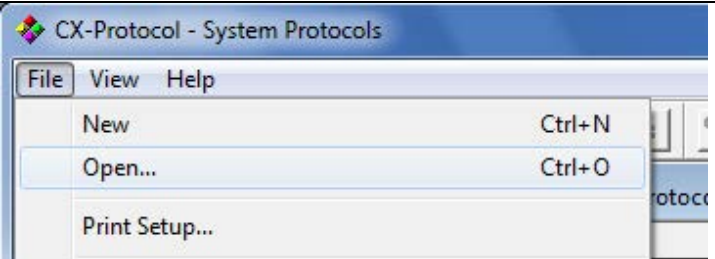
- 3 On the Open Dialog Box, select *OMRON_V400-R2_PMCR_EV100.psw* and click the **Open** Button.

* Obtain the protocol macro data from OMRON.

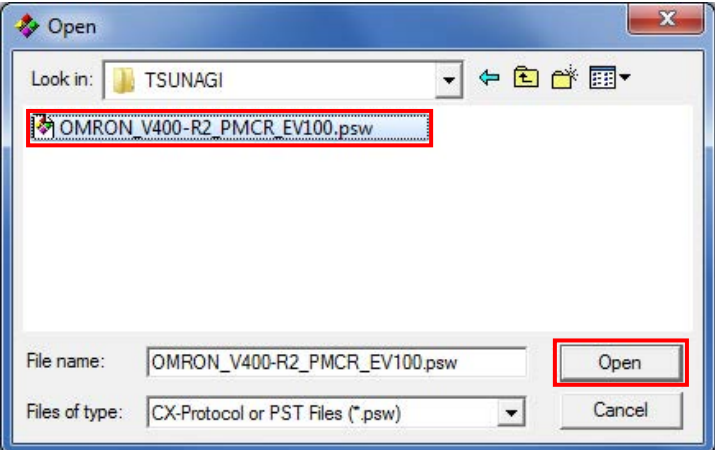
- 4 The project workspace and the Project Window display the protocol macro data that was read.

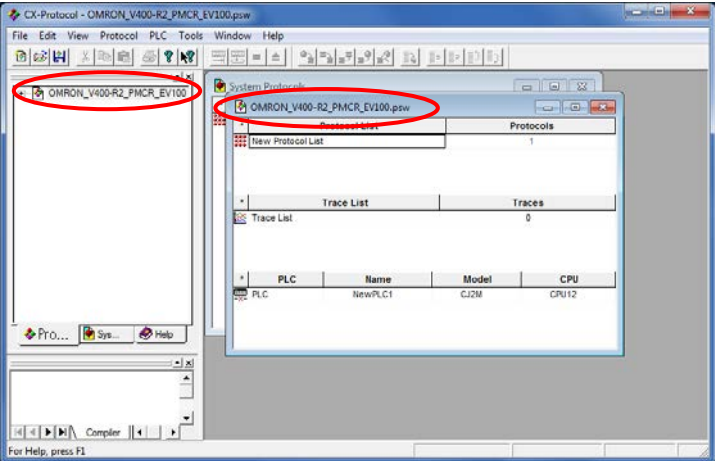

7.3.7. Connecting Online and Transferring the Protocol Macro Data

Connect online with the CX-Protocol, and transfer the protocol macro data to the Serial Communications Unit.

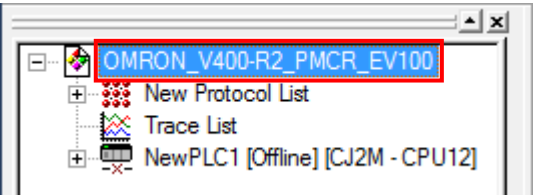
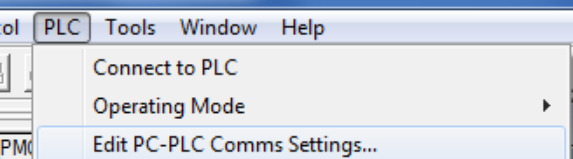
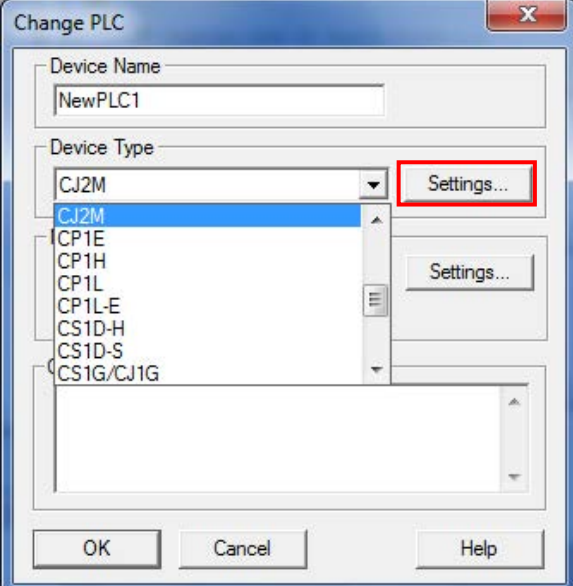
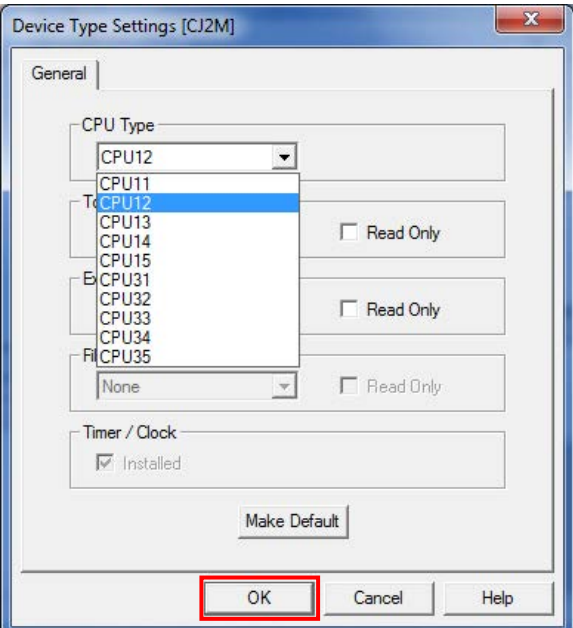
<p>1 Double-click the OMRON_V400-R2_PMCR_EV100 on the project workspace to display a tree.</p>	
<p>2 Select Edit PC-PLC Comms Settings from the PLC Menu.</p>	
<p>3 The Change PLC Dialog Box is displayed. Select the device type to use from the pull-down list, and click the Settings Button.</p> <p>* CJ2M is used in this document.</p>	
<p>4 The Device Type Settings Dialog Box is displayed. Select the CPU type to use from the pull-down list, and click the OK Button.</p> <p>* CPU12 is used in this document.</p>	

5 Confirm that the Network Type is set to USB on the Change PLC Dialog Box and click the **OK** Button.

* If the Network Type is not set to USB, select *USB* from the pull-down list.

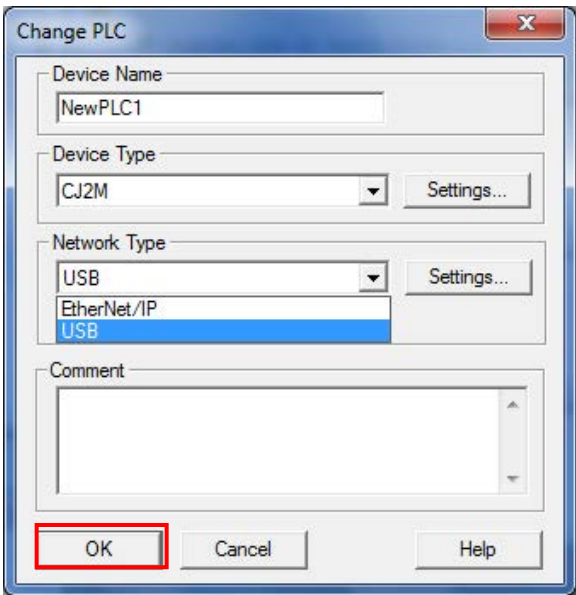

6 Select **Connect to PLC** from the PLC Menu.

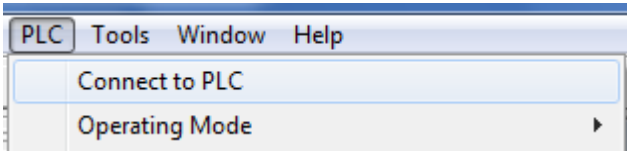

7 The PLC icon on the project workspace changes from Offline to Program. It means that the PLC is connected online.

* If Monitor or Run is displayed, change it to Program by following steps 8 and 9.

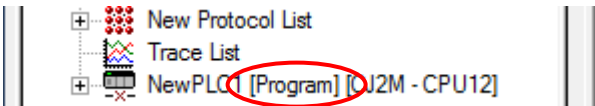

8 If the *operating mode* of the PLC is Monitor or Run, select **Operating Mode - Program** from the PLC Menu.

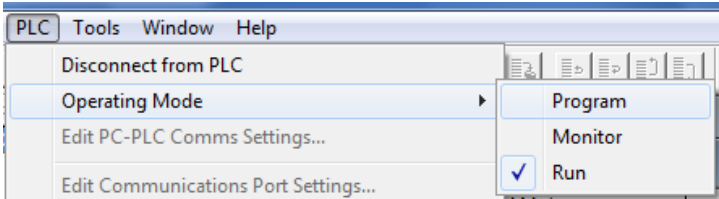

9 The dialog box on the right is displayed. Confirm that there is no problem and click the **Yes** Button. Confirm that the operating mode was changed to Program mode as shown in step 7.

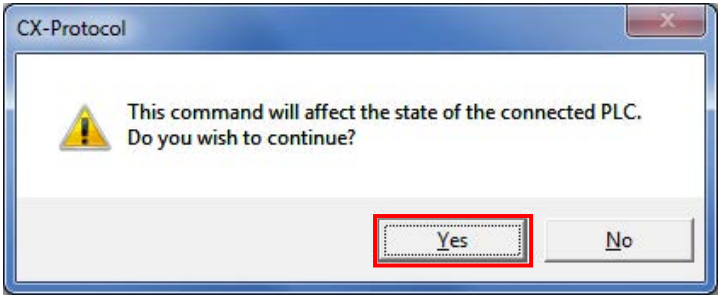

10 Double-click the **New Protocol List** on the project workspace to display a tree.

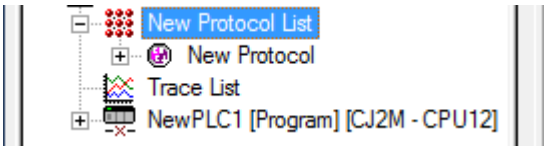

11 The Project Window on the right is displayed. Confirm that *SCU[0]* is entered in the Target Column.

* If *SCU[0]* is not entered, select *SCU[0]* as shown on the right figure.

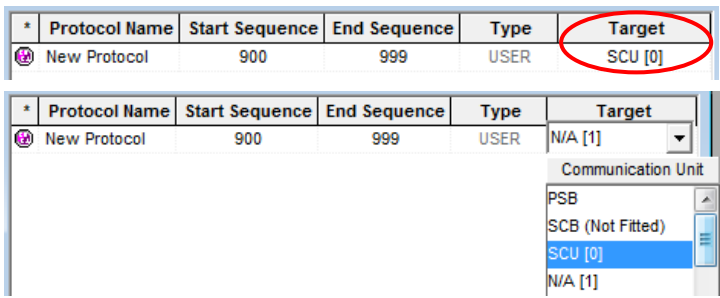

12 Select **New Protocol List** and select **Download Protocols** from the Protocol Menu.

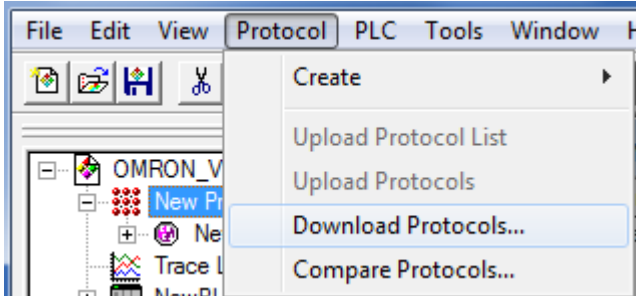

13 The dialog box on the right is displayed. Select the *Include Source Information* Check Box and click the **Compile** Button.

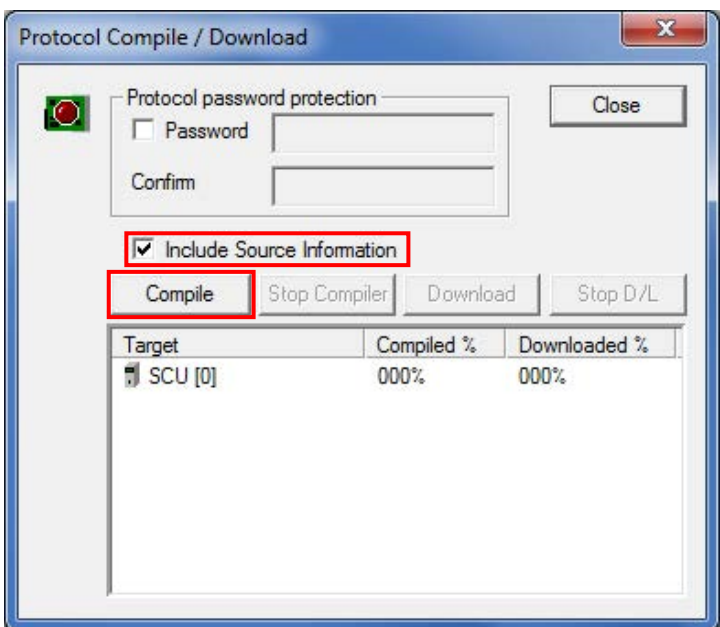

14 When 100% is displayed in the *Compiled %* Column, the compiling operation is completed. After confirming that the compiling operation is completed, click the **Download** Button.

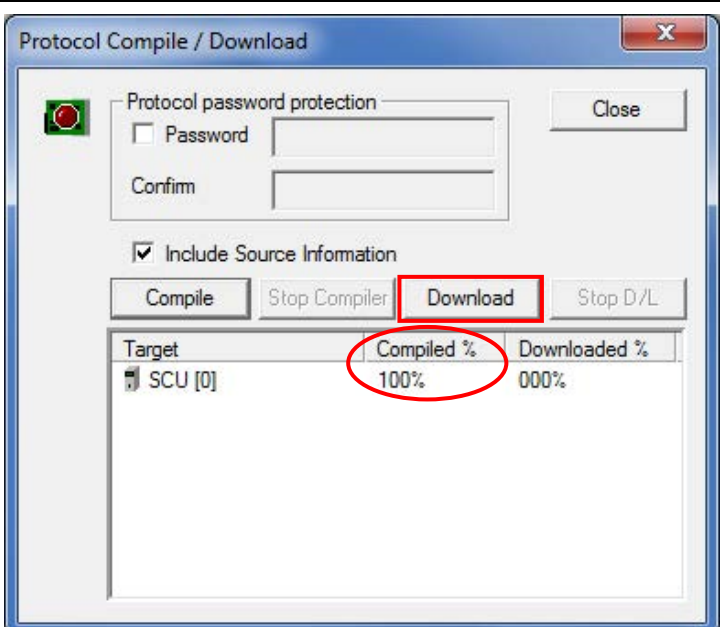

15 The dialog box on the right is displayed. Confirm that there is no problem and click the **OK** Button.

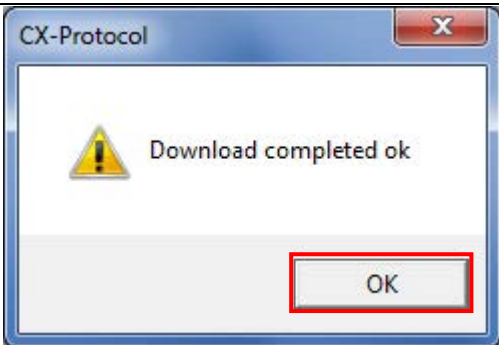

16 Check that 100% is displayed in the *Downloaded %* Column in the right figure, and click the **Close** Button.

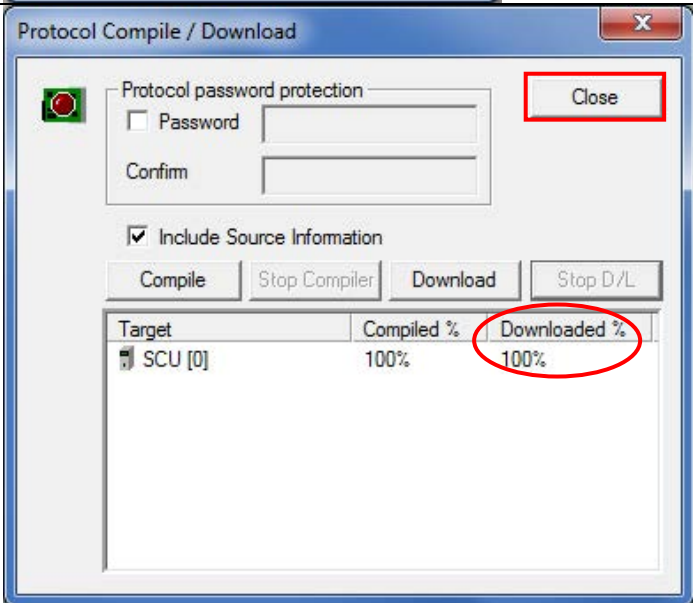

17 Select **New Protocol List** and select **Compare Protocols** from the Protocol Menu.

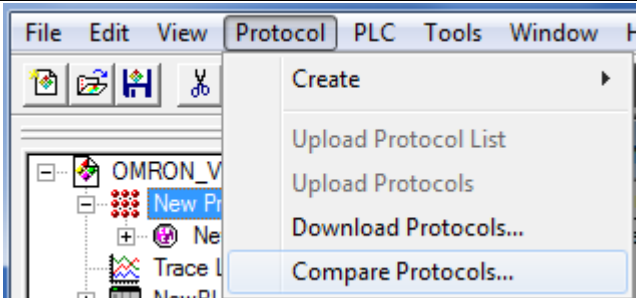

18 The dialog box on the right is displayed. Select the *Include Source Information* Check Box and click the **Compile** Button.

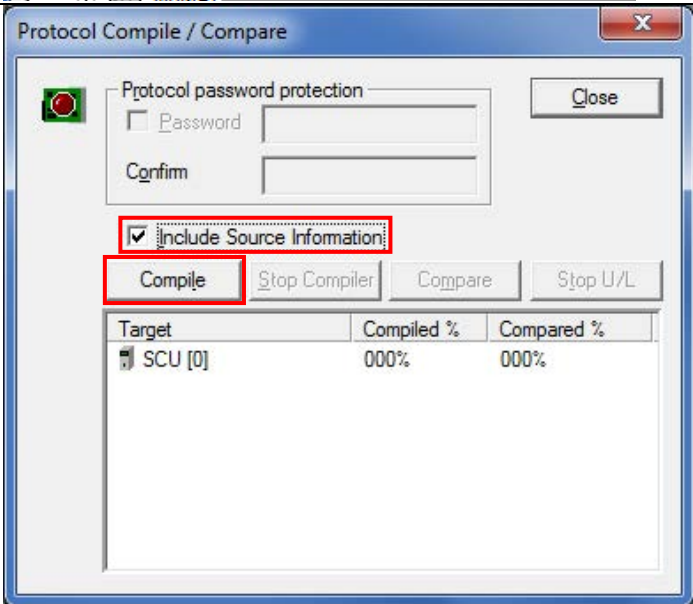

19 When 100% is displayed in the *Complied %* Column, the compiling operation is completed. After confirming that the compiling operation is completed, click the **Compare** Button.

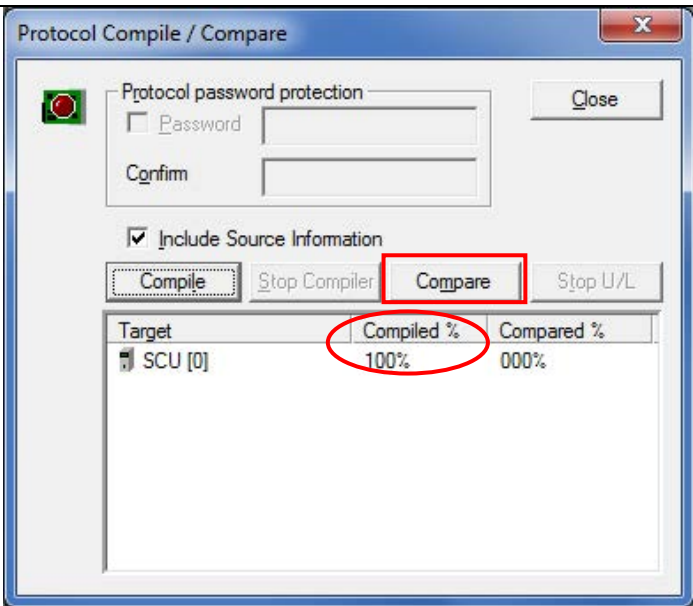

20 The dialog box on the right is displayed. Confirm that *Successful* is displayed in the Result Column and click the **OK** Button.

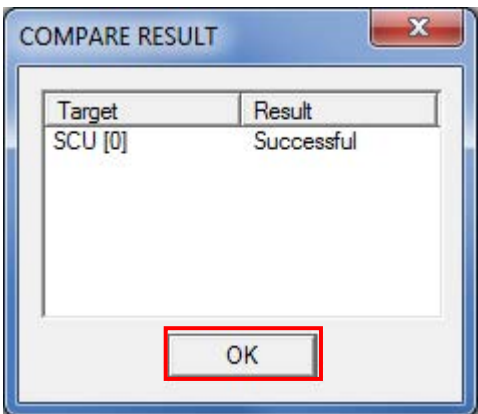

21 Confirm that 100% is displayed in the *Compared %* Column in the right figure, and click the **Close** Button.

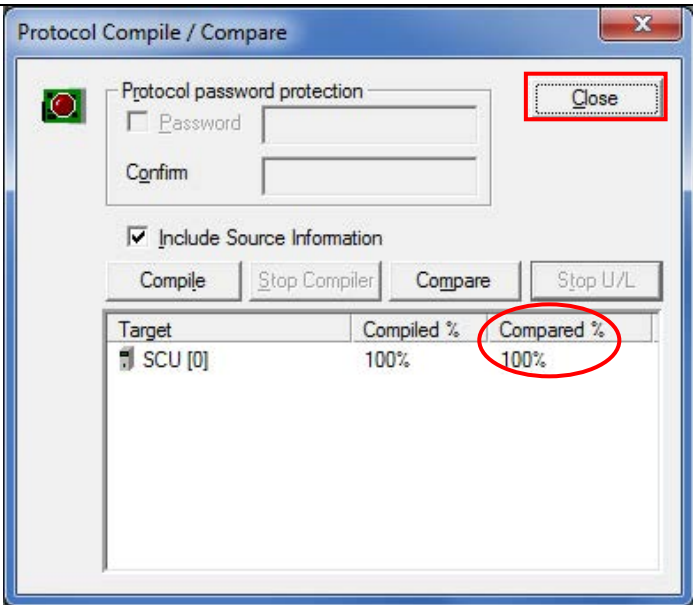

7.4. Checking the Serial Communications

Execute the program and confirm that serial communications are normally performed.

⚠ Caution

Confirm safety sufficiently before monitoring power flow and present value status in the Ladder Section window or before monitoring present values in the Watch window.

If force-set/reset or set/reset operations are incorrectly performed by pressing short-cut keys, the devices connected to Output Units may malfunction, regardless of the operating mode of the CPU Unit.



Precautions for Correct Use

This document explains the procedures for setting up the Code Reader from the factory default setting. If the Code Reader was changed from the factory default setting, make sure to initialize by referring to *Section 8.2. Initializing the Code Reader*.





Precautions for Correct Use

Confirm that the serial cable is connected before proceeding to the following procedure. If it is not connected, turn OFF the power supply to each device, and then connect the serial cable.

7.4.1. Starting Tracing

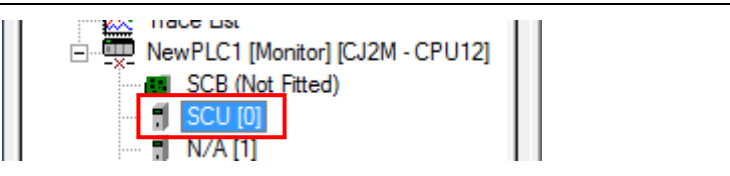

Start tracing with the CX-Protocol.

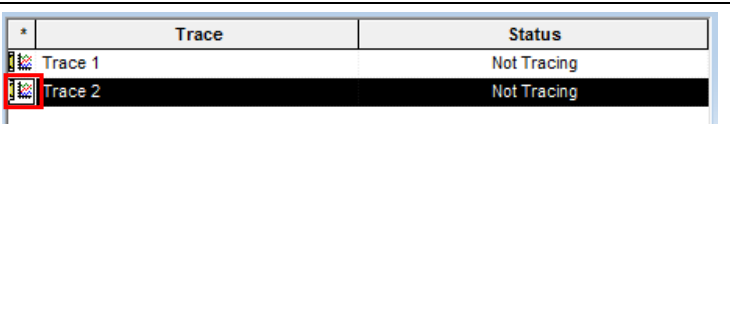
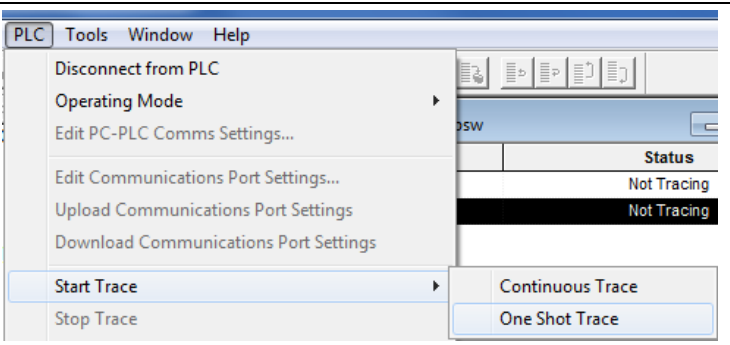
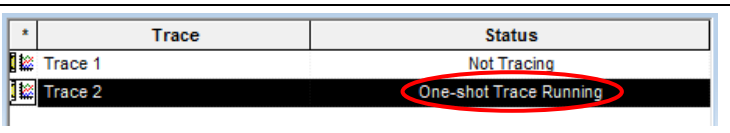
<p>1 Select Operating Mode - Monitor from the PLC Menu of the CX-Protocol.</p>	
<p>2 The dialog box on the right is displayed. Confirm that there is no problem and click the Yes Button.</p>	
<p>3 Confirm that the operating mode was changed to the Monitor mode, and double-click NewPLC1.</p>	

<p>4 The tree under  NewPLC1 expands. Select the Serial Communications Unit (SCU[0] is selected in the right figure).</p>	 <p>The screenshot shows a tree view under 'NewPLC1 [Monitor] [CJ2M - CPU12]'. The 'SCU [0]' item is highlighted with a red box. Other items include 'SCB (Not Fitted)' and 'N/A [1]'.</p>						
<p>5 Select the Trace 2 Icon () on the Project Window. (Confirm that Trace 2 is highlighted as shown in the right figure.)</p> <p>* Trace 2 corresponds to port 2 of the Serial Communications Unit.</p>	 <table border="1"> <thead> <tr> <th>Trace</th> <th>Status</th> </tr> </thead> <tbody> <tr> <td>Trace 1</td> <td>Not Tracing</td> </tr> <tr> <td>Trace 2</td> <td>Not Tracing</td> </tr> </tbody> </table>	Trace	Status	Trace 1	Not Tracing	Trace 2	Not Tracing
Trace	Status						
Trace 1	Not Tracing						
Trace 2	Not Tracing						
<p>6 Select Start Trace - One Shot Trace from the PLC Menu.</p>	 <p>The screenshot shows the 'PLC' menu with 'Start Trace' selected. A sub-menu is open showing 'Continuous Trace' and 'One Shot Trace' options.</p>						
<p>7 Confirm that the status of Trace 2 in the Project Window was changed to One-shot Trace Running.</p>	 <table border="1"> <thead> <tr> <th>Trace</th> <th>Status</th> </tr> </thead> <tbody> <tr> <td>Trace 1</td> <td>Not Tracing</td> </tr> <tr> <td>Trace 2</td> <td>One-shot Trace Running</td> </tr> </tbody> </table>	Trace	Status	Trace 1	Not Tracing	Trace 2	One-shot Trace Running
Trace	Status						
Trace 1	Not Tracing						
Trace 2	One-shot Trace Running						

7.4.2. Executing the Program

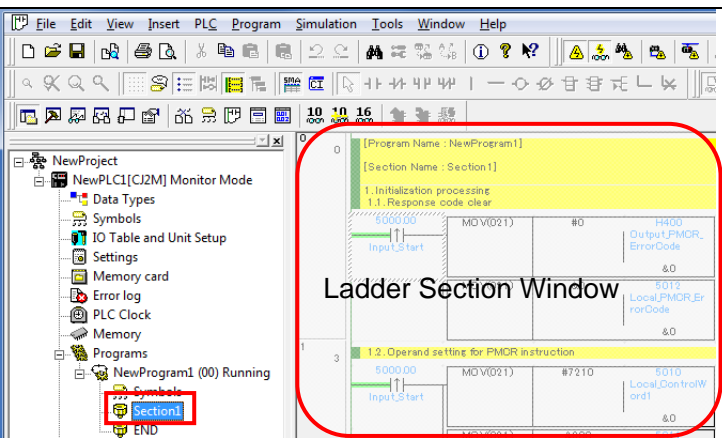
Execute the program with the CX-Programmer.

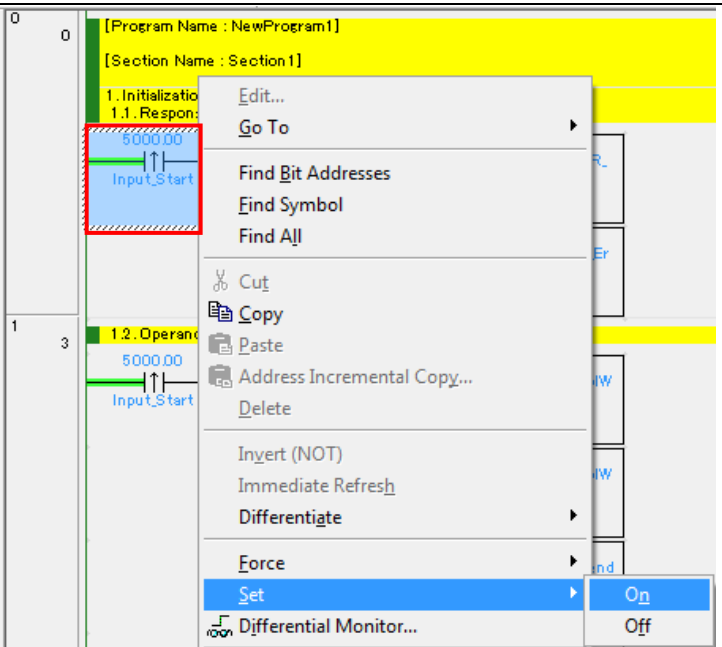
<p>1 Expand the Programs Tree on the project workspace of the CX-Programmer, and double-click Section1. The Ladder Section Window shows the Section 1 ladder.</p>	
<p>2 Read the bar code shown on the right as an example. Position the Code Reader so that it can read the bar code shown on the right.</p>	
<p>3 On the Ladder Section Window, right-click <i>Input_Start</i> and select Set - On.</p> <p>* You can right-click any <i>Input_Start</i> contact. (<i>Input_Start</i> of Block 0 is operated in the right figure.)</p>	

4 Confirm that the *Input_Start* contact is turned ON as shown in the right figure.

The program operates, serial communications are performed with the Code Reader, and then the bar code is read.

- * If the Read confirmation LED that is on the top of the Code Reader is lit green and a buzzer sounds, then the read operation succeeds.
- * If the bar code shown in the document cannot be read, read a bar code shown in Preliminary Examination in *Section 2 Introduction Procedure of the Ultra Small Multi-code Reader V400-R2 Series User's Manual* (Cat. No. Z333). Turn *Input_Start* OFF and then ON in the same way as step 3.

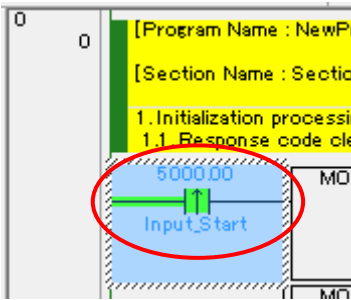

A buzzer sounds if the read operation succeeds.

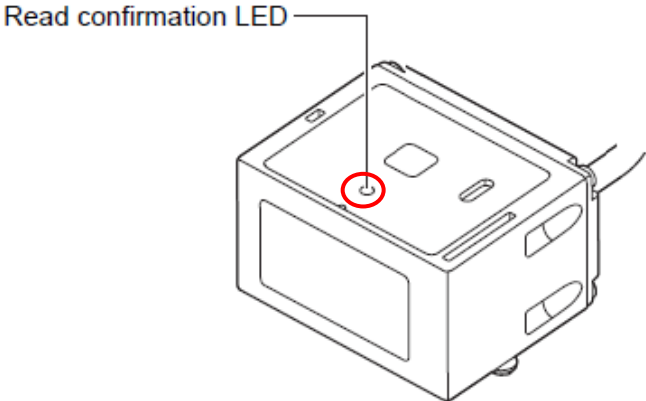

7.4.3. Checking the Trace Data

Confirm that the correct data is sent and received by checking the trace data of the CX-Protocol.

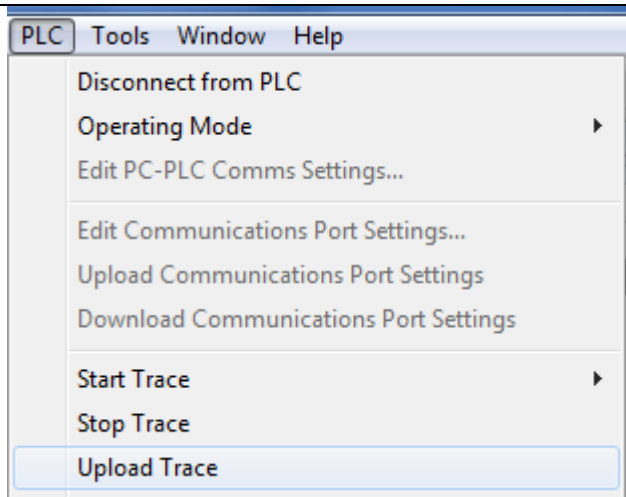
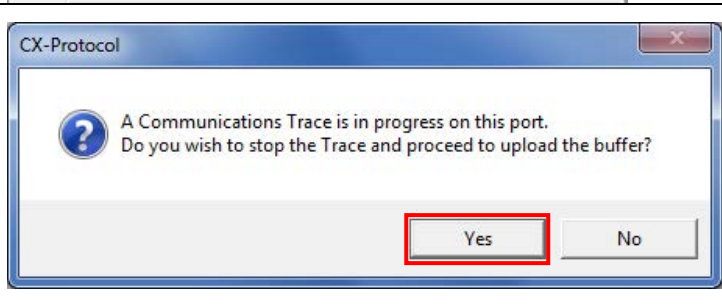
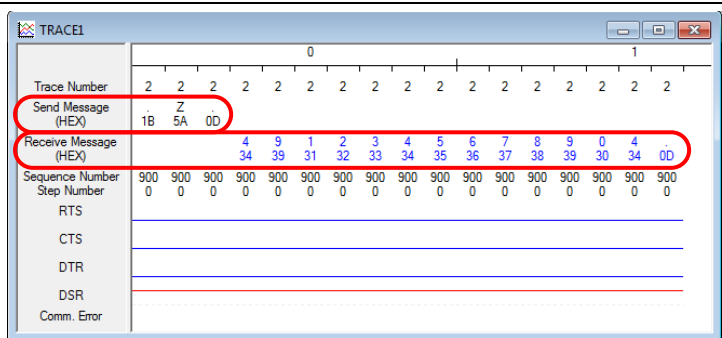
<p>1 Select Upload Trace from the PLC Menu from the CX-Protocol.</p>																																																																																																																																																																																																																																																																																																																																			
<p>2 A dialog box on the right is displayed. Check the contents and click the Yes Button.</p>																																																																																																																																																																																																																																																																																																																																			
<p>3 Check the send/receive message on the trace data file shown in the right figure.</p> <p>* In the example on the right, the Reading Trigger command is sent from the Controller and the bar code data that are shown in step 2 of Section 7.4.2. are received.</p>	 <table border="1" data-bbox="703 1160 1428 1496"> <thead> <tr> <th>Trace Number</th> <th colspan="16">0</th> <th colspan="16">1</th> </tr> </thead> <tbody> <tr> <td>Send Message (HEX)</td> <td colspan="16">Z</td> <td colspan="16"></td> </tr> <tr> <td>Receive Message (HEX)</td> <td>1B</td><td>5A</td><td>0D</td> <td>4</td><td>9</td><td>1</td><td>2</td><td>3</td><td>4</td><td>5</td><td>6</td><td>7</td><td>8</td><td>9</td><td>0</td><td>4</td> <td>34</td><td>39</td><td>31</td><td>32</td><td>33</td><td>34</td><td>35</td><td>36</td><td>37</td><td>38</td><td>39</td><td>30</td><td>34</td><td>0D</td> </tr> <tr> <td>Sequence Number</td> <td>900</td><td>900</td><td>900</td><td>900</td><td>900</td><td>900</td><td>900</td><td>900</td><td>900</td><td>900</td><td>900</td><td>900</td><td>900</td><td>900</td><td>900</td><td>900</td> <td>900</td><td>900</td><td>900</td><td>900</td><td>900</td><td>900</td><td>900</td><td>900</td><td>900</td><td>900</td><td>900</td><td>900</td><td>900</td> </tr> <tr> <td>Step Number</td> <td>0</td><td>0</td><td>0</td><td>0</td><td>0</td><td>0</td><td>0</td><td>0</td><td>0</td><td>0</td><td>0</td><td>0</td><td>0</td><td>0</td><td>0</td><td>0</td> <td>0</td><td>0</td><td>0</td><td>0</td><td>0</td><td>0</td><td>0</td><td>0</td><td>0</td><td>0</td><td>0</td><td>0</td><td>0</td> </tr> <tr> <td>RTS</td> <td colspan="32"></td> </tr> <tr> <td>CTS</td> <td colspan="32"></td> </tr> <tr> <td>DTR</td> <td colspan="32"></td> </tr> <tr> <td>DSR</td> <td colspan="32"></td> </tr> <tr> <td>Comm. Error</td> <td colspan="32"></td> </tr> </tbody> </table> <ul style="list-style-type: none"> ■ Send message <ul style="list-style-type: none"> Hex :1B 5A 0D String :[ESC]"Z"[CR] ■ Receive message <ul style="list-style-type: none"> Hex :34 39 31 32 33 34 35 36 37 38 39 30 34 0D String :“4912345678904”[CR] 	Trace Number	0																1																Send Message (HEX)	Z																																Receive Message (HEX)	1B	5A	0D	4	9	1	2	3	4	5	6	7	8	9	0	4	34	39	31	32	33	34	35	36	37	38	39	30	34	0D	Sequence Number	900	900	900	900	900	900	900	900	900	900	900	900	900	900	900	900	900	900	900	900	900	900	900	900	900	900	900	900	900	Step Number	0	0	0	0	0	0	0	0	0	0	0	0	0	0	0	0	0	0	0	0	0	0	0	0	0	0	0	0	0	RTS																																	CTS																																	DTR																																	DSR																																	Comm. Error																																
Trace Number	0																1																																																																																																																																																																																																																																																																																																																		
Send Message (HEX)	Z																																																																																																																																																																																																																																																																																																																																		
Receive Message (HEX)	1B	5A	0D	4	9	1	2	3	4	5	6	7	8	9	0	4	34	39	31	32	33	34	35	36	37	38	39	30	34	0D																																																																																																																																																																																																																																																																																																					
Sequence Number	900	900	900	900	900	900	900	900	900	900	900	900	900	900	900	900	900	900	900	900	900	900	900	900	900	900	900	900	900																																																																																																																																																																																																																																																																																																						
Step Number	0	0	0	0	0	0	0	0	0	0	0	0	0	0	0	0	0	0	0	0	0	0	0	0	0	0	0	0	0																																																																																																																																																																																																																																																																																																						
RTS																																																																																																																																																																																																																																																																																																																																			
CTS																																																																																																																																																																																																																																																																																																																																			
DTR																																																																																																																																																																																																																																																																																																																																			
DSR																																																																																																																																																																																																																																																																																																																																			
Comm. Error																																																																																																																																																																																																																																																																																																																																			

7.4.4. Checking the Receive Data

Confirm that the correct data is written to the I/O memory of the PLC with the CX-Programmer.

1 Select **Edit - Memory** from the PLC Menu of the CX-Programmer.

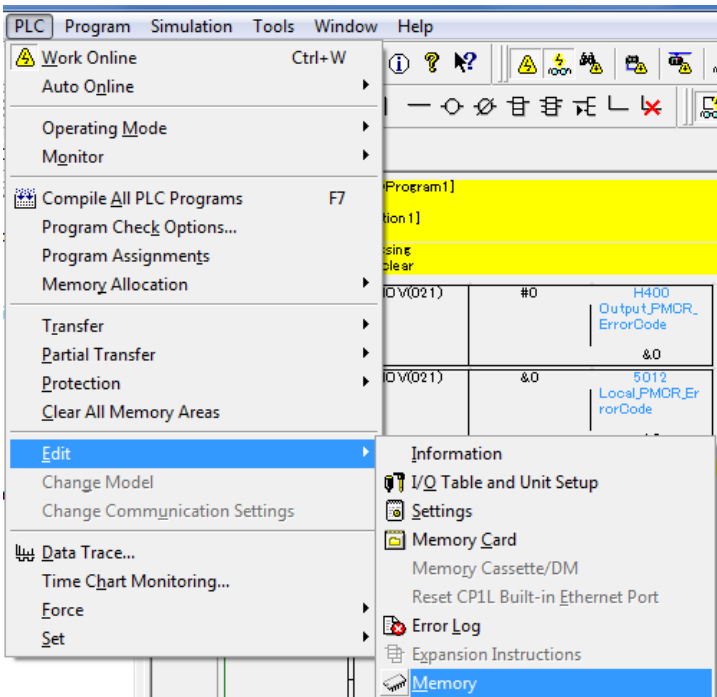

2 Double-click **CIO** from the list in the PLC Memory Window that is displayed.

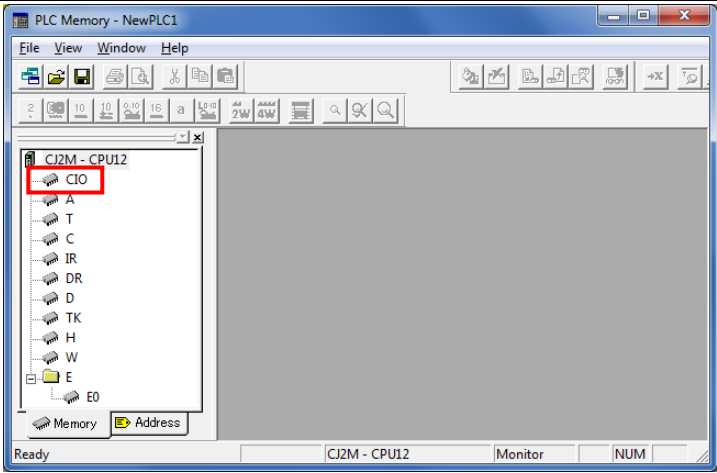

(PLC Memory Window)

3 Enter **5500** in the Start Address Field on the displayed CIO Window. Confirm that the start address was changed to **CIO 5500**.

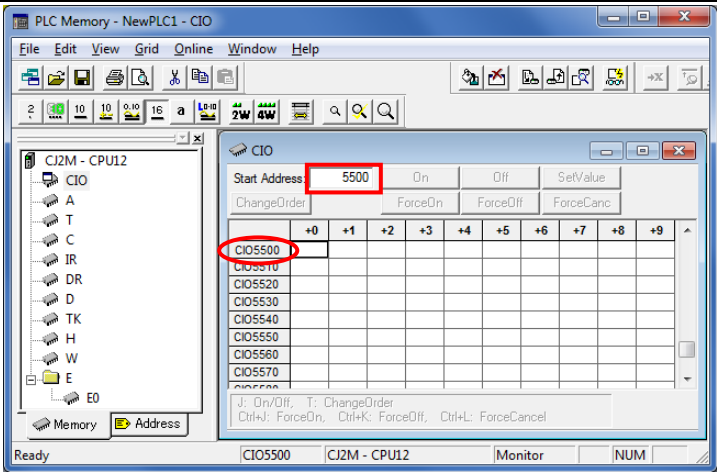

4 Select **Monitor** from the Online Menu.

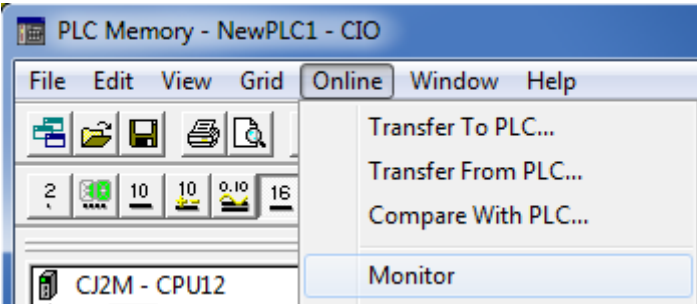

5 The Monitor Memory Areas Dialog Box is displayed. Select the *CIO* Check Box and click the **Monitor** Button.

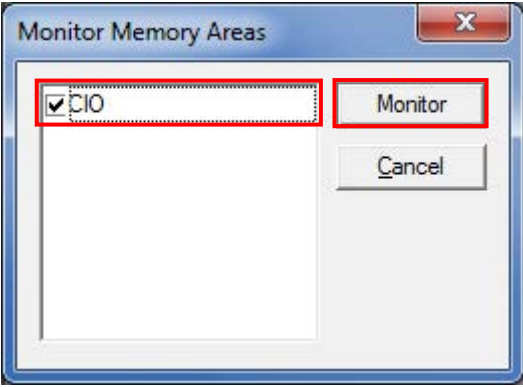

6 On the CIO Window shown on the right, check the received data (code that was read).

* In the example on the right, the data stored from CIO 5501 is 3439 3132 3334 3536 3738 3930 3400 in hexadecimal (4912345678904 in string). It is the same as the trace data in step 3 of Section 7.4.3.

* The number of used words (0008 in hexadecimal) is stored in CIO 5500. The code data that were read are stored from CIO 5501 to CIO 5507.

* Refer to 9.2.2. *PMCR Instruction Operand Settings* for details.

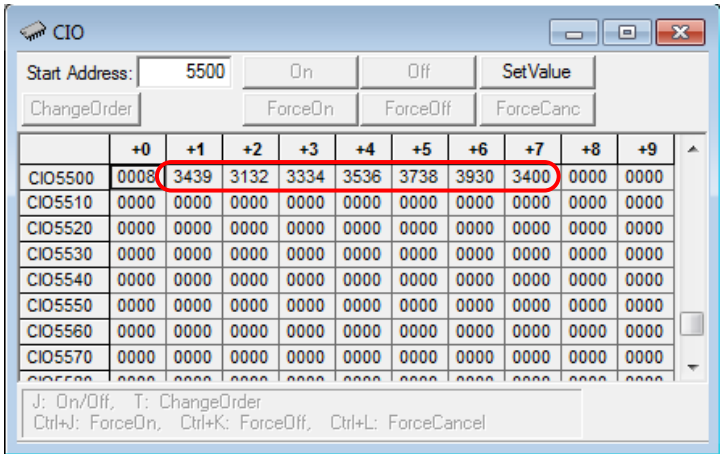

* The data display can be changed from hexadecimal to text by selecting **Display - Text** from the View Menu.

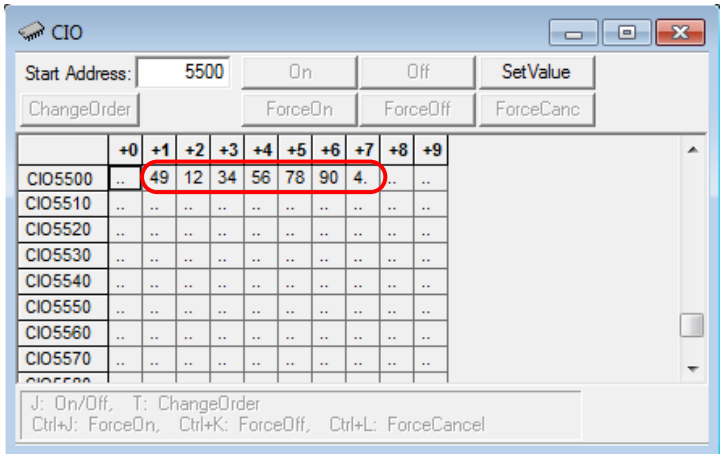
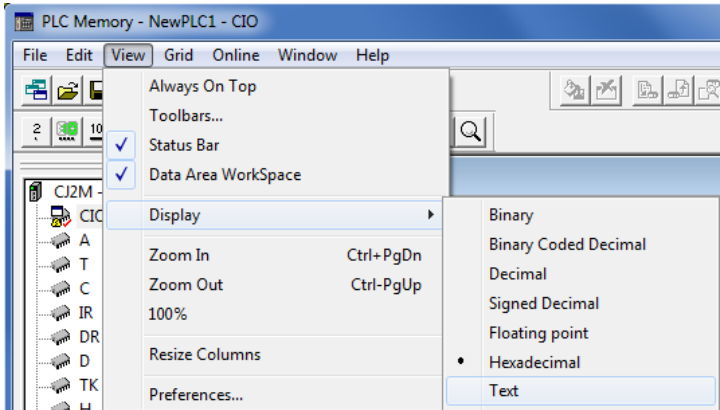

8. Initialization Method

This document explains the setting procedure from the factory default setting.

Some settings may not be applicable as described in this document unless you use the devices with the factory default setting.

8.1. Initializing the PLC

To initialize the PLC, it is necessary to initialize the Serial Communications Unit and the CPU Unit. Change to PROGRAM mode before initialization.

8.1.1. Serial Communications Unit

To initialize the settings of the Serial Communications Unit, select **Edit - I/O Table** and **Unit Setup** from the PLC Menu of the CX-Programmer.

On the PLC IO Table Dialog Box, right-click the Serial Communications Unit and select **Unit Setup** from the menu that is displayed.

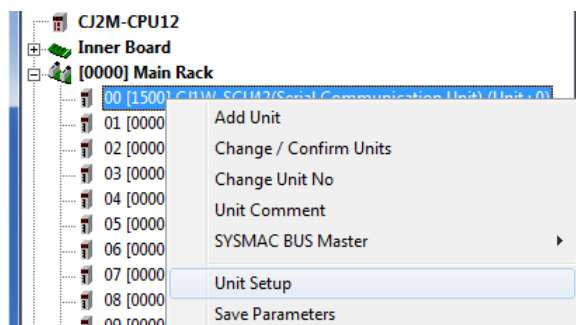

On the View Parameters Dialog Box, click the **Set Defaults** Button, and click the **Transfer (PC to Unit)** Button.

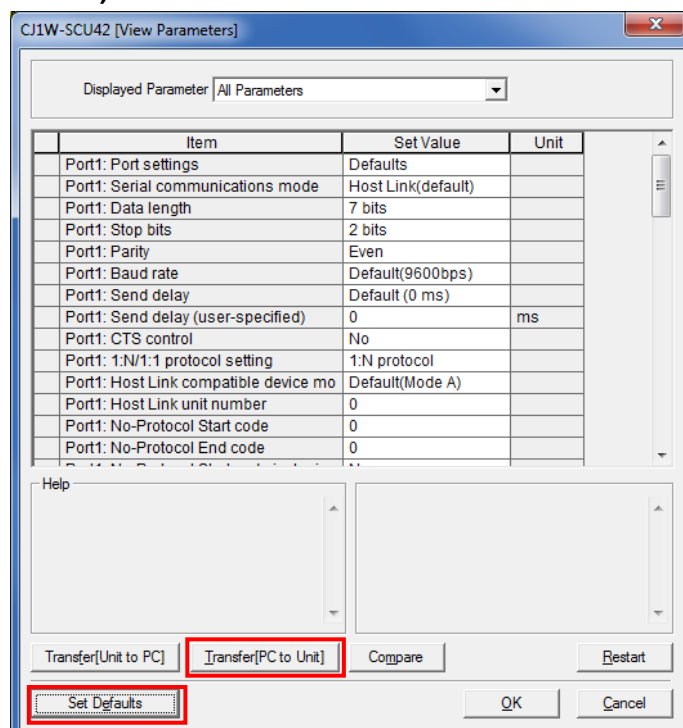

8.1.2. CPU Unit

To initialize the settings of the CPU Unit, select **Clear All Memory Areas** from the PLC Menu of the CX-Programmer. On the Confirm All Memory Area Clear Dialog Box, select the *Initialize* Option and click the **OK** Button.

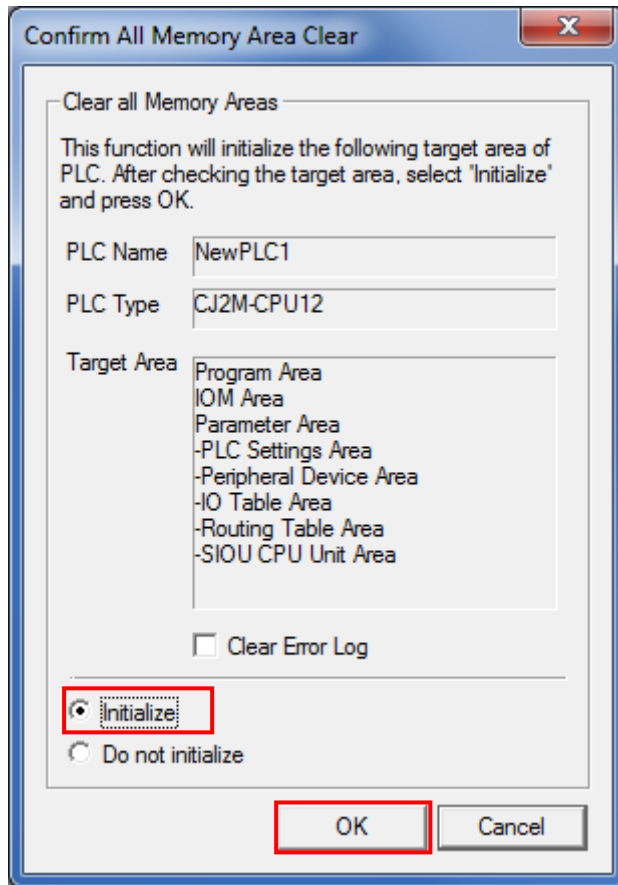

8.2. Initializing the Code Reader

For the initialization of the Code Reader, refer to *Return to the factory default setting* in *Menu Sheet/Command List* in *Section 4 Setting Method of the Ultra Small Multi-code Reader V400-R2 Series User's Manual* (Cat. No. Z333).

9. Program

This section describes the details on the program and the protocol macro data used in this document.

9.1. Overview

This section explains the specifications and functions of the program and the protocol macro data that are used to check the connection between the Code Reader (hereinafter referred to as the Destination Device) and the PLC (Serial Communications Unit) (hereinafter referred to as the SCU).

This program and protocol macro data use the protocol macro function of the SCU to send/receive the Reading Trigger command to/from the Destination Device and to detect whether the operation ends normally or ends in an error.

A normal end of this program means a normal end of the communications sequence of the protocol macro.

An error end means an error end of the communications sequence of the protocol macro.

In this section, the "&" prefix is added to decimal data and the "#" prefix is added to hexadecimal data when it is necessary to distinguish between decimal and hexadecimal data. (e.g., "&1000" for decimal data and "#03E8" for hexadecimal data)



Additional Information

OMRON has confirmed that normal communications can be performed using this program and protocol macro data under the OMRON evaluation conditions including the test system configuration, version and product lot number of each device which was used for evaluation. OMRON does not guarantee the normal operation under the disturbance such as electrical noise or the performance variation of the device.

9.1.1. Communications Data Flow

The following figure shows the data flow from when the PLC (SCU) issues command data via serial communications to the Destination Device until when it receives the response data from the Destination Device.

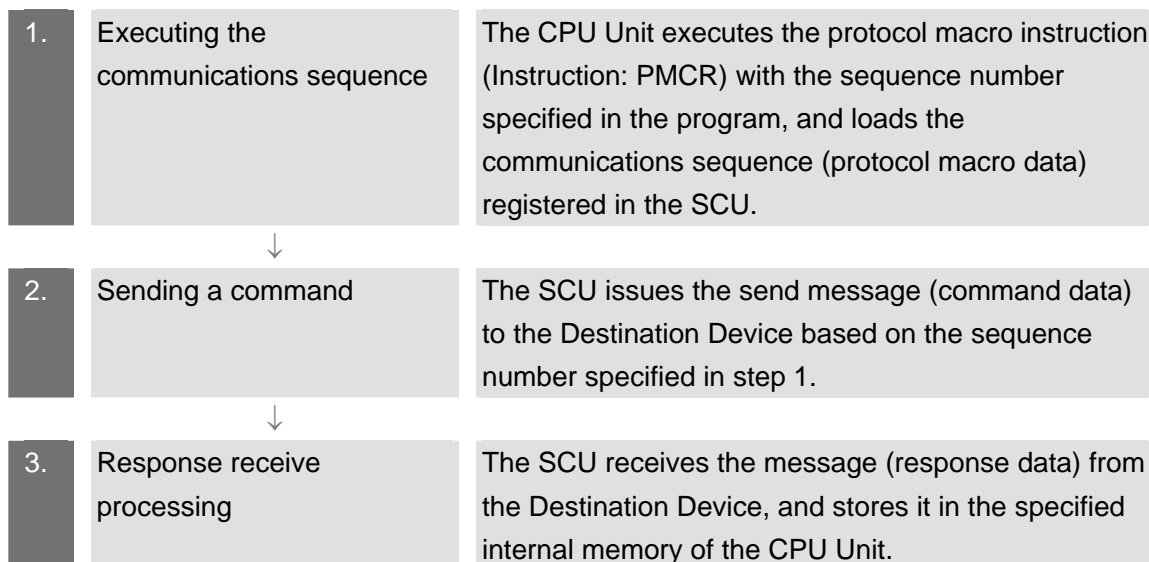

9.1.2. PMCR Instruction and Send/Receive Message

This section explains the protocol macro instruction (Instruction: PMCR, hereinafter referred to as the PMCR instruction) and outlines the general operation of the send/receive messages.



Additional Information

Refer to *Serial Communication Instructions (PMCR)* in *Section 3 Instructions of the CJ Series Instructions Reference Manual (Cat. No. W474)* for details.

• PMCR instruction operand data

Instruction	Mnemonic	Variations	Function code	Function
PROTOCOL MACRO	PMCR	@PMCR	260	Starts a communications sequence (protocol data) that is registered in a Serial Communications Board (CS Series only) or Serial Communications Unit.

PMCR	
Symbol	

[C1: Control word]

Set the following 3 items for the SCU.

- Communications port No. (internal logical port): #0 to #7
- Serial port number (physical port): #1 or #2 (#1: PORT1, #2: PORT2)
- Unit address of Destination Device: # unit number + #10

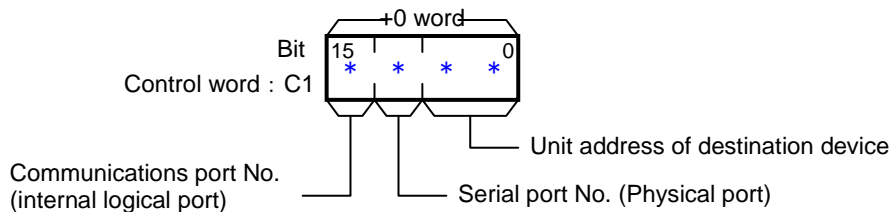

[C2: Control word]

Set the communications sequence number that is registered as the protocol macro data. For information on the sequence number registered in this protocol macro data, refer to 9.2.1 Communications Sequence Number.

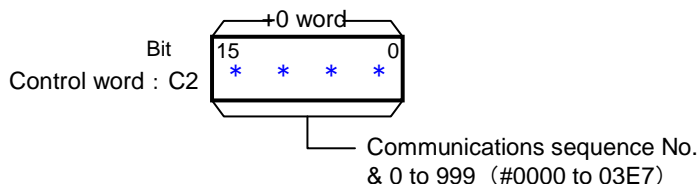

[S: First send word (send area specification)]

Set the number of words (n) to send. (Including S word)

Between #0000 and #00FA (&0 and &250) words can be set.

Enter the send data in the words from S+1 to S+(n-1).

If there is no operand specified in the execution sequence, such as a direct or linked word, set constant #0000 for S.

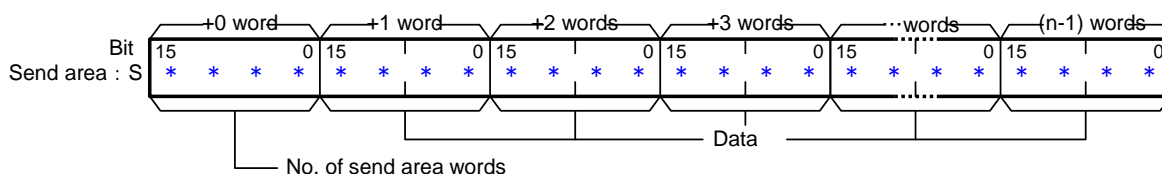

[R: First receive word (receive area specification)]

The number of the received data words (m) is automatically stored in R. (Including R word)

The received data is stored in the words from R+1 to R+(m-1). (m=&0 to &250 or #0000 to #00FA)

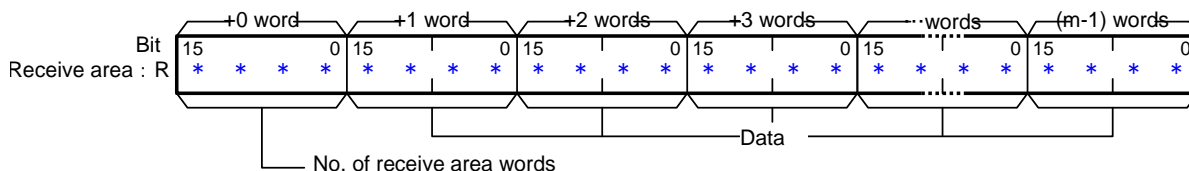

•Send/Receive messages

[Overview of send/receive messages]

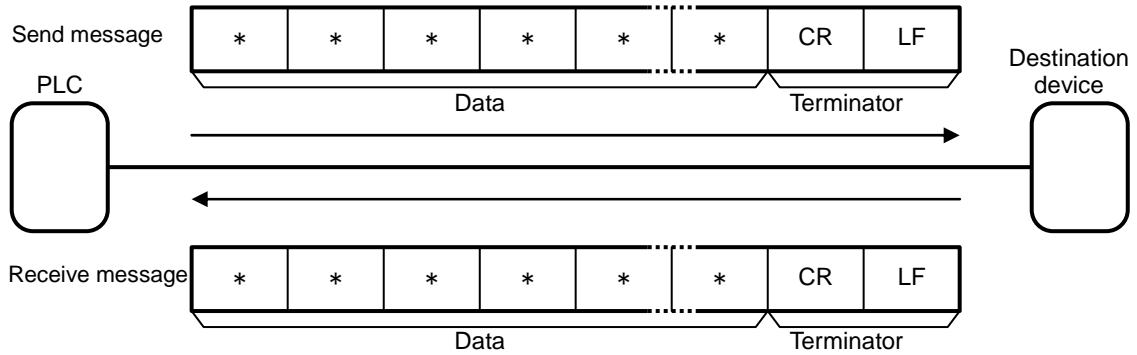

[Relationship between send area S (PMCR instruction operand) and send message]

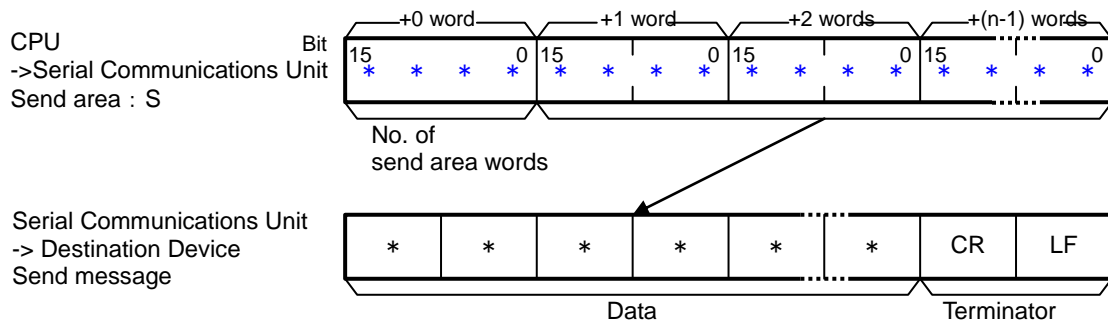

[Relationship between receive message and receive area R (PMCR instruction operand)]

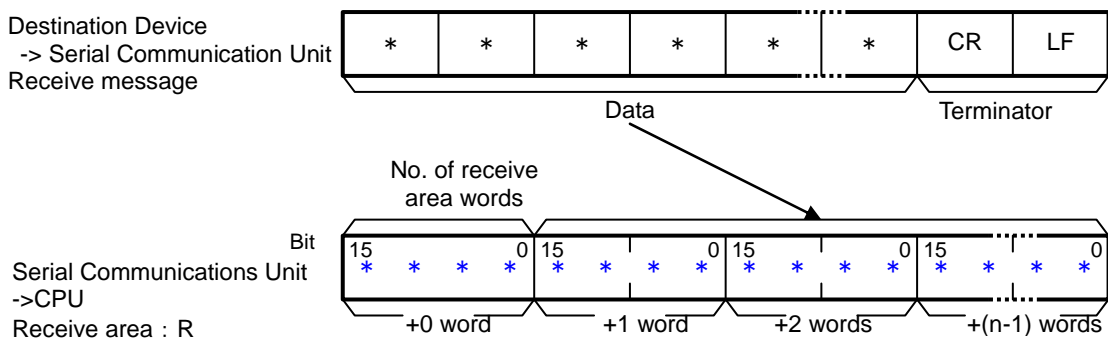

9.2. Communications Sequence

This section explains the communications sequence (protocol macro data) that can be used for the PMCR instruction of this program.

9.2.1. Communications sequence No.

A communications sequence (protocol macro data) that is registered in the SCU is identified by a communications sequence number. The PLC executes the corresponding command on the Destination Device by specifying a communications sequence number in PMCR instruction.

This protocol macro data includes the following communications sequence.

No.	Command name	Description
900	Reading Trigger	Issues the reading trigger for a code.

9.2.2. PMCR Instruction Operand Settings

The PMCR instruction operands of Reading Trigger (Communications sequence No. 900) are shown below.

•Control word C1 settings (C1: CIO 5010)

CH	Description (data type)	Data (explanation)
C1	Communications port No. (1 digit hex)	#7210 (Communications port No. 7, Serial port No.2, #Unit number + #10)
	Serial port No. (1 digit hex)	
	Unit address of Destination Device (2 digit hex)	

•Control word C2 setting (C2: CIO 5011)

CH	Description (data type)	Data (explanation)
C2	Communications sequence No.	&900 (Reading Trigger)

•Control word S settings (S: CIO 5020)

CH	Description (data type)	Data (explanation)
S	Number of words of send data (4-digit hex)	#0000: (Specifies that no parameter is required for the command.)

•Control word R settings (R: CIO 5500)

CH	Description (data type)	Data (explanation)
R	Number of words of receive data (4-digit hex)	Receive data. Setting is unnecessary.
R+1	Receive data [0] (4-digit hex)	
R+2	Receive data [1] (4-digit hex)	
R+3	Receive data [2] (4-digit hex)	
:	:	
R+250	Receive data [249] (4-digit hex)	

9.3. Error Detection Processing

This program detects and handles the errors (1) to (3) below. For information on error codes, refer to 9.8 *Error Process*.

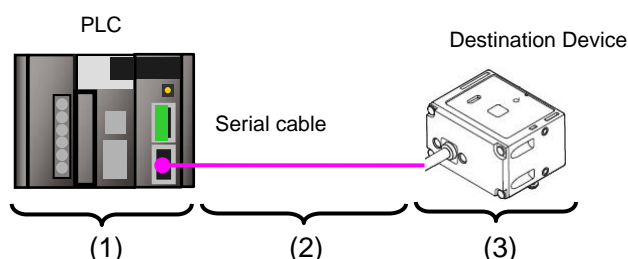

(1) Errors when executing the PMCR instruction (PMCR instruction error)

An incorrect sequence number and an incorrect memory address which prevent the execution of the PMCR instruction are detected as PMCR instruction errors. An error can be detected with error codes (1519.00 to 03) of the Port Operating Status in the CIO area allocated to the SCU.

(2) Errors when communicating with Destination Device (Communications error)

Errors that occur in communications with the Destination Device, such as character corruption and transmission errors caused by unmatched baud rate settings, are detected as "communications errors". The error can be detected with the Transmission Error Flag (1518.15) of Transmission Error Status in the CIO area allocated to the SCU.

(3) Errors in the Destination Device (Destination device errors)

Destination device errors include a command error, a parameter error, data error, and an execution failure in the Destination Device. An error is detected with the response data which is returned from the Destination Device. With this program, the Destination Device does not send a response when an error occurs. Therefore, this error is detected as a timeout error described in (2).



Additional Information

For information on the CIO area allocated to the SCU, refer to 9.4.2 *List of Fixed Allocations*.

9.4. Memory Maps

This section shows the memory maps of this program.

9.4.1. Lists of Addresses

The tables below list the addresses necessary to execute this program.

You can change the allocation below to any addresses.



Precautions for Correct Use

Make sure there is no duplicated address when changing the addresses.

● Input addresses

These addresses are used to operate this program.

Address	Data type	Symbol name	Explanation
5000.00	BOOL	Input_Start	When this flag changes from OFF to ON, the program starts.

● Output addresses

The execution results of the program are stored in these addresses.

Address	Data type	Symbol name	Explanation
5000.02	BOOL	Output_NormalEnd	Turns ON when the program ends normally.
5000.03	BOOL	Output_ErrorEnd	Turns ON when one or more of the following errors occur. (1) PMCR instruction error (2) Communications error (3) Destination device error
5501 to 5750	WORD	Read code value	Stores the read code value that were received from the Destination Device. 250 words are secured.
H400	UINT	Output_PMCR_ErrorCode	Stores the error code when a PMCR instruction error or communications error occurs.

●Internal addresses

These addresses are used to operate this program only.

Address	Data type	Symbol name	Explanation
5000.01	BOOL	Local_PMCRExecuting	Indicates the PMCR instruction execution status. Turns ON when the PMCR instruction is being executed, and turns OFF when the PMCR instruction is not executed.
5000.04	BOOL	Local_PMCRNormalEnd	Turns ON when the PMCR instruction ended normally.
5000.05	BOOL	Local_PMCRErrorEnd	Turns ON when a communications error (e.g., transmission error) occurs.
5000.07	BOOL	Local_PMCRErrorCode	Turns ON when any of the following PMCR instruction errors occurs. (1) Sequence No. error (2) Symbol specification area exceeded error (3) Protocol macro syntax error
5010	UINT	Local_ControlWord1	Execution parameter of PMCR instruction.
5011	UINT	Local_ControlWord2	Execution parameter of PMCR instruction.
5012	UINT	Local_PMCR_ErrorCode	Stores the error code when a PMCR instruction error occurs.
5020	UINT	Local_FirstSendWord	Sets the number of send message words of the PMCR instruction.
5500	UINT	Local_FirstReceiveWord	Stores the number of message words received from the Destination Device.

9.4.2. List of Fixed Allocations

The tables below list the addresses necessary to execute this program.

- Allocated CIO area

They are the fixed addresses determined by the unit address (unit number) that is set for the SCU. Therefore, you must not change these allocations.

Unit number 0 is used in this program.

Address	Data type	Symbol name
1518.15	BOOL	TransmissionError_SCU_0_P2
1518	WORD	TransmissionErrorStatus_SCU_0_P2
1519.10	BOOL	SequenceAbortCompletion_SCU_0_P2
1519.11	BOOL	SequenceEndCompletion_SCU_0_P2
1519.15	BOOL	ProtocolMacroExecuting_SCU_0_P2
1519	UINT	ProtocolMacroErrorCode_SCU_0_P2



Additional Information

For details on the CIO area allocated to the SCU, refer to *Section 2-3-2 CIO Area of the CJ-series Serial Communications Boards and Serial Communications Units Operation Manual* (Cat. No. W336).

- Related auxiliary area

The addresses of the following related auxiliary area are determined by the communications port (internal logical port) specified in the program (PMCR operand). Therefore, you must not change these allocations.

This program uses communications port (internal logical port) No. 7.

Address	Data type	Symbol name
A202.07	BOOL	CommPortEnabledFlag_P7



Additional Information

For information on related auxiliary area for the PMCR instruction, refer to *Related Auxiliary Area Words and Bits in Serial Communications instructions (PMCR)* in *Chapter 3 Instructions of the CJ series Instructions Reference Manual* (Cat. No. W474).

9.5. Ladder Program

9.5.1. Functional Components of the Ladder Program

The functional components of this program are shown below.

Major classification	Minor classification	Description
1. Initialization processing	1.1. Response code clear 1.2. Operand setting for PMCR instruction 1.3. Send/Receive symbol setting	The area to use is cleared and the initialization setting is performed as a preparation for communications.
2. PMCR instruction execution management	2.1. PMCR instruction executing 2.2. PMCR instruction execution processing 2.3. Normal/Error detection processing	The communications sequence (protocol macro data) registered in the SCU is identified and executed. A normal end or an error end is detected based on the related flags and receive data.
3. Normal end state management	3.1. Normal end processing 3.2. Response code setting	The normal completion flag is turned ON. The response code for a normal end is set.
4. Error end state management	4.1. Error end processing 4.2. Response code setting	The error end flag is turned ON. The response code corresponding to the error cause is set.

9.5.2. Detailed Description of Each Functional Component

This section shows the program.

•1. Initialization processing

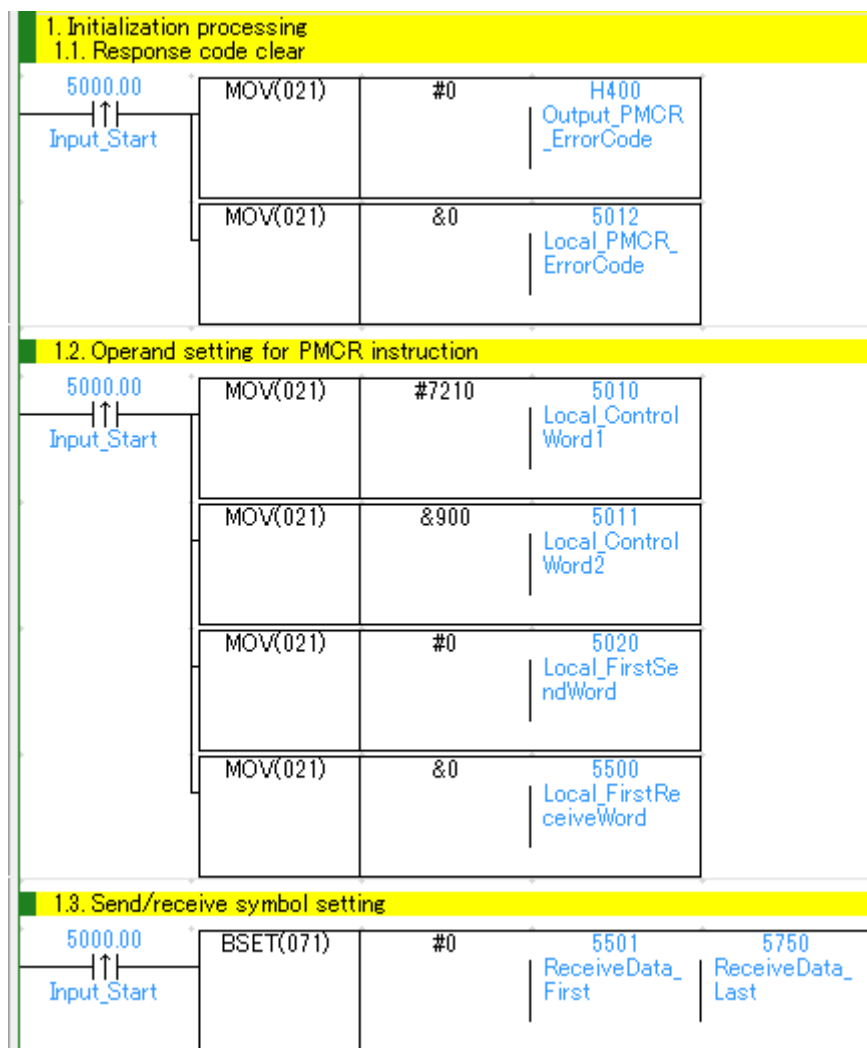

No.	Overview	Description
1.1.	Response code clear	Clears the error code storage area to 0.
1.2.	Operand setting for PMCR instruction	Sets the PMCR execution parameters (operands).
1.3.	Send/Receive symbol setting	Initializes the receive data storage area.

●2. PMCR instruction execution management

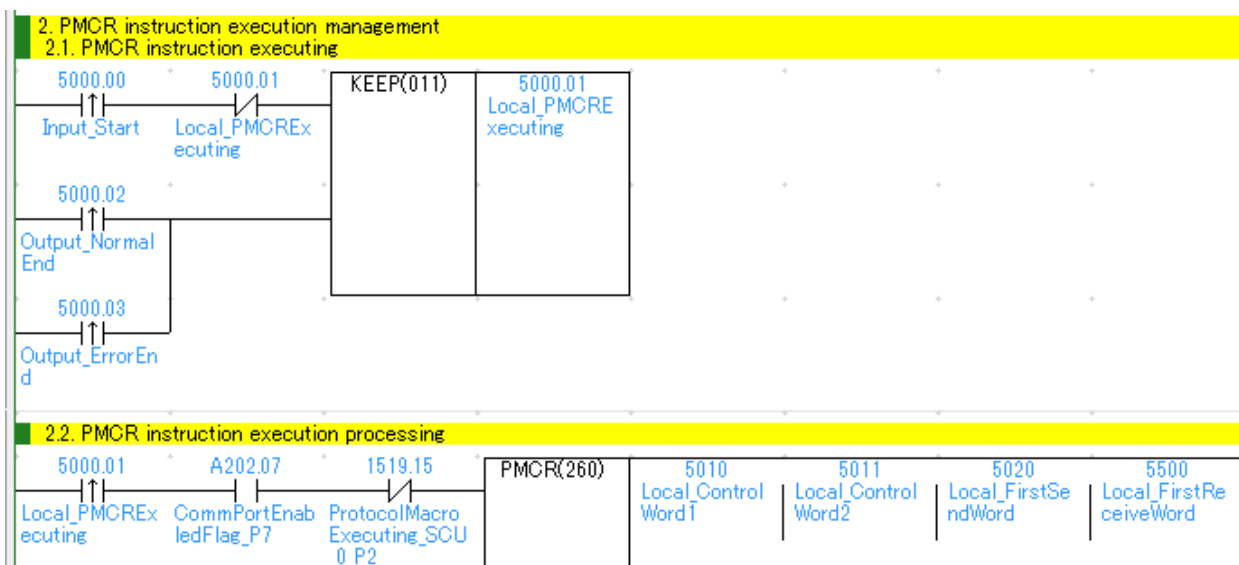

No.	Overview	Description
2.1.	PMCR instruction executing	Enters the PMCR instruction executing status. The executing state is reset at a normal end or an error end of the program.
2.2.	PMCR instruction execution processing	The PMCR instruction is executed under the following conditions. -Communications port No.7 can be used. -The PMCR instruction is not being executed.



Precautions for Safe Use

Make sure to sufficiently check the overall program before specifying the area to save the receive data of the PMCR instruction. Or, data may be written to an unintended memory area.



Precautions for Correct Use

This program uses communications port (internal logical port) No.7.
Do not use communications port No.7 for other purpose. If you have no choice but to use communication port No. 7, confirm that the Communications Port Enabled Flag (A202.07) is ON.

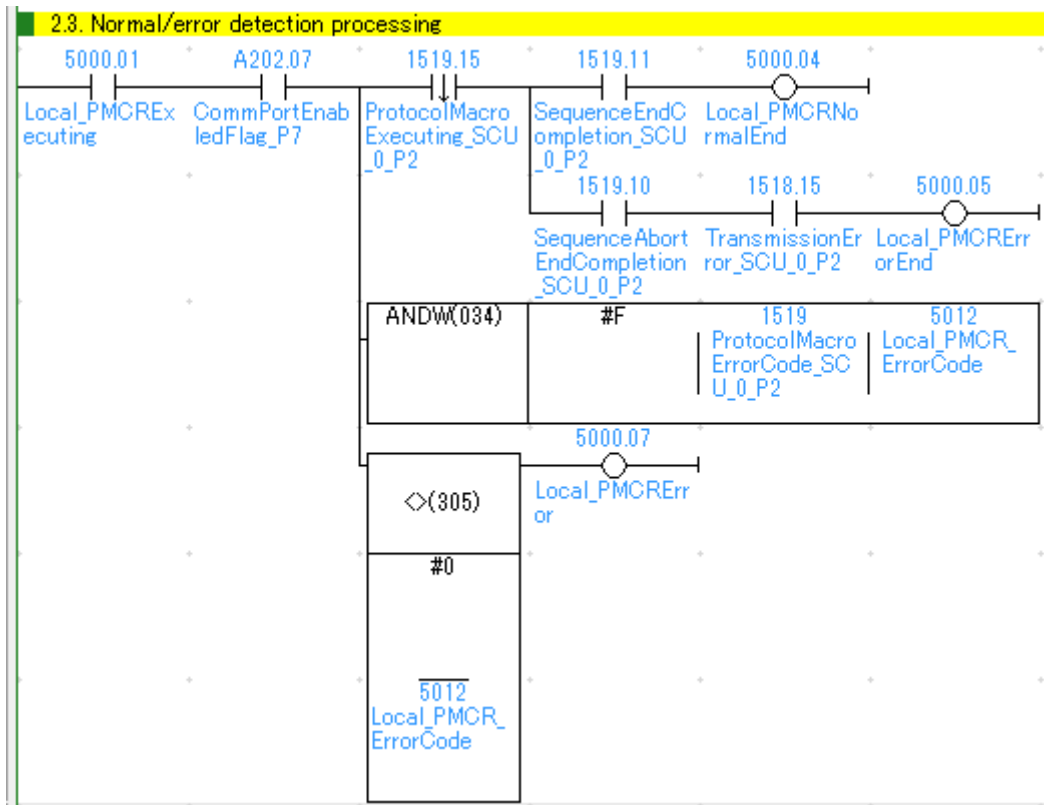

No.	Overview	Description
2.3.	Normal/Error detection processing	<p>Detects a normal end or error end of the program execution.</p> <p>It is identified as a normal end when all the following conditions are satisfied.</p> <p>(1) Normal end of PMCR instruction (No PMCR instruction error)</p> <p>(2) Normal end of communications sequence (No communications error)</p> <p>If any of the above errors occurs under the conditions above, the corresponding error flag will turn ON.</p>

●3. Normal end state management

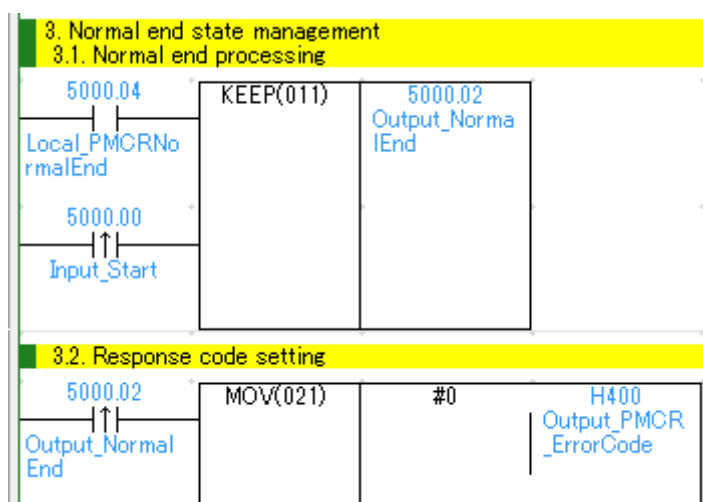

No.	Overview	Description
3.1.	Normal end processing	Turns ON the normal end flag if it is detected in 2.3 Normal/Error detection processing that the program ends normally.
3.2.	Response code setting	Sets response code "#0000" for a normal end in the response code storage area.

●4. Error end state management

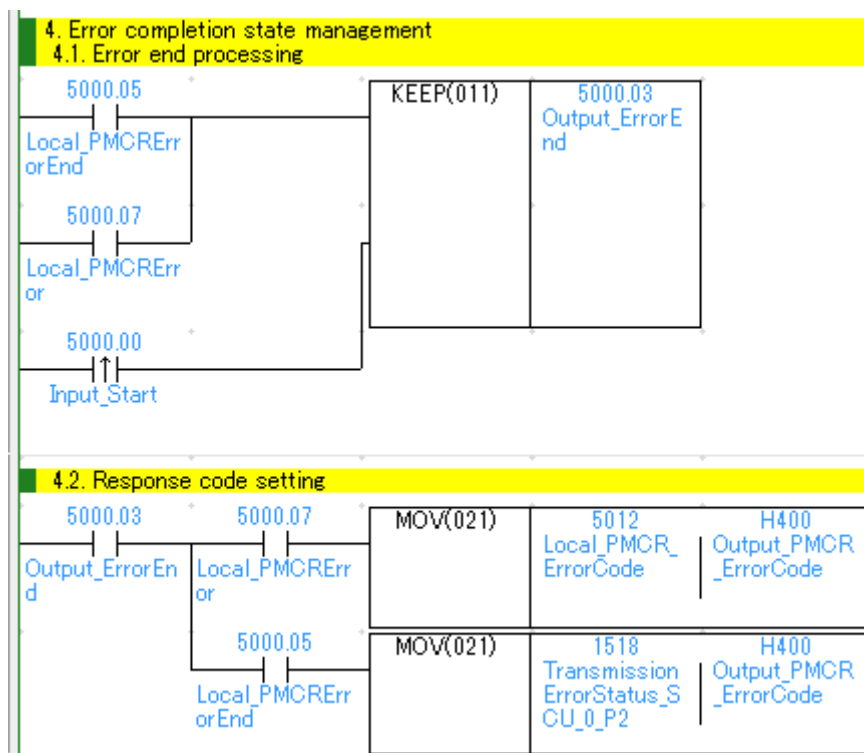

No.	Overview	Description
4.1.	Error end processing	Turns ON the error end flag if it is detected in 2.3 Normal/Error detection processing that the program ends in an error.
4.2.	Response code setting	Sets the response code corresponding to the error in the response code storage area when an error occurs.



Additional Information

Refer to 9.8 Error Process in this document for details on the response codes.

9.6. Protocol Macro Data

Protocol macro data consists of sequence, step, send/receive message, and matrix. Its composition is described as follows:

- When there is only one receive message format for a step (send/receive once)
 - Set one send message and one receive message for the step

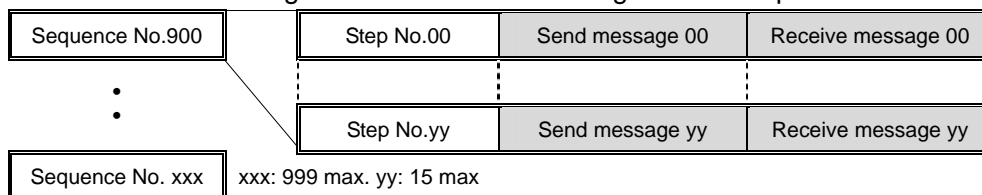

- When there are several types of receive message formats for a step (send/receive once)
 - Set the send message and matrix for the step
 - Set several types of cases (receive messages) for the matrix

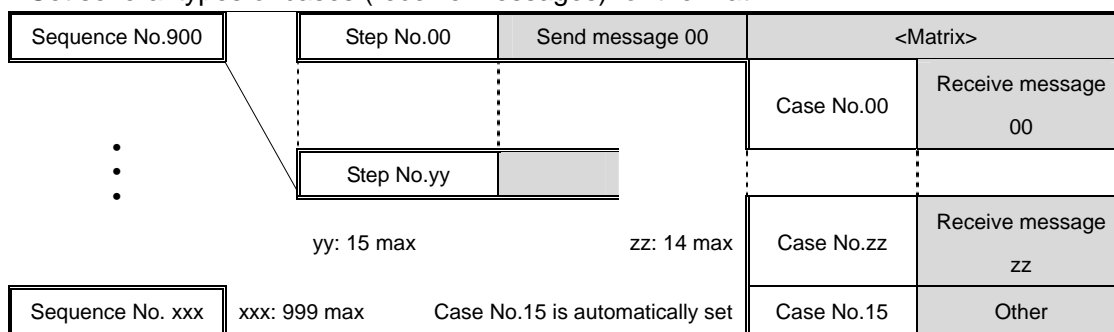

9.6.1. Composition of Protocol Macro Data

In this protocol macro data, there is only 1 type of receive message (SD_RDCODE) for the send message (SD_RDCODE). Therefore, the following composition is used without using the matrix. Refer to 9.6.6. *Receive Message Settings* for details.



9.6.2. Protocol Macro Processing Procedure

This section describes the processing procedure of the protocol macro.

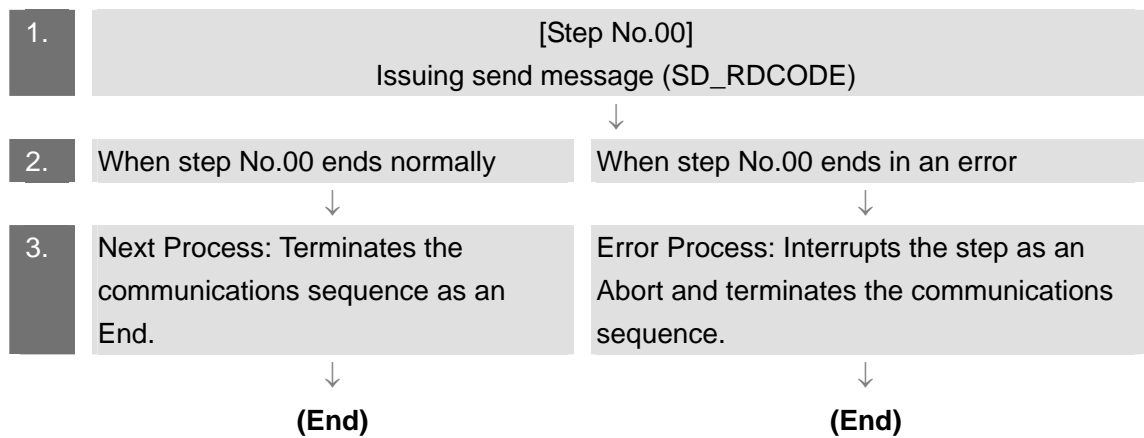

9.6.3. Sequence Settings

This protocol macro data performs Reading Trigger (read code) by using communications sequence No. 900. Set the timeout periods for the communications sequence.



Additional Information

Refer to *3-2 Sequence Attributes (Common to All Steps) of the CX-Protocol Operation Manual (Cat. No. W344)* for details on sequence settings.

- Timeout period setting

The following is the settings of the timeout periods (Timer Tr, Tfr, and Tfs) which are set for the sequence.

[Communications sequence setting screen]

#	Communication Sequence	Link Word	Control	Response	Timer Tr	Timer Tfr	Timer Tfs
900	New Sequence	---	Set	Scan	3 sec	3 sec	3 sec

<Settings>

Item	Description	Explanation
Timer Tr	Receive wait monitoring time	Monitors the time from the receive wait status to receiving the first data (header) in the step of the sequence. This timer is set to 3 seconds in this protocol macro data.
Timer Tfr	Receive finished monitoring time	Monitors the time from receiving the first data to the completion of the receiving in the step of the sequence. This timer is set to 3 seconds in this protocol macro data.
Timer Tfs	Send finished monitoring time	Monitors the time from the sending of the header to the sending of the last data. This timer is set to 3 seconds in this protocol macro data.



Additional Information

Refer to *Section 4-5 Calculation Method of Monitoring Time of the CX-Protocol Operation Manual (Cat. No. W344)* for the calculation method of monitoring time.

9.6.4. Step Settings

This section describes the step settings for communications sequence No. 900. The settings include retry count, send/receive messages (message names), next process, and error process. The sequence of this protocol macro data includes Step No.00 only.



Additional Information

Refer to 3-3 Step Attributes of the CX-Protocol Operation Manual (Cat. No. W344) for details on step settings.

- Retry count setting

This section describes the retry count setting for the step. The step is retried for the specified number of times (0 to 9 times) when an error occurs. If an error occurs after retries, the step moves to the error process.

The retry count is enabled for the Send&Receive command only.

<Step setting screen>

* Step	Repeat	Command	Retry	Send Wait	Send Message	Recv Message	Response	Next	Error
00	RSET/001	Send & Receive	3	---	SD_RDCODE	RV_RDCODE	YES	End	Abort

<Settings>

Step No.	Retry count
00	3

- Send/Receive message (message name) settings

This section describes the settings for the send/receive messages of the step. Here, a registered send message name and message name are selected.

<Step setting screen>

* Step	Repeat	Command	Retry	Send Wait	Send Message	Recv Message	Response	Next	Error
00	RSET/001	Send & Receive	3	---	SD_RDCODE	RV_RDCODE	YES	End	Abort

<Settings>

Step No.	Send message	Receive message
00	SD_RDCODE	RV_RDCODE

- Next process and error process settings

This section describes the settings for the next process and error process of the step. The process set in the Next Column is executed when the step execution ends normally. If a communications error occurs, the process set in the Error Column is executed.

<Step setting screen>



Step	Repeat	Command	Retry	Send Wait	Send Message	Recv Message	Response	Next	Error
00	RSET/001	Send & Receive	3	---	SD_RDCODE	RV_RDCODE	YES	End	Abort

<Settings>

Step No.	Next process	Error process
00	End	Abort

<Process list>

Process.	Description
End	Ends the communications sequence.
Next	Moves to the next step No.
Abort	Interrupts the step and ends the communications sequence.
Goto	Moves to the specified step number.
Matrix	Uses the settings of the matrix.

9.6.5. Send Message Settings

This section explains the settings of the send message.



Additional Information

Refer to *3-4 Communication Message Attributes of the CX-Protocol Operation Manual (Cat. No. W344)* for details on send message settings.

<Send message setting screen>

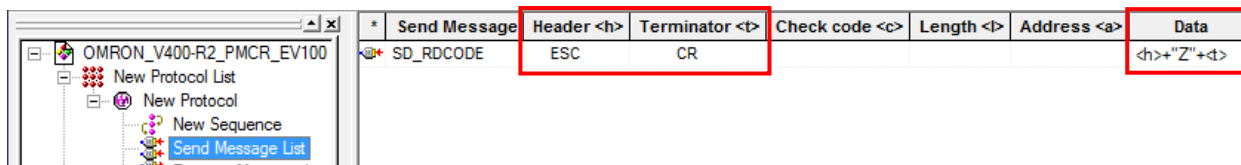

- Settings of SD_RDCODE send message

<Settings>

<h>+\"Z\"+<t>
 (1) (2) (3)

No.	Code	Description
(1)	<h >(Header)	Message data: Constant hex, Type: Code, Data: ESC
(2)	"Z"	Message data: Constant ASCII
(3)	<t>(Terminator *)	Message data: Constant hex, Type: Code, Data: CR

* The footer for the Destination Device is the terminator for the protocol macro data. Hereinafter, the term "terminator" is used.

<Send message command format>

This is the command format of the message that is sent from the SCU to the Destination Device according to the settings of SD_RDCODE.

<ESC>	"Z"	<CR>
-------	-----	------

Command	Number of bytes	Description
Header	1	Fixed: <ESC> (#1B)
"Z"	1	Fixed: "Z" (#5A) (Reading Trigger command)
Terminator	1	Fixed: <CR> (#0D)

9.6.6. Receive Message Settings

This section describes the settings of the receive message.



Additional Information

Refer to *3-4 Communication Message Attributes of the CX-Protocol Operation Manual (Cat. No. W344)* for details on receive message settings.

[Receive message setting screen]

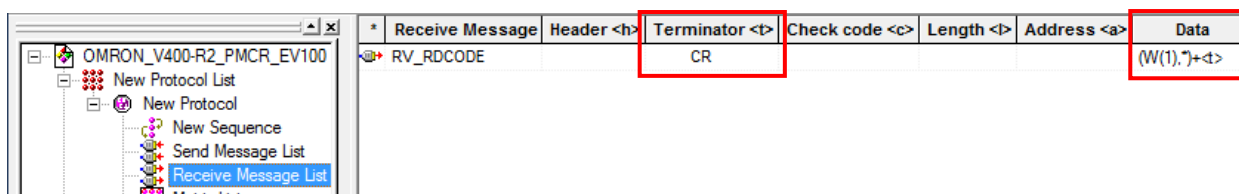

•Setting of receive message RV_RDCODE

<Settings>

(W(1),*)+<t>

(1) (2)

No.	Code	Description
(1)	(W(1),*)	Message data: Symbol All variable length data are read and stored from the first receive word, which is specified with the operand of the PMCR instruction, + 1 word. (With this program, data is stored from 5501.)
(2)	<t>(Terminator)	Message data: Constant hex, Type: Code, Data: CR

* The header <h> is set to None.

<Response format of receive message>

This is the response format of the receive message which is received by the SCU from the Destination Device according to the settings of RV_RDCODE.

Read code value	<CR>
-----------------	------

Command	Number of bytes	Remarks
Data	Variable length	Variable: Read code value
Terminator	1	Fixed: <CR> (#0D)

9.7. Timing Charts

The timing charts of the program are shown below.

The definitions of the timing chart patterns are as follows:

Pattern	Normal end	Error end (1) PMCR instruction error	Error end (2) Protocol macro error
Command	Normal	Error	Error
Destination Device	Normal	Normal or error	Normal or error
Response	Yes	None	None

●Normal end

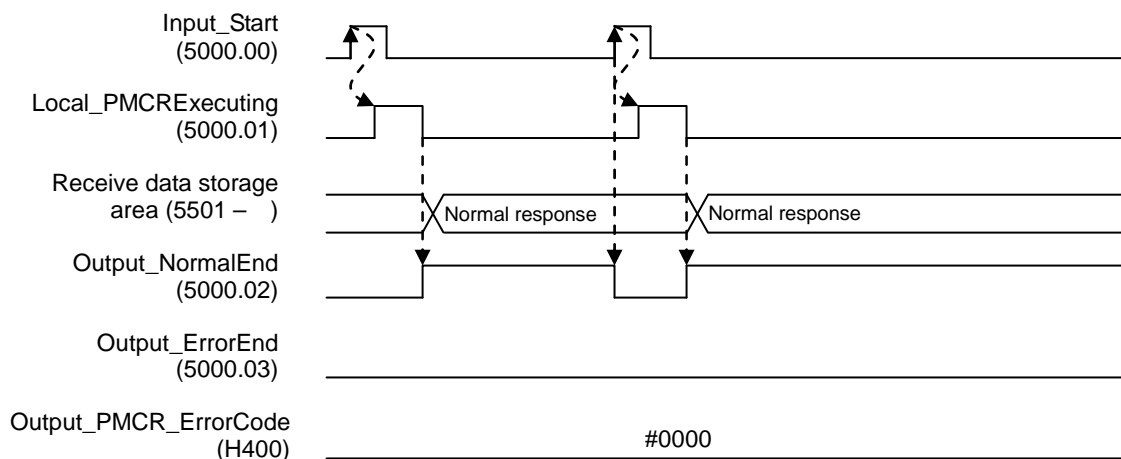

●Error end

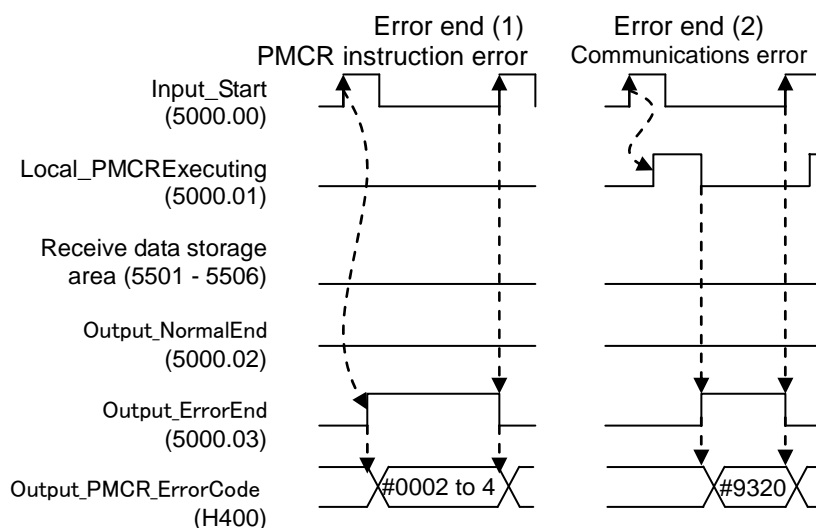

9.8. Error Processing

The following tables list the errors that occur during executing this program.

9.8.1. Protocol Macro Error Codes

The SCU detects these errors by monitoring the macro operations.

The error codes are stored in H400 (Symbol name: Output_PMCR_ErrorCode).

[Error code list]

Error code	Name
#0000	There are no errors
#0002	Sequence No. error
#0003	Symbol specification area exceeded error
#0004	Protocol macro syntax error



Additional Information

For details and troubleshooting of the protocol macro errors, refer to *12-3 Troubleshooting of the CJ Series Serial Communications Boards and Serial Communications Units Operation Manual* (Cat. No. W336).

9.8.2. Transmission error status

The error flags used when a transmission error occurs are shown below.

The error codes are stored in H400 (Symbol name: Output_PMCR_ErrorCode).

[Transmission error status]

Bit	Description
15	1:Transmission error 0:No transmission error
14	1:Send Finished Monitoring Time Exceeded 0:Normal
13	1:Receive Finished Monitoring Time Exceeded 0:Normal
12	1:Receive Wait Monitoring Time Exceeded 0:Normal
8 to 11	Retry count
7	1:FCS Check Error 0:Normal
6	1:Command Error 0:Normal
5	1:Timeout 0:Normal
4	1:Overrun error 0:Normal
3	1:Framing error 0:Normal
2	1:Parity error 0:Normal
0 and 1	(Not used)



Additional Information

For details on the transmission error status and troubleshooting, refer to *12-3 Troubleshooting of the CJ Series Serial Communications Boards and Serial Communications Units Operation Manual* (Cat. No. W336).

10. Revision History

Revision code	Date of revision	Revision reason and revision page
01	Sep. 30, 2013	First edition

OMRON Corporation Industrial Automation Company

Tokyo, JAPAN

Contact: www.ia.omron.com

Regional Headquarters

OMRON EUROPE B.V.

Wegalaan 67-69-2132 JD Hoofddorp
The Netherlands

Tel: (31)2356-81-300/Fax: (31)2356-81-388

OMRON ELECTRONICS LLC

One Commerce Drive Schaumburg,
IL 60173-5302 U.S.A.

Tel: (1) 847-843-7900/Fax: (1) 847-843-7787

OMRON ASIA PACIFIC PTE. LTD.

No. 438A Alexandra Road # 05-05/08 (Lobby 2),
Alexandra Technopark,
Singapore 119967

Tel: (65) 6835-3011/Fax: (65) 6835-2711

OMRON (CHINA) CO., LTD.

Room 2211, Bank of China Tower,
200 Yin Cheng Zhong Road,
PuDong New Area, Shanghai, 200120, China

Tel: (86) 21-5037-2222/Fax: (86) 21-5037-2200

Authorized Distributor:

© OMRON Corporation 2013 All Rights Reserved.
In the interest of product improvement,
specifications are subject to change without notice.

Cat. No. P566-E1-01

0911(-)