

Machine Automation Controller NJ-series

EtherNet/IP™ Connection Guide

OMRON Corporation

FQ2 series Smart Camera

Network
Connection
Guide

About Intellectual Property Right and Trademarks

Microsoft product screen shots reprinted with permission from Microsoft Corporation.

Windows is a registered trademark of Microsoft Corporation in the USA and other countries.

ODVA and EtherNet/IP™ are trademarks of ODVA.

Sysmac is a trademark or registered trademark of OMRON Corporation in Japan and other countries for OMRON factory automation products.

EtherCAT® is registered trademark and patented technology, licensed by Beckhoff Automation GmbH, Germany.

Other company names and product names in this document are the trademarks or registered trademarks of their respective companies

Table of Contents

1. Related Manuals	1
2. Terms and Definitions	2
3. Remarks	3
4. Overview	4
5. Applicable Devices and Support Software	5
5.1. Applicable Devices.....	5
5.2. Device Configuration.....	6
6. EtherNet/IP Settings	8
6.1. EtherNet/IP Communications Settings	8
6.2. Allocation for Tag Data Links.....	9
7. Connection Procedure	13
7.1. Overview of Setting Tag Data Links	13
7.2. Work Flow	14
7.3. Setting Up the Smart Camera	15
7.4. Setting Up the Controller.....	28
7.5. Setting Up the Network	34
7.6. Connection Status Check.....	38
8. Initialization Method	42
8.1. Controller	42
8.2. Smart Camera.....	44
9. Appendix 1 Detailed Settings of the Tag Data Links	45
9.1. Global Variable Table	45
9.2. Relationship between Destination Device and Global Variables	47
9.3. Associating the Tag Data Links	50
10. Appendix 2 Setting Procedure without the Configuration Files	51
10.1. Overview of Setting Procedure without the Configuration Files	51
10.2. Work Flow of "Procedure for Setting Parameters from the Beginning"	52
10.3. Setting Up the Controller without the Configuration Files.....	54
10.4. Setting Up the Network with Network Configurator	66
11. Revision History	76

1. Related Manuals

The table below lists the manuals related to this document.

To ensure system safety, make sure to always read and heed the information provided in all Safety Precautions, Precautions for Safe Use, and Precaution for Correct Use of manuals for each device which is used in the system.

Cat. No.	Model	Manual name
W500	NJ501-□□□□ NJ301-□□□□	NJ-series CPU Unit Hardware User's Manual
W501	NJ501-□□□□ NJ301-□□□□	NJ-series CPU Unit Software User's Manual
W506	NJ501-□□□□ NJ301-□□□□	NJ-series CPU Unit Built-in EtherNet/IP™ Port User's Manual
W504	SYSMAC-SE2□□□□	Sysmac Studio Version 1 Operation Manual
Z326	FQ2 series	FQ2 Smart Camera User's Manual



2. Terms and Definitions

Terms	Explanation and Definition
Tag data link	A function that enables cyclic tag data exchanges on an EtherNet/IP network between Controllers or between Controllers and other devices without using a user program in the Controllers.
Tag	A tag is a unit that is used to exchange data with tag data links. Data is exchanged between the local network variables and remote network variables specified in the tags or between specified I/O memory areas.
Tag set	When a connection is established, from 1 to 8 tags (including Controller status) is configured as a tag set. Each tag set represents the data that is linked for a tag data link connection.
Connection	A connection is used to exchange data as a unit within which data synchronicity is maintained. Thus, data concurrency is maintained for all the data exchanged for a tag or multiple tags in one data set.
Originator and Target	To perform tag data links, one node requests the opening of a communications line called "connection" to exchange data with another node. The node that requests opening the connection is called "originator", and the node that receives the request is called "target".
Node	With an EtherNet/IP network, 1 node is 1 EtherNet/IP port.
Tag data link parameter	The tag data link parameter is the setting data to perform the tag data link. It includes the data to set tags, tag sets, and connections.
EDS file	A file that contains the I/O points of EtherNet/IP devices and the parameters that can be set via EtherNet/IP.

3. Remarks

- (1) Understand the specifications of devices which are used in the system. Allow some margin for ratings and performance. Provide safety measures, such as installing safety circuit in order to ensure safety and minimize risks of abnormal occurrence.
- (2) To ensure system safety, always read and heed the information provided in all Safety Precautions, Precautions for Safe Use, and Precaution for Correct Use of manuals for each device used in the system.
- (3) The user is encouraged to confirm the standards and regulations that the system must conform to.
- (4) It is prohibited to copy, to reproduce, and to distribute a part of or whole part of this document without the permission of OMRON Corporation.
- (5) The information contained in this document is current as of July 2013. It is subject to change without notice for improvement.

The following notation is used in this document.

 WARNING	Indicates a potentially hazardous situation which, if not avoided, will result in minor or moderate injury, or may result in serious injury or death. Additionally there may be significant property damage.
 Caution	Indicates a potentially hazardous situation which, if not avoided, may result in minor or moderate injury or in property damage.



Precautions for Safe Use

Precautions on what to do and what not to do to ensure safe usage of the product.



Precautions for Correct Use

Precautions on what to do and what not to do to ensure proper operation and performance.



Additional Information

Additional information to read as required.

This information is provided to increase understanding or make operation easier.

Symbols



The filled circle symbol indicates operations that you must do.
The specific operation is shown in the circle and explained in text.
This example shows a general precaution for something that you must do.

4. Overview

This document describes the procedure for connecting the Smart Camera (FQ2 series) of OMRON Corporation (hereinafter referred to as OMRON) to the NJ-series Machine Automation Controller (hereinafter referred to as the Controller) on EtherNet/IP and provides the procedure for checking their connection.

Specifically, it describes the procedure for connecting EtherNet/IP using the EtherNet/IP settings of the project file prepared beforehand (hereinafter referred to as the "procedure for using the configuration files").

Section 9 A-1 and Section 10 A-2 describe the procedures for setting parameters without the prepared configuration files (hereinafter referred to as the "procedure for setting parameters from the beginning").

To follow the "procedure for using configuration files", obtain the latest "Sysmac Studio project file" and "Network Configurator v3 network configuration file" (hereinafter referred to as "configuration files") from OMRON in advance.

Name	File name	Version
Sysmac Studio project file (extension: SMC)	OMRON_FQ2_EIP_EV100.SMC	Ver.1.00
Network Configurator version 3 network configuration file (extension: NVF)	OMRON_FQ2_EIP_EV100.NVF	Ver.1.00

5. Applicable Devices and Support Software

5.1. Applicable Devices

The applicable devices are as follows:

Manufacturer	Name	Model
OMRON	NJ-series CPU Unit	NJ501-□□□□ NJ301-□□□□
OMRON	FQ2 series Smart Camera	FQ2-S10□□□□ FQ2-S15□□□□ FQ2-S20□□□□ FQ2-S25□□□□ FQ2-S30□□□□ FQ2-S35□□□□ FQ2-S30□□ FQ2-S35□□



Precautions for Correct Use

As applicable devices above, the devices with the models and versions listed in Section 5.2. are actually used in this document to describe the procedure for connecting devices and checking the connection.

You cannot use devices with versions lower than the versions listed in Section 5.2.

To use the above devices with versions not listed in Section 5.2 or versions higher than those listed in Section 5.2, check the differences in the specifications by referring to the manuals before operating the devices.



Additional Information

This document describes the procedure to establish the network connection. Except for the connection procedure, it does not provide information on operation, installation or wiring method. It also does not describe the function or operation of the devices. Refer to the manuals or contact your OMRON representative.

5.2. Device Configuration

The hardware components to reproduce the connection procedure of this document are as follows:

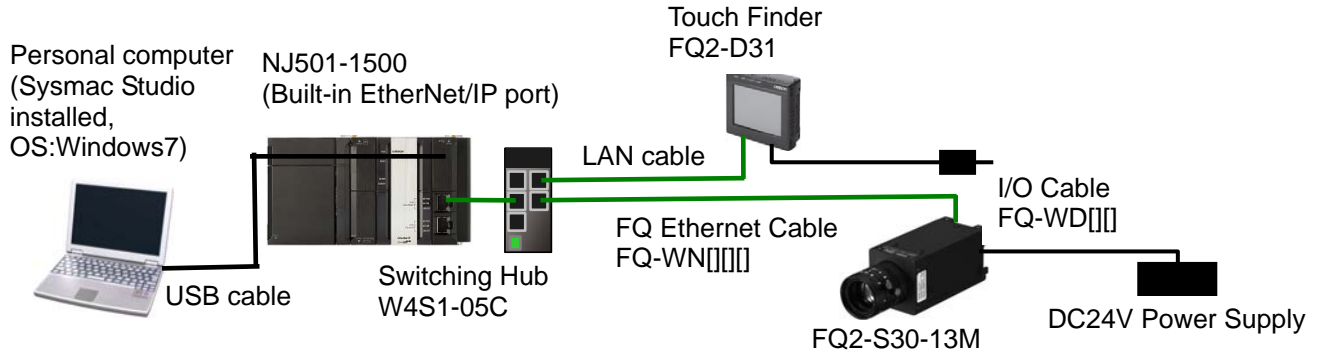

Manufacturer	Name	Model	Version
OMRON	NJ series CPU Unit (Built-in EtherNet/IP port)	NJ501-1500	Ver.1.03
OMRON	Power Supply Unit	NJ-PA3001	
OMRON	Switching Hub	W4S1-05C	Ver.1.0
OMRON	Sysmac Studio	SYSMAC-SE2	Ver.1.04
OMRON	Network Configurator	(Included in Sysmac Studio.)	Ver.3.53
OMRON	Sysmac Studio project file	OMRON_FQ2_EIP_EV10 0.SMC	Ver.1.00
OMRON	Network Configurator version 3 network configuration file	OMRON_FQ2_EIP_EV10 0.NVF	Ver.1.00
-	Personal computer (OS:Windows7)	-	
-	USB cable (USB 2.0 type B connector)	-	
-	LAN cable (Ethernet STP (Shielded twisted-pair) cable of category 5 or higher)	-	
OMRON	Smart Camera (with a C-mount)	FQ2-S30-13M	Ver.1.61
OMRON	Camera lens	3Z4S-LE SV FZ-LEH	
OMRON	I/O Cable	FQ-WD	
OMRON	FQ Ethernet Cable	FQ-WN	
OMRON	Touch Finder (Model with AC/DC/battery power supply)	FQ2-D31	Ver.1.60
OMRON	AC Adapter for Touch Finder (Model with AC/DC/battery power supply)	FQ-AC1	



Precautions for Correct Use

To use the configuration files, obtain the latest "Sysmac Studio project file" and "Network Configurator version 3 network configuration file" from OMRON beforehand.
(To obtain the files, contact your OMRON representative.)



Precautions for Correct Use

Update the Sysmac Studio to the version specified in this section or higher version using the auto update function.

If a version not specified in this section is used, the procedures described in Section 7 and subsequent sections may not be applicable. In that case, use the equivalent procedures described in the Sysmac Studio Version 1 Operation Manual (Cat.No. W504) and Network Configurator Online Help.



Additional Information

In this document, a USB is used to connect with the Controller. For information on how to install a USB driver, refer to *A-1 Driver Installation for Direct USB Cable Connection* in the *Sysmac Studio Version 1 Operation Manual* (Cat.No. W504).

6. EtherNet/IP Settings

This section describes the specifications such as communication parameters and variables that are defined in this document.

Hereinafter, the Smart Camera is referred to as the “destination device” in some descriptions.

6.1. EtherNet/IP Communications Settings

The Controller settings are shown below.

	Controller (node 1)	Smart Camera (node 2)
IP address setting	-	Fixed
IP address	192.168.250.1	192.168.250.2
Subnet mask	255.255.255.0	255.255.255.0 (Default)
Gateway	-	10.5.5.1 (Default)
KeepAlive	Use (Default)	-
Link data output Connection type	-	EtherNet/IP
Output data size	-	32 bytes (Default)

*In this document, the gateway setting is unnecessary because the connection is made in the same segment.

The Touch Finder settings used in 7.6.2 Checking Data That Are Sent and Received are shown below.

	Touch Finder (For operation check)
Auto	OFF (Default)
IP Address	192.168.250.150
Subnet mask	255.255.255.0 (Default)
Gateway	10.5.5.1 (Default)
Display screen	Run

*In this document, the gateway setting is unnecessary because the connection is made in the same segment.

6.2. Allocation for Tag Data Links

6.2.1. Data Types

The following data types are used for the Smart Camera.

■ Definition of the data type to access the signals (Union)

This data type is used to access the control signals and status signals.

Data type name	Base type
U_EIPFlag	UNION
F	BOOL[32]
W	DWORD

■ Definition of the data type to access the command communications area (Structure)

This data type is used to access the command area

Data type name	Base type	Destination device data
S_EIPOutput	STRUCT	-
ControlFlag	U_EIPFlag	Control flags (32bit)
CommandCode	DWORD	Command code (CMD-CODE)
CommandParam1	UDINT	Command parameter (CMD-PARAM)
CommandParam2	UDINT	
CommandParam3	DINT	

■ Definition of the data type to access the response/output areas (Structure)

This data type is used to access the response/output areas.

Data type name	Base type	Destination device data
S_EIPInput	STRUCT	-
StatusFlag	U_EIPFlag	Status flags (32bit)
CommandCodeEcho	DWORD	Command code (CMD-CODE)
ResponseCode	UDINT	Response code (RES-CODE)
ResponseData	UDINT	Response data (RES-DATA)
OutputData	DINT[8] *1	Output data 0 to 7 (DATA0 to 7)

*1: Output data size

The data that can be output is determined by the set value of the Output data sizes as follows:

Output data size	Destination device data	Base type
32 bytes (Default)	Output data 0 to 7	DINT[8]
64 bytes	Output data 0 to 15	DINT[16]
128 bytes	Output data 0 to 31	DINT[32]
256 bytes	Output data 0 to 63	DINT[64]



Additional Information

For details on the structure and union, refer to *Accessing Communications Areas Using Variables with NJ-series Controllers in 9-2 Outputting Data and Controlling Operation Through EtherNet/IP of 9 Connecting through Ethernet* in the *FQ2 Smart Camera User's Manual* (Cat. No. Z326).

6.2.2. Data Allocation

The data in the tag data links of the Smart Camera are allocated to the global variables of the Controller. The relationship between the device data and the global variables is shown below. The following global variables are defined in the "Configuration file".

■ Output area (Controller → Smart Camera)

Variable	Data type	Data size
EIPOutput	S_EIPOutput	20 bytes

Offset (word)	Destination device data	Variable name	Data type
+0 and +1	Control flags (32 bits) (Data type: U_EIPFlag)	EIPOutput.ControlFlag.F ^{*1}	BOOL[32]
		EIPOutput.ControlFlag.W ^{*1}	DWORD
+2 and +3	Command code (CMD-CODE)	EIPOutput.CommandCode	DWORD
+4 and +5	Command parameter (CMD-PARAM)	EIPOutput.CommandParam1	UDINT
+6 and +7		EIPOutput.CommandParam2	UDINT
+8 and +9		EIPOutput.CommandParam3	DINT

*1: Allocation of Control flags

Allocation of the *EIPOutput.ControlFlag.F* variable

31	30	29	28	27	26	25	24	23	22	21	20	19	18	17	16	15	14	13	12	11	10	9	8	7	6	5	4	3	2	1	0	
															DS A	ER RCL R															TR IG	EX E

EXE: Control command execution bit: Turn ON this bit to send a specified command to execute

TRIG: Measurement execution bit: Turn ON this bit to start measurement.

ERRCLR: Error clear bit: Turn ON this bit to turn OFF the ERROR signal.

DSA: Data output request bit: Turn ON this bit to request next data output.

■ Input area (Controller ← Smart Camera)

Variable	Data type	Data size
EIPInput	S_EIPInput	48 bytes

Offset (word)	Destination device data	Variable name	Data type
+0 and +1	Status flags (32 bits)	EIPInput.StatusFlag.F ^{*1}	BOOL[32]
	(Data type: U_EIPFlag)	EIPInput.StatusFlag.W ^{*1}	DWORD
+2 and +3	Command code (CMD-CODE)	EIPInput.CommandCodeEcho	DWORD
+4 and +5	Response code (RES-CODE)	EIPInput.ResponseCode	UDINT
+6 and +7	Response data (RES-DATA)	EIPInput.ResponseData	DINT
+8 and +9	Output data 0(DATA0)	EIPInput.OutputData	DINT[8] ^{*2}
+10 and +11	Output data 1(DATA1)		
+12 and +13	Output data 2(DATA2)		
+14 and +15	Output data 3(DATA3)		
+16 and +17	Output data 4(DATA4)		
+18 and +19	Output data 5(DATA5)		
+20 and +21	Output data 6(DATA6)		
+22 and +23	Output data 7(DATA7)		

*1: Allocation of Status flags

Allocation of the *EIPInput.StatusFlag.F* variable

31	30	29	28	27	26	25	24	23	22	21	20	19	18	17	16	15	14	13	12	11	10	9	8	7	6	5	4	3	2	1	0	
																GATE	ERR											RUN	OR	READY	BUSY	FLG

FLG: Control command completion bit: Turns ON when the execution of the command is completed

BUSY: Command execution active bit: Turns ON during the execution of the command

READY: Ready bit: Turns ON when a command can be executed.

OR: Overall judgment bit: Turns ON when the overall judgment result is NG.

RUN: RUN mode display bit: Turns ON during RUN mode.

ERR: Error bit: Turns ON when an error is detected.

GATE: Data output completed bit: Turns ON when data output is completed.

*2: Output data size

The output data that is specified for the data output method is output.

The data that can be output is determined by the set value of the Output data sizes as follows:

Offset (word)	Output data size	Destination device data	Data type
+8 to +23	32 bytes (Default)	Output data 0 to 7	DINT[8]
+8 to +39	64 bytes	Output data 0 to 15	DINT[16]
+8 to +71	128 bytes	Output data 0 to 31	DINT[32]
+8 to +135	256 bytes	Output data 0 to 63	DINT[64]

**Additional Information**

For details on the command codes and response codes, refer to *9-2 Outputting Data and Controlling Operation Through EtherNet/IP of 9 Connecting through Ethernet* in the *FQ2 Smart Camera User's Manual* (Cat. No. Z326).

**Additional Information**

For information on how to set output data items (position, etc.), refer to *Setting the Data to Output Automatically after Measurements* in *9-2 Outputting Data and Controlling Operation Through EtherNet/IP of 9 Connecting through Ethernet* in the *FQ2 Smart Camera User's Manual* (Cat. No. Z326).

**Additional Information**

With the Sysmac Studio, the data type is expressed as ARRAY[0..2] OF WORD when an array is specified for a data type. However, the data type of an array is simplified in this document (e.g. WORD[3]).

It is possible for Sysmac Studio to specify an array as a data type by using each of the following ways.

- ARRAY[0..2] OF WORD
- WORD [3]

In the example above, 3 WORD array elements are secured.

7. Connection Procedure

This section describes how to connect the Controller on the EtherNet/IP network using the "procedure for using configuration files".

This document explains the setting procedure of the Controller and Smart Camera from the factory default setting. For the initialization, refer to *Section 8 Initialization Method*.

7.1. Overview of Setting Tag Data Links

The following figure shows the relationship of processes to perform tag data links using the "procedure for using configuration files".

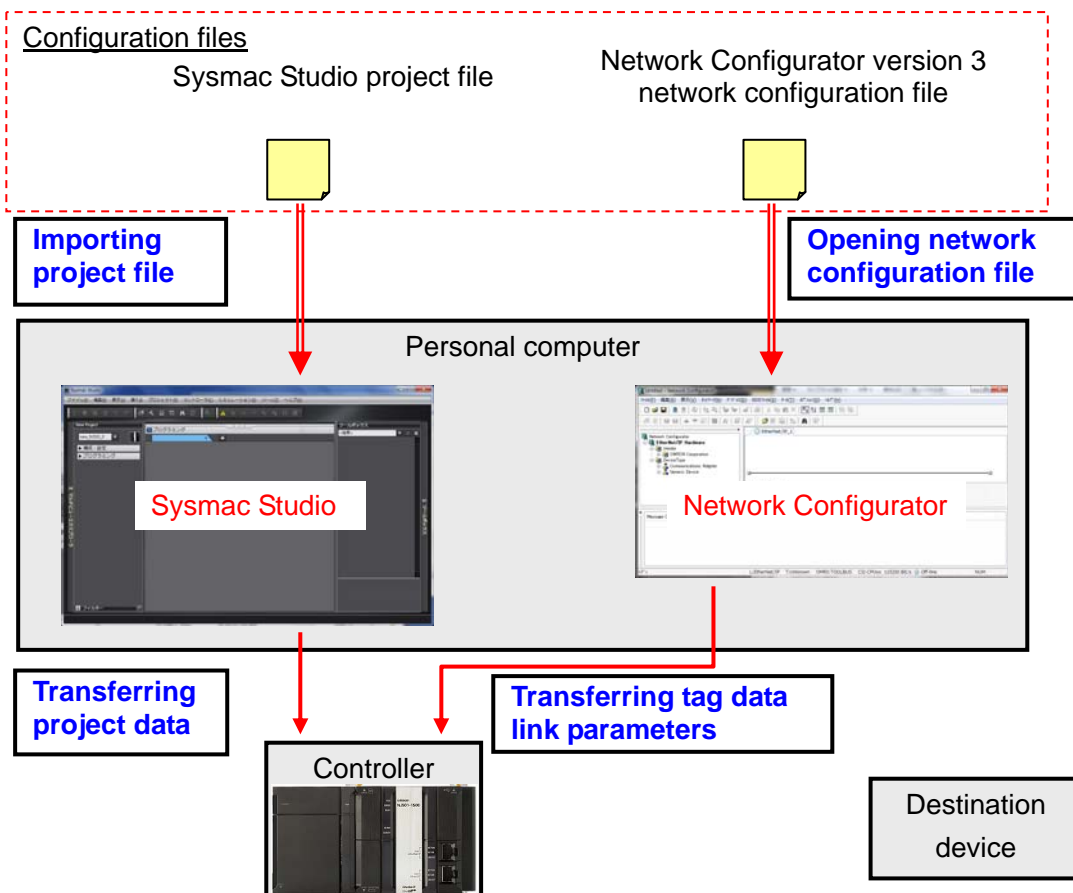

Precautions for Correct Use

Obtain the latest "Sysmac Studio project file" and "Network Configurator version 3 network configuration file" from OMRON in advance.

(To obtain the files, contact your OMRON representative.)

7.2. Work Flow

Take the following steps to make the tag data link connection settings for EtherNet/IP.

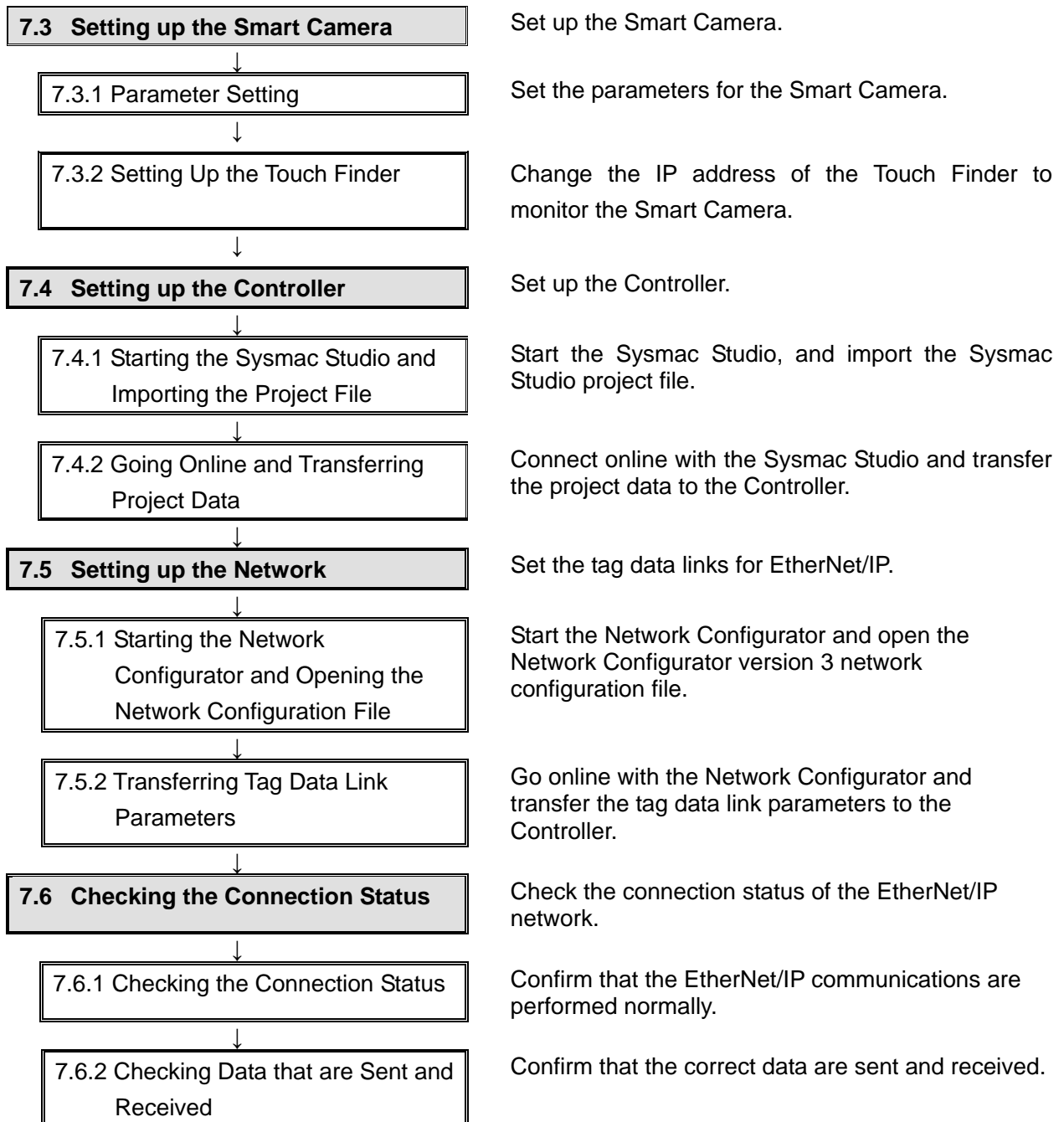

7.3. Setting Up the Smart Camera

Set up the Smart Camera.



Precautions for Correct Use

Complete the procedure in 7.3.1 Parameter Setting before moving on to 7.3.2. Setting Up the Touch Finder.

To restart from 7.3.1 Parameter Setting, restore the Controller, Smart Camera and Touch Finder to the factory default setting. For the initialization, refer to 8. Initialization.

7.3.1. Parameter Setting

Set the parameters for the Smart Camera.

- 1 Connect the Switching Hub to the Ethernet Cable Connector on the side of the Smart Camera using the FQ Ethernet Cable.

Connect the I/O Cable to the I/O Cable Connector.

Connect the 24 VDC power supply to the brown of the I/O Cable, and the GND to the blue of the I/O Cable

Turn ON the 24 VDC power supply.

*In this document, only the power supply lines are wired.

Note that so as not to short-circuit the other lines.

*For details on I/O Cable, refer to 2-4 Wiring in the *FQ2 Smart Camera User's Manual* (Cat. No. Z326).

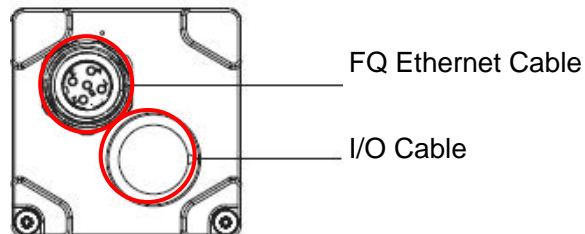

Side of Smart Camera

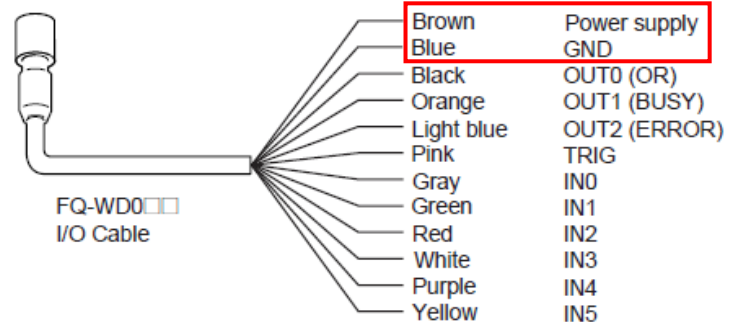

FQ-WD0□□
I/O Cable

2 Set up the Smart Camera by using the Touch Finder.

To select a setting item, tap the Touch Finder's touch panel using the touch pen.

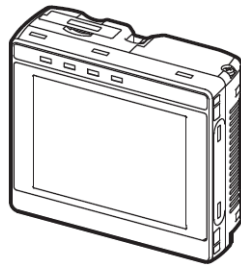

Front of Touch Finder



Touch pen

Connect the AC Adaptor to the AC power supply connector on the Touch Finder.

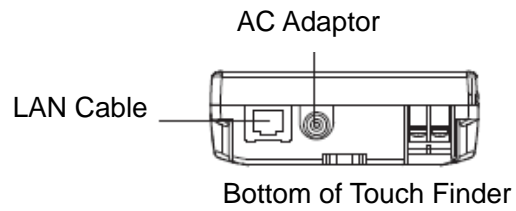

Connect the Switching Hub to the Ethernet Connector on the Touch Finder using the LAN Cable.

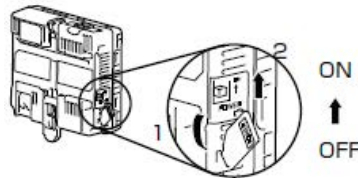

Turn ON the power supply Touch Finder power supply switch to the Touch Finder.

- 3 The start screen of the Touch Finder is displayed.



Start screen of Touch Finder

*Select a language at the first startup. In the following example, **English** is selected.

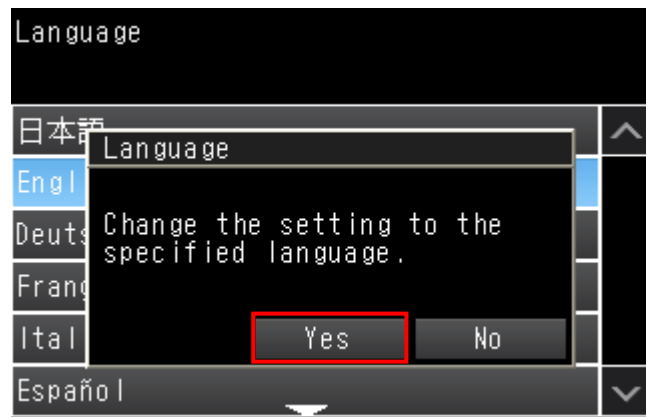

- 4 Tap the  icon on the right button of the Touch Finder Window.

*If "Auto connect" is displayed and the screen on the right is not displayed, tap Auto connect and display this screen.

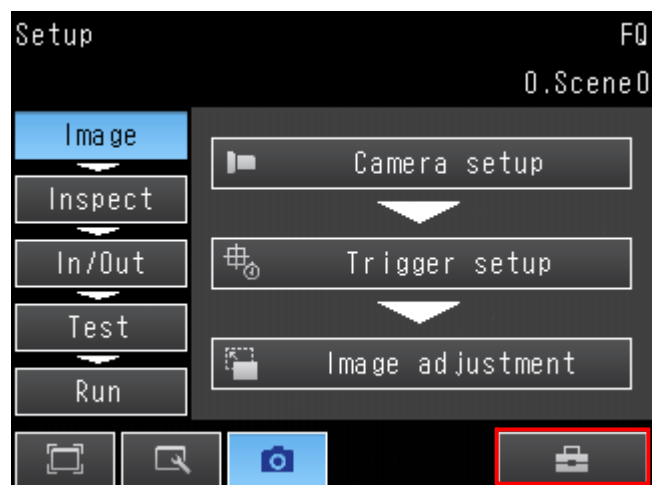

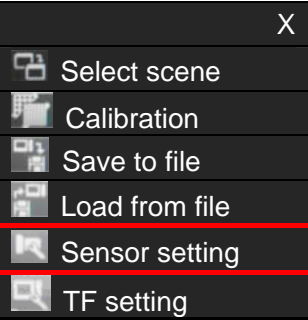
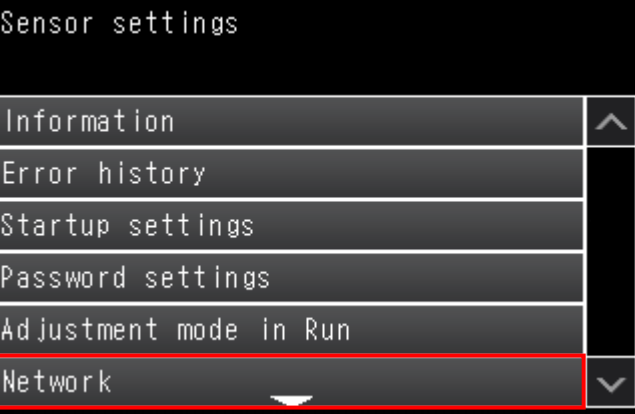
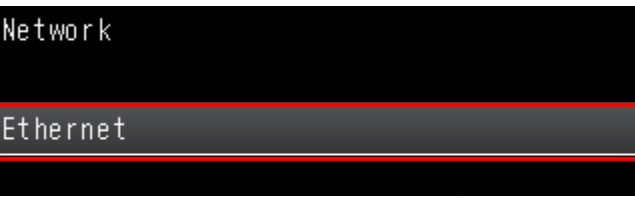
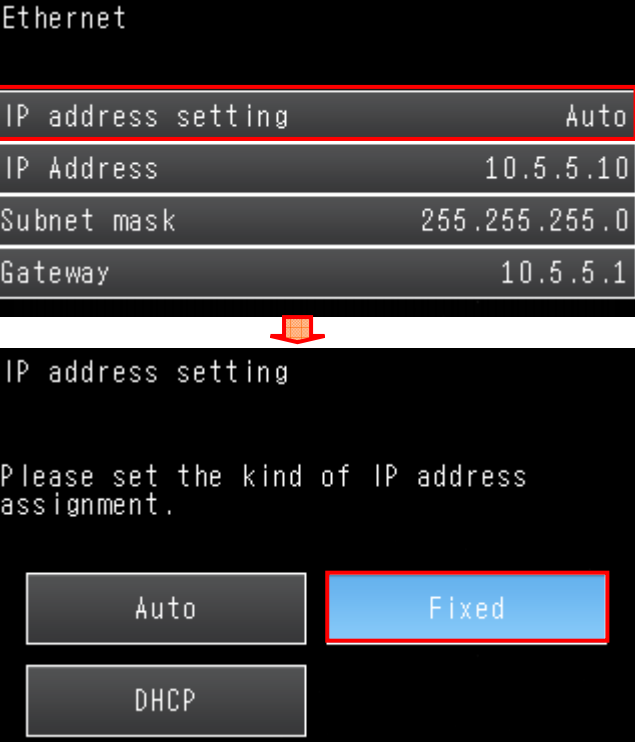
5	<p>The pop-up menu on the right is displayed. Tap the Sensor setting.</p>	
6	<p>Tap Network on the Sensor settings Menu.</p>	
7	<p>Tap Ethernet on the Network Menu.</p>	
8	<p>Tap IP address setting on the Ethernet Menu.</p> <p>Tap Fixed on the IP address setting Menu.</p>	

9 Set the fixed IP address.

Tap **IP Address** on the Ethernet Menu.

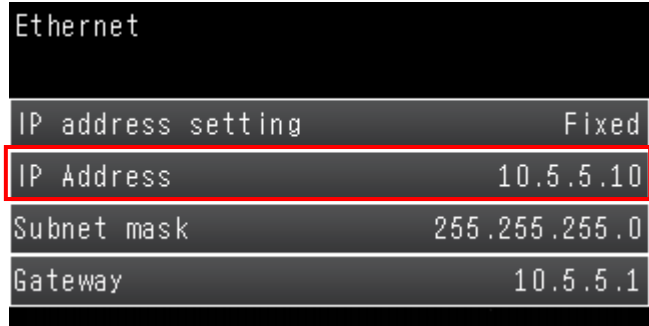

Tap each octet on the IP Address Screen. A numeric keypad is displayed. Tap the numeric keypad and enter each octet of the IP address. After entering, tap **OK**.



Set the IP address to 192.168.250.2.

Tap **OK** to complete the IP address setting.

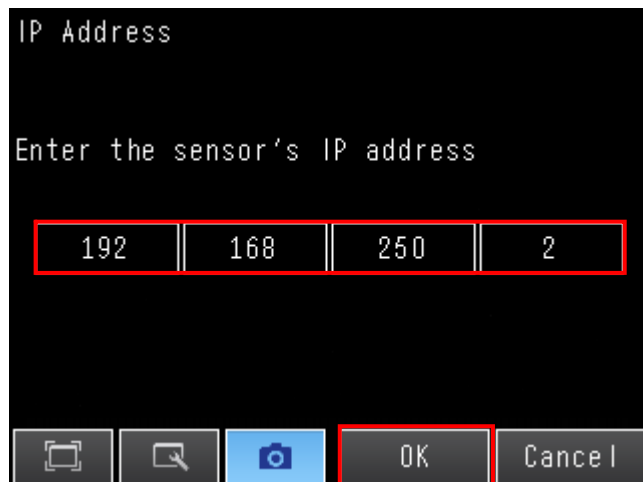

10 Confirm that the settings are made as follows and tap **OK**.

IP address setting: Fixed
 IP address: 192.168.250.2
 Subnet mask: 255.255.255.0

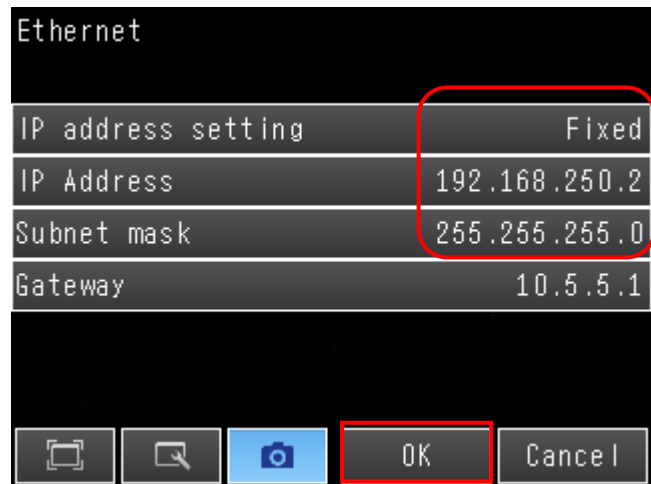

If the dialog box on the right is displayed, tap **OK**.

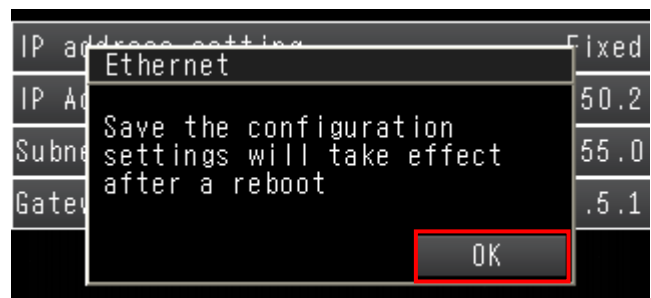

Tap **Back**.
 The window in step 6 is displayed again.

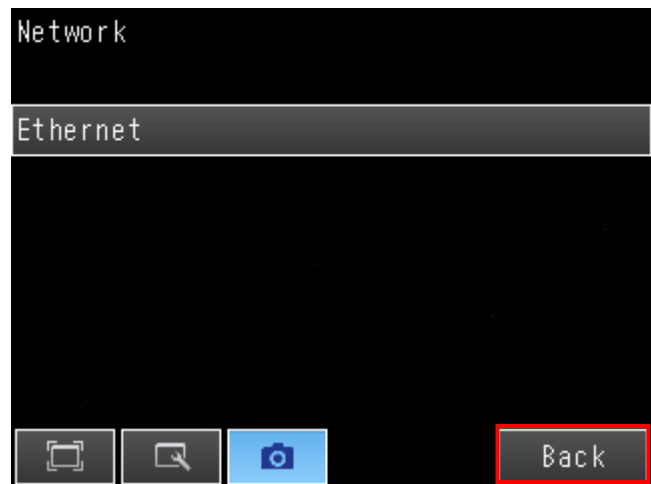

11 Tap **Data output**.

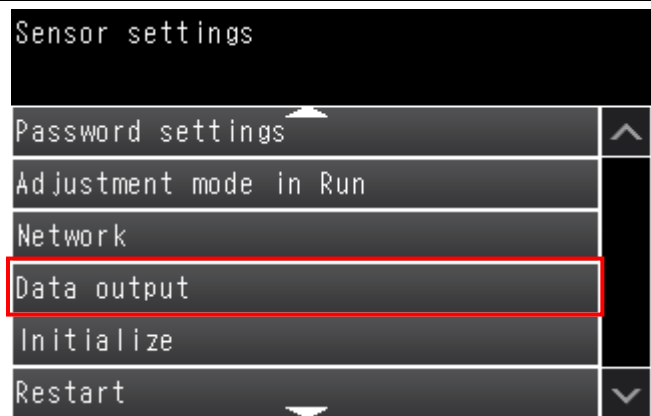

12 The Data output Menu is displayed.

Tap **Link data output**.

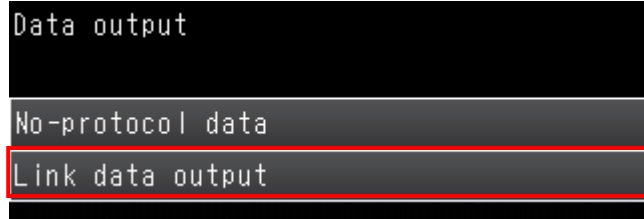

On the Link data output Menu, tap **Comm. type**.

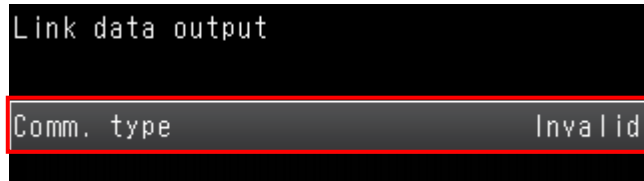

On the Comm. type Menu, tap **EtherNet/IP**.

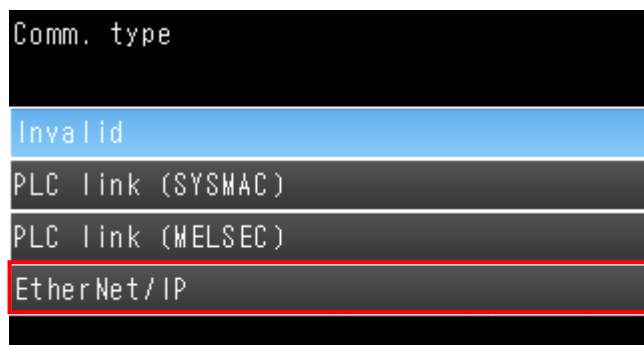

The Link data output Menu is displayed.

Confirm that the following settings are made, and tap **Back**.

Comm. type: EtherNet/IP
Output data size: 32 bytes

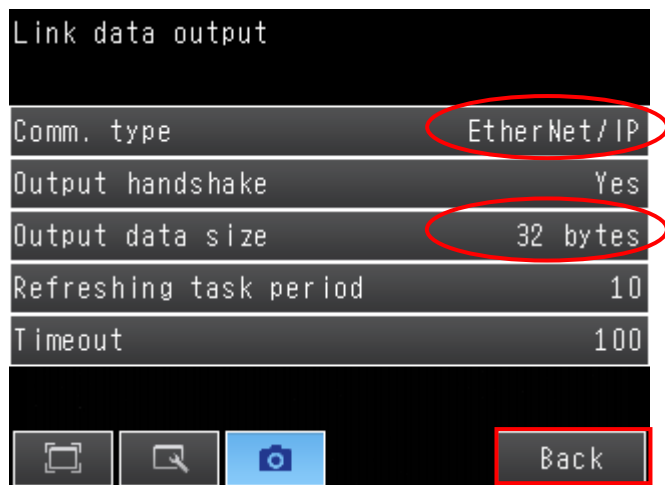

- 13 On the Data output Menu, tap **Back**.

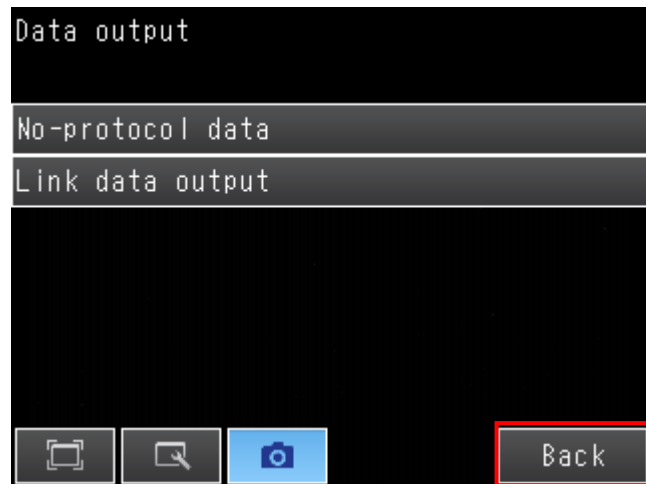

- On the Data output Dialog Box, tap **OK**.

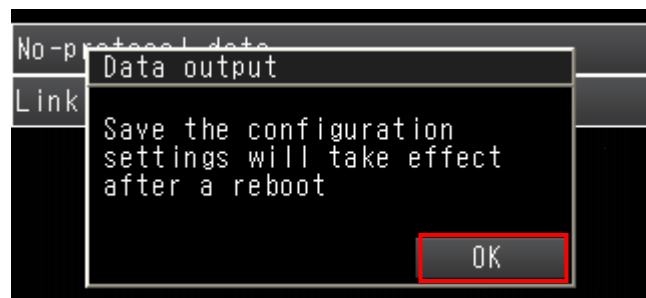

- On the Sensor settings Menu, tap **Back**.
The Setup Menu is displayed again.

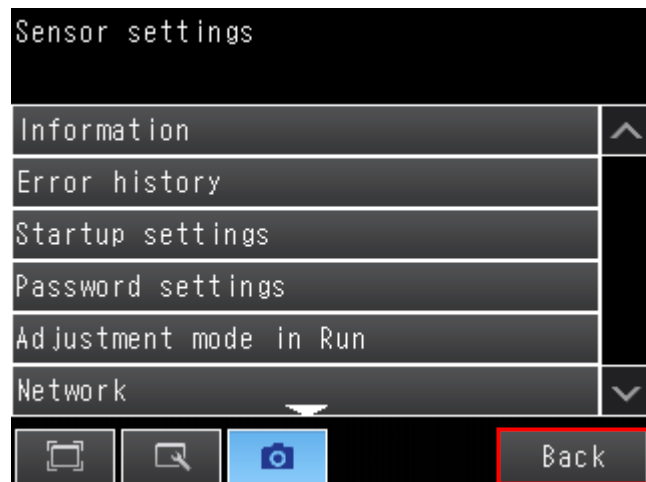

14 On the Setup Menu, tap **Test**.

Tap **Save data**.

On the Save data Dialog Box, tap **Yes**.

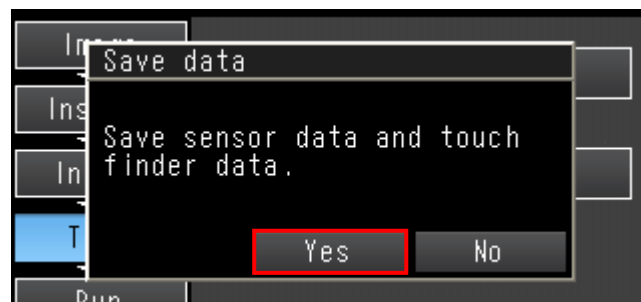
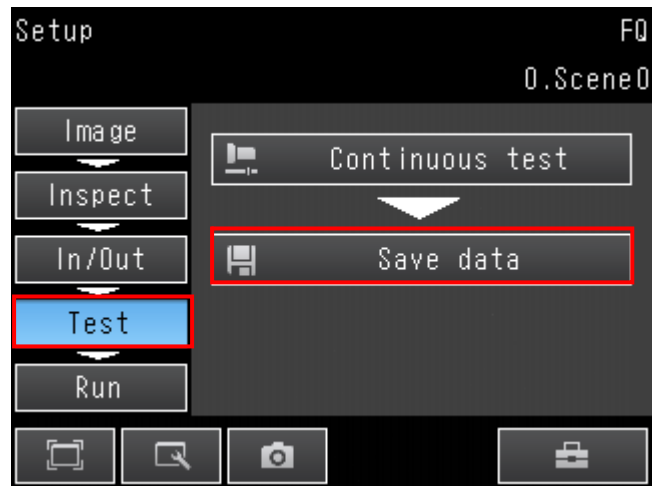

15 Cycle the power supply to the Smart Camera.

*The new parameters take effect after cycling the power supply.

7.3.2. Setting Up the Touch Finder

Change the IP address of the Touch Finder to monitor the Smart Camera.

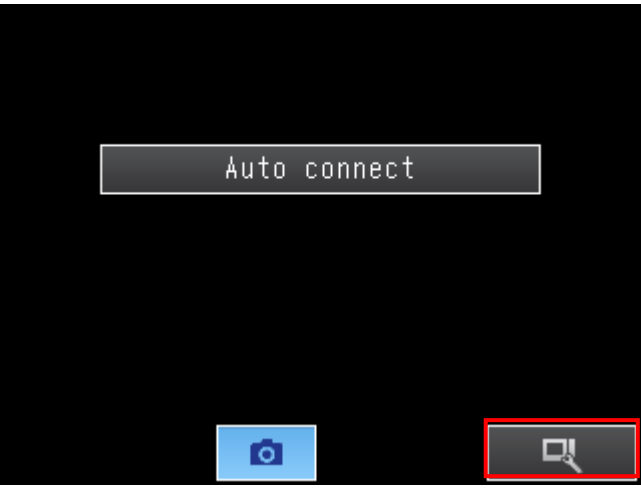
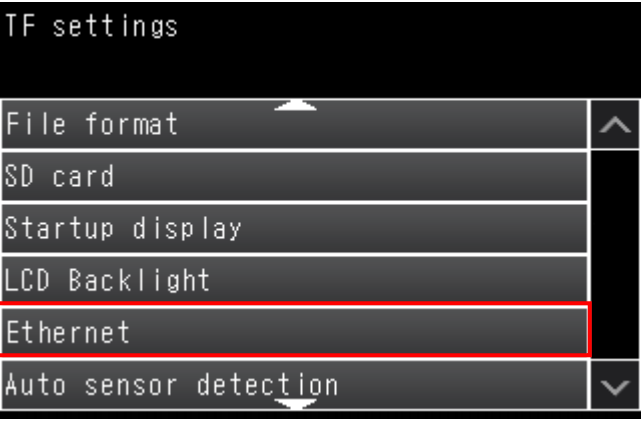
1 Tap  on the Touch Finder.	
2 The TF setting Menu is displayed. Tap Ethernet .	

3 Tap **IP Address** on the Ethernet Menu.

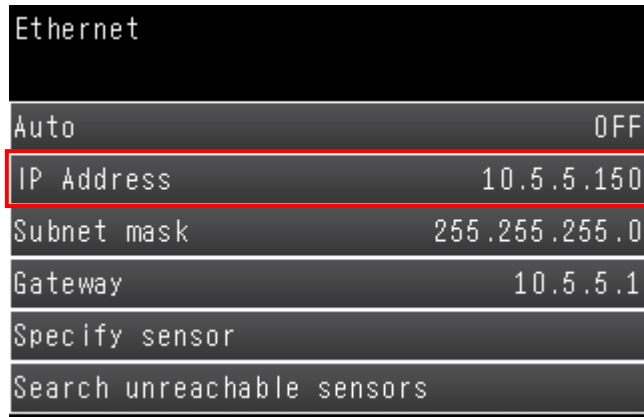

Tap each octet on the IP Address Screen. A numeric keypad is displayed. Tap the numeric keypad and enter each octet of the IP address. After entering, tap **OK**.

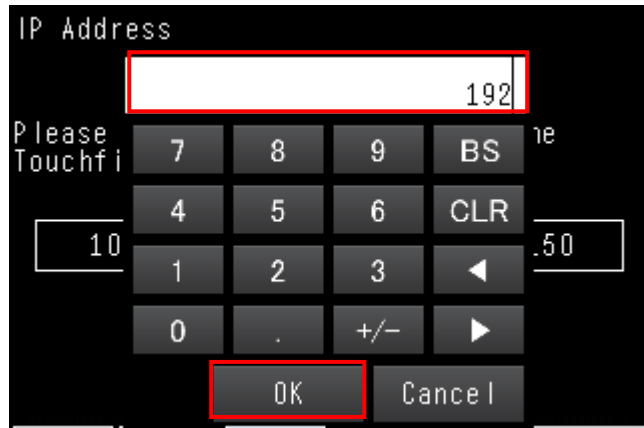

Set the IP address to 192.168.250.150.



Tap **OK** to complete the IP address setting.

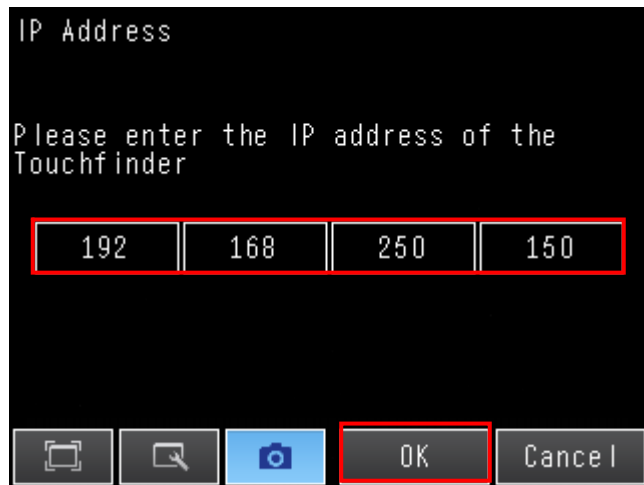

- 4 Confirm that the settings are made as follows and tap **Back**.

Auto: OFF

IP address: 192.168.250.150

Subnet mask: 255.255.255.0

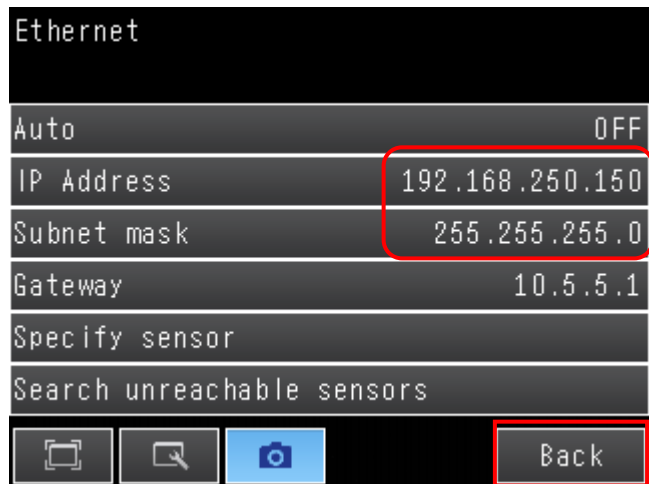

Tap **Back**.



If the dialog box on the right is displayed, tap **Yes**.

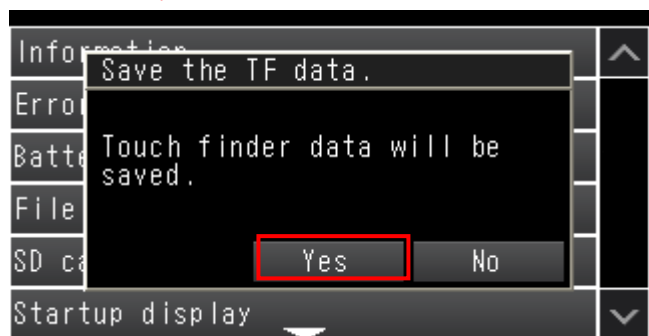

5 On the Setup Menu, tap **Run**.

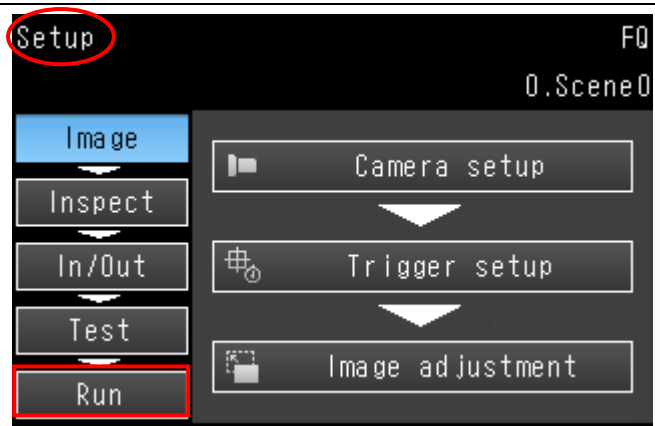

Tap **Switch to Run mode**.

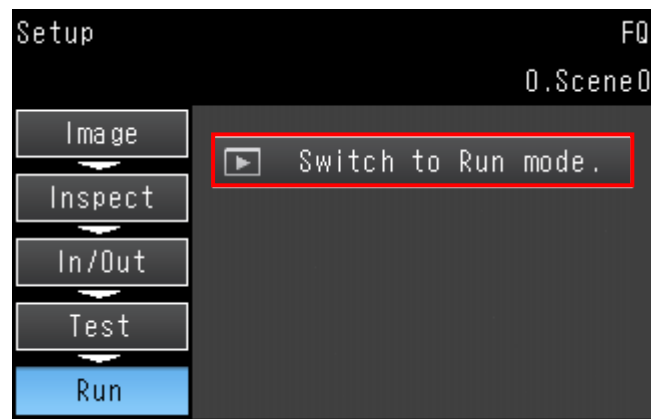

If the dialog box on the right is displayed, tap **Yes**.

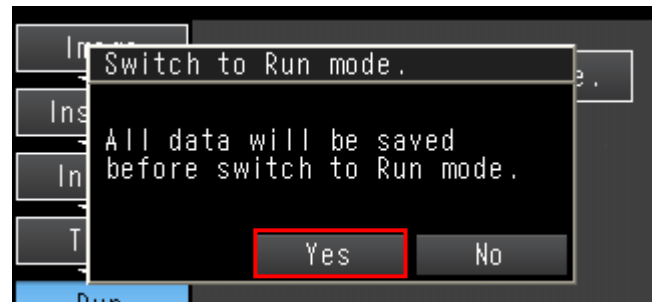

Run is displayed on the Touch Finder.

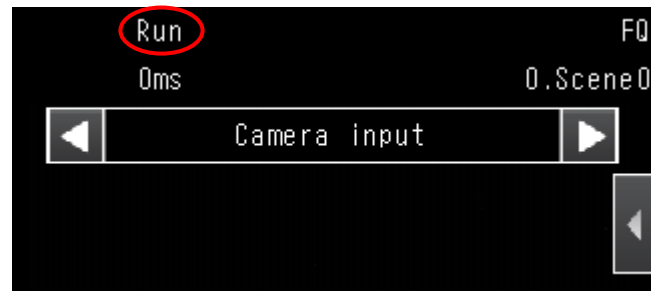

Additional Information

For details on the Ethernet setting for the Touch Finder, refer to *2-5 Setting Up Ethernet in Section 2 Installation and Connections* of the *FQ2 Smart Camera User's Manual* (Cat. No. Z326).

7.4. Setting Up the Controller

Set up the Controller.

7.4.1. Starting the Sysmac Studio and Importing the Project File

Start the Sysmac Studio, and import the Sysmac Studio project file.

Install the Sysmac Studio and USB driver beforehand

- 1 Connect the LAN cable to the built-in EtherNet/IP port (PORT1) on the Controller, and connect the USB cable to the peripheral (USB) port. Then, connect the personal computer, Smart Camera, Switching Hub and Controller as shown in 5.2. Device Configuration. Turn ON the power supply to the Controller.

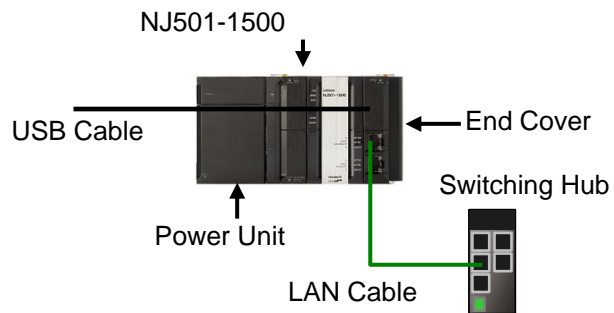

- 2 Start the Sysmac Studio. Click the **Import** Button.

*If a confirmation dialog for an access right is displayed at start, select to start.

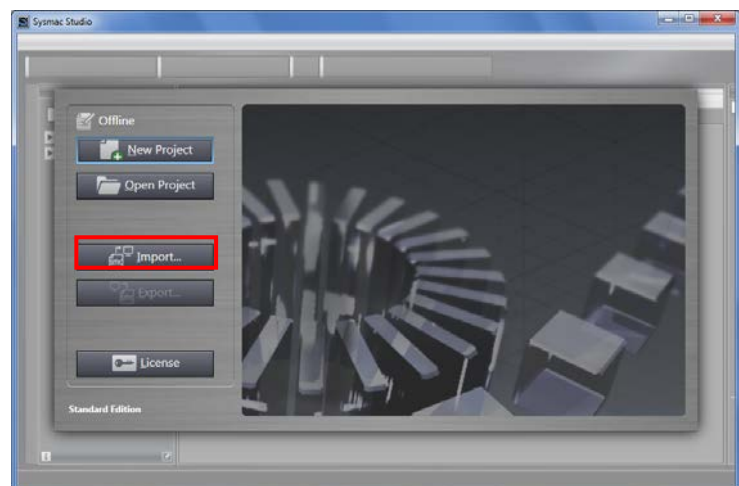

- 3 The Import File Dialog Box is displayed. Select OMRON_FQ2_EIP_EV100.SMC (Sysmac Studio project file) and click the **Open** Button.

*Obtain the Sysmac Studio project file from OMRON.

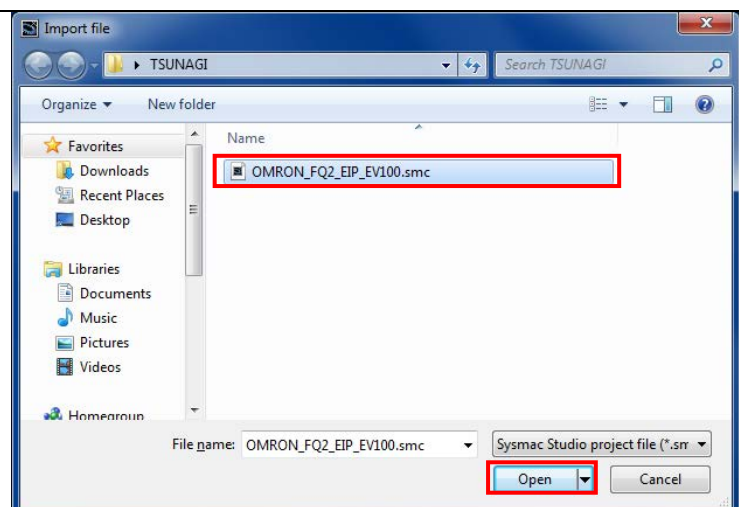

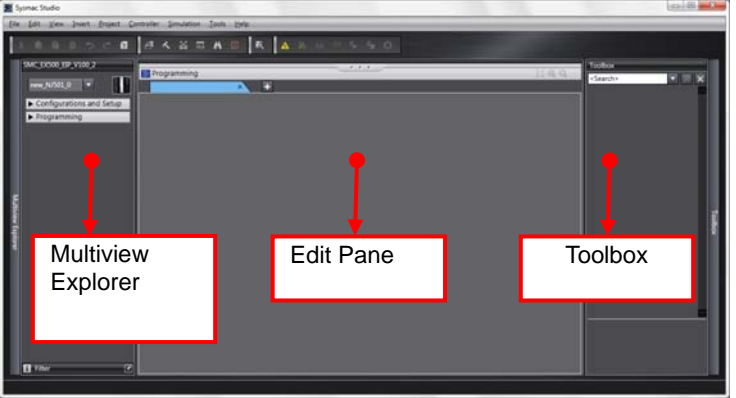
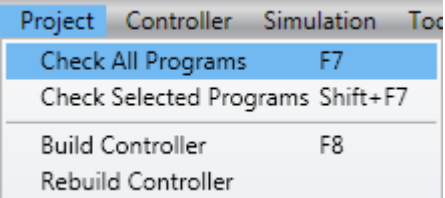
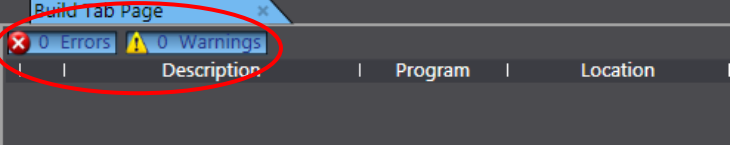
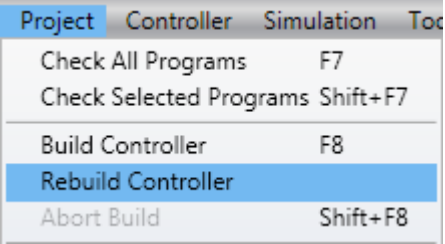
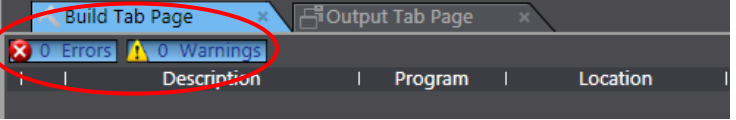
<p>4 The OMRON_FQ2_EIP_EV100 project is displayed. The left pane is called Multiview Explorer, the right pane is called Toolbox and the middle pane is called Edit Pane.</p> <p>*If an error message is displayed stating “Failed to Load Descendants”, change the version of the Sysmac Studio to any version specified in 5.2. Device Configuration.</p>	 <p>The screenshot shows the Sysmac Studio interface with three panes highlighted by red boxes and arrows: 'Multiview Explorer' on the left, 'Edit Pane' in the center, and 'Toolbox' on the right.</p>
<p>5 Select Check All Programs from the Project Menu.</p>	 <p>The screenshot shows the 'Project' menu with 'Check All Programs' (F7) selected. Other options include 'Check Selected Programs' (Shift+F7), 'Build Controller' (F8), and 'Rebuild Controller'.</p>
<p>6 The Build Tab Page is displayed in the Edit Pane. Check that “0 Errors” and “0 Warnings” are displayed.</p>	 <p>The screenshot shows the 'Build Tab Page' with a status bar indicating '0 Errors' and '0 Warnings'. The status bar is circled in red.</p>
<p>7 Select Rebuild Controller from the Project Menu.</p>	 <p>The screenshot shows the 'Project' menu with 'Rebuild Controller' (F8) selected. Other options include 'Check All Programs' (F7), 'Check Selected Programs' (Shift+F7), and 'Abort Build' (Shift+F8).</p>
<p>8 Confirm that Check that “0 Errors” and “0 Warnings” are displayed in the Build Tab Page.</p>	 <p>The screenshot shows the 'Build Tab Page' with a status bar indicating '0 Errors' and '0 Warnings'. The status bar is circled in red.</p>

7.4.2. Going Online and Transferring the Project Data

Connect online with the Sysmac Studio and transfer the project data to the Controller.

⚠ WARNING

Always confirm safety at the destination node before you transfer a user program, configuration data, setup data, device variables, or values in memory used for CJ-series Units from the Sysmac Studio.

The devices or machines may perform unexpected operation regardless of the operating mode of the CPU Unit.



- 1 Select **Change Device** from the Controller Menu.

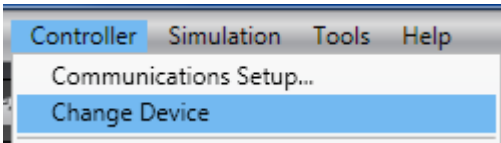

- 2 The Change Device Dialog Box is displayed. Confirm that Device and Version are set as shown on the right.

*If the settings are different, select and set the setting items from the pull-down list

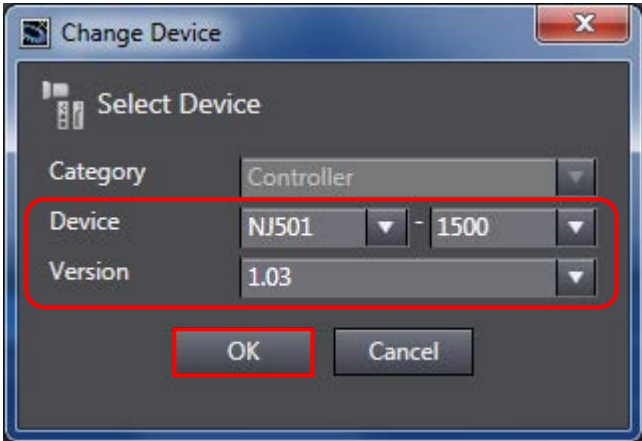
Click the **OK** Button.

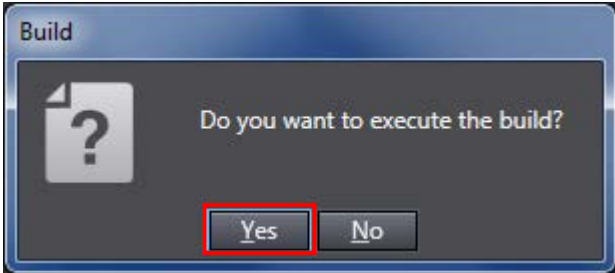

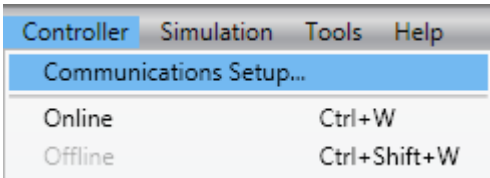
- 3 If the settings were changed in step 2, the Build Dialog Box is displayed. Click the **Yes** Button.

- 4 Select **Communications Setup** from the Controller Menu.

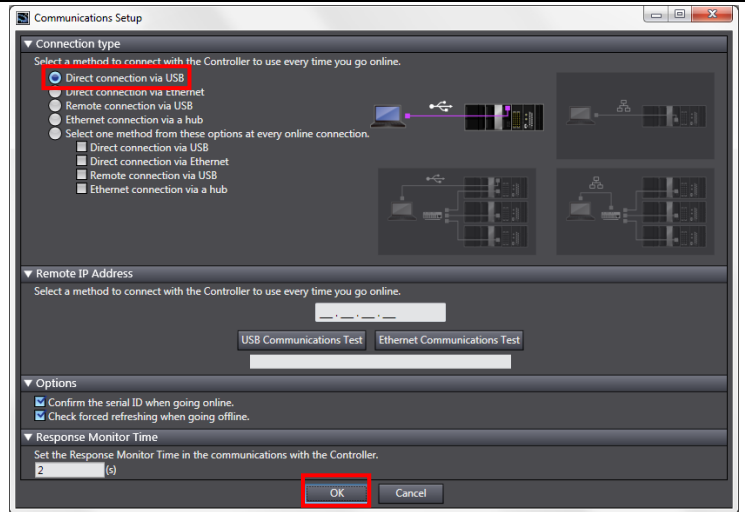

- 5 The Communications Setup Dialog Box is displayed.
Select the *Direct Connection via USB* Option for Connection Type.

Click the **OK** Button.



- 6 Select **Online** from the Controller Menu.

*If a confirmation dialog box shown on the right is displayed, the model or version of the Controller is different from the device setting.
Check the model and version of the Controller, correct the device setting of the project file, and repeat the procedure from step 1.
Click the **OK** Button to close the dialog box.

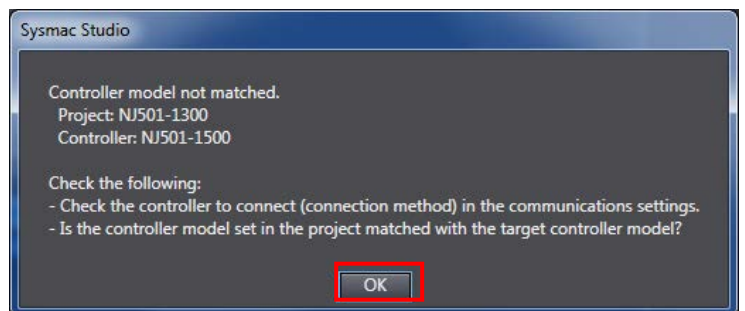
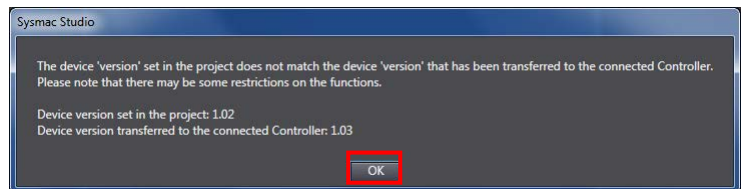
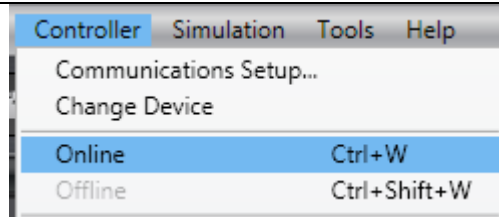

7 A confirmation dialog box is displayed. Click the **Yes** Button.

*The displayed dialog depends on the status of the Controller used. Click the **Yes** Button to proceed with the processing.

*The displayed serial ID differs depending on the device.

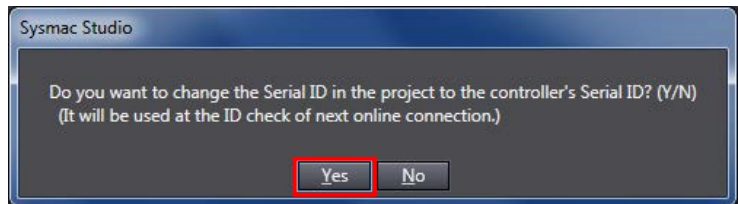
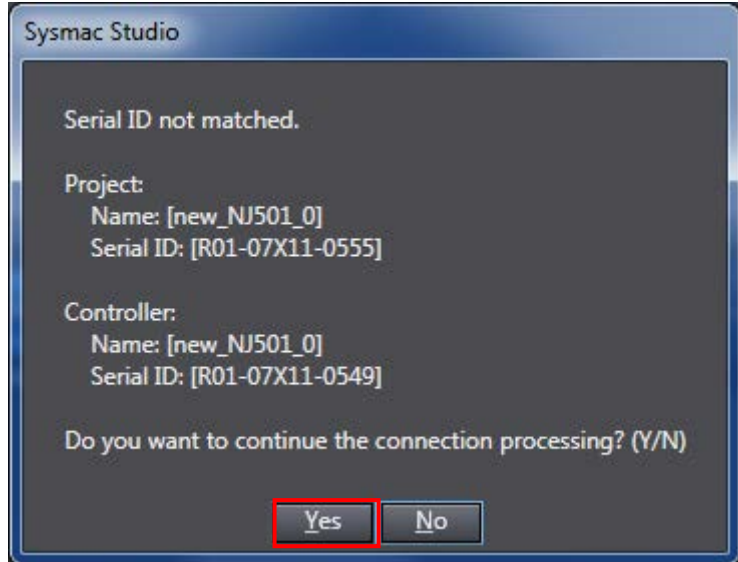
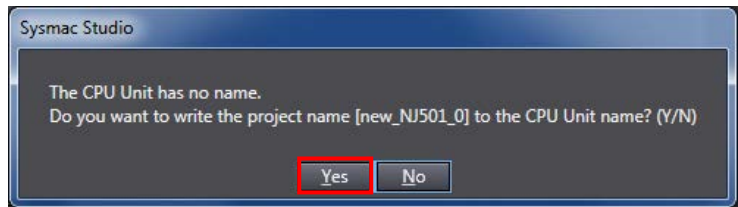

8 When an online connection is established, a yellow bar is displayed on the top of the Edit Pane.



Additional Information

For details on the online connections to a Controller, refer to *Section 5 Going Online with a Controller* in the *Sysmac Studio Version 1 Operation Manual* (Cat. No. W504).

9 Select **Synchronization** from the Controller Menu.

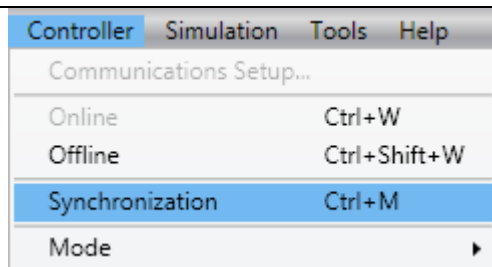

10 The Synchronization Dialog Box is displayed.

Confirm that the data to transfer (NJ501 in the right figure) is selected. Then, click the **Transfer to Controller** Button.

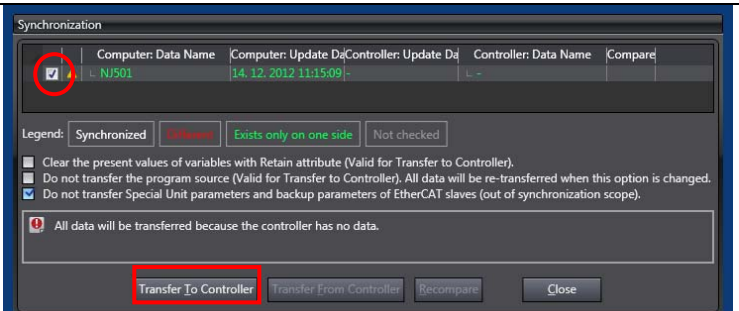

11 A confirmation dialog is displayed. Click the **Yes** Button.

A screen stating "Synchronizing" is displayed.

A confirmation dialog is displayed. Click the **No** Button.

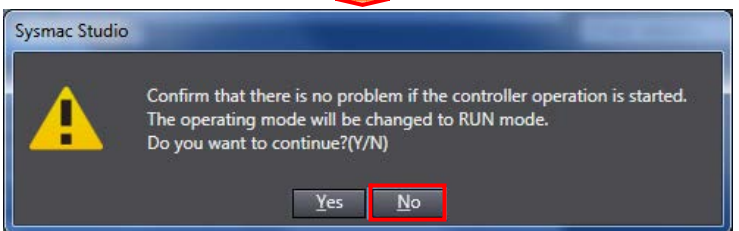
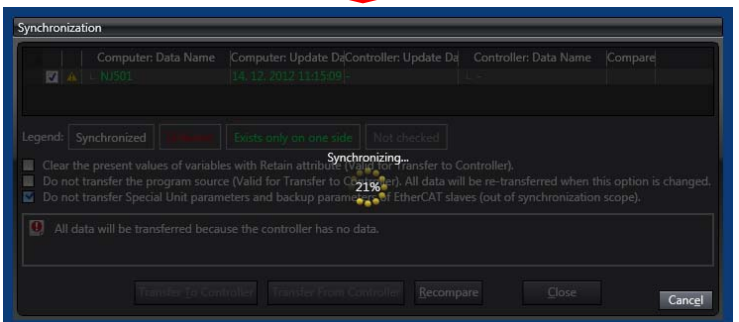
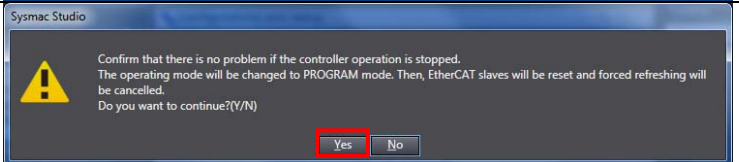

12 Confirm that the synchronized data is displayed with the color specified by "Synchronized", and confirm that a message is displayed stating "The synchronization process successfully finished". If there is no problem, click the **Close** Button.

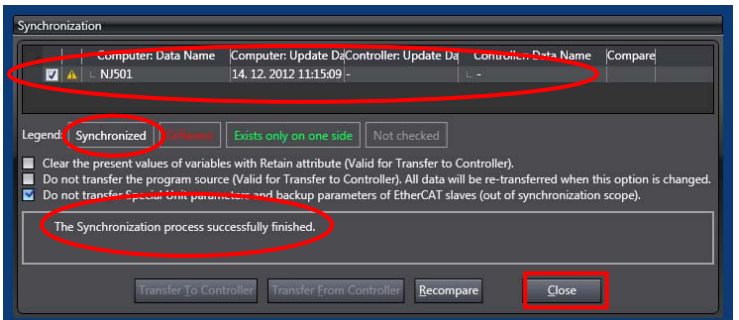

Additional Information

If the synchronization fails, referring to the message that is displayed, please take appropriate action. For details, refer to *10-3 Error Messages for Sysmac Studio Operation in the Sysmac Studio Version 1 Operation Manual (Cat. No. W504)*.

7.5. Setting Up the Network

Set the tag data links for EtherNet/IP.

7.5.1. Starting the Network Configurator and Opening the Network Configuration File

Start up the Network Configurator and open the Network Configurator version 3 network configuration file.

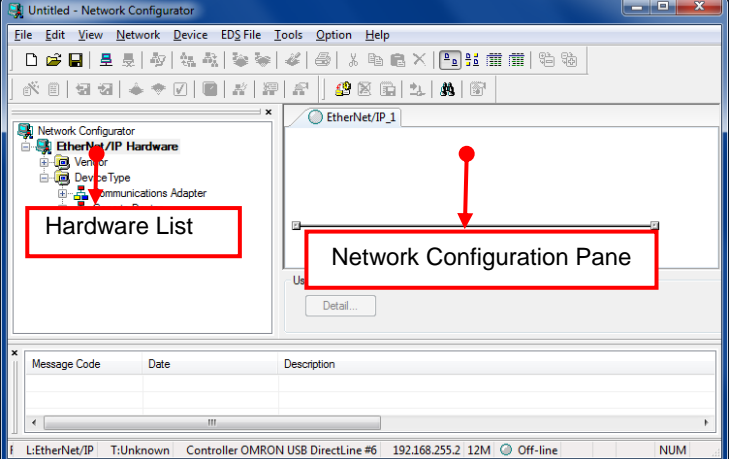
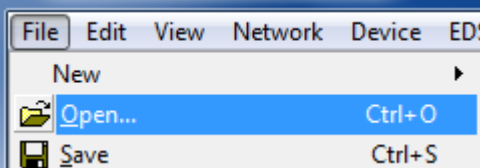
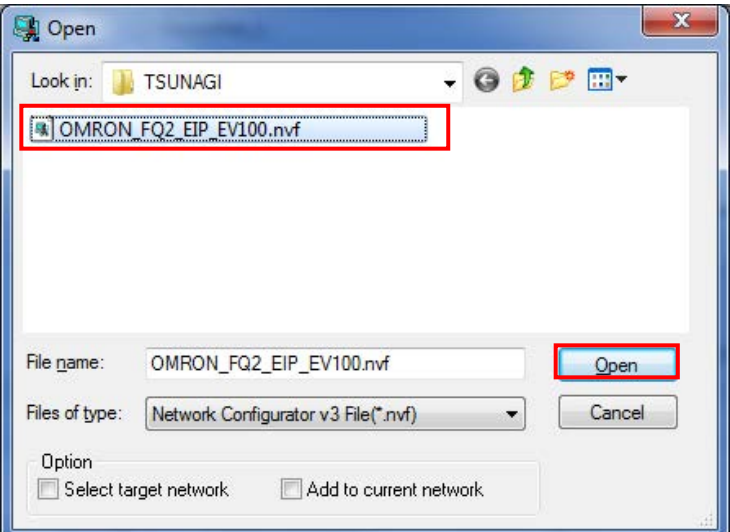
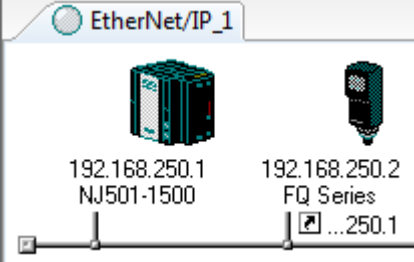
<p>1 Start the Network Configurator.</p>	
<p>2 Select Open from the File Menu.</p>	
<p>3 The Open Dialog Box is displayed. Select OMRON_FQ2_EIP_EV100.NVF (Network Configurator version 3 network configuration file). Then, click the Open Button.</p> <p>*Obtain the Network Configurator version 3 network configuration file from OMRON.</p>	
<p>4 The following devices are displayed in the Network Configuration Pane as shown on the right figure. IP address of node 1: 192.168.250.1 IP address of node 2: 192.168.250.2</p>	

7.5.2. Transferring the Tag Data Link Parameters

Connect the Network Configurator online and transfer the tag data link parameters to the Controller.



Precautions for Correct Use

Confirm that the LAN cable is connected before proceeding to the following procedure.

If it is not connected, turn OFF the power to the devices and then connect the LAN cable.

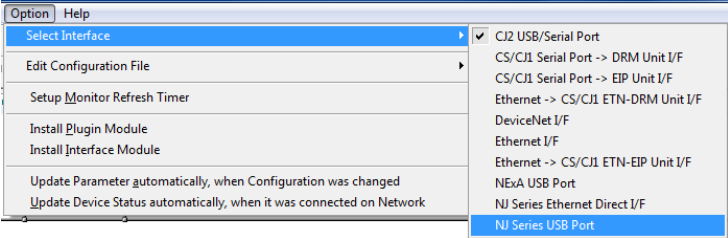
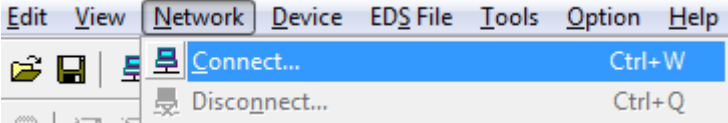
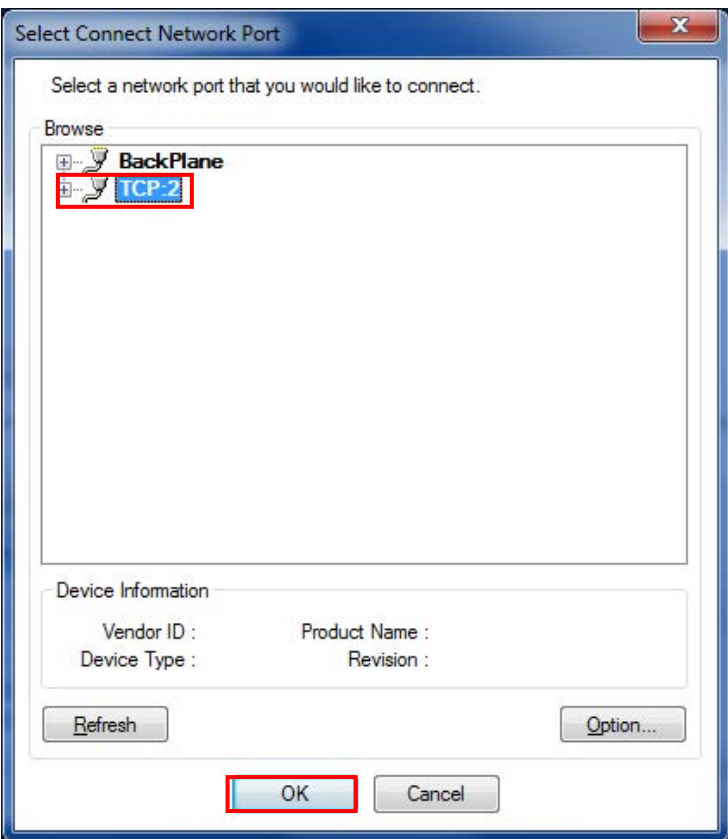
<p>1 Select Select Interface - NJ Series USB Port from the Option Menu.</p>	
<p>2 Select Connect from the Network Menu.</p>	
<p>3 The Select Connect Network Port Dialog Box is displayed. Select TCP:2 and click the OK Button.</p>	

- 4 The Select Connected Network Dialog Box is displayed. Click the **OK** Button.

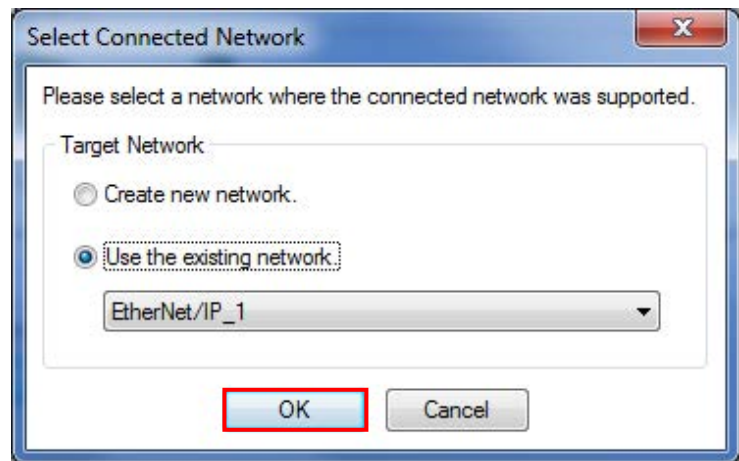

Precautions for Correct Use

If an online connection cannot be made to the Controller, check the cable connection. Or, return to step 4 and check the settings such as a connection type and try again.



Additional Information

For details on the online connections to a Controller, refer to 7-2-8 *Connecting the Network Configurator to the Network* in Section 7 *Tag Data Link Functions* of the *NJ-series CPU Unit Built-in EtherNet/IP Port User's Manual* (Cat. No. W506).

- 5 When an online connection is established normally, the color of the icon shown on the figure changes to blue.

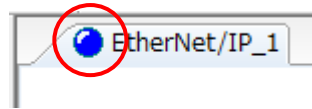

- 6 Right-click node 1 device on the Network Configuration Pane and select **Parameter - Download**.

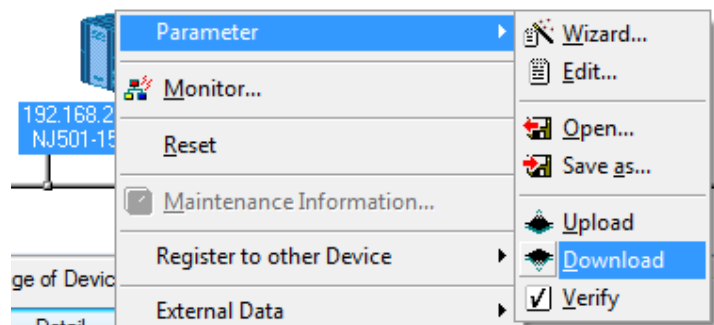

The dialog box on the right is displayed. Click the **Yes** Button.

*If the Controller used is in RUN mode, the List of Device that are executing Dialog Box is displayed. If displayed, click the **Download after changed to Program mode** Button and proceed to the next step.

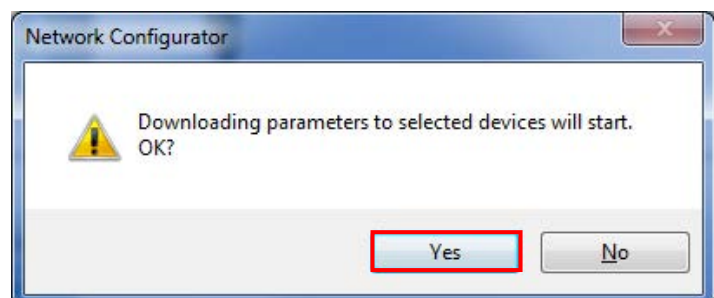

- 7 The tag data link parameters are downloaded from the Network Configurator to the Controller.

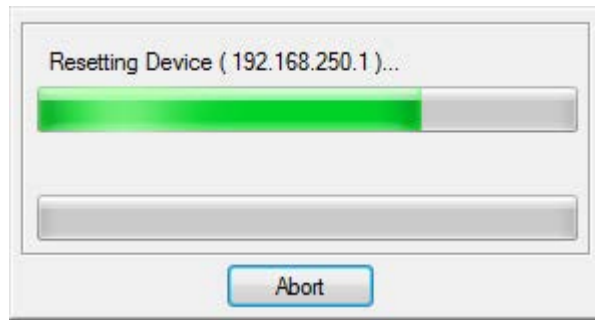

- 8 The dialog box on the right is displayed. Click the **OK** Button.

*If the operating mode was changed in step 6, a confirmation dialog is displayed. Click the **No** Button to remain in the current operating mode.

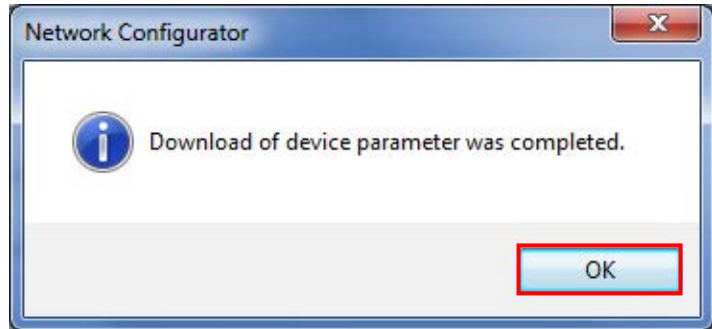

7.6. Connection Status Check

Check the connection status of the EtherNet/IP network.

7.6.1. Checking the Connection Status

Check that the EtherNet/IP communications are performed normally.

- 1 Confirm that the tag data links are normally in operation by checking the LED indicators on the Controller.

- Controller

LED indicators in normal status:

[NET RUN]: Lit green

[NET ERR]: Not lit

[LINK/ACT]: Flashing yellow
(Flashing while packets are being sent and received)

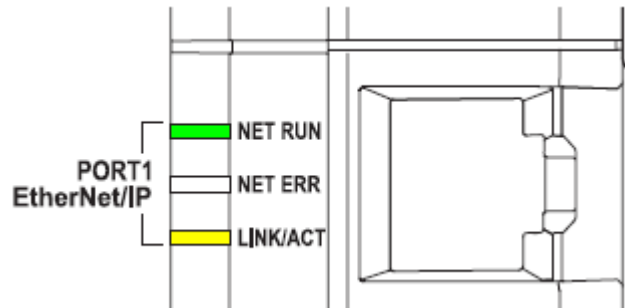

(Controller)

- Smart Camera

LED indicators in normal status:

[ETN]: Flashing orange

[BUSY]: Not lit or lit green

[OR]: Not lit or lit orange

[ERROR]: Not lit

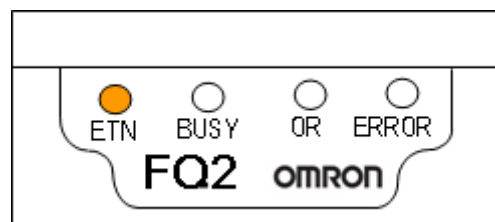

(Smart camera)

- 2 Confirm that the tag data links are normally performed by checking the status information on the Device Monitor Window of the Network Configurator.

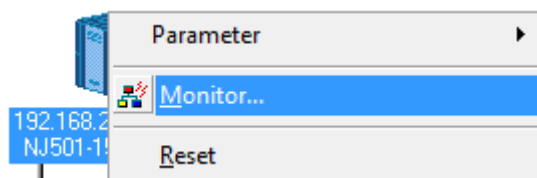

Right-click node 1 device icon on the Network Configuration Pane, and select **Monitor**.

3 The dialog box on the right shows the Status 1 Tab Page of the Monitor Device Dialog Box.

When the same items in the right dialog are selected, the data links are normally performed.

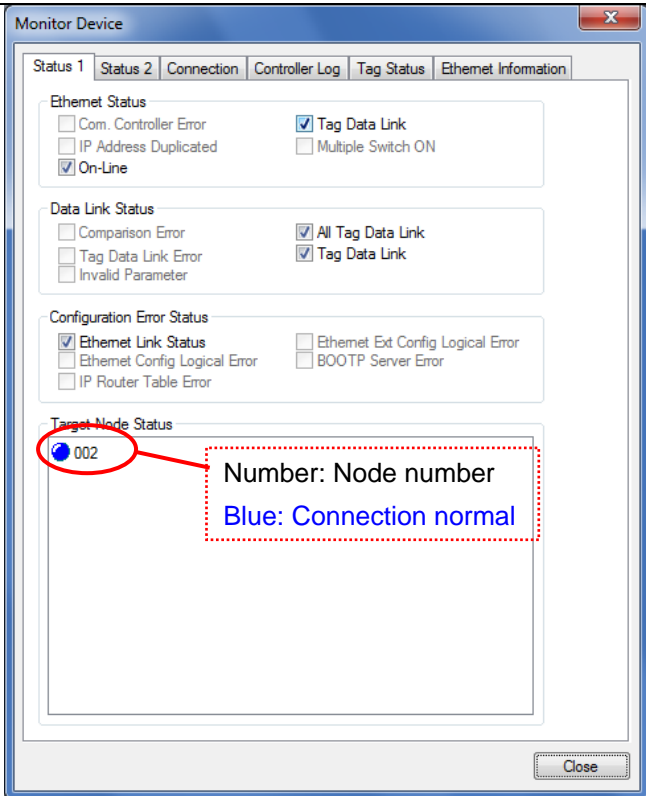

4 The dialog on the right shows an example of the error status.

To check the error details, select the Controller Log tab.

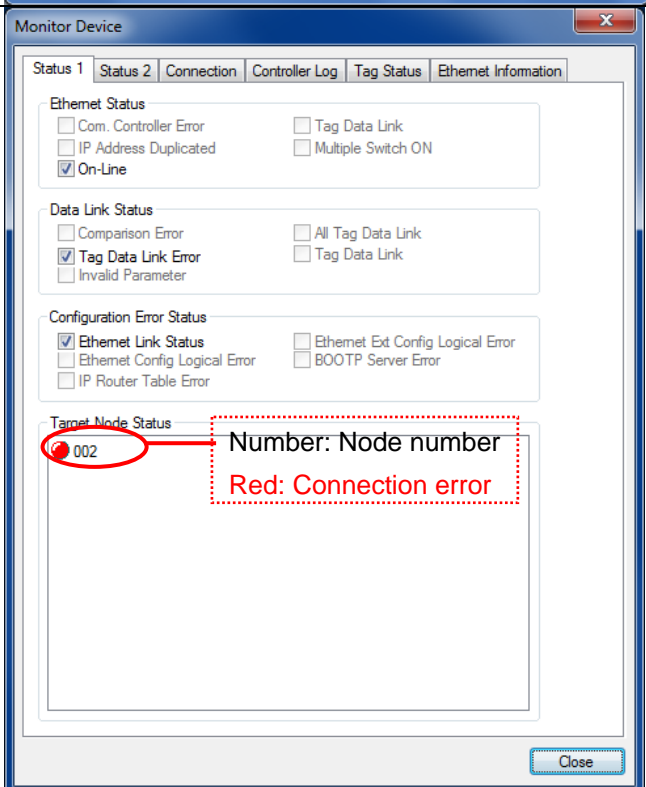

5 This is the Controller Log Tab Page.

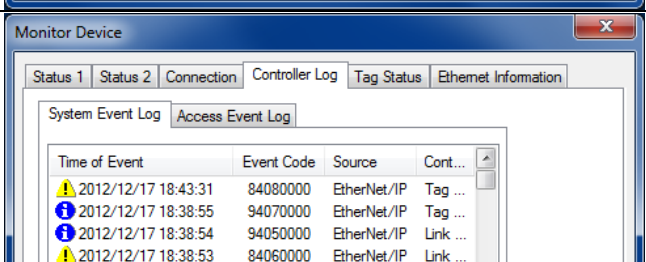

6 Exit the Network Configurator.

7.6.2. Checking Data That Are Sent and Received

Confirm that the correct data are sent and received.

WARNING

Always confirm safety at the destination node before you transfer a user program, configuration data, setup data, device variables, or values in memory used for CJ-series Units from the Sysmac Studio.

The devices or machines may perform unexpected operation regardless of the operating mode of the CPU Unit.



Caution

The Smart Camera will start operation if you perform the following procedure. Confirm safety before you perform the procedure. If you cannot confirm safety, complete the check procedure in Section 7.6.1 and do not perform the procedure in this section.

When you perform the check procedure in this section, make sure to complete all the steps and to place the operation in the safe state.

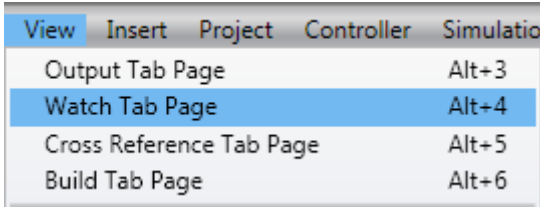

- 1 Select **Watch Tab Page** from the View Menu.

- 2 The Watch Tab Page 1 is displayed in the lower section of the Edit Pane.

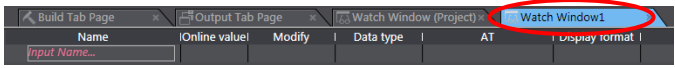
- 3 The following names are entered in the Watch Tab Page 1 for monitoring.

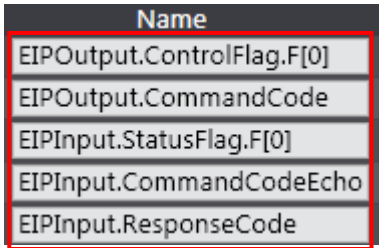
 - EIOutput.ControlFlag.F[0](EXE)
 - EIOutput.CommandCode
 - EIInput.StatusFlag.F[0](FLG)
 - EIInput.CommandCodeEcho
 - EIInput.ResponseCode

- 4 Enter 00101020 in the Modify Column for *EIOutput.CommandCode*.
(Command code [00101020]: Start Continuous Measurements)

Name	Online value	Modify	Data type
EIOutput.ControlFlag.F[0]	False	TRUE FALSE	BOOL
EIOutput.CommandCode	0000 0000	00101020	DWORD
EIInput.StatusFlag.F[0]	False	TRUE FALSE	BOOL
EIInput.CommandCodeEcho	0000 0000		DWORD
EIInput.ResponseCode	0		UDINT



Press the **Enter** key to set the value. The Online value for *EIOutput.CommandCode* changes to 00101020.

Name	Online value	Modify	Data type
EIOutput.ControlFlag.F[0]	False	TRUE FALSE	BOOL
EIOutput.CommandCode	0010 1020	00101020	DWORD
EIInput.StatusFlag.F[0]	False	TRUE FALSE	BOOL
EIInput.CommandCodeEcho	0000 0000		DWORD
EIInput.ResponseCode	0		UDINT



Click **True** in the Modify Column for *EIOutput.ControlFlag.F[0]*(EXE).
The Online Value changes to True.
(EIOutput.ControlFlag.F[0](EXE): Control command execution bit)

Name	Online value	Modify	Data type
EIOutput.ControlFlag.F[0]	True	TRUE FALSE	BOOL
EIOutput.CommandCode	0010 1020	00101020	DWORD
EIInput.StatusFlag.F[0]	True	TRUE FALSE	BOOL
EIInput.CommandCodeEcho	0010 1020		DWORD
EIInput.ResponseCode	0		UDINT

- 5 The measurement is completed and OK is displayed on the screen of the Touch Finder.

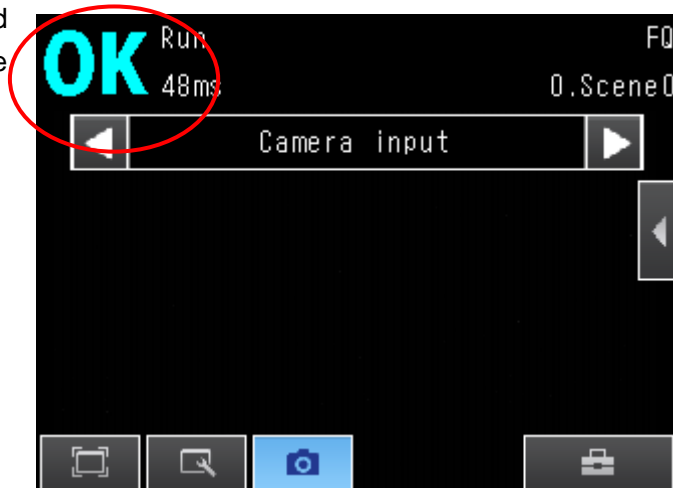

- 6 The values of *EIInput.StatusFlag.F[0]*(FLG), *EIInput.CommandCodeEcho* and *EIInput.ResponseCode* change as follows:

- EIInput.StatusFlag.F[0](FLG): [TRUE]
- EIInput.CommandCodeEcho: [00101020]
(The sent command code is returned.)
- EIInput.ResponseCode:[0]
(The execution result of the command (0: OK, -1(FFFFFFFF):NG) is reflected.)

Name	Online value	Modify	Data type
EIOutput.ControlFlag.F[0]	True	TRUE FALSE	BOOL
EIOutput.CommandCode	0010 1020	00101020	DWORD
EIInput.StatusFlag.F[0]	True	TRUE FALSE	BOOL
EIInput.CommandCodeEcho	0010 1020		DWORD
EIInput.ResponseCode	0		UDINT

8. Initialization Method

This document explains the setting procedure from the factory default setting.

Some settings may not be applicable as described in this document unless you use the devices with the factory default setting.

8.1. Controller

To initialize the Controller, it is necessary to initialize the CPU Unit and EtherNet/IP port. Place in the PROGRAM mode before the initialization.

8.1.1. EtherNet/IP Port

Delete the connection information and tag information that are set for the EtherNet/IP port. Follow the procedure below to set blank connection information and blank tag information and delete them using the Network Configurator.

(1)Deleting connection information

In the Connections Tab Page of the Edit Device Parameters Dialog Box, move all devices registered in the Register Device List to the Unregister Device List by using the UP Button. If a confirmation dialog is displayed when you remove devices from the registration list, click the **Yes** Button.

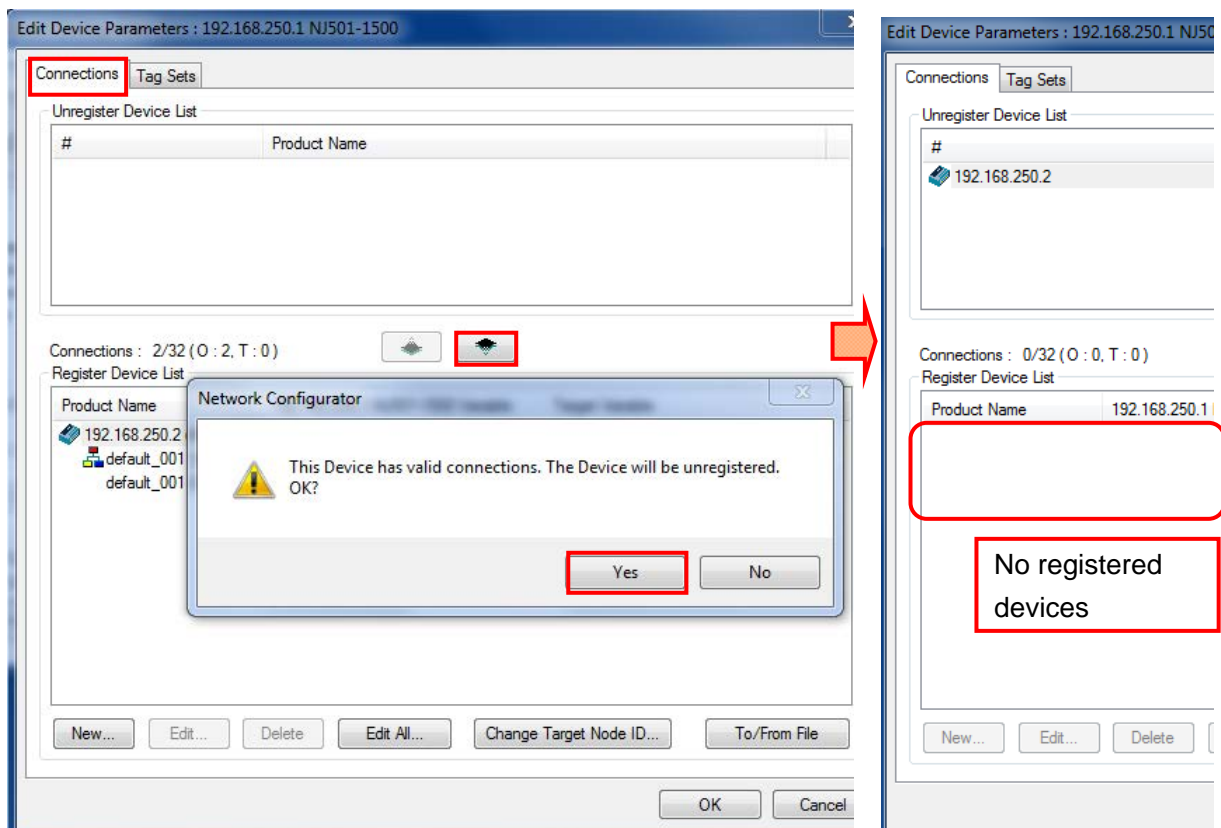

(2)Deleting tag information

In the Tag Sets Tab Page of the Edit Parameters Dialog Box, click the **Delete all of unused Tag Sets** Button. Delete tags in both tab pages: In - Consume Tab Pages and Out - Produce Tab Page.

If a confirmation dialog box is displayed when deleting, click the **Yes** Button.

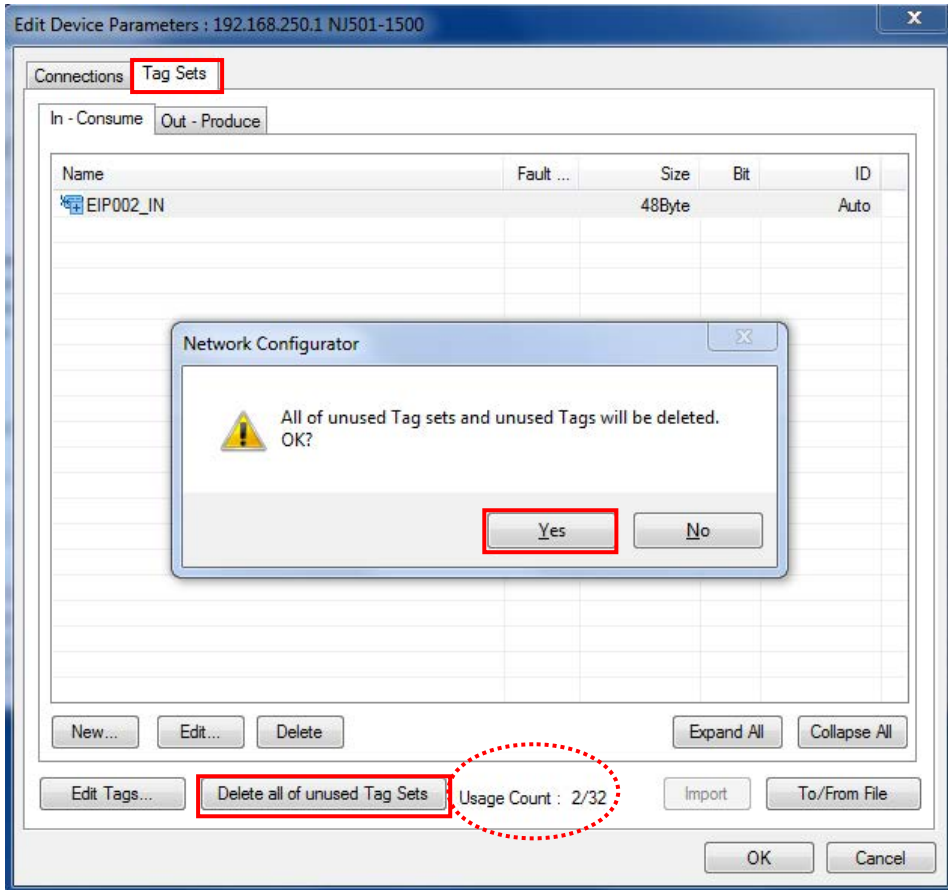

No registered tags

Usage Count : 0/32

(3)Download

Right-click the Controller and select **Parameter - Download** from the menu that is displayed.

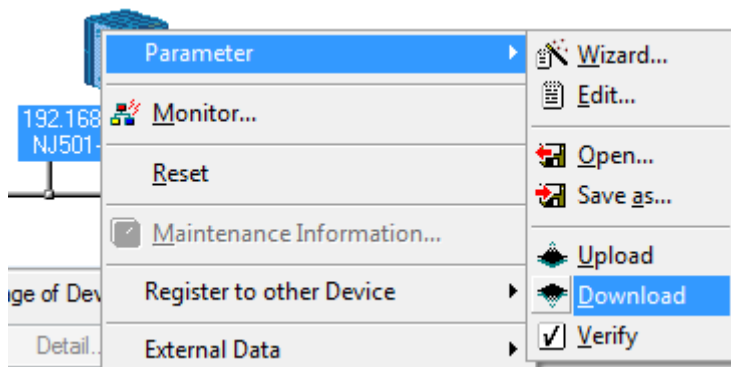

8.1.2. CPU Unit

To initialize the settings of the Controller, select **Clear All Memory** from the Controller Menu of the Sysmac Studio.

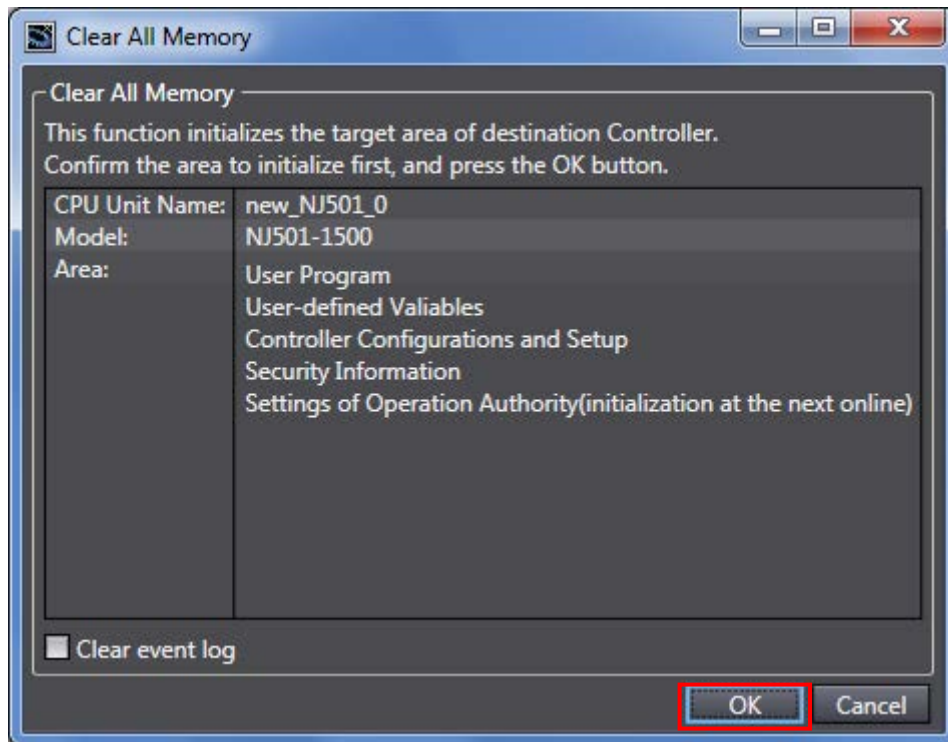

8.2. Smart Camera

For information on how to initialize the Smart Camera, refer to *Initializing the Sensor and Touch Finder* in *7-11 Functions Related to the System* of the *FQ2 Smart Camera User's Manual* (Cat. No. Z326).

9. Appendix 1 Detailed Settings of the Tag Data Links

This section describes the detailed settings necessary to perform tag data links set in this document.

9.1. Global Variable Table

The Controller accesses the data in the tag data links as global variables. The following are the settings of the global variables. Register a global variable table with the Sysmac Studio.

Name	Data type	Network publish	Destination device allocation
EIPOutput	S_EIPOutput	Output	Output data (20Byte)
EIPInput	S_EIPInput	Input	Input data (48Byte)

9.1.1. Data Types

The following data types are used for the global variables.

■ Definition of the data type to access the signals (Union)

This data type is used to access the control signals and status signals.

Data type name	Base type
U_EIPFlag	UNION
F	BOOL[32]
W	DWORD

■ Definition of the data type to access the command communications area (Structure)

This data type is used to access the command area

Data type name	Base type	Destination device data
S_EIPOutput	STRUCT	-
ControlFlag	U_EIPFlag	Control flags (32bit)
CommandCode	DWORD	Command code (CMD-CODE)
CommandParam1	UDINT	Command parameter (CMD-PARAM)
CommandParam2	UDINT	
CommandParam3	DINT	

■ Definition of the data type to access the response/output areas (Structure)

This data type is used to access the response/output areas.

Data type name	Base type	Destination device data
S_EIPInput	STRUCT	-
StatusFlag	U_EIPFlag	Status flags (32bit)
CommandCodeEcho	DWORD	Command code (CMD-CODE)
ResponseCode	UDINT	Response code (RES-CODE)
ResponseData	UDINT	Response data (RES-DATA)
OutputData	DINT[8] ^{*1}	Output data 0 to 7 (DATA0 to 7)

*1: Output data size

The data that can be output is determined by the set value of the Output data size setting as follows:

Output data size	Destination device data	Base type
32 bytes (Default)	Output data 0 to 7	DINT[8]
64 bytes	Output data 0 to 15	DINT[16]
128 bytes	Output data 0 to 31	DINT[32]
256 bytes	Output data 0 to 63	DINT[64]



Additional Information

For details on the data types, refer to *Accessing Communications Areas Using Variables with NJ-series Controllers* in 9-2 *Outputting Data and Controlling Operation Through EtherNet/IP* of 9 *Connecting through Ethernet* in the *FQ2 Smart Camera User's Manual* (Cat. No. Z326).



Additional Information

With the Sysmac Studio, the data type is expressed as ARRAY[0..2] OF WORD when an array is specified for a data type. However, the data type of an array is simplified in this document (e.g. WORD[3]).

It is possible to set either of the following to specify an array for a data type with the Sysmac Studio.

- ARRAY[0..2] OF WORD
- WORD [3]

In the example above, 3 WORD array elements are secured.

9.2. Relationship between Destination Device and Global Variables

The global variables must be sorted in order of offsets of the destination device when setting the tag data link parameters.

The relationship between the memory allocation (offset) of the destination device and the global variables are shown below.

■ Output area (Controller → Smart Camera)

Offset (word)	Destination device data	Variable name	Data type
+0 and +1	Control flags (32 bits) (Data type: U_EIPFlag)	EIOutput.ControlFlag.F ^{*1}	BOOL[32]
		EIOutput.ControlFlag.W ^{*1}	DWORD
+2 and +3	Command code (CMD-CODE)	EIOutput.CommandCode	DWORD
+4 and +5	Command parameter (CMD-PARAM)	EIOutput.CommandParam1	UDINT
+6 and +7		EIOutput.CommandParam2	UDINT
+8 and +9		EIOutput.CommandParam3	DINT

*1: Allocation of Control flags

Allocation of the *EIOutput.ControlFlag.F* variable

31	30	29	28	27	26	25	24	23	22	21	20	19	18	17	16	15	14	13	12	11	10	9	8	7	6	5	4	3	2	1	0	
																DS A	ER RC LR														TR IG	EX E

EXE: Control command execution bit: Turn ON this bit to send a specified command to execute

TRIG: Measurement execution bit: Turn ON this bit to start measurement.

ERRCLR: Error clear bit: Turn ON this bit to turn OFF the ERROR signal.

DSA: Data output request bit: Turn ON this bit to request next data output.

■ Input area (Controller ← Smart Camera)

Offset (word)	Destination device data	Variable name	Data type
+0 and +1	Status flags (32bit) (Data type: U_EIPFlag)	EIPInput.StatusFlag.F ^{*1}	BOOL[32]
		EIPInput.StatusFlag.W ^{*1}	DWORD
+2 and +3	Command code (CMD-CODE)	EIPInput.CommandCodeEcho	DWORD
+4 and +5	Response code (RES-CODE)	EIPInput.ResponseCode	UDINT
+6 and +7	Response data (RES-DATA)	EIPInput.ResponseData	DINT
+8 and +9	Output data 0(DATA0)	EIPInput.OutputData	DINT[8] ^{*2}
+10 and +11	Output data 1(DATA1)		
+12 and +13	Output data 2(DATA2)		
+14 and +15	Output data 3(DATA3)		
+16 and +17	Output data 4(DATA4)		
+18 and +19	Output data 5(DATA5)		
+20 and +21	Output data 6(DATA6)		
+22 and +23	Output data 7(DATA7)		

*1: Allocation of Status flags

Allocation of the *EIPInput.StatusFlag.F* variable

31	30	29	28	27	26	25	24	23	22	21	20	19	18	17	16	15	14	13	12	11	10	9	8	7	6	5	4	3	2	1	0	
																GATE	ERR											RUN	OR	READY	BUSY	FLG

FLG: Control command completion bit: Turns ON when the execution of the command is completed

BUSY: Command execution active bit: Turns ON during the execution of the command

READY: Ready bit: Turns ON when a command can be executed.

OR: Overall judgment bit: Turns ON when the overall judgment result is NG.

RUN: RUN mode display bit: Turns ON during RUN mode.

ERR: Error bit: Turns ON when an error is detected.

GATE: Data output completed bit: Turns ON when data output is completed.

*2: Output data size

The output data that is specified for the data output method is output.

The data that can be output is determined by the set value of the Output data size setting as follows:

Offset (word)	Output data size	Destination device data	Data type
+8 to +23	32 bytes (Default)	Output data 0 to 7	DINT[8]
+8 to +39	64 bytes	Output data 0 to 15	DINT[16]
+8 to +71	128 bytes	Output data 0 to 31	DINT[32]
+8 to +135	256 bytes	Output data 0 to 63	DINT[64]



Additional Information

For details on the command codes and response codes, refer to *9-2 Outputting Data and Controlling Operation Through EtherNet/IP of 9 Connecting through Ethernet* in the *FQ2 Smart Camera User's Manual* (Cat. No. Z326).



Additional Information

For information on how to set output data items (position, etc.), refer to *Setting the Data to Output Automatically after Measurements* in *9-2 Outputting Data and Controlling Operation Through EtherNet/IP of 9 Connecting through Ethernet* in the *FQ2 Smart Camera User's Manual* (Cat. No. Z326).

9.3. Associating the Tag Data Links

Tag data link parameters are required to perform tag data links with the destination device. Follow the procedure below to associate the tag data links.

- (1) Use the Sysmac Studio to define the global variables to publish on the network.
Store the created global variables in a CSV file to use in the Network Configurator.
- (2) Read the CSV file (tag list) created in step 1 to the Network Configurator.
- (3) Install the EDS file of the destination device in the Network Configurator.
- (4) Make a single tag set that includes the tag lists.
- (5) Link the tag set with the destination device information and create tag data link parameters.

The numbers shown in the tables below correspond to the steps above.

■ Output area (Controller → Smart Camera)

Controller setting (Set with Sysmac Studio.)		Tag data link parameter setting (Set with Network Configurator.)		Destination device information (EDS file setting contents)	
(1)		Tag set: EIPOutput	20 bytes (5)	← (3)	Output_100-[20 Bytes]
Global variable (Data type)		(4)	Tag list		*For details, refer to <i>Section 9.2.</i>
EIPOutput	S_EIPOutput → (2)	EIPOutput	(20 bytes)		

■ Input area (Controller ← Smart Camera)

Controller setting (Set with Sysmac Studio.)		Tag data link parameter setting (Set with Network Configurator.)		Destination device information (EDS file setting contents)	
(1)		Tag set: EIPIInput	48 bytes (5)	← (3)	Input_101 - [48 bytes]
Global variable (Data type)		(4)	Tag list		*For details, refer to <i>Section 9.2.</i>
EIPIInput	S_EIPIInput → (2)	EIPIInput	(48 bytes)		

10. Appendix 2 Setting Procedure without the Configuration Files

This section describes the procedure for setting the Controller without using the configuration files (Procedure for setting parameters from the beginning).

It also describes the procedure for changing the parameters of the configuration files.

10.1. Overview of Setting Procedure without the Configuration Files

The following figure shows the relationship of processes to perform tag data links using the "procedure for setting parameters from the beginning".

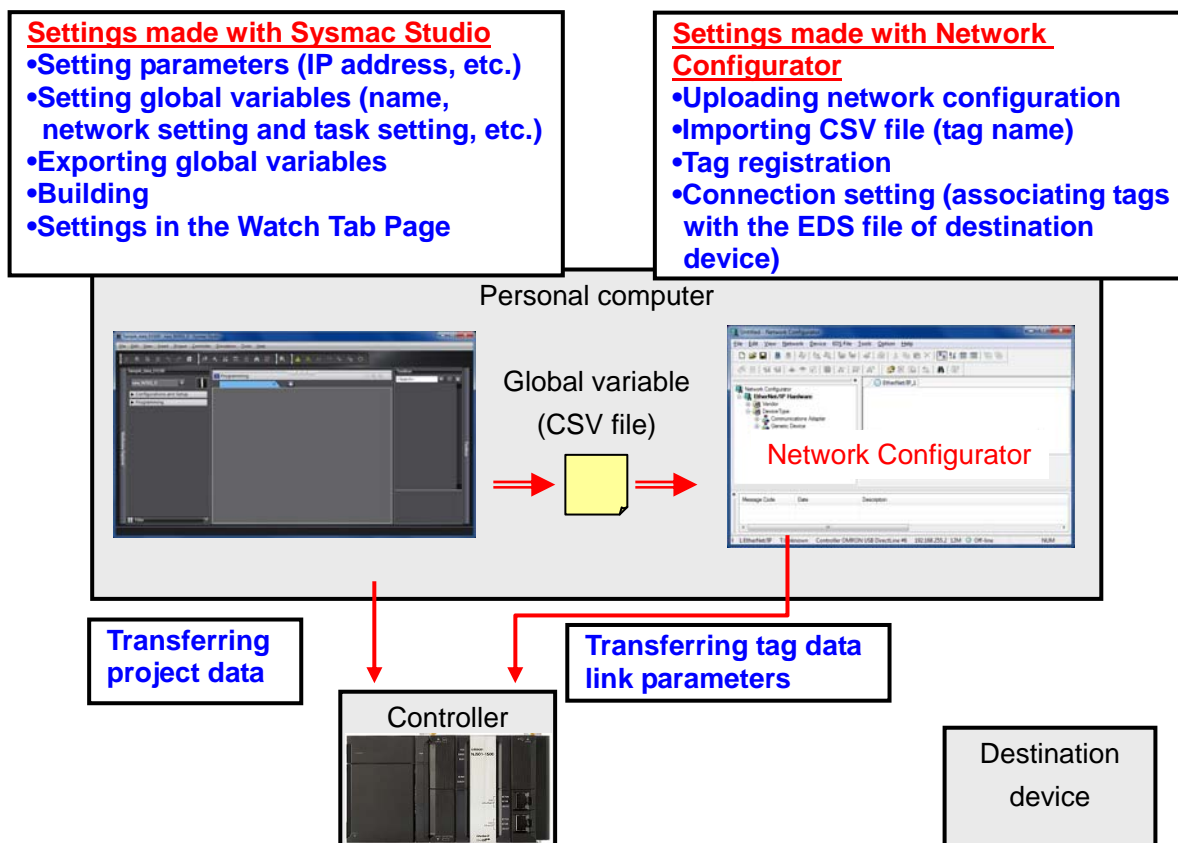

10.2. Work Flow of "Procedure for Setting Parameters from the Beginning"

Use the following procedures to make connection settings for tag data links of EtherNet/IP using the "procedure for setting parameters from the beginning".

This section describes the detailed procedures for "10.3 Setting up the Controller without the Configuration Files" and "10.4 Setting up the Network with Network Configurator" (in red frames below) without using the "configuration files".

The procedures for 7.3 Setting up the Smart Camera and 7.6 Checking the Connection Status" are the same as for the "procedure for using the configuration files". Refer to the procedures in Section 7.

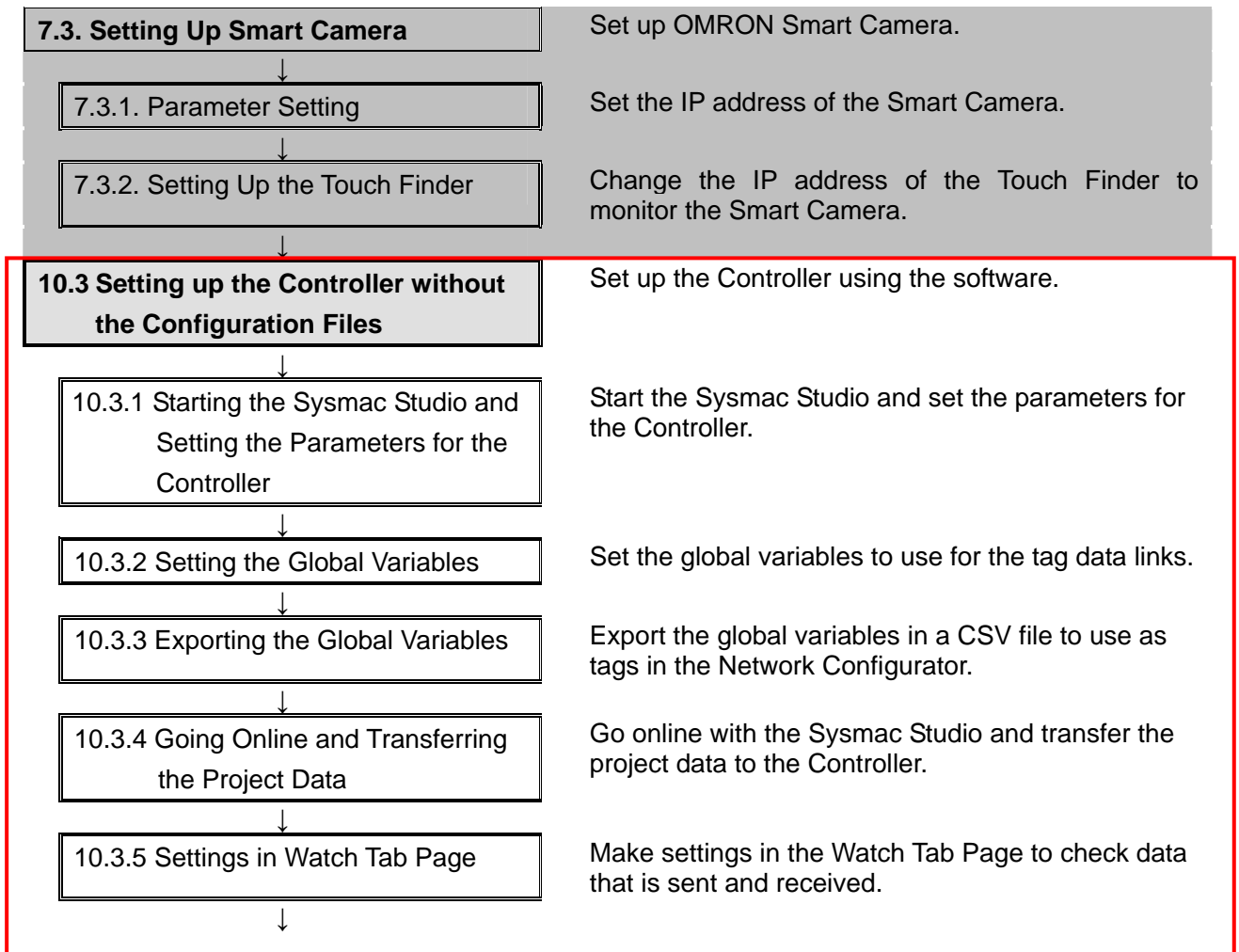

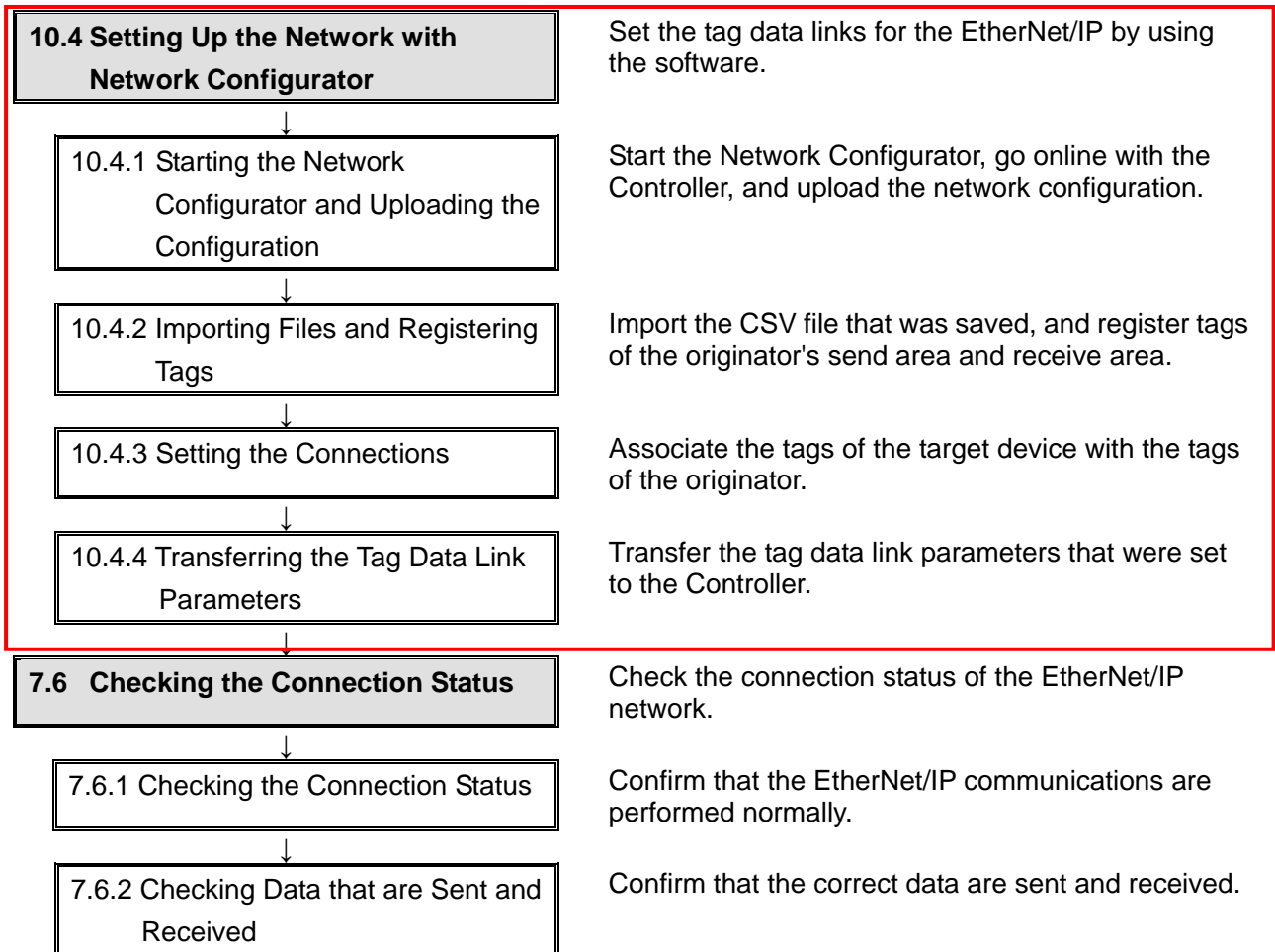

10.3. Setting Up the Controller without the Configuration Files

Set up the Controller using the software.

10.3.1. Starting the Sysmac Studio and Setting the Parameters for the Controller

Start the Sysmac Studio and set the parameters for the Controller.

- 1 Connect the LAN cable and USB cable to the Controller and turn ON the power supply to the Controller.
*For details, refer to step 1 in 7.4.1 Starting the Sysmac Studio and Importing the Project File.

- 2 Start the Sysmac Studio. Click the **New Project** Button.

*If a confirmation dialog for an access right is displayed at start, select to start.

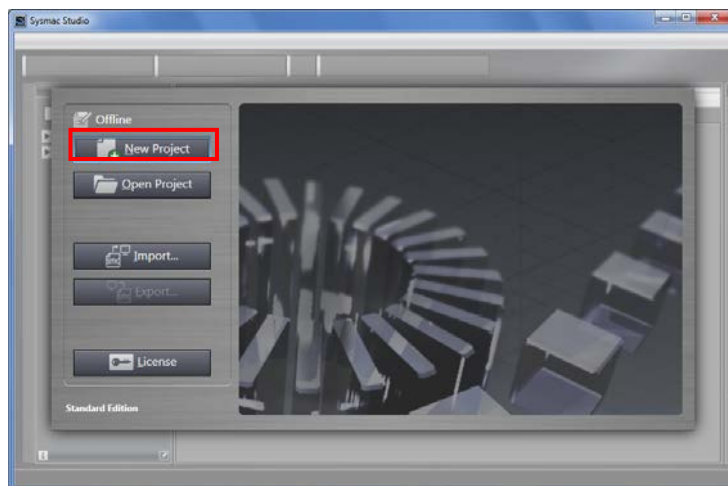

- 3 The Project Properties Dialog Box is displayed.

*In this document, New Project is set as the project name.

Confirm that the Category and Device to use are set in the Select Device Field.

Select 1.03 from the Version pull-down menu.

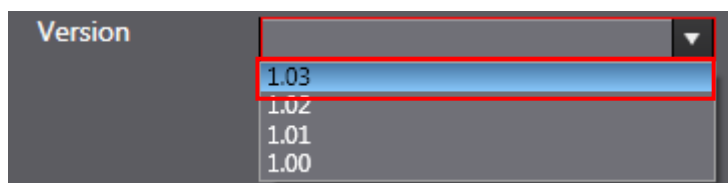
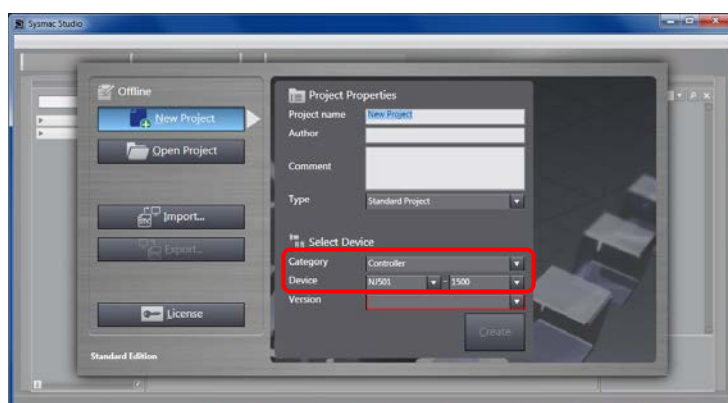

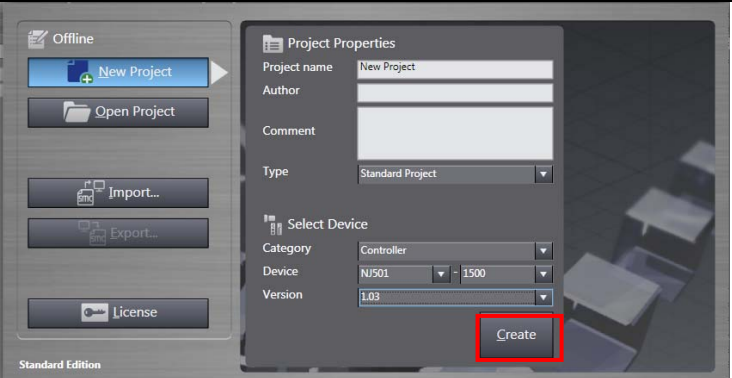
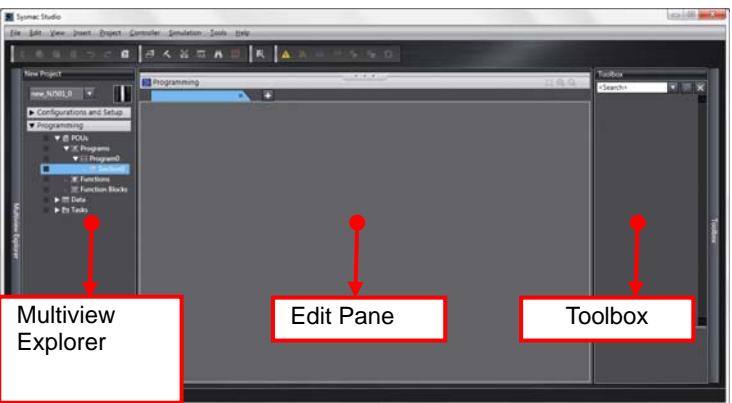
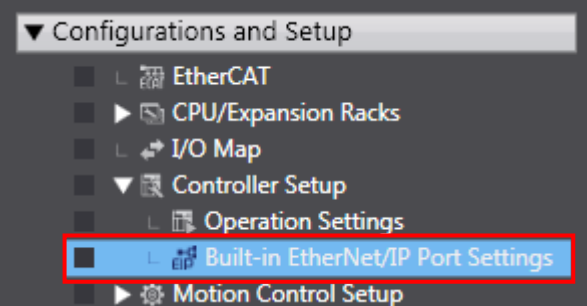
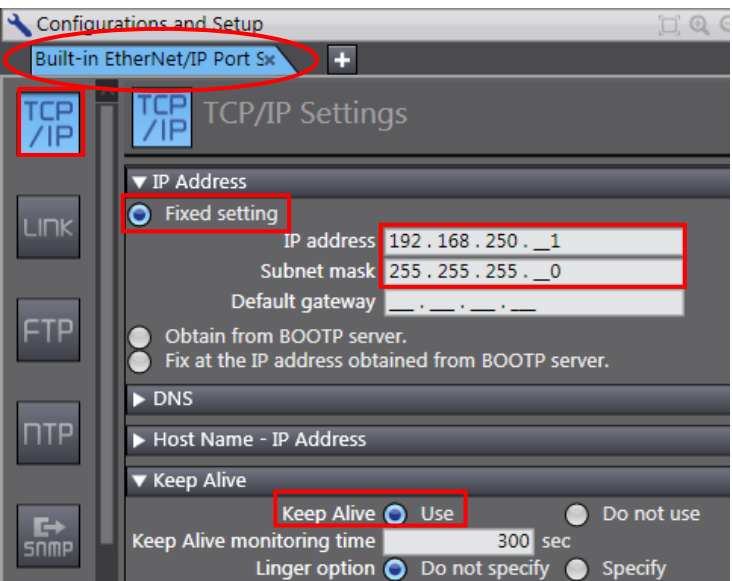
<p>4 Click the Create Button.</p>	
<p>5 The New Project is displayed. The left pane is called Multiview Explorer, the right pane is called Toolbox and the middle pane is called Edit Pane.</p>	
<p>6 Double-click Built-in EtherNet/IP Port Settings under Configurations and Setup - Controller Setup in the Multiview Explorer.</p>	
<p>7 The Built-in EtherNet/IP Port Settings Tab Page is displayed in the Edit Pane. Click the TCP/IP Settings Button, select the <i>Fixed Setting</i> Option in the IP Address Field, and make the following settings. IP address: 192.168.250.1 Subnet mask: 255.255.255.0 Keep Alive: Use</p>	

10.3.2. Setting Global Variables

Set the global variables to use for the tag data links.

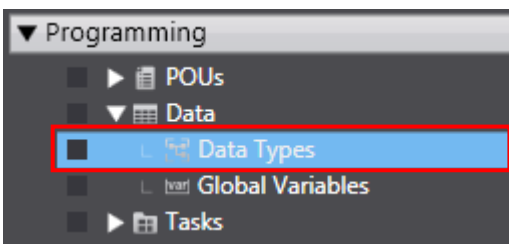
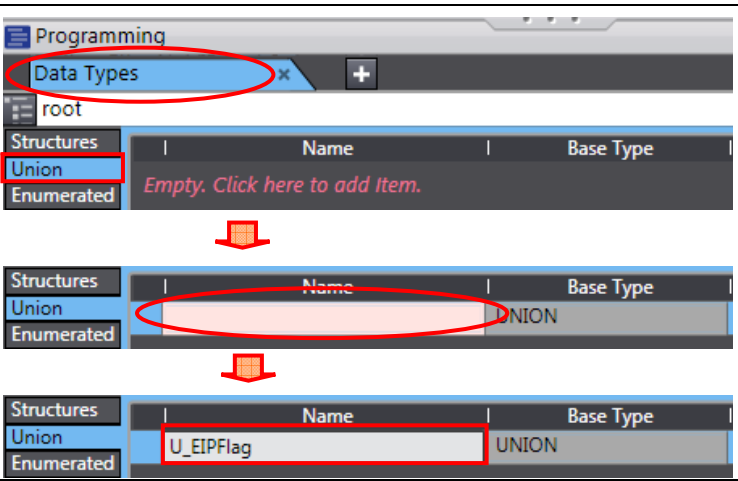
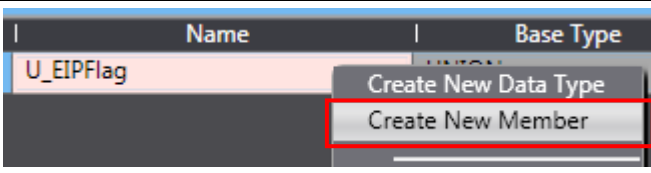
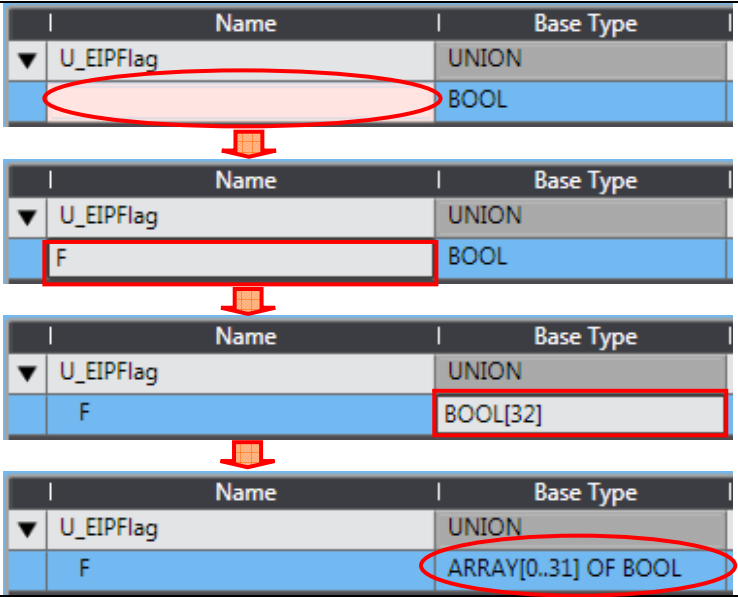
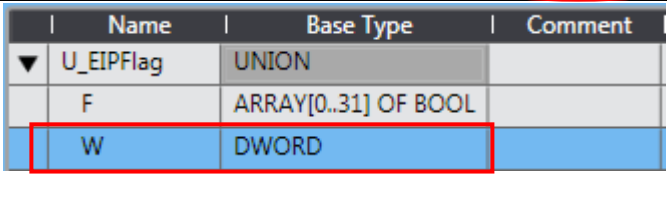
<p>1</p>	<p>Double-click Data Types under Programming - Data in the Miltiview Explorer.</p>	
<p>2</p>	<p>Click the Union in the Data Types Tab Page.</p> <p>Click a column under Name to enter a new item.</p> <p>Enter <i>U_EIPFlag</i> in the Name Column.</p>	
<p>3</p>	<p>After entering, right-click and select Create New Member from the menu.</p>	
<p>4</p>	<p>A new row is added.</p> <p>Type F in the Name Column.</p> <p>Enter BOOL[32] in the Base Type.</p> <p>*After entering, the base type changes to ARRAY[0..31] OF BOOL as shown on the right.</p>	
<p>5</p>	<p>In the same way as steps 3 and 4, enter the following data in new columns.</p> <ul style="list-style-type: none"> •Name: W <p>Base type: DWORD</p>	

6 Click **Structures**.

Click a column under Name to enter a new item.

Enter *S_EIPOutput* in the Name Column.

7 After entering, right-click and select **Create New Member** from the menu.

8 A new row is added.

Enter *ControlFlag* in the Name Column.

Enter *U_EIPFlag* in the Base Type Column.

9 Enter the following data in the new columns in the same way as steps 7 and 8.

- Name: *CommandCode*
Base Type: *DWORD*
- Name: *CommandParam1*
Base Type: *UDINT*
- Name: *CommandParam2*
Base Type: *UDINT*
- Name: *CommandParam3*
Base Type: *DINT*

*Make sure to sort the member list in order of the offsets shown in 9.2. Relationship between Destination Device and Global Variables.

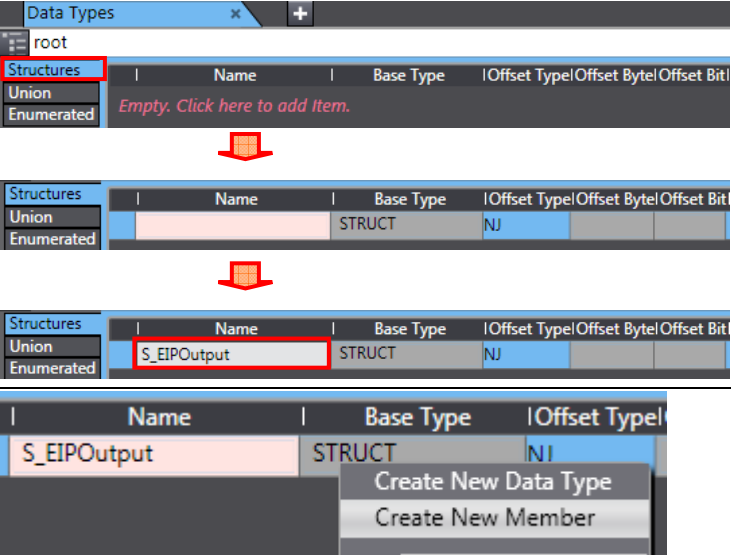

Structures	Name	Base Type	Offset Type	Offset Byte	Offset Bit
Union					
Enumerated	Empty. Click here to add Item.				

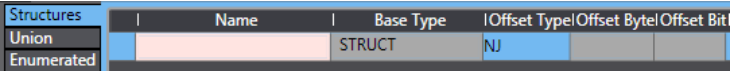

Structures	Name	Base Type	Offset Type	Offset Byte	Offset Bit
Union		STRUCT	NJ		
Enumerated					

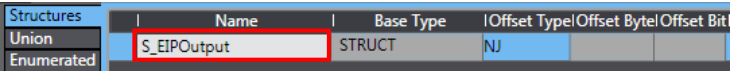

Structures	Name	Base Type	Offset Type	Offset Byte	Offset Bit
Union	S_EIPOutput	STRUCT	NJ		
Enumerated					

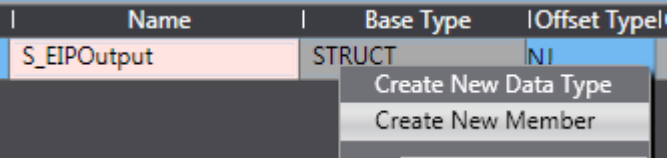

Name	Base Type	Offset Type
S_EIPOutput	STRUCT	NJ

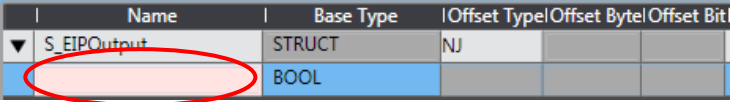

Name	Base Type	Offset Type	Offset Byte	Offset Bit
▼ S_EIPOutput	STRUCT	NJ		
	BOOL			

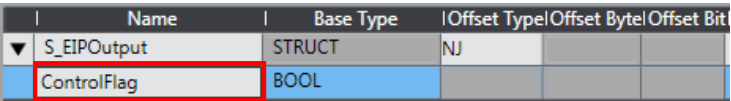

Name	Base Type	Offset Type	Offset Byte	Offset Bit
▼ S_EIPOutput	STRUCT	NJ		
ControlFlag	BOOL			



Name	Base Type	Offset Type	Offset Byte	Offset Bit
▼ S_EIPOutput	STRUCT	NJ		
ControlFlag	U_EIPFlag			

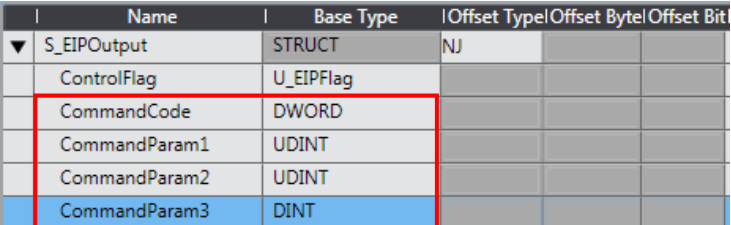

Name	Base Type	Offset Type	Offset Byte	Offset Bit
▼ S_EIPOutput	STRUCT	NJ		
ControlFlag	U_EIPFlag			
CommandCode	DWORD			
CommandParam1	UDINT			
CommandParam2	UDINT			
CommandParam3	DINT			

10 After entering, right-click and select **Create New Data Type** from a menu.

Name	Base Type	Offset Type	Offset
▼ S_EIPOutput	STRUCT	NJ	
ControlFlag	U_EIPFlag		
CommandCode	DWORD		
CommandParam1	UDINT		
CommandParam2	UDINT		
CommandParam3	DINT		

Create New Data Type
 Create New Member



Enter *S_EIPInput* in the Name Column.

Name	Base Type	Offset Type	Offset	Byte	Bit
▼ S_EIPOutput	STRUCT	NJ			
ControlFlag	U_EIPFlag				
CommandCode	DWORD				
CommandParam1	UDINT				
CommandParam2	UDINT				
CommandParam3	DINT				
S_EIPInput	STRUCT	NJ			

11 Enter the following data in the new columns in the same way as steps 7 and 8.

- Name: StatusFlag
Base type: U_EIPFlag
- Name: CommandCodeEcho
Base type: DWORD
- Name: ResponseCode
Base type: UDINT
- Name: ResponseData
Base type: DINT
- Name: OutputData
Base type: DINT[8]

Name	Base Type	Offset Type	Offset	Byte	Bit
▼ S_EIPOutput	STRUCT	NJ			
ControlFlag	U_EIPFlag				
CommandCode	DWORD				
CommandParam1	UDINT				
CommandParam2	UDINT				
CommandParam3	DINT				
▼ S_EIPInput	STRUCT	NJ			
StatusFlag	U_EIPFlag				
CommandCodeEcho	DWORD				
ResponseCode	UDINT				
ResponseData	DINT				
OutputData	ARRAY[0..7] OF DINT				

12 Double-click **Global Variables** under **Programming - Data** in the Multiview Explorer.

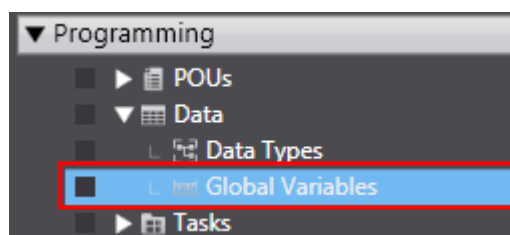

13 The Global Variables Tab Page is displayed in the Edit Pane.

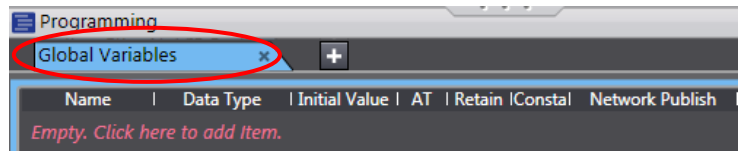

Click a column under Name to enter a new variable.

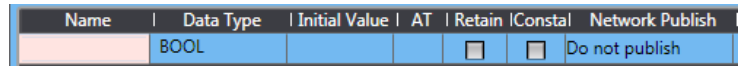

Enter *EIPOutput* in the Name Column.

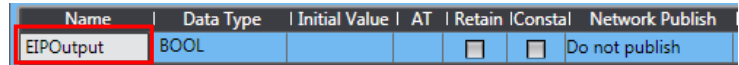

Enter *S_EIPOutput* in the Data Type Column.

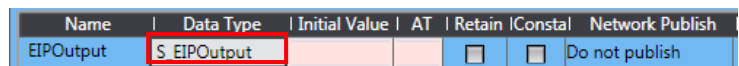

Select **Output** from the Network Publish Menu.

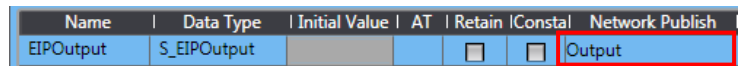
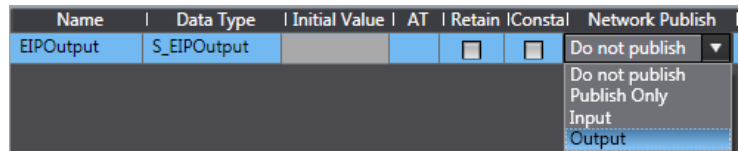

14 After entering, right-click and select **Create New** from the menu.

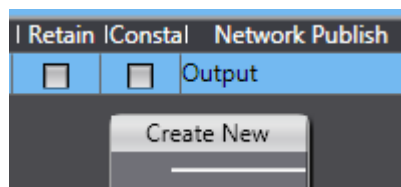

15 Enter the following data in the new columns in the same way as step 13.

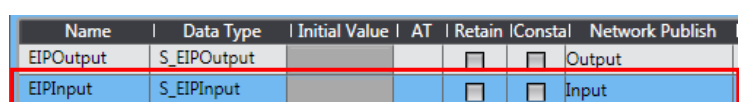

- Name: EIPIInput
- Data type: S_EIPIInput
- Network Publish: Input

16 Double-click **Task Settings** under **Configurations and Setup** in the Multiview Explorer. The Task Settings Tab Page is displayed in the Edit Pane. Click the **VAR** Button and then click the **+** Button.

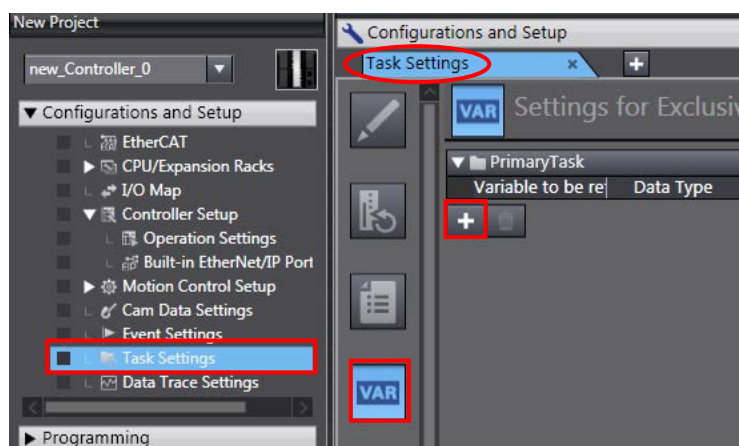

17 Click the Down Button under Variable to be refreshed. The variables set in steps 2 to 5 are displayed.
Select *EIPOutput*.

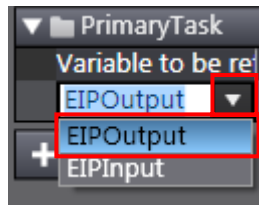

18 Click the + Button and select a variable to be refreshed.
*The data types are displayed automatically, and they do not have to be set.

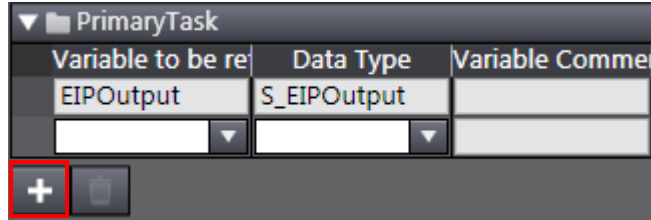

Add all variables set in steps 13 and 15 as shown in the right figure.

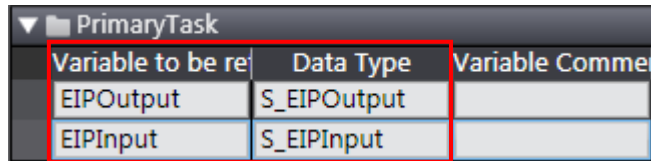

10.3.3. Exporting the Global Variable

Export the global variables in a CSV file to use as tags in the Network Configurator.

- 1 Double-click **Global variables** under **Programming - Data** in the Multiview Explorer.

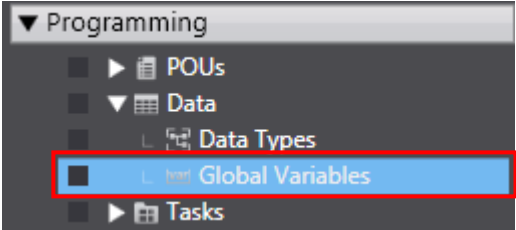

- 2 The Global Variables Tab is displayed in the Multiview Explorer. Right-click on the pane and Select **Select All**.

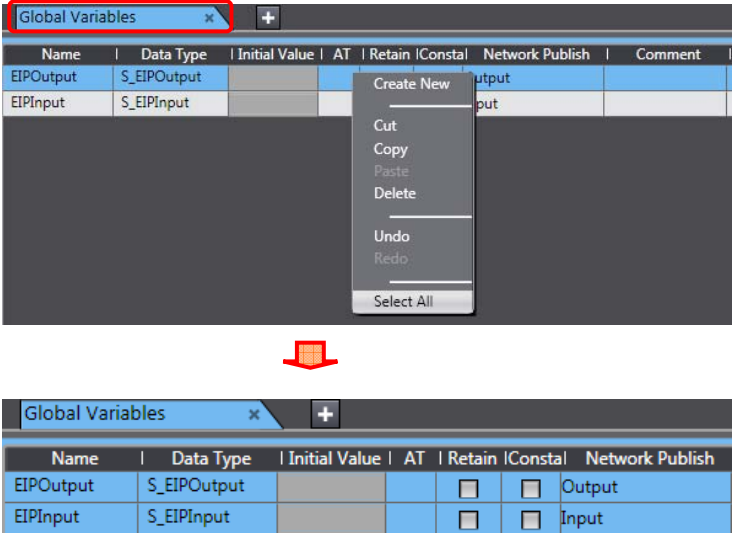
All the selected variables are highlighted.

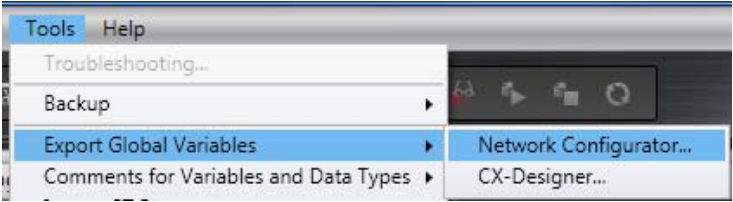

Name	Data Type	Initial Value	AT	Retain	Constal	Network Publish	Comment
EIPOutput	S_EIPOutput						
EIPInput	S_EIPInput						

Name	Data Type	Initial Value	AT	Retain	Constal	Network Publish	Comment
EIPOutput	S_EIPOutput			<input type="checkbox"/>	<input type="checkbox"/>	Output	
EIPInput	S_EIPInput			<input type="checkbox"/>	<input type="checkbox"/>	Input	
- 3 Select **Export Global Variables - Network Configurator** from the Tools Menu.

- 4 The Save As Dialog Box is displayed. Enter EIP002 in the File name Field. Click the **Save** Button.

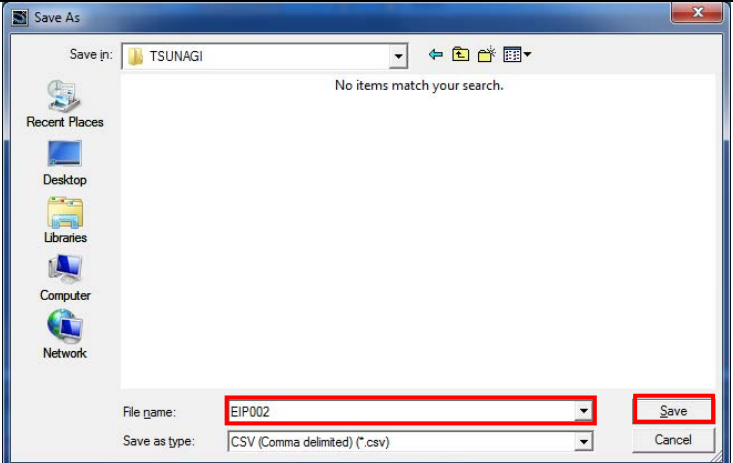

10.3.4. Going Online and Transferring the Project Data

Connect online with the Sysmac Studio and transfer the project data to the Controller.

WARNING

Always confirm safety at the destination node before you transfer a user program, configuration data, setup data, device variables, or values in memory used for CJ-series Units from the Sysmac Studio.

The devices or machines may perform unexpected operation regardless of the operating mode of the CPU Unit.

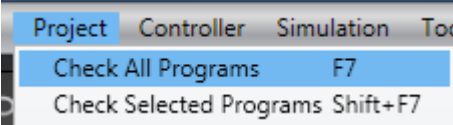
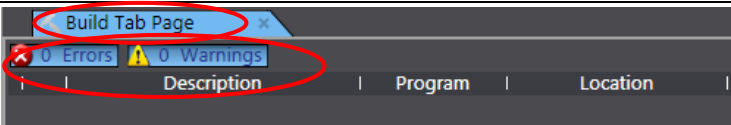
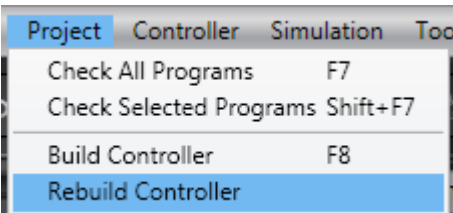
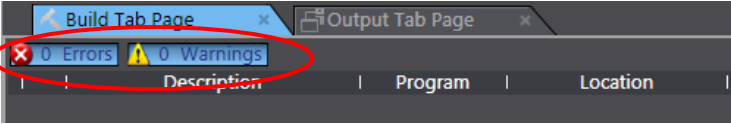
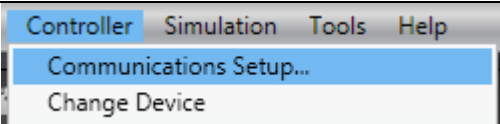

- | | | |
|---|---|--|
| 1 | Select Check All Programs from the Project Menu. |  |
| 2 | The Build Tab Page is displayed in the Edit Pane. Check that "0 Errors" and "0 Warnings" are displayed. |  |
| 3 | Select Rebuild Controller from the Project Menu. |  |
| 4 | Check that "0 Errors" and "0 Warnings" are displayed in the Build Tab Page. |  |
| 5 | Select Communications Setup from the Controller Menu. |  |

6 The Communications Setup Dialog Box is displayed.
 Select the *Direct Connection via USB* Option for Connection Type.
 Click the **OK** Button.

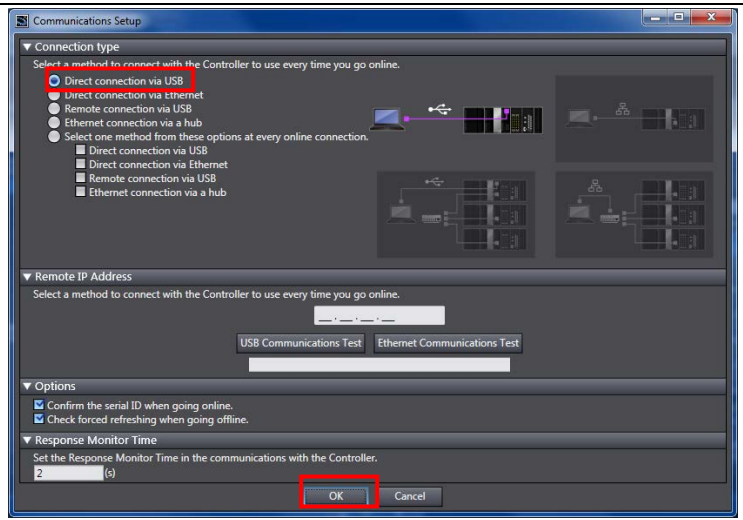

7 Select **Online** from the Controller Menu.
 A confirmation dialog is displayed. Click the **Yes** Button.
 *The displayed dialog depends on the status of the Controller used. Select the **Yes** Button to proceed with the processing.

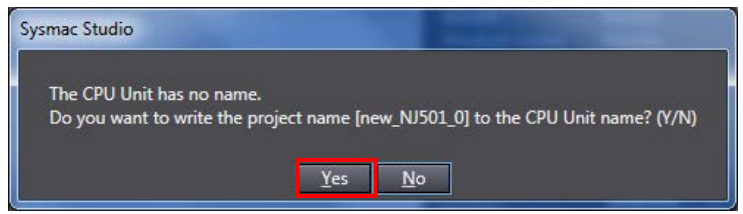
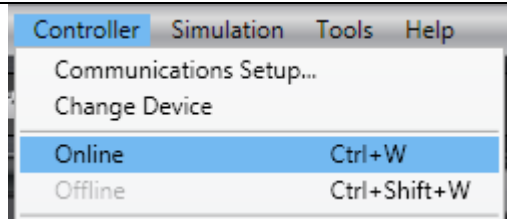

8 When an online connection is established, a yellow bar is displayed on the top of the Edit Pane.

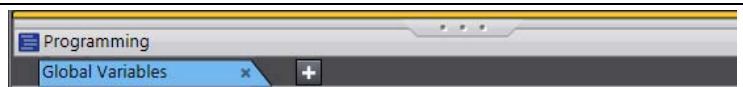

Additional Information

For details on the online connections to a Controller, refer to *Section 5 Going Online with a Controller* in the *Sysmac Studio Version 1.0 Operation Manual (Cat. No. W504)*.

9 Select **Synchronization** from the Controller Menu.

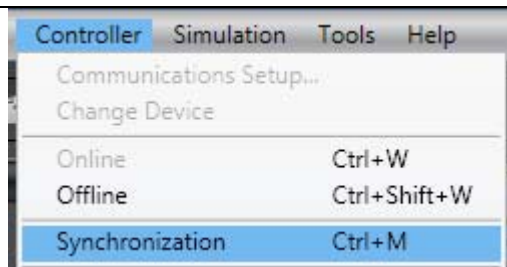

10 The Synchronization Dialog Box is displayed.
Check that the data to transfer (NJ501 in the right figure) is selected. Then, click the **Transfer to Controller** Button.

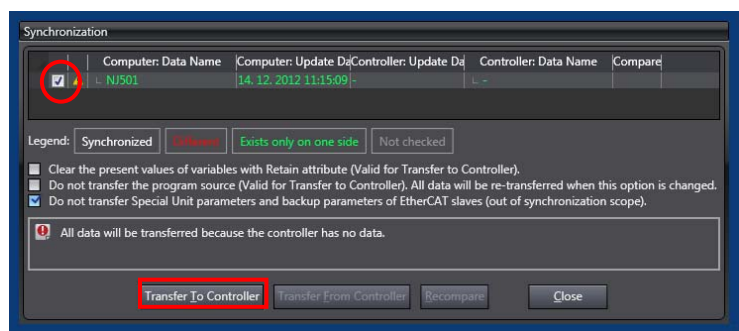

11 A confirmation dialog is displayed. Click the **Yes** Button.

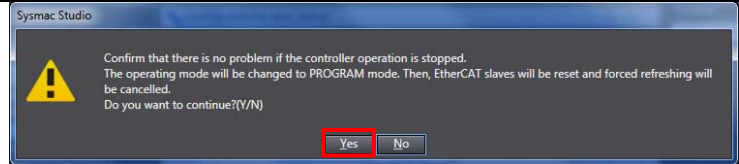

A screen stating "Synchronizing" is displayed.

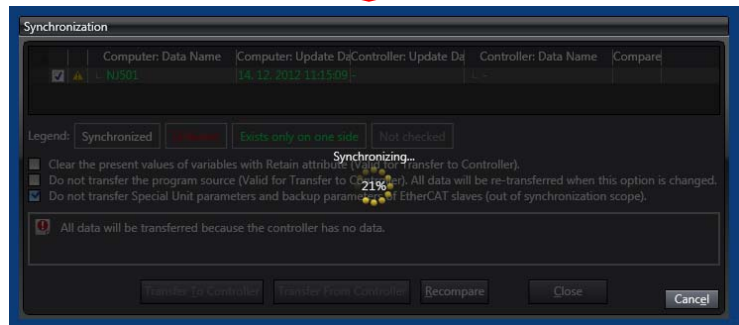

A confirmation dialog is displayed. Click the **Yes** Button.

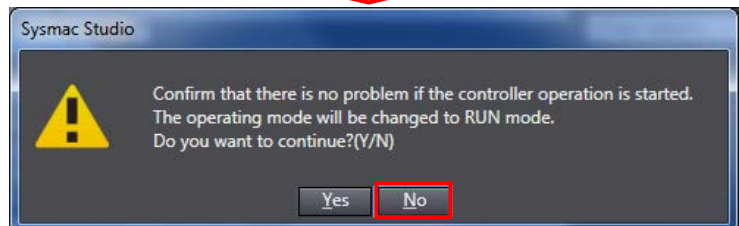

12 Confirm that the synchronized data is displayed with the color specified by "Synchronized", and that a message is displayed stating "The synchronization process successfully finished". If there is no problem, click the **Close** Button.

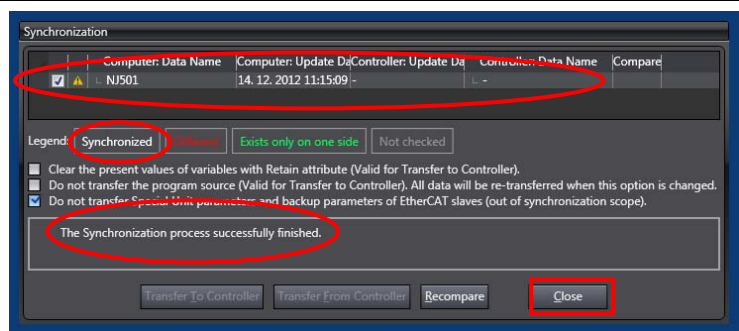

Additional Information

If the synchronization fails, referring to the message that is displayed, please take appropriate action. For details, refer to *10-3 Error Messages for Sysmac Studio Operation in the Sysmac Studio Version 1 Operation Manual (Cat. No. W504)*.

10.3.5. Settings in the Watch Tab Page

Make settings in the Watch Tab Page to check data that is sent and received.

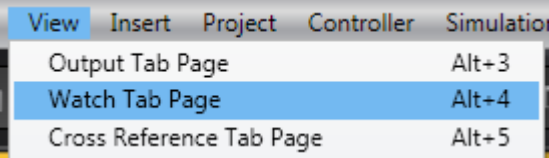
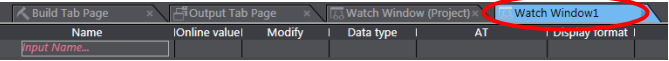
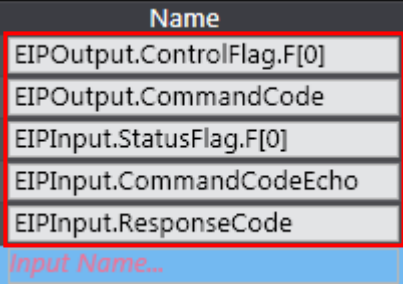
1	<p>Select Watch Tab Page from the View Menu.</p>	
2	<p>The Watch Tab Page 1 is displayed in the lower section of the Edit Pane.</p>	
3	<p>Enter the following names to monitor in the Name Columns on the Watch Tab Page 1. To enter a new name, click a cell stating <i>Input Name</i>.</p> <ul style="list-style-type: none"> EIPOutput.ControlFlag.F[0](EXE) EIPOutput.CommandCode EIPInput.StatusFlag.F[0](FLG) EIPInput.CommandCodeEcho EIPInput.ResponseCode <p>*The settings are used in 7.6.2. Checking Data That are Sent and Received.</p>	

10.4. Setting Up the Network with Network Configurator

Set the tag data links for the EtherNet/IP by using the software.



Precautions for Correct Use

Please confirm that the LAN cable is connected before proceeding to the following steps. If it is not connected, turn OFF the power to the devices, and then connect the LAN cable.

10.4.1. Starting Network Configurator and Uploading Configuration

Start the Network Configurator and install the EDS file.

<p>1 Start the Network Configurator.</p>	
<p>2 Select Select Interface - NJ Series USB Port from the Option Menu.</p>	
<p>3 Select Connect from the Network Menu.</p>	

- 4 The Select Connect Network Port Dialog Box is displayed. Select **TCP:2** and click the **OK** Button.

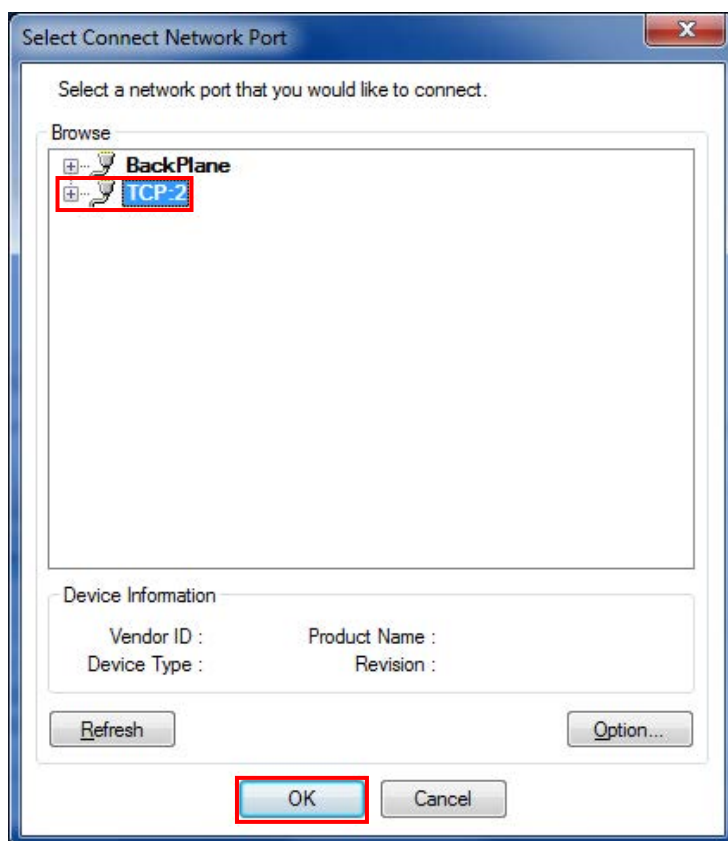

- 5 The Select Connected Network Dialog Box is displayed. Click the **OK** Button.

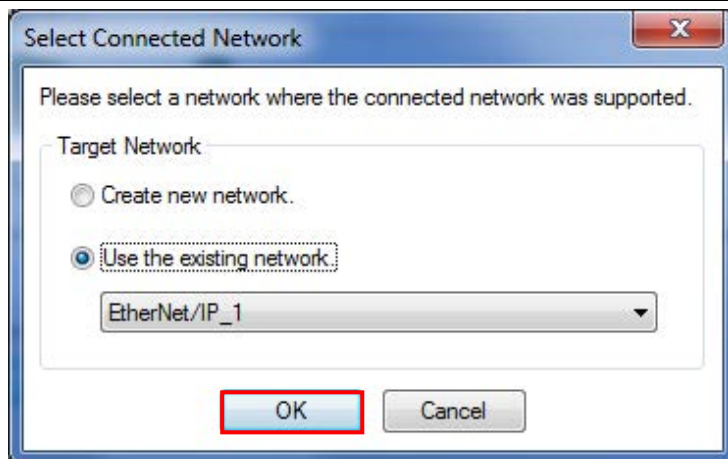

Precautions for Correct Use

If an online connection cannot be made to the Controller, check the cable connection. Or, return to step 2 and check the settings such as a connection type and try again.



Additional Information

For details on the online connections to a Controller, refer to 7-2-8 *Connecting the Network Configurator to the Network* in Section 7 *Tag Data Link Functions* of the *NJ-series CPU Unit Built-in EtherNet/IP Port User's Manual* (Cat. No. W506).

6 When an online connection has been established normally, the icon shown on the figure turns blue.

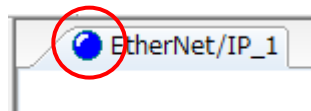

7 Select **Upload** from the Network Menu to upload the device information on the network.

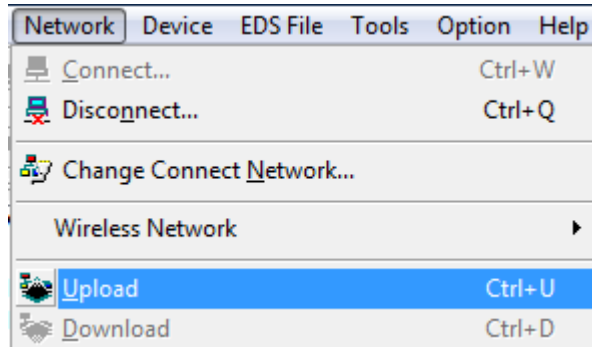

8 The dialog box on the right is displayed. Click the **Yes** Button.

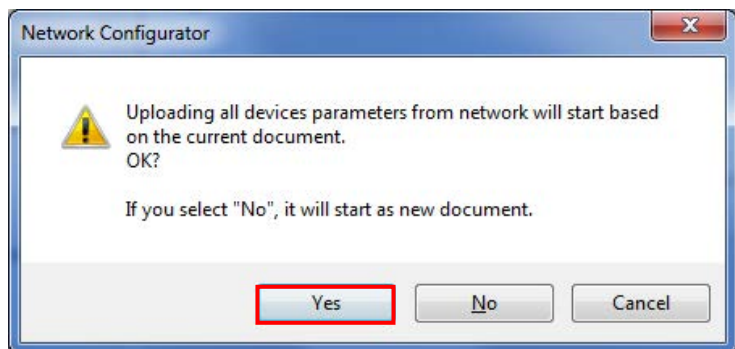

9 The Target Device Dialog Box is displayed. Click the **OK** Button.

*The addresses displayed depend on the environment. Display addresses to connect by using the Add and Edit Button.

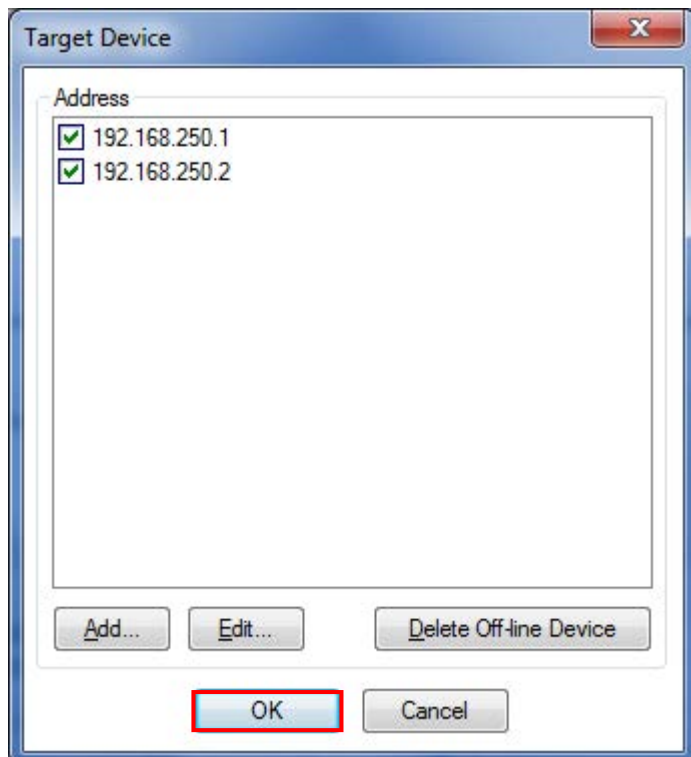

10 The device parameters are uploaded. When uploading is completed, the dialog on the right is displayed. Click the **OK** Button.

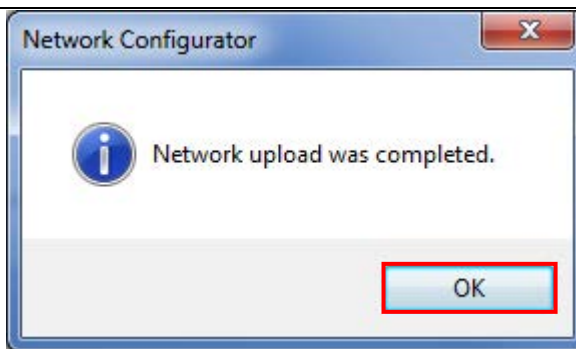

11 After uploading is completed, confirm that the Network Configuration Pane shows the updated IP Addresses of devices.

IP address of node 1:

192.168.250.1

IP address of node 2

192.168.250.2

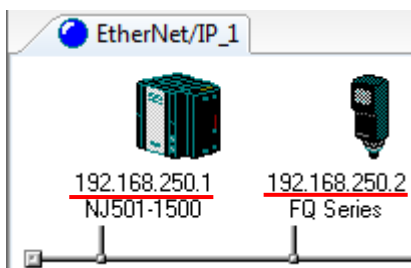

12 Right-click the node 2 device and select **Parameter - Edit**.

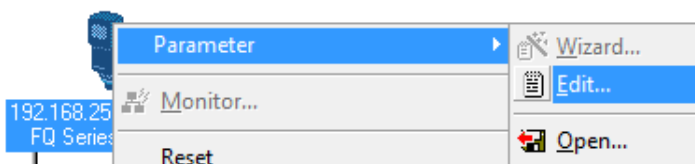

13 The Edit Device Parameters Dialog Box is displayed. Confirm that the values are set as follows and click the **OK** Button.

- Output Size :20

- Input Size :48

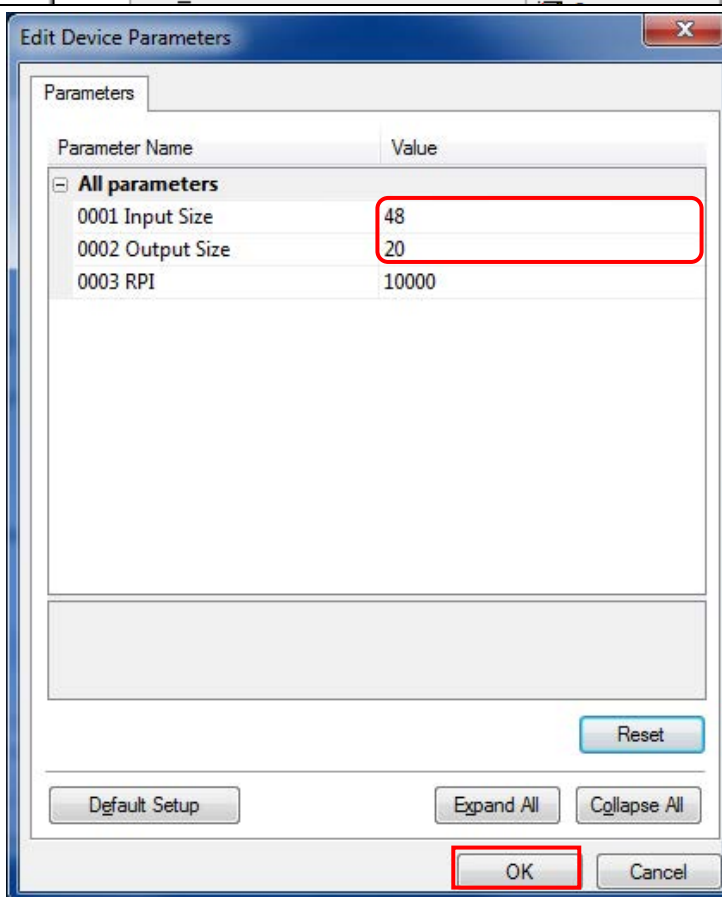

10.4.2. Importing the File and Registering the Tags

Import the CSV file that was saved, and register tags of the originator's send area and receive area.

This section explains the receive settings and send settings of the target node.

- 1 On the Network Configuration Pane of the Network Configurator, right-click the node 1 device and select **Parameter - Edit**.

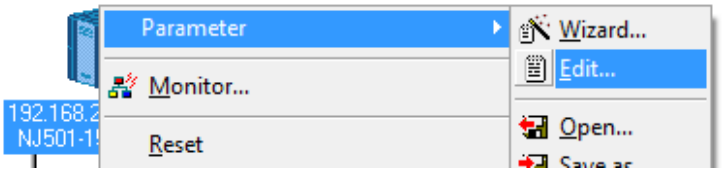
- 2 The Edit Device Parameters Dialog Box is displayed. Click the **To/From File** Button.

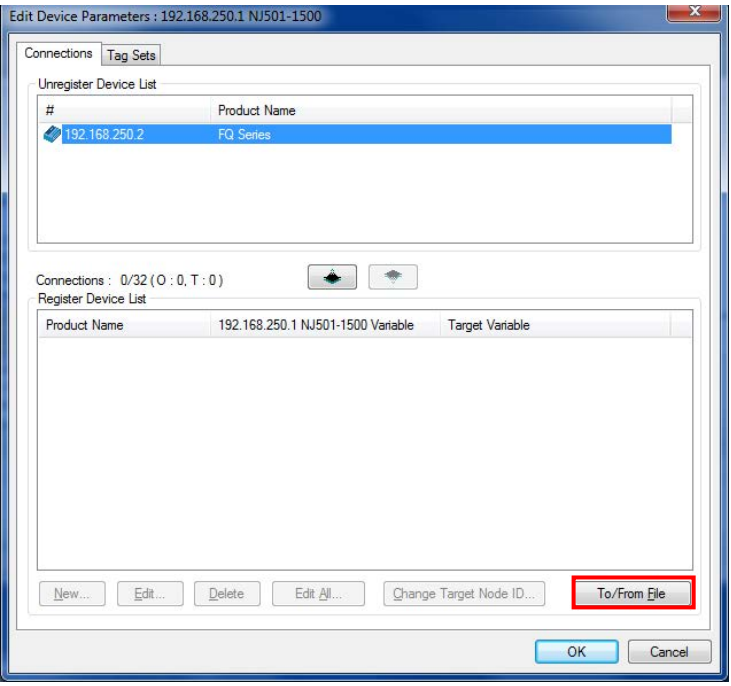
- 3 Select **Import from File**.

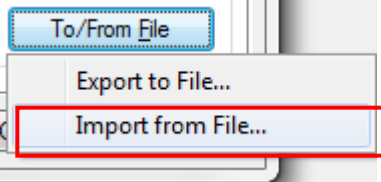

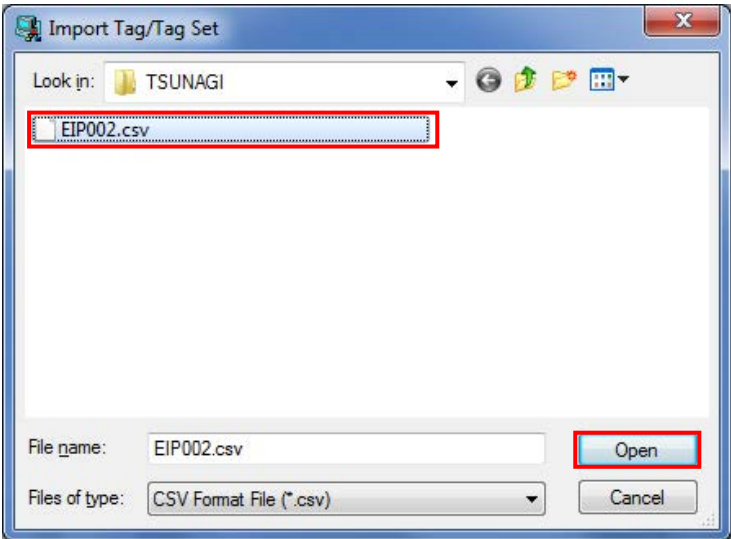
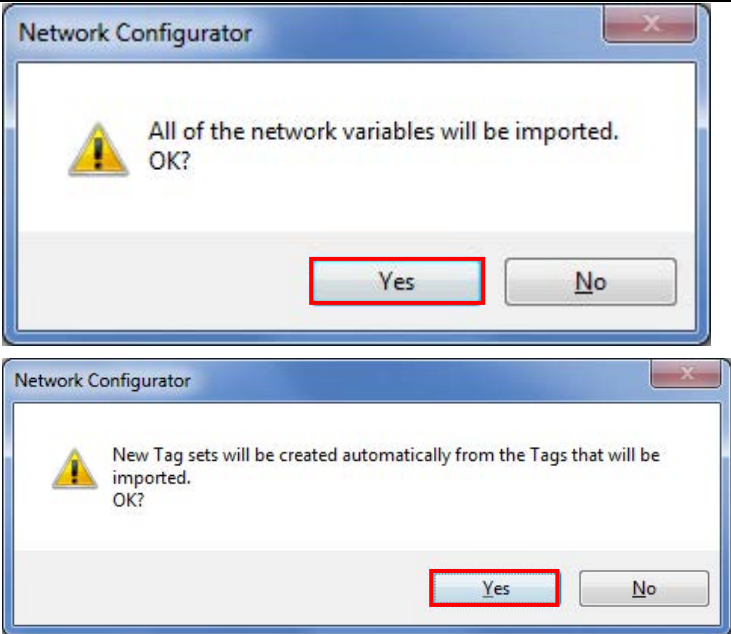
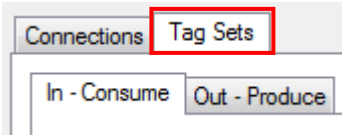
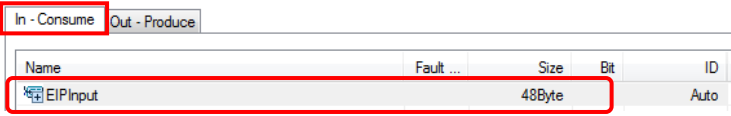
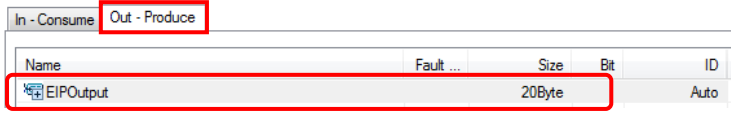
- 4 The Import Tag/Tag Set Dialog Box is displayed. Select EIP002.csv and click the **Open** Button.
- *In the Look in Field, specify the folder in which the file is saved in Section 10.3.3. Exporting the Global Variables.
- 
- 5 The dialog boxes on the right may not be displayed depending on the status of the Controller and the software used. If not displayed, proceed to the next step.
- Click the **Yes** Button on the right dialog box.
- Click the **Yes** Button on the right dialog box.
- 
- 6 The Edit Device Parameters Dialog Box is displayed again. Click the Tag Sets Tab.
- 
- 7 Select the In-Consume Tab. EIPInput and 48Byte are displayed.
- 
- | Name | Fault ... | Size | Bit | ID |
|----------|-----------|--------|-----|------|
| EIPInput | | 48Byte | | Auto |
- 8 Select the Out-Produce Tab Page. EIPOutput and 20Byte are displayed.
- 
- | Name | Fault ... | Size | Bit | ID |
|-----------|-----------|--------|-----|------|
| EIPOutput | | 20Byte | | Auto |

10.4.3. Setting the Connections

Associate the tags of the target device (that receives the open request) with the tags of the originator (that requests opening).

- 1 Select the Connections Tab in the Edit Device Parameters Dialog Box. Then, select 192.168.250.2 in the Unregister Device List Field. Click the Down Button that is shown in the dialog.

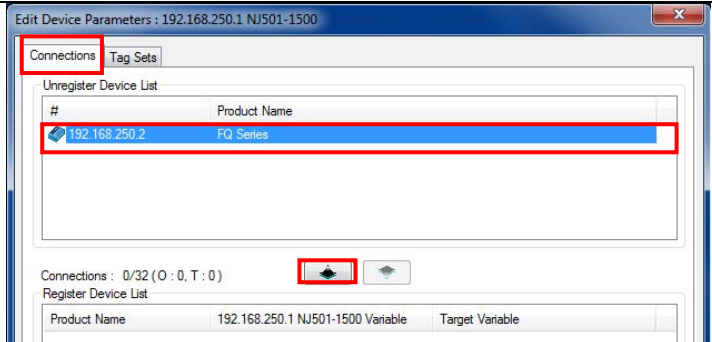

- 2 192.168.250.2 is registered in the Register Device List. Select 192.168.250.2 and click the **New** Button.

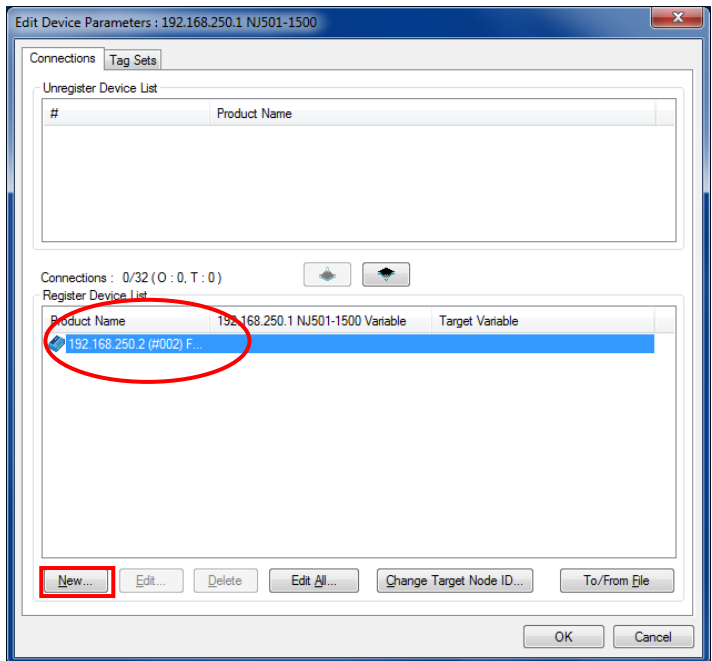

- 3 The Edit Connection Dialog Box is displayed. Select *Consume Data From/Produce Data To* from the Connection I/O Type Pull-down Menu. In the same way, set the value listed in the table below in each field of Originator Device and Target Device.

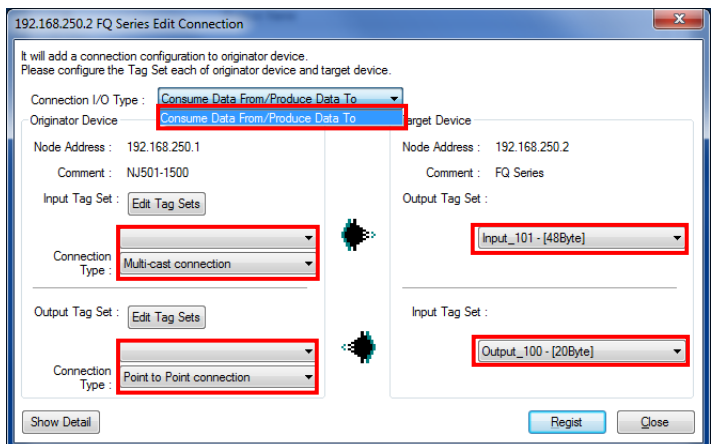

■ Settings of Connections

Connection I/O type		Consume Data From/Produce Data To
Originator device	Input Tag Set	EIPInput – [48Byte]
	Connection Type	Multi-cast connection
	Output Tag Set	EIPOutput – [20Byte]
	Connection Type	Point to Point connection
Target Device	Output Tag Set	Input_101 – [48Byte]
	Input Tag Set	Output_100 – [20Byte]

4 Confirm that settings are correct and click the **Regist** Button.

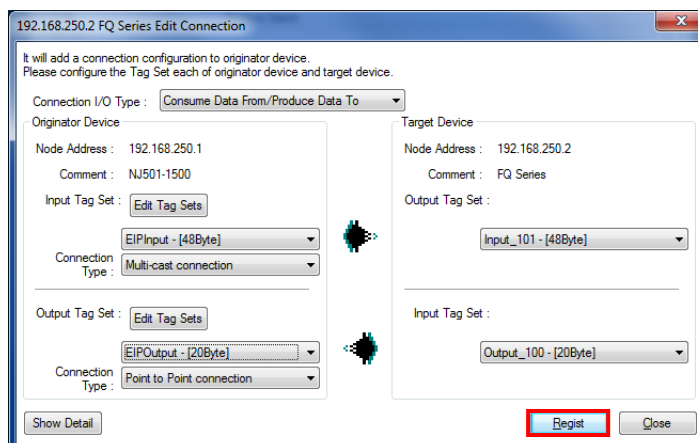

5 The Edit Connection Dialog Box is displayed. Do not make any setting and click the **Close** Button.

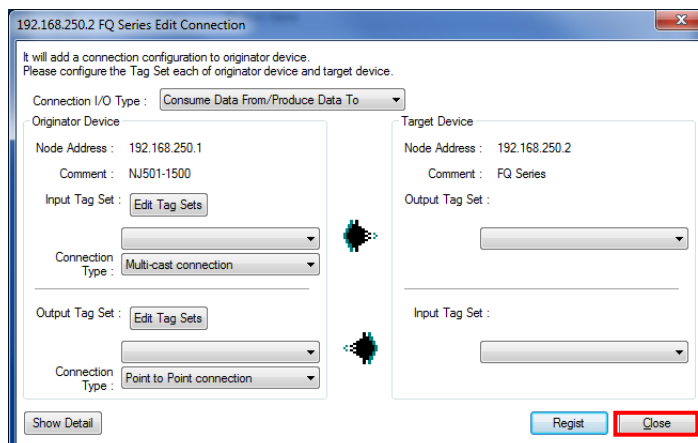

- 6 The Edit Device Parameters Dialog Box is displayed again. Click the **OK** Button.

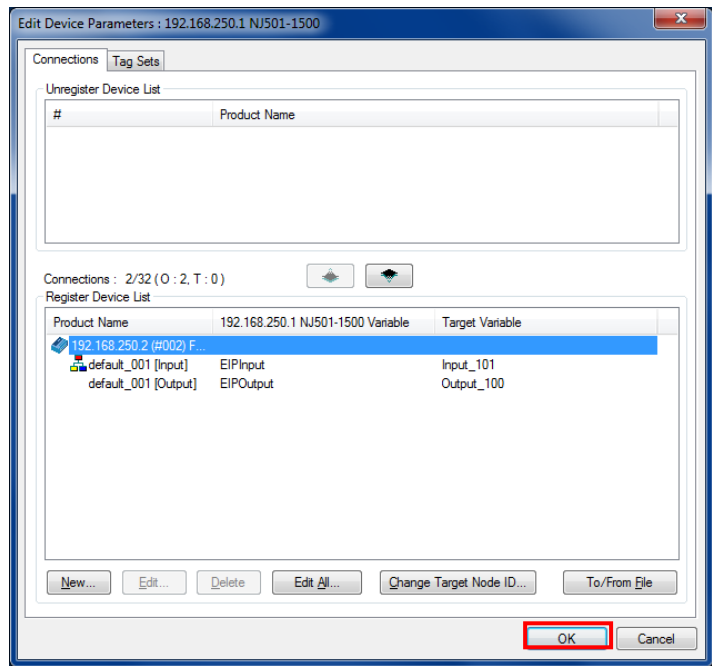

- 7 When the connection setting is completed, the node address is displayed under the device icon on the Network Configuration Pane.

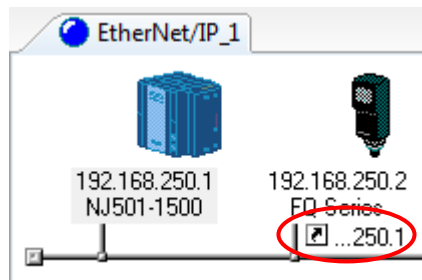

10.4.4. Transferring Tag Data Link Parameters

Transfer the tag data link parameters that were set to the Controller.

- 1 Right-click node 1 device on the Network Configuration Pane and select **Parameter - Download**.

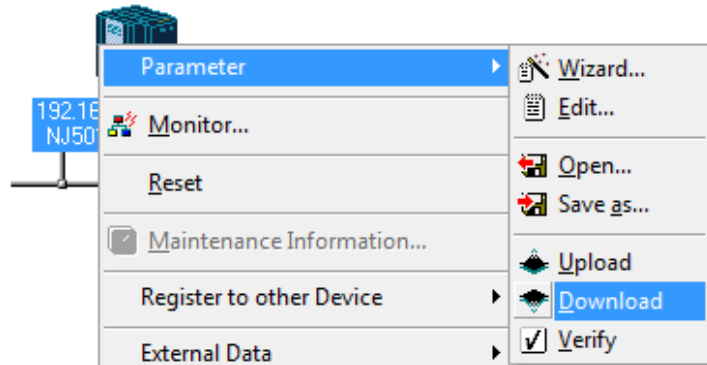

The dialog on the right is displayed. Click the **Yes** Button.

*The List of Devices that are executing Dialog Box is displayed if the Controller used is in RUN mode. If displayed, click the **Download after changed to Program mode** Button and proceed to the next step.

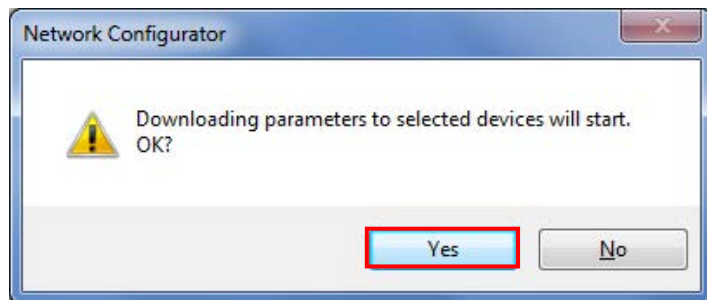

- 2 The tag data link parameters are downloaded from the Network Configurator to the Controller.

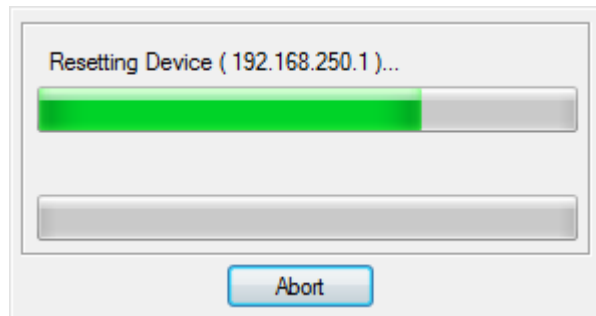

- 3 The dialog box on the right is displayed. Click the **OK** Button.

*If the operating mode was changed in step 1, a confirmation dialog box is displayed. Click the **NO** Button to remain in the current operating mode.

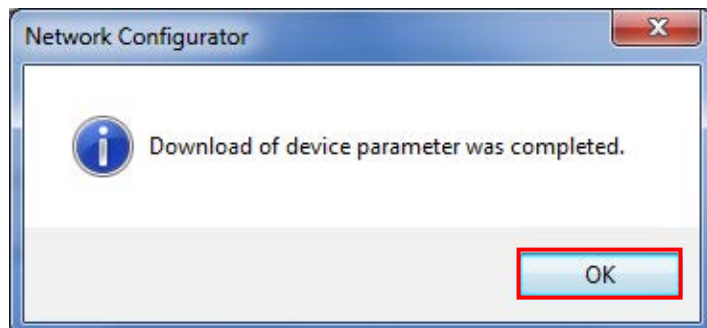

11. Revision History

Revision code	Date of revision	Revision reason and revision page
01	Jul. 18, 2013	First edition

OMRON Corporation Industrial Automation Company

Tokyo, JAPAN

Contact: www.ia.omron.com

Regional Headquarters

OMRON EUROPE B.V.

Wegalaan 67-69-2132 JD Hoofddorp
The Netherlands

Tel: (31)2356-81-300/Fax: (31)2356-81-388

OMRON ELECTRONICS LLC

One Commerce Drive Schaumburg,
IL 60173-5302 U.S.A.

Tel: (1) 847-843-7900/Fax: (1) 847-843-7787

OMRON ASIA PACIFIC PTE. LTD.

No. 438A Alexandra Road # 05-05/08 (Lobby 2),
Alexandra Technopark,
Singapore 119967

Tel: (65) 6835-3011/Fax: (65) 6835-2711

OMRON (CHINA) CO., LTD.

Room 2211, Bank of China Tower,
200 Yin Cheng Zhong Road,
PuDong New Area, Shanghai, 200120, China

Tel: (86) 21-5037-2222/Fax: (86) 21-5037-2200

Authorized Distributor:

© OMRON Corporation 2013 All Rights Reserved.
In the interest of product improvement,
specifications are subject to change without notice.

Cat. No. P550-E1-01

0713(-)