

CJ-series

**General-purpose Ethernet Connection Guide
(TCP/IP)**

OMRON Corporation

V750-series RFID System

About Intellectual Property Right and Trademarks

Microsoft product screen shots reprinted with permission from Microsoft Corporation.

Windows is a registered trademark of Microsoft Corporation in the USA and other countries.

Ethernet is a registered trademark of Xerox Corporation.

Java and all Java-related trademarks and logos are trademarks or registered trademarks of Oracle Corporation, Inc., in the USA and other countries.

Company names and product names in this document are the trademarks or registered trademarks of their respective companies.

Table of Contents

1. Related Manuals	1
2. Terms and Definition	2
3. Remarks	3
4. Overview	5
5. Applicable Devices and Support Software	6
5.1. Applicable Devices.....	6
5.2. Device Configuration.....	7
6. Ethernet Communications Settings	9
6.1. Ethernet Communications Settings.....	9
6.2. Example of Connection Check.....	11
7. Connection Procedure	12
7.1. Work Flow	12
7.2. Setting Up the RFID Reader/Writer.....	13
7.3. Setting Up the PLC	19
7.4. Checking the Connection Status	31
8. Initialization Method	35
8.1. Initializing the PLC	35
8.2. Initializing the RFID Reader/Writer.....	37
9. Program	38
9.1. Overview	38
9.2. Destination Device Command.....	43
9.3. Error Detection Processing	45
9.4. Memory Maps	48
9.5. Ladder Program	54
9.6. Timing Charts.....	70
9.7. Error Process	74
10. Revision History	80

1. Related Manuals

The table below lists the manuals related to this document.

To ensure system safety, make sure to always read and heed the information provided in all Safety Precautions, Precautions for Safe Use, and Precaution for Correct Use of manuals for each device which is used in the system.

Cat. No.	Model	Manual name
W472	CJ2H-CPU6[]-EIP CJ2H-CPU6[] CJ2M-CPU[][]	CJ-series CJ2 CPU Unit Hardware User's Manual
W473	CJ2H-CPU6[]-EIP CJ2H-CPU6[] CJ2M-CPU[][]	CJ-series CJ2 CPU Unit Software User's Manual
W420	CJ1W-ETN21	CJ-series Ethernet Units Operation Manual Construction of Networks
W421	CJ1W-ETN21	CJ-series Ethernet Units Operation Manual Construction of Applications
W446	-	CX-Programmer Operation Manual
W474	CJ2[]-CPU[][]	CJ-series Instructions Reference Manual
Z235	V750-BA50C04-US V740-HS01[][]	V750-series UHF RFID System User's Manual

2. Terms and Definition

Terms	Explanation and Definition
IP address	<p>Ethernet uses an IP address to perform communications.</p> <p>The IP address (Internet Protocol address) is an address that is used to identify a node (host computer or controller, etc.) on Ethernet.</p> <p>IP addresses must be set and managed so they do not overlap.</p>
Socket	<p>A socket is an interface that enables the use of the TCP or UDP function directly from the user program. The socket services enable data exchange with destination nodes. The CJ-series Programmable Controller can use the socket services in the following ways:</p> <ul style="list-style-type: none"> •Manipulation of a dedicated control bit allocated in the CIO area for the Ethernet Unit •Issuing a FINS command (CMND instruction) to an Ethernet Unit
Active open/ Passive open	<p>Open processing is executed on each node to connect the TCP socket. The open method depends on whether the node is opened as a server or client.</p> <p>In this document, the method used to open a node as a server is called "passive open" and the method used to open a node as a client is called "active open" or "open processing (active)".</p>
Keep-alive function	<p>When the keep-alive function is used with TCP/IP socket services, the keep-alive communications frame is used to check the status of the connection with the destination node (either a server or client) if there are no communications during the specified time interval.</p> <p>Checks are executed at a certain interval, and if there is no response to any of them then the connection is terminated.</p>
Linger function	<p>This is an option for the TCP socket that enables immediate open processing using the same port number without waiting until the port number opens after RST data is sent when the TCP socket closes.</p> <p>If the linger option is not specified, FIN data will be sent when a TCP socket is closed, and then approximately 1 minute will be required to confirm the transmission and perform other closing management with the destination node. Therefore, it may not be possible to immediately use TCP sockets with the same port number.</p>

3. Remarks

- (1) Understand the specifications of devices which are used in the system. Allow some margin for ratings and performance. Provide safety measures, such as installing safety circuit in order to ensure safety and minimize risks of abnormal occurrence.
- (2) To ensure system safety, always read and heed the information provided in all Safety Precautions, Precautions for Safe Use, and Precaution for Correct Use of manuals for each device used in the system.
- (3) The users are encouraged to confirm the standards and regulations that the system must conform to.
- (4) It is prohibited to copy, to reproduce, and to distribute a part of or whole part of this document without the permission of OMRON Corporation.
- (5) This document provides the latest information as of April 2013. The information on this manual is subject to change for improvement without notice.

The following notation is used in this document.



WARNING

Indicates a potentially hazardous situation which, if not avoided, could result in death or serious injury. Additionally, there may be severe property damage.



Caution

Indicates a potentially hazardous situation which, if not avoided, may result in minor or moderate injury, or property damage.



Precautions for Safe Use

Indicates precautions on what to do and what not to do to ensure using the product safely.



Precautions for Correct Use

Indicates precautions on what to do and what not to do to ensure proper operation and performance.



Additional Information

Provides useful information.

Additional information to increase understanding or make operation easier.

Symbols



The triangle symbol indicates precautions (including warnings).
The specific operation is shown in the triangle and explained in text.
This example indicates a general precaution.



The filled circle symbol indicates operations that you must do.
The specific operation is shown in the circle and explained in text.
This example shows a general precaution for something that you must do.

4. Overview

This document describes the procedure for connecting the RFID Reader/Writer (V750 series) of OMRON Corporation (hereinafter referred to as OMRON) to CJ2-series Programmable Controller + Ethernet Unit (hereinafter referred to as the PLC), and provides the procedure for checking their connection.

Refer to Ethernet communications settings described in 6. Ethernet Communications Settings and 7. Connection Procedure to understand the setting method and key points to connect the devices via Ethernet.

The user program in the prepared CX-Programmer project file is used to check the Ethernet connection by sending/receiving the message of “GETR (read Reader/Writer settings)” to/from the destination device.

Prepare the latest CX-Programmer project file beforehand. To obtain the file, contact your OMRON representative.

Name	File name	Version
CX-Programmer project file (extension: cxp)	OMRON_V750_ETN(TCP)_EV110.cxp	Ver.1.10

*Hereinafter, the CX-Programmer project file is referred to as the “project file”.

The user program in the project file is referred to as the “ladder program” or “program”.

Caution

This document aims to explain the wiring method and communications settings necessary to connect the corresponding devices and provide the setting procedure. The program used in this document is designed to check if the connection was properly established, and is not designed to be constantly used at a site. Therefore, functionality and performances are not sufficiently taken into consideration. When you construct an actual system, please use the wiring method, communications settings and setting procedure described in this document as a reference and design a new program according to your application needs.



5. Applicable Devices and Support Software

5.1. Applicable Devices

The applicable devices are given below.

Manufacturer	Name	Model
OMRON	Ethernet Unit	CJ1W-ETN21
OMRON	CJ2-series CPU Unit	CJ2[]-CPU[][]
OMRON	RFID Reader/Writer (Complies with FCC and EN)	V750-BA50C04-US
OMRON	Antenna	V740-HS01[][]
OMRON	Antenna cable	V740-A01[][]M



Additional Information

As applicable devices above, the devices with the models and versions listed in Section 5.2. are actually used in this document to describe the procedure for connecting devices and checking the connection.

You cannot use devices with versions lower than the versions listed in Section 5.2.

To use the above devices with versions not listed in Section 5.2 or versions higher than those listed in Section 5.2, check the differences in the specifications by referring to the manuals before operating the devices.



Additional Information

This document describes the procedure to establish the network connection. Except for the connection procedure, it does not provide information on operation, installation or wiring method. It also does not describe the function or operation of the devices. Refer to the manuals or contact your OMRON representative.

5.2. Device Configuration

The hardware components to reproduce the connection procedure of this document are as follows:

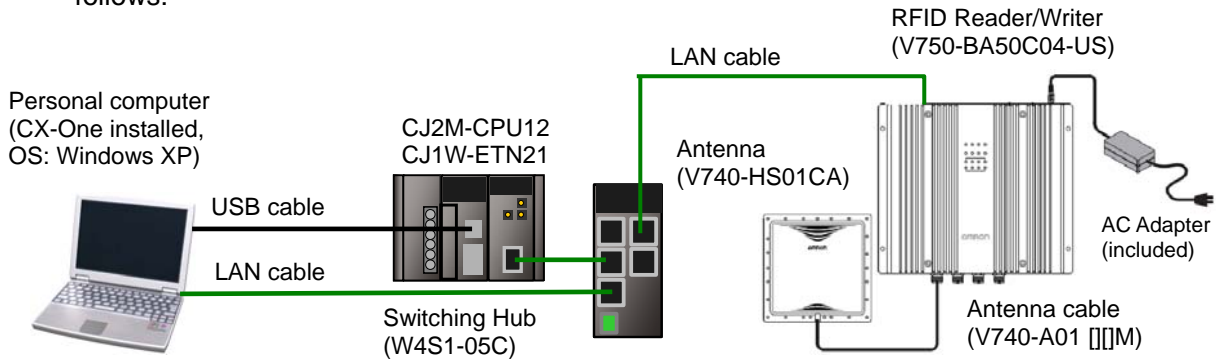

Manufacturer	Name	Model	Version
OMRON	Ethernet Unit	CJ1W-ETN21	Ver.1.5
OMRON	Switching Hub	W4S1-05C	Ver.1.0
OMRON	CPU Unit	CJ2M-CPU12	Ver.2.0
OMRON	Power Supply Unit	CJ1W-PA202	
OMRON	CX-One	CXONE-AL[C-V4 /AL[D-V4	Ver.4.xx
OMRON	CX-Programmer	(Included in CX-One)	Ver.9.41
OMRON	CX-Programmer project file (ladder program)	OMRON_V750_ETN(TCP) _EV110.cxp	Ver.1.10
-	Personal computer (English OS:Windows XP)	-	
-	USB cable (USB 2.0 type B connector)	-	
-	LAN cable	-	
OMRON	RFID Reader/Writer	V750-BA50C04-US	Ver.102- 102-103-0
OMRON	Antenna cable	V740-HS01CA	
OMRON	AC Adapter (Included)	V740-A01 [M	

Precautions for Correct Use

Prepare the latest ladder program beforehand.
(To obtain the files, contact your OMRON representative.)

Precautions for Correct Use

Update the CX-Programmer to the version specified in this section or higher version using the auto update function. If a version not specified in this section is used, the procedures described in Section 7 and subsequent sections may not be applicable. In that case, use the equivalent procedures described in the SYSMAC CX-Programmer Operation Manual (Cat.No. W446).



Additional Information

It may not be possible to reproduce the same operation with different devices or versions. Check the configuration, model and version. If they are different from your configuration, contact your OMRON representative.



Additional Information

The system configuration in this document uses USB for the connection between the personal computer and PLC CPU Unit.

6. Ethernet Communications Settings

This section provides the specifications of the communications parameters that are set in this document and outlines the operation.



Additional Information

To perform communications without using the settings specified in this section, you need to modify the program. For details on the program, refer to 9. *Program*.

6.1. Ethernet Communications Settings

The settings required for Ethernet communications are as follows.

6.1.1. Communications Settings between the Personal Computer and the RFID Reader/Writer

The setting example below is used to explain the setting procedure of the RFID Reader/Writer by using the personal computer.

Setting item	Personal computer used for setting	RFID Reader/Writer
IP address	192.168.1.1	192.168.1.200 (Default)
Subnet mask	255.255.255.0	255.255.255.0 (Default)
Gateway	---.---.---.---	192.168.1.254 (Default)

*In this document, the gateway setting is unnecessary because the connection is made in the same segment.

6.1.2. Communications Settings between the PLC and the RFID Reader/Writer

The setting example below is used to explain the procedure for connecting the PLC to the RFID Reader/Writer.

Setting item	Ethernet Unit	RFID Reader/Writer
Unit number	0 (Default)	-
Node address	01(Default)	-
IP address	192.168.250.1(Default)	192.168.250.2
Subnet mask	255.255.255.0(Default)	255.255.255.0 (Default)
Gateway	---.---.---.---	192.168.1.254 (Default)
Host name	-	"V750-BA50C04-US" (Default)
Domain name	-	Blank (Default)
DHCP	-	OFF (Default)
TCP/IP port	(Set with the program.)	7090 (Default)

* In this document, the same values as the IP address and Subnetmask that are set with the node address switches on the Ethernet Unit in 7.3.1. Hardware Setting are set from the I/O Table and Unit Setup of the CX-Programmer to describe the procedure in 7.3.4. Parameter Settings.

*In this document, the gateway setting is unnecessary because the connection is made in the same segment.



Precautions for Correct Use

This document describes the setting procedure with the CJ1W-ETN21 Ethernet Unit, unit number 0 and node address 01. For the system with other configuration, please change the control word of the CIO area used in the ladder program. Refer to 9. *Program* for details.

6.2. Example of Connection Check

This document uses an example of the ladder program in which the PLC executes TCP socket open, send/receive, and socket close processing on the RFID Reader/Writer (V750-BA50C04-US).

The PLC and RFID Reader/Writer send and receive the message of “read Reader/Writer setting”. The following figure outlines the operation.

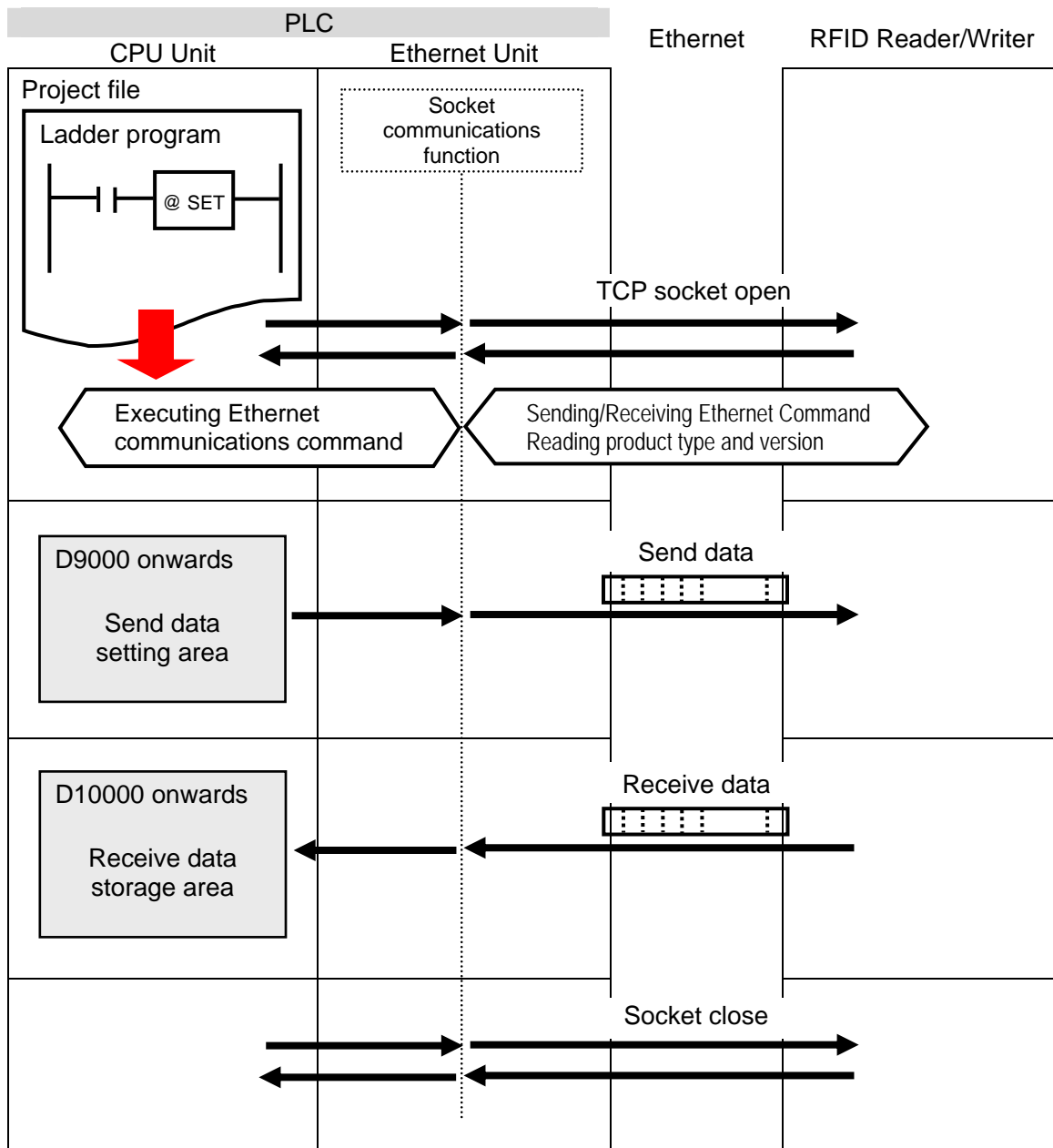

7. Connection Procedure

This section explains the procedure for connecting the RFID Reader/Writer to the PLC via Ethernet.

This document explains the procedures for setting up the PLC and RFID Reader/Writer from the factory default setting. For the initialization, refer to *Section 8 Initialization Method*.

7.1. Work Flow

Take the following steps to connect the RFID Reader/Writer to the PLC via Ethernet.

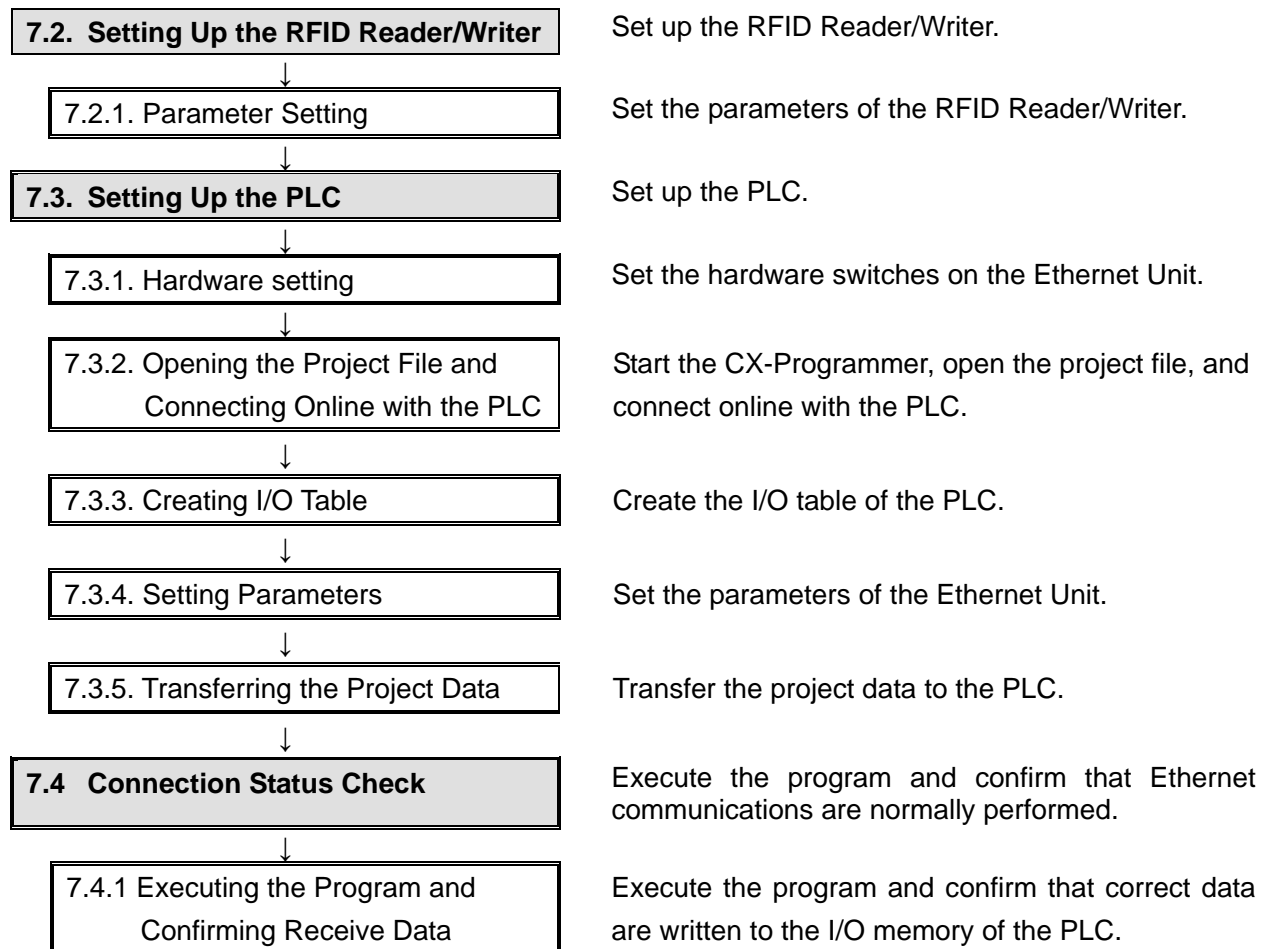

7.2. Setting Up the RFID Reader/Writer

Set up the RFID Reader/Writer.

7.2.1. Parameter Setting

Set the parameters of the RFID Reader/Writer.
To set, a web browser (e.g., Internet Explorer) that can execute Java software is required.
Install it when necessary so that Java software can operate.
Set the IP address of the personal computer to 192.168.1.1.



Precautions for Correct Use

Use a personal computer to set the parameters of the RFID Reader/Writer.
Note that you may need to change the settings of the personal computer depending on the status of the personal computer.

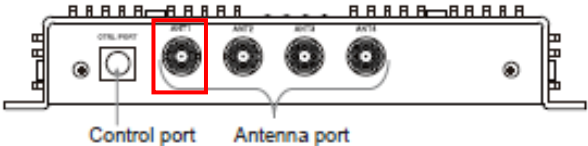
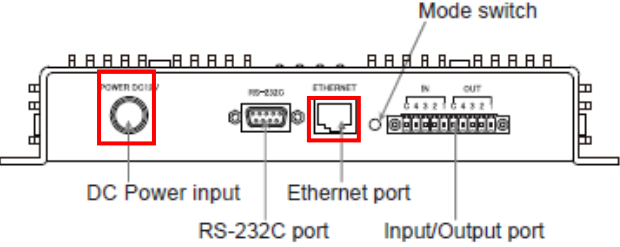
1	Connect the antenna to the antenna port on the side of the RFID Reader/Writer.	 <p>(Side of RFID Reader/Writer)</p>
2	Connect the Switching Hub to the Ethernet port on the other side of the RFID Reader/Writer using the LAN cable. Connect the included AC Adapter cable to the DC power input.	 <p>(Other side of RFID Reader/Writer)</p>

- 3 Start Internet Explorer from the personal computer that is connected to the Switching Hub.

*Set the IP address of the personal computer to 192.168.1.1. Use the following procedure to check the IP address of the personal computer.

- (1) Click **Network Connections** on the Control Panel.
- (2) Double-click **Local Area Connection** on the Network Connections.
- (3) Click the Support Tab on the Local Area Connection Status Dialog Box.
- (4) Confirm that the IP address is 192.168.1.1.

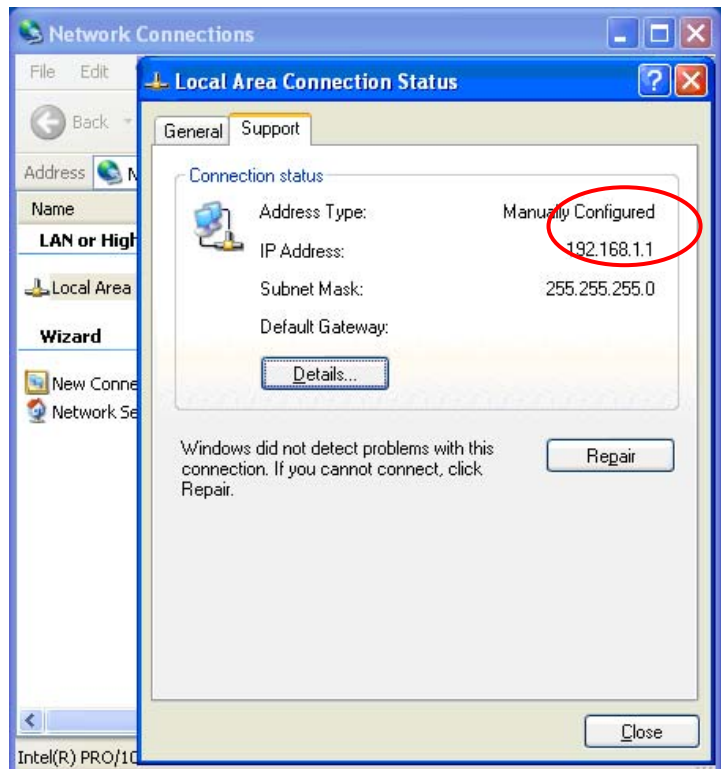

- 4 Click **Internet Options** from the Tools Menu of the Internet Explorer.

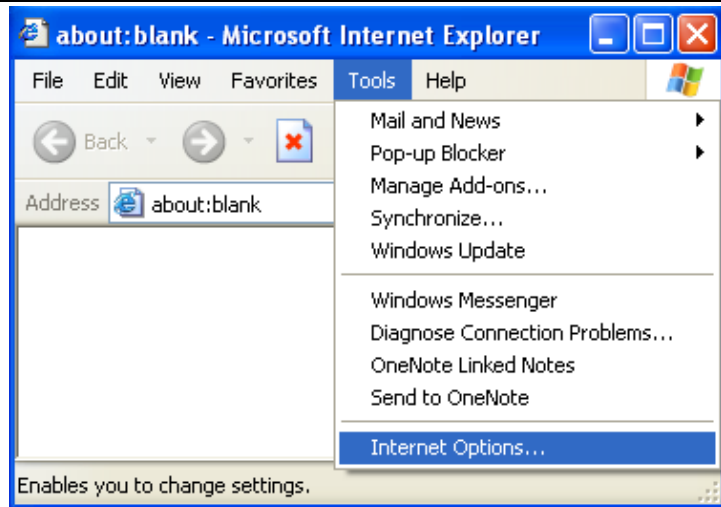

- 5 The Internet Options Dialog Box is displayed. Select the Connections Tab.

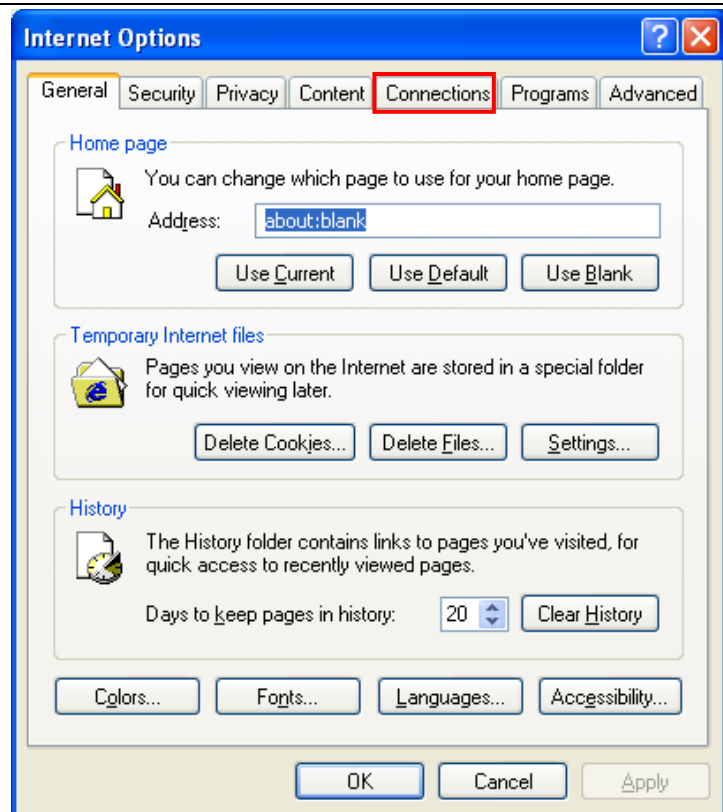

- 6 On the Internet Options Dialog Box, click the LAN Settings Button.

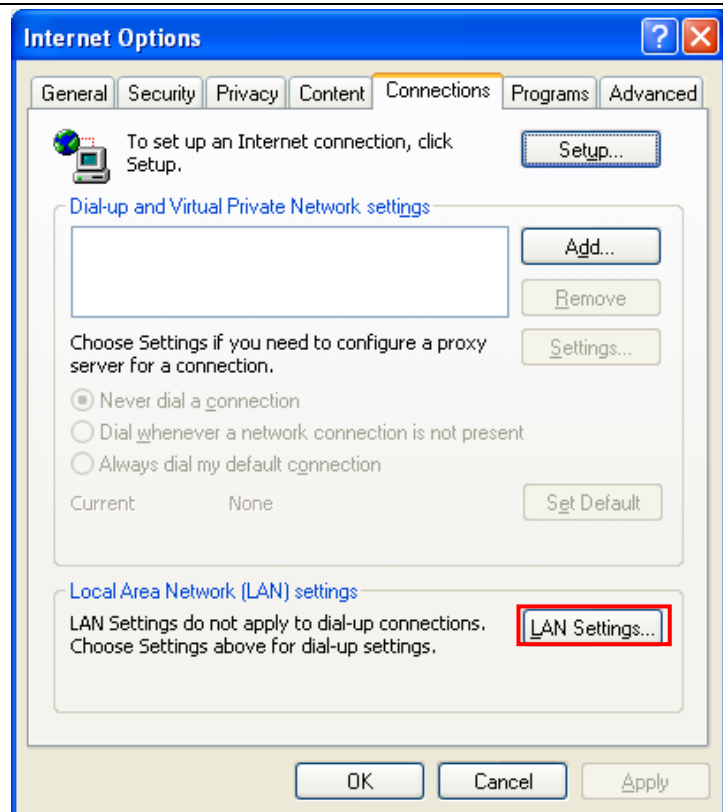

- 7 The Local Area Network (LAN) Settings Dialog Box is displayed. Confirm that the *Use a proxy server for your LAN* Check Box is cleared from the Proxy server Field, and click the **OK** Button.

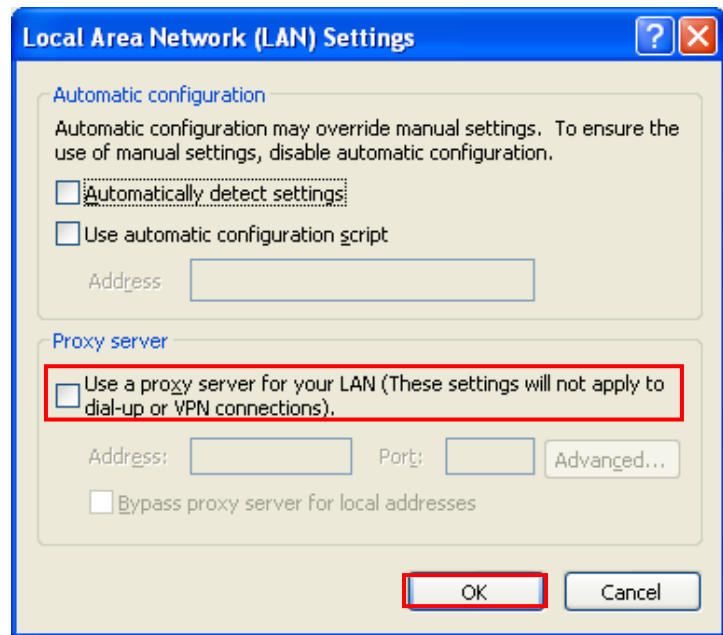

- 8 Click the **OK** Button on the Internet Options Dialog Box.

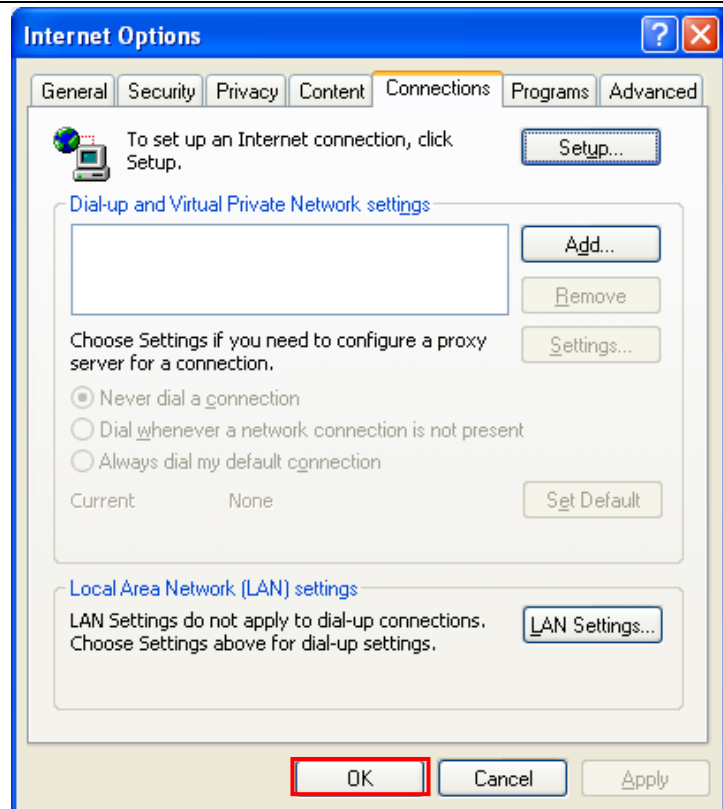

- 9 Type `http://192.168.1.200` / in the address bar of the Internet Explorer.

The Reader Status Window is displayed. Click the **Reader Settings** Button.

The V750 Operation Warning Dialog Box is displayed. Click the **OK** Button.

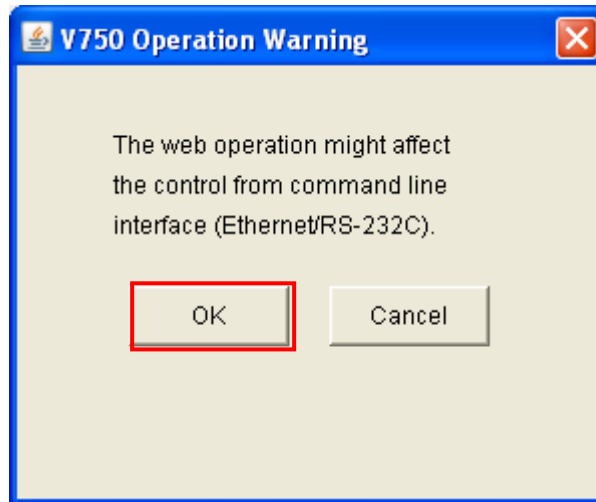
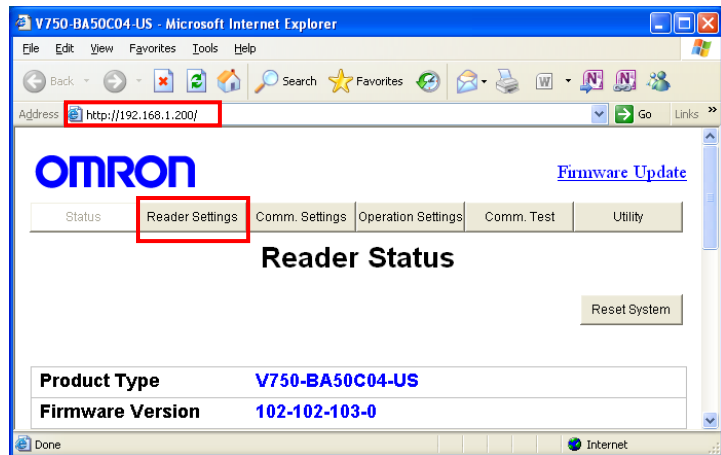

- 10 The Reader Settings Window shows the Ethernet settings. Make the settings as follows and click the **Save** Button.

Host Name
:V750-BA50C04-US
Domain Name
:Blank
DHCP: OFF
IP Address
:192.168.250.2
Subnet Mask
:255.255.255.0
Gateway
:192.168.1.254
TCP/IP Port
:7090

*If the settings are different from the above, change the corresponding set values.

Exit Internet Explorer.

*If Internet Explorer does not exit, the IP address of the RFID Reader/Writer will be changed and the screen will not be displayed.

*The gateway setting is unnecessary. However, if you leave the Gateway Field blank, an error will occur. Therefore, use the default setting.

- 11 Cycle the power supply to the RFID Reader/Writer.

*The new parameters will be enabled after the power supply is cycled.



Additional Information

In addition to changing the Ethernet settings on the web browser screen, you can set and read the Ethernet parameters by using the setting commands (SETR and GETR). For information on the specifications of the setting commands, refer to *Section 5 Command Line Interface* in the *V750-series UHF RFID System User's Manual* (Cat. No. Z235).

7.3. Setting Up the PLC

Set up the PLC.

7.3.1. Hardware Setting

Set the hardware switches on the Ethernet Unit.



Precautions for Correct Use

Make sure that the power supply is OFF when you perform the settings.

<p>1</p>	<p>Make sure that the PLC power is OFF when you perform the settings.</p> <p>*If the power supply is turned ON, settings may not be applicable in the following procedure.</p> <p>Refer to the right figure and check the hardware switches located on the front panel of the Ethernet Unit.</p>	<p>Indicators Display the operating status of the Unit.</p> <p>Unit Number Switch Used to set the Ethernet Unit's unit number in one digit hexadecimal.</p> <p>Node Number Switches Used to set the Ethernet Unit's FINS node number in two digits hexadecimal.</p> <p>Ethernet Connector Used to connect the Ethernet twisted-pair cable.</p>
<p>2</p>	<p>Set the Unit No. Switch to 0.</p>	<p>Setting the Unit Number</p> <p>The unit number is used to identify individual CPU Bus Units when more than one CPU Bus Unit is mounted to the same PLC. Use a small screwdriver to make the setting, taking care not to damage the rotary switch. The unit number is factory-set to 0.</p> <p>UNIT No. Setting range: 0 to F</p>
<p>3</p>	<p>Set the node address switches to the following default settings: NODE No.x16¹: 0 NODE No.x16⁰: 1</p> <p>*Set the IP address to 192.168.250.1.</p> <p>*By default, the first to third octets of the local IP address are fixed to 192.168.250. The fourth octet is the value that was set with the node address switches.</p>	<p>Setting the Node Address</p> <p>With the FINS communications service, when there are multiple Ethernet Units connected to the Ethernet network, the Ethernet Units are identified by node addresses. Use the node address switches to set the node address between 01 and FE hexadecimal (1 to 254 decimal). Do not set a number that has already been set for another node on the same network.</p> <p>· Unit Version 1.5 or Later</p> <p>NODE No.₁ x16¹ NODE No.₀ x16⁰ Setting range 01 to FE (1 to 254 decimal)</p> <p>The node address is factory-set to 01.</p>
<p>4</p>	<p>Connect the Ethernet Unit to the PLC as shown on the right. Connect the LAN cable and USB cable, and turn ON the power supply to the PLC.</p>	<p>CPU Unit Ethernet Unit</p> <p>USB Cable End Cover</p> <p>Power Supply Unit LAN Cable</p>

7.3.2. Opening the Project File and Connecting Online with the PLC

Start the CX-Programmer, open the project file, and connect online with the PLC.
Install the CX-Programmer and USB driver in the personal computer beforehand.

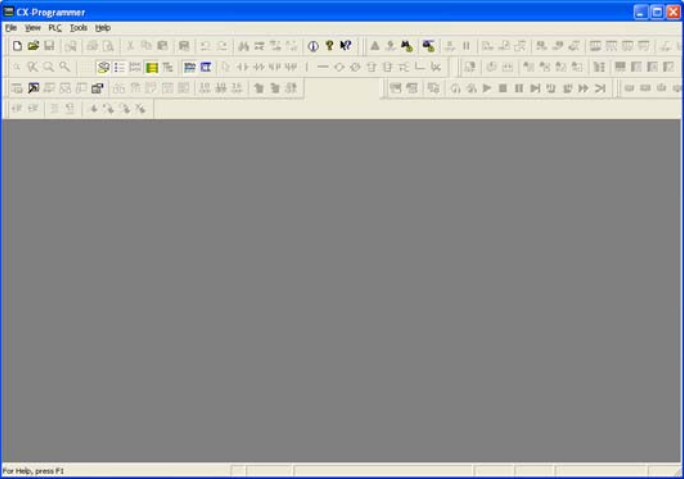
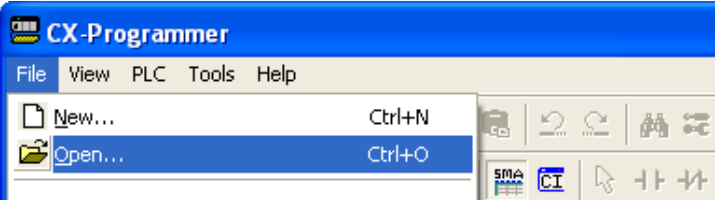
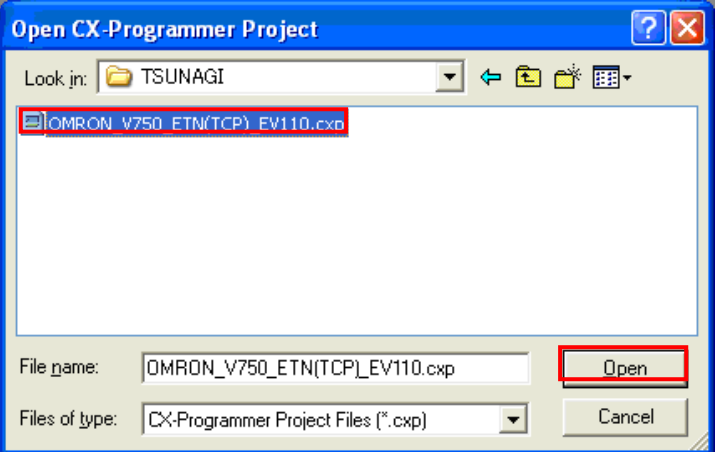
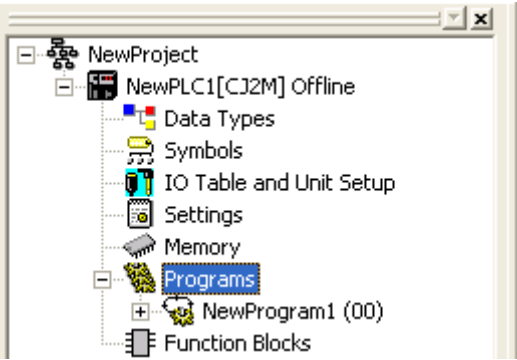
<p>1</p>	<p>Confirm that the PC and PLC are connected using the USB cable and turn ON the power to the PLC.</p> <p>Start the CX-Programmer.</p> <p>*If a confirmation dialog for an access right is displayed at start, select to start.</p>	
<p>2</p>	<p>Select Open from the File Menu.</p>	
<p>3</p>	<p>On the Open CX-Programmer Project Dialog Box, select the OMRON_V750_ETN(TCP)_EV10.cxp and click the Open Button.</p> <p>*Obtain the project file from OMRON.</p>	
<p>4</p>	<p>After opening the project file, select Programs in the project workspace.</p>	 <p>(Project workspace)</p>

- 5 Select **Change Model** from the PLC Menu.

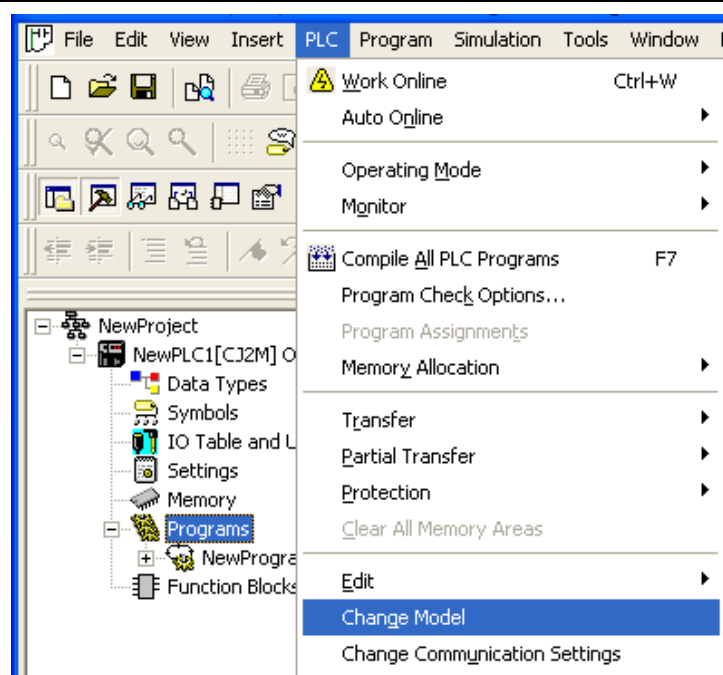

- 6 The Change PLC Dialog Box is displayed. Select a device type of the PLC to be used from the pull-down list in the Device Type, and click the **Settings** Button.

*CJ2M is selected in this document.

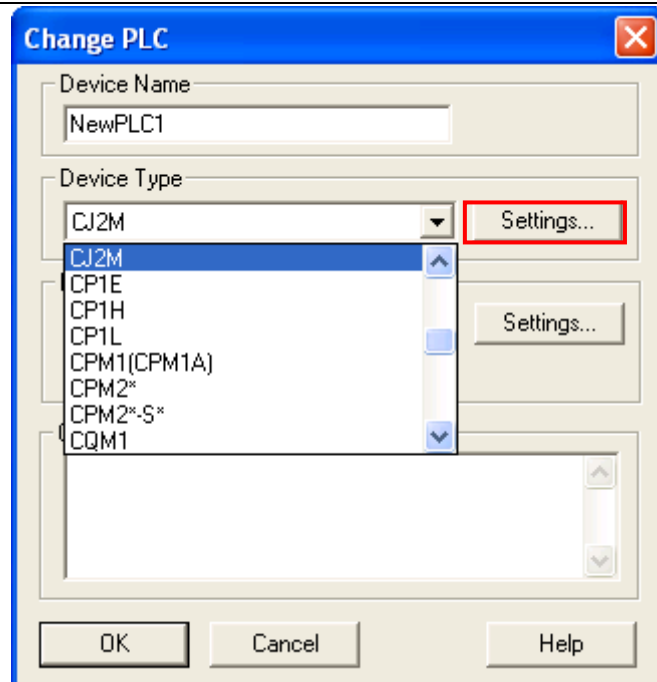

7 The Device Type Settings Dialog Box is displayed. Select a CPU type to use from the pull-down list in the CPU Type, and click the **OK** Button.

*CPU12 is selected in this document.

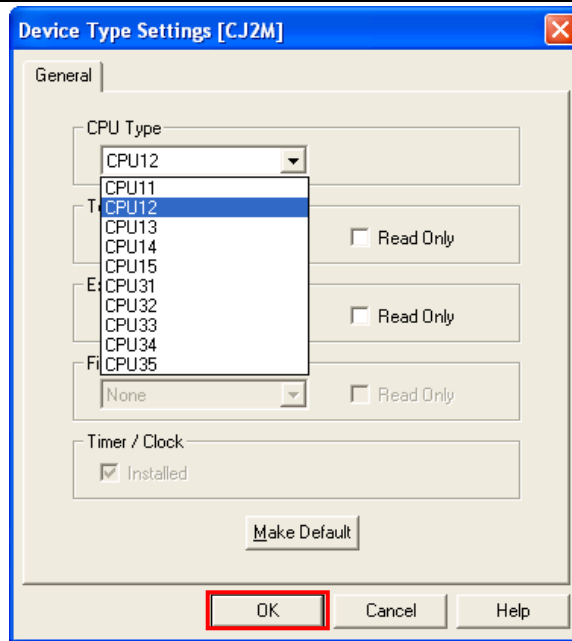

8 Confirm that the Network Type is set to USB on the Change PLC Dialog Box and click the **OK** Button.

*When the Network Type is not set to USB, select USB from the pull-down list.

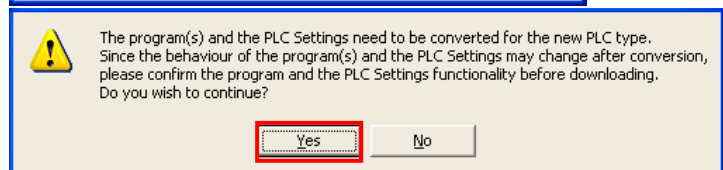
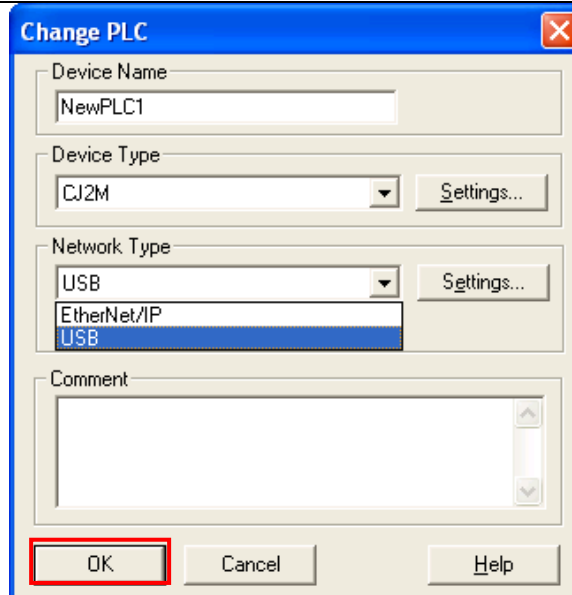



*If you have changed the Device Type in step 6 or the CPU Type in step 7, the dialog box on the right will be displayed. Click the **Yes** Button.

Confirm that the program was normally converted ("0 errors" must be shown).

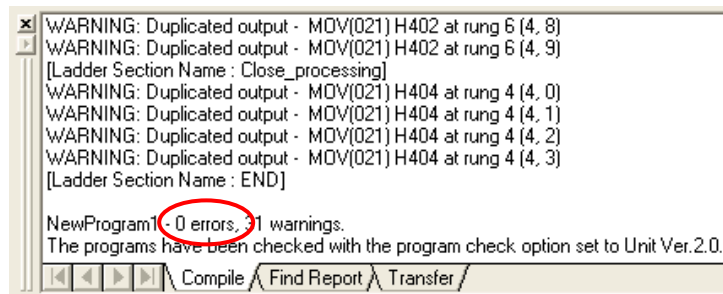
(Although duplicated output warnings were detected in the right dialog, they are not problems.)

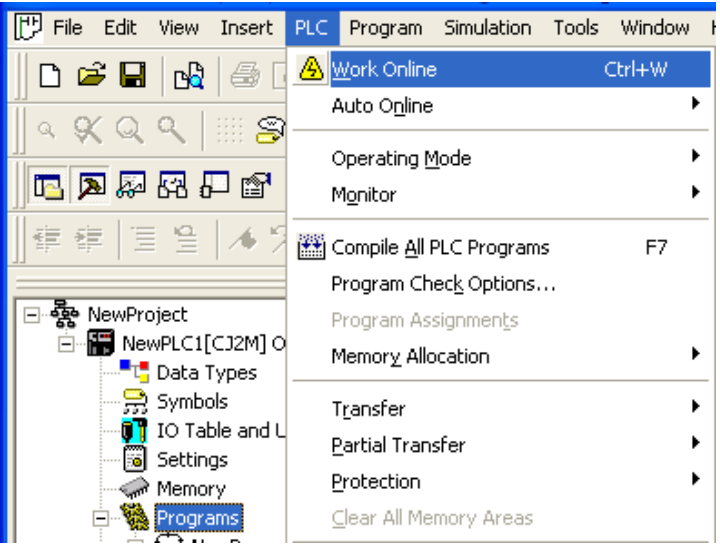
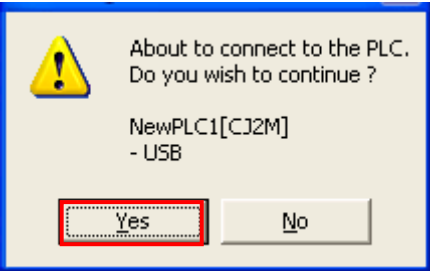

- 9 Select **Programs** in the project workspace and select **Work Online** from the PLC Menu.
- 
- 10 The dialog box on the right is displayed. Click the **Yes** Button.
- 
- 11 Confirm that the CX-Programmer and the PLC are normally connected online.
- 
- *The icon  is selected during online connection.



Additional Information

If the CX-Programmer and PLC are not connected online, please check the connection of the cable.

Or, check the settings that were set in steps 6 to 8 and try to connect them again.



Additional Information

The dialogs explained in the following procedures may not be displayed depending on the environmental setting of CX-Programmer.

This document explains the setting procedure when the *Confirm all operations affecting the PLC* Check Box is selected.

7.3.3. Creating the I/O Table

Create the I/O table of the PLC.

1 If the operating mode of the PLC is RUN Mode or Monitor Mode, change it to Program Mode, by following steps (1) to (3).

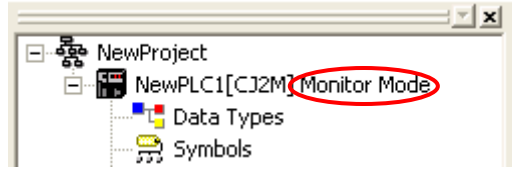

(1) Select **Operating Mode - Program** from the PLC Menu.

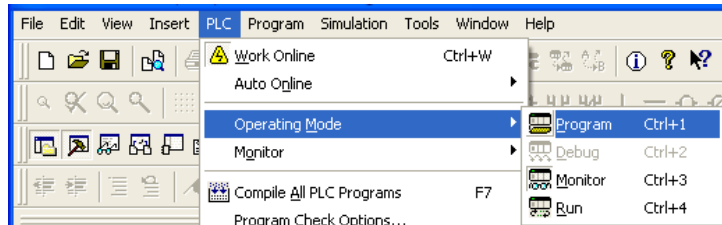

(2) The dialog box on the right is displayed. Click the **Yes** Button.

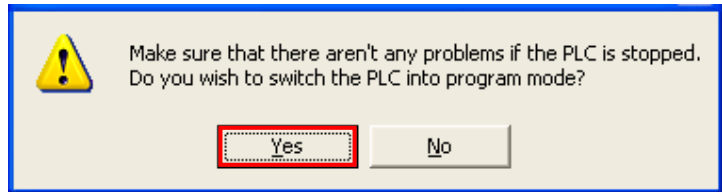

*Please refer to *Additional Information* on the previous page for the settings concerning the dialog display.

(3) Confirm that Stop/Program Mode is displayed on the right of the PLC model in the Project Tree.

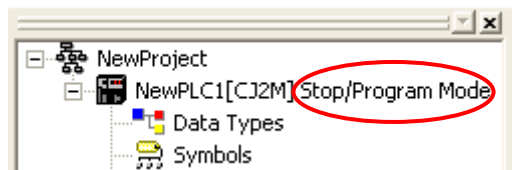

2 Select **Edit - I/O Table and Unit Setup** from the PLC Menu of the CX-Programmer.

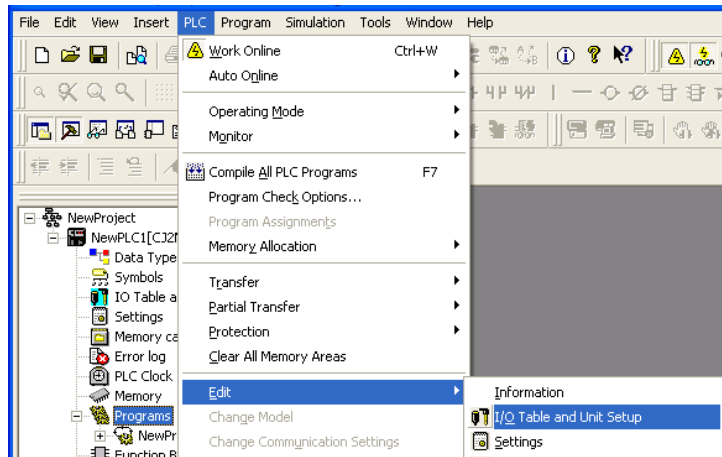

The PLC I/O Table Window is displayed.

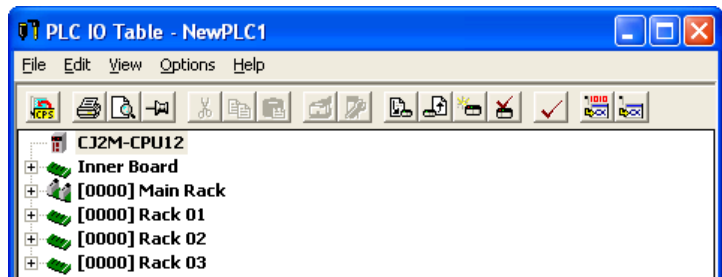

3 Select **Create** from the Options Menu of the PLC I/O Table Window.

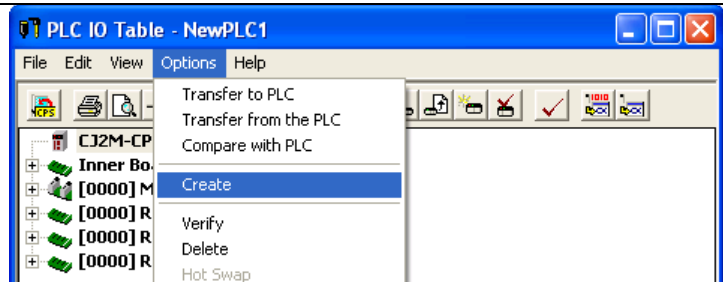

The dialog box on the right is displayed. Click the **Yes** Button.

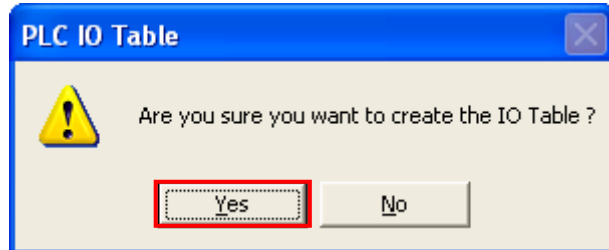

The dialog box on the right is displayed. Click the **Yes** Button.

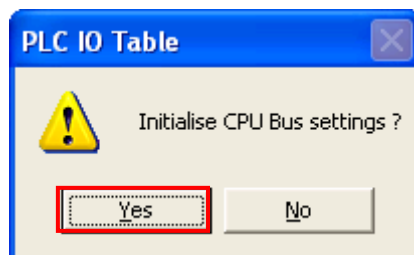

4 The Transfer from PLC Dialog Box is displayed. Select the *I/O Table* Check Box and *SIO Unit Parameters* Check Box, and click the **Transfer** Button.

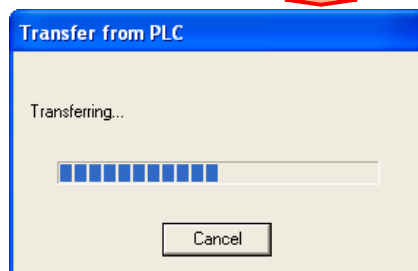
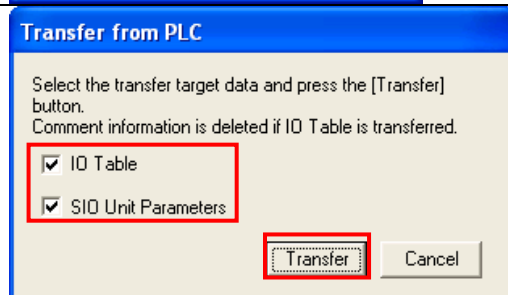

When the transfer is completed, Transfer Results Dialog Box is displayed.

Read the message in the dialog box to confirm if transfer was normally executed.

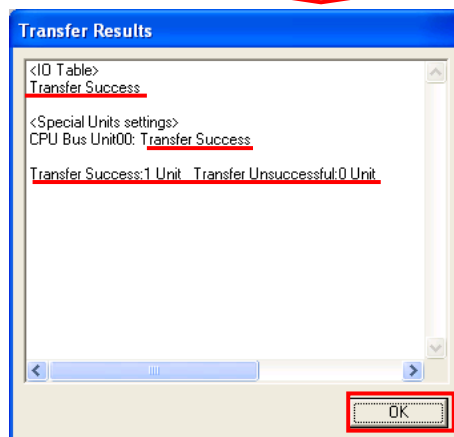

When the I/O table has been created normally, the dialog box shows the following:

Transfer Success: 1 Unit
Transfer Unsuccessful: 0 Unit

Click the **OK** Button.

7.3.4. Parameter Settings

Set the parameters of the Ethernet Unit.

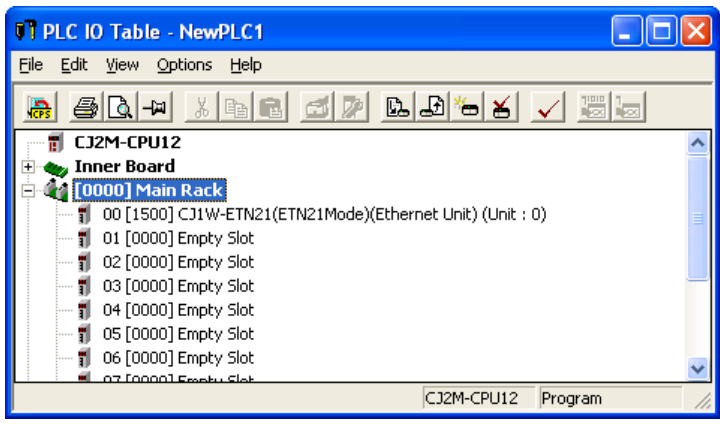
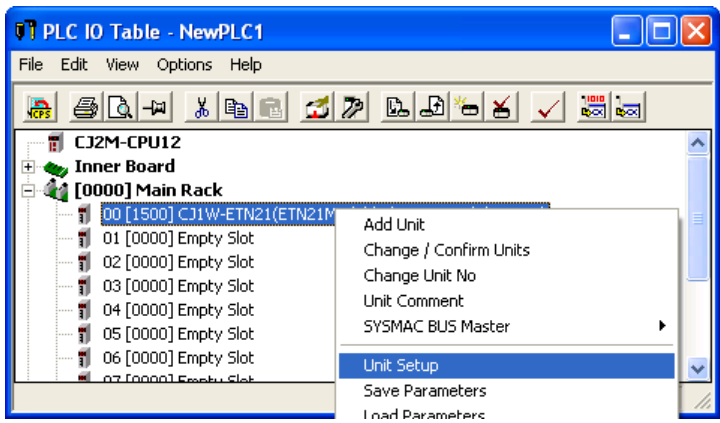
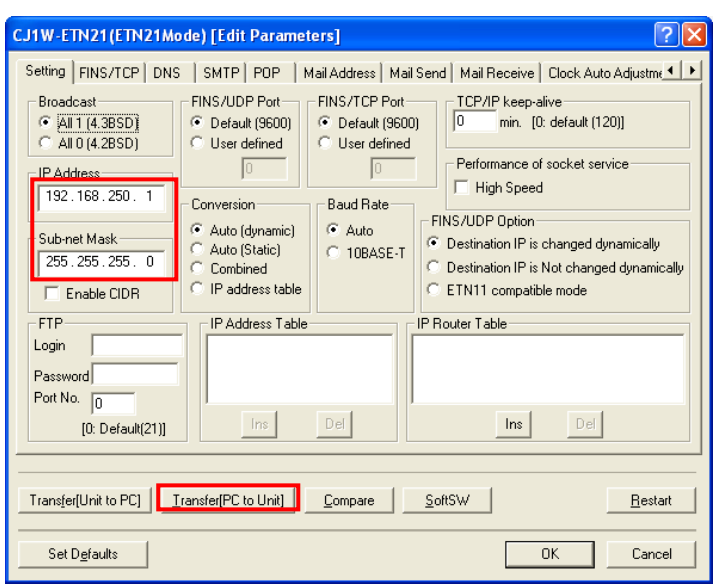
<p>1</p>	<p>Double-click the [0000] Main Rack on the PLC IO Table Window to display a tree.</p>	
<p>2</p>	<p>Right-click 00[1500]CJ1W-ETN21 (ETN21 Mode), and select the Unit Setup.</p>	
<p>3</p>	<p>The Edit Parameters Dialog is displayed. On the Setting Tab, enter 192.168.250.1 as the IP Address and 255.255.255.0 as the Sub-net Mask. After entering the values, click the Transfer[PC to Unit] Button.</p> <p>*To describe the setting procedure, the same values as the IP address and Subnetmask that are set with the node address switches on the Ethernet Unit in 7.3.1. Hardware Setting are set.</p>	

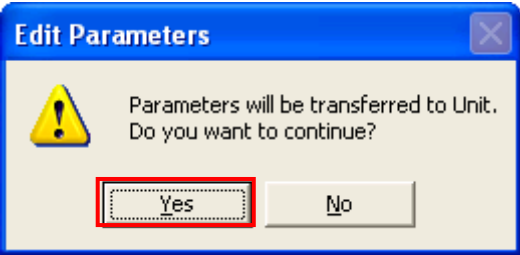
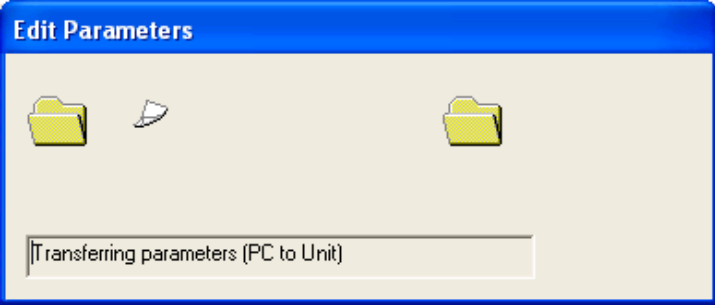
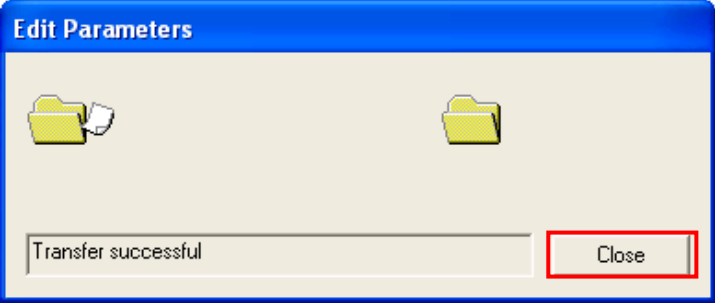
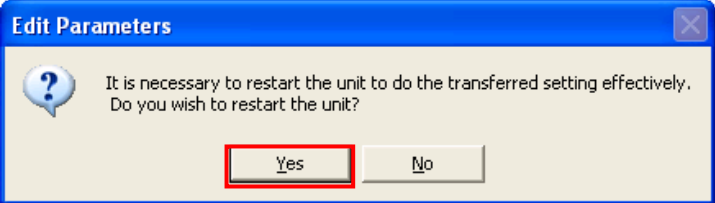
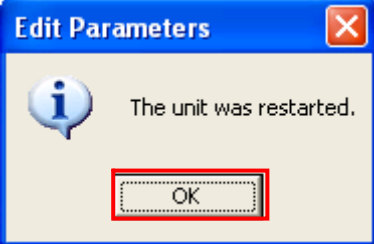
4	<p>The dialog box on the right is displayed. Click the Yes Button.</p> <p>The dialog box on the right is displayed when transfer has been completed. Click the Close Button.</p>	 <p>↓</p>  <p>↓</p> 
5	<p>The dialog box on the right is displayed. Click the Yes Button.</p>	
6	<p>The dialog box on the right is displayed. Click the OK Button.</p>	

7 To confirm that IP address was correctly changed, click the **Compare** Button.

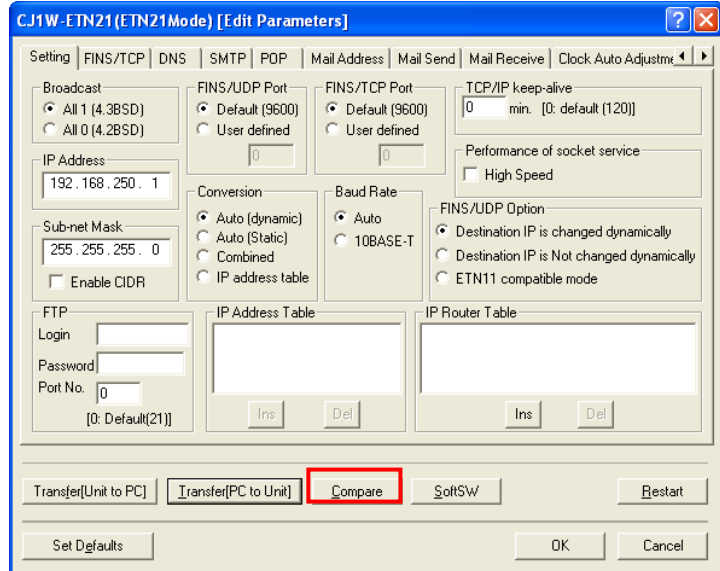

8 The dialog box on the right is displayed when the parameter settings matched. Click the **Close** Button.

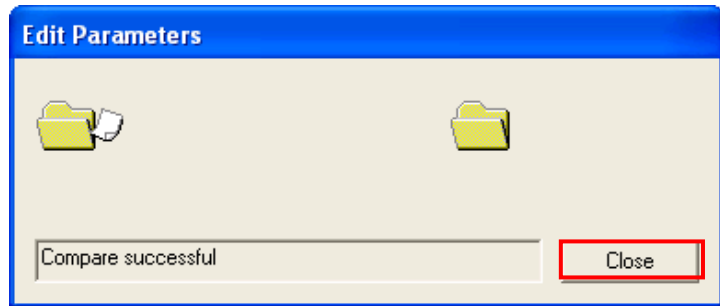

9 Click the **OK** Button on the Edit Parameters Dialog Box.

Close the Edit Parameters Dialog Box and PLC I/O Table Window.

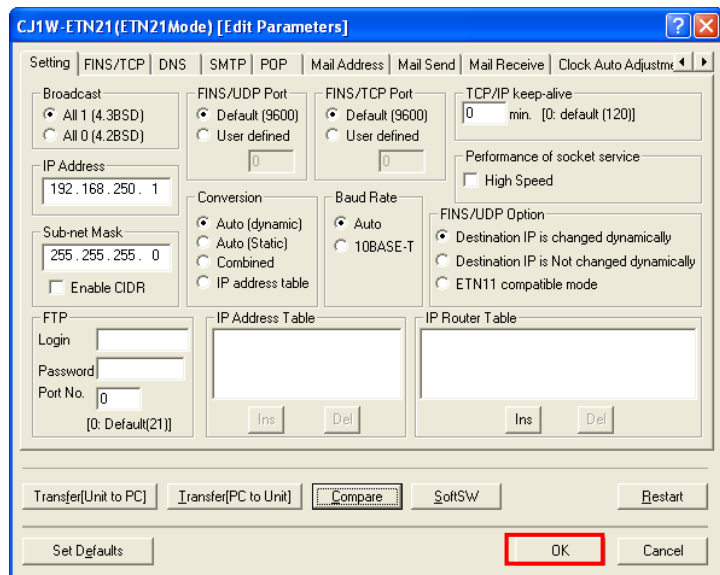

7.3.5. Transferring the Project Data

Transfer the project data to the PLC.

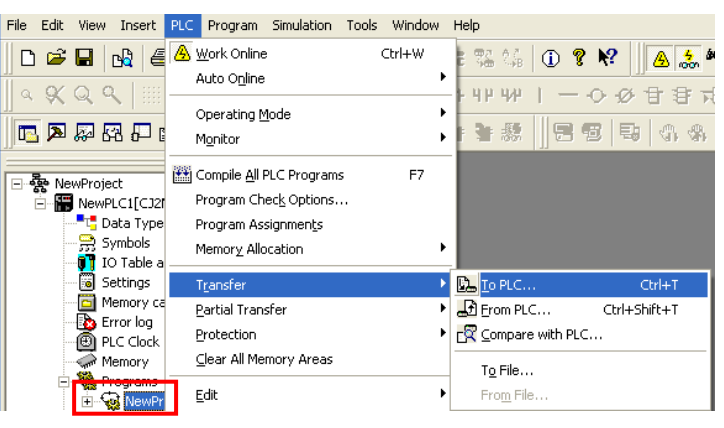
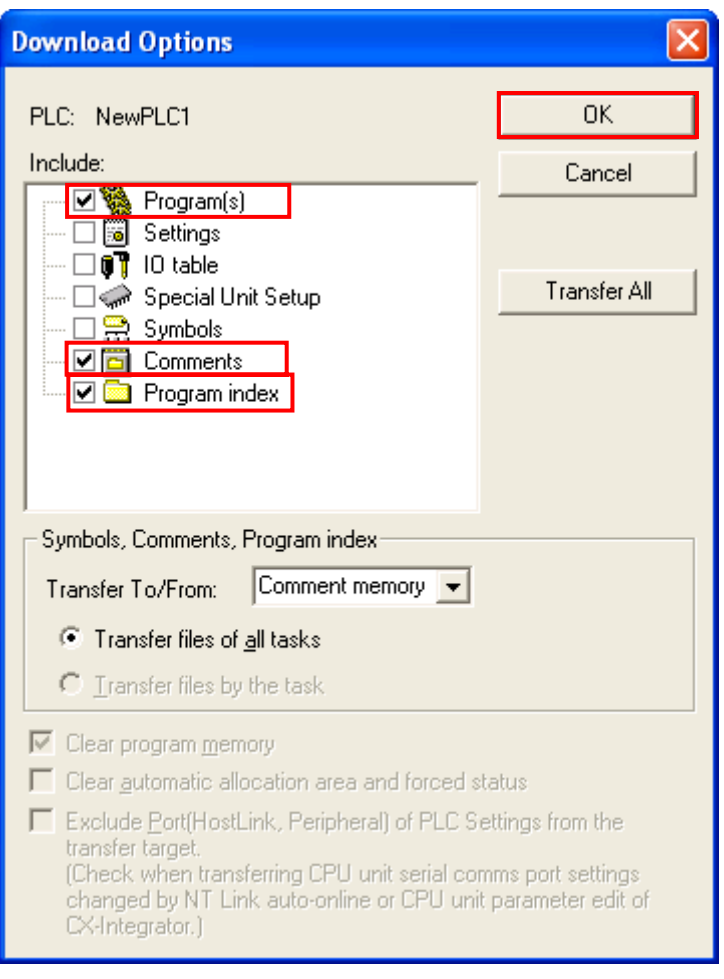
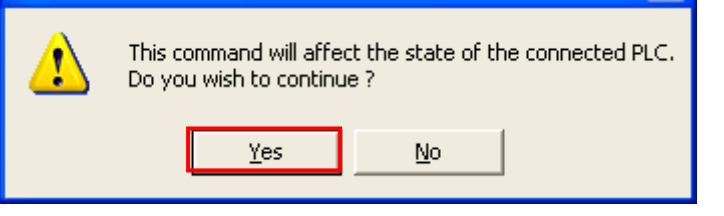
<p>1 Select Programs on the project workspace of CX-programmer, and select Transfer - To PLC from the PLC Menu.</p>	
<p>2 Select the <i>Program(s)</i> Check Box, <i>Comments</i> Check Box, and <i>Program index</i> Check Box, and click the OK Button.</p> <p>*Transferring I/O table and Special Unit Setup is unnecessary here because they were transferred in 7.3.3 and 7.3.4.</p> <p>*The <i>Comments</i> Check Box and the <i>Program index</i> Check Box may not be displayed depending on the device type. In such a case, select the <i>Program(s)</i> Check Box only and transfer the project data.</p>	
<p>3 The dialog box on the right is displayed. Click the Yes Button.</p>	

4 The dialog box on the right is displayed (stating Download successful) when the transfer is completed. Click the **OK** Button.

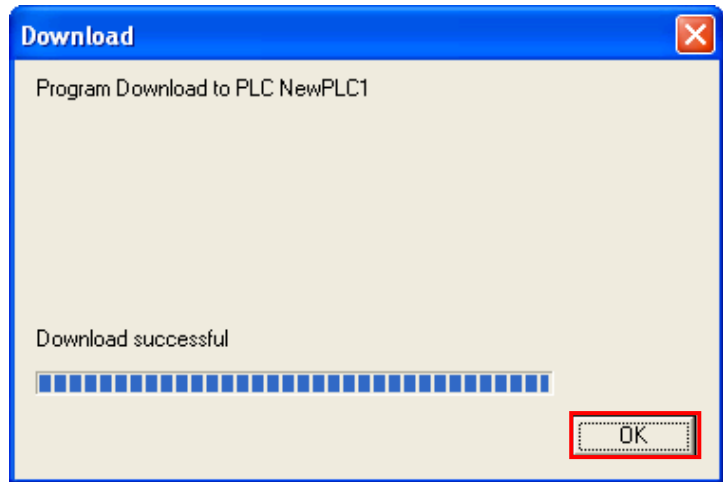

5 Select **Programs** in the project workspace, and select **Transfer - Compare with PLC** from the PLC Menu.

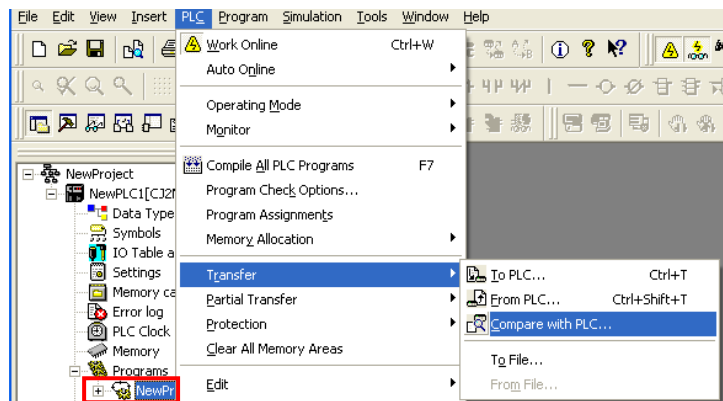

6 Select the *Program(s)* Check Box and click the **OK** Button.

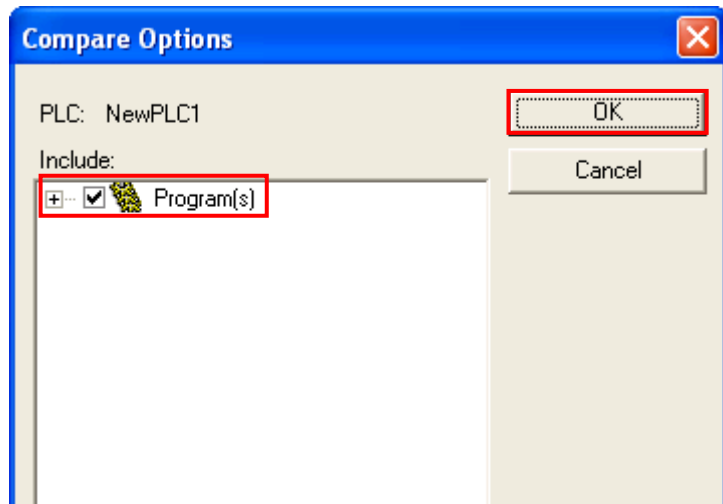

7 Confirm that a message stating "Compare successful" is displayed, and click the **OK** Button.

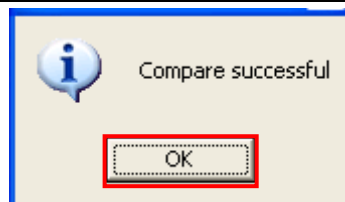

7.4. Checking the Connection Status

Execute the program and confirm that Ethernet communications are normally performed.

Caution

Confirm safety sufficiently before monitoring power flow and present value status in the Ladder Section window or when monitoring present values in the Watch window. If force-set/reset or set/reset operations are inadvertently performed by pressing short-cut keys, the devices connected to Output Units may malfunction, regardless of the operating mode of the CPU Unit.



Precautions for Correct Use

Please confirm that the LAN cable is connected before proceeding to the following procedure.

If it is not connected, turn OFF the power to the devices, and then connect the LAN cable.

7.4.1. Executing the Program and Checking the Receive Data

Execute the program and confirm that correct data is written to the I/O memory of the PLC.

- 1 Open the Programs Tree on the project workspace of the CX-Programmer, and double-click **Start&Set**. The ladder window shows the Start&Set ladder.

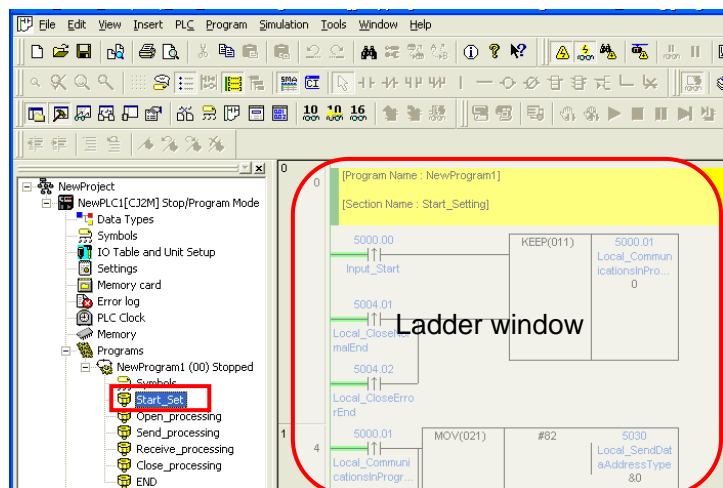

- 2 Select **Operating Mode - Monitor** from the PLC Menu.

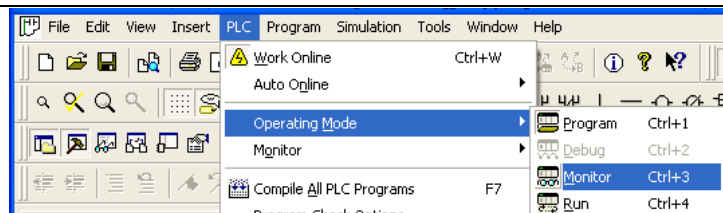

- 3 The dialog box on the right is displayed. Click the **Yes** Button.

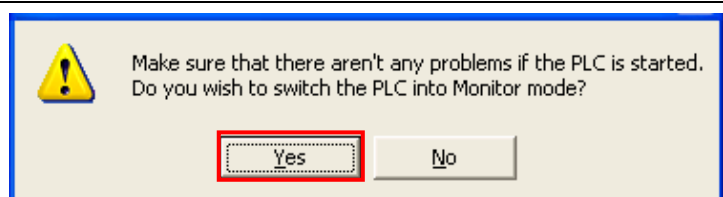

4 Confirm that the operating mode was changed to Monitor Mode.

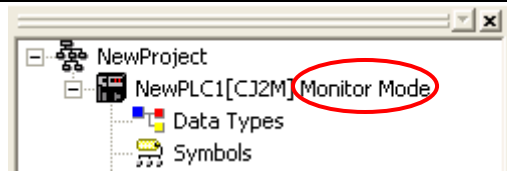

5 On the ladder window, right-click **Input_Start** on the block 0 and select **Set - On**.

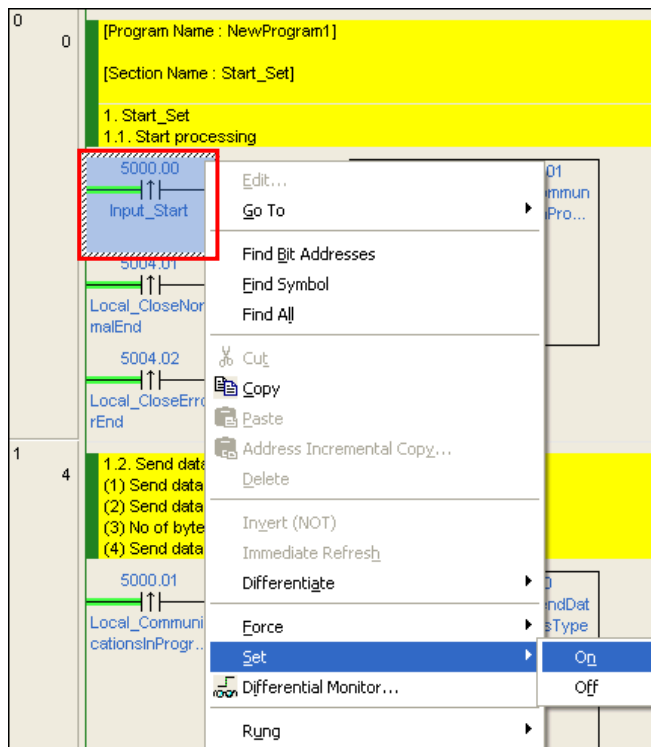

6 Confirm that the Input_Start contact is turned ON as shown in the right figure.

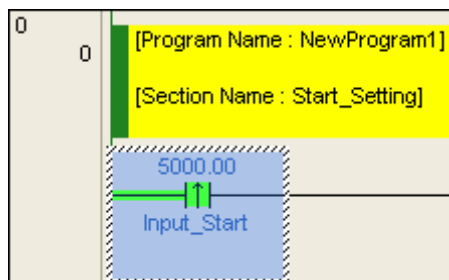

7 Select **Edit - Memory** from the PLC Menu.

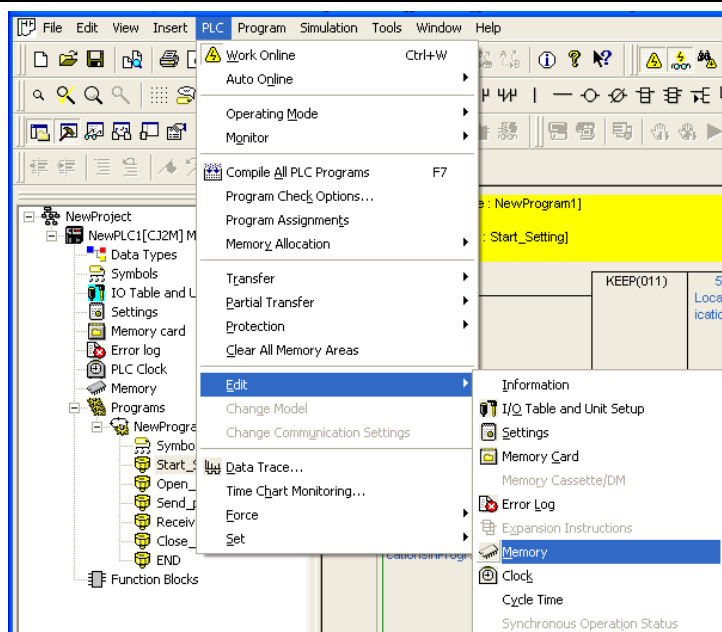

8 Double-click **D** from a list in the PLC Memory Window.

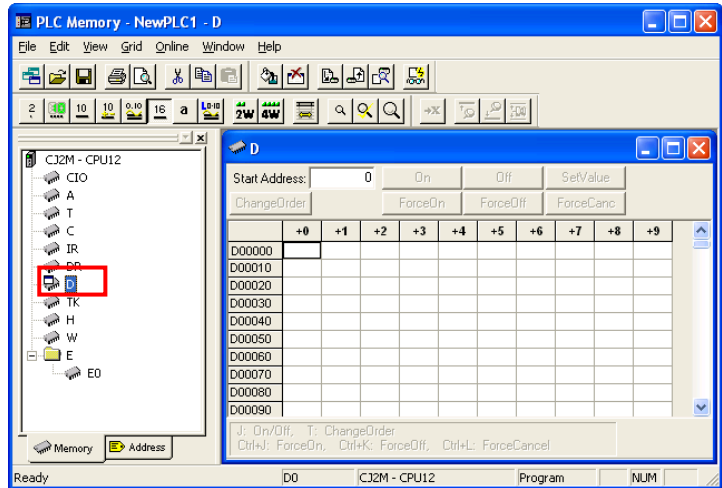

(PLC Memory Window)

9 On the D Window, enter 10000 in the Start Address Field. Confirm that the start address was changed to D10000.

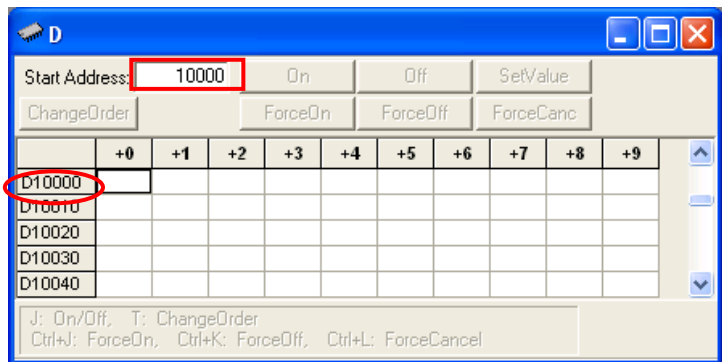

10 Select **Monitor** from the Online Menu.

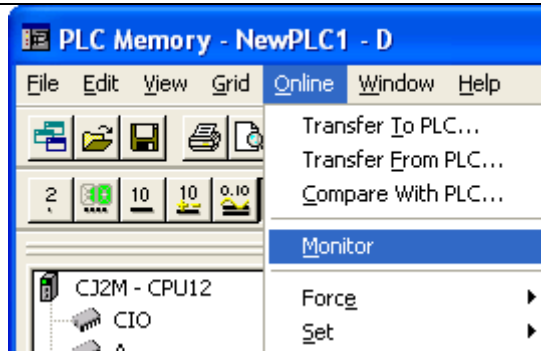

11 The Monitor Memory Areas Dialog Box is displayed. Select the **D** Check Box and click the **Monitor** Button.

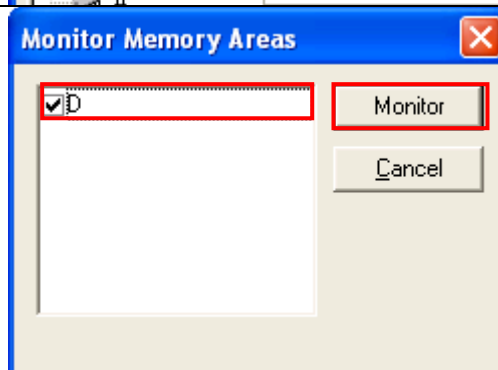

12 On the D Window, check the received data.

*The number of bytes to receive is stored in D10000. The value is 0031 in hexadecimal (49 in decimal), which are 24 words and 1 byte. The received data are stored in between D10001 and D10024 and in the upper byte of D10025.

	+0	+1	+2	+3	+4	+5	+6	+7	+8	+9
D10000	0031	4745	5452	3030	3030	2074	7970	3D22	5637	3530
D10010	2D42	4135	3043	3034	2D55	5322	2066	7776	3D31	3032
D10020	2D31	3032	2D31	3033	2D30	0A00	0000	0000	0000	0000
D10030	0000	0000	0000	0000	0000	0000	0000	0000	0000	0000
D10040	0000	0000	0000	0000	0000	0000	0000	0000	0000	0000

Select **Display - Text** from the View Menu.

You can display the received data "GETR0000[]
typ="V750-BA50C04-US"[]
fwv=102-102-103-0 ([] indicates a space)" as an ASCII character string.

ASCII character string display

	+0	+1	+2	+3	+4	+5	+6	+7	+8	+9
D10000	.1	GE	TR	00	00	t	yp	=	V7	50
D10010	-B	A5	0C	04	-U	S"	f	wv	=1	02
D10020	-1	02	-1	03	-0

*In the example on the right, the value that was read is "GETR..." as an ASCII character string. However, the response data depends on the device used.

*Refer to 9.2. *Destination Device Command* for details on the command.

Receive data

- Send command: GETR
- Response code: 0000
- Option 1 name: typ= (Product type)
- Option 1 return value ("V750-BA50C04-US")
- Option 2 name: fwv= (Firmware version)
- Option 2 return value: 102-102-103-0

8. Initialization Method

This document explains the setting procedure from the factory default setting.

If the device settings are changed from the factory default setting, some settings may not be applicable as described in this procedure.

8.1. Initializing the PLC

To initialize the PLC, it is necessary to initialize the Ethernet Unit and the CPU Unit. Place in the PROGRAM Mode before initialization.

8.1.1. Ethernet Unit

To initialize the settings of the Ethernet Unit, select **Edit – I/O Table** from the PLC Menu of the CX-Programmer.

On the PLC IO Table Dialog Box, right-click the Ethernet Unit and select **Unit Setup** from the menu that is displayed.

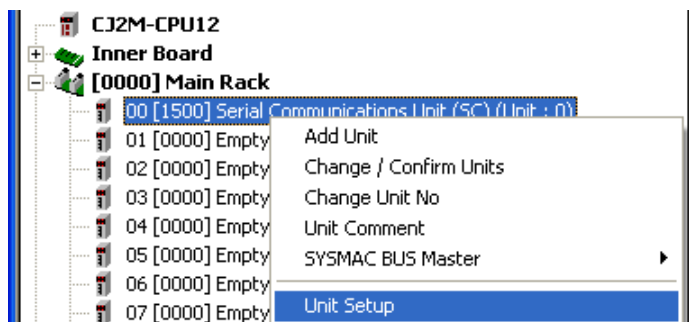

On the Edit Parameters Dialog Box, click the **Set Defaults** Button, and click the **Transfer (PC to Unit)** Button.

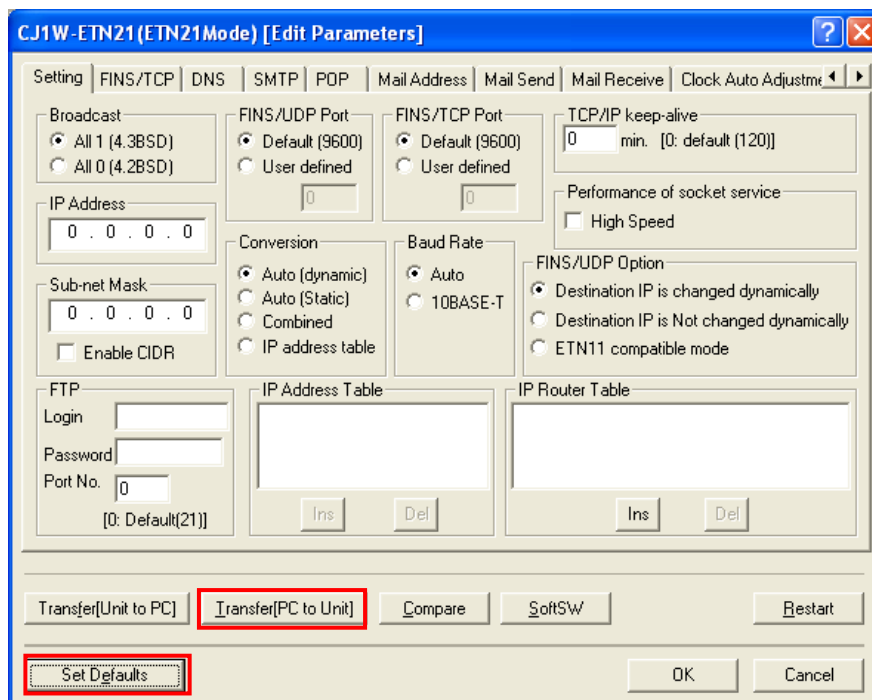

8.1.2. CPU Unit

To initialize the settings of the CPU Unit, select **Clear All Memory Areas** from the PLC Menu of the CX-Programmer. On the Confirm All Memory Area Clear Dialog Box, select the *Initialize* Option and click the **OK** Button.

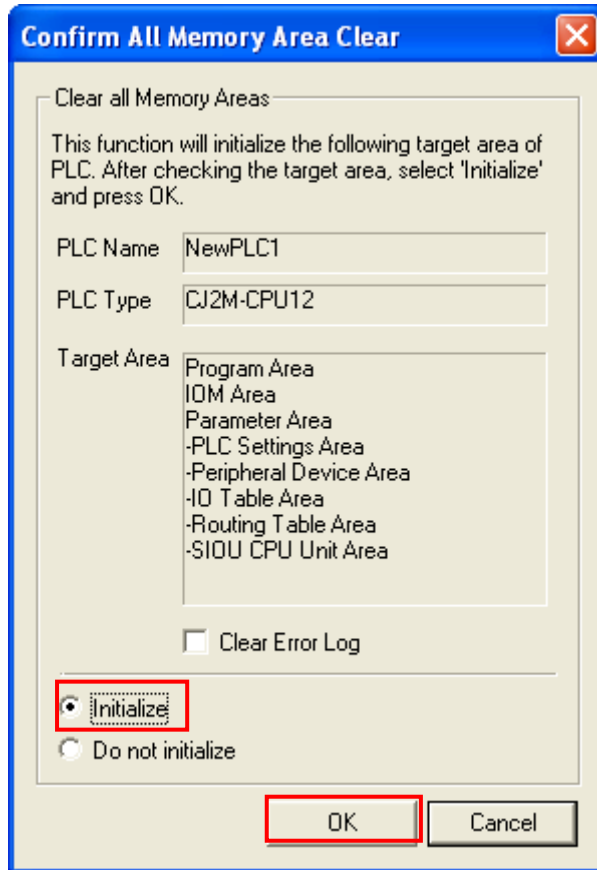

8.2. Initializing the RFID Reader/Writer

Use the following procedure to initialize the settings of the RFID Reader/Writer.

- 1 Press the mode switch at least one second and start the Safe Mode of the RFID Reader/Writer.

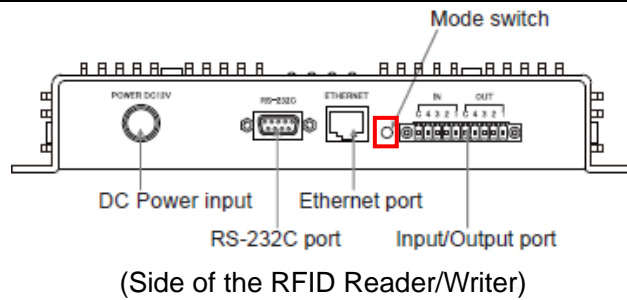

- 2 Type "http://192.168.1.200/" in the address bar of the Internet Explorer.

The Safe Mode Window is displayed. Click the **Init All Settings** Button.

*The firmware version of the safe mode is 010-000-000-0.

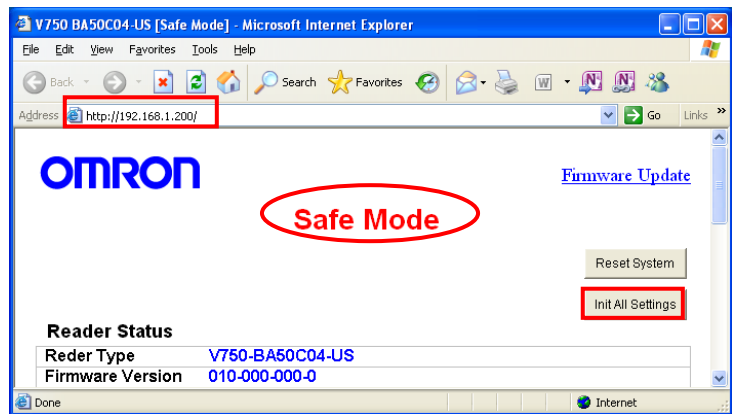

Additional Information

For the initialization of the RFID Reader/Writer, refer to *Mode switch* in *Names and Functions of Components in Reader of Section 2 Specifications and Performance* and *Mode* in *Section 3 Mode and Function* in the *V750-series UHF RFID System User's Manual* (Cat. No. Z235).

9. Program

This section explains the details on the program in the project file that is used in this document.

9.1. Overview

This section explains the specifications and functions of the program used to check the connection between the RFID Reader/Writer (Hereafter, referred to as a "destination device") and the PLC (using the Ethernet Unit).

This program performs the TCP socket communications by manipulating a dedicated control bit, sends and receives the message of GETR (Read Reader/Writer setting) and detects a normal end or an error end.

The normal end of this program means a normal end of the TCP socket communications. The error end means an error end of the TCP socket communications and destination device error (detected with the response data from the destination device).

The keep-alive and linger functions, which are TCP socket options, are not used in this program. Whether to use them must be determined when configuring the system.

In this section, the "&" prefix is added to decimal data and the "#" prefix is added to hexadecimal data when it is necessary to distinguish between decimal and hexadecimal data. (e.g., "&1000" for decimal and "#03E8" for hexadecimal)



Additional Information

OMRON has confirmed that normal communications can be performed using this program under the OMRON evaluation conditions including the test system configuration, version of each product, and product Lot, No. of each device which was used for evaluation.

OMRON does not guarantee the normal operation under the disturbance such as electrical noise and the performance variation of the device.

9.1.1. Communications Data Flow

The following figure shows the data flow from when the PLC issues command data with TCP socket communications to the destination device until when the PLC receives the response data from the destination device. This program continuously executes a series of processing from the TCP open processing to the close processing. The receive processing is repeated when the response data is divided and multiple receive data are sent. No response data may exist depending on the destination device and send command. In this case, skip the response receive processing by setting the receive processing not required setting in advance.

*Receive processing required/not required setting...

-Receive processing required: After the send processing, the program waits for the receive data and shifts to the receive processing.

-Receive processing not required: After the send processing, the program immediately shifts to the close processing.

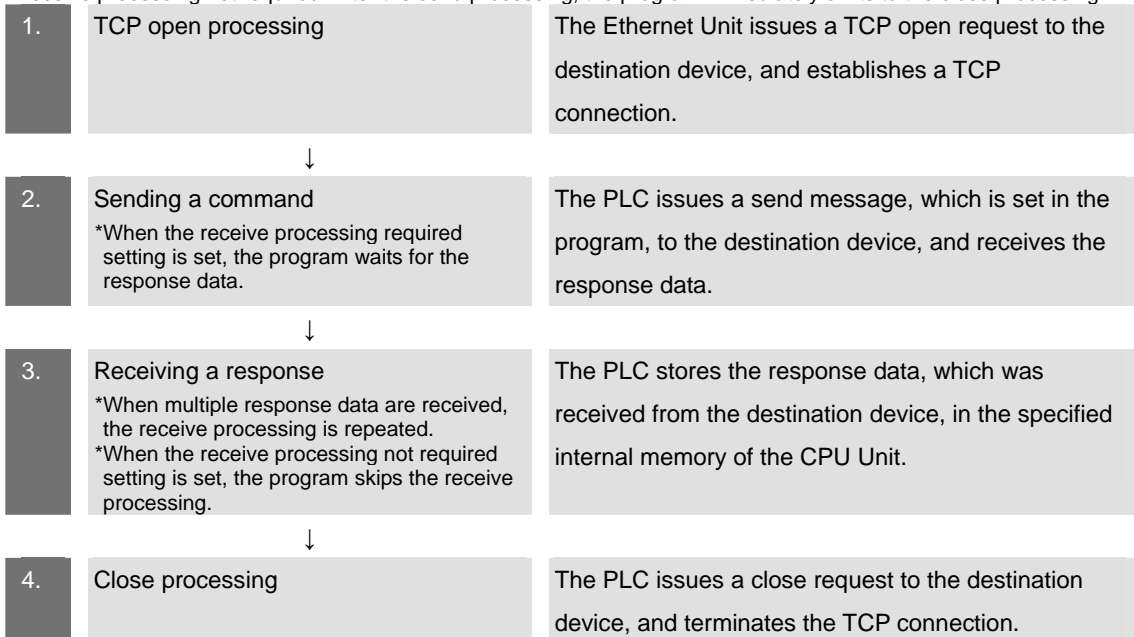

9.1.2. TCP Socket Communications by Manipulating a Dedicated Control Bit

This section explains the TCP socket communications manipulating a dedicated control bit and outlines the general operations of the send/receive message.



Additional Information

For details, refer to *Section 6 Socket Services of the CJ-series Ethernet Units Operation Manual Construction of Applications (Cat.No. W421)*.

- Using socket service by manipulating a dedicated control bit

To use the socket service by manipulating a dedicated control bit, store the necessary parameters in the socket service parameter area in the CPU Bus Unit area and then turn ON the Socket Service Request Switch.

[Socket service parameter area (Allocated DM area)]

The parameters for the socket service used by the socket service request are allocated to the DM area as follows. (First word m is calculated using the following formula: $m = D30000 + (100 \times \text{Unit No.})$.)

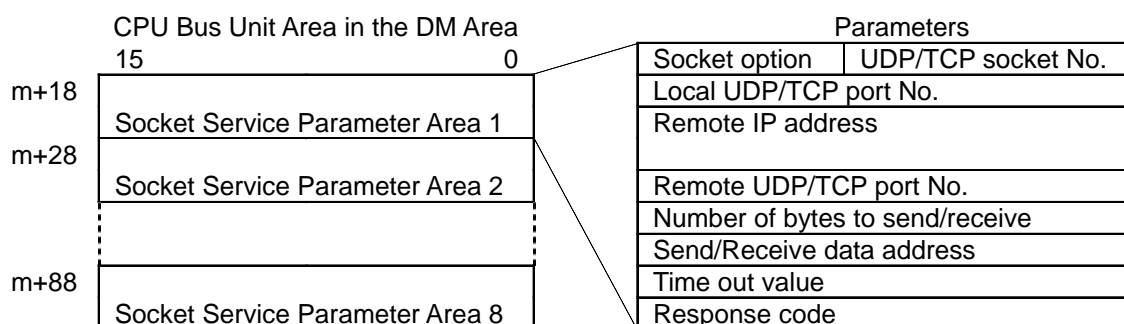

The following example uses socket service parameter area 1.

(1)[m + 18] Socket option/TCP socket No.

- To use the keep-alive function, set bit 08 to 1 (ON).
- To use the linger function, set bit 09 to 1 (ON).
- Specify &1 to &8 as the TCP socket number to be used in bits 00 to 07.

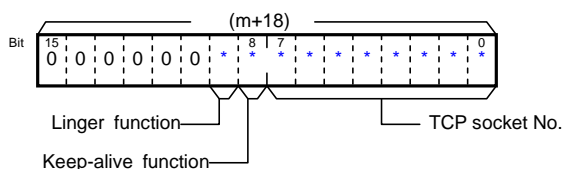

(2)[m+19] Local TCP port No.

- Specify the number of the TCP port for the socket to use for communications. As a rule, specify 1024 or greater. If 0 is specified, the TCP port number is allocated automatically.

(3)[m+20, m+21] Destination IP Address

- Specify the IP address of the destination device.

[m+20] contains the first and second octets of the destination IP address, and [m+21] contains the third and fourth octets.

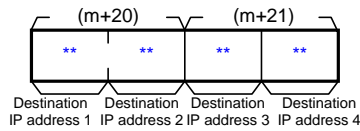

(4)[m+22] Destination TCP port No.

- Specify the TCP port number of the destination device.

(5)[m+23] Number of bytes to send/receive

- Specify the number of bytes to send/receive when issuing a send or receive request.

(6)[m+24, m+25] Send/Receive data address

- Specify the start address of the send data when issuing a send request. Or specify the start address where the receive data is stored when issuing a receive request.

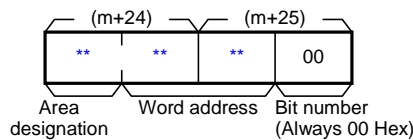

(7)[m+26] Timeout value

- Specify the time limit in increments of 0.1 second from when the Socket Service Request Switch is turned ON to when the switch is turned OFF (receive processing is completed) when issuing a receive request,.

If 0 is specified, timeout monitoring is not performed when a receive request is issued.

(8)[m+27] Response code

- A response code for each execution result of the open request, send request, receive request and close request is stored.

[Socket Service Request Switches (Allocated CIO areas)]

Dedicated control bits can be manipulated to request socket services. These bits are called Socket Service Request Switches, and are turned ON in the CPU Unit to request socket services through the Ethernet Unit.

The Socket Service Request Switches are allocated to CIO area words by each socket number as follows:

(The start word n is calculated using the following formula: $n=1500 + (25 \times \text{Unit No})$)

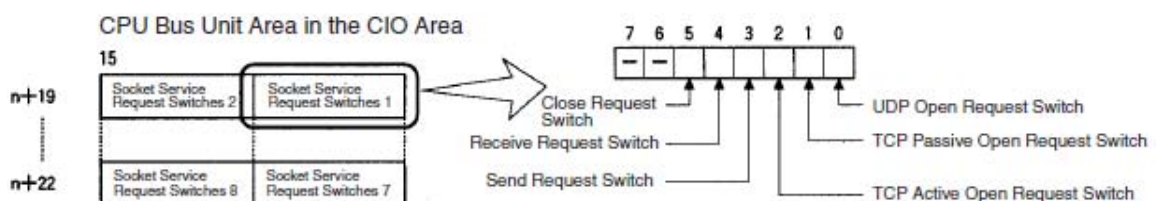

● Send/Receive message

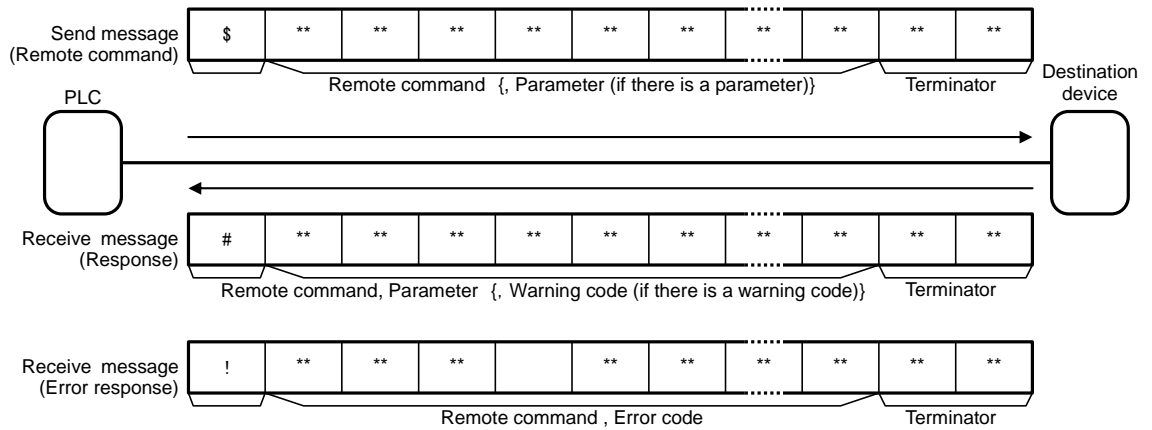

● Communications sequence

TCP communications are performed between the destination device (server) and PLC (client) in the following procedure.

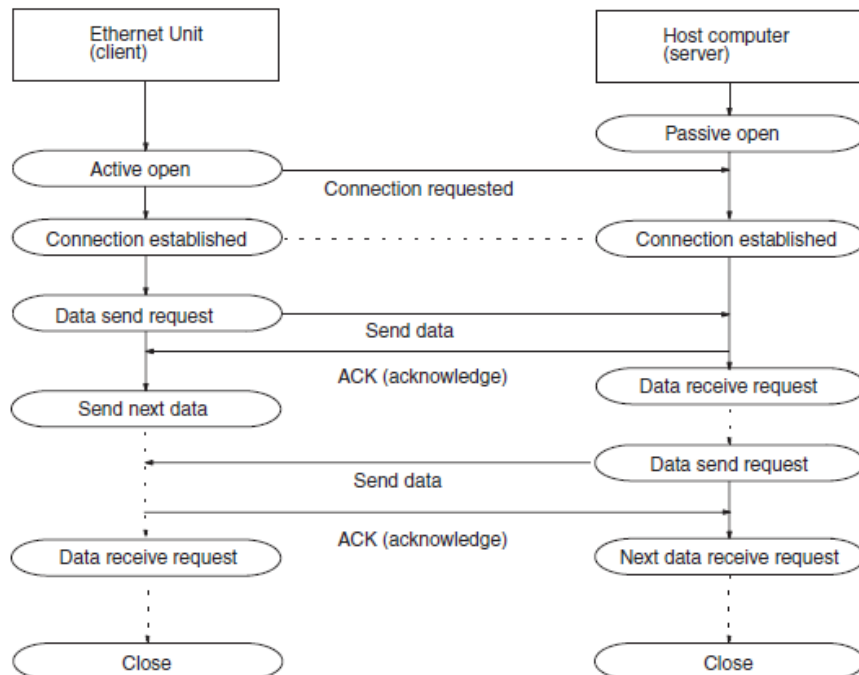

9.2. Destination Device Command

This section explains the destination device command.

9.2.1. Overview of the Command

This program reads the product type and firmware version information of the destination device by using the GETR (Read Reader/Writer settings) command.

Command	Description
GETR	Read the Reader/Writer settings.



Additional Information

For details, refer to *the Command Code List in Section 5 Command Line Interface of the UHF RFID System V750 Series User's Manual (Cat. No. Z235)*.

9.2.2. Detailed Description of the Command

This section explains the processing to read the product type and version information by executing GETR (read Reader/Writer settings).

- Send data (Command) setting (D9000)
 - <Specifications of the destination device>
 - The command is entered in ASCII code.
 - Upper case characters are used for the command.
 - Terminator #0A is added to the end of the command.

Address	Description (Data type)	Data (Explanation)	Description
D9000	No. of send bytes (4-digit hex)	#000D (&13)	13 bytes from D9001 to D9007
D9001	1 st and 2 nd bytes of send data (4-digit hex)	#4745 ('GE')	"GETR": Destination device command (Read settings)
D9002	3 rd and 4 th bytes of send data (4-digit hex)	#5452 ('TR')	
D9003	5 th and 6 th bytes of send data (4-digit hex)	#2074 (' f')	Space (Options are separated by a space.) + "typ" (product type): GETR command option
D9004	7 th and 8 th bytes of send data (4-digit hex)	#7970 ('yp')	
D9005	9 th and 10 th bytes of send data (4-digit hex)	#2066 (' f')	Space (Options are separated by a space.) + "fw" (firmware version): GETR command option
D9006	11 th and 12 th bytes of send data (4-digit hex)	#7677 ('v'w')	
D9007	13 th byte of send data (2-digit hex)	#0A00 ([LF]'00')	[LF]: Terminator

- Receive data (response) that is stored (D10000)

<Specifications of the destination device>

- The response is stored in ASCII code.

Address	Description (Data type)	Data (Explanation)
D10000	No. of receive bytes (4-digit hex)	Stores the number of receive bytes (2 × n bytes)
D10001	Receive data 1 (4-digit hex)	Stores 1 st and 2 nd bytes of receive data in ASCII code.
D10002	Receive data 2 (4-digit hex)	Stores 3 rd and 4 th bytes of receive data in ASCII code.
:	:	:
Dxxxxx	Receive data n (4-digit hex)	Stores n-1 and n th bytes of receive data in ASCII code.

- Send/Receive message

*Send message

47	45	54	52	20	74	79	70	20	66	77	76	0A
'G'	'E'	'T'	'R'	' '	't'	'y'	'p'	' '	'f'	'w'	'v'	[LF]

*Receive message 1 (at normal process)

47	45	54	52	30	30	30	30	20	74	79	70	3D	22
'G'	'E'	'T'	'R'	'0000' (Response code)				' '	't'	'y'	'p'	'='	'"'

****	22	20	66	77	76	3D	****	0A
Product type	'"'	' '	'f'	'w'	'v'	'='	Version	[LF]

*Receive message 2 (at error process)

47	45	54	52	****	0A
'G'	'E'	'T'	'R'	Response code	[LF]

*Receive message 3 (at error process: Undefined)

49	43	4D	44	****	0A
'I'	'C'	'M'	'D'	Response code	[LF]

9.3. Error Detection Processing

This section explains the error detection processing of this program.

9.3.1. Error Detection of this Program

This program detects and handles errors of the following items (1) to (4). For information on error codes, refer to 9.7.1. *Error Code List*.

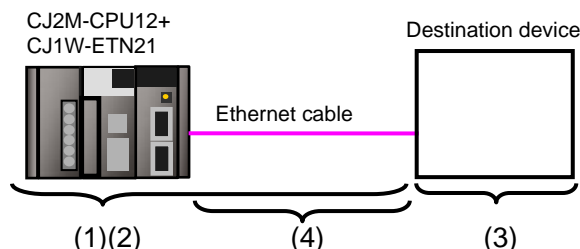

(1) Communications errors in TCP socket communications manipulating the dedicated control bit

Errors occurred during TCP socket communications such as Unit error, command format error and parameter error are detected as communications errors. An error is detected with a response code in the allocated DM area when performing TCP socket communications manipulating the dedicated bit.

(2) Timeout errors during communication with the destination device

When the open processing, send processing, receive processing, or close processing is not normally performed and cannot be completed within the monitoring time, it is detected as a timeout error. An error is detected by the timer monitoring function in the program. For information on the time monitoring function of the timer in the program, refer to 9.3.2. *Time Monitoring Function*.

(3) Errors in the destination device (Destination device error)

The destination device errors include a command error, a parameter error, and an execution failure in the destination device. An error is detected with the response data which is returned from the destination device. With this program, a destination device error is detected with the response code, which is returned from the destination device when the error occurs. For information on the send/receive messages, refer to 9.2. *Destination Device Command*.

Normal message	'GETR'	'0000'	*...*	#0A
	Command code	Response code	Response data	Terminator
Error message	'GETR'	****	#0A	
	Command code	Response code	Terminator	
Error message (Undefined command)	'ICMD'	****	#0A	
	Command code	Response code	Terminator	

(4) TCP connection status error when ending the processing

With this program, the close processing is always performed at the end of the whole processing regardless of whether each processing from the open processing to the receive processing ends normally or in an error. The TCP connection status in the allocated DM area is used to detect whether the close processing ends normally. When the close processing is operated abnormally, the next open processing may not be performed normally. For information on the corrective actions for the TCP connection status error, refer to *9.7.2 TCP Connection Status Error and Corrective Actions*.

9.3.2. Time Monitoring Function

This section explains the time monitoring function of this program. You can change the monitoring time by changing the setting values in the program.

- Time monitoring function of the communication instruction processing

To avoid errors that keep a communications process executing without a stop, the timer in this program is used to abort the processing (timeout). The timeout value for each processing from the open processing to the close processing is 5 seconds (default).

[Monitoring time of the communications instruction processing]

Processing	Monitoring	Timeout value
Open processing	Time from the start to the end of the open processing	5 seconds (default)
Send processing	Time from the start to the end of the send processing *When the receive processing required setting is set, the time monitoring timer confirms the arrival of the first receive data and determines that the processing is completed.	5 seconds (default)
Receive processing	Time from the start to the end of the receive processing *When the receive processing is repeated, the time monitoring timer monitors each receive processing separately.	5 seconds (default)
Close processing	Time from the start to the end of the close processing *The time monitoring timer confirms the normal TCP connection status after the close processing and determines that the processing is completed.	5 seconds (default)

- Receive wait function of the divided packets

The receive processing is repeated to receive divided packets for when receive data are divided and arrive. 300 ms (default) is set as a parameter of the socket service at the receive processing. Then, if the receive data does not arrive from the destination device within this time at each receive processing (if the receive data arrive at an interval of more than 300 ms), repeating the receive processing will end.



Additional Information

For information on the time monitoring function of the socket service, refer to *6-7 Using Socket Services by Manipulating Dedicated Control Bits of the CJ-series Ethernet Units Operation Manual Construction of Applications (Cat.No. W421)*.

- Resend/time monitoring functions of the PLC (TCP/IP)

When a communication problem occurs, TCP/IP will automatically resend the data and monitor the processing time if there is no error in the PLC. If the processing ends in an error, this program will perform the close processing and stop the TCP/IP resend/time monitoring function. If a TCP connection status error occurs during the close processing, the TCP/IP resend/time monitoring function of the PLC may be operating. For information on the status and corrective actions, refer to *9.7.2. TCP Connection Status Error and Corrective Actions*.

9.4. Memory Maps

This section shows the memory maps of this program.

9.4.1. Lists of Addresses

The tables below list the addresses necessary to execute this program.

You can change the allocation below to any addresses.



Precautions for Correct Use

Make sure there is no duplicated address when changing the addresses.

•Input addresses

These addresses are used to operate this program.

Address	Data type	Symbol name	Explanation
5000.00	BOOL	Input_Start	When this flag is changed from OFF to ON, the program starts.
5010	UINT_BCD	Input_OpenMonitoringTime_BCD	Sets the monitoring time of the open processing in increments of 10 ms. (#500: 5 s is set.)
5011	UINT_BCD	Input_SendMonitoringTime_BCD	Sets the monitoring time of the send processing in increments of 10 ms. (#500: 5 s is set.)
5012	UINT_BCD	Input_ReceiveMonitoringTime_BCD	Sets the monitoring time of the receive processing in increments of 10 ms. (#500: 5 s is set.)
5013	UINT_BCD	Input_CloseMonitoringTime_BCD	Sets the monitoring time of the close processing in increments of 10 ms. (#500: 5 s is set.)
5014	UINT	Input_ReceiveWaitingTime_BIN	Sets the waiting time for the receive data in increments of 100 ms. (&3: 300 ms is set.)

Address	Data type	Symbol name	Explanation
5020	UINT	Input_ReceiveProcessingRequired/NotRequired	<p>Sets the receive processing required/not required setting considering whether there is a response from the destination device to the command sent from the PLC.</p> <p>*When the receive processing is not required: Sets &0. This program does not wait for an arrival of the receive data at the send processing, skips the receive processing and shifts to the close processing. This is specified when any response data is not sent for the sent command.</p> <p>*When the receive processing is required: Sets &1. This program waits for the receive data at the send processing. After confirming that the receive data arrived, this program shifts to the receive processing. This is specified when response data is sent for the sent command.</p>
D9000	UINT	Input_NoOfBytesToSend	Sets the number of bytes to send.
D9001 D9002 to D9128	WORD[128]	Input_SendData[0] Input_SendData[1] to Input_SendData[127]	The storage area of the send data. The send command is set. (128-word area is secured.)

●Output addresses

The execution results of the program are stored in these addresses.

Address	Data type	Symbol name	Explanation
D10000	INT	Output_NoOfBytesToReceive	Stores the number of bytes to receive.
D10001 D10002 to D12000	WORD[2000]	Output_ReceiveData[0] Output_ReceiveData[1] to Output_ReceiveData[1999]	Stores the receive data (response). (2000-word area is secured.)
H400	WORD	Output_OpenErrorCode	Stores the error code for a communications error or timeout error detected during open processing. #0000 is stored for a normal end.
H401	WORD	Output_SendErrorCode	Stores the error code for a communications error or timeout error detected during send processing. #0000 is stored for a normal end.
H402	WORD	Output_ReceiveErrorCode	Stores the error code for a communications error or timeout error detected during receive processing. #0000 is stored for a normal end.

Address	Data type	Symbol name	Explanation
H403	WORD	Output_DestinationDevice ErrorCode	Stores the error code for a destination device error detected after the receive processing. #0000 is stored for a normal end.
H404	WORD	Output_CloseErrorCode	Stores the error code for a communications error, timeout error, or TCP connection status error detected during close processing. #0000 is stored for a normal end.

●Internal addresses

These addresses are used to operate this program only.

Address	Data type	Symbol name	Explanation
5000.01	BOOL	Local_CommunicationsInProgress	Turns ON when this program is being operated. Turns OFF when not operated.
5000.02	BOOL	Local_ReceiveProcessingRequired	When this flag turns ON, the receive processing is performed after the send processing.
5000.03	BOOL	Local_ReceiveProcessingNotRequired	When this flag turns ON, the receive processing is skipped after the send processing and the close processing is performed.
5000.04	BOOL	Local_InitialSettingCompleted	Turns ON when the initialization settings are completed.
5001.00	BOOL	Local_OpenExecuting	Turns ON during the open processing.
5001.01	BOOL	Local_OpenNormalEnd	Turns ON when the open processing ends normally.
5001.02	BOOL	Local_OpenErrorEnd	Turns ON when the open processing abnormally ends.
5001.03	BOOL	Local_OpenResponseCodeError	Turns ON when an error is indicated by the response code of the socket service parameter area (allocated DM area) after the open processing.
5001.04	BOOL	Local_OpenTimeout	Turns ON when the open processing times out.
5002.00	BOOL	Local_SendExecuting	Turns ON during the send processing.
5002.01	BOOL	Local_SendNormalEnd	Turns ON when the send processing ends normally.
5002.02	BOOL	Local_SendErrorEnd	Turns ON when the send processing ends abnormally.
5002.03	BOOL	Local_SendResponseCodeError	Turns ON when an error is indicated by the response code of the socket service parameter area (allocated DM area) after the send processing.
5002.04	5002.04	Local_SendTimeout	Turns ON when the send processing times out.
5003.00	BOOL	Local_ReceiveExecuting	Turns ON during the receive processing.
5003.01	BOOL	Local_ReceiveNormalEnd	Turns ON when the receive processing ends normally.
5003.02	BOOL	Local_ReceiveErrorEnd	Turns ON when the receive processing ends abnormally.

Address	Data type	Symbol name	Explanation
5003.03	BOOL	Local_ReceiveResponseCodeError	Turns ON when an error is indicated by the response code of the socket service parameter area (allocated DM area) after the receive processing.
5003.04	BOOL	Local_ReceiveTimeout	Turns ON when the receive processing times out.
5003.05	BOOL	Local_ReceiveDestinationDeviceError	Turns ON when a destination device error is detected after the receive processing.
5003.06	BOOL	Local_ReceiveRepeatON	Turns ON when repeating the receive processing is necessary.
5003.07	BOOL	Local_ReceiveRequestON	Used to manipulate a dedicated control bit for a receive request. This address changes between ON and OFF repeatedly when repeating the receive processing is necessary.
5004.00	BOOL	Local_CloseExecuting	Turns ON during the close processing.
5004.01	BOOL	Local_CloseNormalEnd	Turns ON when the close processing ends normally.
5004.02	BOOL	Local_CloseErrorEnd	Turns ON when the close processing ends abnormally.
5004.03	BOOL	Local_CloseResponseCodeError	Turns ON when an error is indicated by the response code of the socket service parameter area (allocated DM area) after the close processing.
5004.04	BOOL	Local_CloseTimeout	Turns ON when the close processing times out.
5004.05	BOOL	Local_CloseStatusError	Turns ON if an error was detected in the TCP connection status after the close processing.
5005	UINT	Local_TCPConnectionStatus	Obtains and sets the lower 4 bits of the TCP connection status from the allocated DM area to determine the TCP connection status after the close processing.
5030	UINT	Local_SendDataAddressType	Sets the memory for the send data storage area. (#82: This is the DM area.)
5031	UINT	Local_FirstSendWord	Sets the start word for the send data storage area. (&9001: The memory is set to the DM area, and D9001 is set as the start word.)
5110	UINT	Local_ReceiveDataAddressType	Sets the memory for the receive data storage area. (#82: This is the DM area.)
5111	INT	Local_FirstReceiveWord	Sets the start word for the receive data storage area. (&10001: The memory is set to the DM area, and D10001 is set as the start word.)
5112	INT	Local_FirstReceiveWordOffset	Stores the offset value of the storage address if there are multiple receive data.
5113	INT	Local_FirstReceiveWordDivisionRemainder	Stores the remainder (1 or 0) obtained by dividing the bytes of the last receive data by two to calculate the address where the current receive data is stored.

Address	Data type	Symbol name	Explanation
5114	UINT	Local_ReceiveDataJudgmentArea_UNIT	Converts the receive data from WORD to UNIT for comparison and determination.

- Timers

This program uses the following timers.

Address	Data type	Symbol name	Explanation
T1000	BOOL	Local_OpenMonitoringTimerON	Counts the time taken to perform the open processing.
T1001	BOOL	Local_SendMonitoringTimerON	Counts the time taken to perform the send processing.
T1002	BOOL	Local_ReceiveMonitoringTimerON	Counts the time taken to perform the receive processing.
T1003	BOOL	Local_CloseMonitoringTimerON	Counts the time taken to perform the close processing.

9.4.2. List of Fixed Allocations

The tables below list the addresses necessary to execute this program.

They are fixed addresses determined by the unit address (unit number) that is set for the Ethernet Unit and the socket number used. Therefore, you must not change these allocations. With this program, the unit number is set to 0, the TCP socket number is 8 and the socket service parameter area is 8.

- Allocated CIO area

Address	Data type	Symbol name
1516.13	BOOL	ETN_ReceiveData
1522.10	BOOL	ETN_OpenRequest
1522.11	BOOL	ETN_SendRequest
1522.12	BOOL	ETN_ReceiveRequest
1522.13	BOOL	ETN_CloseRequest

- Allocated DM area

Address	Data type	Symbol name
D30008	UINT	ETN_TCPNoOfBytesToReceive
D30016	UINT	ETN_TCPConnectionStatus
D30088	UINT	ETN_SocketNo8
D30089	UINT	ETN_LocalPortNo
D30090	UINT	ETN_DestinationIPAddress_1
D30091	UINT	ETN_DestinationIPAddress_2
D30092	UINT	ETN_DestinationPortNo
D30093	INT	ETN_NoOfBytesToSendReceive
D30094	UINT	ETN_SendReceiveDataAddress1
D30095	UINT	ETN_SendReceiveDataAddress2
D30096	UINT	ETN_TimeoutValue
D30097	UINT	ETN_ResponseCode

**Additional Information**

For information on the allocated CIO and DM areas, refer to *Section 6 Socket Services* of the *CJ-series Ethernet Units Operation Manual Construction of Applications* (Cat.No. W421).

9.5. Ladder Program

9.5.1. Functional Components of the Ladder Program

The functional components of this program are shown below.

Major classification	Minor classification	Description
1. Start & Set	1.1 Start processing 1.2 Send data setting 1.3 Control word setting 1.4 Common parameter setting 1.5 Receive data storage area setting 1.6 Receive processing required/not required flag setting 1.7 Error code storage area initialization 1.8 Initialization setting end processing	The communications processing starts, the command and parameters are set, and the error code storage area is initialized.
2. Open processing	2.1 Open processing start 2.2 Socket service parameter area setting 2.3 Open request dedicated control bit ON 2.4 Normal/error detection processing 2.5 Error code storage area setting	The TCP open (ACTIVE) processing is performed. The processing starts unconditionally after starting the communications processing and making the initialization settings.
3. Send processing	3.1 Send processing start 3.2 Socket service parameter area setting 3.3 Send request dedicated control bit ON 3.4 Normal/error detection processing 3.5 Error code storage area setting	The send processing is performed. The processing starts when the open processing is completed normally.
4. Receive processing	4.1 Receive processing start 4.2 Socket service parameter area setting 4.3 Receive request ON 4.4 Receive request dedicated control bit ON 4.5 Normal/error detection processing 4.6 Receive processing repeat information calculation 4.7 Error code storage area setting	The processing starts when the receive processing required setting is set and the send processing is completed normally. The receive processing is repeated when the receive data is divided into multiple data and received.
5. Close processing	5.1 Close processing start 5.2 Socket service parameter area setting 5.3 Close request dedicated control bit ON 5.4 Normal/error detection processing 5.5 Error code storage area setting	The close processing is performed. The processing starts in the following cases: <ul style="list-style-type: none"> •When the receive processing not required setting is set and the send processing is completed normally. •When the receive processing ends normally •When the open processing ends abnormally •When the send processing ends abnormally •When the receive processing ends abnormally

9.5.2. Detailed Description of Each Functional Component

This section shows the program. To change the communications settings, edit the code specified by the red frames.

●1. Start&Set

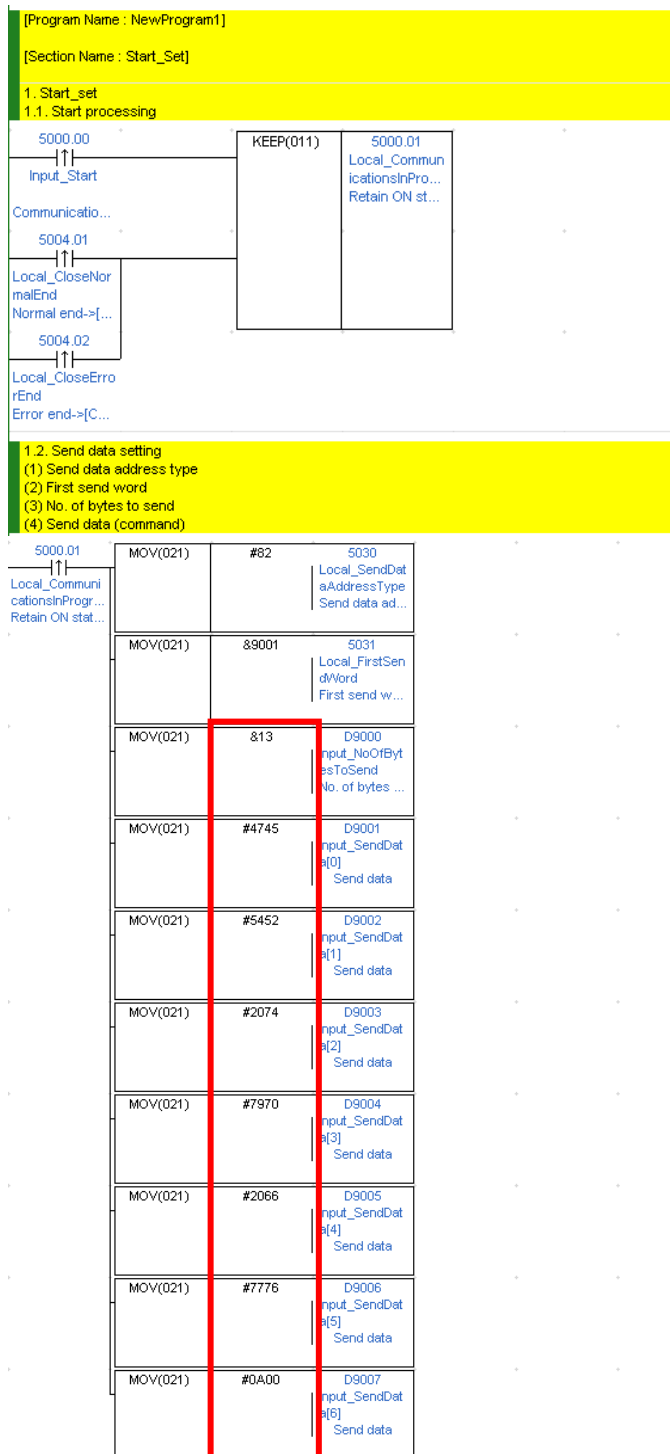

No.	Function	Description
1.1.	Start processing	Turns ON the Input_Start Switch and starts the communications processing. When the close processing is completed, the communications processing ends.
1.2.	Send data setting	Sets the number of bytes to send and the send data (command).

1.3. Control data setting
 (1) Open processing maximum waiting time (Unit: 10ms_BCD)
 (2) Send processing maximum waiting time (Unit: 10ms_BCD)
 (3) Receive processing maximum waiting time (Unit: 10ms_BCD)
 (4) Close processing maximum waiting time (Unit: 10ms_BCD)
 (5) Receive data arrival waiting time (Unit: 100ms_BIN)
 (6) Receive processing required/not required setting for command send (&0: Required, &1: Not required)

5000.01 ↑↑ Local_Communi cationsInProgr... Retain ON stat...	MOV(021)	#500	5010 Input_OpenMo nitoringTime_... Open monitor...
	MOV(021)	#500	5011 Input_SendMo nitoringTime_... Send monitor...
	MOV(021)	#500	5012 Input_Receive MonitoringTi... Receive moni...
	MOV(021)	#500	5013 Input_CloseMo nitoringTime_... Close monito...
	MOV(021)	&3	5014 Input_Receive WaitingTime_... Receive wait...
	MOV(021)	&1	5020 Input_Receive ProcessingR... Receive proc...

1.4. Common parameter setting
 (1) Use socket No.8
 (2) Use socket service parameter area 8
 (3) Auto allocate local port No: &0
 (4) Destination IP address: 192.168.250.2
 (5) Destination IP port No: Same as for destination device

5000.01 ↑↑ Local_Communi cationsInProgr... Retain ON stat...	MOV(021)	&8	D30088 ETN_SocketNo 8 ETN Unit soc...
	MOV(021)	&0	D30089 ETN_LocalPort No ETN Unit loca...
	MOVD(083)	&192	#210 D30090 TN_Destination IPAddress1 ETN Unit dest...
	MOVD(083)	&168	#10 D30090 TN_Destination IPAddress1 ETN Unit dest...
	MOVD(083)	&250	#210 D30091 ETN_Destinatio nIPAddress2 ETN Unit dest...
	MOVD(083)	&2	#10 D30091 ETN_Destinatio nIPAddress2 ETN Unit dest...
	MOV(021)	&7090	D30092 ETN_Destinatio nPortNo ETN Unit dest...

No.	Function	Description
1.3.	Control word setting	Sets the monitoring time for each processing. Sets the receive processing required/not required setting.
1.4.	Common parameter setting	Sets the common parameter for TCP socket communications.

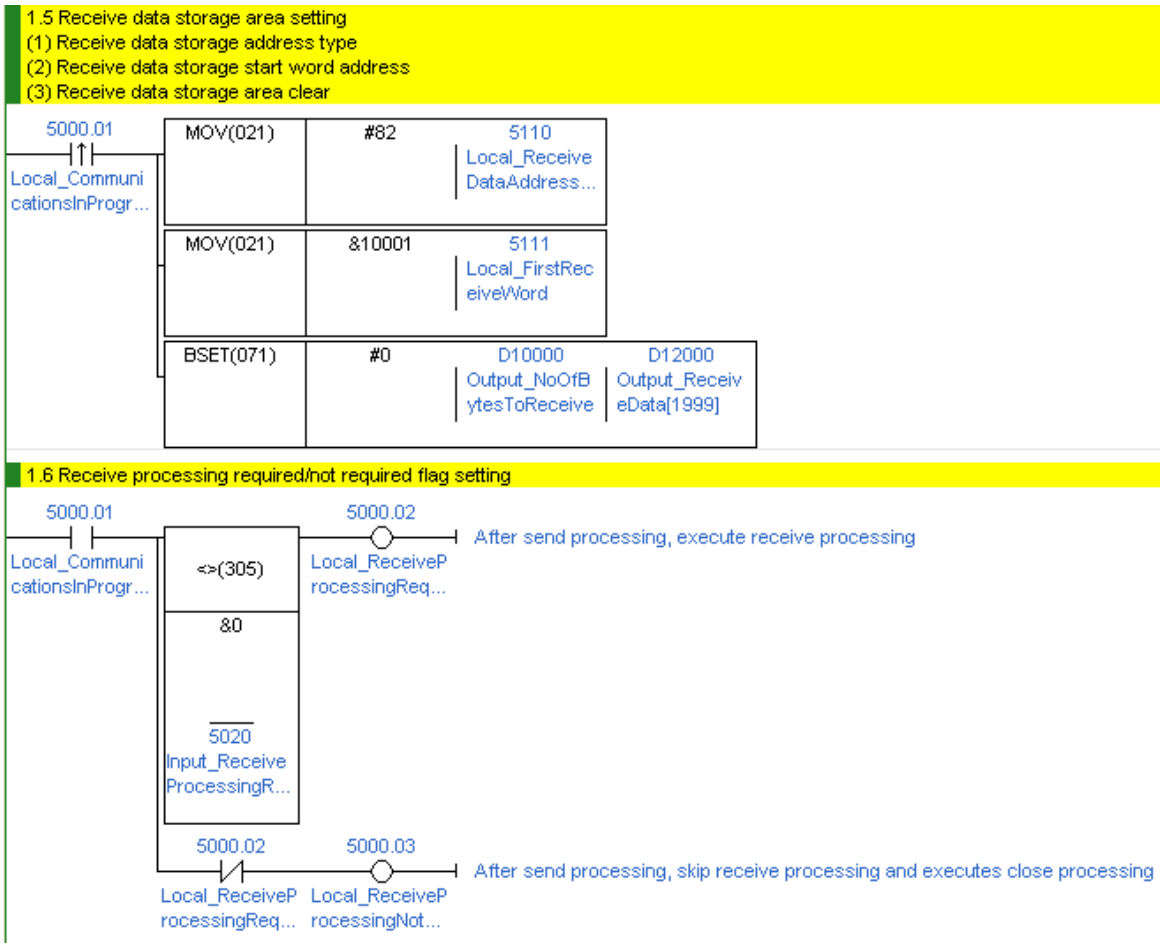

No.	Function	Description
1.5.	Receive data storage area setting	Initializes the receive data storage area.
1.6.	Receive processing required/not required flag setting	Reflects the receive processing required/not required setting in the flag.

Precautions for Safe Use

Make sure to sufficiently check the overall program before changing the receive data storage area. Or, data may be written to an unintended memory area.

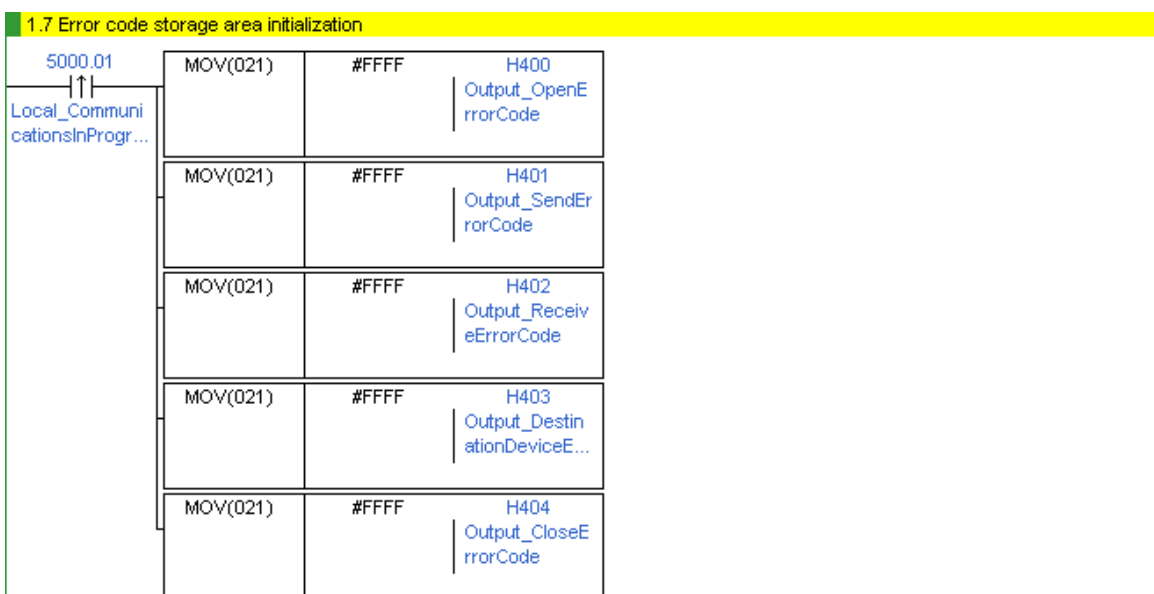

No.	Function	Description
1.7.	Error code storage area initialization	Initializes the error code storage area.
1.8.	Initialization setting end processing	Turns ON the initialization setting end flag.

●2. Open processing

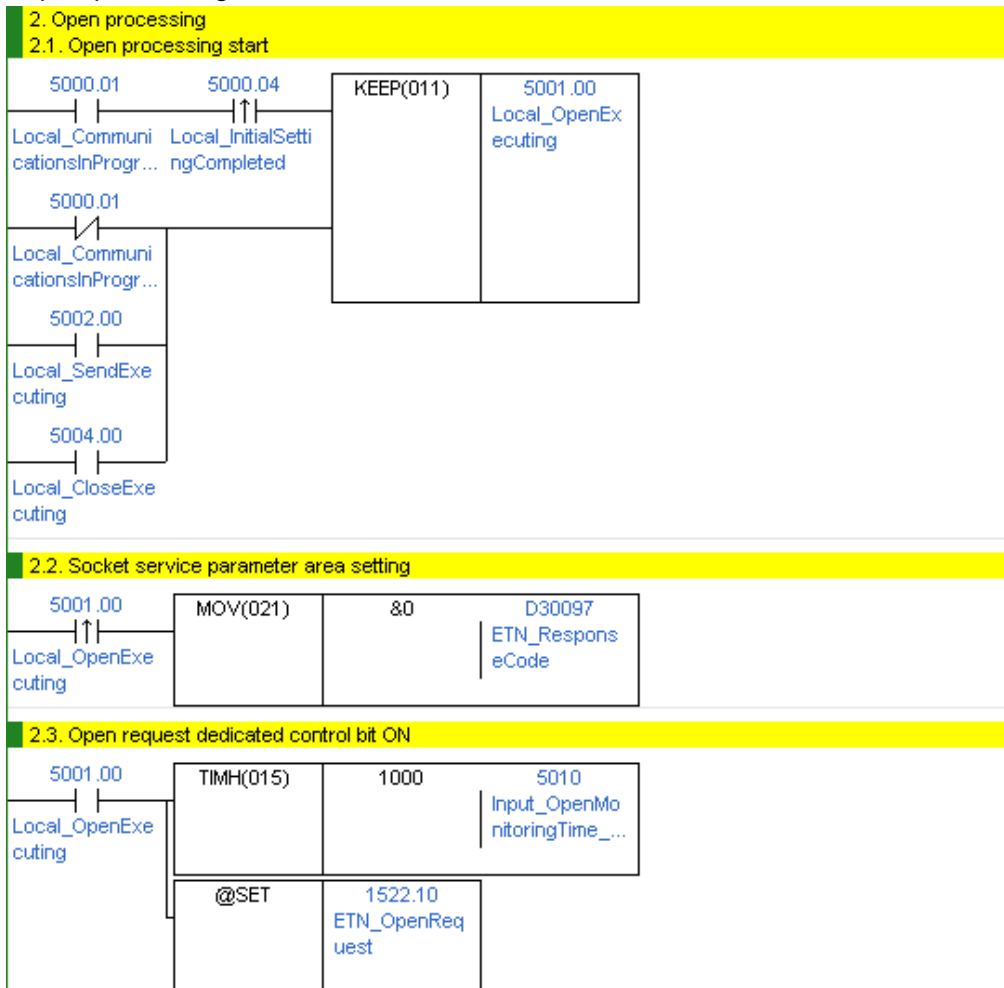

No.	Function	Description
2.1.	Open processing start	Starts the open processing. By shifting to the send processing or close processing, the open processing ends.
2.2.	Socket service parameter area setting	Sets the parameter necessary for the open processing. •Clears the response code storage area.
2.3.	Open request dedicated control bit ON	Starts the open processing monitoring timer, and turns ON the dedicated control bit used for the open processing request.

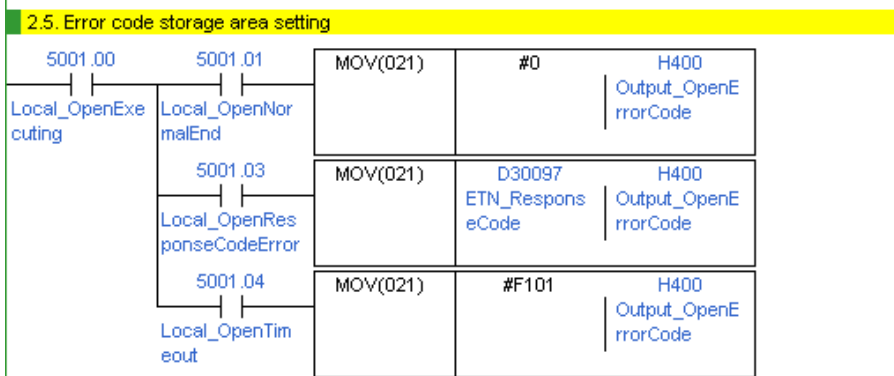
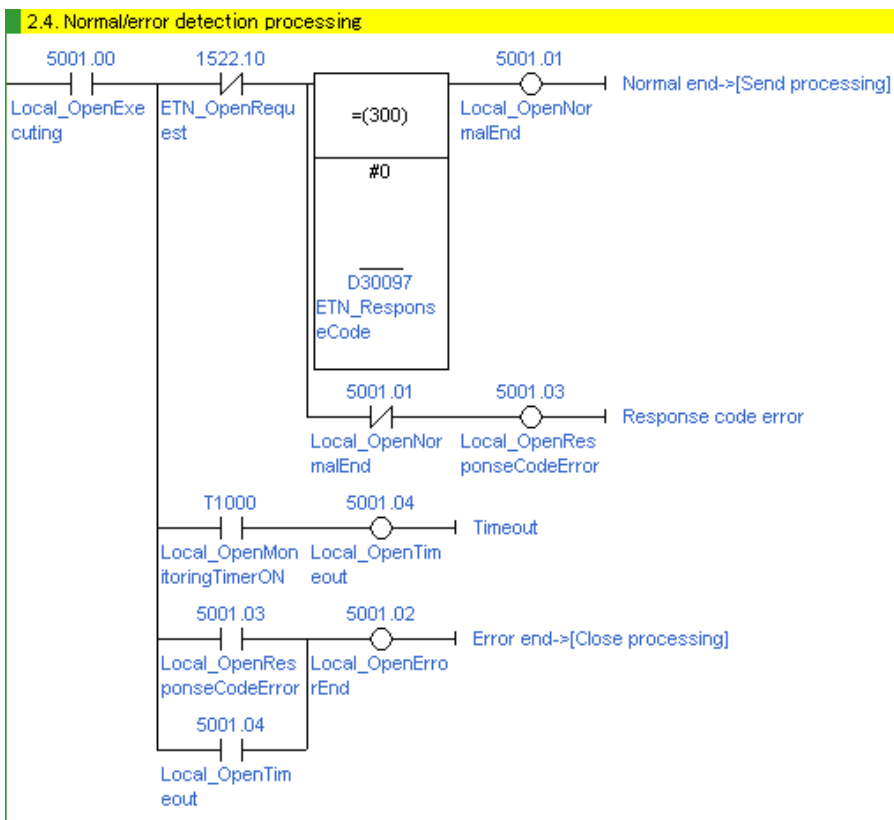

No.	Function	Description
2.4.	Normal/error detection processing	<p>Detects the open processing result as a normal end, an error end, or a timeout error.</p> <p>In the case of normal end, the processing is shifted to the send processing. In the case of error end, it is shifted to the close processing.</p>
2.5.	Error code storage area setting	<p>If it was detected in 2.4 Normal/Error Detection Processing that the processing ended normally, #0 is set in the error code storage area.</p> <p>If it was detected in 2.4 Normal/Error Detection Processing that the processing ended in error, either of the following values is set in the error code storage area.</p> <ul style="list-style-type: none"> •Socket service response code for a response code error •#F101 for a timeout <p>*For information on response codes, refer to 9.7.1 Error Code List.</p>

●3. Send processing

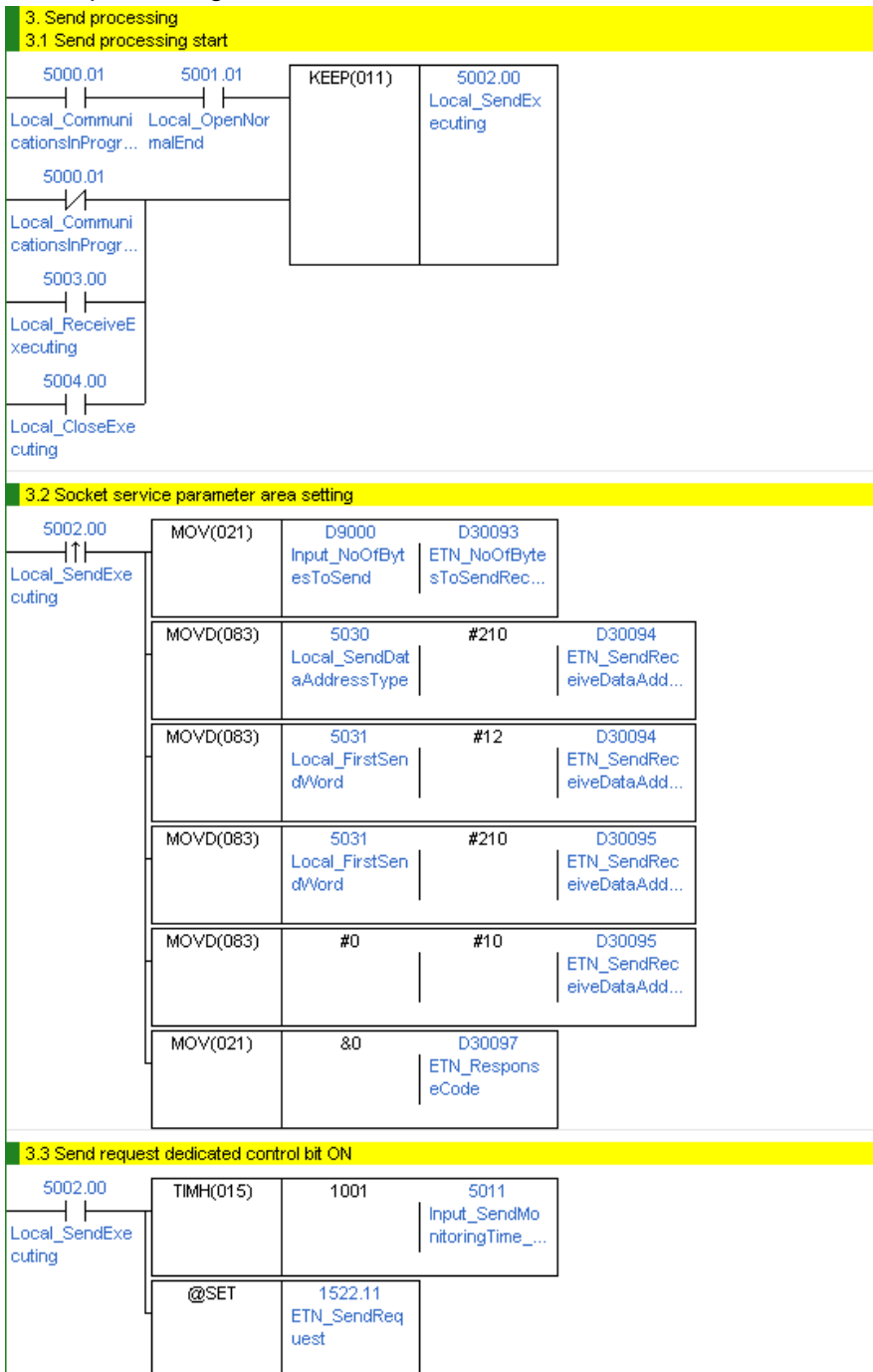

No.	Function	Description
3.1.	Send processing start	Starts the send processing By shifting to the receive processing or the close processing, the send processing ends.
3.2.	Socket service parameter area setting	Sets the parameter necessary for the send processing. <ul style="list-style-type: none"> •Sets the number of bytes to send. •Sets the memory for the send data storage area. •Sets the start address for the send data storage area. •Clears the response code storage area.
3.3.	Send request dedicated control bit ON	Starts the send processing monitoring timer, and turns ON the dedicated control bit for the send processing request.

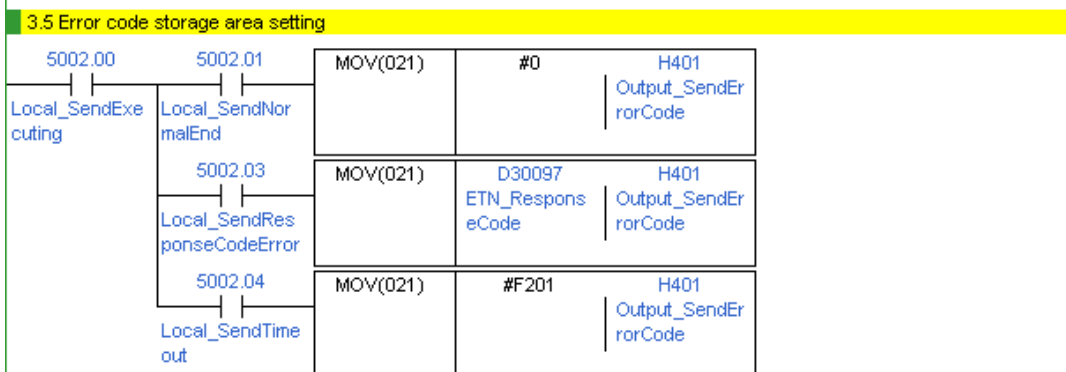
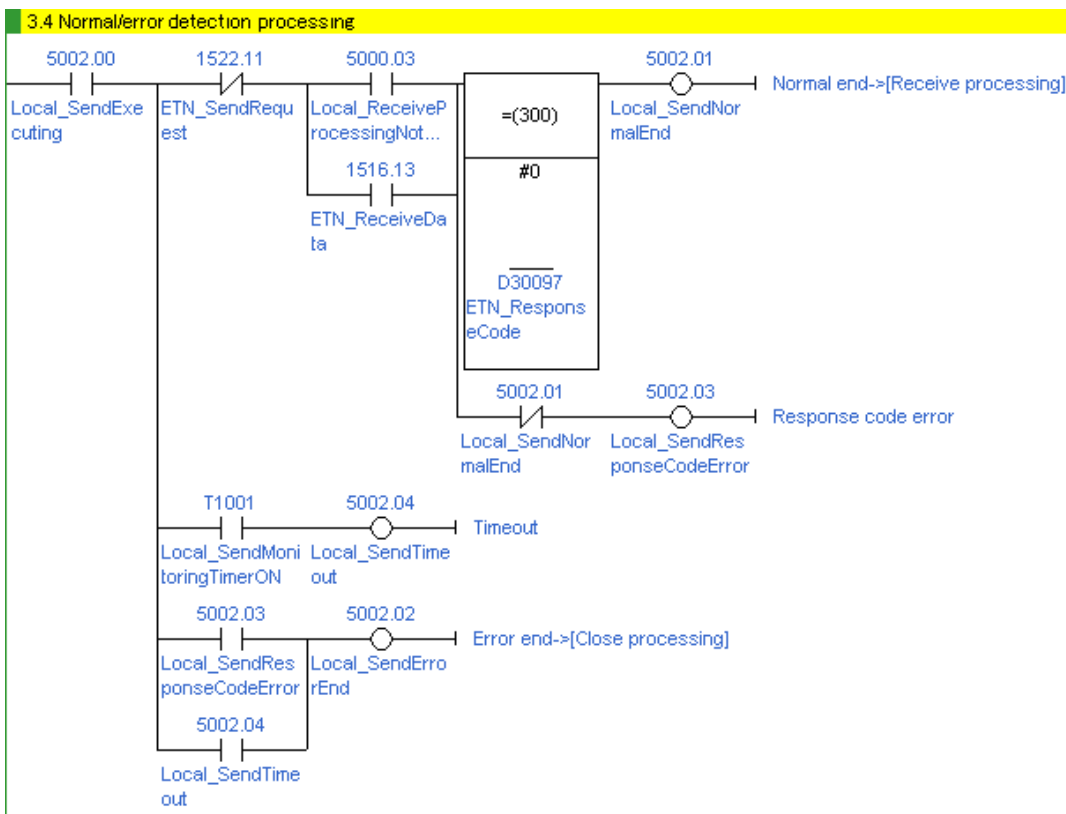

No.	Function	Description
3.4.	Normal/error detection processing	<p>Detects the send processing as a normal end, an error end or a timeout error.</p> <p>In the case of normal end, the processing is shifted to the receive processing. In the case of error end, it is shifted to the close processing.</p>
3.5.	Error code storage area setting	<p>If it was detected in 3.4 Normal/Error Detection Processing that the processing ended normally, #0 is set in the error code storage area.</p> <p>If it was detected in 3.4 Normal/Error Detection Processing that the processing ended in error, either of the following values is set in the error code storage area.</p> <ul style="list-style-type: none"> •Socket service response code for a response code error •#F201 for a timeout <p>*For information on response codes, refer to 9.7.1 Error Code List.</p>

● 4. Receive processing

4. Receive processing

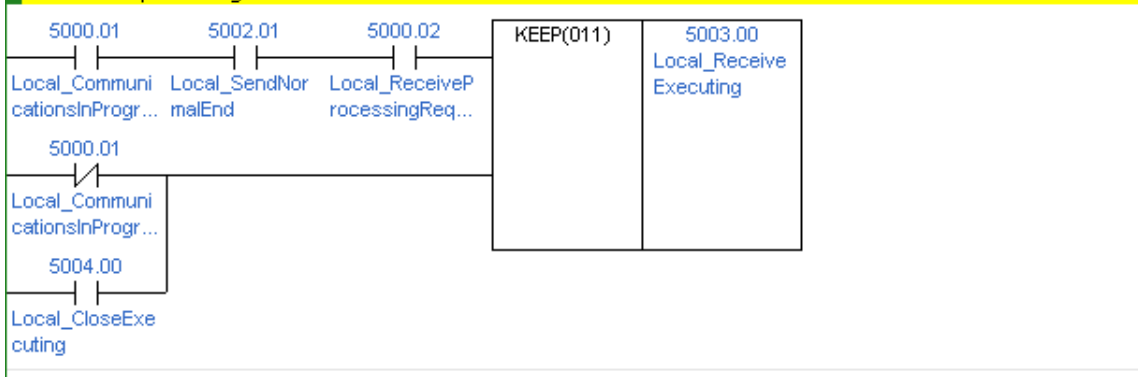

4.2 Socket service parameter area setting

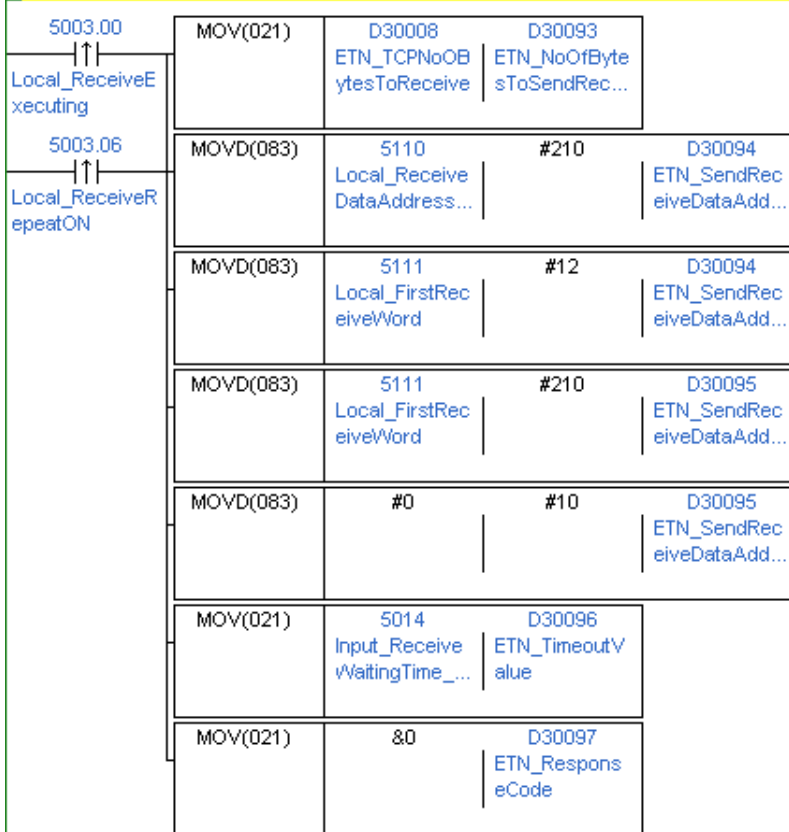

No.	Function	Description
4.1.	Receive processing start	Starts the receive processing when the receive processing required setting is set. The receive processing is skipped when the receive processing not required setting is set. By shifting to the close processing, the receive processing ends.
4.2.	Socket service parameter area setting	Sets the parameters necessary for the receive processing. <ul style="list-style-type: none"> •Sets the number of bytes to receive. •Sets the memory for the receive data storage area. •Sets the start address for the receive data storage area. •Sets the waiting time for the receive data. •Clears the response code storage area.

4.3 Receive request ON

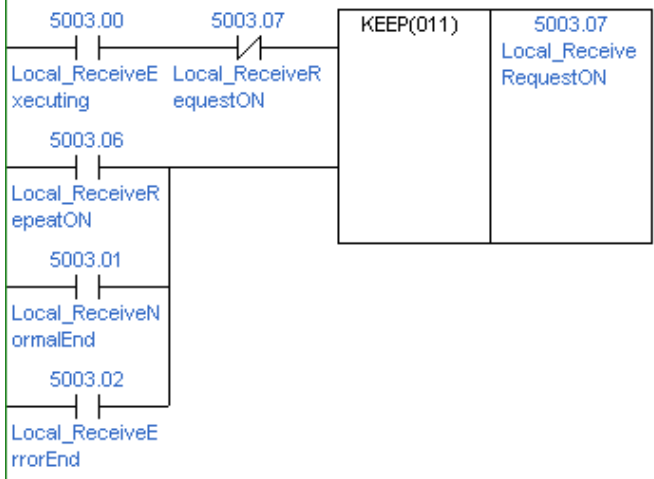

4.4 Receive request dedicated control bit ON

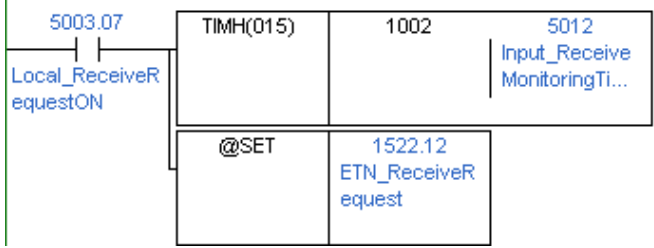

No.	Function	Description
4.3.	Receive request ON	Turns ON the receive request dedicated control bit by manipulating the Receive request ON. (Changing between ON and OFF the Receive request ON repeats the receive processing.)
4.4.	Receive request dedicated control bit ON	Starts the receive processing monitoring timer, and turns ON the dedicated control bit for the receive processing request.

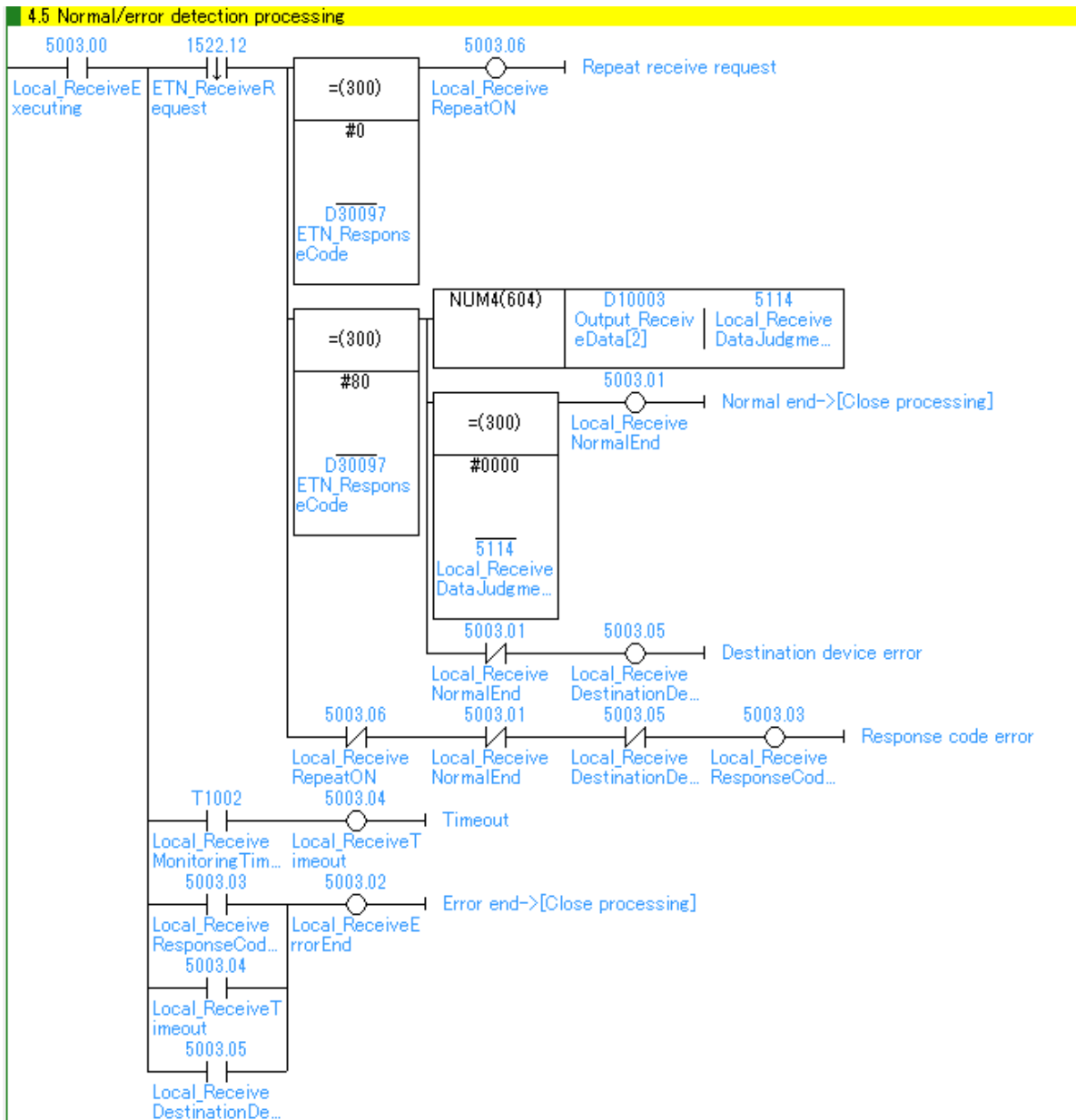

No.	Function	Description
4.5.	Normal/error detection processing	Detects whether it is necessary to repeat the receive processing, or whether a normal end, error end, timeout error or destination device error occurs after the receive processing. After the receive processing, the program shifts to the close processing.

4.6 Receive processing repeat information calculation

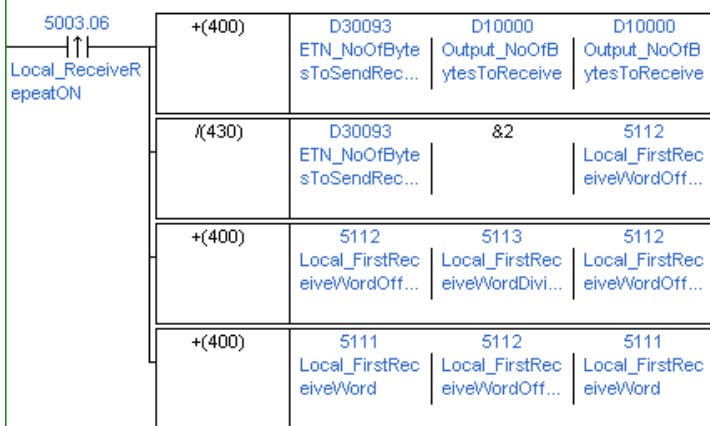

4.7 Error code storage area setting

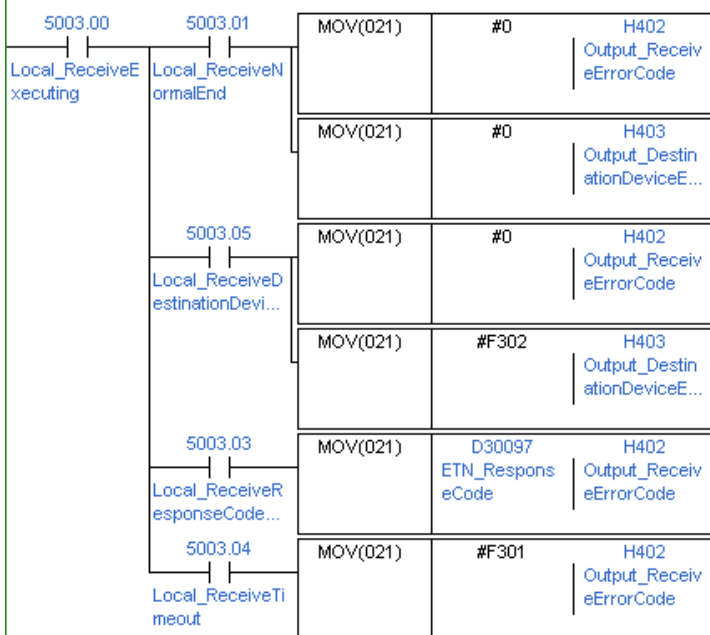

No.	Function	Description
4.6.	Receive processing repeat information calculation	When it is detected in 4.5. Normal/Error Detection Processing that the receive processing needs to be repeated, the following processing is performed. <ul style="list-style-type: none"> •The current number of bytes to receive is added to the total number of bytes to receive. •The start word is calculated to store the next receive data.
4.7.	Error code storage area setting	If it was detected in 4.5. Normal/Error Detection Processing that the processing ended normally, #0 is set in the error code storage area. If it was detected in 4.5. Normal/Error Detection Processing that the processing ended in error, one of the following values is set in the error code storage area. <ul style="list-style-type: none"> •Socket service response code for a response code error •#F301 for a timeout •#F302 for a destination device error or a destination device response code in hexadecimal *For information on response codes, refer to 9.7.1 Error Code List.

●5. Close processing

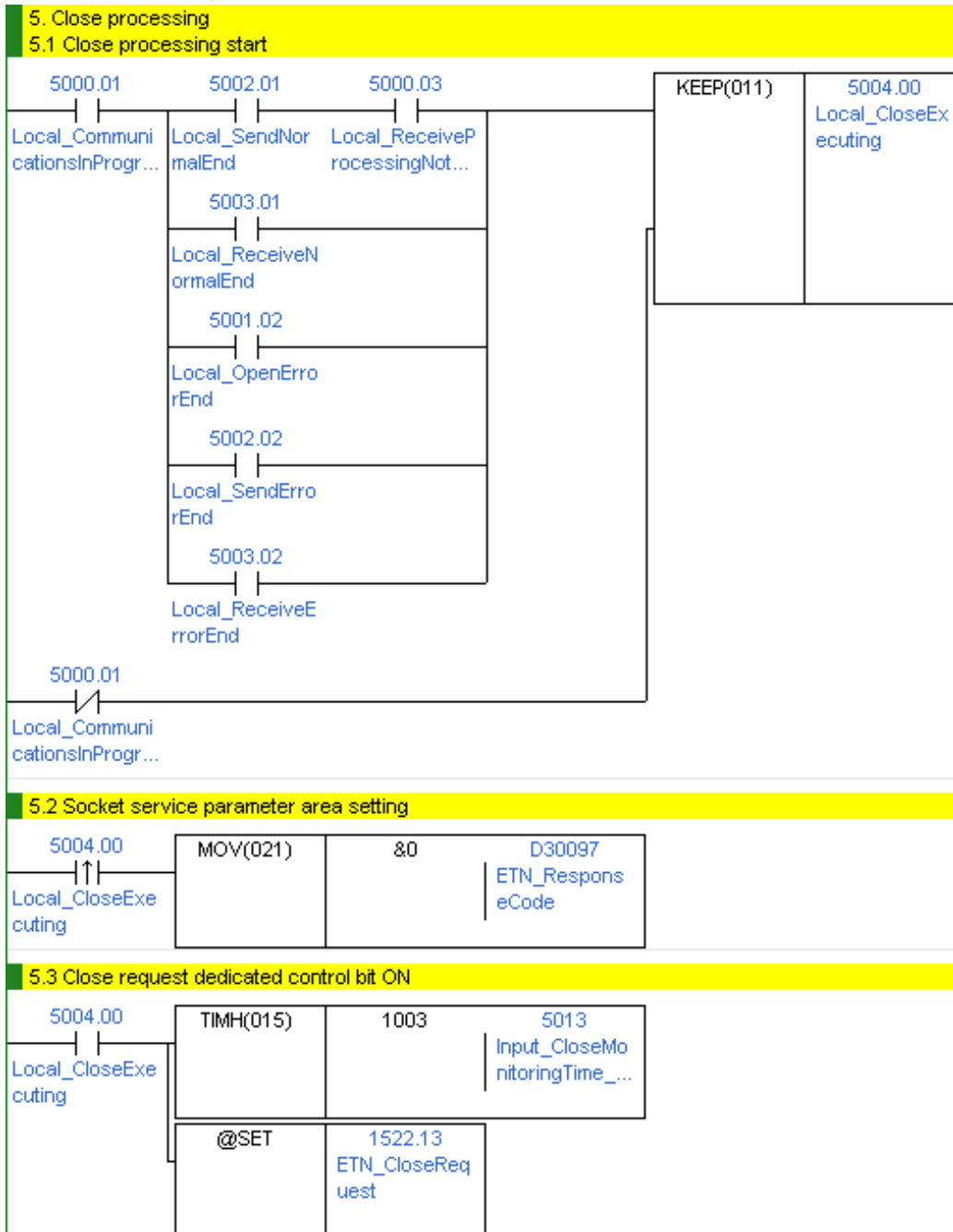

No.	Function	Description
5.1.	Close processing start	Starts the close processing. When ending the communications processing (when shifting to the non-execution status), the close processing ends.
5.2.	Socket service parameter area setting	Sets the parameter necessary for the close processing. •Clears the response code storage area.
5.3.	Close request dedicated control bit ON	Starts the close processing monitoring timer, and turns ON the dedicated control bit for the close processing request.

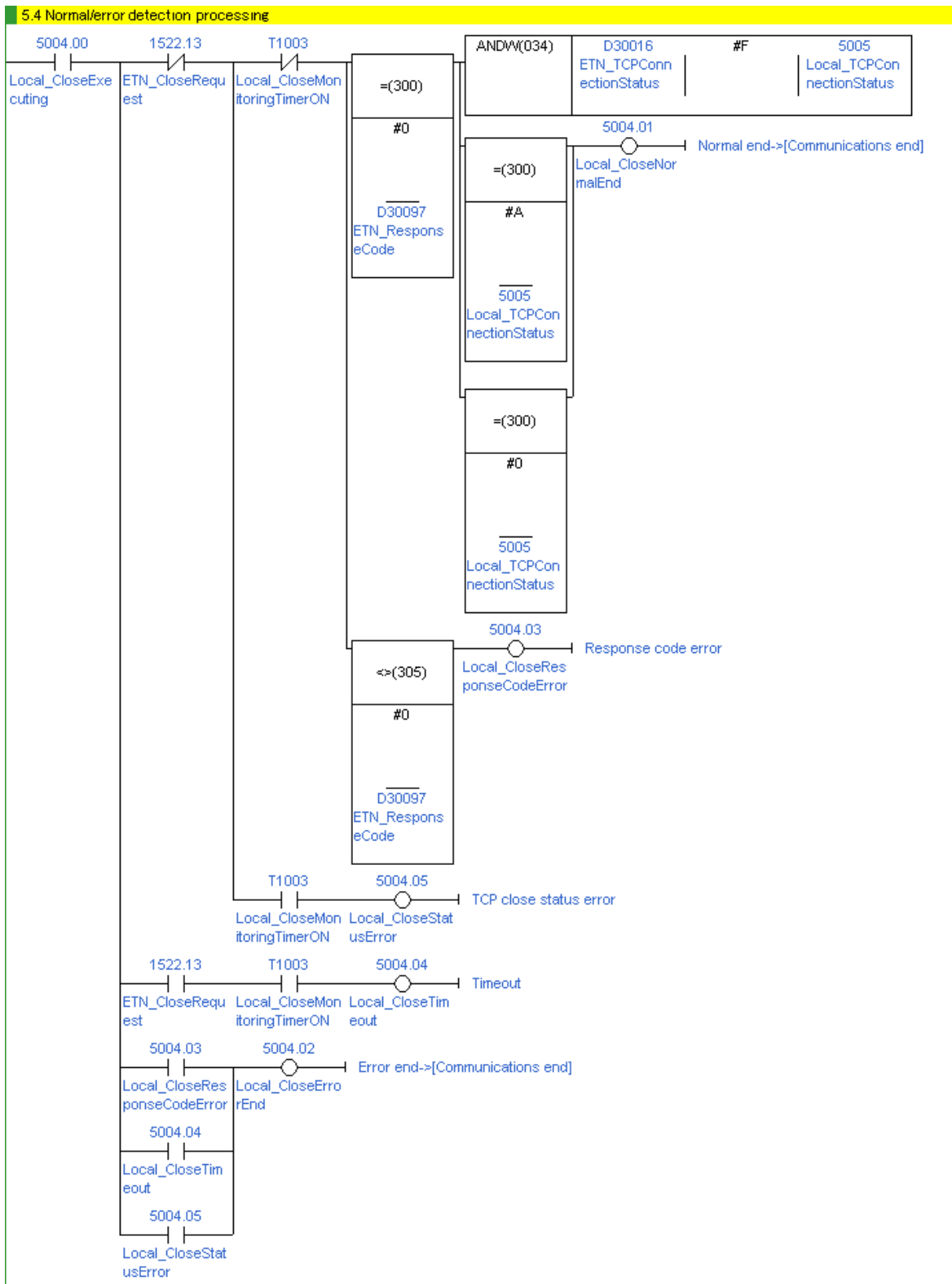

No.	Function	Description
5.4.	Normal/error detection processing	Detects the close processing as a normal end, an error end or a timeout error, or a close status error. After the close processing ends, the communication processing ends.

5.5 Error code storage area setting

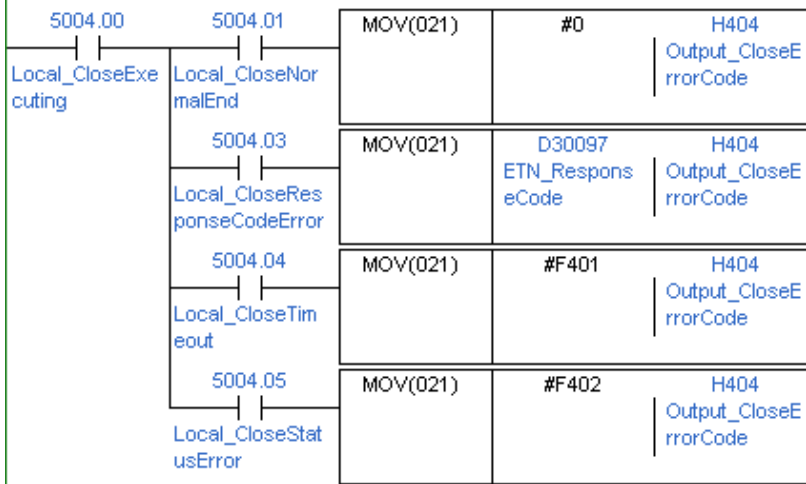

No.	Function	Description
5.5.	Error code storage area setting	<p>If it was detected in 7.4. Normal/Error Detection Processing that the processing ended normally, #0 is set in the error code storage area.</p> <p>If it was detected in 7.4. Normal/Error Detection Processing that the processing ended in error, one of the following values is set in the error code storage area.</p> <ul style="list-style-type: none"> •Socket service response code for a response code error •#F401 for a timeout •#F402 for a close processing status error <p>*For information on response codes, refer to 9.7.1. Error Code List.</p>

9.6. Timing Charts

The timing charts of the program are shown below.

●Start & set

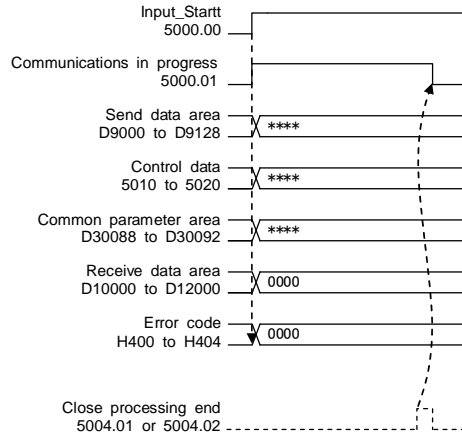

●Open processing

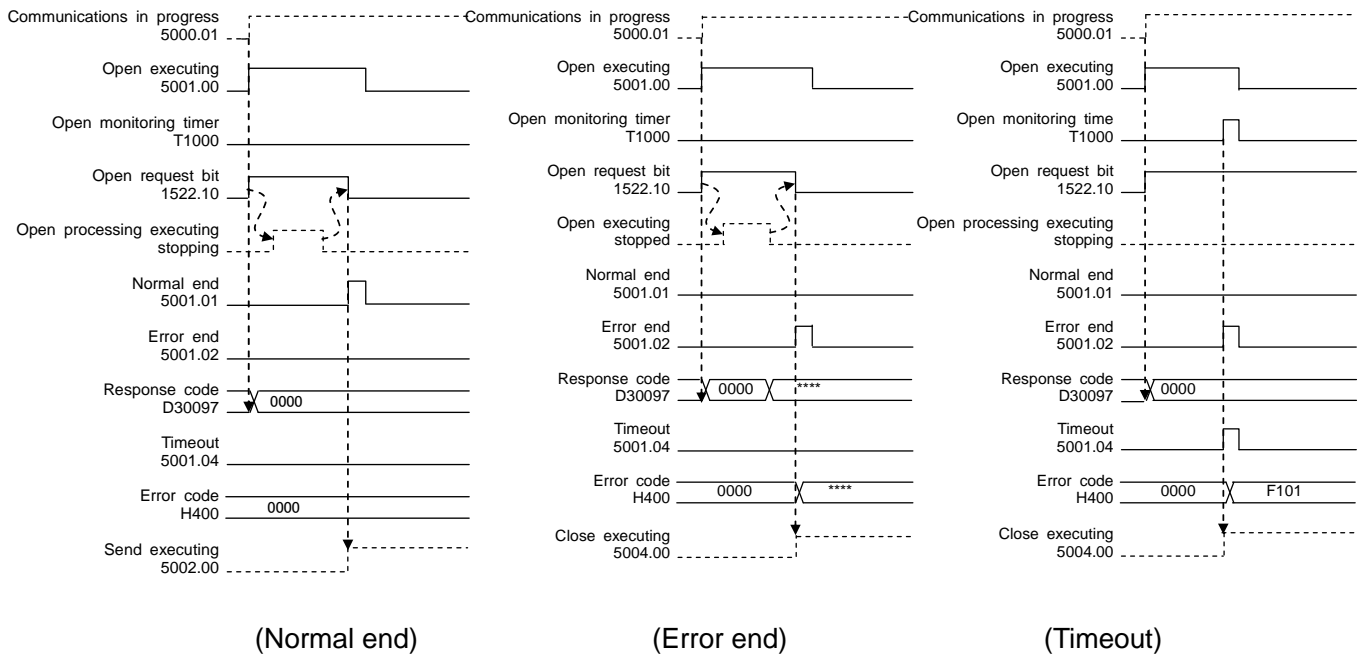

●Send processing

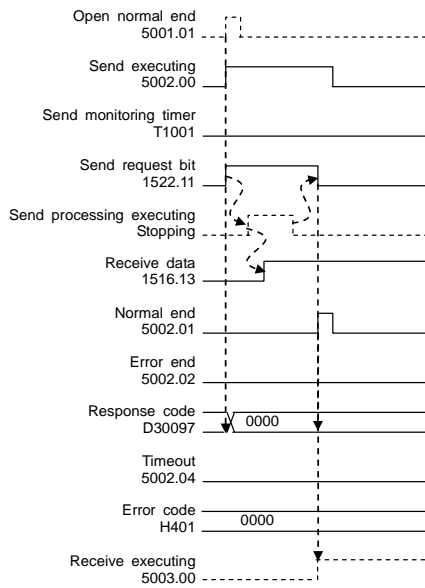

(Normal end)

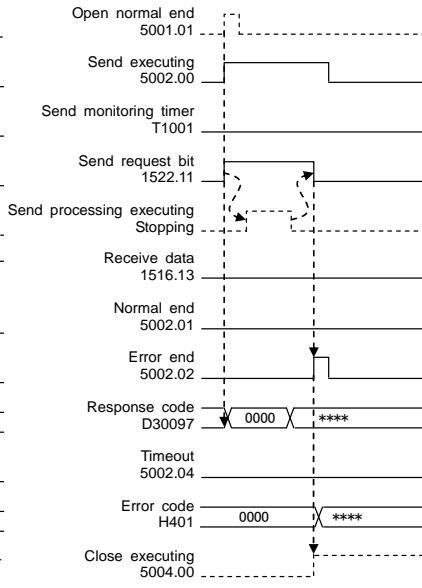

(Error end)

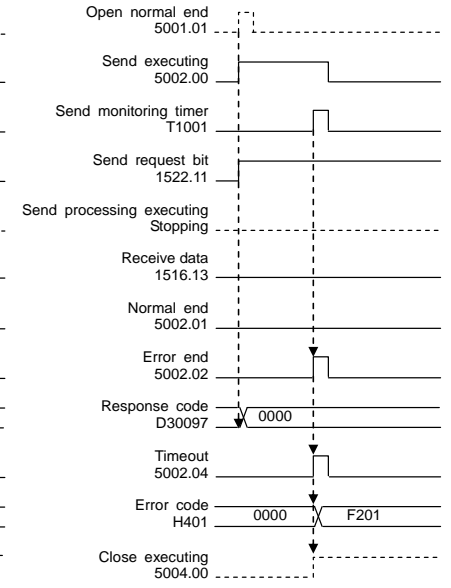

(Timeout)

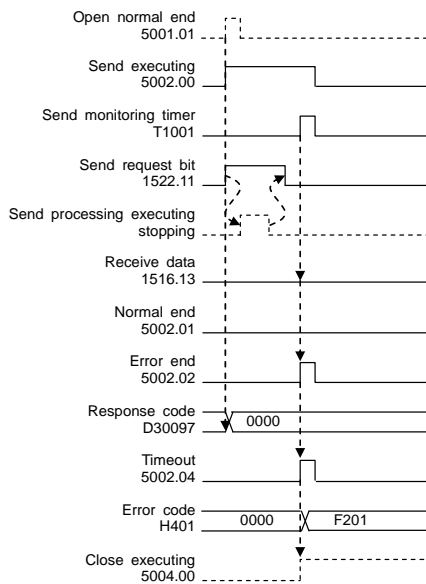

(Timeout: No receive data)

●Receive processing

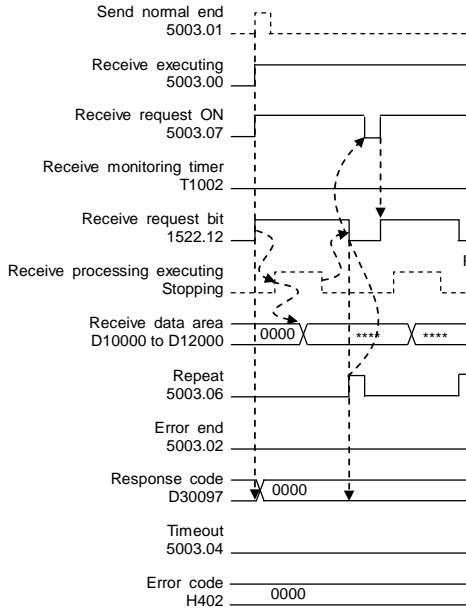

(Repeat)

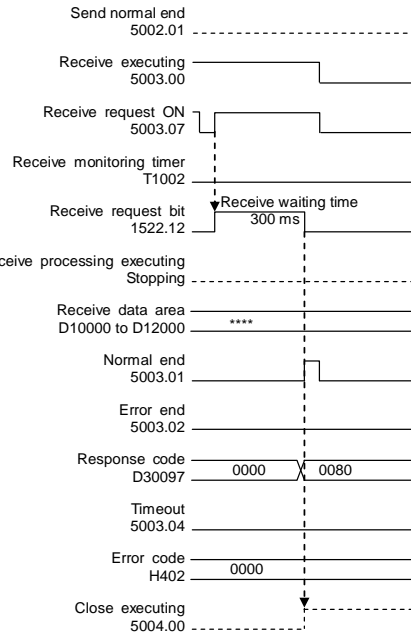

(Normal end)

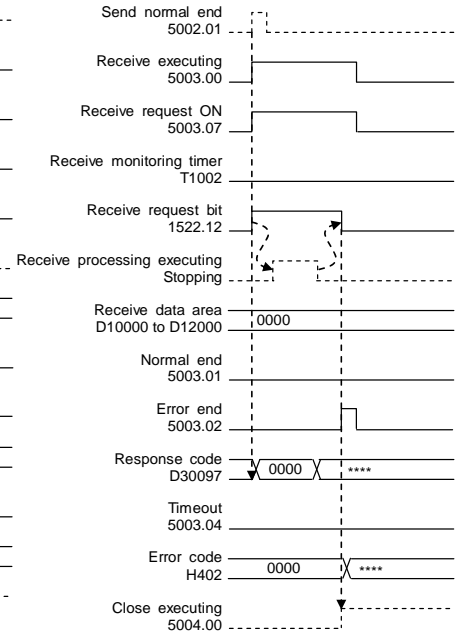

(Error end)

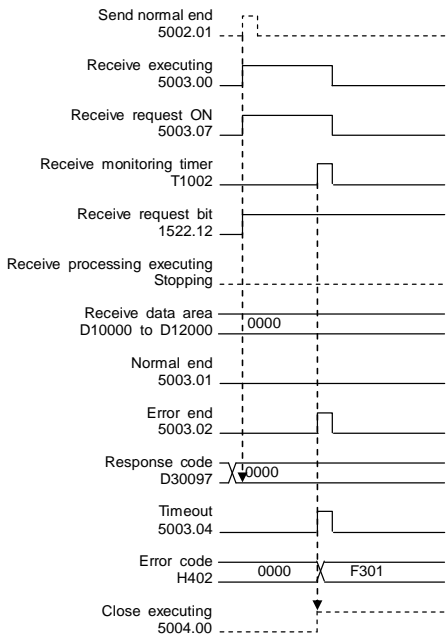

(Timeout)

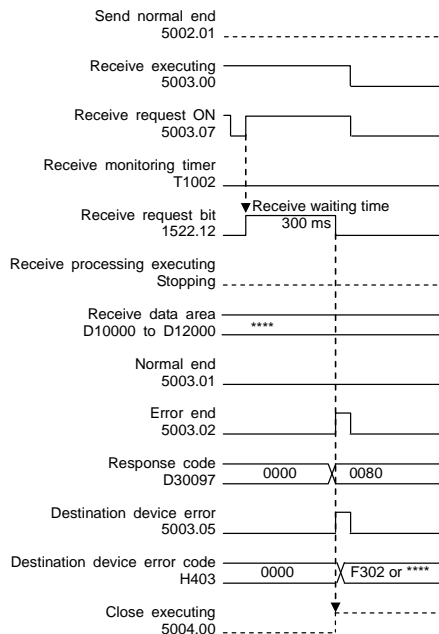

(Destination device error)

●Close processing

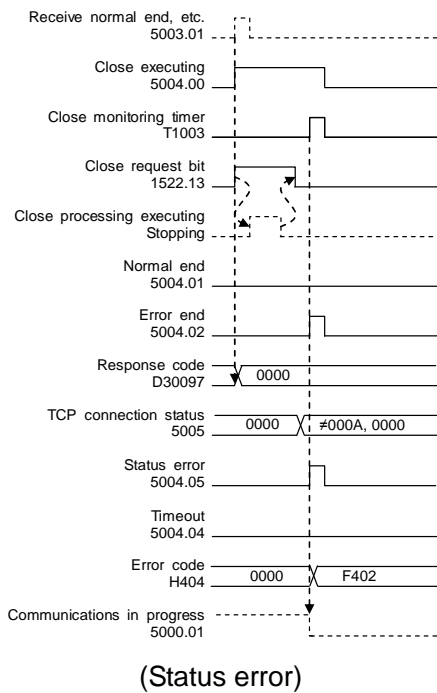
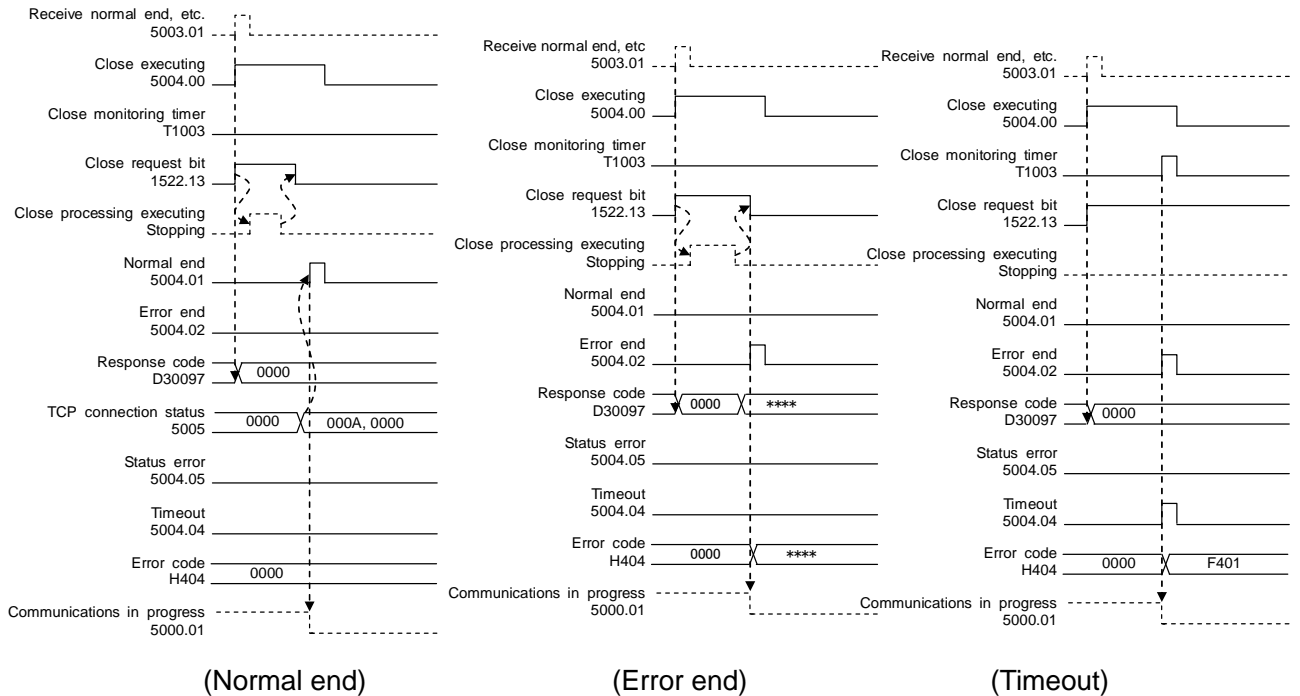

9.7. Error Process

9.7.1. Error Code Lists

The following tables list error codes for errors that occur during the execution of this program.

- Socket service response code list

H400 contains a response code for the open processing, H401 contains a response code for the send processing, H402 contains a response code for the receive processing and H404 contains a response code for the close processing.

Main response codes are given below.

Response code	Description
#0000	Normal end
#0105	Local IP address setting error
#0302	Unit error
#1100	TCP socket number is not 1 to 8, or destination IP address is 0 when performing open processing Number of bytes to send is not in allowable range. Number of bytes to receive is not in allowable range.
#1101	The area designation of the send/receive data address is not in allowable range.
#1103	The bit address of the send/receive data address is other than 0.
#110C	Request Switch turned ON during other processing.
#220F	Specified socket is already open or is performing the open processing. Specified socket is performing the send processing. Specified socket is performing the receive processing.
#2210	The specified socket is not been connected.
#2211	Unit is busy; cannot execute.
#2606	Specified socket is already open as UDP socket; cannot open TCP socket.
#2607	Specified Socket Service Parameter Area is already being used for another socket.
#000D	Destination IP address parameter error
#0020	Connection with destination socket broken during send.
#003E	Internal buffer cannot be obtained due to high reception traffic
#0045	Local socket closed
#0049	Port No. duplicated
#004A	Error occurs or the destination node has not been opened as passive socket during open. Error during communications with destination node during send.
#004B	Communications error with destination node
#004C	Destination IP address parameter error. Wrong parameter designation. An attempt was made to set the local TCP port of the local node to Active Open.
#0053	Communications error with destination node/No destination node.
#0066	Internal memory cannot be obtained; cannot execute.
#0080	Receive request timed out.
#0081	Closed during open processing. The specified socket was closed during send processing. The specified socket was closed during receive processing.
#FFFF	Processing was skipped for some reason.



Additional Information

For details, refer to 6-7-6 *Response Codes* in *Section 6 Socket Services* of the *CJ-series Ethernet Units Operation Manual Construction of Applications* (Cat.No. W421).



Additional Information

For details, refer to *8-4 Troubleshooting Procedures* in *Section 8 Troubleshooting of the CJ-series Ethernet Units Operation Manual Construction of Networks* (Cat.No. W421).

- Timeout error/TCP connection status error

H400 contains a timeout error code/TCP connection status error code for the open processing, H401 contains a timeout error code/TCP connection status error code for send processing, H402 contains a timeout error code/TCP connection status error code for the receive processing, and H404 contains a timeout error code/TCP connection status error code for the close processing/TCP connection status error code.

Error code	Description
#0000	Normal end
#F101	The open processing could not be completed within the time limit.
#F201	The send processing could not be completed within the time limit. (Including the case the arrival of the expected response cannot be confirmed)
#F301	The receive processing could not be completed within the time limit.
#F401	The close processing could not be completed within the time limit.
#F402	After the close processing, the TCP connection status could not return to the normal state within the time limit.

●Destination device error code

H403 contains a destination device error code that is detected during the receive processing.

Error code	Description
#0000	Normal end
[Destination device error code]	Refer to the <i>Destination device error code list</i> shown below.
#FFFF	There is no response from the destination device for some reason and whether there is a destination device error is not detected.

[Destination device error code list]

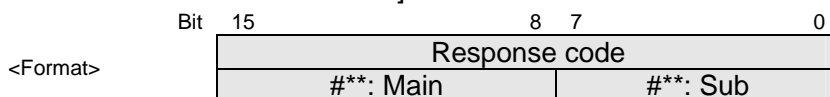

Category	Response Code		Response Name	Description	
	Main	Sub			
Normal end	00	00	Normal end	The received command ended normally with no error.	
Command error	10	00	Parity error	A parity error has occurred in one of the characters of the command frame (For only RS-232C).	
	11	00	Framing error	A framing error has occurred in one of the characters of the command frame (For only RS-232C).	
	12	00	Overrun error	An overrun error has occurred in one of the characters of the command frame (For only RS-232C).	
	13	00	FCS error	The command frame has an incorrect FCS (For only RS-232C).	
	14	0X <small>(See Note 1)</small>		Command code error	Incorrect command has been received. The response code is ICMD.
		1X <small>(See Note 1)</small>		Command parameter error	Command parameter is incorrect.
		2X <small>(See Note 1)</small>		Command option error	Command option is incorrect.
	15	00		Process error	Specified command can not be executed. Ex. Caused by executing a communication command when the last command is being executed. Ex. Caused by incorrect setting of filtering condition.
		0X <small>(See Note 1)</small>		Filter error	Specified filter settings is incorrect. Ex. Caused by incorrect setting of filtering condition.
	18	00	Frame length error	A command received from the host exceeds the receive buffer (512 Bytes).	
RF Tag communication error	70	00	LBT busy error	Channel none by can LBT use. (The electric wave cannot be sent.)	
		1X <small>(See Note 1)</small>	Communication error	During the transaction after tag detection, communication error or process time out has occurred, and consequently the transaction can not be completed normally. Specified password does not match to the one of the target tag.	
		2X <small>(See Note 1)</small>	Communication error	During the transaction after tag detection, communication error or process time out has occurred, and consequently the transaction can not be completed normally .* In the case of ID write/Data write, a part of data in the tag may have been written.	
	71	00	Verification error	The reader has not written the data to the tag by reason of verification error.	
	7A	00	Address specification error	Specifying Bank/Address in the tag memory is incorrect and command can not be executed.	
	7B	00	Data write error	During the data write into the detected tag, sufficient power is not supplied to the tag.	
	7C	1X <small>(See Note 1)</small>	Antenna detection error	At the R/W starts up, an appropriate antenna has not been connected to the specified antenna port.	
		2X <small>(See Note 1)</small>	Antenna error	Error occurred with the antenna connected to the specified antenna port (even though the antenna is detected normally when start up).	
	7E	00	Lock error	When data write or read command is sent for the locked area. It depends on the tag's chip specifications. (For Monza chip, when these commands are sent for Lock Bit of User Memory because this area does not exist.) <small>(See Note 2)</small>	
	7F	0X <small>(See Note 1)</small>	Tag error	The tag has been rejected the command process.	
System error	9A	XX <small>(See Note 1)</small>	System error	An error that blocks command execution has been detected in the hardware (such as malfunction of inner circuit or temporary execution error caused by noise).	

Note1: 'x' character in response code means one character in the list of 0 to 9 or A to F.

Note2: Depends on the specification of IC chip equipped in the RF tag. (It occurs at Monza chip when it specified the lock bit which does not exist in its memory map.



Additional Information

For details and troubleshooting the destination device errors, refer to *Section 7 Troubleshooting Alarms and Errors* in the *V750-series UHF RFID System User's Manual* (Cat. No. Z235).

9.7.2. TCP Connection Status Error and Corrective Action

This section explains the situation in which the TCP connection status error occurs and its corrective actions.

- Affects of the TCP connection status error

After a TCP connection status error occurs, if this program is executed again without any corrective action or without notifying the error, then the destination device may not be passively opened (hereinafter referred to as an open processing error). This may be affected by the TCP connection status error that occurred when the previous communication processing ended. The error status can be determined based on the following error code storage areas.

[Error code storage area]

Address: Code that is stored	Error code: Error description
[H400]: Code indicating the end status of the open processing	#004A: The destination device is not passively opened.
[H404]: Code indicating the end status of the close processing	#F402: TCP connection status error

- Situation in which the TCP connection status error occurs

Both a TCP connection status error after the close processing and an open processing error that occurs when the next communications processing is performed can be caused by the fact that the close processing is not completed at the destination device. Although, all processing (until the close processing) of this program ended in the PLC, the close processing completion notification is not received from the destination device (It is not confirmed that the close processing is completed at the destination device).

- Corrective action

The close processing may not be completed at the destination device. Check if the communications port of the destination device is closed. If not closed or not possible to check, reset the communications port of the destination device. The communications port of the destination device can be reset by executing restart operation from the software or by cycling the power supply. For details, refer to the manual for each destination device.



Precautions for Correct Use

Make sure the destination device is disconnected from other device before resetting the communications port of the destination device.

- State of the PLC at a TCP connection status error

When a TCP connection status error occurs, the processing of this program is completed. However, the resend/time monitoring function of the PLC (TCP/IP function), which is described in 9.3.2. Time Monitoring Function, may be operating. This resend processing stops in the following cases. Therefore, you do not have to stop it.

- When the open processing request is made again by restarting the program
- When a communications problem such as cable disconnection is cleared during resend processing
- When the resend processing is completed with the TCP/IP time monitoring (timeout) function
- When the Ethernet Unit is restarted or the power supply to the PLC is turned OFF

10. Revision History

Revision code	Date of revision	Revision reason and revision page
01	2013/04/15	First edition

OMRON Corporation Industrial Automation Company

Tokyo, JAPAN

Contact: www.ia.omron.com

Regional Headquarters

OMRON EUROPE B.V.

Wegalaan 67-69-2132 JD Hoofddorp
The Netherlands

Tel: (31)2356-81-300/Fax: (31)2356-81-388

OMRON ELECTRONICS LLC

One Commerce Drive Schaumburg,
IL 60173-5302 U.S.A.

Tel: (1) 847-843-7900/Fax: (1) 847-843-7787

OMRON ASIA PACIFIC PTE. LTD.

No. 438A Alexandra Road # 05-05/08 (Lobby 2),
Alexandra Technopark,
Singapore 119967

Tel: (65) 6835-3011/Fax: (65) 6835-2711

OMRON (CHINA) CO., LTD.

Room 2211, Bank of China Tower,
200 Yin Cheng Zhong Road,
PuDong New Area, Shanghai, 200120, China

Tel: (86) 21-5037-2222/Fax: (86) 21-5037-2200

Authorized Distributor:

© OMRON Corporation 2013 All Rights Reserved.
In the interest of product improvement,
specifications are subject to change without notice.

Cat. No. P541-E1-01

0911(-)