

# Conductive Level Controller 61F-D21T-V1

CSM\_61F-D21T-V1\_DS\_E\_1\_3

## Ideal for level control for industrial facilities and equipment.

- Outputs can be set to self-hold at ON or OFF using self-holding circuits.
- Sensitivity adjustment of operating resistance from 10 to 100 k $\Omega$  for application to a wide range of liquids.
- Delay timer to prevent relay contact chattering caused by waves.
- Models with a wide AC power supply range (100 to 240 VAC) and 24 VAC/DC reduce the number of level controller models kept in stock.
- CE marking, cUL recognized.
- Easy wiring with ferrules  
2  $\times$  2.5 mm<sup>2</sup> solid or 2  $\times$  1.5 mm<sup>2</sup> standard ferrules.

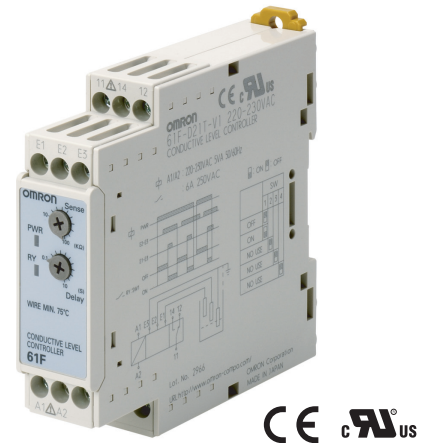

## Model Number Structure

### ■ Model Number Legend

61F-□□  
1 2 3

#### 1. Basic Model

61F: Conductive Level Controller

#### 2. Functions

D21T-V1: Automatic liquid supply operation/  
Automatic liquid drainage operation

#### 3. Supply Voltage

24 VAC/DC: 24 VAC/DC  
100-240 VAC: 100 to 240 VAC

## Ordering Information

### ■ List of Models

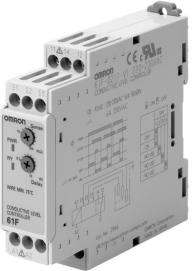
Conductive Level Controller	Supply voltage	Model
	24 VAC/DC	<b>61F-D21T-V1 24 VAC/DC</b>
	100 to 240 VAC	<b>61F-D21T-V1 100 to 240 VAC</b>

## Specifications

<b>Rated voltage</b>	24 VAC, 50/60 Hz, or 24 VDC 100 to 240 VAC, 50/60 Hz
<b>Operating voltage range</b>	85% to 110% of rated voltage
<b>Voltage between electrodes</b>	6 V p-p (approx. 20 Hz)
<b>Power consumption</b>	24 VDC: 2 W max. 24 VAC: 4 VA max. 100 to 240 VAC: 5 VA max.
<b>Operating resistance</b>	10 k $\Omega$ to 100 k $\Omega$ (variable)
<b>Reset resistance</b>	250 k $\Omega$ max.
<b>Response time</b>	Approx. 0.1 to 10 s (variable)
<b>Cable length</b>	100 m max. with completely insulated (600 V) cable with 3 conductors (0.75 mm <sup>2</sup> )
<b>Control output</b>	6 A at 250 VAC for resistive load at 20°C, 1 A at 250 VAC for inductive load $\cos\phi = 0.4$ at 20°C
<b>Indicators</b>	Green LED: Power, Yellow LED: Control output
<b>Ambient temperature</b>	Operating: -20 to 60°C, Storage: -30 to 70°C (with no condensation or icing)
<b>Ambient humidity</b>	Operating: 25% to 85%, Storage: 25% to 85%
<b>Elevation</b>	2,000 m max.
<b>Insulation resistance</b>	100 M $\Omega$ min. (at 500 VDC) between power supply section, electrode section, and contact section
<b>Dielectric strength</b>	2,000 VAC 50/60 Hz for 1 min between power source section, electrode section, and contact section
<b>Vibration resistance</b>	Vibration of 10 to 55 Hz and acceleration of 50 m/s <sup>2</sup> for 5 min. 10 times each in X, Y, and Z directions
<b>Shock resistance</b>	100 m/s <sup>2</sup> 3 times each in 6 directions on 3 axes
<b>Installation environment</b>	Overvoltage Category II, Pollution Degree 2
<b>Safety standards</b>	EN61010-1
<b>EMC</b>	EN61326 Industrial applications

# Connections

## ■ Operation Diagram

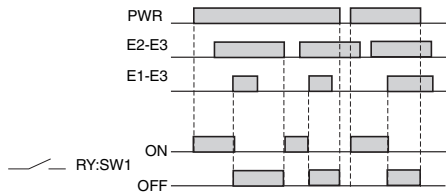

## ■ Wiring Diagram

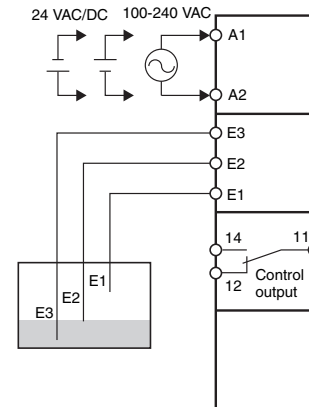

### 1. Water Supply (RY-SW1 ON)

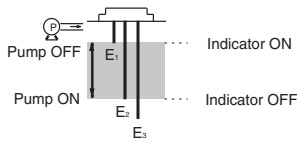

- Connect electromagnetic switch coil terminal A to terminal 2.
- The pump stops when the water level reaches E1 (indicator ON) and starts when the water level drops below E2 (indicator OFF).

### 2. Drainage (RY-SW1 OFF)

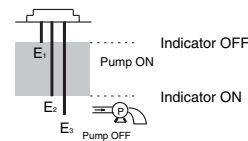

- Connect the electromagnetic switch coil terminal A to terminal 3.
- The pump starts when the water level reaches E1 (indicator OFF) and stops when the water level drops below E2 (indicator ON).

## ■ Accessories

### Electrode Holders

Applications	General applications such as water supply lines	Applications where only a small space is available	Liquid with low specific resistance	Applications where high mounting strength is required	Applications where high temperature/high pressure conditions are severe	Applications where high corrosion resistance is required	Applications where distance to the water surface is long
Models	PS-3S/-4S/-5S (Two-wire models are also available.)	PS-31	BF-1	BF-3/-4/-5	BS-1	BS-1T	PH-1/-2
Appearance							

### Electrodes

Sets of Electrodes, connecting nuts, lock nuts, and spring washers are available. When ordering individual parts, refer to page 6.



Applications	Purified city water, industrial water, sewage	Purified city water, industrial water, sewage, dilute alkaline solution	Sodium hydroxide, acetic acid, dilute sulfuric acid, dilute hydrochloric acid	Sea water, ammonia water, nitric acid	Acetic acid, dilute sulfuric acid, sea water
Models	F03-60-SUS304	F03-60-SUS316	F03-60 HAS B	F03-60 HAS C	F03-60 Titanium

### Others

Item	Model
Protective Cover (for PS or BF electrode holders)	F03-11
Spring Clamp (for PS electrode holders)	F03-12
Electrode Separators (for preventing long electrodes from contacting with each other)	F03-14 1P (for 1 pole) F03-14 3P (for 3 poles) F03-14 5P (for 5 poles)

# Nomenclature

## ■ Front

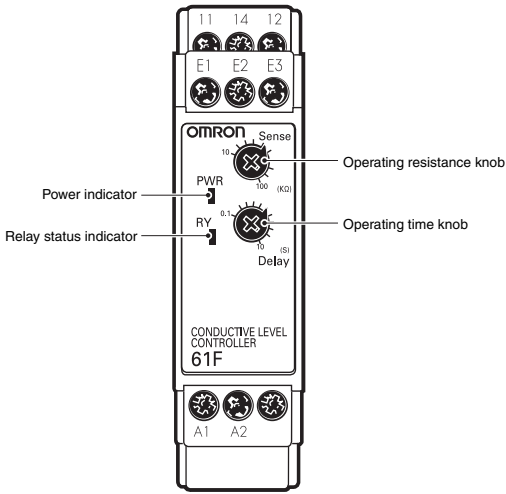

## ■ DIP Switch Settings

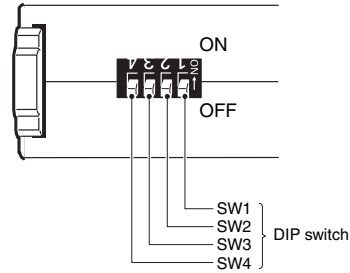

: ON     : OFF

	SW			
	1	2	3	4
OFF	<input type="checkbox"/>			
ON	<input type="checkbox"/>			
NOT USED		<input type="checkbox"/>		
NOT USED			<input type="checkbox"/>	
NOT USED				<input type="checkbox"/>

## Indicators

Item	Meaning
Power indicator (PWR: Green)	Lit when power is being supplied.
Relay status indicator (RY: Yellow)	Lit when relay is operating.

## Setting Knobs

Item	Usage
Operating resistance knob	Used to set the operating resistance to 10 to 100 kΩ.
Operating time knob	Use to set the operating time to 0.1 to 10 s.

## DIP Switch Functions

SWITCH		ON ● ↑			
		4	3	2	1
	OFF ○ ↓	<input type="checkbox"/>	<input type="checkbox"/>	<input type="checkbox"/>	<input type="checkbox"/>
Supply/drainage selection	Automatic liquid drainage operation	Not used.	Not used.	Not used.	●
	Automatic liquid supply operation				○

**Note:** All pins are set to OFF at the factory.

# Dimensions

61F-D21T-V1

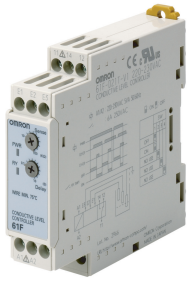

Unit: mm

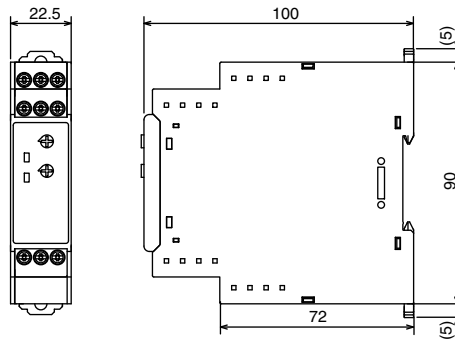

\*Installation Procedure: Mount to the DIN Rail or with front screws  
 \*Dimensions for Mounting with Front Screws

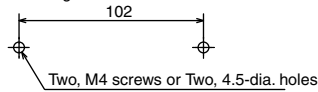

**Note:** When mounting with front screws, draw out the hooks on the bottom of the product on the left and right sides.

## Installation Procedure

- Pull down the hook, fasten the upper tab onto the Rail, and then press the Controller onto the Rail until the hook locks into place.

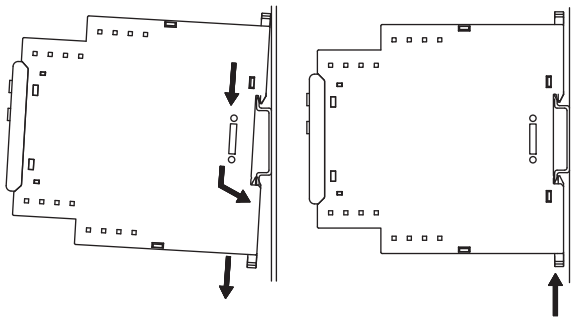

## DIN Rail

Attach the 61F-D21T-V1 to a DIN Rail.

- DIN Rails: PFP-100N (1,000 mm)  
PFP-50N (500 mm)

## Separator

- F03-14

## Recommended Crimp Terminals

Recommended crimp terminal	Recommended cable diameter
Al 1,5-8BK (Phoenix Contact)	AWG16
Al 1-8RD (Phoenix Contact)	AWG18
Al 0,75-8GY (Phoenix Contact)	AWG18

## Uninstallation Procedure

- Using a flat-blade screwdriver or a similar tool, pull down the hook and lift the Controller from the bottom.

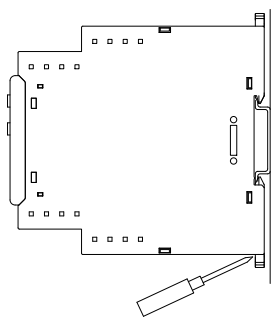

## ■ Electrode Holder and Electrodes

### How to Mount Electrodes

#### Connecting Electrodes to Electrode Holders

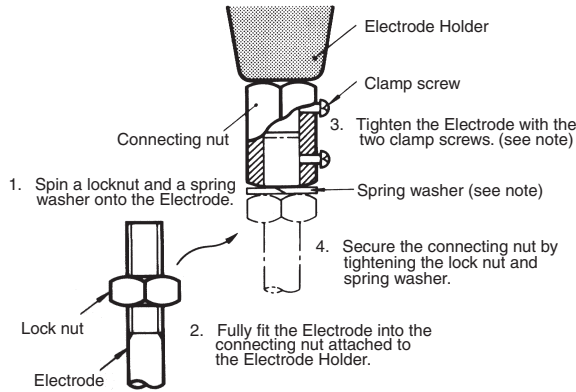

**Note:** Clamp screw and spring washer are not provided for the BS-1T Electrode Holder (titanium, HAS B, or HAS C).

#### Connecting One Electrode to Another

When a long Electrode is required, use two or more Electrodes by joining them with a connecting nut and two lock nuts at intervals of 1 m.

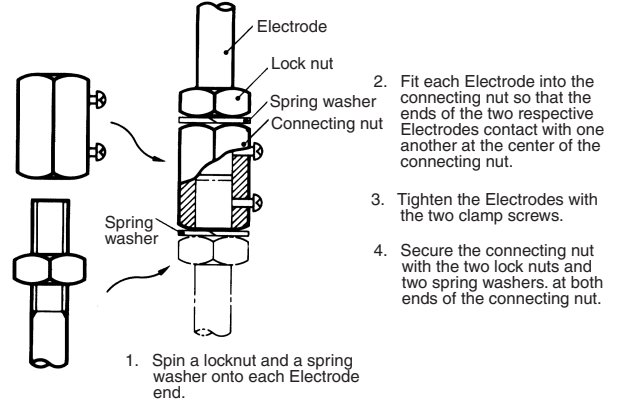

## ■ PH-1/PH-2 Electrodes

PH-1  
(See notes 1 and 2)

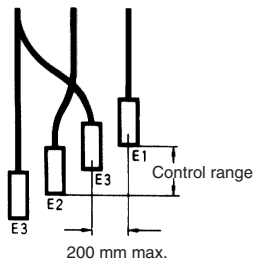

PH-2

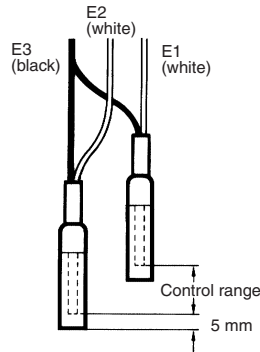

**Note:** 1. When the distance between E1 and E3 exceeds 1 m for supplying purified city water, for example, locate a second E3 within 200 mm of E1.  
2. Even when the distance is less than 1 m, the product may not operate due to the water quality.

# Safety Precautions

## Definition of Precaution Information



Indicates a potentially hazardous situation which, if not avoided, may result in minor or moderate injury or in property damage.

## Precautionary Information



Do not touch the terminals while power is being supplied.  
Doing so may possibly result in electric shock.

## ■ Precautions for Safe Use

- Do not disassemble, repair, or modify the product.
- When attaching the product to the DIN rail, attach it firmly with screws.
- When attaching the product to the DIN rail, ensure that the product has been attached firmly.
- If the thickness of a mounting panel is not adequate, or a mistake has been made during installation, the product may become disconnected.
- Ensure that terminal screws have been tightened firmly.  
Recommended torque: 0.49 N·m  
Assured torque: 0.59 N·m
- When using the product, ensure that the wiring is correct before turning on the power.
- Use a power-supply voltage that is within the range of specifications.
- Use the control source and power supply or power lines that provide inputs with appropriate specifications.
- Do not install near heat-generating devices (coils, or devices that use coils).
- Be sure to confirm terminal numbers for correct wiring.
- Ensure that wiring is correct. Double-check materials such as connection charts and circuit diagrams.
- Properly ground the grounding terminal. Ensure that the common electrode terminal has been properly grounded. Doing so can alleviate effects from noise.
- If electrodes make contact with liquid, purchase and use a separator to prevent such contact.
- Keep appropriate distance from devices that generate high-frequency noise (e.g., high-frequency welders, electronic sewing machines).
- Do not turn a setting volume beyond the scope of movement.
- Do not connect anything to unused terminals.
- Use SELV power supply with over load protection function for DC power supply. The insulation of SELV power supply must be a double or reinforced between input and output. The output voltage shall be 30 V r.m.s. and 42.4 V at peak, or use the power supply of 60 V DC max. Recommended power supply: type S8VS-06024□ (OMRON made)

## Do not keep, install, or use this product in the following environments.

- Outdoors, or places subject to direct sunlight or wearing weather.
- Places where temperature and humidity exceed the allowable range of the product specifications.
- Places where there are extreme changes in temperature and humidity, or icing or condensation may occur.
- Places subject to static electricity or inductive noise.
- Places subject to electrical fields.
- Places where vibrations or physical shocks are strong.
- Places where flammable gasses or flammable liquids exist.
- Places where corrosive gases (in particular, sulfuric or ammonia gas) exist.
- Places with large amounts of dust or iron powders.
- Places where water or oil come in contact with the product.
- Places subject to salt-water splashes.

## ■ Precautions for Correct Use

### For Proper Use

1. Make sure to use setting values appropriate for the controlled object. Failure to do so can cause unintended operation, and may result in accident or corruption of the product.
2. When discarding, properly dispose of the product as industrial waste.
3. Only use this product within a board whose structure allows no possibility for fire to escape.
4. To avoid damage to the exterior of the product, do not use organic solvents (thinner, benzene) or agents with strong alkalinity or acidity.

### About Installation

1. When wiring, use only recommended crimp terminals.
2. Do not block areas around the product for proper dissipation of heat. (If you do not secure space for heat dissipation, life cycle of the product will be compromised.)

### Noise Countermeasures

1. Do not install the product near devices generating strong high frequency waves or surges.
2. When using a noise filter, check the voltage and current and install it as close to the product as possible.
3. In order to prevent inductive noise, wire the lines connected to the product separately from power lines carrying high voltages or currents. Do not wire in parallel with or on the same cable as power lines. Other measures for reducing noise include running lines along separate ducts and using shield lines.

## To avoid faulty operations, malfunctions, or failure, observe the following operating instructions.

1. During insulation resistance measurements, never apply the megohmmeter across the electrode terminals.
2. Use a power supply that will reach rated voltage within 1 second.

ALL DIMENSIONS SHOWN ARE IN MILLIMETERS.

To convert millimeters into inches, multiply by 0.03937. To convert grams into ounces, multiply by 0.03527.

In the interest of product improvement, specifications are subject to change without notice.

## Terms and Conditions Agreement

### Read and understand this catalog.

Please read and understand this catalog before purchasing the products. Please consult your OMRON representative if you have any questions or comments.

### Warranties.

(a) Exclusive Warranty. Omron's exclusive warranty is that the Products will be free from defects in materials and workmanship for a period of twelve months from the date of sale by Omron (or such other period expressed in writing by Omron). Omron disclaims all other warranties, express or implied.

(b) Limitations. OMRON MAKES NO WARRANTY OR REPRESENTATION, EXPRESS OR IMPLIED, ABOUT NON-INFRINGEMENT, MERCHANTABILITY OR FITNESS FOR A PARTICULAR PURPOSE OF THE PRODUCTS. BUYER ACKNOWLEDGES THAT IT ALONE HAS DETERMINED THAT THE PRODUCTS WILL SUITABLY MEET THE REQUIREMENTS OF THEIR INTENDED USE.

Omron further disclaims all warranties and responsibility of any type for claims or expenses based on infringement by the Products or otherwise of any intellectual property right. (c) Buyer Remedy. Omron's sole obligation hereunder shall be, at Omron's election, to (i) replace (in the form originally shipped with Buyer responsible for labor charges for removal or replacement thereof) the non-complying Product, (ii) repair the non-complying Product, or (iii) repay or credit Buyer an amount equal to the purchase price of the non-complying Product; provided that in no event shall Omron be responsible for warranty, repair, indemnity or any other claims or expenses regarding the Products unless Omron's analysis confirms that the Products were properly handled, stored, installed and maintained and not subject to contamination, abuse, misuse or inappropriate modification. Return of any Products by Buyer must be approved in writing by Omron before shipment. Omron Companies shall not be liable for the suitability or unsuitability or the results from the use of Products in combination with any electrical or electronic components, circuits, system assemblies or any other materials or substances or environments. Any advice, recommendations or information given orally or in writing, are not to be construed as an amendment or addition to the above warranty.

See <http://www.omron.com/global/> or contact your Omron representative for published information.

### Limitation on Liability; Etc.

OMRON COMPANIES SHALL NOT BE LIABLE FOR SPECIAL, INDIRECT, INCIDENTAL, OR CONSEQUENTIAL DAMAGES, LOSS OF PROFITS OR PRODUCTION OR COMMERCIAL LOSS IN ANY WAY CONNECTED WITH THE PRODUCTS, WHETHER SUCH CLAIM IS BASED IN CONTRACT, WARRANTY, NEGLIGENCE OR STRICT LIABILITY.

Further, in no event shall liability of Omron Companies exceed the individual price of the Product on which liability is asserted.

### Suitability of Use.

Omron Companies shall not be responsible for conformity with any standards, codes or regulations which apply to the combination of the Product in the Buyer's application or use of the Product. At Buyer's request, Omron will provide applicable third party certification documents identifying ratings and limitations of use which apply to the Product. This information by itself is not sufficient for a complete determination of the suitability of the Product in combination with the end product, machine, system, or other application or use. Buyer shall be solely responsible for determining appropriateness of the particular Product with respect to Buyer's application, product or system. Buyer shall take application responsibility in all cases.

NEVER USE THE PRODUCT FOR AN APPLICATION INVOLVING SERIOUS RISK TO LIFE OR PROPERTY OR IN LARGE QUANTITIES WITHOUT ENSURING THAT THE SYSTEM AS A WHOLE HAS BEEN DESIGNED TO ADDRESS THE RISKS, AND THAT THE OMRON PRODUCT(S) IS PROPERLY RATED AND INSTALLED FOR THE INTENDED USE WITHIN THE OVERALL EQUIPMENT OR SYSTEM.

### Programmable Products.

Omron Companies shall not be responsible for the user's programming of a programmable Product, or any consequence thereof.

### Performance Data.

Data presented in Omron Company websites, catalogs and other materials is provided as a guide for the user in determining suitability and does not constitute a warranty. It may represent the result of Omron's test conditions, and the user must correlate it to actual application requirements. Actual performance is subject to the Omron's Warranty and Limitations of Liability.

### Change in Specifications.

Product specifications and accessories may be changed at any time based on improvements and other reasons. It is our practice to change part numbers when published ratings or features are changed, or when significant construction changes are made. However, some specifications of the Product may be changed without any notice. When in doubt, special part numbers may be assigned to fix or establish key specifications for your application. Please consult with your Omron's representative at any time to confirm actual specifications of purchased Product.

### Errors and Omissions.

Information presented by Omron Companies has been checked and is believed to be accurate; however, no responsibility is assumed for clerical, typographical or proofreading errors or omissions.