

Cat. No. I542-E1-02
0675373-0

OMRON

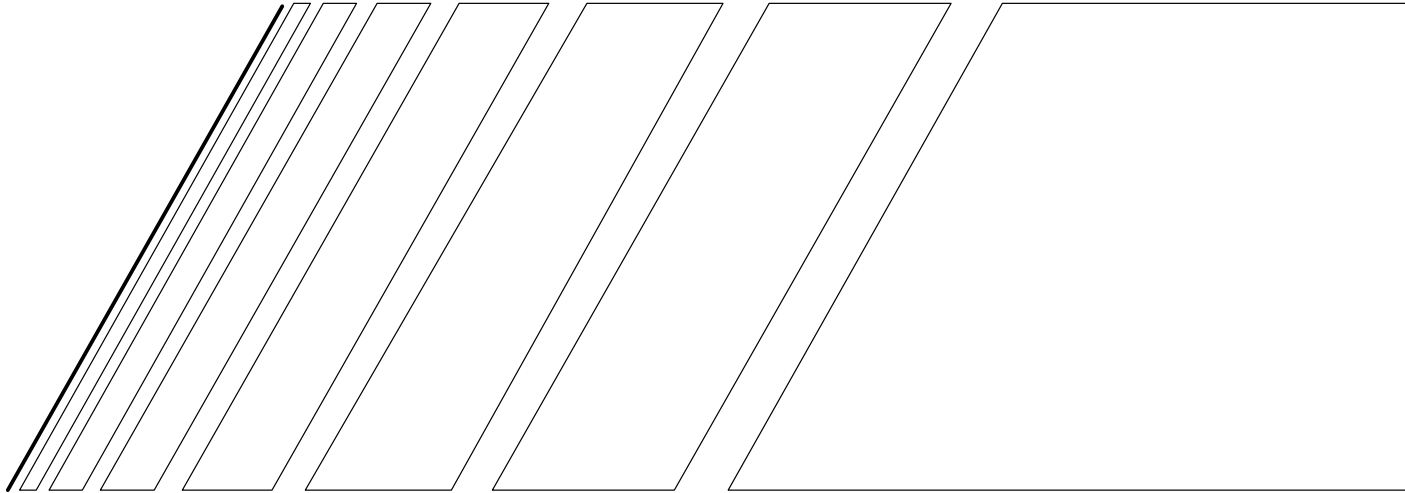

SETUP MANUAL

SYSDRIVE 3G3MV

Multi-function Compact Inverter

Thank you for choosing this SYSDRIVE 3G3MV-series product. Proper use and handling of the product will ensure proper product performance, will lengthen product life, and may prevent possible accidents.

Please read this manual thoroughly and handle and operate the product with care.

1. To ensure safe and proper use of the OMRON Inverters, please read this SETUP MANUAL and the USER'S MANUAL (Cat. No. I527-E1) to gain sufficient knowledge of the devices, safety information, and precautions before actual use.
2. The products are illustrated without covers and shieldings for closer look in this SETUP MANUAL and the USER'S MANUAL. For actual use of the products, make sure to use the covers and shieldings as specified.
3. This SETUP MANUAL and other related user's manuals are to be delivered to the actual end users of the products.
4. Please keep this manual close at hand for future reference.
5. If the product has been left unused for a long time, please inquire at our sales representative.

NOTICE

1. This manual describes the functions of the product and relations with other products. You should assume that anything not described in this manual is not possible.
2. Although care has been given in documenting the product, please contact your OMRON representative if you have any suggestions on improving this manual.
3. The product contains potentially dangerous parts under the cover. Do not attempt to open the cover under any circumstances. Doing so may result in injury or death and may damage the product. Never attempt to repair or disassemble the product.
4. We recommend that you add the following precautions to any instruction manuals you prepare for the system into which the product is being installed.
 - Precautions on the dangers of high-voltage equipment.
 - Precautions on touching the terminals of the product even after power has been turned off. (These terminals are live even with the power turned off.)
5. Specifications and functions may be changed without notice in order to improve product performance.

Items to Check Before Unpacking

Check the following items before removing the product from the package:

- Has the correct product been delivered (i.e., the correct model number and specifications)?
- Has the product been damaged in shipping?
- Are any screws or bolts loose?

Notice:

OMRON products are manufactured for use according to proper procedures by a qualified operator and only for the purposes described in this manual.

The following conventions are used to indicate and classify precautions in this manual. Always heed the information provided with them. Failure to heed precautions can result in injury to people or damage to property.

 **DANGER** Indicates an imminently hazardous situation which, if not avoided, will result in death or serious injury. Additionally, there may be severe property damage.

 **WARNING** Indicates a potentially hazardous situation which, if not avoided, could result in death or serious injury. Additionally, there may be severe property damage.

 **Caution** Indicates a potentially hazardous situation which, if not avoided, may result in minor or moderate injury, or property damage.

OMRON Product References

All OMRON products are capitalized in this manual. The word “Unit” is also capitalized when it refers to an OMRON product, regardless of whether or not it appears in the proper name of the product.

The abbreviation “Ch,” which appears in some displays and on some OMRON products, often means “word” and is abbreviated “Wd” in documentation in this sense.

The abbreviation “PC” means Programmable Controller and is not used as an abbreviation for anything else.

Visual Aids

The following headings appear in the left column of the manual to help you locate different types of information.

Note Indicates information of particular interest for efficient and convenient operation of the product.

© OMRON, 2004

All rights reserved. No part of this publication may be reproduced, stored in a retrieval system, or transmitted, in any form, or by any means, mechanical, electronic, photocopying, recording, or otherwise, without the prior written permission of OMRON.









No patent liability is assumed with respect to the use of the information contained herein. Moreover, because OMRON is constantly striving to improve its high-quality products, the information contained in this manual is subject to change without notice. Every precaution has been taken in the preparation of this manual. Nevertheless, OMRON assumes no responsibility for errors or omissions. Neither is any liability assumed for damages resulting from the use of the information contained in this publication.

General Precautions



Observe the following precautions when using the SYSDRIVE Inverters and peripheral devices.

This manual may include illustrations of the product with protective covers removed in order to describe the components of the product in detail. Make sure that these protective covers are on the product before use.





Consult your OMRON representative when using the product after a long period of storage.

-  **WARNING** Do not touch the inside of the Inverter. Doing so may result in electrical shock.
-  **WARNING** Operation, maintenance, or inspection must be performed after turning OFF the power supply, confirming that the CHARGE indicator (or status indicators) are OFF, and after waiting for the time specified on the front cover. Not doing so may result in electrical shock.
-  **WARNING** Do not damage, pull on, apply stress to, place heavy objects on, or pinch the cables. Doing so may result in electrical shock.
-  **WARNING** Do not touch the rotating parts of the motor under operation. Doing so may result in injury.
-  **WARNING** Do not modify the product. Doing so may result in injury or damage to the product.
-  **Caution** Do not store, install, or operate the product in the following places. Doing so may result in electrical shock, fire or damage to the product.
 - Locations subject to direct sunlight.
 - Locations subject to temperatures or humidity outside the range specified in the specifications.
 - Locations subject to condensation as the result of severe changes in temperature.
 - Locations subject to corrosive or flammable gases.
 - Locations subject to exposure to combustibles.
 - Locations subject to dust (especially iron dust) or salts.
 - Locations subject to exposure to water, oil, or chemicals.
 - Locations subject to shock or vibration.
-  **Caution** Do not touch the Inverter radiator, regenerative resistor, or Servomotor while the power is being supplied or soon after the power is turned OFF. Doing so may result in a skin burn due to the hot surface.
-  **Caution** Do not conduct a dielectric strength test on any part of the Inverter. Doing so may result in damage to the product or malfunction.
-  **Caution** Take appropriate and sufficient countermeasures when installing systems in the following locations. Not doing so may result in equipment damage.
 - Locations subject to static electricity or other forms of noise.
 - Locations subject to strong electromagnetic fields and magnetic fields.
 - Locations subject to possible exposure to radioactivity.
 - Locations close to power supplies.





Transportation Precautions







-  **Caution** Do not hold by front cover or panel, instead, hold by the radiation fin (heat sink) while transporting the product. Doing so may result in injury.
-  **Caution** Do not pull on the cables. Doing so may result in damage to the product or malfunction.
-  **Caution** Use the eye-bolts only for transporting the Inverter. Using them for transporting the machinery may result in injury or malfunction.

Installation Precautions







-  **WARNING** Provide an appropriate stopping device on the machine side to secure safety. (A holding brake is not a stopping device for securing safety.) Not doing so may result in injury.
-  **WARNING** Provide an external emergency stopping device that allows an instantaneous stop of operation and power interruption. Not doing so may result in injury.
-  **Caution** Be sure to install the product in the correct direction and provide specified clearances between the Inverter and control panel or with other devices. Not doing so may result in fire or malfunction.
-  **Caution** Do not allow foreign objects to enter inside the product. Doing so may result in fire or malfunction.
-  **Caution** Do not apply any strong impact. Doing so may result in damage to the product or malfunction.







Wiring Precautions

-  **WARNING** Wiring must be performed only after confirming that the power supply has been turned OFF. Not doing so may result in electrical shock.
-  **WARNING** Wiring must be performed by authorized personnel. Not doing so may result in electrical shock or fire.
-  **WARNING** Be sure to confirm operation only after wiring the emergency stop circuit. Not doing so may result in injury.
-  **WARNING** Always connect the ground terminals to a ground of 100 Ω or less for the 200-V AC class, or 10 Ω or less for the 400-V AC class. Not connecting to a proper ground may result in electrical shock.







-  **Caution** Install external breakers and take other safety measures against short-circuiting in external wiring. Not doing so may result in fire.
-  **Caution** Confirm that the rated input voltage of the Inverter is the same as the AC power supply voltage. An incorrect power supply may result in fire, injury, or malfunction.
-  **Caution** Connect the Braking Resistor and Braking Resistor Unit as specified in the manual. Not doing so may result in fire.
-  **Caution** Be sure to wire correctly and securely. Not doing so may result in injury or damage to the product.
-  **Caution** Be sure to firmly tighten the screws on the terminal block. Not doing so may result in fire, injury, or damage to the product.
-  **Caution** Do not connect an AC power to the U, V, or W output. Doing so may result in damage to the product or malfunction.
-  **Caution** Set the multi-function contact input parameter for NC contact terminals (e.g., 3-wire sequence) before wiring them. If the parameter's default setting is used, the motor may start running when the input terminal S2 is turned ON.

Operation and Adjustment Precautions

-  **WARNING** Turn ON the input power supply only after mounting the front cover, terminal covers, bottom cover, Operator, and optional items. Not doing so may result in electrical shock.
-  **WARNING** Do not remove the front cover, terminal covers, bottom cover, Operator, or optional items while the power is being supplied. Not doing so may result in electrical shock or damage to the product.
-  **WARNING** Do not operate the Operator or switches with wet hands. Doing so may result in electrical shock.
-  **WARNING** Do not touch the inside of the Inverter. Doing so may result in electrical shock.
-  **WARNING** Do not come close to the machine when using the error retry function because the machine may abruptly start when stopped by an alarm. Doing so may result in injury.
-  **WARNING** Do not come close to the machine immediately after resetting momentary power interruption to avoid an unexpected restart (if operation is set to be continued in the processing selection function after momentary power interruption is reset). Doing so may result in injury.

-  **WARNING** Provide a separate emergency stop switch because the STOP Key on the Operator is valid only when function settings are performed. Not doing so may result in injury.
-  **WARNING** Be sure confirm that the RUN signal is turned OFF before turning ON the power supply, resetting the alarm, or switching the LOCAL/REMOTE selector. Doing so while the RUN signal is turned ON may result in injury.
-  **Caution** Be sure to confirm permissible ranges of motors and machines before operation because the Inverter speed can be easily changed from low to high. Not doing so may result in damage to the product.
-  **Caution** Provide a separate holding brake when necessary. Not doing so may result in injury.
-  **Caution** Do not perform a signal check during operation. Doing so may result in injury or damage to the product.
-  **Caution** Do not carelessly change settings. Doing so may result in injury or damage to the product.

Maintenance and Inspection Precautions

-  **WARNING** Do not touch the Inverter terminals while the power is being supplied.
-  **WARNING** Maintenance or inspection must be performed only after turning OFF the power supply, confirming that the CHARGE indicator (or status indicators) is turned OFF, and after waiting for the time specified on the front cover. Not doing so may result in electrical shock.
-  **WARNING** Maintenance, inspection, or parts replacement must be performed by authorized personnel. Not doing so may result in electrical shock or injury.
-  **WARNING** Do not attempt to take the Unit apart or repair. Doing either of these may result in electrical shock or injury.
-  **Caution** Carefully handle the Inverter because it uses semiconductor elements. Careless handling may result in malfunction.
-  **Caution** Do not change wiring, disconnect connectors, the Operator, or optional items, or replace fans while power is being supplied. Doing so may result in injury, damage to the product, or malfunction.

Warnings for UL/cUL Marking

- Do not connect or disconnect wiring, or perform signal checks while the power supply is turned ON.
- The Inverter internal capacitor is still charged even after the power supply is turned OFF. To prevent electrical shock, disconnect all power before servicing the Inverter. Then wait at least one minute after the power supply is disconnected and all indicators are OFF.
- Do not perform a withstand voltage test on any part of the Inverter. This electronic equipment uses semiconductors and is vulnerable to high voltage.
- Do not remove the Digital Operator or the blank cover unless the power supply is turned OFF. Never touch the printed control board (PCB) while the power supply is turned ON.
- The Inverter is not suitable for use on a circuit capable of delivering more than 5,000 RMS symmetrical amperes, 250 volts maximum (200-V-class Units) or 18,000 RMS symmetrical amperes, 480 V maximum (400-V-class Units).
- Take measures against overcurrent, overload, and overheating by using the Motor Protection Settings.

CAUTION

Use 75°C copper wires or equivalent.
Low voltage wires shall be wired with Class I Wiring.

■ Motor Protection Settings

Rated Motor Current (n036)

- Check the rated current on the motor nameplate and set the parameter.
- This parameter is used for the electronic thermal function for motor overload detection (OL1). By setting the correct parameter, the overloaded motor will be protected from burning.

n036	Rated Motor Current	Register No.	0124 Hex	Changes during operation	No
Setting range	0.0% to 150% (A) of rated output current of Inverter	Unit of setting	0.1 A	Default setting	(see note 1)

Note 1. The standard rated current of the maximum applicable motor is the default rated motor current.

Note 2. Motor overload detection (OL1) is disabled by setting the parameter to 0.0.

Motor Protection Functions (n037 and n038)

- This parameters setting is for motor overload detection (OL1).

n037	Motor Protection Function Selection	Register No.	0125 Hex	Changes during operation	No
Setting range	0 to 2	Unit of setting	1	Default setting	0

● Set Values

Value	Description
0	Protection characteristics for general-purpose induction motors
1	Protection characteristics for Inverter-dedicated motors
2	No protection

- This parameter is used to set the electric thermal characteristics of the motor to be connected.
- Set the parameter according to the motor.
- If a single Inverter is connected to more than one motor, set the parameter to 2 for no protection. The parameter is also disabled by setting n036 for rated motor current to 0.0. Provide thermal relays or other methods separately for each motor to protect equipment from overloads.

n038	Motor Protection Time	Register No.	0126 Hex	Changes during operation	No
Setting range	1 to 60 (min)	Unit of setting	1 min	Default setting	8

● Set Values

- This parameter is used to set the electronic thermal protection constant of motor overload detection OL1.
- The default setting does not need any changes in normal operation.
- To set the parameter according to the characteristics of the motor, confirm the thermal time constant with the motor manufacturer and set the parameter with some margin. In other words, set the value a little shorter than the thermal time constant.
- To detect motor overloading more quickly, reduce the set value, provided that it does not cause any application problems.

Checking Before Unpacking

■ Checking the Product

On delivery, always check that the delivered product is the SYSDRIVE 3G3MV Inverter that you ordered.

Should you find any problems with the product, immediately contact your nearest local sales representative.

● Checking the Nameplate

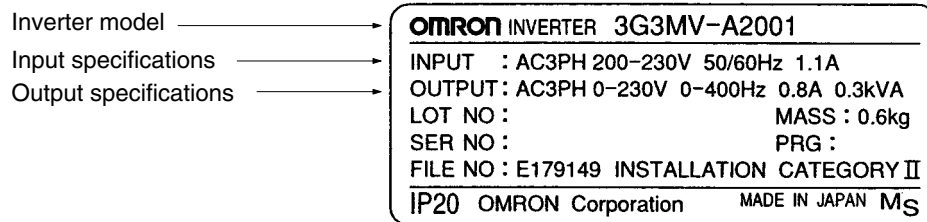

● Checking the Model

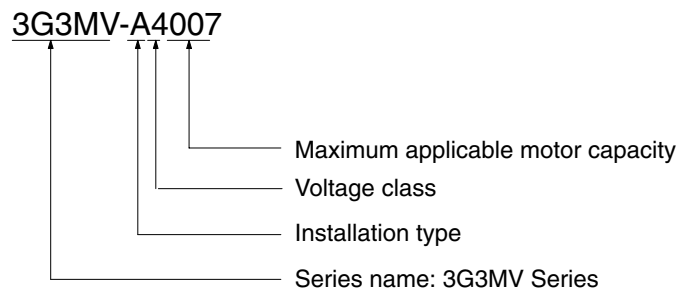

Maximum Applicable Motor Capacity

001	0.1 (0.1) kW
002	0.25/0.37 (0.2) kW
004	0.55 (0.4) kW
007	1.1 (0.75) kW
015	1.5 (1.5) kW
022	2.2 (2.2) kW
037	3.7 (3.7) kW
055	5.5 (5.5) kW
075	7.5 (7.5) kW

Note The figures in parentheses indicate capacities for motors used in Japan.

Voltage Class

2	Three-phase 200-V AC input (200-V class)
B	Single-phase 200-V AC input (200-V class)
4	Three-phase 400-V AC input (400-V class)

Read and Understand this Manual

Please read and understand this manual before using the product. Please consult your OMRON representative if you have any questions or comments.

Warranty and Limitations of Liability

WARRANTY

OMRON's exclusive warranty is that the products are free from defects in materials and workmanship for a period of one year (or other period if specified) from date of sale by OMRON.

OMRON MAKES NO WARRANTY OR REPRESENTATION, EXPRESS OR IMPLIED, REGARDING NON-INFRINGEMENT, MERCHANTABILITY, OR FITNESS FOR PARTICULAR PURPOSE OF THE PRODUCTS. ANY BUYER OR USER ACKNOWLEDGES THAT THE BUYER OR USER ALONE HAS DETERMINED THAT THE PRODUCTS WILL SUITABLY MEET THE REQUIREMENTS OF THEIR INTENDED USE. OMRON DISCLAIMS ALL OTHER WARRANTIES, EXPRESS OR IMPLIED.

LIMITATIONS OF LIABILITY

OMRON SHALL NOT BE RESPONSIBLE FOR SPECIAL, INDIRECT, OR CONSEQUENTIAL DAMAGES, LOSS OF PROFITS OR COMMERCIAL LOSS IN ANY WAY CONNECTED WITH THE PRODUCTS, WHETHER SUCH CLAIM IS BASED ON CONTRACT, WARRANTY, NEGLIGENCE, OR STRICT LIABILITY.

In no event shall the responsibility of OMRON for any act exceed the individual price of the product on which liability is asserted.

IN NO EVENT SHALL OMRON BE RESPONSIBLE FOR WARRANTY, REPAIR, OR OTHER CLAIMS REGARDING THE PRODUCTS UNLESS OMRON'S ANALYSIS CONFIRMS THAT THE PRODUCTS WERE PROPERLY HANDLED, STORED, INSTALLED, AND MAINTAINED AND NOT SUBJECT TO CONTAMINATION, ABUSE, MISUSE, OR INAPPROPRIATE MODIFICATION OR REPAIR.

Application Considerations

SUITABILITY FOR USE

OMRON shall not be responsible for conformity with any standards, codes, or regulations that apply to the combination of products in the customer's application or use of the products.

At the customer's request, OMRON will provide applicable third party certification documents identifying ratings and limitations of use that apply to the products. This information by itself is not sufficient for a complete determination of the suitability of the products in combination with the end product, machine, system, or other application or use.

The following are some examples of applications for which particular attention must be given. This is not intended to be an exhaustive list of all possible uses of the products, nor is it intended to imply that the uses listed may be suitable for the products:

- Outdoor use, uses involving potential chemical contamination or electrical interference, or conditions or uses not described in this manual.
- Nuclear energy control systems, combustion systems, railroad systems, aviation systems, medical equipment, amusement machines, vehicles, safety equipment, and installations subject to separate industry or government regulations.
- Systems, machines, and equipment that could present a risk to life or property.

Please know and observe all prohibitions of use applicable to the products.

NEVER USE THE PRODUCTS FOR AN APPLICATION INVOLVING SERIOUS RISK TO LIFE OR PROPERTY WITHOUT ENSURING THAT THE SYSTEM AS A WHOLE HAS BEEN DESIGNED TO ADDRESS THE RISKS, AND THAT THE OMRON PRODUCTS ARE PROPERLY RATED AND INSTALLED FOR THE INTENDED USE WITHIN THE OVERALL EQUIPMENT OR SYSTEM.

PROGRAMMABLE PRODUCTS

OMRON shall not be responsible for the user's programming of a programmable product, or any consequence thereof.

Disclaimers

CHANGE IN SPECIFICATIONS

Product specifications and accessories may be changed at any time based on improvements and other reasons.

It is our practice to change model numbers when published ratings or features are changed, or when significant construction changes are made. However, some specifications of the products may be changed without any notice. When in doubt, special model numbers may be assigned to fix or establish key specifications for your application on your request. Please consult with your OMRON representative at any time to confirm actual specifications of purchased products.

DIMENSIONS AND WEIGHTS

Dimensions and weights are nominal and are not to be used for manufacturing purposes, even when tolerances are shown.

PERFORMANCE DATA

Performance data given in this manual is provided as a guide for the user in determining suitability and does not constitute a warranty. It may represent the result of OMRON's test conditions, and the users must correlate it to actual application requirements. Actual performance is subject to the OMRON Warranty and Limitations of Liability.

ERRORS AND OMISSIONS

The information in this manual has been carefully checked and is believed to be accurate; however, no responsibility is assumed for clerical, typographical, or proofreading errors, or omissions.

Revision History

A manual revision code appears as a suffix to the catalog number on the front cover of the manual.

Cat. No. I542-E1-02

↑
Revision code

The following table outlines the changes made to the manual during each revision. Page numbers refer to the previous version.

Revision code	Date	Revised content
01	July 2004	Original production
02	November 2005	Following changes made to front matter. Notice: Information on general precautions notation added. Read and Understand this Manual: Information on liability and warranty added. Page 2-3: New section 2-1-2 added. Page 3-2: New setting of "4" added and note added in table. Page 3-11: Numbers fixed for acceleration/deceleration times. Page 3-39: Note added and two references to it added in table.

Table of Contents

Chapter 1. Design 1-1

1-1	Installation	1-2
1-1-1	Dimensions	1-2
1-1-2	Removing and Mounting the Covers	1-7
1-2	Wiring	1-12
1-2-1	Terminal Block	1-12
1-2-2	Standard Connections	1-21
1-2-3	Wiring around the Main Circuit	1-22

Chapter 2. Preparing for Operation and Monitoring 2-1

2-1	Nomenclature	2-2
2-1-1	Names of Parts and their Functions	2-2
2-1-2	Accepting Operation Commands While Changing Parameters	2-4
2-1-3	Outline of Operation	2-5
2-2	Copying and Verifying Parameters	2-8
2-2-1	Parameters Used to Copy and Verify Parameters	2-8
2-2-2	Outline of Copying Parameters	2-10
2-2-3	Procedures	2-11
2-2-4	Error Messages for Copying and Verifying Parameters	2-13

Chapter 3. List of Parameters 3-1

Chapter 4. Maintenance Operations 4-1

4-1	Protective and Diagnostic Functions	4-2
4-1-1	Fault Detection (Fatal Errors)	4-2
4-1-2	Warning Detection (Nonfatal Errors)	4-10

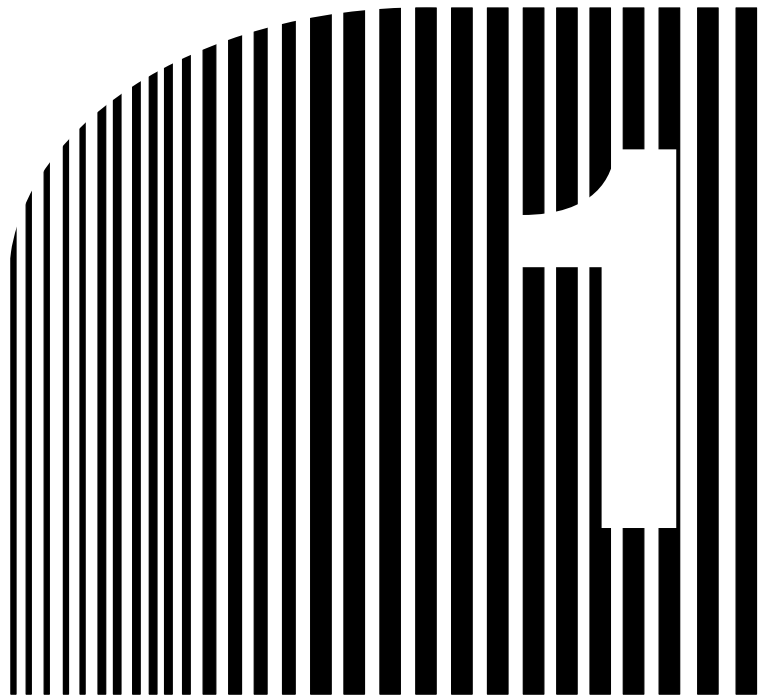

Chapter 1

• Design •

- 1-1 Installation
- 1-2 Wiring

1-1 Installation

1-1-1 Dimensions

- 3G3MV-A2001 to 3G3MV-A2007 (0.1 to 0.75 kW) 3-phase 200-V AC Input
 3G3MV-AB001 to 3G3MV-AB004 (0.1 to 0.4 kW) Single-phase 200-V AC Input

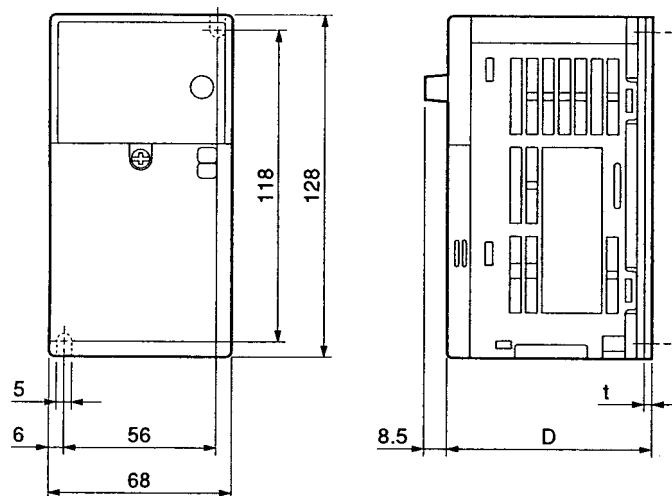

Rated voltage	Model 3G3MV-	Dimensions (mm)		Weight (kg)
		D	t	
3-phase 200 V AC	A2001	76	3	Approx. 0.6
	A2002	76	3	Approx. 0.6
	A2004	108	5	Approx. 0.9
	A2007	128	5	Approx. 1.1
Single-phase 200 V AC	AB001	76	3	Approx. 0.6
	AB002	76	3	Approx. 0.7
	AB004	131	5	Approx. 1.0

- 3G3MV-A2015 to 3G3MV-A2022 (1.5 to 2.2 kW) 3-phase 200-V AC Input
- 3G3MV-AB007 to 3G3MV-AB015 (0.75 to 1.5 kW) Single-phase 200-V AC Input
- 3G3MV-A4002 to 3G3MV-A4022 (0.2 to 2.2 kW) 3-phase 400-V AC Input

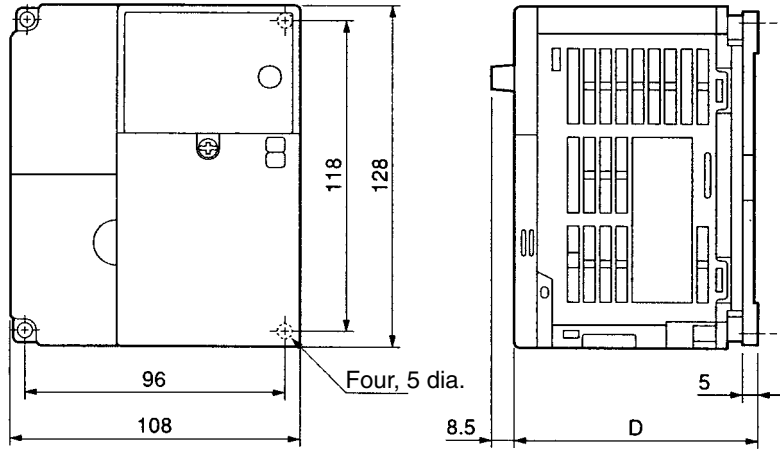

Rated voltage	Model 3G3MV-	Dimensions (mm)	Weight (kg)
		D	
3-phase 200 V AC	A2015	131	Approx. 1.4
	A2022	140	Approx. 1.5
Single-phase 200 V AC	AB007	140	Approx. 1.5
	AB015	156	Approx. 1.5
3-phase 400 V AC	A4002	92	Approx. 1.0
	A4004	110	Approx. 1.1
	A4007	140	Approx. 1.5
	A4015	156	Approx. 1.5
	A4022	156	Approx. 1.5

- 3G3MV-A2037 (3.7 kW) 3-phase 200-V AC Input
- 3G3MV-AB022 (2.2 kW) Single-phase 200-V AC Input
- 3G3MV-A4037 (3.7 kW) 3-phase 400-V AC Input

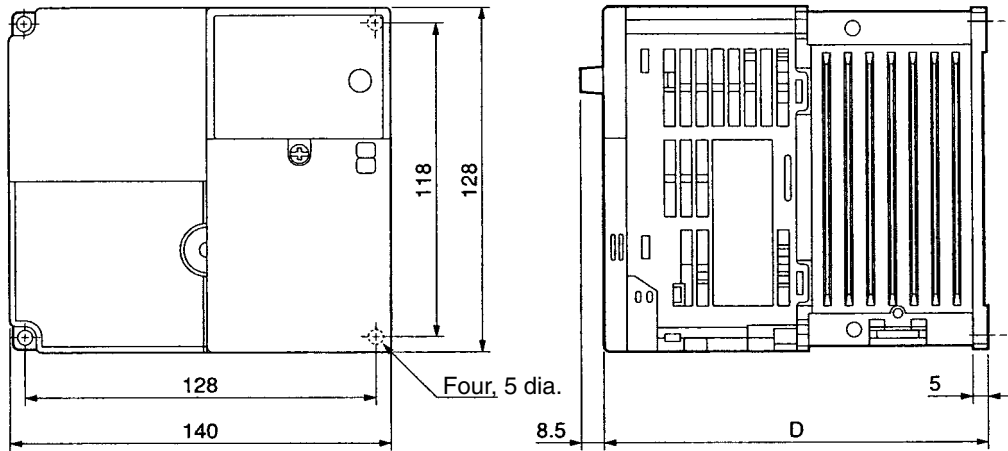

Rated voltage	Model 3G3MV-	Dimensions (mm)	Weight (kg)
		D	
3-phase 200 V AC	A2037	143	Approx. 2.1
Single-phase 200 V AC	AB022	163	Approx. 2.2
3-phase 400 V AC	A4037	143	Approx. 2.1

- 3G3MV-AB037 (3.7 kW) Single-phase 200-V AC Input

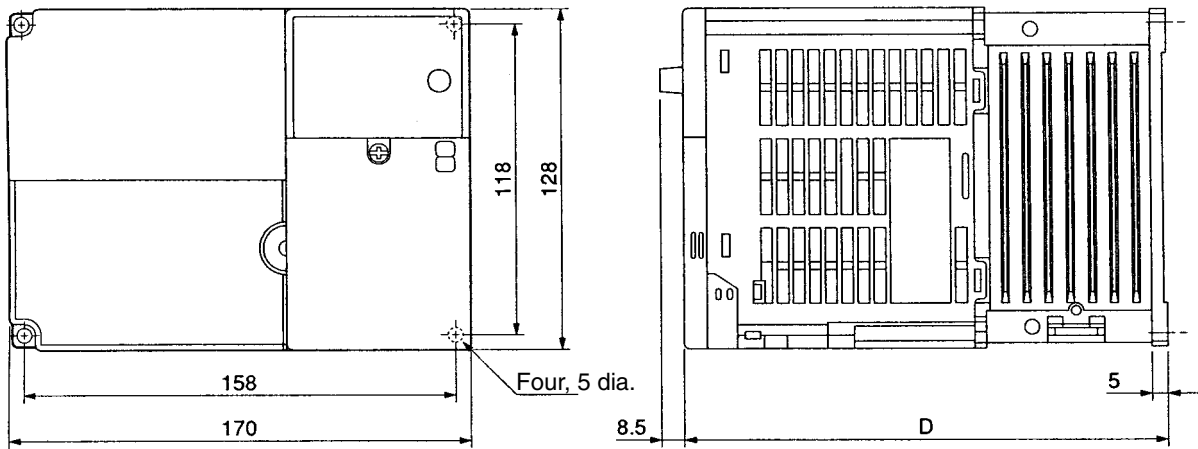

Rated voltage	Model 3G3MV-	Dimensions (mm)	Weight (kg)
		D	
Single-phase 200 V AC	AB037	180	Approx. 2.9

- 3G3MV-A2055 to -A2075 (5.5 to 7.5 kW) 3-phase 200-V AC Input
 3G3MV-A4055 to -A4075 (5.5 kW to 7.5 kW) 3-phase 400-V AC Input

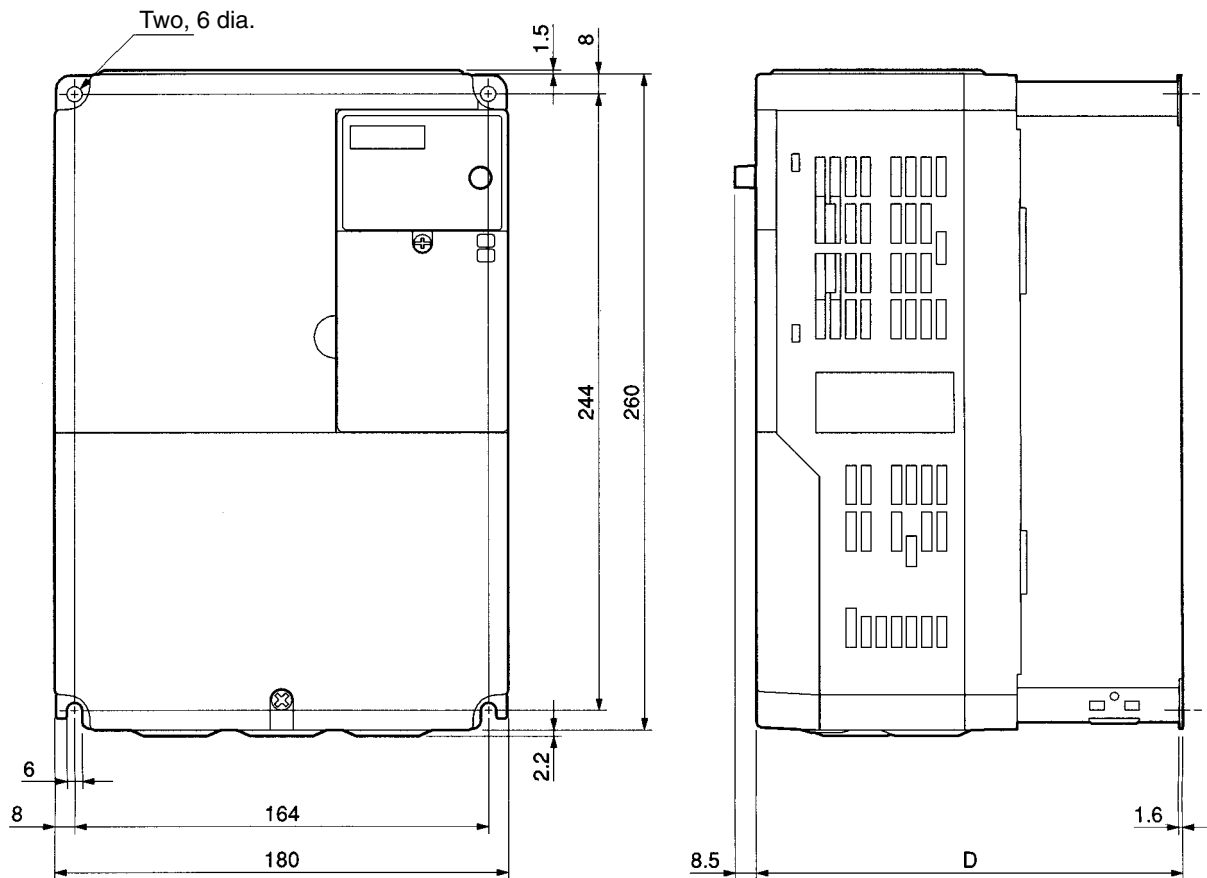

Rated voltage	Model 3G3MV-	Dimensions (mm)	Weight (kg)
		D	
3-phase 200 V AC	A2055	170	Approx. 4.6
3-phase 200 V AC	A2075	170	Approx. 4.8
3-phase 400 V AC	A4055	170	Approx. 4.8
3-phase 400 V AC	A4075	170	Approx. 4.8

■ Installation Direction and Dimensions

- Install the Inverter under the following conditions.

Ambient operating temperature:

Panel-mounting models (conforming to IP20): -10 to 50°C (0.1- to 3.7-kW Inverters)

Closed wall-mounting models (conforming to NEMA1 and IP20):

-10 to 40°C (5.5- to 7.5-kW Inverters)

Humidity: 95% max. (with no condensation)

Note 1. By removing the top and bottom covers from a 5.5- to 7.5-kW Inverter, it can be used as a panel-mounting model (conforming to IP00) within an ambient temperature range of -10 to 50°C.

Note 2. All C-type Inverters (closed wall-mounting models: NEMA1-type for North America) are closed wall-mounting models, and can be used within an ambient temperature range of -10 to 40°C. If the top and bottom covers are removed, the C-type Inverters can be used as panel-mounting models (conforming to IP00) within an ambient temperature range of -10 to 50°C.

- Install the Inverter in a clean location free from oil mist and dust. Alternatively, install it in a totally enclosed panel that is completely protected from floating dust.
- When installing or operating the Inverter, always take special care so that metal powder, oil, water, or other foreign matter does not get into the Inverter.
- Do not install the Inverter on inflammable material such as wood.
- If a 5.5- to 7.5-kW Inverter or a C-type Inverter is to be installed inside of a control panel, it must have the top and bottom covers removed and be used as a panel-mounting model (conforming to IP00).

■ Direction

- Install the Inverter on a vertical surface so that the characters on the nameplate are oriented upward.

■ Dimensions

- When installing the Inverter, always provide the following clearances to allow normal heat dissipation from the Inverter.

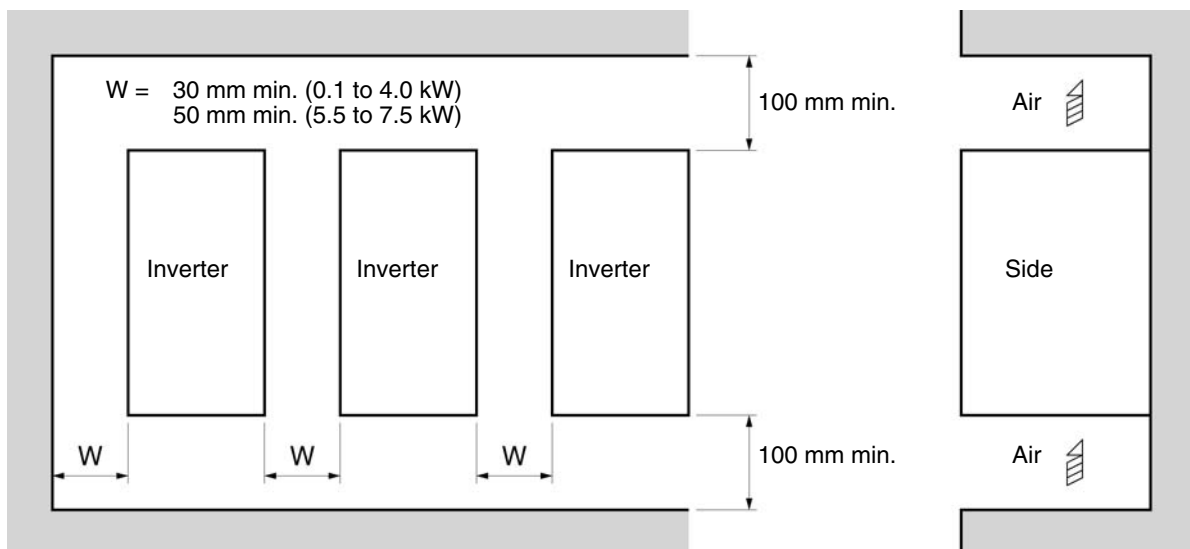

■ Ambient Temperature Control

- To enhance operation reliability, the Inverter should be installed in an environment free from extreme temperature changes.
- If the Inverter is installed in an enclosed environment such as a box, use a cooling fan or air conditioner to maintain the internal air temperature below 50°C.
The life of the built-in electrolytic capacitors of the Inverter is prolonged by maintaining the internal air temperature as low as possible.
- The surface temperature of the Inverter may rise approximately 30°C higher than the ambient temperature. Be sure to keep away equipment and wires from the Inverter as far as possible if the equipment and wires are easily influenced by heat.

■ Protecting Inverter from Foreign Matter during Installation

- Place a cover over the Inverter during installation to shield it from metal power produced by drilling. Upon completion of installation, always remove the cover from the Inverter. Otherwise, ventilation will be affected, causing the Inverter to overheat.

1-1-2 Removing and Mounting the Covers

To mount the Inverter, it is necessary to remove the front cover, terminal cover (unless the Inverter is a 200-V model), and the Digital Operator. To wire the Inverter, it is necessary to remove the front cover, terminal cover (unless the Inverter is a 200-V model), and bottom cover from the Inverter.

Follow the instructions below to remove the covers from the Inverter.

To mount the covers, take the opposite steps.

■ Removing the Front Cover

- Loosen the front cover mounting screws with a screwdriver.
- Press the left and right sides of the front cover in the arrow 1 directions and lift the bottom of the cover in the arrow 2 direction to remove the front cover as shown in the following illustration.

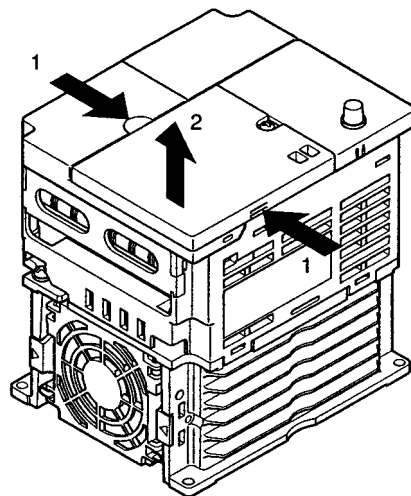

■ Removing the Digital Operator

- After removing the front cover, lift up the upper and lower right-hand sides (positions A) of the Digital Operator in the direction of arrow 1 as shown in the following illustration.

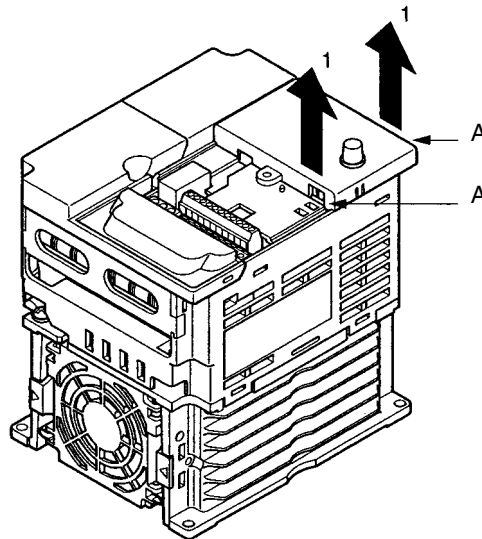

■ Removing the Terminal Cover

● 0.2- to 3.7-kW Inverters

- After the front cover is removed, press the left and right sides of the terminal cover in the arrow 1 directions and lift the terminal cover in the arrow 2 direction as shown in the following illustration.

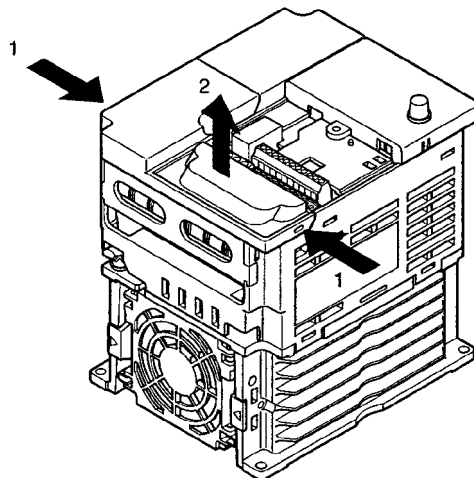

● 5.5-/7.5-kW Inverters

- Loosen the terminal cover screws in the direction of arrows 1.
- Press the left and right sides of the terminal cover in the direction of arrows 2 and lift it in the direction of arrow 3 as shown in the following illustration.

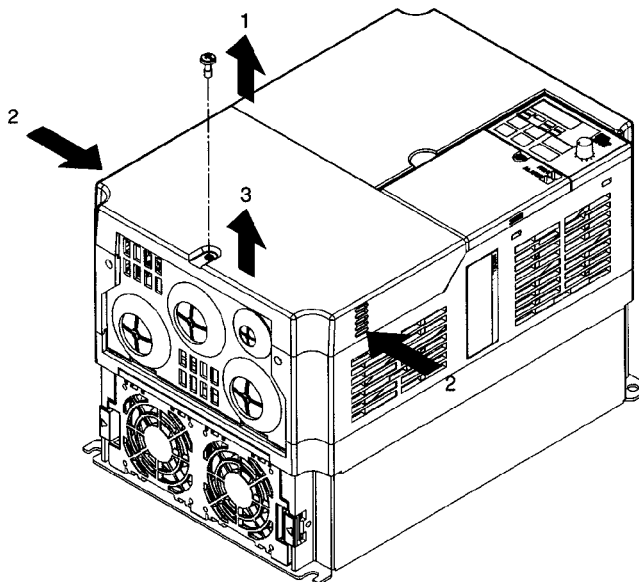

Note None of the following 200-V models have a terminal cover. Instead, the front cover is used as a terminal cover.

3G3MV-A2001 (0.1 kW), 3G3MV-A2002 (0.2 kW), 3G3MV-A2004 (0.4 kW), 3G3MV-A2007 (0.75 kW), 3G3MV-AB001 (0.1 kW), 3G3MV-AB002 (0.2 kW), and 3G3MV-AB004 (0.4 kW)

■ Removing the Bottom Cover

● 0.2- to 3.7-kW Inverters

- After removing the front cover and terminal cover, press the bottom cover in the arrow 1 direction based on position A as a fulcrum.

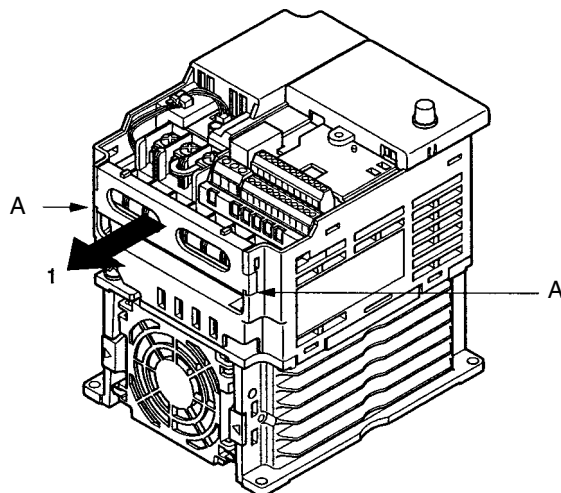

● **5.5-/7.5-kW Inverters**

- After removing the terminal cover, loosen the fastening screws.

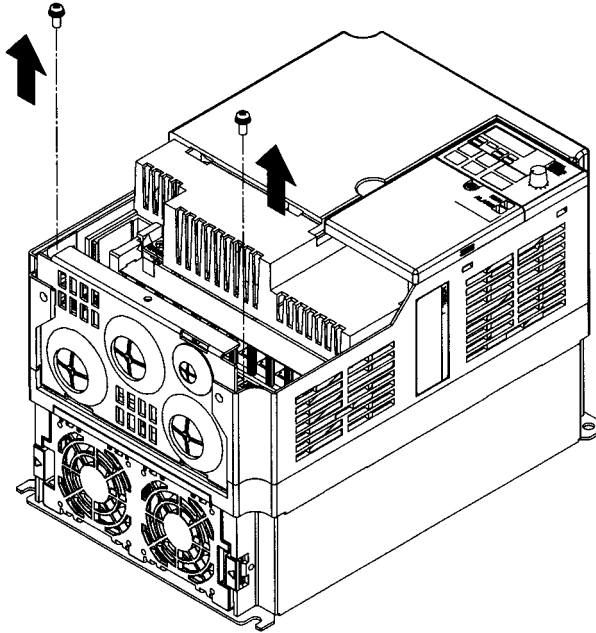

● **Replacing Cooling Fan (68-, 140-, 170-, and 180-mm-wide Inverters)**

1. Press the left and right sides of the fan cover located on the lower part of the radiation fin in the arrow 1 directions. Then lift the bottom of the Fan in the arrow 2 direction to remove the Fan as shown in the following illustration.

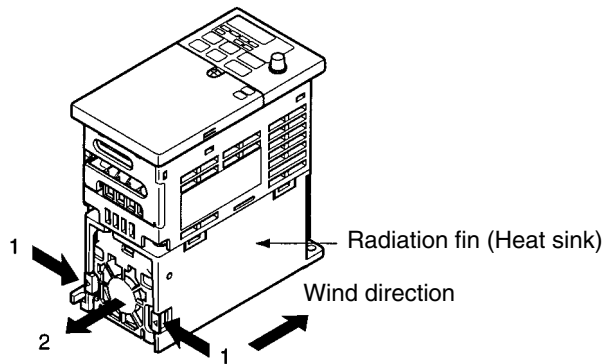

2. Hold the fan wire and pull the protective tube of the cover in the arrow 3 direction.

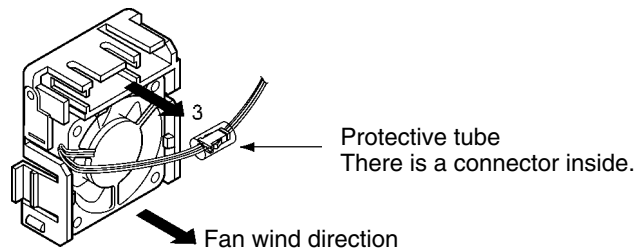

3. Slide the protective tube and remove the internal connector.

4. Remove the Fan from the fan cover.
5. Mount the new Fan on the fan cover. At this time, make sure that the wind direction of the Fan will be in the direction of the heat radiation fin.
6. Attach the connector, cover the connector with the protective tube, and insert the connector into the cover.
7. Mount the fan cover with the new Fan to the lower part of the heat radiation fin. Make sure that the fan cover snaps on securely with the heat radiation fin.

● Replacing Cooling Fan of 108-mm-wide Inverter Model

1. Dismount the front cover, bottom cover, and fan connector CN4.

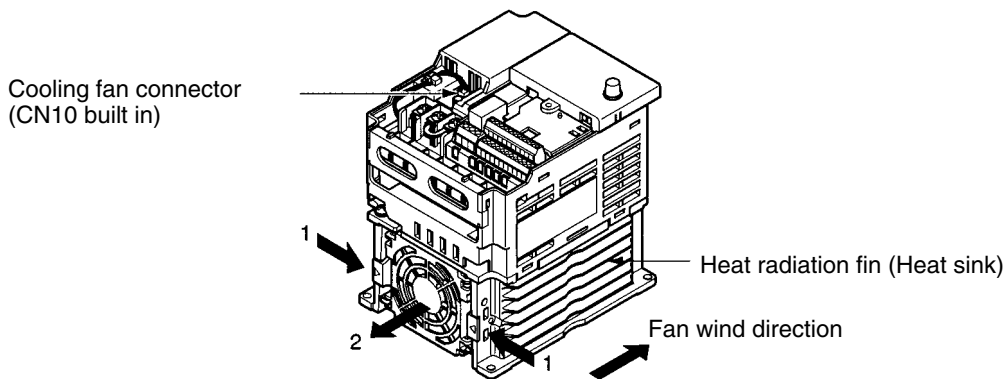

2. Press the left and right sides of the fan cover located on the lower part of the radiation fin in the arrow 1 directions. Then lift the bottom of the Fan in the arrow 2 direction to remove the fan as shown in the following illustration.
Disconnect the wire from the electrical inlet on the bottom of the plastic casing.
3. Remove the Fan from the fan cover.
4. Mount the new Fan on the fan cover. At this time, make sure that the wind direction of the fan will be in the direction of the heat radiation fin.
5. Mount the fan cover with the new Fan to the lower part of the heat radiation fin. Make sure that the fan cover snaps on securely with the heat radiation fin.
6. Wire the power line through the electrical inlet on the bottom of the plastic casing and the wiring groove into the internal circuitry of the Inverter.
7. Attach the wire to connector CN10 and attach the bottom cover and front cover.

1-2 Wiring

1-2-1 Terminal Block

To wire the terminal block of the Inverter, remove the front cover, terminal cover (unless the Inverter is a low-capacity 200-V model), and bottom cover from the Inverter.

There is a label under the front cover indicating the arrangement of main circuit terminals. Be sure to remove the label after wiring the terminals. The output terminal of the motor has a label as well. Remove the label before wiring the motor terminal.

■ Arrangement of Control Circuit Terminals

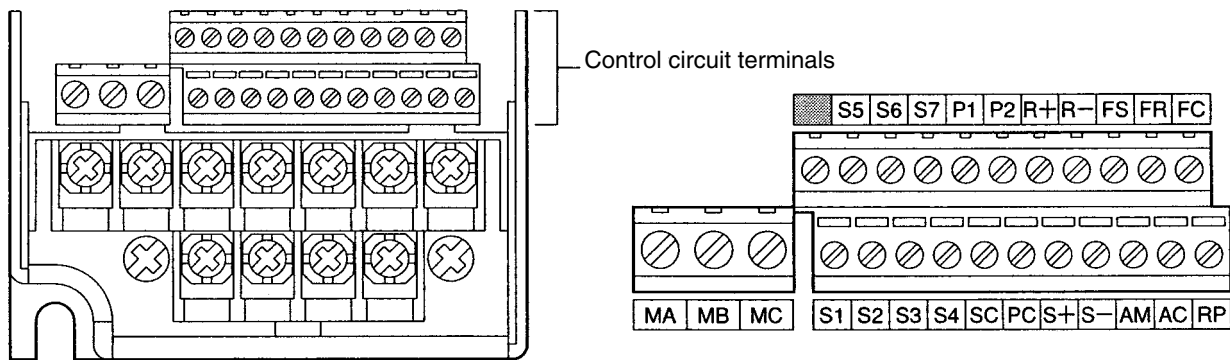

■ Arrangement of Main Circuit Terminals

- 3G3MV-A2001 through 3G3MV-A2007 (0.1 through 0.75 kW):
3-phase 200-V AC Input
- 3G3MV-AB001 through 3G3MV-AB004 (0.1 through 0.4 kW):
Single-phase 200-V AC Input

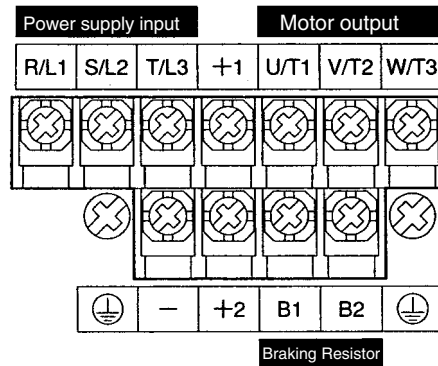

Note For single-phase input, connect R/L1 and S/L2.

- 3G3MV-A2015 to 3G3MV-A2022 (1.5 to 2.2 kW): 3-phase 200-V AC Input
3G3MV-AB007 to 3G3MV-AB015 (0.75 to 1.5 kW):
Single-phase 200-V AC Input
3G3MV-A4002 to 3G3MV-A4022 (0.2 to 2.2 kW): 3-phase 400-V AC Input

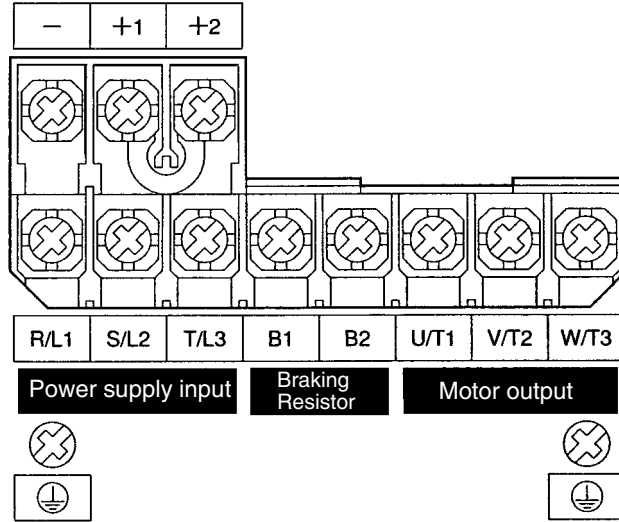

Note For single-phase input, connect R/L1 and S/L2.

- 3G3MV-A2037 to -A2075 (3.7 to 7.5 kW): 3-phase 200-V AC Input
3G3MV-AB022 to 3G3MV-AB037 (2.2 to 3.7 kW):
Single-phase 200-V AC Input
3G3MV-A4037 to -A4075 (3.7 to 7.5 kW): 3-phase 400-V AC Input

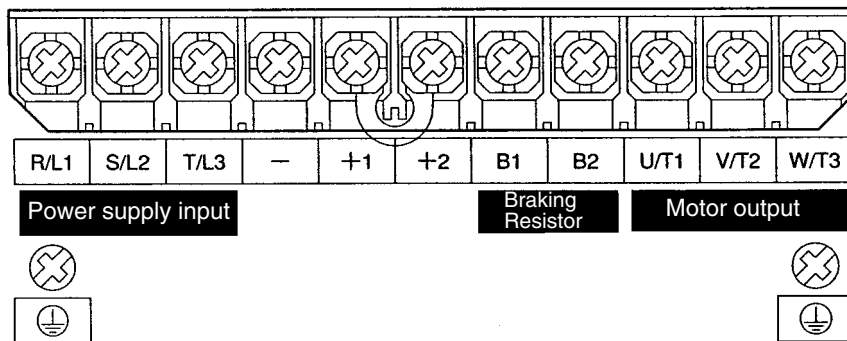

Note For single-phase input, connect R/L1 and S/L2.

■ Main Circuit Terminals

Symbol	Name	Description
R/L1	Power supply input terminals	3G3MV-A2□: 3-phase 200 to 230 V AC
S/L2		3G3MV-AB□: Single-phase 200 to 240 V AC (See note 1.)
T/L3		3G3MV-A4□: 3-phase 380 to 460 V AC
U/T1	Motor output terminals	3-phase power supply output for driving motors. (See note 2.)
V/T2		3G3MV-A2□: 3-phase 200 to 230 V AC
W/T3		3G3MV-AB□: 3-phase 200 to 240 V AC 3G3MV-A4□: 3-phase 380 to 460 V AC
B1	Braking Resistor connection terminals	Terminals for attaching an external Braking Resistor or a Braking Resistor Unit. (Connect to detect overvoltage during braking.)
B2		
+1	Connection terminals +1 and +2:	Connect the DC reactor for suppressing harmonics to terminals +1 and +2. When driving the Inverter with DC power, input the DC power to terminals +1 and –. (Terminal +1 is a positive terminal.)
+2	DC reactor connection terminals	
–	+1 and –: DC power supply input terminals	
	Ground terminal	Be sure to ground the terminal under the following conditions. 3G3MV-A2□: Ground at a resistance of 100 Ω or less. 3G3MV-AB□: Ground at a resistance of 100 Ω or less. 3G3MV-A4□: Ground at a resistance of 10 Ω or less. To conform to EC Directives, connect to the neutral point of the power supply. Note Be sure to connect the ground terminal directly to the motor frame ground.

Note 1. Connect single-phase input to both the R/L1 terminal and the S/L2 terminal.

Note 2. The maximum voltage at the output side corresponds to the power supply voltage for Inverter input.

■ Control Circuit Terminals

Symbol	Name	Specification	
Input	S1	Multi-function input 1 (Forward/Stop)	Photocoupler 8 mA at 24 V DC (See notes 2 and 3.)
	S2	Multi-function input 2 (Reverse/Stop)	
	S3	Multi-function input 3 (External fault: Normally open)	
	S4	Multi-function input 4 (Fault reset)	
	S5	Multi-function input 5 (Multi-step speed reference 1)	
	S6	Multi-function input 6 (Multi-step speed reference 2)	
	S7	Multi-function input 7 (Inching frequency command)	
	SC	Sequence input common	
	FS	Frequency reference power supply output	20 mA at 12 V DC
	FR	Frequency reference input	0 to 10 V DC (Input impedance: 20 k Ω)
	FC	Frequency reference common	
	RP	Pulse train input	Response frequency: 0 to 33 kHz (30% to 70% ED) H: 3.5 to 13.2 V L: 0.8 V max. (Input impedance: 2.24 k Ω)
CN2	1	Multi-function analog voltage input	Voltage input (between terminals 1 and 3): 0 to 10 V DC (Input impedance: 20 k Ω) Current input (between terminals 2 and 3): 4 to 20 mA (Input impedance: 250 Ω)
	2	Multi-function analog current input	
	3	Multi-function analog input common	

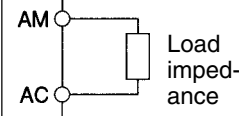
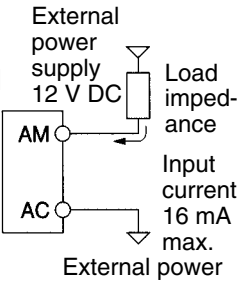
Symbol		Name	Specification					
Output	MA	Multi-function contact output (Normally open: Fault)	Relay output 1 A max. at 30 V DC 1 A max. at 250 V AC					
	MB	Multi-function contact output (Normally closed: Fault)						
	MC	Multi-function contact output common						
	P1	Multi-function photocoupler output 1 (During operation)	Open collector output 50 mA max. at 48 V DC					
	P2	Multi-function photocoupler output 2 (Frequency matching)						
	PC	Multi-function photocoupler output common						
AM	Multi-function analog output	<ul style="list-style-type: none"> • Analog output: 2 mA max. at 0 to 10 V DC • Pulse train output (max. output voltage: 12 V DC) (See note 4.) <p>When Used as Voltage Output</p> <table border="1"> <thead> <tr> <th>Output voltage (insulation type)</th> <th>Load impedance</th> </tr> </thead> <tbody> <tr> <td>+5 V</td> <td>1.5 kΩ min.</td> </tr> <tr> <td>+10 V</td> <td>10 kΩ min.</td> </tr> </tbody> </table> 	Output voltage (insulation type)	Load impedance	+5 V	1.5 kΩ min.	+10 V	10 kΩ min.
Output voltage (insulation type)	Load impedance							
+5 V	1.5 kΩ min.							
+10 V	10 kΩ min.							
AC	Multi-function analog output common	<p>When External Power Supply is Used</p> <table border="1"> <thead> <tr> <th>External power supply (V)</th> <th>Input current (mA) from external power supply</th> </tr> </thead> <tbody> <tr> <td>12 V DC (±5%)</td> <td>16 mA max.</td> </tr> </tbody> </table>  <p>Note Do not use a 5-V DC or 24-V DC external power supply. Doing so can cause internal circuit damage or malfunctioning.</p>	External power supply (V)	Input current (mA) from external power supply	12 V DC (±5%)	16 mA max.		
External power supply (V)	Input current (mA) from external power supply							
12 V DC (±5%)	16 mA max.							
Communications	R+	Receiver side	Conforming to RS-422/485					
	R-							
	S+	Sender side						
	S-							

Note 1. Parameter settings can be used to select various functions for multi-function inputs 1 to 7, multi-function contact outputs, and multi-function photocoupler outputs. The functions in parentheses are the default settings.

Note 2. NPN is the default setting for these terminals. Wire them by providing a common ground. No external power supply is required.

Note 3. To provide an external power supply and wire the terminals through a common positive line, set SW1 to PNP and use a 24 V DC ±10% power supply.

Note 4. When multi-function analog outputs are used for pulse train outputs, they can be directly connected to the pulse train inputs at other 3G3MV-series Inverters for simple synchronization or other applications.

■ **Selecting Input Method**

- Switches SW1 and SW2, both of which are located above the control circuit terminals, are used for input method selection.
Remove the front cover and optional cover to use these switches.

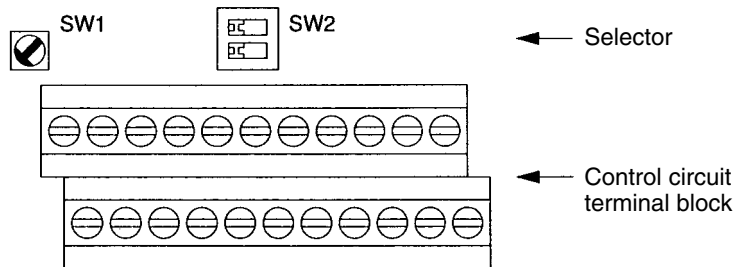

• **Selecting Sequence Input Method**

- By using SW1, NPN or PNP input can be selected as shown below.

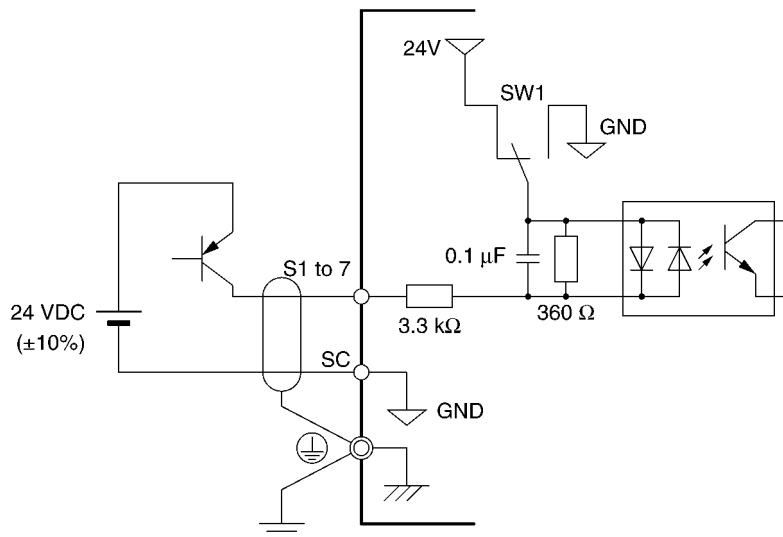
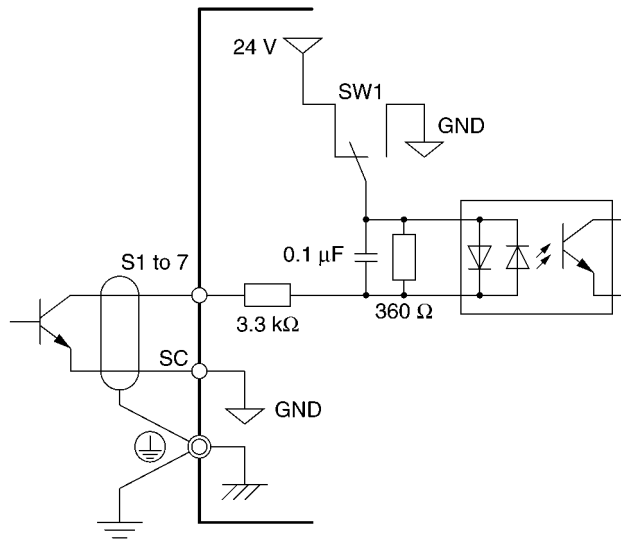

● **Selecting RS-422/485 Termination Resistance**

- Termination resistance can be selected by setting pin 1 of the SW2 to ON. The default setting for the pin is OFF.

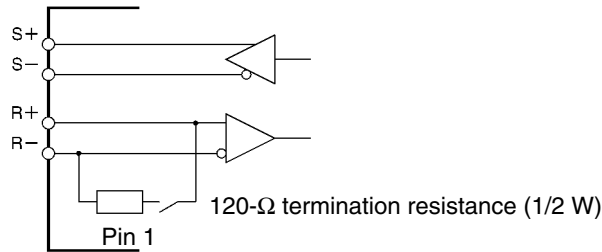

● **Selecting Frequency Reference Input Method**

Frequency reference input method	Pin 2 setting	Frequency reference selection (parameter n004)
Voltage input (default setting)	V (OFF)	Set value 2
Current input	I (ON)	Set value 3 or 4

Note Do not set pin 2 to ON for current input while voltage is being input, otherwise the resistor in the input circuit may burn out.

● **Frequency Reference Input by Pulse Train Input**

- The RP terminal can input or output a PLC or external pulse generator signal directly to the Inverter if an analog signal is unable to provide an accurate reference.
- This allows speed ratio and tracking operation between inverters.

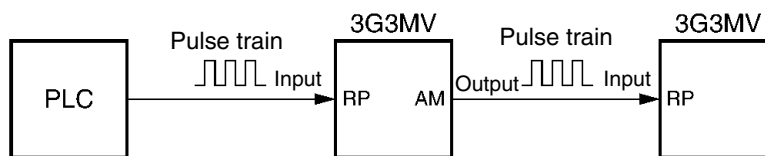

● Frequency Reference Input by PLC Pulse Train

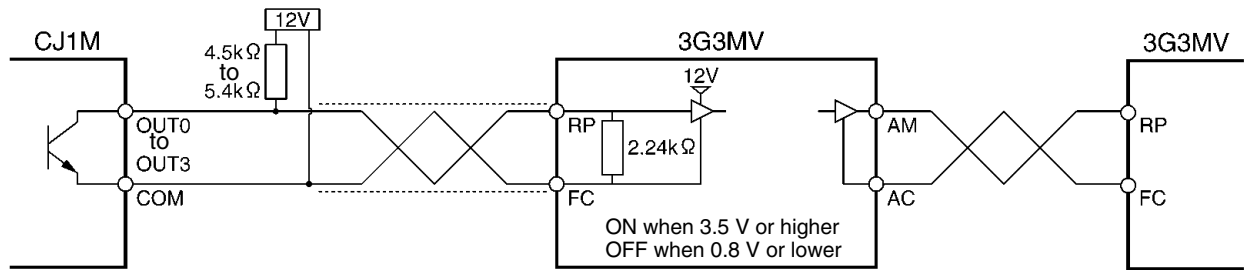

Note Use twisted pair shielded wire no longer than 5 m for pulse train input lines in order to suppress noise.

1-2-2 Standard Connections

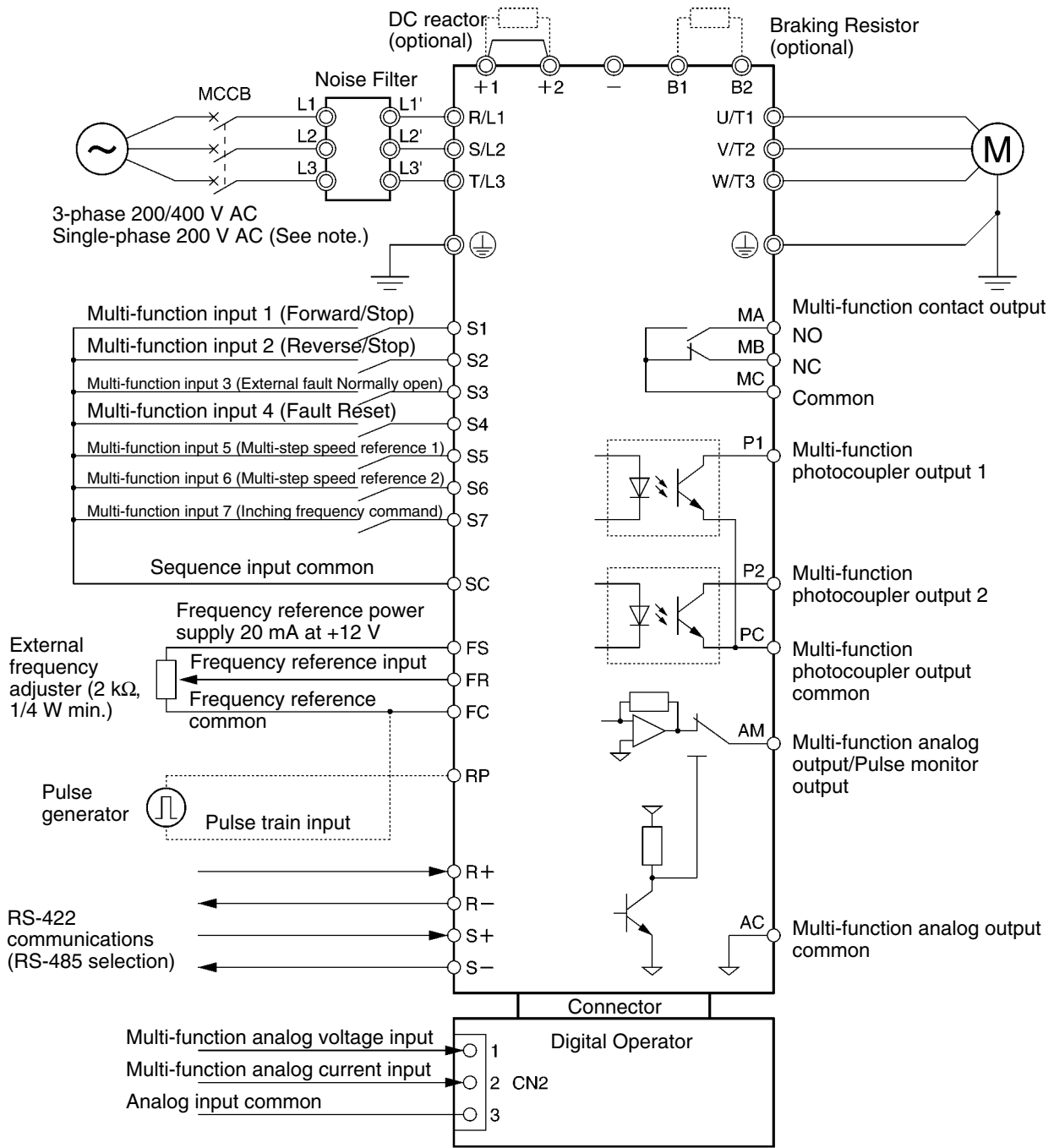

Note Connector on CN2 wiring side:
Contact: SZH-002T-P0.5
Housing: ZHR-3
(Products of J.S.T. MFG. Co., Ltd.)

Note Connect single-phase 200 V AC to terminals R/L1 and S/L2 of the 3G3MV-AB□.

● Example of 3-wire Sequence Connections

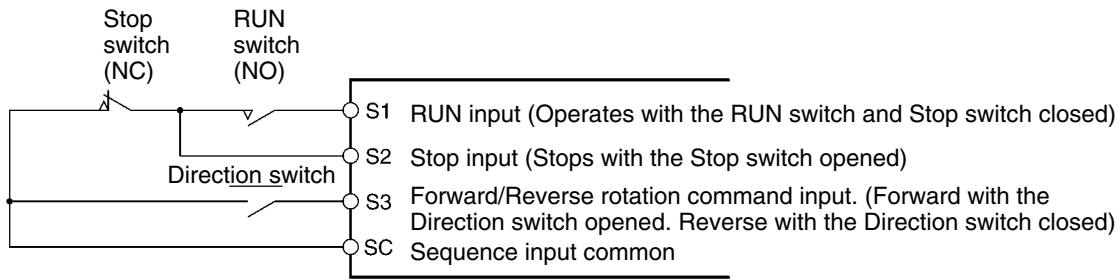

Note Set parameter 052 to forward/reverse rotation command 0 for 3-wire sequence input.

1-2-3 Wiring around the Main Circuit

■ Wire Size, Terminal Screw, Screw Tightening Torque, and Molded-case Circuit Breaker Capacities







- For the main circuit and ground, always use 600-V polyvinyl chloride (PVC) cables.
- If any cable is long and may cause voltage drops, increase the wire size according to the cable length.

● 3-phase 200-V AC Model



Model 3G3MV-	Terminal symbol	Terminal screw	Screw tightening torque (N•m)	Wire size (mm ²)	Recommended wire size (mm ²)
A2001	R/L1, S/L2, T/L3, B1, B2, -, +1, +2, U/T1, V/T2, W/T3	M3.5	0.8 to 1.0	0.75 to 2	2
	⏏				
A2002	R/L1, S/L2, T/L3, B1, B2, -, +1, +2, U/T1, V/T2, W/T3	M3.5	0.8 to 1.0	0.75 to 2	2
	⏏				
A2004	R/L1, S/L2, T/L3, B1, B2, -, +1, +2, U/T1, V/T2, W/T3	M3.5	0.8 to 1.0	0.75 to 2	2
	⏏				
A2007	R/L1, S/L2, T/L3, B1, B2, -, +1, +2, U/T1, V/T2, W/T3	M3.5	0.8 to 1.0	0.75 to 2	2
	⏏				
A2015	R/L1, S/L2, T/L3, B1, B2, -, +1, +2, U/T1, V/T2, W/T3	M4	1.2 to 1.5	2 to 5.5	2
	⏏				3.5
A2022	R/L1, S/L2, T/L3, B1, B2, -, +1, +2, U/T1, V/T2, W/T3	M4	1.2 to 1.5	2 to 5.5	3.5
	⏏				
A2037	R/L1, S/L2, T/L3, B1, B2, -, +1, +2, U/T1, V/T2, W/T3	M4	1.2 to 1.5	2 to 5.5	5.5
	⏏				
A2055	R/L1, S/L2, T/L3, B1, B2, -, +1, +2, U/T1, V/T2, W/T3	M5	2.5	5.5 to 8	8
	⏏				





Model 3G3MV-	Terminal symbol	Terminal screw	Screw tightening torque (N•m)	Wire size (mm ²)	Recommended wire size (mm ²)
A2075	R/L1, S/L2, T/L3, B1, B2, -, +1, +2, U/T1, V/T2, W/T3	M5	2.5	5.5 to 8	8
					

● Single-phase 200-V AC Model

Model 3G3MV-	Terminal symbol	Terminal screw	Terminal torque (N•m)	Wire size (mm ²)	Recommended wire size (mm ²)
AB001	R/L1, S/L2, T/L3, B1, B2, -, +1, +2, U/T1, V/T2, W/T3	M3.5	0.8 to 1.0	0.75 to 2	2
					
AB002	R/L1, S/L2, T/L3, B1, B2, -, +1, +2, U/T1, V/T2, W/T3	M3.5	0.8 to 1.0	0.75 to 2	2
					
AB004	R/L1, S/L2, T/L3, B1, B2, -, +1, +2, U/T1, V/T2, W/T3	M3.5	0.8 to 1.0	0.75 to 2	2
					
AB007	R/L1, S/L2, T/L3, B1, B2, -, +1, +2, U/T1, V/T2, W/T3	M4	1.2 to 1.5	2 to 5.5	3.5
					
AB015	R/L1, S/L2, B1, B2, -, +1, +2, U/T1, V/T2, W/T3	M4	1.2 to 1.5	2 to 5.5	5.5
					3.5
AB022	R/L1, S/L2, B1, B2, -, +1, +2, U/T1, V/T2, W/T3	M4	1.2 to 1.5	2 to 5.5	5.5
					
AB037	R/L1, S/L2, B1, B2, -, +1, +2, U/T1, V/T2, W/T3	M5	3.0	5.5 to 8	8
		M4	1.2 to 1.5	2 to 8	5.5

● 3-phase 400-V AC Model

Model 3G3MV-	Terminal symbol	Terminal screw	Screw tightening torque (N•m)	Wire size (mm ²)	Recommended wire size (mm ²)
A4002	R/L1, S/L2, T/L3, B1, B2, -, +1, +2, U/T1, V/T2, W/T3	M4	1.2 to 1.5	2 to 5.5	2
					
A4004	R/L1, S/L2, T/L3, B1, B2, -, +1, +2, U/T1, V/T2, W/T3	M4	1.2 to 1.5	2 to 5.5	2
					
A4007	R/L1, S/L2, T/L3, B1, B2, -, +1, +2, U/T1, V/T2, W/T3	M4	1.2 to 1.5	2 to 5.5	2
					

Model 3G3MV-	Terminal symbol	Terminal screw	Screw tight- ening torque (N•m)	Wire size (mm ²)	Recom- mended wire size (mm ²)
A4015	R/L1, S/L2, T/L3, B1, B2, -, +1, +2, U/T1, V/T2, W/T3	M4	1.2 to 1.5	2 to 5.5	2
					
A4022	R/L1, S/L2, T/L3, B1, B2, -, +1, +2, U/T1, V/T2, W/T3	M4	1.2 to 1.5	2 to 5.5	2
					
A4037	R/L1, S/L2, T/L3, B1, B2, -, +1, +2, U/T1, V/T2, W/T3	M4	1.2 to 1.5	2 to 5.5	2
					3.5
A4055	R/L1, S/L2, T/L3, B1, B2, -, +1, +2, U/T1, V/T2, W/T3	M4	1.8	3.5 to 5.5	5.5
					
A4075	R/L1, S/L2, T/L3, B1, B2, -, +1, +2, U/T1, V/T2, W/T3	M5	2.5	5.5 to 8	5.5
					

■ Wiring

Control Circuit

Terminal symbol	Terminal screw	Screw tightening torque N•m (lb•in)	Wire size mm ² (AWG)	Recommended wire size mm ² (AWG)
MA, MB, MC	M3	0.5 to 0.6 (4.4 to 5.3)	Stranded wire: 0.5 to 1.25 (20 to 16) Single wire: 0.5 to 1.25 (20 to 16)	0.75 (18)
S1 to S7, P1, P2, SC, PC, R+, R-, S+, S-, FS, FR, FC, AM, AC, RP	M2	0.22 to 0.25 (2 to 2.2)	Stranded wire: 0.5 to 0.75 (20 to 18) Single wire: 0.5 to 1.25 (20 to 16)	0.75 (18)

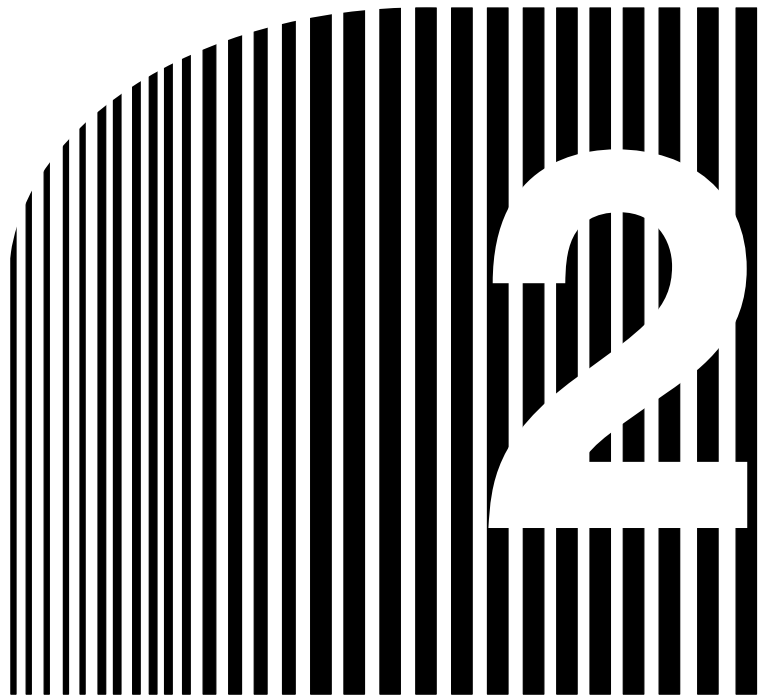

Chapter 2

• **Preparing for Operation and Monitoring** •

2-1 Nomenclature





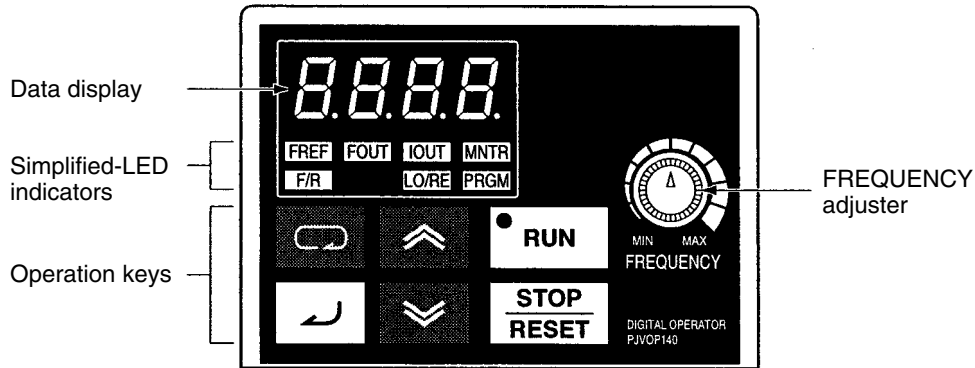

2-2 Copying and Verifying Parameters

2-1 Nomenclature

2-1-1 Names of Parts and their Functions



Appearance	Name	Function
	Data display	Displays relevant data items, such as frequency reference, output frequency, and parameter set values.
	FREQ adjuster	Sets the frequency reference within a range between 0 Hz and the maximum frequency.
	FREF indicator	The frequency reference can be monitored or set while this indicator is lit.
	FOUT indicator	The output frequency of the Inverter can be monitored while this indicator is lit.
	IOUT indicator	The output current of the Inverter can be monitored while this indicator is lit.
	MNTR indicator	The values set in U-01 through U-18 are monitored while this indicator is lit.
	F/R indicator	The direction of rotation can be selected while this indicator is lit, when operating the Inverter with the RUN Key.
	LO/RE indicator	The operation of the Inverter through the Digital Operator or according to the parameters set is selectable while this indicator is lit. Note This status of this indicator can be only monitored while the Inverter is in operation. Any RUN command input is ignored while this indicator is lit.
	PRGM indicator	The parameters in n001 through n179 can be set or monitored while this indicator is lit. Note While the Inverter is in operation, the parameters can be only monitored and only some parameters can be changed. The RUN command input is ignored while this indicator is lit.

Appearance	Name	Function
	Mode Key	Switches the simplified-LED (setting and monitor) item indicators in sequence. Parameter setting being made is canceled if this key is pressed before entering the setting.
	Increment Key	Increases multi-function monitor numbers, parameter numbers, and parameter set values.
	Decrement Key	Decreases multi-function monitor numbers, parameter numbers, and parameter set values.
	Enter Key	Enters multi-function monitor numbers, parameter numbers, and internal data values after they are set or changed.
	RUN Key	Starts the Inverter running when the 3G3MV is in operation with the Digital Operator.
	STOP/RESET Key	Stops the Inverter unless n007 is not set to disable the STOP Key. Functions as a Reset Key when an Inverter error occurs. (See note.)

Note For safety reasons, the reset will not work while a RUN command (forward or reverse) is in effect. Wait until the RUN command is OFF before resetting the Inverter.

2-1-2 Accepting Operation Commands While Changing Parameters

With the default settings, the Inverter will not accept operation commands when parameter settings are being changed. This functions as a safety measure to prevent the motor from rotating if the operation command is mistakenly set to ON when changing parameters.

Depending on the operating conditions, however, the user may want to have operation commands accepted even while parameters are being changed. In that case, change the following settings.

■ Using the Indicators to Determine When Operation Commands Can Be Accepted

The indicators on the Digital Operator can be used to determine if operation commands will be accepted or not while changing parameters.

Green: Operation commands will be accepted if the indicator lights green.

Red: Operation commands will not be accepted after the Inverter stops if an indicator lights red.

Therefore, if the indicator lights red when changing parameters or when switching between local and remote operation, operation will continue, but once the Inverter stops, the Inverter will not operate even if the operation command is set to ON again.

The FREF indicator will light when the power supply is turned ON.

Indicator	Color	Name	Acceptance of operation commands	
			During operation	Stopped
FREF	Green	Frequency Reference/Monitor	Yes	Yes
FOUT	Green	Output Frequency Monitor		
IOUT	Green	Output Current Monitor		
MNTR	Green	Multi-function Monitor		
F/R	Green	Operator RUN command forward/reverse operation selection		
LO/RE	Red	Local/Remote Selection	Yes	No (See note.)
PRGM	Red	Parameter Number/Setting		

Note Perform the settings given in the following description to have operation commands accepted while the red indicator is lit (i.e., while changing parameters or switching between local and remote.)

Set n001 (Parameter write-prohibit selection/parameter initialization) to 5.

- The default value for n001 is 1.
- Operation commands will not be accepted when n001 itself is being changed.
- Some parameters cannot be changed during operation. Those parameters cannot be changed during operation even if the setting for n001 is changed.
- When n001 is changed to 5, an operation command will be accepted even when changing parameters, such as during trial operation. Thoroughly check safety before changing any setting.

2-1-3 Outline of Operation

■ Selecting Indicators

Whenever the Mode Key is pressed, an indicator is lit in sequence beginning with the FREF indicator. The data display indicates the item corresponding to the indicator selected.

The FOUT or IOUT indicator will be lit by turning the Inverter ON again if the Inverter is turned OFF while the FOUT or IOUT indicator is lit. The FREF indicator will be lit by turning the Inverter ON again if the Inverter is turned OFF while an indicator other than the FOUT or IOUT indicator is lit.

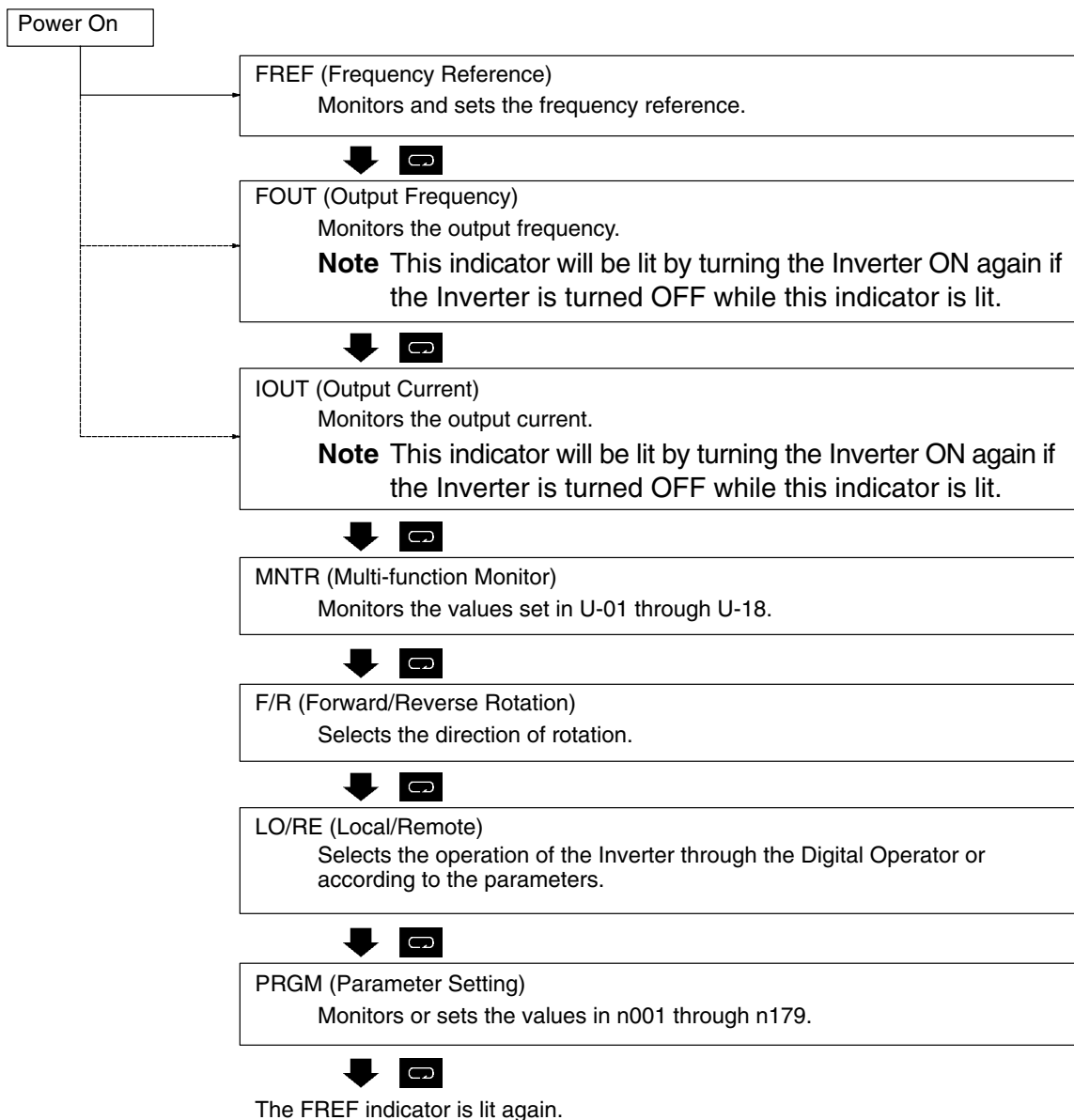

Note The setting unit of the frequency reference and output frequency is determined by the set value in n035. The default unit is Hz.

■ Example of Multi-function Display

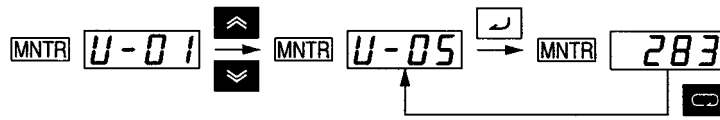

Key sequence	Indicator	Display	Explanation
	FREF	6.00	Power On
	MNTR	U-01	Press the Mode Key repeatedly until the MNTR indicator is lit. U01 will be displayed.
	MNTR	U-05	Use the Increment or Decrement Key to select the monitor item to be displayed.
	MNTR	283	Press the Enter Key so that the data of the selected monitor item will be displayed.
	MNTR	U-05	The monitor item will appear again by pressing the Mode Key.

● Status Monitor

Item	Display	Display unit	Function
U-01	Frequency reference	Hz (see note 1)	Monitors the frequency reference. (Same as FREF)
U-02	Output frequency	Hz (see note 1)	Monitors the output frequency. (Same as FOUT)
U-03	Output current	A	Monitors the output current. (Same as IOUT)
U-04	Output voltage	V	Monitors the internal output voltage reference value of the Inverter.
U-05	DC bus voltage	V	Monitors the DC voltage of the internal main circuit of the Inverter.
U-06	Input terminal status	---	Shows the ON/OFF status of inputs.
U-07	Output terminal status	---	Shows the ON/OFF status of outputs.
U-08	Torque monitor	%	Displays the torque being currently output as a percentage of the rated motor torque. This display can only be made in vector control mode.

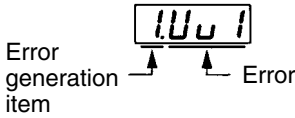
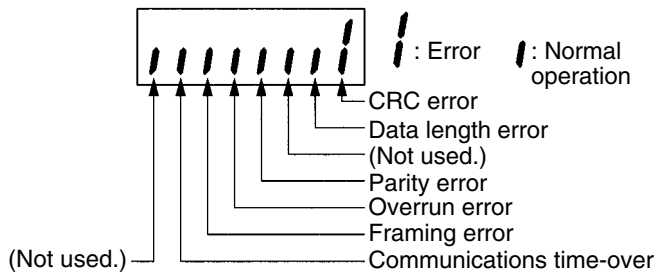
Item	Display	Display unit	Function
U-09	Error log (most recent one)	---	<p>The four most recent errors can be checked.</p>  <p>Note “1” means that the latest error is displayed. Press the Increment Key to display the second latest error. A maximum of four errors can be displayed.</p>
U-10	Software No.	---	OMRON use only.
U-11	Output power	W	Monitors the output power of the Inverter. (See note 2.)
U-13	Accumulated operating time	x10H	Monitor the accumulated operating time in 10-second units. (See note 3.)
U-15	Communications error	---	<p>Displays communications errors that occur during serial communications (RS-422/RS-485). The errors that are displayed have the same content as the serial communications error at register number 003D Hex.</p> 
U-16	PID feedback	%	Monitors the PID control feedback (Max. frequency: 100%)
U-17	PID input	%	Monitors the PID control input (Max. frequency: 100%)
U-18	PID output	%	Monitors the PID output (Max. frequency: 100%)

Note 1. The setting unit of the frequency reference and output frequency is determined by the set value in n035. The default unit is Hz.

Note 2. The output power monitor is not displayed in vector control mode. “—” is displayed instead.

Note 3. This function is provided for 200- and 400-V (5.5-/7.5-kW) Inverters only.

2-2 Copying and Verifying Parameters

The Digital Operator contains an EEPROM. All Inverter parameter settings, the Inverter capacity, and the software number are recorded in this EEPROM. The EEPROM can be used to copy parameter settings to other Inverters.

Parameter settings can be copied between Inverters with the same power supply specifications and the same control mode (V/f control or vector control), but some of the parameter settings are not copied.

2-2-1 Parameters Used to Copy and Verify Parameters

- The following parameters are used to read, copy (write), and verify parameter settings.

Parameter No. (Register No. (Hex))	Name	Description	Setting range	Setting unit	Default setting	Changes during operation
n176 (01B0)	Parameter copy and verify function	Selects the function for copying parameters. rdy: Ready to accept the next command. rED: Reads the Inverter parameters. Cpy: Copies the parameter to the Inverter. vFY: Verifies the Inverter parameters. vA: Checks the Inverter capacity display. Sno: Checks the software number.	rdy to Sno	---	rdy	No
n177 (01B1)	Parameter read prohibit selection	Selects the copy-prohibit function. Use this parameter to protect the data in the EEPROM of the Digital Operator. 0: Read prohibited for Inverter parameters. (Data cannot be written to EEPROM.) 1: Read possible for Inverter parameters. (Data can be written to EEPROM.)	0, 1	---	0	

■ Display Transitions

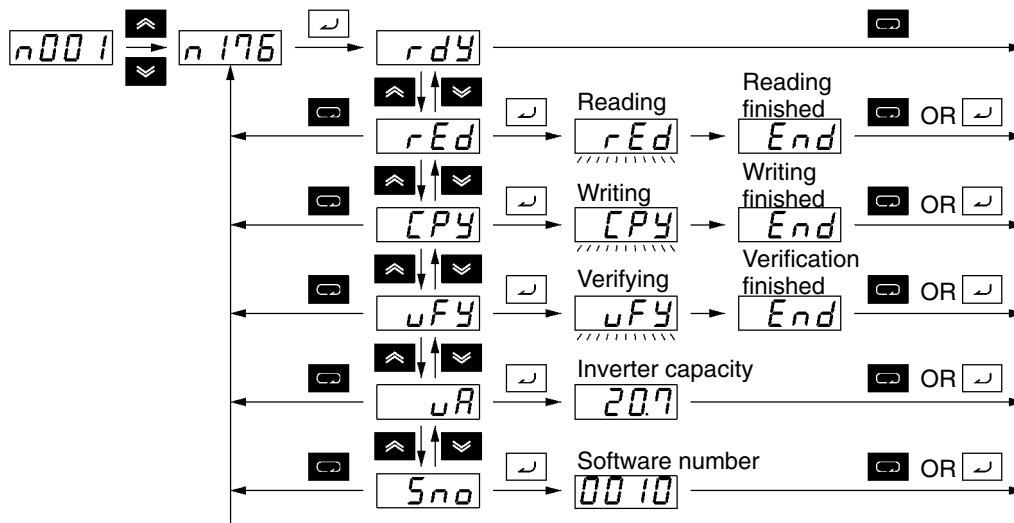

Note The following display is an example of the capacity displayed. The values in parentheses indicate the capacities for European motors.

Voltage Class	Max. applicable motor capacity
2: 3-phase 200 V	0.1: 0.1 kW (0.1 kW)
b: Single-phase 200 V	0.2: 0.25 kW/0.37 kW (0.2 kW)
4: 3-phase 400 V	0.4: 0.55 kW (0.4 kW)
	0.7: 1.1 kW (0.75 kW)
	1.5: 1.5 kW (1.5 kW)
	2.2: 2.2 kW (2.2 kW)
	3.7: 3.7 kW (3.7 kW)
	4.0: 4.0 kW (4.0 kW)
	5.5: 5.5 kW (5.5 kW)
	7.5: 7.5 kW (7.5 kW)

Note The values in parentheses indicate Japanese motor capacities.

2-2-2 Outline of Copying Parameters

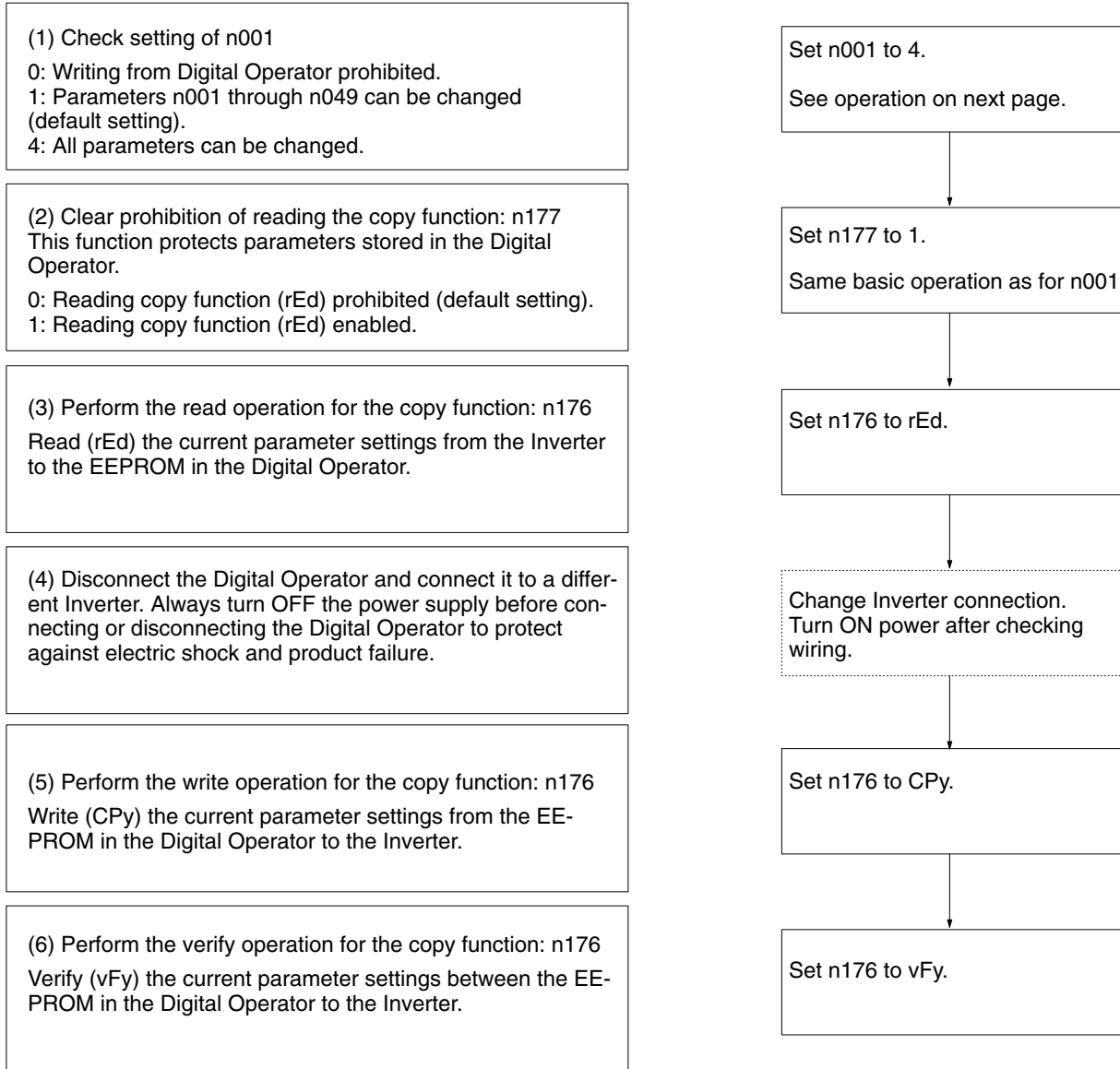

■ Parameters That Cannot Be Copied

1. Copying is not possible between Inverters with different power supply specifications (e.g., from a 200-V Inverter to a 400-V Inverter).
2. The recorded hold output frequency and the following parameters cannot be copied:
 - n176: Parameter copy and verify function selection
 - n177: Parameter read prohibit selection
 - n178: Fault log
 - n179: Software number
3. The following parameters cannot be copied if the Inverters have different capacities.
 - n011 to n017: V/f settings
 - n036: Rated motor current
 - n080: Carrier frequency selection





- n105: Torque compensation core loss
- n106: Rated motor slip
- n107: Motor phase-to-neutral resistance
- n108: Motor leakage inductance
- n109: Torque compensation limit
- n110: Motor no-load current
- n140: Energy-saving control coefficient K2
- n158: Motor code

2-2-3 Procedures

Changing Parameters

The setting of n001 is changed so that n176 and n177 can be displayed.

● **Setting n01 (Parameter Write-prohibit Selection/Parameter Initialization Parameter)**

Key	Indicator	Display	Description
---	FREF	0.00	(Display after the power supply is turned ON.)
	PRGM	n001	Press the Mode Key until the PRGM indicator lights. Confirm that n001 is displayed on the data display.
	PRGM	1	Press the Enter Key. The setting of the specified parameter number will be displayed.
	PRGM	4	Press the Increment Key until 4 is displayed. (The display will flash.)
	PRGM	4	Press the Enter Key to confirm the setting. (The display will stop flashing.)
After about 1 s	PRGM	n001	The display of the parameter number will return in about 1 s.

Example of Copy Function

■ **Verifying Parameters (vFy)**

- The Parameter Copy and Verify Function (n176) can be set to “vFy” to compare the parameter settings in the Digital Operator with those in the Inverter.

● **Verifying Parameters**

Key	Indicator	Display	Description
---	FREF	0.00	(Display after the power supply is turned ON.)
	PRGM	n001	Press the Mode Key until the PRGM indicator lights. Confirm that n001 is displayed on the data display.
	PRGM	n176	Press the Increment/Decrement Key until “n176” is displayed.
	PRGM	rdy	Press the Enter Key. “rdy” will be displayed.
	PRGM	vFy	Press the Increment Key until “vFy” is displayed
	PRGM	vFy	Press the Enter Key. The parameter settings will be compared and the display will flash.
	PRGM	n011	The parameter number of any parameter that has different settings will be displayed.
	PRGM	600	Press the Enter Key. The setting of the parameter in the Inverter will be displayed (flashing) first.
	PRGM	500	Press the Enter Key again. The setting of the parameter in the Digital Operator will be displayed (flashing) next.
	PRGM	vFy	Press the Increment Key. The comparison will be continued.
(After comparison is finished.)	PRGM	End	“End” will be displayed when the comparison has been finished.
or	PRGM	n176	Press the Mode Key or Enter Key. The display of the parameter number will return.

Note 1. If the STOP/RESET Key is pressed when a non-matching parameter number or setting is displayed, verification will be canceled at that point and “End” will be displayed. The parameter number display will then return if the Mode Key or Enter Key is pressed.

Note 2. “vAE” (capacity error) will be displayed if verification is attempted between Inverters with different capacities. Press the Enter Key to continue the verification operation. Press the STOP/RESET Key to cancel the verification operation.

2-2-4 Error Messages for Copying and Verifying Parameters

The errors that can be displayed when reading, writing, or verifying parameter settings are described in the following table along with corrective actions. All of these error displays will flash on the display.

Display	Name	Description	Corrective action
<i>P-rE</i>	Protect error	An attempt was made to read parameter settings when the Parameter Read Prohibit Selection parameter (n177) was set to 0 (prohibiting reading).	Confirm that it is necessary to read the parameter settings. If it is, change the Parameter Read Prohibit Selection parameter (n177) to 1 (enabling reading).
<i>r-dE</i>	Read error	The parameter settings could not be read normally or a low main circuit voltage was detected while reading parameter settings.	Check the main circuit voltage and then attempt reading again.
<i>[-SE</i>	Checksum error	A checksum error occurred for the parameters recorded in the Digital Operator.	Read the parameter settings again to record them in the Digital Operator.
<i>no-dt</i>	No data error	No parameters are recorded in the Digital Operator.	Read the parameter settings to record them in the Digital Operator.
<i>[PE</i>	Copy source error	Copying or verifying parameter settings was attempted between Inverters with different voltage classes or control modes.	Check the voltage classes and control modes. (They must both be the same to copy parameter settings.) If only the control modes are different, change the control mode of the Inverter to which the parameters are being copied and then repeat the operation.
<i>[YE</i>	Voltage error while copying	A low main circuit voltage was detected while copying parameter settings.	Check the main circuit voltage and then attempt copying again.
<i>u-rE</i>	Capacity error	Verification was attempted between Inverters of different capacities.	Press the Enter Key to continue the comparison. Press the STOP/RESET Key to cancel the comparison.
<i>[-FE</i>	Communications error	A communications error occurred between the Inverter and Digital Operator.	Check the connection between the Inverter and the Digital Operator and then repeat the operation.

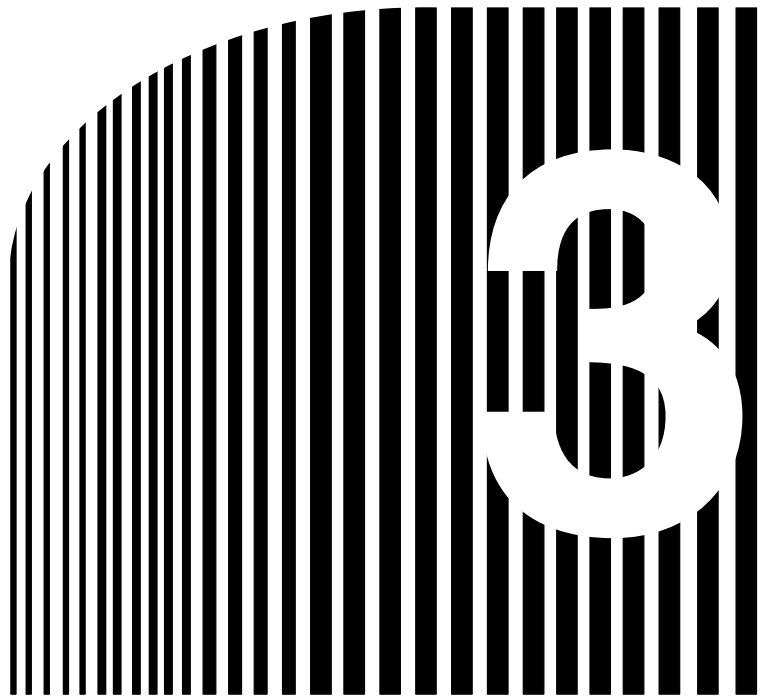

Chapter 3

- **List of Parameters** •

■ Function Group 1 (n001 through n049)

Parameter No.	Register No. (Hex)	Name	Description	Setting range	Default setting	Changes during operation	Memo
n001	0101	Parameter write-prohibit selection/parameter initialization	<p>Used to prohibit parameters to be written, sets parameters, or change the monitor range of parameters.</p> <p>Used to initialize parameters to default settings.</p> <p>0: Parameter n001 is set or displayed. Parameters from n002 to n179 can be displayed only.</p> <p>1: Parameters from n001 to n049 (function group 1) are set or displayed.</p> <p>2: Parameters from n001 to n079 (function groups 1 and 2) are set or displayed.</p> <p>3: Parameters from n001 to n119 (function groups 1 through 3) are set or displayed.</p> <p>4: Parameters from n001 to n179 (function groups 1 through 4) are set or displayed.</p> <p>5: Operation commands can be accepted (n001 to n179 can be set) while the red indicator is lit (i.e., while changing parameters or switching between local and remote.) (See note.)</p> <p>6: Clears the error log.</p> <p>8: Initializes parameters to default settings in 2-wire sequence.</p> <p>9: Initializes parameters to default settings in 3-wire sequence.</p> <p>10: For the USA, initializes parameter in 2-wire sequence.</p> <p>11: For the USA, initializes parameter in 3-wire sequence.</p> <p>Note If the parameter is set to 0 to 4, operation commands will be ignored while the red indicator is lit (refer to 2-1-2). Normally, use the Inverter with set values 0 to 4.</p>	0 to 9	1	No	

Parameter No.	Register No. (Hex)	Name	Description	Setting range	Default setting	Changes during operation	Memo
n002	0102	Control mode selection	<p>Used to select the control mode of the Inverter.</p> <p>0: V/f control mode 1: Vector control mode (open loop)</p> <p>Note The set value in n002 is not initialized with n001 set to 8, 9, 10, or 11.</p> <p>Note Each of the following parameters is initialized according to the preset control mode. The default setting varies with the control mode.</p> <p>n014: Middle output frequency n015: Middle output frequency voltage n016: Minimum output frequency n017: Minimum output frequency voltage n104: Torque compensation primary delay time constant n111: Slip compensation gain n112: Slip compensation primary delay time constant</p>	0, 1	0	No	
n003	0103	RUN command selection	<p>Used to select the input method for the RUN and STOP commands in remote mode.</p> <p>0: The STOP/RESET Key on the digital Operator is enabled. 1: Multi-function input is enabled through the control circuit terminals in 2- or 3-wire sequence. 2: RS-422/485 communications are enabled. 3: Input is enabled from the optional DeviceNet Communications Unit.</p> <p>Note The RUN command only through key sequences on the Digital Operator is acceptable in local mode.</p>	0 to 3	0	No	

Parameter No.	Register No. (Hex)	Name	Description	Setting range	Default setting	Changes during operation	Memo
n004	0104	Frequency reference selection	Used to set the input method for the frequency reference in remote mode. 0: Digital Operator 1: Frequency reference 1 (n024) 2: Frequency reference control terminal (0 to 10 V) 3: Frequency reference control terminal (4 to 20 mA) 4: Frequency reference control terminal (0 to 20 mA) 5: Pulse train reference control terminal is enabled. 6: Frequency reference through RS-422/RS-485 is enabled. 7: Multi-function analog voltage input (0 to 10 V) is enabled. 8: Multi-function analog current input (4 to 20 mA) is enabled. 9: Frequency reference input through DeviceNet communications is enabled.	0 to 9	0	No	
n005	0105	Stopping method selection	Used to set the stopping method for use when the STOP command is input. 0: Decelerates to stop in preset time. 1: Coasts to stop (with output turned OFF by the STOP command)	0, 1	0	No	
n006	0106	Reverse rotation-prohibit selection	Used to select the operation with the reverse command input. 0: Reverse enabled (accept). 1: Reverse disabled (not accept).	0, 1	0	No	
n007	0107	STOP Key function selection	Used to enable/disable the STOP Key in remote mode with n003 for operation mode selection not set to 0. 0: STOP Key of the Digital Operator enabled. 1: STOP Key of the Digital Operator disabled.	0, 1	0	No	

Parameter No.	Register No. (Hex)	Name	Description	Setting range	Default setting	Changes during operation	Memo
n008	0108	Frequency reference selection in local mode	Used to set the input method for the frequency reference in local mode. 0: The FREQ adjuster of the Digital Operator enabled. 1: Key sequences on the Digital Operator enabled. (Set in n024.)	0, 1	0	No	
n009	0109	Operator frequency setting method selection	Used to enable the Enter Key for setting the frequency reference with the Increment and Decrement Keys. 0: The value is entered with the Enter Key pressed. 1: The value is enabled when the value is input.	0, 1	0	No	
n010	010A	Operation selection at Digital Operator interruption	Select whether or not to detect the OPR error (Digital Operator connection error). 0: No (The Inverter continues operating.) 1: Yes (Error output turns ON and the Inverter coasts to a stop)	0, 1	0	No	

Parameter No.	Register No. (Hex)	Name	Description	Setting range	Default setting	Changes during operation	Memo
n011	010B	Maximum frequency (FMAX)	<p>Used to set the V/f pattern as the basic characteristic of the Inverter. V/f control mode: set output voltage per frequency Vector control mode: set for torque adjustment</p> <p>Output voltage (V)</p> <p>Frequency (Hz)</p> <p>Note Set the parameters so that the following condition will be satisfied. $n016 \leq n014 < n013 \leq n011$</p> <p>Note The value set in n015 will be ignored if parameters n016 and n014 have the same value.</p>	50.0 to 400.0	60.0	No	
n012	010C	Maximum voltage (VMAX)		0.1 to 255.0 (0.1 to 510.0)	200.0 (400.0) (See note 1.)	No	
n013	010D	Maximum voltage frequency (FA)		0.2 to 400.0	60.0	No	
n014	010E	Middle output frequency (FB)		0.1 to 399.9	1.5	No	
n015	010F	Middle output frequency voltage (VC)		0.1 to 255.0 (0.1 to 510.0)	12.0 (24.0) (See note 2.)	No	
n016	0110	Minimum output frequency (FMIN)		0.1 to 10.0	1.5	No	
n017	0111	Minimum output frequency voltage (VMIN)		0.1 to 50.0 (0.1 to 100.0)	12.0 (24.0) (See note 2)	No	
n018	0112	Acceleration/Deceleration time setting Unit (n018)	<p>Select the unit of acceleration or deceleration time of the Inverter.</p> <p>0: 0.1 s Unit (Less than 1,000 s: 0.1-s increments; 1,000 s or over: 1-s increments)</p> <p>1: 0.01 s Unit (Less than 100 s: 0.01-s increments; 100 s or over: 0.1-s increments)</p>	0, 1	0	No	

Note 1. The values in brackets are those for 400-V-class Inverters.

Note 2. For 200 and 400-V-class 5.5-/7.7-kW Inverters, this value is 10.0 V (20.0 V).

Parameter No.	Register No. (Hex)	Name	Description	Setting range	Default setting	Changes during operation	Memo
n019	0113	Acceleration time 1	Acceleration time: The time required to go from 0% to 100% of the maximum frequency.	0.0 to 6,000	10.0	Yes	
n020	0114	Deceleration time 1	Deceleration time: The time required to go from 100% to 0% of the maximum frequency. Note The actual acceleration or deceleration time is obtained from the following formula. Acceleration/Deceleration time = (Acceleration/Deceleration time set value) × (Frequency reference value) ÷ (Max. frequency)		10.0	Yes	
n021	0115	Acceleration time 2			10.0	Yes	
n022	0116	Deceleration time 2			10.0	Yes	
n023	0117	S-shape acceleration/ deceleration characteristic	Used to set S-shape acceleration/ deceleration characteristics. 0: No S-shape acceleration/ deceleration (trapezoidal acceleration/ deceleration) 1: S-shape acceleration/ deceleration characteristic time 0.2 s 2: S-shape acceleration/ deceleration characteristic time 0.5 s 3: S-shape acceleration/ deceleration characteristic time 1.0 s Note When the S-shape acceleration/ deceleration characteristic time is set, the acceleration and deceleration times will be lengthened according to the S-shape at the beginning and end of acceleration/ deceleration.	0 to 3	0	No	

Parameter No.	Register No. (Hex)	Name	Description	Setting range	Default setting	Changes during operation	Memo
n024	0118	Frequency reference 1	<p>Used to set internal frequency references.</p> <p>Note Frequency reference 1 is enabled in remote mode with n004 for frequency reference selection set to 1.</p> <p>Note These frequency references are selected with multi-step speed references (multi-function input).</p>	0.0 to max. frequency	6.00	Yes	
n025	0119	Frequency reference 2			0.00	Yes	
n026	011A	Frequency reference 3			0.00	Yes	
n027	011B	Frequency reference 4			0.00	Yes	
n028	011C	Frequency reference 5			0.00	Yes	
n029	011D	Frequency reference 6			0.00	Yes	
n030	011E	Frequency reference 7			0.00	Yes	
n031	011F	Frequency reference 8			0.00	Yes	
n032	0120	Inching frequency command	<p>Used to set the inching frequency command.</p> <p>Note The inching frequency command is selected with the inching command (multi-function input). The inching frequency command takes precedence over the multi-step speed reference.</p>		6.00	Yes	
n033	0121	Upper frequency reference limit	<p>Used to set the upper and lower frequency reference limits in percentage based on the maximum frequency as 100%.</p> <p>Note If n034 is set to a value less than the minimum output frequency (n016), the Inverter will have no output when a frequency reference less than the minimum output frequency input is input.</p>	0 to 110	100	No	
n034	0122	Lower frequency reference limit		0 to 110	0	No	

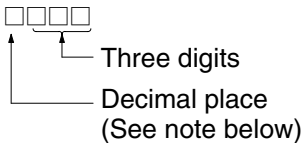
Parameter No.	Register No. (Hex)	Name	Description	Setting range	Default setting	Changes during operation	Memo
n035	0123	Frequency reference setting/display unit selection	<p>Set the unit of frequency reference and frequency-related values to be set or monitored through the Digital Operator.</p> <p>0: 0.01 Hz 1: 0.1% 2 to 39: rpm (number of motor poles) 40 to 3,999: The value to be set or monitored at max. frequency. Set the value as shown below.</p>  <p>Note To display 50.0, for example, set the value to 1500. The setting unit of each parameter or monitor item below varies with the decimal place.</p> <ul style="list-style-type: none"> Parameters: n024 through n032 and n120 through n127 Monitor Items: U-01 and U-02 	0 to 3,999	0	No	
n036	0124	Rated motor current	<p>Used to set the rated motor current for motor overload detection (OL1) based on the rated motor current.</p> <p>Note In vector control mode, this parameter is used as a constant for vector control operation.</p> <p>Note Motor overload detection (OL1) is disabled by setting the parameter to 0.0.</p> <p>Note The rated motor current is default to the standard rated current of the maximum applicable motor.</p>	0.0 to 150% of rated output current of the Inverter	Varies with the capacity	No	

Parameter No.	Register No. (Hex)	Name	Description	Setting range	Default setting	Changes during operation	Memo
n037	0125	Motor protection characteristics	<p>Used to set the motor overload detection (OL1) for the electronic thermal characteristics of the motor.</p> <p>0: Protection characteristics for general-purpose induction motors</p> <p>1: Protection characteristics for inverter-dedicated motors</p> <p>2: No protection</p> <p>Note If a single Inverter is connected to more than one motor, set the parameter to 2 for no protection. The parameter is also disabled by setting n036 for rated motor to 0.0.</p>	0 to 2	0	No	
n038	0126	Motor protective time	<p>Used to set the electric thermal characteristics of the motor to be connected in 1-minute increments.</p> <p>Note The default setting does not require any changes in normal operation.</p> <p>Note To set the parameter according to the characteristics of the motor, check with the motor manufacturer the thermal time constant and set the parameter with some margin. In other words, set the value slightly shorter than the thermal time constant.</p> <p>Note To detect motor overloading quicker, reduce the set value, provided that it does not cause any application problems.</p>	1 to 60	8	No	

Parameter No.	Register No. (Hex)	Name	Description	Setting range	Default setting	Changes during operation	Memo	
n039	0127	Cooling fan operation	Used to operate the Cooling Fan of the Inverter while the Inverter is turned ON or only while the Inverter is in operation. 0: Rotates only while RUN command is input and for 1 minute after Inverter stops operating 1: Rotates while Inverter is turned ON Note This parameter is available only if the Inverter incorporates a Cooling Fan. Note If the operation frequency of the Inverter is low, the life of the fan can be prolonged by setting the parameter to 0.	0, 1	0	No		
n040	0128	Motor rotation direction	0: A forward command rotates the motor counterclockwise when viewed from the load. 1: A forward command rotates the motor clockwise when viewed from the load.	0, 1	0	No		
n041	0129	Acceleration time 3	Acceleration time: The time it takes maximum frequency to go from 0% to 100%.	0.0 to 6,000	10.0	Yes		
n042	012A	Deceleration time 3	Deceleration time: The time it takes maximum frequency to go from 100% to 0%.		10.0	Yes		
n043	012B	Acceleration time 4	Note Actual acceleration/deceleration time is calculated using the following formula. Acceleration/deceleration time setting x frequency reference / maximum frequency		10.0	Yes		
n044	012C	Deceleration time 4			10.0	Yes		

■ Function Group 2 (n050 through n079)

Parameter No.	Register No. (Hex)	Name	Description			Setting range	Default setting	Changes during operation	Memo
n050	0132	Multi-function input 1 (Input terminal S1)	Used to select the functions of multi-function input terminals S1 through S7.			1 to 33 (26 See note.)	1	No	
			Set value	Function	Description				
n051	0133	Multi-function input 2 (Input terminal S2)	0	Forward/Reverse rotation command	3-wire sequence (to be set in n052 only) By setting to 0, the set values in n050 and n051 are ignored and the following settings are forcibly made.	1 to 33 (26 See note.)	2	No	
n052	0134	Multi-function input 3 (Input terminal S3)			S1: RUN input (RUN when ON) S2: STOP input (STOP when OFF) S3: Forward/Reverse rotation command (OFF: Forward; ON: Reverse)	0 to 33 (26 See note.)	3	No	
n053	0135	Multi-function input 4 (Input terminal S4)	1	Forward/Stop	Forward rotation command in 2-wire sequence. (Forward rotation with the signal turned ON)	1 to 33 (26 See note.)	5	No	
n054	0136	Multi-function input 5 (Input terminal S5)	2	Reverse/Stop	Reverse rotation command in 2-wire sequence (Reversed with the terminal turned ON)	1 to 33 (26 See note.)	6	No	
n055	0137	Multi-function input 6 (Input terminal S6)	3	External fault (NO)	ON: External fault (EF□ detection: □ is a terminal number)	1 to 33 (26 See note.)	7	No	
			4	External fault (NC)	OFF: External fault (EF□ detection: □ is a terminal number)				

Note Inverter overheating warning (setting value: 26) can be set for 5.5-kW and 7.5-kW Inverters only.

Parameter No.	Register No. (Hex)	Name	Description			Setting range	Default setting	Changes during operation	Memo
n056	0138	Multi-function input 7 (Input terminal S7)	5	Fault reset	ON: Fault reset (disabled while RUN command is input)	1 to 35, (26 See note.) 34, 35	10	No	
			6	Multi-step speed reference 1	Signals to select frequency references 1 through 16.				
			7	Multi-step speed reference 2					
			8	Multi-step speed reference 3					
			9	Multi-step speed reference 4					
			10	Inching frequency command	ON: Inching frequency command (taking precedence over the multi-step speed reference)				
			11	Acceleration/deceleration time selection 1	See set value 27.				
			12	External base block command (NO)	ON: Output turned OFF				
			13	External base block command (NC)	OFF: Output turned OFF				
			14	Search command (Searching starts from maximum frequency)	ON: Speed search (Searching starts from n011)				
15	Search command (Searching starts from pre-set frequency)	ON: Speed search							

Parameter No.	Register No. (Hex)	Name	Description	Setting range	Default setting	Changes during operation	Memo
			16	Acceleration/Deceleration-prohibit command	ON: Acceleration/Deceleration is on hold (running at parameter frequency)		
			17	Local or remote selection	ON: Local mode (operated with the Digital Operator)		
			18	Communications/remote selection	ON: Communications input is enabled.		
			19	Emergency stop fault (NO)	The Inverter stops according to the setting in n005 for interruption mode selection with the emergency stop input turned ON.		
			20	Emergency stop warning (NO)		NO: Emergency stop with the contact closed. NC: Emergency stop with the contact opened.	
			21	Emergency stop fault (NC)	Fault: Fault output is ON and reset with RESET input. Warning output is ON (no reset required). "STP" is displayed (lit with fault input ON and flashes with alarm input ON)		
			22	Emergency stop warning (NC)			
			23	PID control cancel	ON: PID control disabled.		
			24	PID control integral reset	ON: Integral value reset.		
			25	PID control integral hold	ON: Keeps integral value on hold.		
			26 (See note)	Inverter overheating warning	ON: Displays inverter overheating warning (oH3).		

Parameter No.	Register No. (Hex)	Name	Description		Setting range	Default setting	Changes during operation	Memo	
			27	Acceleration/deceleration time selection 2	<p>A pair of inputs is needed to select acceleration and deceleration times. If acceleration/deceleration time selection 2 (setting: 27) is not set at any multi-function input from n050 to n056, the Inverter will determine that the acceleration/deceleration selection 2 is set to OFF, and select the acceleration/deceleration time.</p> <p>In the same way, if acceleration/deceleration time selection 1 (setting: 11) is not set at any multi-function input, the Inverter will determine that the acceleration/deceleration selection 1 is set to OFF, and select the acceleration/deceleration time.</p> <p>See note.</p>				

Note

Selection 2	Selection 1	Acceleration/deceleration time
OFF	OFF	Acceleration time 1 (n019) Deceleration time 1 (n020)
OFF	ON	Acceleration time 2 (n021) Deceleration time 2 (n022)
ON	OFF	Acceleration time 3 (n041) Deceleration time 3 (n042)
ON	ON	Acceleration time 4 (n043) Deceleration time 4 (n044)

Parameter No.	Register No. (Hex)	Name	Description	Setting range	Default setting	Changes during operation	Memo																								
			<table border="1"> <tr> <td>28</td> <td>General - purpose input 1</td> <td rowspan="7"> The Inverter will not operate with S1 to S7 sensor input if these functions are set. They are used when you want sensors to provide SYS-MAC information via the Inverter for RS422/485 or Option Unit communications (DeviceNet). The status of S1 to S7 is constantly refreshed at register 002B regardless of the n050 to n056 settings. Multi-function input monitoring is a useful function for DeviceNet. </td> <td rowspan="7"></td> <td rowspan="7"></td> <td rowspan="7"></td> <td rowspan="7"></td> <td rowspan="7"></td> </tr> <tr> <td>29</td> <td>General - purpose input 2</td> </tr> <tr> <td>30</td> <td>General - purpose input 3</td> </tr> <tr> <td>31</td> <td>General - purpose input 4</td> </tr> <tr> <td>32</td> <td>General - purpose input 5</td> </tr> <tr> <td>33</td> <td>General - purpose input 6</td> </tr> <tr> <td>34</td> <td>Up or down command</td> <td> Up or down command (set in n056 only) By setting n056 to 34, the set value in n055 is ignored and the following setting are forcibly made. S6: Up command S7: Down command </td> </tr> <tr> <td>35</td> <td>Self-diagnostic test</td> <td>ON: RS-422/485 communications self-diagnostic test (set in n056 only)</td> </tr> </table>	28	General - purpose input 1	The Inverter will not operate with S1 to S7 sensor input if these functions are set. They are used when you want sensors to provide SYS-MAC information via the Inverter for RS422/485 or Option Unit communications (DeviceNet). The status of S1 to S7 is constantly refreshed at register 002B regardless of the n050 to n056 settings. Multi-function input monitoring is a useful function for DeviceNet.						29	General - purpose input 2	30	General - purpose input 3	31	General - purpose input 4	32	General - purpose input 5	33	General - purpose input 6	34	Up or down command	Up or down command (set in n056 only) By setting n056 to 34, the set value in n055 is ignored and the following setting are forcibly made. S6: Up command S7: Down command	35	Self-diagnostic test	ON: RS-422/485 communications self-diagnostic test (set in n056 only)				
28	General - purpose input 1	The Inverter will not operate with S1 to S7 sensor input if these functions are set. They are used when you want sensors to provide SYS-MAC information via the Inverter for RS422/485 or Option Unit communications (DeviceNet). The status of S1 to S7 is constantly refreshed at register 002B regardless of the n050 to n056 settings. Multi-function input monitoring is a useful function for DeviceNet.																													
29	General - purpose input 2																														
30	General - purpose input 3																														
31	General - purpose input 4																														
32	General - purpose input 5																														
33	General - purpose input 6																														
34	Up or down command					Up or down command (set in n056 only) By setting n056 to 34, the set value in n055 is ignored and the following setting are forcibly made. S6: Up command S7: Down command																									
35	Self-diagnostic test	ON: RS-422/485 communications self-diagnostic test (set in n056 only)																													

Note Available for 5.5- and 7.5-kW Inverters only.

Parameter No.	Register No. (Hex)	Name	Description	Setting range	Default setting	Changes during operation	Memo	
n057	0139	Multi-function output 1 (MA/MB and MC output terminals)	Used to select the functions of multi-function output terminals.		0 to 7, 10 to 19 (21 See note.)	0	No	
			Set value	Function				Description
n058	013A	Multi-function output 2 (P1-PC output terminals)	0	Fault output	ON: Fault output (with protective function working)	0 to 7, 10 to 19 (21 See note.)	1	No
			1	During RUN	ON: During RUN			
			2	Frequency agree	ON: Output frequency agree with frequency reference			
n059	013B	Multi-function output 3 (P2-PC output terminals)	3	Zero speed	ON: Zero speed (at less than min. output frequency)	0 to 7, 10 to 19 (21 See note.)	2	No
			4	Frequency detection 1	ON: Output frequency \geq frequency detection level (n095)			
			5	Frequency detection 2	ON: Output frequency \leq frequency detection level (n095)			
			6	Overtorque being monitored (NO-contact output)	Output if any of the following parameter conditions is satisfied. n096: Overtorque detection function selection 1 n097: Overtorque detection function selection 2			
7	Overtorque being monitored (NC-contact output)	n098: Overtorque detection level n099: Overtorque detection time NO contact: ON with overtorque being detected NC contact: OFF with overtorque being detected						

Parameter No.	Register No. (Hex)	Name	Description			Setting range	Default setting	Changes during operation	Memo	
n059	013B	Multi-function output 3 (P2-PC output terminals)	8	Undertorque being monitored (NO contact output)	Output if either of the following parameter conditions is satisfied. n117: Undertorque detection function selection n097: Overtorque detection function selection 2 n118: Undertorque detection level n119: Undertorque detection time Note NO contact: ON with undertorque being detected NC contact: OFF with undertorque being detected	0 to 7, 10 to 19 (21 See note.)	2	No		
			9	Undertorque being monitored (NC contact output)						
			10	Warning output						ON: Warning being detected (Nonfatal error being detected)
			11	Base block in progress						ON: Base block in progress (in operation with output turned OFF)
			12	RUN mode						ON: Local mode (with the Digital Operator)

Parameter No.	Register No. (Hex)	Name	Description	Setting range	Default setting	Changes during operation	Memo																											
			<table border="1"> <tr> <td>13</td> <td>Inverter ready</td> <td>ON: Inverter ready to operate (with no fault detected)</td> </tr> <tr> <td>14</td> <td>Fault retry</td> <td>ON: Fault retry</td> </tr> <tr> <td>15</td> <td>UV in progress</td> <td>ON: Undervoltage being monitored</td> </tr> <tr> <td>16</td> <td>Rotating in reverse direction</td> <td>ON: Rotating in reverse direction</td> </tr> <tr> <td>17</td> <td>Speed search in progress</td> <td>ON: Speed search in progress</td> </tr> <tr> <td>18</td> <td>Communications output</td> <td>ON: Turns communications output 1 ON.</td> </tr> <tr> <td>19</td> <td>PID feedback loss</td> <td>ON: PID feedback loss enabled.</td> </tr> <tr> <td>20 (See note 2.)</td> <td>Frequency reference loss</td> <td>ON: Frequency reference lost (when frequency reference loss detection in n064 is enabled, and either analog input or pulse train input is set for frequency reference selection in n004)</td> </tr> <tr> <td>21 (See note 2.)</td> <td>Inverter overheating warning oH3</td> <td>ON: Inverter overheating warning (ON when the multi-function input Inverter overheating warning signal is being input, i.e., when 0H3 is flashing.)</td> </tr> </table>	13	Inverter ready	ON: Inverter ready to operate (with no fault detected)	14	Fault retry	ON: Fault retry	15	UV in progress	ON: Undervoltage being monitored	16	Rotating in reverse direction	ON: Rotating in reverse direction	17	Speed search in progress	ON: Speed search in progress	18	Communications output	ON: Turns communications output 1 ON.	19	PID feedback loss	ON: PID feedback loss enabled.	20 (See note 2.)	Frequency reference loss	ON: Frequency reference lost (when frequency reference loss detection in n064 is enabled, and either analog input or pulse train input is set for frequency reference selection in n004)	21 (See note 2.)	Inverter overheating warning oH3	ON: Inverter overheating warning (ON when the multi-function input Inverter overheating warning signal is being input, i.e., when 0H3 is flashing.)				
13	Inverter ready	ON: Inverter ready to operate (with no fault detected)																																
14	Fault retry	ON: Fault retry																																
15	UV in progress	ON: Undervoltage being monitored																																
16	Rotating in reverse direction	ON: Rotating in reverse direction																																
17	Speed search in progress	ON: Speed search in progress																																
18	Communications output	ON: Turns communications output 1 ON.																																
19	PID feedback loss	ON: PID feedback loss enabled.																																
20 (See note 2.)	Frequency reference loss	ON: Frequency reference lost (when frequency reference loss detection in n064 is enabled, and either analog input or pulse train input is set for frequency reference selection in n004)																																
21 (See note 2.)	Inverter overheating warning oH3	ON: Inverter overheating warning (ON when the multi-function input Inverter overheating warning signal is being input, i.e., when 0H3 is flashing.)																																

Note Frequency reference loss (setting value: 20) and inverter overheating warning (setting value: 26) can be set for 5.5-kW and 7.5-kW Inverters only.

Parameter No.	Register No. (Hex)	Name	Description	Setting range	Default setting	Changes during operation	Memo
n060	013C	Frequency reference gain	Used to set the input characteristics of analog frequency references. Gain: The frequency of maximum analog input (10 V or 20 mA) in percentage based on the maximum frequency as 100%.	0 to 255	100	Yes	
n061	013D	Frequency reference bias	Bias: The frequency of minimum analog input (0 V or 0 or 4 mA) in percentage based on the maximum frequency as 100%.	-100 to 100	0	Yes	
n062	013E	Analog frequency reference filter time constant	Used to set the digital filter with a first-order lag for analog frequency references to be input.	0.00 to 2.00	0.10	Yes	
n063	---	Not used	---	---	---	---	
n064	0140	Frequency reference loss detection (See note.)	Selects the frequency loss detection function for when the frequency reference from the control circuit terminal suddenly drops. 0: Disable (Operate according to frequency reference.) 1: Enable (Continue operation at 80% of frequency reference prior to loss.) Note: Frequency reference loss: Frequency reference voltage drop of 90% within 400 ms.	0, 1	0	No	
n065	0141	Multi-function analog output type selection	Selects the multi-function analog output type. 0: Analog voltage output (functions set in n066) 1: Pulse train output (functions set in n150)	0, 1	0	No	

Note Frequency reference loss (setting value: 20) can be set for 5.5-kW and 7.5-kW Inverters only.

Parameter No.	Register No. (Hex)	Name	Description	Setting range	Default setting	Changes during operation	Memo
n066	0142	Multi-function analog output	<p>Selects the monitor item with n065 set to 0.</p> <p>0: Output frequency (with 10-V output at max. frequency)</p> <p>1: Output current (with 10-V output with Inverter rated output current)</p> <p>2: Main circuit DC voltage (with 10-V output at 400 [800] V DC)</p> <p>3: Vector operation torque monitor (with 10-V output at rated motor torque)</p> <p>4: Output power (with 10-V output at power equivalent to max. applicable motor capacity) Cannot be monitored in vector control mode.</p> <p>5: Output voltage (with 10-V output at 200 [400] V AC)</p> <p>Note Values in () apply with n067 set to 1.00.</p> <p>Note Values in [] are for 400-V models.</p>	0 to 5	0	No	
n067	0143	Multi-function analog output gain	Used to set the output characteristics of multi-function analog output.	0.00 to 2.00	1.00	Yes	
n068	0144	Multi-function analog voltage input gain	<p>Sets the input characteristics of multi-function analog voltage input.</p> <p>Gain: Sets the frequency of maximum analog input (10 V) in percentage based on the maximum frequency as 100%.</p>	-255 to 255	100	Yes	
n069	0145	Multi-function analog voltage input bias	<p>Bias: Sets the frequency of minimum analog input (0 V) in percentage based on the maximum frequency as 100%.</p>	-100 to 100	0	Yes	
n070	0146	Multi-function analog voltage input filter time constant	Sets a primary lag digital filter for multi-function analog voltage input.	0.00 to 2.00	0.10	Yes	

Parameter No.	Register No. (Hex)	Name	Description	Setting range	Default setting	Changes during operation	Memo
n071	0147	Multi-function analog current input gain	Sets the input characteristics of multi-function analog current input. Gain: Sets the frequency of maximum analog input (20 mA) in percentage based on the maximum frequency as 100%.	-255 to 255	100	Yes	
n072	0148	Multi-function analog current input bias	Bias: Sets the frequency of minimum analog input (4 mA) in percentage based on the maximum frequency as 100%.	-100 to 100	0	Yes	
n073	0149	Multi-function analog current input filter time constant	Sets a primary delay digital filter for multi-function analog current input.	0.00 to 2.00	0.10	Yes	
n074	014A	Pulse train frequency reference gain	Sets the input characteristics of pulse train input. Gain: Sets the gain in percentage based on the maximum frequency of the pulse train input scale in n149 as 100%.	0 to 255	100	Yes	
n075	014B	Pulse train frequency reference bias	Bias: Sets the bias in percentage for frequency reference input at 0-Hz pulse train input based on the maximum frequency as 100%.	-100 to 100	0	Yes	
n076	014C	Pulse train frequency reference input filter constant	Sets the pulse train input's primary-delay digital filter for frequency reference.	0.00 to 2.00	0.10	Yes	
n077	014D	Multi-function analog input terminal function selection	Selects the function allocated to the multi-function analog input terminal. 0: Disable multi-function analog input function. 1: Auxiliary frequency reference 2: Frequency gain 3: Frequency bias 4: Output voltage bias Note: When setting "3," also set the standard value for the bias in n079.	0 to 4	0	No	

Parameter No.	Register No. (Hex)	Name	Description	Setting range	Default setting	Changes during operation	Memo
n078	014E	Multi-function analog input terminal selection	Selects whether voltage input or current input is to be used. 0: Enable multi-function analog voltage input (and disable current input). 1: Enable multi-function analog current input (and disable voltage input).	0, 1	0	No	
n079	014F	Multi-function input frequency bias	When "3" is set for n077, set the standard value for the bias as a percentage, taking the maximum frequency as 100%.	0 to 50	10	No	

■ Function Group 3 (n080 through n0119)

Parameter No.	Register No. (Hex)	Name	Description	Setting range	Default setting	Changes during operation	Memo
n080	0150	Carrier frequency selection	Used to set the carrier frequency. Note The default setting does not need any changes in normal operation.	1 to 4, 7 to 9	Varies with the capacity.	No	
n081	0151	Momentary power interruption compensation	Used to specify the processing that is performed when a momentary power interruption occurs. 0: Inverter stops operating 1: Inverter continues operating if power interruption is 0.5 s or less. 2: Inverter always continues operating. 5 to 100: Power interruption recovery timer Inverter restarts after the set value (5 to 100) × 0.1 (second).	0 to 2, 5 to 100	0	No	
n082	0152	Number of fault retries	Used set the number of times that reset and restart are automatically attempted for the Inverter when the Inverter has an overvoltage fault or overcurrent fault.	0 to 10	0	No	

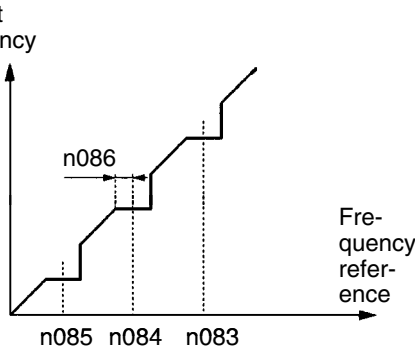
Parameter No.	Register No. (Hex)	Name	Description	Setting range	Default setting	Changes during operation	Memo
n083	0153	Jump frequency 1	<p>Used to set the frequency jump function.</p>  <p>Output frequency</p> <p>Frequency reference</p> <p>n085 n084 n083</p> <p>n086</p>	0.00 to 400.0	0.00	No	
n084	0154	Jump frequency 2		0.00 to 400.0	0.00	No	
n085	0155	Jump frequency 3		0.00 to 400.0	0.00	No	
n086	0156	Jump width		<p>Note Set n083 to n085 to satisfy the following condition. $n083 \geq n084 \geq n085$</p>	0.00 to 25.50	0.00	No
n087	0157	Accumulated operating time function selection (See note.)	<p>Selects the operating status to be accumulated.</p> <p>0: Accumulate the time that the Inverter power is ON (i.e., the time from when the power is turned ON until it is shut OFF).</p> <p>1: Accumulate Inverter execution time (i.e., the time that forward or reverse signals are being input).</p>	0, 1	0	No	
n088	0158	Accumulated operating time (See note.)	<p>Sets the initial value for the accumulated operating time, with 10 h as 1.</p> <p>The accumulation begins from the set time. The accumulated operating time's monitor value (U-13) can be cleared to 0 by setting "0" here.</p>	0 to 6,550	0	No	

Note Accumulated operating time can be selected with 5.5-kW and 7.5-kW Inverters only.

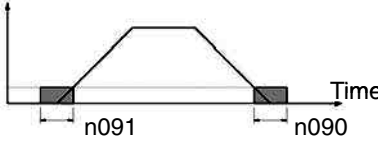
Parameter No.	Register No. (Hex)	Name	Description	Setting range	Default setting	Changes during operation	Memo
n089	0159	DC injection braking current	<p>Used to impose DC on the induction motor for braking control.</p> <p>Sets the DC braking current as a percentage based on the rated current of the Inverter as 100%.</p>	0 to 100	50	No	
n090	015A	DC injection braking-to-stop time	<p>Output frequency</p>  <p>Minimum output frequency (n016)</p> <p>n091 n090</p>	0.0 to 25.5	0.5	No	
n091	015B	Startup DC injection braking time		0.0 to 25.5	0.0	No	

Parameter No.	Register No. (Hex)	Name	Description	Setting range	Default setting	Changes during operation	Memo
n092	015C	Stall prevention during deceleration	Used to select a function to change the deceleration time of the motor automatically so that there will be no overvoltage imposed on the motor during deceleration. 0: Stall prevention during deceleration enabled 1: Stall prevention during deceleration disabled Note Be sure to set the parameter to 1 when the Braking Resistor Unit or a braking resistor is used as an option.	0, 1	0	No	
n093	015D	Stall prevention level during acceleration	Used to select a function to stop the acceleration of the motor automatically for stall prevention during acceleration. Sets the level as a percentage based on the rated current of the Inverter as 100%.	30 to 200	170	No	
n094	015E	Stall prevention level during operation	Used to select a function to reduce the output frequency of the Inverter automatically for stall prevention during operation. Sets the level as a percentage based on the rated current of the Inverter as 100%.	30 to 200	160	No	
n095	015F	Frequency detection level	Used to set the frequency to be detected. Note The parameter n059 for multi-function output must be set for the output of frequency detection levels 1 and 2.	0.00 to 400.0	0.00	No	
n096	0160	Overtorque detection function selection 1	Used to enable or disable overtorque detection and select the processing method after overtorque detection. 0: Overtorque detection disabled 1: Overtorque detection only when speed coincides and operation continues (issues alarm) 2: Overtorque detection only when speed coincides and output turned OFF (for protection) 3: Overtorque always detected and operation continues (issues alarm) 4: Overtorque always detected and output turned OFF (for protection)	0 to 4	0	No	
n097	0161	Overtorque detection function selection 2	Select the item to detect overtorque. 0: Detected from output torque. 1: Detected from output current.	0, 1	0	No	

Parameter No.	Register No. (Hex)	Name	Description	Setting range	Default setting	Changes during operation	Memo
n098	0162	Overtorque detection level	Used to set overtorque detection level. Detection from output torque: Set as a percentage based on the rated motor torque as 100%. Detection from output current: Set as a percentage based on the rated Inverter output current as 100%.	30 to 200	160	No	
n099	0163	Overtorque detection time	Used to set the detection time of overtorque.	0.1 to 10.0	0.1	No	
n100	0164	UP/DOWN frequency memory	Used to store the adjusted frequency reference with the UP/DOWN function. 0: Frequency not stored 1: Frequency stored The frequency must be on hold for 5 s or more.	0, 1	0	No	
n101	0165	Speed search deceleration time (See note.)	Sets the speed search deceleration time as the time required to go from 100% to 0% of the maximum frequency. This is a constant for adjusting the speed search function. If "0.0" is set, the Inverter will operate at the default time of 2.0 seconds.	0.0 to 10.0	2.0	No	
n102	0166	Speed search operating level (See note.)	Sets the speed search operating level as a percentage, taking the Inverter's rated output current as 100%. This is a constant for adjusting the speed search function. If the Inverter output current falls below the set value, the speed search will be judged as completed and acceleration will begin again.	0 to 200	150	No	
n103	0167	Torque compensation gain	Used to set the gain of the torque compensation function. Note The default setting does not need any changes in normal operation.	0.0 to 2.5	1.0	Yes	
n104	0168	Torque compensation primary delay time constant	Sets the response speed of the torque compensation function. Note Normally, the default setting does not need to be changed.	0.0 to 25.5	0.3	No	

Parameter No.	Register No. (Hex)	Name	Description	Setting range	Default setting	Changes during operation	Memo
n105	0169	Torque compensation core loss	Sets the core loss of the motor in use. Note Normally, the default setting does not need to be changed. Note This parameter is enabled in V/f control mode only.	0.0 to 6,550	Varies with the capacity.	No	
n106	016A	Rated motor slip	Used to set the rated slip value of the motor in use. Note Used as the constant of the slip compensation function or vector control.	0.0 to 20.0	Varies with the capacity.	Yes	

Note Speed search deceleration time and speed search operating level can be set for 5.5-kW and 7.5-kW Inverters only.

Parameter No.	Register No. (Hex)	Name	Description	Setting range	Default setting	Changes during operation	Memo
n107	016B	Motor phase-to-neutral resistance	Set this parameter to the phase-to-neutral resistance or 1/2 of the phase-to-phase resistance of the motor. Note This parameter is used as a vector control constant.	0.000 to 65.50	Varies with the capacity	No	
n108	016C	Motor leakage inductance	Sets the leakage inductance of the motor in use. Note This parameter is used as a vector control constant. Note The Inverter with the default setting in this parameter fully functions in vector control.	0.00 to 655.0	Varies with the capacity.	No	
n109	016D	Torque compensation limit	Sets a limit on the torque compensation function in vector control mode. Note Normally, the default setting does not need to be changed. Note The Inverter in torque compensation control limits the torque at a current 1.5 times larger than the set value.	0 to 250	150	No	
n110	016E	Motor no-load current	Used to set the no-load current of the motor in use based on the rated motor current as 100%. Note Used as the constant of vector control and the slip compensation function.	0 to 99	Varies with the capacity	No	

Parameter No.	Register No. (Hex)	Name	Description	Setting range	Default setting	Changes during operation	Memo
n111	016F	Slip compensation gain	Used to set the gain of the slip compensation function. Note The default is set to 1.0 in vector control mode. Note The slip compensation function is disabled with n111 set to 0.0.	0.0 to 2.5	0.0	Yes	
n112	0170	Slip compensation primary delay time	Used for the response speed of the slip compensation function. Note The default is set to 0.2 in vector control mode. Note The default setting does not need any changes in normal operation.	0.0 to 25.5	2.0	No	
n113	0171	Slip compensation during regeneration	Selects the slip compensation function in regenerative operation. 0: Disabled 1: Enabled Note This parameter is valid only in vector control mode.	0, 1	0	No	
n114		Not used	---	---	---	---	
n115	0173	Stall prevention level automatic suppression selection	Selects whether or not to automatically decrease the level for stall prevention during operation if the frequency lies in a constant output range exceeding the frequency set in n013 for max. voltage frequency (a range greater than the rated motor frequency). 0: Automatic suppression function disabled (the value of n094 is valid for any frequency) 1: Automatic suppression function enabled. Note The operation level is decreased by $n094 \times (\text{max. voltage frequency/output frequency})$. Note The stall prevention function during operation operates according to the acceleration/deceleration time set in n116.	0, 1	0	No	

Parameter No.	Register No. (Hex)	Name	Description	Setting range	Default setting	Changes during operation	Memo
n116	0174	Stall prevention acceleration/deceleration time setting	<p>Sets the acceleration/deceleration time for the stall prevention function during operation.</p> <p>0: Accelerates or decelerates according to acceleration/deceleration time 1 or 2, whichever is selected.</p> <p>1: Accelerates or decelerates according to acceleration/deceleration time 2. (n021/n022).</p> <p>Note When a faster (or slower) acceleration/deceleration time is desired, set this parameter to “1” and set the desired acceleration/deceleration time for stall prevention operation in acceleration/deceleration time 2.</p>	0, 1	0	No	
n117	0175	Undertorque detection function selection	<p>Sets the undertorque detection function.</p> <p>0: Undertorque detection disabled.</p> <p>1: Undertorque detection only when speed coincides and operation continues (issues alarm).</p> <p>2: Undertorque detection only when speed coincides and output turned OFF (for protection).</p> <p>3: Undertorque always detected and operation continues (issues alarm).</p> <p>4: Undertorque always detected and output turned OFF (for protection)</p>	0 to 4	0	No	
n118	0176	Undertorque detection level	Sets the detection level for undertorque detection.	0 to 200	10%	No	
n119	0177	Undertorque detection time	Sets the detection time for undertorque detection.	0.1 to 10.0 (s)	0.1 s	No	

■ Function Group 4 (n120 through n179)

Parameter No.	Register No. (Hex)	Name	Description	Setting range	Default setting	Changes during operation	Memo
n120	0178	Frequency reference 9	Sets the internal frequency references. Note These frequency references are selected with multi-step speed references (multi-function inputs).	0.00 Hz to max.	0.00	Yes	
n121	0179	Frequency reference 10			0.00	Yes	
n122	017A	Frequency reference 11			0.00	Yes	
n123	017B	Frequency reference 12			0.00	Yes	
n124	017C	Frequency reference 13			0.00	Yes	
n125	017D	Frequency reference 14			0.00	Yes	
n126	017E	Frequency reference 15			0.00	Yes	
n127	017F	Frequency reference 16			0.00	Yes	
n128	0180	PID control selection	Selects the PID control method. 0: PID control disabled. 1 to 8: PID control enabled. Note The derivative control method (i.e., the derivative control of the deviation or detected value), the addition of the frequency reference, and the positive or negative characteristics of PID control are selectable.	0 to 8	0	No	
n129	0181	Feedback value adjustment gain	Sets the value by which the feedback value is multiplied. Note This parameter is used for adjusting the target and detected values so that they will have the same input level.	0.00 to 10.00	1.00	Yes	
n130	0182	Proportional (P) gain	Sets the proportional (P) gain for PID control. Note PID control is disabled with this parameter set to 0.0.	0.0 to 25.0	1.0	Yes	
n131	0183	Integral (I) time	Sets the integral (I) time for PID control. Note Integral control is disabled with this parameter set to 0.0.	0.0 to 360.0	1.0	Yes	
n132	0184	Derivative (D) time	Sets the derivative (D) time for PID control. Note Derivative control is disabled with this parameter set to 0.0.	0.00 to 2.50	0.00	Yes	

Parameter No.	Register No. (Hex)	Name	Description	Setting range	Default setting	Changes during operation	Memo
n133	0185	PID offset adjustment	This parameter is for the offset adjustment of all PID control. Sets the parameter as a percentage based on the maximum frequency as 100%.	-100 to 100	0	Yes	
n134	0186	Integral (I) upper limit	Sets the upper limit value of integral control output. Sets the parameter as a percentage based on the maximum frequency as 100%.	0 to 100	100	Yes	
n135	0187	PID primary delay time	Set this parameter to the primary delay time constant for the frequency reference after PID control. Note Normally, the default setting does not need to be changed.	0.0 to 10.0	0.0	Yes	
n136	0188	Feedback loss detection selection	Sets the detection method of feedback loss in PID control. 0: Feedback loss detection disabled. 1: Feedback loss detection enabled (Nonfatal error: FbL warning) 2: Feedback loss detection enabled (Fatal error: FbL fault)	0 to 2	0	No	
n137	0189	Feedback loss detection level	Sets the detection level of feedback loss. Sets the parameter as a percentage based on the feedback value equivalent to the maximum frequency as 100%.	0 to 100	0	No	
n138	018A	Feedback loss detection time	Sets the detection time of feedback loss. Note If the detection level set in n137 or lower is detected for the set time in n138, the result will be determined as feedback loss.	0.0 to 25.5	1.0	No	
n139	018B	Energy-saving control selection	Select the energy-saving control function. 0: Disabled 1: Enabled Note This parameter is enabled in V/f control mode only.	0, 1	0	No	

Parameter No.	Register No. (Hex)	Name	Description	Setting range	Default setting	Changes during operation	Memo
n140	018C	Energy-saving control coefficient K2	Sets the coefficient for the primary level of energy-saving control. Note The constant automatically changes according to the motor code in n158. Make fine adjustments of the contact if necessary after setting the motor code in n158.	0.0 to 6,550	Varies with the capacity	No	
n141	018D	Energy-saving voltage lower limit at 60-Hz output	These parameters prevent the output voltage of the Inverter from dropping excessively so that the motor will not stall or come to a stop at the primary level of energy-saving control.	0 to 120	50	No	
n142	018E	Energy-saving voltage lower limit at 6-Hz output	Sets the lower limit of output voltage as a percentage at each frequency based on the rated motor voltage as 100%. Note Normally, the default settings do not need to be changed.	0 to 25	12	No	
n143	018F	Power averaging time	Sets the time required to calculate the average of power used in energy-saving control. Power averaging time (ms) = Set value x 24 (ms) Note Normally, the default setting does not need to be changed.	1 to 200	1	No	
n144	0190	Probe operation voltage limit	Sets the range of voltage control for the secondary level of energy-saving control. Sets the parameter as a percentage based on the rated motor voltage as 100%. Note No probe operation is available with the parameter set to 0.	0 to 100	0	No	
n145	0191	Probe operation control voltage step at 100%	Sets the range of probe operation voltage as a percentage based on the rated motor voltage as 100%. Note Normally, the default setting does not need to be changed.	0.1 to 10.0	0.5	No	
n146	0192	Probe operation control voltage step at 5%		0.1 to 10.0	0.2	No	
n147	---	Not used	---	---	---	---	
n148							

Parameter No.	Register No. (Hex)	Name	Description	Setting range	Default setting	Changes during operation	Memo
n149	0195	Pulse train input scale	<p>Set this parameter to the pulse train input scale so that frequency references can be executed by pulse train input.</p> <p>Set the maximum pulse train frequency in 10-Hz increments based on 10 Hz as 1.</p> <p>Note This parameter is enabled with n004 for frequency reference selection set to 5.</p>	100 to 3,300	2,500	No	
n150	0196	Multi-function analog output, pulse train frequency selection.	<p>Select the relationship between the pulse train output frequency and output frequency.</p> <p>0: 1,440 Hz at max. frequency (A proportional relationship is applied to frequencies less than the maximum frequency)</p> <p>1: 1x output frequency</p> <p>6: 6x output frequency</p> <p>12: 12x output frequency</p> <p>24: 24x output frequency</p> <p>36: 36x output frequency</p> <p>Note This parameter is enabled with n065 set to 1.</p>	0, 1, 6, 12, 24, 36	0	No	
n151	0197	RS-422/485 communications time-over detection selection	<p>The set value in the parameter determines whether communications time-over detection will be performed with "CE" displayed if there is an interval of more than 2 s between normal communications and how the detected communications time-over will be processed.</p> <p>0: Detects time-over, fatal error, and the Inverter coasts to a stop.</p> <p>1: Detects time-over, detects fatal error, and the Inverter decelerates to a stop in deceleration time 1.</p> <p>2: Detects time-over, detects fatal error, and the Inverter decelerates to a stop in deceleration time 2.</p> <p>3: Detects time-over, detects nonfatal error warning, and the Inverter continues operating.</p> <p>4: No time-over is detected.</p>	0 to 4	0	No	

Parameter No.	Register No. (Hex)	Name	Description	Setting range	Default setting	Changes during operation	Memo
n152	0198	RS-422/485 communications frequency reference/display unit selection	Sets the unit of frequency reference and frequency-related values to be set or monitored through communications. 0: 0.1 Hz 1: 0.01 Hz 2: Converted value based on 30,000 as max. frequency 3: 0.1% (Max. frequency: 100%)	0 to 3	0	No	
n153	0199	RS-422/485 communications Slave address	Set this parameter to the Slave address (Slave unit number) for communications. 00: Broadcast message (with the communications function disabled) 01 to 32: Slave address	00 to 32	00	No	
n154	019A	RS-422/485 baud rate selection	Select the communications baud rate. 0: 2,400 bps 1: 4,800 bps 2: 9,600 bps 3: 19,200 bps	0 to 3	2	No	
n155	019B	RS-422/485 parity selection	Select the parity check function for communications data. 0: Even 1: Odd 2: No parity	0 to 2	0	No	
n156	019C	RS-422/485 send wait time	Sets the time to wait for a response after the DSR (data-send-request) message is received from the Master.	10 to 65	10	No	
n157	019D	RS-422/485 RTS control selection	Select whether or not to enable the RTS (request-to-send) communications control function. 0: RTS control enabled 1: RTS control disabled (available to 1-to-1 RS-422 communications only)	0, 1	0	No	
n158	019E	Motor code	Sets the code to automatically set the constants for energy-saving control. 0 to 10: 200-V AC, 0.1- to 4.0-kW motor 20 to 30: 400-V AC, 0.1- to 4.0-kW motor	0 to 70	Varies with the capacity.	No	

Parameter No.	Register No. (Hex)	Name	Description	Setting range	Default setting	Changes during operation	Memo
n159	019F	Energy-saving voltage upper limit at 60-Hz output	These parameters prevent the motor from over excitation due to voltage changes during energy-saving control.	0 to 120	120	No	
n160	01A0	Energy-saving upper limit voltage at 6-Hz output	Sets the upper limit of output voltage as a percentage at each frequency based on the rated motor voltage as 100%. Note Normally, the default settings do not need to be changed.	0 to 25	16	No	
n161	01A1	Power detection width for probe operation switching	Sets the detection width of power that sets the Inverter into probe operation. Sets the width as a percentage based on the power to be detected as 100%. Note Normally, the default setting does not need to be changed. Note The Inverter will operate with a power detection width of 10% if the value is set to 0.	0 to 100	10	No	
n162	01A2	Power detection filter constant	Sets the filter time constant of the power detection block of the Inverter operating in probe operation. Filter time constant (ms) = Set value in n162 x 4 (ms) Note Normally, the default setting does not need to be changed. Note The Inverter will operate with a time constant of 20 ms if the value is set to 0.	0 to 255	5	No	
n163	01A3	PID output gain	Sets the rate by which PID control value is multiplied for PID control. Note Normally, the default setting does not need to be changed.	0.0 to 25.0	1.0	No	

Parameter No.	Register No. (Hex)	Name	Description	Setting range	Default setting	Changes during operation	Memo
n164	01A4	PID feedback input block selection	<p>Sets the feedback input block for PID control detection.</p> <p>0: Frequency reference control terminal for voltage input (0 to 10 V) is enabled.</p> <p>1: Frequency reference control terminal for current input (4 to 20 mA) is enabled.</p> <p>2: Frequency reference control terminal for current input (0 to 20 mA) is enabled.</p> <p>3: Multi-function analog voltage input (0 to 10 V) is enabled.</p> <p>4: Multi-function analog current input (4 to 20 mA) is enabled.</p> <p>5: Pulse train reference control terminal is enabled.</p> <p>Note Make sure that the target value input and feedback value input do not overlap with each other.</p>	0 to 5	0	No	
n165	---	Not used	---	---	---	---	
n166	01A6	Input open-phase detection level (See note 1.)	<p>Sets the main circuit DC voltage fluctuation level, as a percentage, for detecting an input open phase.</p> <p>200-V-class Inverters: Set 400 V as 100%.</p> <p>400-V-class Inverters: Set 800 V as 100%.</p> <p>If "0" is set, the input open-phase detection function will be disabled.</p> <p>Recommended setting: 7 (%)</p>	0 to 100	0	No	
n167	01A7	Input open-phase detection time (See note 1.)	<p>Sets the input open-phase detection time in units of seconds.</p> <p>If "0" is set, the input open-phase detection function will be disabled.</p> <p>Recommended setting: 10 (s)</p>	0 to 255	0	No	
n168	01A8	Output open-phase detection level (See note 1.)	<p>Sets as a percentage the current for detecting an output open phase, taking the Inverter's rated output current as 100%.</p> <p>If "0" is set, the output open-phase detection function will be disabled.</p> <p>Recommended setting: 5 (%)</p>	0 to 100	0	No	

Parameter No.	Register No. (Hex)	Name	Description	Setting range	Default setting	Changes during operation	Memo
n169	01A9	Output open-phase detection time (See note 1.)	Sets the output open-phase detection time in units of seconds. If "0" is set, the output open-phase detection function will be disabled. Recommended setting: 0.2 (s)	0.0 to 2.0	0.0	No	
n170	---	Enter command (Save to EEPROM) receive condition (DeviceNet and RS-422A/485 communications)	0: Disable Enter command reception during operations 1: Always enable Enter command reception	0, 1	0	No	
n171 to n174	---	Not used	---	---	---	---	
n175	01AF	Low-speed carrier frequency reduction selection	This function automatically reduces the carrier frequency to 2.5 kHz if the output frequency is 5 kHz or less, and the output current is 110% or greater than the rated Inverter current. Normally this setting is not necessary. This function improves the overload capacity at low frequencies. 0: Disables low-speed carrier frequency reduction. 1: Enables low-speed carrier frequency reduction. Note Normally, it is not necessary to change the default setting. Note This function is enabled if n080 (carrier frequency) is set to 2, 3, or 4.	0, 1	0 (See note 2.)	No	

Note 1. Available for 5.5-kW and 7.5-kW Inverters only.

Note 2. The default setting for 5.5-kW and 7.5-kW Inverters is "1."

Parameter No.	Register No. (Hex)	Name	Description	Setting range	Default setting	Changes during operation	Memo
n176	01B0 (See note.)	Parameter copy and verify function selection	<p>Selects the function to read, copy, and verify the parameter between the memory of the Inverter and that of the Digital Operator.</p> <p>rdy: Ready to accept the next command.</p> <p>rEd: Reads the Inverter parameter.</p> <p>Cpy: Copies the parameter to the Inverter.</p> <p>vFy: Verifies the Inverter parameter.</p> <p>vA: Checks the Inverter capacity display.</p> <p>Sno: Checks the software number.</p>	rdy to Sno	rdy	No	
n177	01B1 (See note.)	Parameter read prohibit selection	<p>Select the copy-prohibit function.</p> <p>Set this parameter to store the data in the EEPROM of the Digital Operator.</p> <p>0: Read prohibited for Inverter parameters (data cannot be stored in EEPROM).</p> <p>1: Read possible for Inverter parameters (data can be stored in EEPROM).</p>	0, 1	0	No	
n178	01B2	Fault log	<p>Used to display the four most recent fault recorded.</p> <div style="text-align: center;"> </div> <p>Note The most recent fault is indicated by "1."</p> <p>Note This parameter is monitored only.</p>	---	---	---	
n179	01B3	Software number	<p>Used to display the software number of the Inverter for OMRON's control reference use.</p> <p>Note This parameter is monitored only.</p>	---	---	---	

Note Parameters for register numbers 01B0 and 01B1 cannot be written from RS-422/485 communications or the Option Unit. These parameters are read-only.

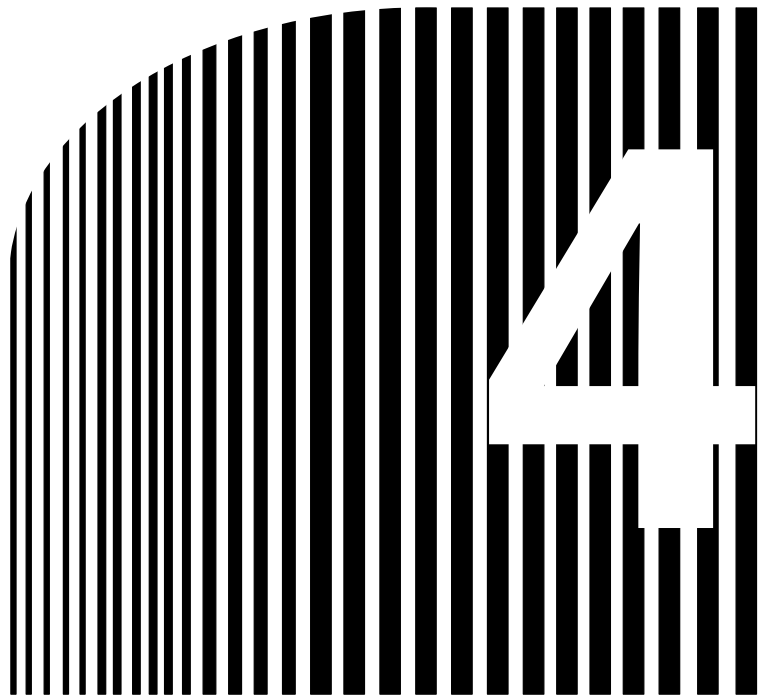

Chapter 4

- **Maintenance
Operations** .

4-1 Protective and Diagnostic Functions

4-1 Protective and Diagnostic Functions

4-1-1 Fault Detection (Fatal Errors)

The Inverter will detect the following faults if the Inverter or motor burns or the internal circuitry of the Inverter malfunctions. When the Inverter detects a fault, the fault code will be displayed on the Digital Operator, the fault contact output will operate, and the Inverter output will be shut off causing the motor to coast to a stop. The stopping method can be selected for some faults, and the selected stopping method will be used with these faults. If a fault has occurred, refer to the following table to identify and correct the cause of the fault. Use one of the following methods to reset the fault after restarting the Inverter. If the operation command is being input, however, the reset signal will be ignored. Therefore, be sure to reset the fault with the operation command turned OFF.

- Turn ON the fault reset signal. A multi-function input (n050 to n056) must be set to 5 (Fault Reset).
- Press the STOP/RESET Key on the Digital Operator.
- Turn the main circuit power supply OFF and then ON again.

■ Fault Displays and Processing

Fault display	Fault name and meaning	Probable cause and remedy
$\alpha\bar{L}$	<p>Overcurrent (OC) The Inverter output current is as high as or higher than 250% of the rated output current.</p>	<ul style="list-style-type: none"> • A short-circuit or ground fault has occurred and at the Inverter output. → Check and correct the motor power cable. • The V/f setting is incorrect. → Reduce the V/f set voltage. • The motor capacity is too large for the Inverter. → Reduce the motor capacity to the maximum applicable motor capacity. • The magnetic contactor on the output side of the Inverter has been opened and closed. → Rearrange the sequence so that the magnetic contactor will not open or close while the Inverter has current output. • The output circuit of the Inverter is damaged. → Replace the Inverter.

Fault display	Fault name and meaning	Probable cause and remedy
OV	<p>Overvoltage (OV) The main circuit DC voltage has reached the overvoltage detection level (410 V DC for 200-V Inverters, 820 V DC for 400-V Inverters)</p>	<ul style="list-style-type: none"> • There is excessive regenerative energy with no braking resistor or Braking Resistor Unit connected. → Connect the Braking Resistor Unit or a braking resistor. → Increase the deceleration time. • The regenerative energy has not been processed though a braking resistor or Braking Resistor Unit. → Set n092 for stall prevention during deceleration to 1 (disable) • The braking resistor or Braking Resistor Unit is not wired properly. → Check and correct the wiring. • The power supply voltage is too high. → Decrease the voltage so it will be within specifications. • There is excessive regenerative energy due to overshooting at the time of acceleration. → Suppress the overshooting as much as possible. • The braking transistor is damaged. → Change the Inverter.
UV1	<p>Main circuit undervoltage (UV1) The main circuit DC voltage has reached the undervoltage detection level (200 V DC for the 3G3MV-A2□, 160 V DC for the 3G3MV-AB□, and 400 V DC for the 3G3MV-A4□).</p>	<ul style="list-style-type: none"> • Power supply to the Inverter has phase loss, power input terminal screws are loose, or the power cable is disconnected. → Check the above and take necessary countermeasures. • Incorrect power supply voltage → Make sure that the power supply voltage is within specifications. • Momentary power interruption has occurred. → Use the momentary power interruption compensation (Set n081 so that the Inverter restarts after power is restored) → Improve the power supply. • The internal circuitry of the Inverter is damaged. → Change the Inverter.
UV2	<p>Control power supply undervoltage (UV2) The control power supply voltage has reached the undervoltage detection level.</p>	<ul style="list-style-type: none"> • Internal circuit fault. → Turn the Inverter OFF and ON. → Change the Inverter if the same fault occurs again.

Fault display	Fault name and meaning	Probable cause and remedy
oH	<p>Radiation fin overheated (OH) The temperature of the radiation fins of the Inverter has reached $110^{\circ}\text{C} \pm 10^{\circ}\text{C}$.</p>	<ul style="list-style-type: none"> • The ambient temperature is too high. → Ventilate the Inverter or install a cooling unit. • The load is excessive. → Reduce the load. → Change the inverter to one with a higher capacity. • The V/f setting is incorrect. → Reduce the V/f set voltage. • The acceleration/deceleration time is too short. → Increase the acceleration/deceleration time. • The ventilation is obstructed. → Change the location of the Inverter to meet the installation conditions. • The cooling fan of the Inverter does not work. → Replace the cooling fan.
oL1	<p>Motor overload (OL1) The electric thermal relay actuated the motor overload protective function. Calculate the heat radiation of the motor from the output current of the Inverter based on the rated motor current (n036), motor protection characteristics (n037), and motor protective time setting (n038).</p>	<ul style="list-style-type: none"> • The load is excessive. → Reduce the load. → Increase the motor capacity. • The V/f setting is incorrect. → Reduce the V/f set voltage. • The value in n013 for maximum voltage frequency is low. → Check the motor nameplate and set n013 to the rated frequency. • The acceleration/deceleration time is too short. → Increase the acceleration/deceleration time. • The value in n036 for rated motor current is incorrect. → Check the motor nameplate and set n036 to the rated current. • The Inverter is driving more than one motor. → Disable the motor overload protective function and install an electronic thermal relay for each of the motors. The motor overload protective function is disabled by setting n036 to 0.0 or n037 to 2. • The motor protective time setting in n038 is short. → Set n038 to 8 (the default value).
oL2	<p>Inverter overload (OL2) The electronic thermal relay has actuated the Inverter overload protective function.</p>	<ul style="list-style-type: none"> • The load is excessive. → Reduce the load. • The V/f setting is incorrect. → Reduce the V/f set voltage. • The acceleration/deceleration time is too short. → Increase the acceleration/deceleration time. • The Inverter capacity is insufficient. → Use an Inverter model with a higher capacity.

Fault display	Fault name and meaning	Probable cause and remedy
OL3	<p>Overtorque detection (OL3) There has been a current or torque the same as or greater than the setting in n098 for overtorque detection level and that in n099 for overtorque detection time. A fault has been detected with n096 for overtorque detection function selection set to 2 or 4.</p>	<ul style="list-style-type: none"> • The mechanical system is locked or has a failure. → Check the mechanical system and correct the cause of overtorque. • The parameter settings were incorrect. → Adjust the n098 and n099 parameters according to the mechanical system. Increase the set values in n098 and n099.
EF□	<p>External fault □ (EF□) An external fault has been input from a multi-function input. A multi-function input 1 to 7 set to 3 or 4 has operated. The EF number indicates the number of the corresponding input (S1 to S7).</p>	<ul style="list-style-type: none"> • An external fault was input from a multi-function input. → Remove the cause of the external fault. • The sequence is incorrect. → Check and change the external fault input sequence including the input timing and NO or NC contact.
F00	<p>Digital Operator transmission fault 1 (F00) No communications were possible with the Digital Operator for 5 s or more after the Inverter had been turned ON.</p>	<ul style="list-style-type: none"> • The Digital Operator may not be mounted properly. → Turn OFF the Inverter, dismount and mount the Digital Operator, and turn ON the Inverter. • The Digital Operator has a failure. → Change the Digital Operator. • The Inverter has a failure. → Change the Inverter.
F01	<p>Digital Operator transmission fault 2 (F01) A transmission fault continued for 5 s or more after communications with the Digital Operator had failed.</p>	<ul style="list-style-type: none"> • The Digital Operator may not be mounted properly. → Turn OFF the Inverter, dismount and mount the Digital Operator, and turn ON the Inverter. • The Digital Operator has a failure. → Change the Digital Operator. • The Inverter has a failure. → Change the Inverter.
F04	<p>Initial memory fault (F04) An error in the built-in EEPROM of the Inverter has been detected.</p>	<ul style="list-style-type: none"> • The internal circuitry of the Inverter has a fault. → Initialize the Inverter with n001 set to 8, 9, 10, or 11 and turn the Inverter OFF and ON. → Replace the Inverter if the same fault occurs again.
F05	<p>Analog-to-digital converter fault (F05) An analog-to-digital converter fault has been detected.</p>	<ul style="list-style-type: none"> • The internal circuitry of the Inverter has a fault. → Turn the Inverter OFF and ON. → Replace the Inverter if the same fault occurs again.
F06	<p>Option Unit fault (F06) An Option Unit fault was detected. The Inverter will detect this error if the output or verify signal of the Unit has a fault.</p>	<ul style="list-style-type: none"> • The Option Unit may not be connected properly. → Turn OFF the Inverter, dismount and mount the Option Unit or attachment, and turn ON the Inverter. • The Option Unit has a failure. → Change the Option Unit. • The attachment has a failure. → Change the attachment.

Fault display	Fault name and meaning	Probable cause and remedy
F07	<p>Digital Operator fault (F07) An error in the built-in control circuit of the Digital Operator has been detected. The EEPROM of the Digital Operator or the analog-to-digital converter has a failure.</p>	<ul style="list-style-type: none"> • The internal circuitry of the Digital Operator has a fault. → Turn the Digital Operator OFF and ON. → Replace the Digital Operator if the same fault occurs again.
F21	<p>Option Unit Self-diagnostic fault (F21) The Option Unit fails to start initializing 2 seconds after power is turned ON.</p>	<ul style="list-style-type: none"> • The Option Unit power may not be ON. → Check to see if the connectors are properly connected. • The Option Unit has malfunctioned. → Replace the Option Unit.
F22	<p>Option Unit Model Code fault (F22) The Option Unit stopped while trying to identify the Inverter during communications initialization.</p>	<ul style="list-style-type: none"> • The Option Unit may not be compatible with the Inverter. → Replace with the correct Option Unit. • Connectors may not be properly connected. → Check to see if the connectors are properly connected. • The Option Unit has malfunctioned. → Replace the Option Unit.
F23	<p>Option Unit Cross-diagnostic fault (F23)</p>	<ul style="list-style-type: none"> • Check to see if the connector is properly connected to the casing. • Check to see if the frame ground wire for the Option Unit is properly connected. • Take appropriate noise countermeasures.
OPr	<p>Digital Operator connection error (OPR) The Inverter will detect this error if n010 for Digital Operator connection error processing selection is set to 1.</p>	<ul style="list-style-type: none"> • The Digital Operator may not be mounted properly. → Turn OFF the Inverter, dismount and mount the Digital Operator, and turn ON the Inverter.

Fault display	Fault name and meaning	Probable cause and remedy
<p><i>CE</i></p>	<p>Communications time-over (CE) Normal RS-422/485 communications were not established within 2 s. The Inverter will detect this error if n151 for RS-422/485 communications time over detection selection is set to 0, 1, or 2.</p>	<ul style="list-style-type: none"> • A short-circuit, ground fault, or disconnection has occurred on the communications line. → Check and correct the line. • The termination resistance setting is incorrect. → In the case of RS-422 communications, set pin 1 of SW2 of all Inverters to ON. In the case of RS-485 communications, set pin 1 of SW2 of only the Inverter located at each end of the network to ON. • Noise influence. → Do not wire the communications line along with power lines in the same conduit. → Use the twisted-pair shielded wire for the communications line, and ground it at the Master. • Master's program error. → Check and correct the program so that communications will be performed more than once every 2-s period. • Communications circuit damage. → If the same error is detected as a result of a self-diagnostic test, change the Inverter.
<p><i>STP</i></p>	<p>Emergency stop (STP) An emergency stop alarm is input to a multi-function input. (A multi-function input from 1 to 7 that was set to 19 or 21 has operated.)</p>	<ul style="list-style-type: none"> • An emergency stop alarm is input. → Remove the cause of the fault. • The sequence is incorrect. → Check and change the external fault input sequence including the input timing and NO or NC contact.
<p><i>FbL</i></p>	<p>Feedback loss fault (FbL) A feedback input was interrupted during PID control execution. (This fault is detected when an input level below the feedback loss detection level set in n137 persists for longer than the feedback loss detection time set in n138.)</p>	<ul style="list-style-type: none"> • Feedback wiring error. → Check for and correct any cable disconnection or faulty wiring. • Feedback sensor error → Check sensor status and replace any defective sensors. • PID target value input error or feedback loss detection setting error → Correct the target value input so that it is outside of the feedback loss detection range. Correct the feedback loss detection parameter settings (n137, n138). • Feedback input circuit error → Replace the Inverter.

Fault display	Fault name and meaning	Probable cause and remedy
PF (See note.)	<p>Main circuit voltage fault (PF)</p> <p>The main circuit DC voltage has oscillated erroneously when regeneration was not being performed.</p> <p>This fault is detected when a voltage fluctuation greater than the input open-phase detection level set in n166 persists for longer than the input open-phase detection time set in n167.</p>	<ul style="list-style-type: none"> • Momentary power failure. <ul style="list-style-type: none"> → Either apply countermeasures against momentary power failures or disable the input open-phase detection. • Input power supply open phase. <ul style="list-style-type: none"> → Check for and correct any main circuit power supply disconnections or faulty wiring. • Excessive input power supply voltage fluctuation or bad line voltage balance. <ul style="list-style-type: none"> → Check the power supply voltage. Apply measures to stabilize the power supply, or disable the input open-phase detection. • Main circuit capacitor failure. <ul style="list-style-type: none"> → If this fault is occurring frequently and there is no error at the power supply, replace the Inverter or disable the input open-phase detection. (Also check the usage time with the accumulated operating time function.)
LF (See note.)	<p>Output open-phase fault (LF)</p> <p>An open phase has occurred at the Inverter's output.</p> <p>This fault is detected when a current in any of the Inverter output phases less than the output open-phase detection level set in n168 persists for longer than the output open-phase detection time set in n169.</p>	<ul style="list-style-type: none"> • Output cable is disconnected. <ul style="list-style-type: none"> → Check for and correct any output cable disconnections or faulty wiring. • Motor winding disconnected. <ul style="list-style-type: none"> → Check the motor's line resistance. If winding is broken, replace the motor. • Output terminal screws are loose. <ul style="list-style-type: none"> → Check and tighten the output terminal screws. • Inverter output transistor open breakdown. <ul style="list-style-type: none"> → Replace the Inverter.
GF (See note.)	<p>Ground fault (GF)</p> <p>The ground current at the Inverter has exceeded approximately 50% of the Inverter's rated output current.</p>	<ul style="list-style-type: none"> • Motor burnout or insulation damage. <ul style="list-style-type: none"> → Check the motor's insulation resistance. If conducting, replace the motor. • Cable is damaged. <ul style="list-style-type: none"> → Check the resistance between the cable and FG. If conducting, replace the cable. • Cable and FG floating capacity <ul style="list-style-type: none"> → If the cable is longer than 100 m, lower the carrier frequency. → Apply measures to reduce the floating capacity. Don't use metal ducts, use a separate cable for each phase, include an AC reactor in the output side, etc.
SC (See note.)	<p>Load short circuit (SC)</p> <p>The Inverter output or load is short-circuited.</p>	<ul style="list-style-type: none"> • Motor burnout or insulation damage. <ul style="list-style-type: none"> → Check the resistance between the motor phases. If abnormal, replace the Inverter. • Cable is damaged. <ul style="list-style-type: none"> → Check the resistance between the cables. If conducting, replace the cable.

Fault display	Fault name and meaning	Probable cause and remedy
bus	<p>Communications error (Option Unit) A communications error occurred at the Option Unit.</p>	<ul style="list-style-type: none"> • Communications cable wired incorrectly, short-circuited, or disconnected. → Check and correct the communications cable wiring. • Data destroyed by noise. → Change to a dedicated communications cable or to shielded cable, and mask the shield or ground it at the power supply. → Use a dedicated communications power supply, and connect a noise filter to the power supply input side. • Option Unit is damaged. → If communications errors frequently occur and there is no problem with the wiring, replace the Option Unit.
OFF	<p>Power supply error Control power supply voltage is insufficient.</p>	<ul style="list-style-type: none"> • No power supply is provided. → Check and correct the power supply wire and voltage. • Terminal screws are loose. → Check and tighten the terminal screws. • Operator connectors are faulty. → If only the Operator indicator is not lit, (i.e., if the RUN and ALARM indicators are lit), check and correct the Operator's connectors. • The Inverter is damaged. → Replace the Inverter.

Note This fault is displayed for 200 and 400-V, 5.5-/7.5-kW Inverters only.

4-1-2 Warning Detection (Nonfatal Errors)

The warning detection is a type of Inverter protective function that does not operate the fault contact output and returns the Inverter to its original status once the cause of the error has been removed. The Digital Operator flashes and display the detail of the error. If a warning occurs, take appropriate countermeasures according to the table below.

Note Some warnings or some cases stop the operation of the Inverter as described in the table.

■ Warning Displays and Processing

Fault display	Warning name and meaning	Probable cause and remedy
\underline{U} (flashing)	Main circuit undervoltage (UV) The main circuit DC voltage has reached the undervoltage detection level (200 V DC for the 3G3MV-A2□, 160 V DC for the 3G3MV-AB□, and 400 V DC for the 3G3MV-A4□).	<ul style="list-style-type: none"> Power supply to the Inverter has phase loss, power input terminal screws are loose, or the power line is disconnected. → Check the above and take necessary countermeasures. Incorrect power supply voltage → Make sure that the power supply voltage is within specifications.
\overline{O} (flashing)	Main circuit overvoltage The main circuit DC voltage has reached the overvoltage detection level (410 V DC for 200-V Inverters, 820 V DC for 400-V Inverters).	<ul style="list-style-type: none"> The power supply voltage is too high. → Decrease the voltage so it will be within specifications.
\overline{H} (flashing)	Radiation fin overheated (OH) The temperature of the radiation fins of the Inverter has reached $110^{\circ}\text{C} \pm 10^{\circ}\text{C}$.	<ul style="list-style-type: none"> The ambient temperature is too high. → Ventilate the Inverter or install a cooling unit.
\overline{CAL} (flashing)	Communications standby (CAL) No normal DSR message has been received during RS-422/4895 communications. The Inverter detects this warning only when RUN command selection (n003) is set to 2 or frequency reference selection (n004) is set to 6. Until the warning is reset, no input other than communications input will be ignored.	<ul style="list-style-type: none"> A short-circuit, ground fault, or disconnection has occurred on the communications line. → Check and correct the line. The termination resistance setting is incorrect. → In the case of RS-422 communications, set pin 1 of SW2 of all Inverters to ON. In the case of RS-485 communications, set pin 1 of SW2 of only the Inverter located at each end of the network to ON. Master's program error. → Check the start of communications and correct the program. Communications circuit damage. → If the same error is detected as a result of a self-diagnostic test, change the Inverter.

Fault display	Warning name and meaning	Probable cause and remedy
<p>$\alpha P 1$ (flashing)</p>	<p>Operation error (OP□) (Parameter setting error)</p>	<ul style="list-style-type: none"> The values in n050 through n056 for multi-function inputs 1 through 7 have been duplicated. → Check and correct the values.
<p>$\alpha P 2$ (flashing)</p>		<ul style="list-style-type: none"> The V/f pattern settings do not satisfy the following condition. $n016 \leq n014 < n013 \leq n011$ → Check and correct the set value.
<p>$\alpha P 3$ (flashing)</p>		<ul style="list-style-type: none"> The rated motor current set in n036 exceeds 150% of the rated output current of the Inverter. → Check and correct the set value.
<p>$\alpha P 4$ (flashing)</p>		<ul style="list-style-type: none"> The frequency reference upper limit set in n036 and the frequency reference lower limit set in n034 do not satisfy the following condition. $n033 \geq n034$ → Check and correct the set values.
<p>$\alpha P 5$ (flashing)</p>		<ul style="list-style-type: none"> The jump frequencies set in n083 to n085 do not satisfy the following condition. $n083 \geq n084 \geq n085$ → Check and correct the set values.
<p>$\alpha P 9$ (flashing)</p>		<ul style="list-style-type: none"> The carrier frequency set in n080 is incorrect. An attempt was made to set a value that is not within a permissible range. → Check and correct the set value.
<p>$\alpha L 3$ (flashing)</p>	<p>Overtorque detection (OL3) There has been a current or torque the same as or greater than the setting in n098 for overtorque detection level and that in n099 for overtorque detection time. A fault has been detected with n096 for overtorque detection function selection set to 1 or 3.</p>	<ul style="list-style-type: none"> The mechanical system is locked or has a failure. → Check the mechanical system and correct the cause of overtorque. The parameter settings were incorrect. → Adjust the n098 and n099 parameters according to the mechanical system. Increase the set values in n98 and n099.
<p>SEr (flashing)</p>	<p>Sequence error (SER) A sequence change has been input while the Inverter is in operation. Local or remote selection or communications/remote selection are input while the Inverter is in operation. Note The Inverter coasts to a stop.</p>	<ul style="list-style-type: none"> A sequence error has occurred. → Check and correct the sequence.
<p>bb (flashing)</p>	<p>External base block (bb) The external base block command has been input. Note The Inverter coasts to a stop.</p>	<ul style="list-style-type: none"> The external base block command has been input. → Remove the cause of external base block input. The sequence is incorrect. → Check and change the external fault input sequence including the input timing and NO or NC contact.

Fault display	Warning name and meaning	Probable cause and remedy
<p><i>EF</i> (flashing)</p>	<p>Forward- and reverse-rotation input (EF) The forward and reverse commands are input to the control circuit terminals simultaneously for 0.5 s or more. Note The Inverter stops according to the method set in n005.</p>	<ul style="list-style-type: none"> • A sequence error has occurred. → Check and adjust the local or remote selection sequence.
<p><i>SfP</i> (flashing)</p>	<p>Emergency stop (STP) The Digital Operator stops operating. The STOP/RESET Key on the Digital Operator is pressed while the Inverter is operating according to the forward or reverse command through the control circuit terminals. Note The Inverter stops according to the method set in n04. The emergency stop alarm signal is input as multi-function input. A multi-function input 1 to 7 set to 20 or 22 has been used. Note The Inverter stops according to the method set in n005. The Inverter decelerates to a stop in deceleration time 2 with n005 set to 0.</p>	<ul style="list-style-type: none"> • The parameter setting was incorrect. → Check that the n007 parameter setting for STOP/RESET Key function selection is correct. • An emergency stop warning is input to a multi-function input. → Remove the cause of the fault or correct the input sequence.
<p><i>FAn</i> (flashing)</p>	<p>Cooling fan fault (FAN) The cooling fan has been locked.</p>	<ul style="list-style-type: none"> • The cooling fan wiring has a fault. → Turn OFF the Inverter, dismount the fan, and check and repair the wiring. • The cooling fan is not in good condition. → Check and remove the foreign material or dust on the fan. • The cooling fan is beyond repair. → Replace the fan.
<p><i>FbL</i> (flashing)</p>	<p>Feedback loss fault (FbL) A feedback input was interrupted during PID control execution. (This fault is detected when an input level below the feedback loss detection level set in n137 persists for longer than the feedback loss detection time set in n138.)</p>	<ul style="list-style-type: none"> • Feedback wiring error. → Check for and correct any cable disconnection or faulty wiring. • Feedback sensor error → Check sensor status and replace any defective sensors. • PID target value input error or feedback loss detection setting error → Correct the target value input so that it is outside of the feedback loss detection range. Correct the feedback loss detection parameter settings (n137, n138). • Feedback input circuit error → Replace the Inverter.

Fault display	Warning name and meaning	Probable cause and remedy
oH3	<p>Inverter overheating warning (oH3) An Inverter overheating warning signal was input from an external control terminal set to multi-function input.</p>	<ul style="list-style-type: none"> • Clear the Inverter overheating warning signal. • Eliminate the cause of the warning signal input.
EE	<p>Communications time over (CE) RS-422 or RS-485 communications were not properly carried out within 2 s. (Detected when n151 is set to “3.”)</p>	<ul style="list-style-type: none"> • A short-circuit, ground fault, or disconnection has occurred on the communications line. <ul style="list-style-type: none"> → Check and correct the line. • The termination resistance setting is incorrect. <ul style="list-style-type: none"> → In the case of RS-422 communications, set pin 1 of SW2 of all Inverters to ON. In the case of RS-485 communications, set pin 1 of SW2 of only the Inverter located at each end of the network to ON. • Noise influence. <ul style="list-style-type: none"> → Do not wire the communications line along with power lines in the same conduit. → Use the twisted-pair shielded wire for the communications line, and ground it at the Master. • Master’s program error. <ul style="list-style-type: none"> → Check and correct the program so that communications will be performed more than once every 2-s period. • Communications circuit damage. <ul style="list-style-type: none"> → If the same error is detected as a result of a self-diagnostic test, change the Inverter.