

USER'S MANUAL

SYSDRIVE 3G3EV

(Multi-function Models)

Compact Low-noise Inverter

Thank you for choosing this SYSDRIVE 3G3EV-series product. Proper use and handling of the product will ensure proper product performance, will lengthen product life, and may prevent possible accidents.

Please read this manual thoroughly and handle and operate the product with care.

NOTICE

1. This manual describes the functions of the product and relations with other products. You should assume that anything not described in this manual is not possible.
2. Although care has been given in documenting the product, please contact your OMRON representative if you have any suggestions on improving this manual.
3. The product contains potentially dangerous parts under the cover. Do not attempt to open the cover under any circumstances. Doing so may result in injury or death and may damage the product. Never attempt to repair or disassemble the product.
4. We recommend that you add the following precautions to any instruction manuals you prepare for the system into which the product is being installed.
 - Precautions on the dangers of high-voltage equipment.
 - Precautions on touching the terminals of the product even after power has been turned off. (These terminals are live even with the power turned off.)
5. Specifications and functions may be changed without notice in order to improve product performance.

Items to Check Before Unpacking

Check the following items before removing the product from the package:

- Has the correct product been delivered (i.e., the correct model number and specifications)?
- Has the product been damaged in shipping?
- Are any screws or bolts loose?

Notice:

OMRON products are manufactured for use according to proper procedures by a qualified operator and only for the purposes described in this manual.

The following conventions are used to indicate and classify precautions in this manual. Always heed the information provided with them. Failure to heed precautions can result in injury to people or damage to property.

 **DANGER** Indicates an imminently hazardous situation which, if not avoided, will result in death or serious injury.

 **WARNING** Indicates a potentially hazardous situation which, if not avoided, could result in death or serious injury.

 **Caution** Indicates a potentially hazardous situation which, if not avoided, may result in minor or moderate injury, or property damage.

OMRON Product References

All OMRON products are capitalized in this manual. The word “Unit” is also capitalized when it refers to an OMRON product, regardless of whether or not it appears in the proper name of the product.

The abbreviation “Ch,” which appears in some displays and on some OMRON products, often means “word” and is abbreviated “Wd” in documentation in this sense.

The abbreviation “PC” means Programmable Controller and is not used as an abbreviation for anything else.

Visual Aids

The following headings appear in the left column of the manual to help you locate different types of information.

Note Indicates information of particular interest for efficient and convenient operation of the product.

© OMRON, 2000

All rights reserved. No part of this publication may be reproduced, stored in a retrieval system, or transmitted, in any form, or by any means, mechanical, electronic, photocopying, recording, or otherwise, without the prior written permission of OMRON.









No patent liability is assumed with respect to the use of the information contained herein. Moreover, because OMRON is constantly striving to improve its high-quality products, the information contained in this manual is subject to change without notice. Every precaution has been taken in the preparation of this manual. Nevertheless, OMRON assumes no responsibility for errors or omissions. Neither is any liability assumed for damages resulting from the use of the information contained in this publication.

General Precautions



Observe the following precautions when using the SYSDRIVE Inverters and peripheral devices.

This manual may include illustrations of the product with protective covers removed in order to describe the components of the product in detail. Make sure that these protective covers are on the product before use.





Consult your OMRON representative when using the product after a long period of storage.

-  **WARNING** Do not touch the inside of the Inverter. Doing so may result in electrical shock.
-  **WARNING** Operation, maintenance, or inspection must be performed after turning OFF the power supply, confirming that the CHARGE indicator (or status indicators) are OFF, and after waiting for the time specified on the front cover. Not doing so may result in electrical shock.
-  **WARNING** Do not damage, pull on, apply stress to, place heavy objects on, or pinch the cables. Doing so may result in electrical shock.
-  **WARNING** Do not touch the rotating parts of the motor under operation. Doing so may result in injury.
-  **WARNING** Do not modify the product. Doing so may result in injury or damage to the product.
-  **Caution** Do not store, install, or operate the product in the following places. Doing so may result in electrical shock, fire or damage to the product.
 - Locations subject to direct sunlight.
 - Locations subject to temperatures or humidity outside the range specified in the specifications.
 - Locations subject to condensation as the result of severe changes in temperature.
 - Locations subject to corrosive or flammable gases.
 - Locations subject to exposure to combustibles.
 - Locations subject to dust (especially iron dust) or salts.
 - Locations subject to exposure to water, oil, or chemicals.
 - Locations subject to shock or vibration.
-  **Caution** Do not touch the Inverter radiator, regenerative resistor, or Servomotor while the power is being supplied or soon after the power is turned OFF. Doing so may result in a skin burn due to the hot surface.
-  **Caution** Do not conduct a dielectric strength test on any part of the Inverter. Doing so may result in damage to the product or malfunction.
-  **Caution** Take appropriate and sufficient countermeasures when installing systems in the following locations. Not doing so may result in equipment damage.
 - Locations subject to static electricity or other forms of noise.
 - Locations subject to strong electromagnetic fields and magnetic fields.
 - Locations subject to possible exposure to radioactivity.
 - Locations close to power supplies.





Transportation Precautions







-  **Caution** Do not hold by front cover or panel, instead, hold by the radiation fin (heat sink) while transporting the product. Doing so may result in injury.
-  **Caution** Do not pull on the cables. Doing so may result in damage to the product or malfunction.
-  **Caution** Use the eye-bolts only for transporting the Inverter. Using them for transporting the machinery may result in injury or malfunction.

Installation Precautions







-  **WARNING** Provide an appropriate stopping device on the machine side to secure safety. (A holding brake is not a stopping device for securing safety.) Not doing so may result in injury.
-  **WARNING** Provide an external emergency stopping device that allows an instantaneous stop of operation and power interruption. Not doing so may result in injury.
-  **Caution** Be sure to install the product in the correct direction and provide specified clearances between the Inverter and control panel or with other devices. Not doing so may result in fire or malfunction.
-  **Caution** Do not allow foreign objects to enter inside the product. Doing so may result in fire or malfunction.
-  **Caution** Do not apply any strong impact. Doing so may result in damage to the product or malfunction.





Wiring Precautions

-  **WARNING** Wiring must be performed only after confirming that the power supply has been turned OFF. Not doing so may result in electrical shock.
-  **WARNING** Wiring must be performed by authorized personnel. Not doing so may result in electrical shock or fire.
-  **WARNING** Be sure to confirm operation only after wiring the emergency stop circuit. Not doing so may result in injury.
-  **WARNING** Always connect the ground terminals to a ground of 100 Ω or less for the 200-V AC class, or 10 Ω or less for the 400-V AC class. Not connecting to a proper ground may result in electrical shock.

-  **Caution** Install external breakers and take other safety measures against short-circuiting in external wiring. Not doing so may result in fire.
-  **Caution** Confirm that the rated input voltage of the Inverter is the same as the AC power supply voltage. An incorrect power supply may result in fire, injury, or malfunction.
-  **Caution** Connect the Braking Resistor and Braking Resistor Unit as specified in the manual. Not doing so may result in fire.
-  **Caution** Be sure to wire correctly and securely. Not doing so may result in injury or damage to the product.
-  **Caution** Be sure to firmly tighten the screws on the terminal block. Not doing so may result in fire, injury, or damage to the product.
-  **Caution** Do not connect an AC power to the U, V, or W output. Doing so may result in damage to the product or malfunction.

Operation and Adjustment Precautions

-  **WARNING** Turn ON the input power supply only after mounting the front cover, terminal covers, bottom cover, Operator, and optional items. Not doing so may result in electrical shock.
-  **WARNING** Do not remove the front cover, terminal covers, bottom cover, Operator, or optional items while the power is being supplied. Not doing so may result in electrical shock or damage to the product.
-  **WARNING** Do not operate the Operator or switches with wet hands. Doing so may result in electrical shock.
-  **WARNING** Do not touch the inside of the Inverter. Doing so may result in electrical shock.
-  **WARNING** Do not come close to the machine when using the error retry function because the machine may abruptly start when stopped by an alarm. Doing so may result in injury.
-  **WARNING** Do not come close to the machine immediately after resetting momentary power interruption to avoid an unexpected restart (if operation is set to be continued in the processing selection function after momentary power interruption is reset). Doing so may result in injury.
-  **WARNING** Provide a separate emergency stop switch because the STOP Key on the Operator is valid only when function settings are performed. Not doing so may result in injury.

-  **WARNING** Be sure confirm that the RUN signal is turned OFF before turning ON the power supply, resetting the alarm, or switching the LOCAL/REMOTE selector. Doing so while the RUN signal is turned ON may result in injury.
-  **Caution** Be sure to confirm permissible ranges of motors and machines before operation because the Inverter speed can be easily changed from low to high. Not doing so may result in damage to the product.
-  **Caution** Provide a separate holding brake when necessary. Not doing so may result in injury.
-  **Caution** Do not perform a signal check during operation. Doing so may result in injury or damage to the product.
-  **Caution** Do not carelessly change settings. Doing so may result in injury or damage to the product.

Maintenance and Inspection Precautions







-  **WARNING** Do not touch the Inverter terminals while the power is being supplied.
-  **WARNING** Maintenance or inspection must be performed only after turning OFF the power supply, confirming that the CHARGE indicator (or status indicators) is turned OFF, and after waiting for the time specified on the front cover. Not doing so may result in electrical shock.
-  **WARNING** Maintenance, inspection, or parts replacement must be performed by authorized personnel. Not doing so may result in electrical shock or injury.
-  **WARNING** Do not attempt to take the Unit apart or repair. Doing either of these may result in electrical shock or injury.
-  **Caution** Carefully handle the Inverter because it uses semiconductor elements. Careless handling may result in malfunction.
-  **Caution** Do not change wiring, disconnect connectors, the Operator, or optional items, or replace fans while power is being supplied. Doing so may result in injury, damage to the product, or malfunction.

Table of Contents

Chapter 1. Getting Started	
1-1 Items to be Checked when Unpacking	
1-2 Precautions	
Chapter 2. Overview	
2-1 Features	
2-2 Component Names	
Chapter 3. Design	
3-1 Installation	
3-1-1 Outside/Mounting Dimensions	
3-1-2 Installation Conditions	
3-2 Wiring	
3-2-1 Terminal Blocks	
3-2-2 Wiring Around the Main Circuit	
3-2-3 Wiring Control Circuit Terminals	
Chapter 4. Preparing for Operation	
4-1 Preparation Procedure	
4-2 Using the Digital Operator	
4-2-1 Name and Function of Each Component	
4-2-2 Outline of Operation	
4-2-3 Setting Constants	
4-3 Test Run	
Chapter 5. Operation	
5-1 Protective and Diagnostic Functions	
5-2 Troubleshooting	
5-2-1 Constants Fail to Set	
5-2-2 Motor Fails to Operate	
5-2-3 Motor Rotates in the Wrong Direction	
5-2-4 Motor Deceleration is Too Slow	
5-2-5 Vertical-axis Load Drops when Brakes are Applied	
5-2-6 Motor Burns	
5-2-7 Controller Receives Noise when Inverter is Started	
5-2-8 AM Radio Receives Noise when Inverter is Started	
5-2-9 Ground Fault Interrupter is Actuated when Inverter is Started	
5-2-10 Mechanical System Makes Noise	
5-2-11 Motor Rotates after Output of Inverter is Turned Off	
5-2-12 Overvoltage is Detected When Fan is Turned On or Revolution of Fan Decreases	
5-2-13 Output Frequency Does Not Reach Reference Frequency	
5-2-14 Motor Does Not Operate with EF Warning	
5-3 Maintenance and Inspection	

Table of Contents

Chapter 6. Specifications	
6-1 Specifications of Main Unit	
Chapter 7. Appendix A	
7-1 Notes on Using Inverter for Motor	
7-2 Frequency Reference by Amperage Input	
7-3 List of Product Models	

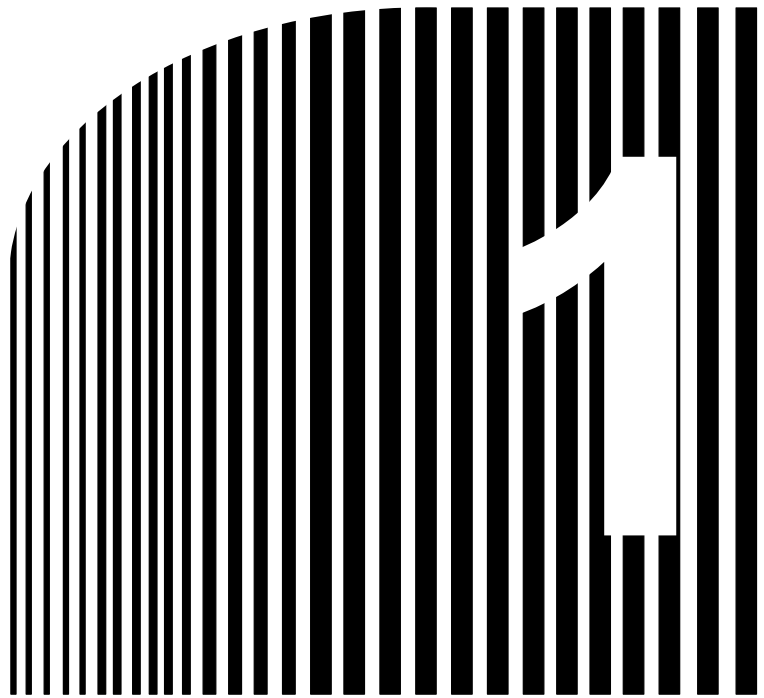

Chapter 1

• Getting Started •

- 1-1 Items to be Checked when Unpacking
- 1-2 Precautions

1-1 Items to be Checked when Unpacking

■ Checking the Product

On delivery, always check that the delivered product is the SYSDRIVE 3G3EV Inverter that you ordered.

Should you find any problems with the product, immediately contact your nearest local sales representative.

● Checking the Nameplate

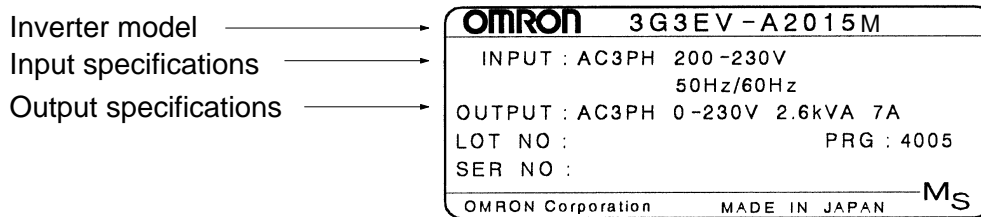

● Checking the Model

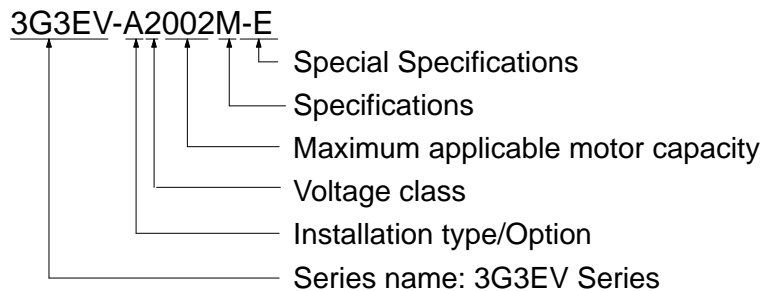

Specifications

Blank	Standard model
M	Multi-function model
R	SYSMAC BUS model

Maximum Applicable Motor Capacity

001	0.1 kW
002	0.2 (0.37) kW
004	0.4 (0.55) kW
007	0.75 (1.1) kW
015	1.5 kW

Note The figures in parentheses indicate capacities for 400-VAC class models.

Voltage Class

2	Three-phase 200-VAC input
B	Single/Three-phase 200-VAC input
4	Three-phase 400-VAC input

Special Specification

-E	English Models
-CUE	UL/CUL and EC Directives Models
Blank	Japanese Models

Installation Type/Option

A	Panel mounting models (IP10 min) or wall-mounting closed models
P	Option

● **Checking for Damage**

Check the overall appearance and check for damage or scratches resulting from transportation.

■ **Checking Accessories**

Note that this manual is the only accessory provided with the 3G3EV (Multi-function Model). Set screws and other necessary parts must be prepared by customers.

1-2 Precautions

To ensure safe operation of the 3G3EV, note the following items:

■ **Always Hold the Heat Sink During Removal.**

When moving the 3G3EV, always hold the heat sink (aluminum portion on the rear of the Unit).

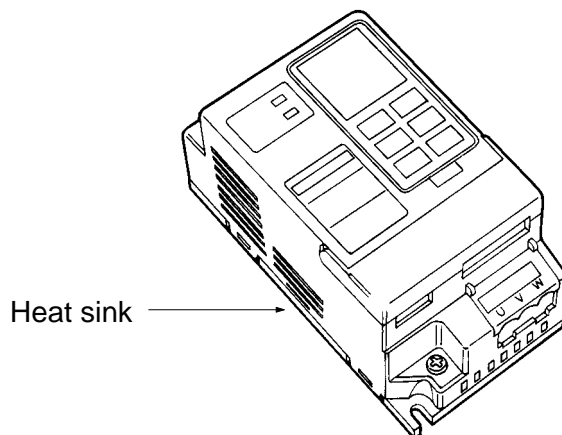

■ Watch Out for Residual Voltage On Charged Portions

After the power is turned off, residual voltage remains in the capacitor inside the Inverter. Therefore, touching terminals immediately after turning the power off may cause an electrical shock.

If an inspection or some other task is to be performed, always wait at least one minute from the time all indicators on the front panel go off.

(Note that this warning is applicable whenever you perform any task after turning the main circuit off.)

■ Do Not Remove the Digital Operator When the Main Circuit is Still On.

Always turn the main circuit off before removing the Digital Operator.

Removing the Digital Operator with the main circuit ON may cause an electrical shock and damage the equipment.

■ Do Not Modify Wiring or Check Signals When the Main Circuit is On.

Always turn the main circuit off before modifying wiring or checking signals.

Touching terminals while the main circuit is on may cause an electrical shock and damage the equipment.

■ Do Not Conduct a Dielectric Strength Test.

Because the 3G3EV Inverter is an electronic control unit using semiconductor, never conduct a dielectric strength test or an insulation resistance test for the control circuit.

■ Modify Constant Settings Correctly.

Always modify the constant settings according to the procedures described in this manual.

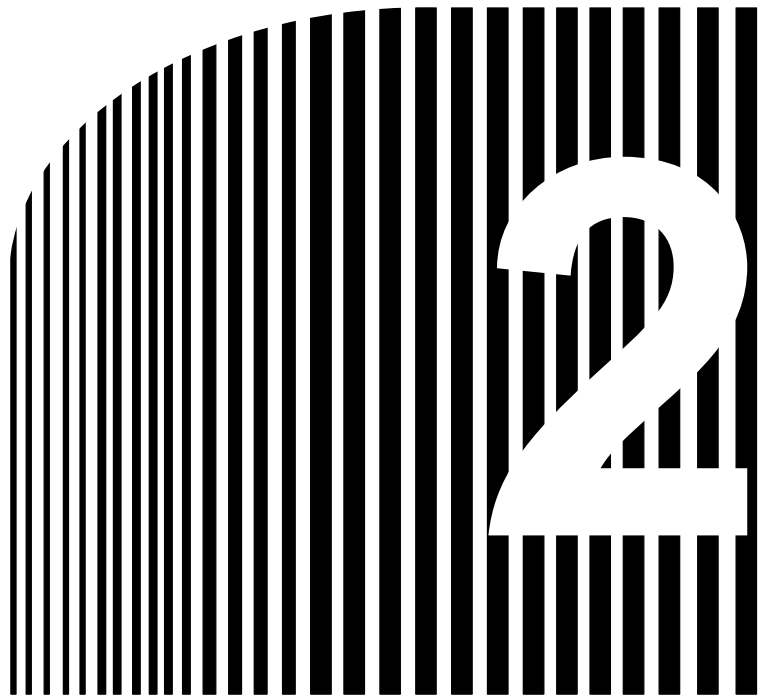

Chapter 2

• Overview •

2-1 Features

2-2 Component Names

2-1 Features

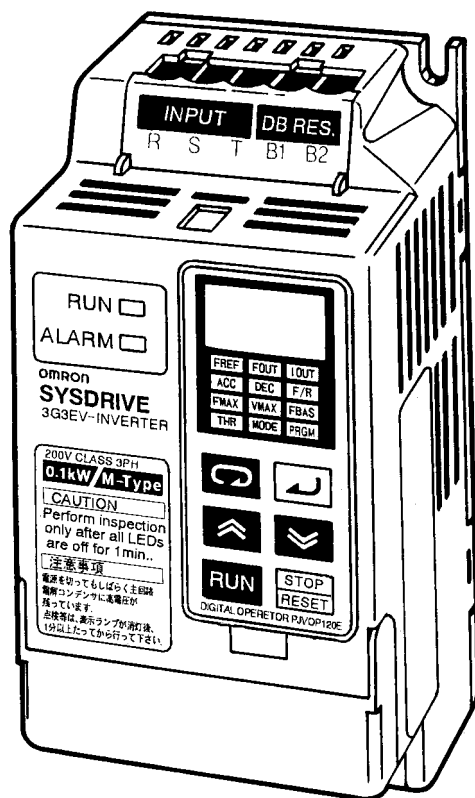

■ Easy to Use

● Basic Constants Displayed On Indicators

Constants for basic operations such as frequency setting and acceleration/deceleration time setting are displayed on dedicated indicators. Therefore, constant numbers can be confirmed easily.

■ Easy to Install

● Very Small and Lightweight

The 3G3EV Inverter is approximately half the size of our Low-noise General-purpose Inverters in terms of volume and weight percentage. This improves space efficiency and operating efficiency (including easier removal).

● Optional DIN Track

An optional DIN track is available. This DIN track enables the user to mount the 3G3EV Inverter on the DIN track with a one-touch operation.

■ Easy to Wire

● Easy Wiring without Having to Open the Front Cover

This Inverter can be wired just by opening the terminal block cover.

● Separate Input and Output Terminal Blocks

Power input terminals are located in the upper section, while motor output terminals are in the lower section. In this way, the input and output terminal blocks are separated according to the contactors, so incorrect wiring can be prevented.

● Soldering No Longer Necessary

No connector means no soldering.

■ Easy to Operate

● Switching the Operation Mode with a One-touch Operation

For example, after a test run is performed using the Digital Operator, it can be easily switched to a production run using control terminals with a one-touch operation.

● Checking a Test Run with Various Monitors

Output frequency, output current, and the direction of motor rotation appear in the display section of the Digital Operator, so the mechanical system can be easily monitored during a test run. Multi-function analog output is also available, which can be used for output frequency or current monitoring.

■ Fine Settings Allow Smooth Machine Control

Voltage and frequency fine-tuning, frequency jump, and S-shape acceleration and deceleration functions are available and ideal for controlling machines that cannot be controlled by conventional standard inverters.

■ Multi-step Speed Selection

Speed selection with a maximum of eight steps is possible.

■ Low Noise

An insulated gate bipolar transistor (IGBT) power element has been adopted to eliminate metallic noise.

■ High-torque Operation Even in Low Speed Range

A torque rate of 150% can be achieved even in a low speed range where output frequency is only 3 Hz. Thus, acceleration time can be reduced.

■ Various Input Power Supplies

A 400-VAC-class Inverter has been newly added to the 3G3EV Series to cope with various power supplies.

- Three-phase 200-VAC input: 0.1 to 1.5 kW
- Single/Three-phase 200-VAC input: 0.1 to 1.5 kW
- Three-phase 400-VAC input: 0.2 to 1.5 kW

2-2 Component Names

■ Main Unit

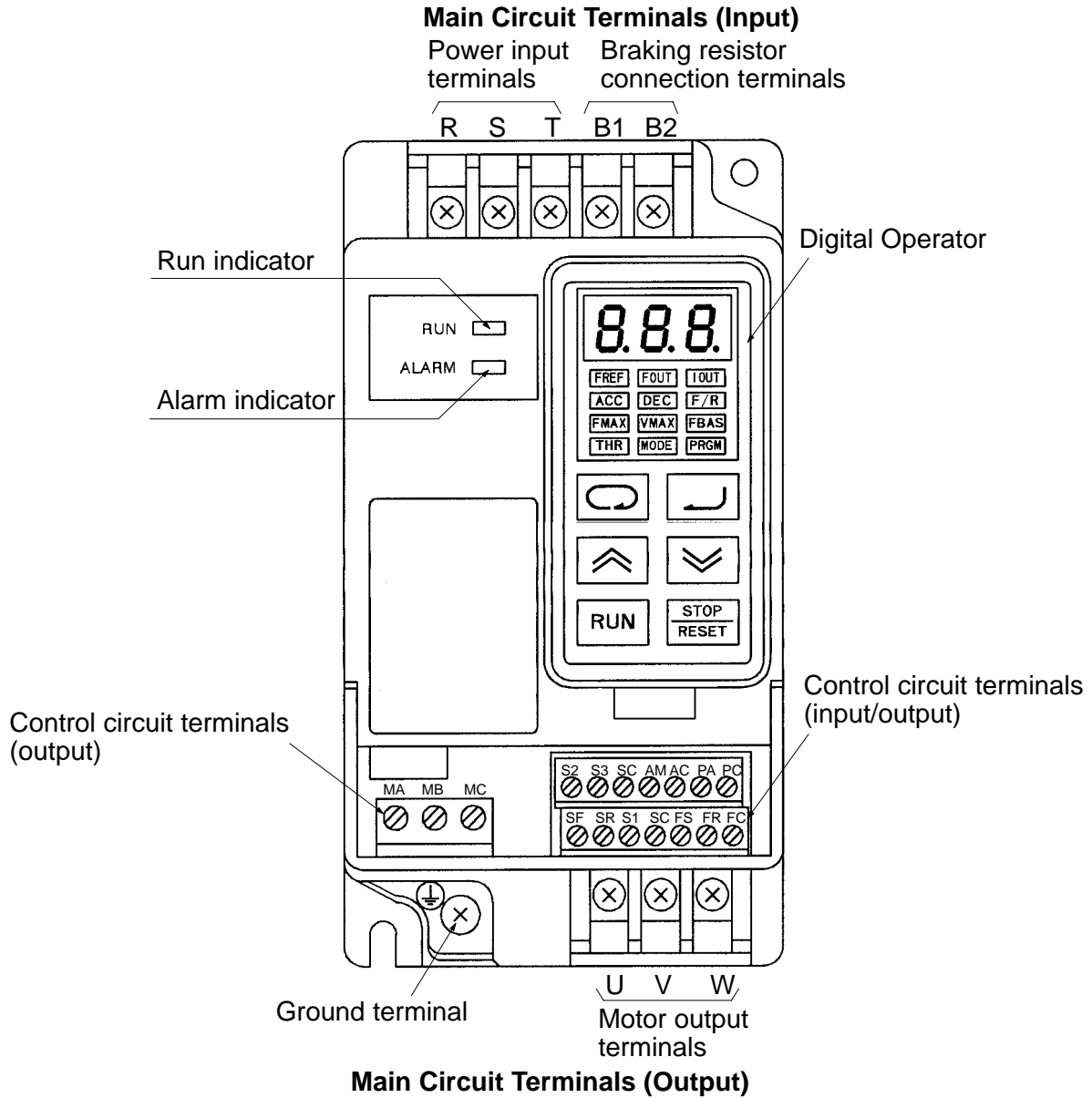

Note This diagram shows the Inverter with all terminal block covers removed.

■ Digital Operator

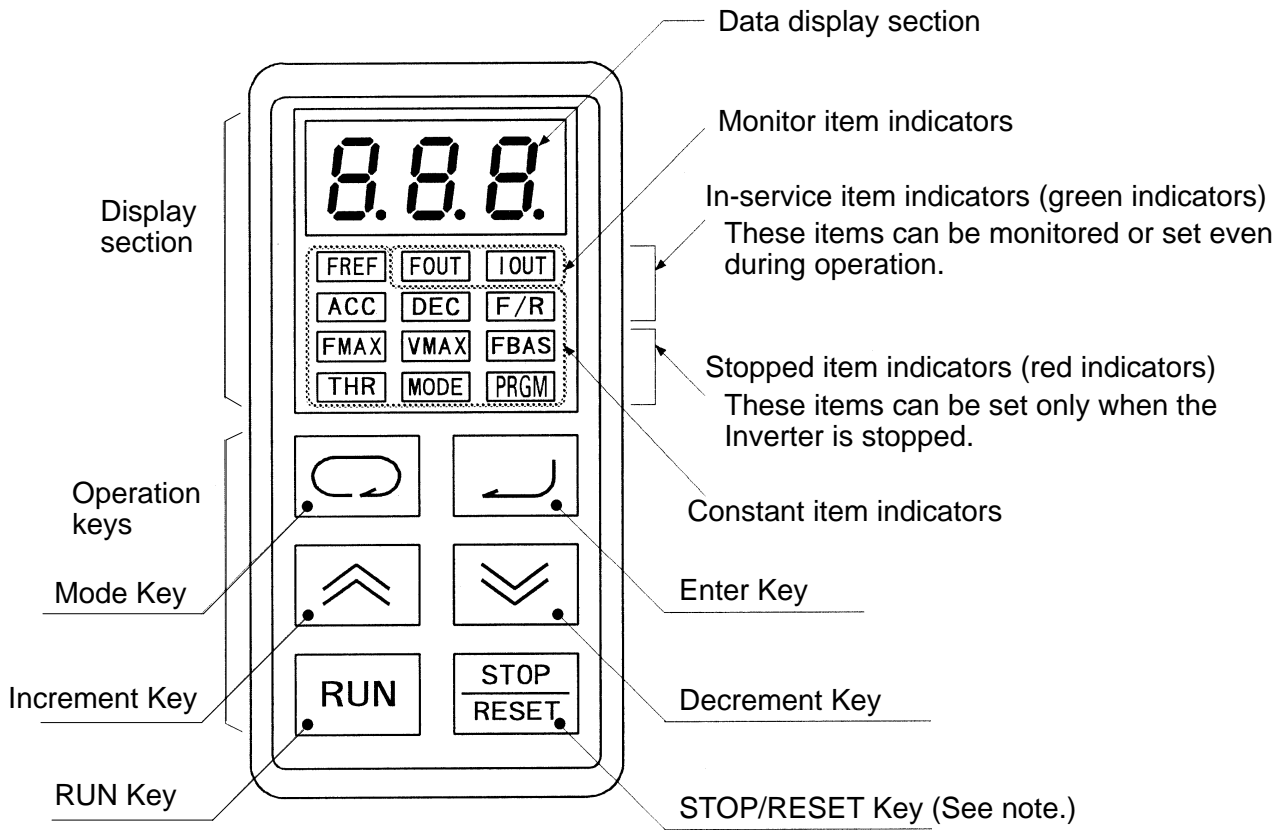

Note For safety reasons, the reset will not work while a RUN command (forward or reverse) is in effect. Wait until the RUN command is OFF before resetting the Inverter.

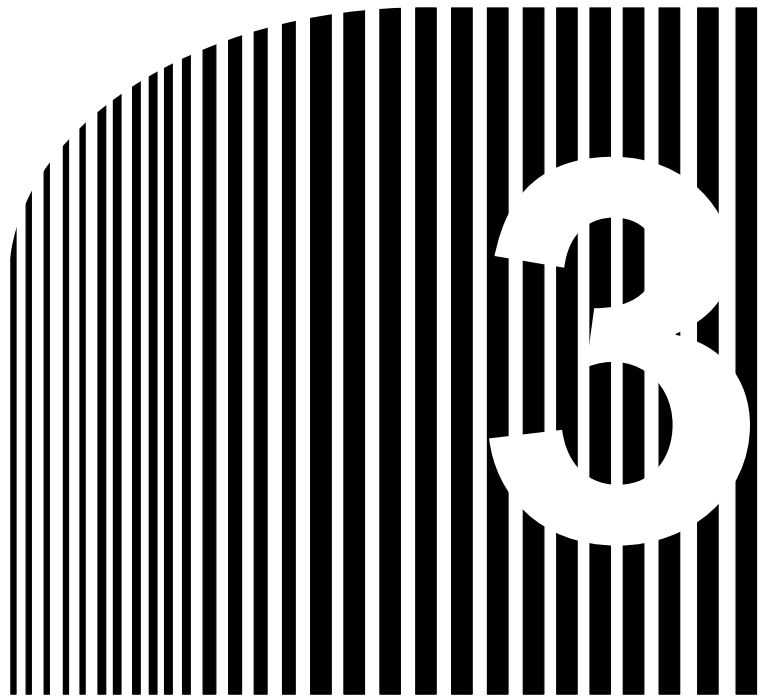

Chapter 3

• Design •

3-1 Installation

3-2 Wiring

3-1 Installation

3-1-1 Outside/Mounting Dimensions

Note All dimensions are in millimeters.

- 3G3EV-A2001M(-) to 3G3EV-A2004M(-) (0.1 to 0.4 kW):
Three-phase 200-VAC Input
- 3G3EV-AB001M(-) to 3G3EV-AB002M(-) (0.1 to 0.2 kW):
Single/Three-phase 200-VAC Input

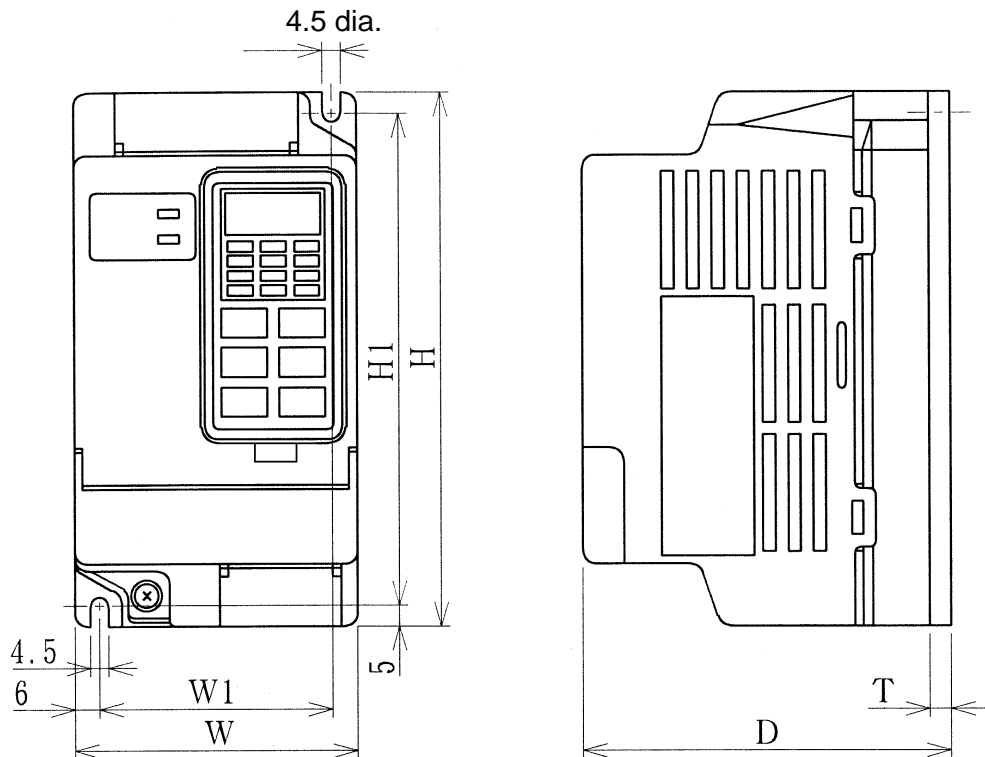

Note 1. For the 3G3EV-A2001M(-), 3G3EV-A2002M(-), and 3G3EV-AB001M(-), a U-shaped notch (4.5 mm wide) is provided instead of the upper mounting hole (4.5 mm in diameter).

Note 2. Install the Inverter with two M4 bolts.

● Three-phase 200-VAC Input Model

3G3EV model	Output	W	H	D	W1	H1	T	Weight (kg)
A2001M(-)	0.1 kW	68	128	75	56	118	3	Approx. 0.5
A2002M(-)	0.2 kW			88				Approx. 0.6
A2004M(-)	0.4 kW			110				Approx. 0.9

● Single/Three-phase 200-VAC Input Model

3G3EV model	Output	W	H	D	W1	H1	T	Weight (kg)
AB001M(-)	0.1 kW	68	128	75	56	118	3	Approx. 0.5
AB002M(-)	0.2 kW			108				Approx. 0.6

- 3G3EV-A2007M(-) to 3G3EV-A2015M(-) (0.75 to 1.5 kW):
Three-phase 200-VAC Input
- 3G3EV-AB004M(-) to 3G3EV-AB015M(-) (0.4 to 1.5 kW):
Single/Three-phase 200-VAC Input
- 3G3EV-A4002M(-) to 3G3EV-A4015(-) (0.2 to 1.5 kW):
Three-phase 400-VAC Input

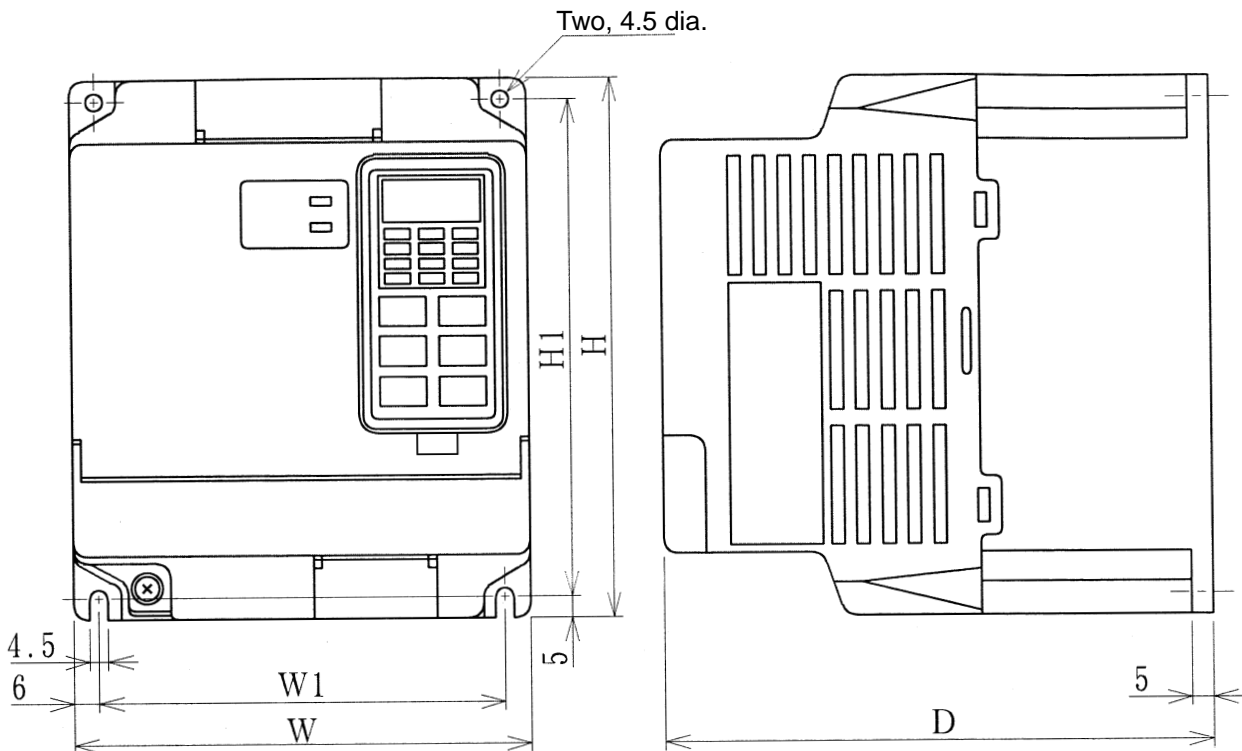

Note Install the Inverter with four M4 bolts.

● **Three-phase 200-VAC Input Model**

3G3EV model	Output	W	H	D	W1	H1	Weight (kg)
A2007M(-)	0.75 kW	108	128	130	96	118	Approx. 1.3
A2015M(-)	1.5 kW			155			Approx. 1.5

● **Single/Three-phase 200-VAC Input Model**

3G3EV model	Output	W	H	D	W1	H1	Weight (kg)
AB004M(-)	0.4 kW	108	128	130	96	118	Approx. 1.3
AB007M(-)	0.75 kW						Approx. 1.3
AB007M(-)	1.5 kW	130		170	118		Approx. 2.0

● **Three-phase 400-VAC Input Model**

3G3EV model	Output	W	H	D	W1	H1	Weight (kg)
A4002M(-)	0.2 kW	108	128	92	96	118	Approx. 1.0
A4004M(-)	0.4 kW			110			Approx. 1.0
A4007M(-)	0.75 kW			140			Approx. 1.5
A4015M(-)	1.5 kW	130		170	118		Approx. 2.0

3-1-2 Installation Conditions

■ **Installation Site**

- Install the Inverter under the following conditions:

Ambient temperature for operation: -10°C to 50°C

Humidity: 90% RH or less (non-condensing)

- Install the Inverter in a clean location free from oil mist and dust. Alternatively, install it in a totally enclosed panel that is completely shielded from suspended dust.

- When installing or operating the Inverter, always take special care so that metal powder, oil, water, or other foreign matter do not get in the Inverter.
- Do not install the Inverter on inflammables such as wood.

■ Direction of Installation

- Install the Inverter on a vertical surface so that the characters on the nameplate are oriented upward.

■ Installation Space

- When installing the Inverter, always provide the following installation space to allow normal heat dissipation from the Inverter:

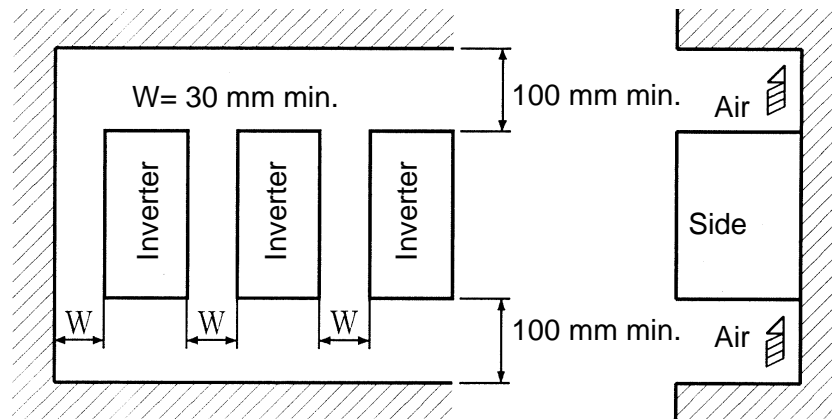

■ Ambient Temperature Control

- To enhance operation reliability, the Inverter should be installed in an environment free from extreme temperature rises.
- If the Inverter is installed in an enclosed environment such as a box, use a cooling fan or air conditioner to maintain the internal air temperature below 50°C.
- The surface temperature of the Inverter may reach 30°C higher than the ambient temperature. Therefore, keep all thermally susceptible devices and wires away from the Inverter.

■ Protecting the Inverter from Foreign Matter during Installation

- Place a cover over the Inverter to shield it from metal powder produced by drilling during installation.

(Upon completion of installation, always remove the cover from the Inverter. Otherwise, ventilation will be affected, causing the invert to overheat.)

3-2 Wiring

3-2-1 Terminal Blocks

■ Name of Each Terminal Block

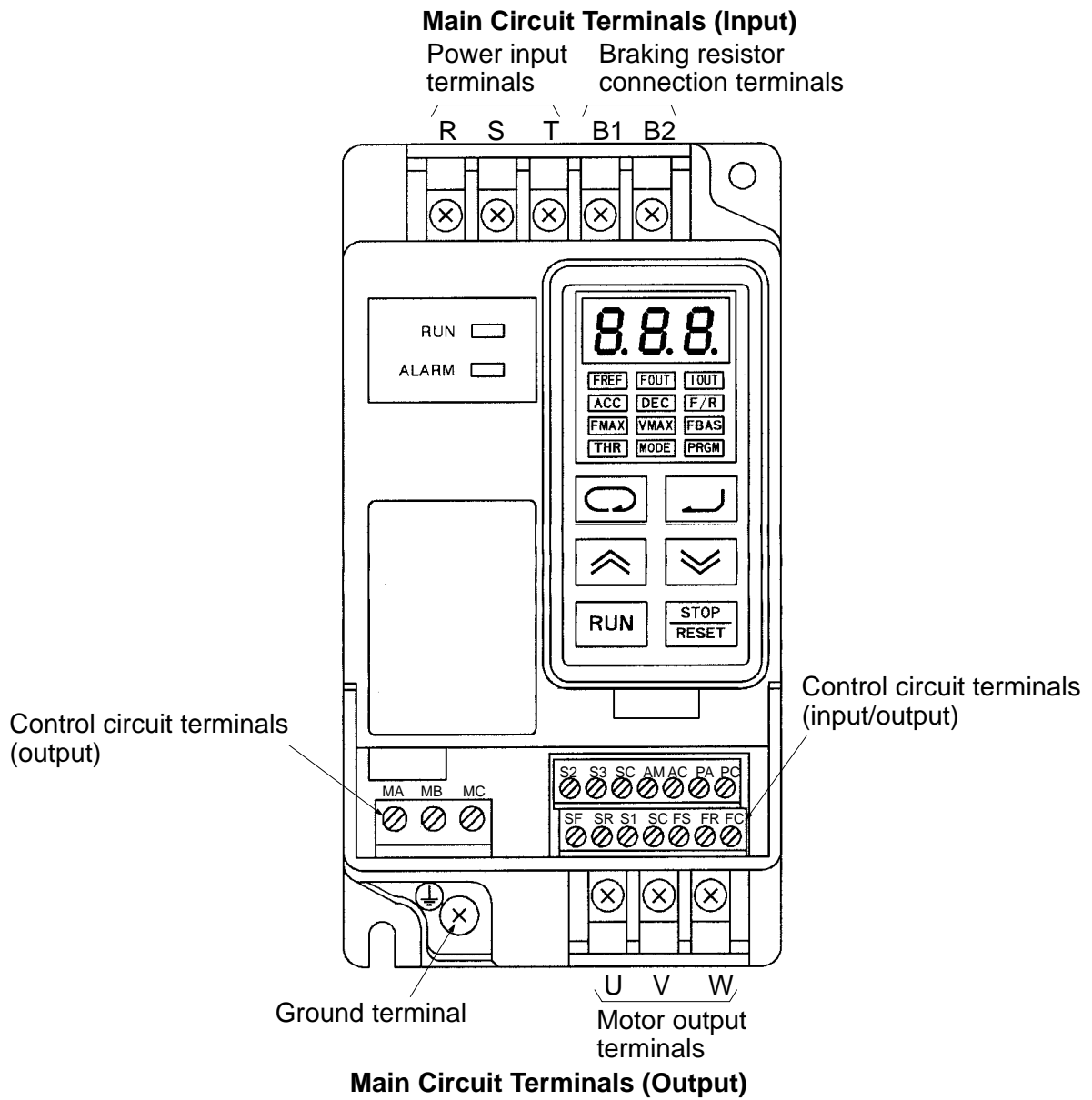

Note This diagram shows an Inverter with all terminal block covers removed.

■ Main Circuit Terminals

● Input Terminals (Top Section)

Terminal symbol	Name and description
R (L1)	Power input terminals A2 : Three-phase 200 to 230 VAC, 50/60 Hz AB : Single-phase 200 to 240 VAC, 50/60 Hz Three-phase 200 to 230 VAC, 50/60 Hz A4 : Three-phase 380 to 460 VAC, 50/60 Hz Note: Single-phase power must be input between terminals R to S.
S (L2/N)	
T (L3)	
B1	Braking resistor connection terminals (see note) Terminals for connecting an optional braking resistor
B2	

Note Before shipping, a resin plate is attached to each braking resistor connection terminal to prevent incorrect wiring.
 When connecting a braking resistor, always remove the resin plates with a pair of long-nose pliers.

● Output Terminals (Bottom Section)

Terminal symbol	Name and description
U V W	Motor output terminals Three-phase power output terminals for operating the motor. (Never connect an AC power supply to these terminals.) A2 , AB : Three-phase 200 to 230 VAC A4 : Three-phase 380 to 460 VAC Note: Depending on input voltage
⏏	Ground terminal Always use a ground terminal with one of the following ground resistances: 100 Ω or less for 200-VAC class 10 Ω or less for 400-VAC class. (Connect also to the power supply neutral to conform to the EC Directives.) Be sure to connect a grounding line to the FG terminal and also connect directly to the FG terminal of the motor.

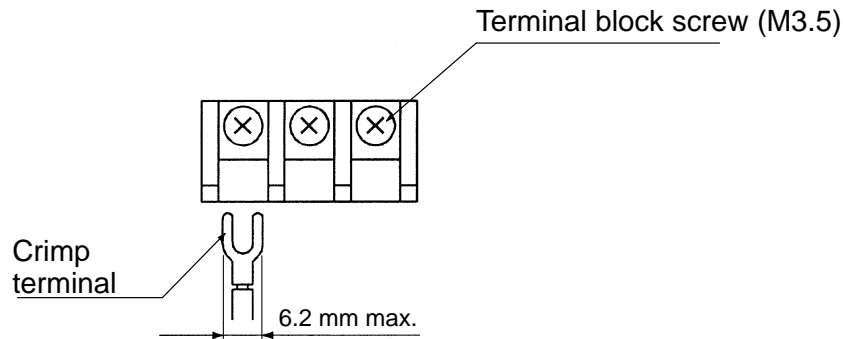

■ Control Circuit Terminals

● Input Terminals (On Right-hand Side)

No external power supply is required because a built-in power supply is provided.

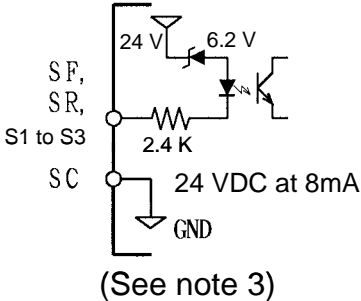
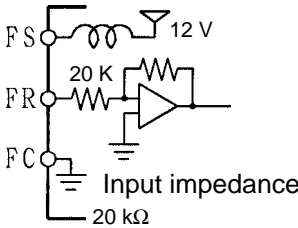
Terminal symbol	Name and description	Interface
SF	Forward/Stop When the terminal is ON, the motor rotates in the forward direction. When the terminal is OFF, the motor stops.	 <p>(See note 3)</p>
SR	Reverse/Stop When the terminal is ON, the motor reverses. When the terminal is OFF, the motor stops.	
S1 to S3	Multi-function input (see note 1)	
SC	Sequence input common Input terminal common to SF, SR, and S1	
FS	Frequency reference power supply Output voltage: 12 VDC Permissible amperage: 20 mA	 <p>Input impedance 20 kΩ</p>
FR	Frequency reference input (see note 2) 0 to 10 VDC is input.	
FC	Frequency reference common	

Note 1. Constant No. 06 (n06) is used to set this function. The following are the factory settings of S1, S2, and S3.

S1: Fault reset (n06 = 1)

S2: External fault (input to contact a) (n07 = 2)

S3: Multi-step speed command 1 (n08 = 4)

Note 2. FR can be switched to an amperage input terminal (4 to 20 mA) by setting the internal DIP switch and constant No. 02 (operation mode selection). For details, refer to 7-2 *Frequency Reference by Amperage Input*.

Note 3. The circuit for a 400-VAC-class Inverter is as shown below.

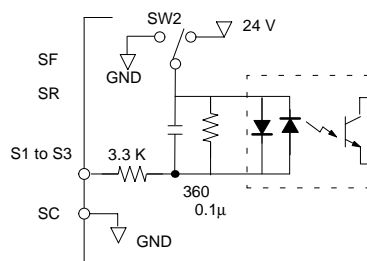

● Output Terminals (On Left-hand Side)

Terminal symbol	Name and description	Interface
MA	Multi-function contact output (contact a) (see note)	
MB	Multi-function contact output (contact b) (see note)	
MC	Multi-function contact output (common)	

Note Constant No. 09 (n09) is used to set the function. This constant is factory set to “operation in progress.”

● Output Terminals (On Right-hand Side)

Terminal symbol	Name and description	Interface
PA	Multi-function photocoupler output (see note)	
PC	Multi-function photocoupler output (common)	

Note Constant No. 10 (n10) is used to set this function. This constant is factory-set to “fault reset.”

● Analog Output Terminals (On Right-hand Side)

Terminal symbol	Name and description	Interface
AM	Multi-function analog output (see note)	
AC	Multi-function analog output (common)	

Note Constant No. 44 (n44) is used to set this function and constant No. 45 (n45) is used to set the multiplying factor, which are factory-set to “output frequency” and “3V at maximum frequency” respectively.

■ Standard Connection Diagram

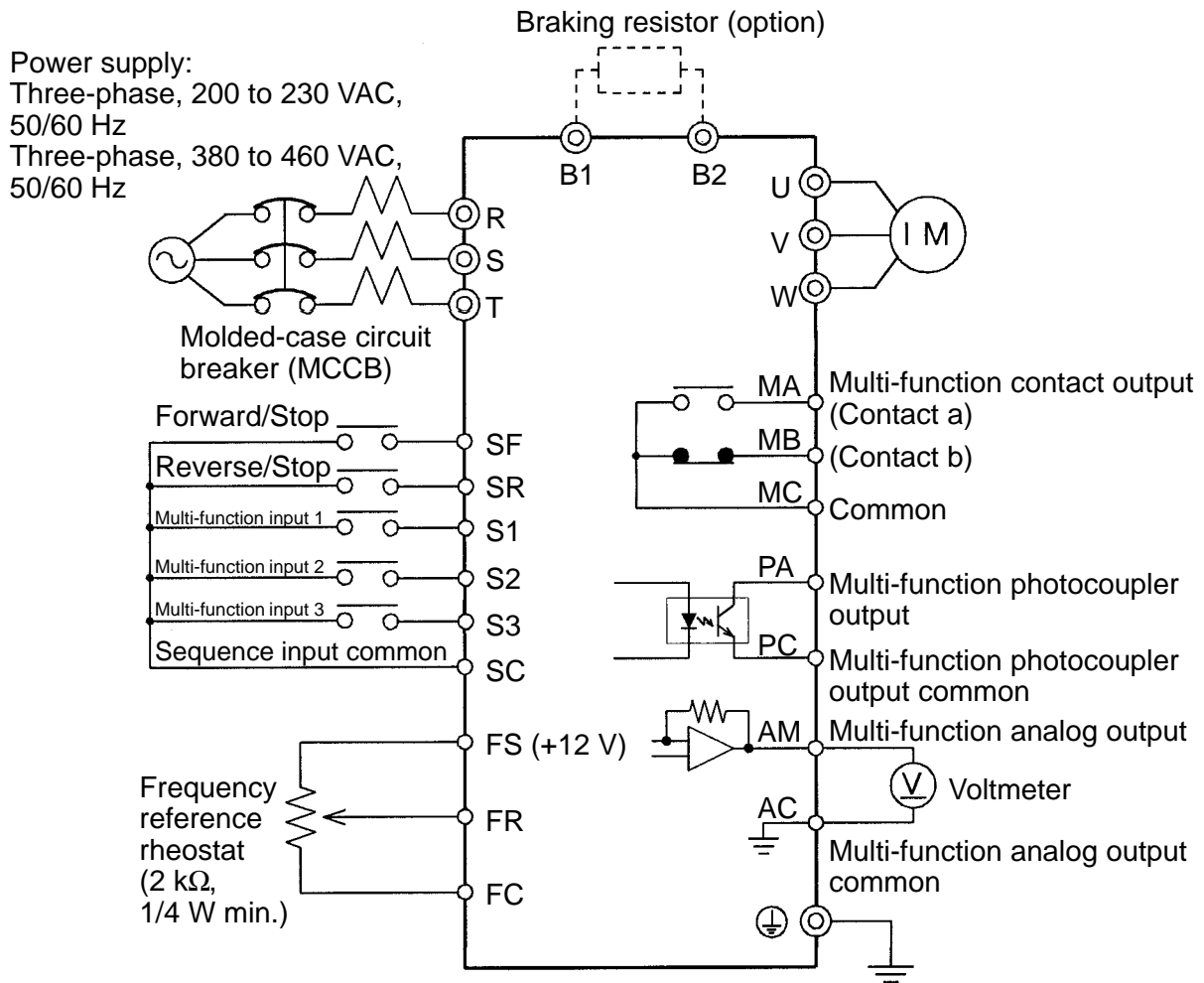

Note 1. If a 3G3EV-AB M is used in single-phase input mode, single-phase 200 to 240 VAC power with a frequency of 50/60 Hz must be input between terminals R and S.

Note 2. For the 3-wire sequence, refer to the wiring on page 4-13.

Note 3. The input sequence power is built in.

3-2-2 Wiring Around the Main Circuit

System reliability and noise resistance are affected by the wiring method used. Therefore, always follow the instructions given below when connecting the Inverter to peripheral devices and other parts.

■ Wire Size and Molded-Case Circuit Breaker to be Used

For the main circuit and ground, always use 600-V polyvinyl chloride (PVC) cables. If the cable is long and may cause voltage drops, increase the wire size according to the cable length.

Model	Terminal symbol	Terminal screw	Wire size (mm ²)	Molded-case circuit breaker capacity (A)
3G3EV-A2001M(-)	R S T B1 B2	M3.5	0.75 to 2	10
3G3EV-AB001M(-)	U V W ⚡			5
3G3EV-A2002M(-)	R S T B1 B2	M3.5	0.75 to 2	5
3G3EV-AB002M(-)	U V W ⚡			
3G3EV-A4002M(-)				
3G3EV-A2004M(-)	R S T B1 B2	M3.5	0.75 to 2	5
3G3EV-AB004M(-)	U V W ⚡			10
3G3EV-A4004M(-)				5
3G3EV-A2007M(-)	R S T B1 B2	M3.5	0.75 to 2	10
3G3EV-AB007M(-)	U V W ⚡			20
3G3EV-A4007M(-)				5
3G3EV-A2015M(-)	R S T B1 B2	M3.5	0.75 to 2	20
3G3EV-AB015M(-)	U V W ⚡		1.25 to 2	20
3G3EV-A4015M(-)			0.75 to 2	10

Note Tighten the M3.5 terminal screw to the torque of 0.8 N · m.

Determining the Wire Size

Determine the wire size for the main circuit so that line voltage drop is within 2% of the rated voltage.

Line voltage drop V_D is calculated as follows:

$$V_D (V) = \sqrt{3} \times \text{wire resistance } (\Omega/\text{km}) \times \text{wire length (m)} \times \text{amperage (A)} \times 10^{-3}$$

● Calculating the Inverter Input Power Supply Capacity

The following formula can generally be used to calculate the input power supply capacity for the Inverter. Always select an Inverter with more than sufficient capacity.

Input power supply capacity [kVA] =
 Motor output [kW]/(Motor efficiency x Inverter efficiency x Inverter input power factor)
 Normal motor efficiency = 0.8, Normal inverter efficiency = 0.9,
 Inverter input power factor = 0.65 to 0.9

Note The Inverter's input power factor will vary with the impedance of the power supply facilities. Use 0.9 when using an AC reactor and 0.65 when not using an AC reactor.

For the input current, divide the input power supply capacity by the input voltage. Assuming the Inverter's resistance to overloads to be 150%, the calculated value can be multiplied by 1.5.

Example for 3-phase 200 V: $1.5 \times \text{input power supply capacity} / (\sqrt{3} \times 200 \text{ V})$
 Example for single-phase 200 V: $1.5 \times \text{input power supply capacity} / 200 \text{ V}$

■ Wiring on the Input Side of Main Circuit

● Installing a Molded-case Circuit Breaker

Always connect the power input terminals (R/L1, S/L2, and T/L3) and power supply via a molded case circuit breaker (MCCB) suitable to the Inverter.

- Install one MCCB for every Inverter used.
- Choose an appropriate MCCB capacity according to the *Circuit breaker capacity* column in the table on the previous page.
- For the MCCB's time characteristics, be sure to consider the Inverter's overload protection (one minute at 150% of the rated output current).
- If the MCCB is to be used in common among multiple Inverters, or other devices, set up a sequence such that the power supply will be turned off by a fault output.

● Installing a Ground Fault Interrupter

Inverter outputs use high-speed switching, so high-frequency leakage current is generated.

In general, a leakage current of approximately 100 mA will occur for each Inverter (when the power cable is 1 m) and approximately 5 mA for each additional meter of power cable.

Therefore, at the power supply input area, use a special-purpose breaker for Inverters, which detects only the leakage current in the frequency range that is hazardous to humans and excludes high-frequency leakage current.

- For the special-purpose breaker for Inverters, choose a ground fault interrupter with a sensitivity amperage of at least 10 mA per Inverter.
- When using a general leakage breaker, choose a ground fault interrupter with a sensitivity amperage of 200 mA or more per Inverter and with an operating time of 0.1 s or more.

● Installing a Magnetic Contactor

If the power supply for the main circuit is to be shut off because of the sequence, a magnetic contactor can be used instead of a molded-case circuit breaker.

However, when a magnetic contactor is installed on the primary side of the main circuit to forcibly stop a load, note that regenerative braking does not work and the load coasts to a stop.

- A load can be started and stopped by opening and closing the magnetic contactor on the primary side. Frequently opening and closing the magnetic contactor, however, may cause the Inverter to break down. In order not to shorten the service life of the Inverter's internal relays and electrolytic capacitors, it is recommended that the magnetic contactor is used in this way no more than once every 30 minutes.
- When the Inverter is operated with a Digital Operator, automatic operation cannot be performed after recovery from a power interruption.

● Connecting Input Power Supply to the Terminal Block

Because the phase sequence of input power supply is irrelevant to the phase sequence (R, S, T) of the terminal block, input power supply can be connected to any terminal on the terminal block.

● Installing an AC Reactor

It is recommended that an AC reactor be inserted in the input power supply side to suppress harmonics.

If the Inverter is connected to a large-capacity power transformer (600 kW or more) or the phase advance capacitor is switched, an excessive peak current may flow through the input power circuit, causing the converter unit to break down. To prevent this, install an optional AC reactor on the input side of the Inverter. This also improves the power factor on the power supply side.

● Installing a Surge Absorber

Always use a surge absorber or diode for the inductive loads to be connected to the Inverter. These inductive loads include magnetic contactors, electromagnetic relays, solenoid valves, solenoids, and magnetic brakes.

● Wiring of Braking Resistor/Braking Resistor Unit

When using an Inverter for loads with a large inertia or for vertical axis loads, regenerative energy will be fed back.

If the regenerative energy exceeds the Inverter capacity, overvoltage will be detected in the main circuit. In such a case, use a Braking Resistor or Braking Resistor Unit.

Note Be sure to create a sequence that will turn OFF the Inverter power supply when resistor overheating occurs. When using a Braking Resistor, be sure to install a

thermal relay to detect resistor overheating. When using a Braking Resistor Unit, use an error output contact. Otherwise, a fire may occur.

3G3EV Model	Braking Resistor (Duty Cycle 3%ED)	Braking Resistor Unit (Duty Cycle 10%ED)	Minimum connected resistance
A2001M(-)/AB001M(-)	3G3IV-PERF150WJ401 (400 Ω)	---	200 Ω
A2002M(-)/AB002M(-)			200 Ω
A2004M(-)/AB004M(-)	3G3IV-PERF150WJ201 (200 Ω)	3G3IV-PLKEB20P7 (200 Ω 70 W)	200 Ω
A2007M(-)/AB007M(-)			80 Ω
A2015M(-)/AB015M(-)	3G3IV-PERF150WJ101 (100 Ω)	3G3IV-PLKEB21P5 (100 Ω 260 W)	60 Ω
A4002M(-)/A4004M(-)	3G3IV-PERF150WJ751 (750 Ω)	3G3IV-PLKEB40P7 (750 Ω 70 W)	750 Ω
A4007M(-)			510 Ω
A4015M(-)	3G3IV-PERF150WJ401 (400 Ω)	3G3IV-PLKEB41P5 (400 Ω 260 W)	240 Ω

Note Do not use a Resistor whose resistance is below the minimum connected resistance. Otherwise, the Inverter will be damaged.

● **Installing a Noise Filter on the Power Supply Side**

Install a noise filter to eliminate noise transmitted between the power line and the Inverter.

Wiring Example

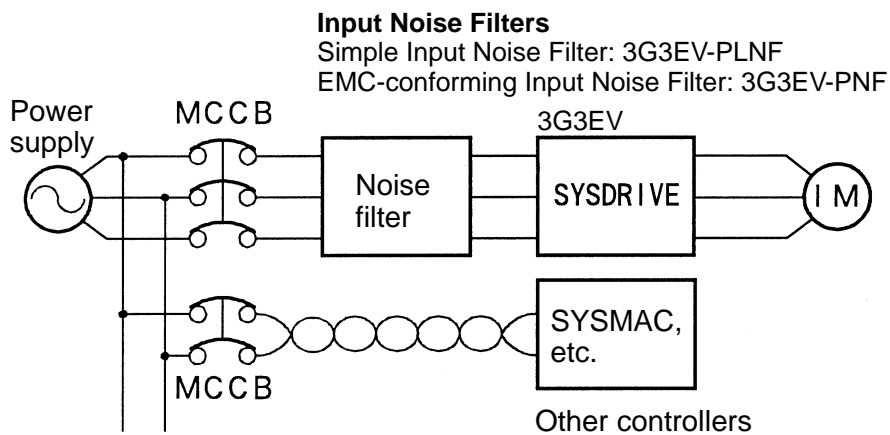

Note Use a noise filter designed for Inverters. A general-purpose noise filter will be less effective and may not reduce noise.

■ Wiring on the Output Side of Main Circuit

● Connecting the Terminal Block to the Load

Connect output terminals U, V, and W to motor lead wires U, V, and W, respectively.

● Never Connect Power Supply to Output Terminals

Caution Never connect a power supply to output terminals U, V, and W.

If voltage is applied to the output terminals, the internal mechanism of the Inverter will be damaged.

● Never Short or Ground the Output Terminals

Caution If the output terminals are touched with bare hands or the output wires come into contact with the Inverter casing, an electric shock or grounding will occur. This is extremely hazardous. Also, be careful not to short the output wires.

● Do Not Use a Phase Advance Capacitor or LC/RC Noise Filter

Never connect a phase advance capacitor or LC/RC noise filter to the output circuit. Doing so may result in damage to the Inverter or cause other parts to burn.

● Do Not Use an Electromagnetic Switch

Do not connect an electromagnetic switch or magnetic contactor to the output circuit. If a load is connected to the Inverter during operation, an inrush current will actuate the overcurrent protective circuit in the Inverter.

● Installing a Thermal Relay

This Inverter has an electronic thermal protection function to protect the motor from overheating. If, however, more than one motor is operated with one Inverter or a multipolar motor is used, always install a thermal relay (THR) between the Inverter and the motor and set to "0.0" (no thermal protection) for constant No. 31 ("THR" indicator).

In this case, program the sequence so that the magnetic contactor on the input side of the main circuit is turned off by the contact of the thermal relay.

● Installing a Noise Filter on the Output Side

Connect a noise filter to the output side of the Inverter to reduce radio noise and induction noise.

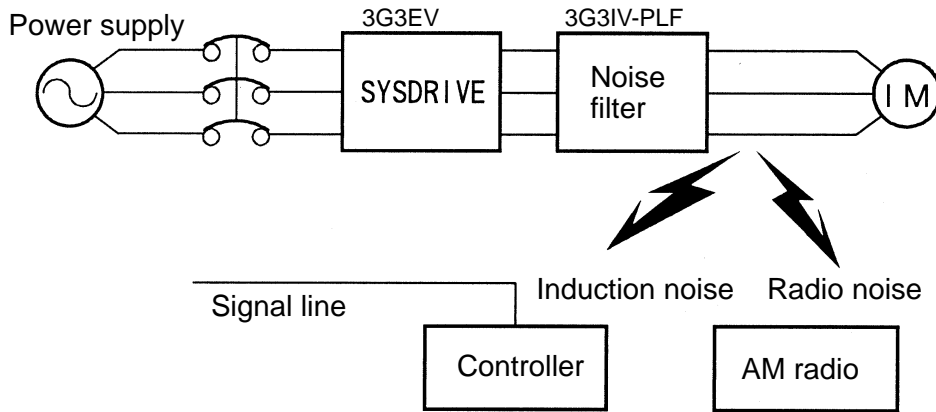

Induction Noise: Electromagnetic induction generates noise on the signal line, causing the controller to malfunction.

Radio Noise: Electromagnetic waves from the Inverter and cables cause the broadcasting radio receiver to make noise.

● How to Prevent Induction Noise

As described above, a noise filter can be used to prevent induction noise from being generated on the output side. Alternatively, cables can be routed through a grounded metal pipe to prevent induction noise. Keeping the metal pipe at least 30 cm away from the signal line considerably reduces induction noise.

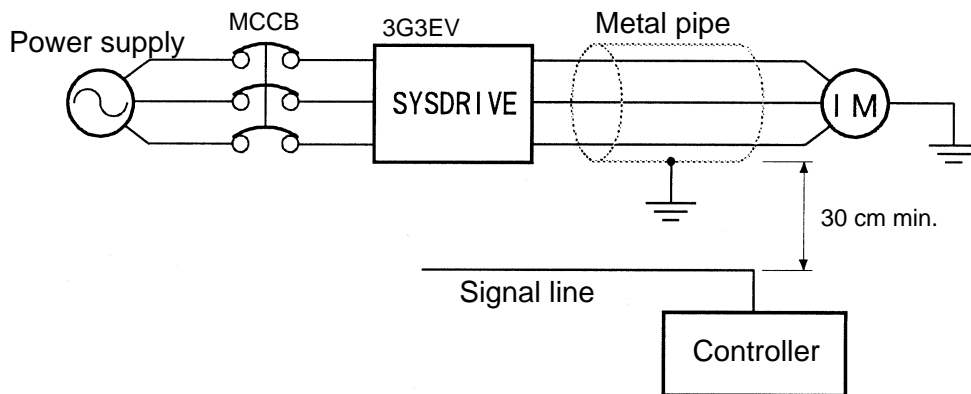

● How to Prevent Radio Noise

Radio noise is generated from the Inverter as well as the input and output lines. To reduce radio noise, install noise filters on both input and output sides, and also install the Inverter in a totally enclosed steel box.

The cable between the Inverter and the motor should be as short as possible.

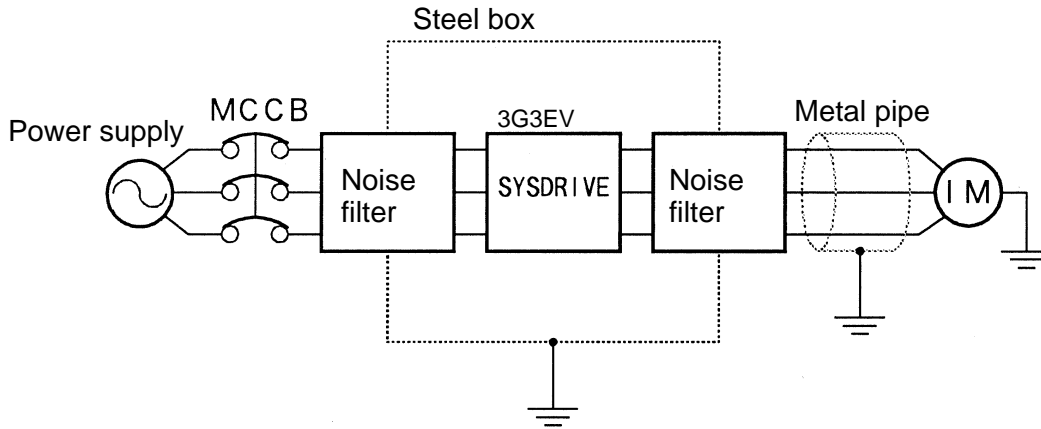

● **Cable Length between Inverter and Motor**

As the cable length between the Inverter and the motor is increased, the floating capacity between the Inverter outputs and the ground is increased proportionally. The increase in floating capacity at the Inverter outputs causes the high-frequency leakage current to increase, and this may adversely affect peripheral devices and the current detector in the Inverter’s output section. To prevent this from occurring, use a cable of no more than 100 meters between the Inverter and the motor. If the cable must be longer than 100 meters, take measures to reduce the floating capacity by not wiring in metallic ducts, by using separate cables for each phase, etc.

Also, adjust the carrier frequency (set in n37) according to the cable length between the Inverter and the motor, as shown in the following table.

Cable length between Inverter and motor	50 m max.	100 m max.
Carrier frequency (n37)	10 kHz max. (1, 2, 3, 4)	5 kHz max. (1, 2)

● **Single-phase motors cannot be used.**

The Inverter is not suited for the variable speed control of single-phase motors. The rotation direction of a single-phase motor is determined by the capacitor starting method or phase-splitting starting method to be applied when starting the motor. In the capacitor starting method, however, the capacitor may be damaged by a sudden electric discharge of the capacitor caused by the output of the Inverter. On the other hand, the starting coil may burn in the phase-splitting starting method because the centrifugal switch does not operate.

■ **Ground Wiring**

- Always use a ground terminal with the following ground resistance.
 200-VAC Class: 100 Ω or less
 400-VAC Class: 10 Ω or less
- For 400-VAC-class models that conform to EC Directives, also connect to the neutral of the power supply.
- Do not share the ground wire with other devices such as a welder or power tool.
- Always use a ground wire that complies with technical standards on electrical equipment. Route the ground wire so that the total length is as short as possible.
- When using more than one Inverter, be careful not to loop the ground wire.

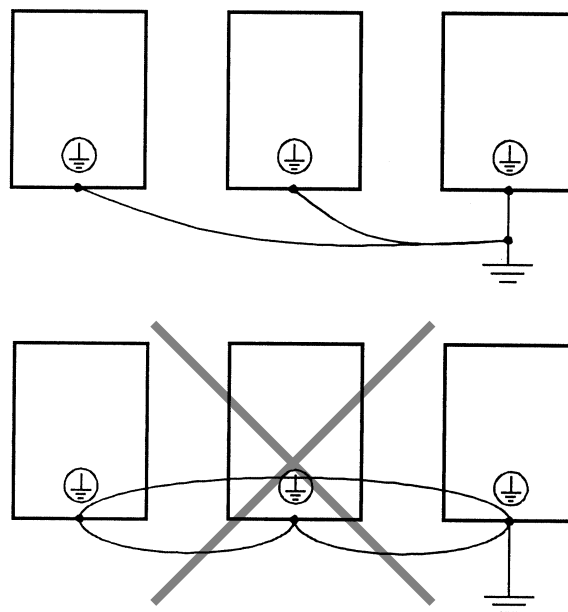

3-2-3 Wiring Control Circuit Terminals

The control signal line must be 50 m or less and must be separated from the power line. If frequency references are input externally, use a twisted-pair shielded line.

■ **Wiring Sequence Input/Output Terminals**

Wire the sequence input terminals (SF, SR, S1 to S3, and SC), multi-function contact output terminals (MA, MB, and MC), and multi-function photocoupler output terminals (PA and PC) as described below.

● **Wires to be Used**

Wire type	Wire size	Wire to be used
Single wire	0.5 to 1.25 mm ²	Polyethylene-shielded cable
Stranded wire	0.5 to 0.75 mm ²	

● **Wiring Method**

- Wire each terminal as follows:
 - a) Loosen the terminal screw with a thin-slotted screwdriver.
 - b) Insert the wire from underneath the terminal block.
 - c) Tighten the terminal screw firmly.
- Always separate the control signal line from the main circuit cables and other power cables.

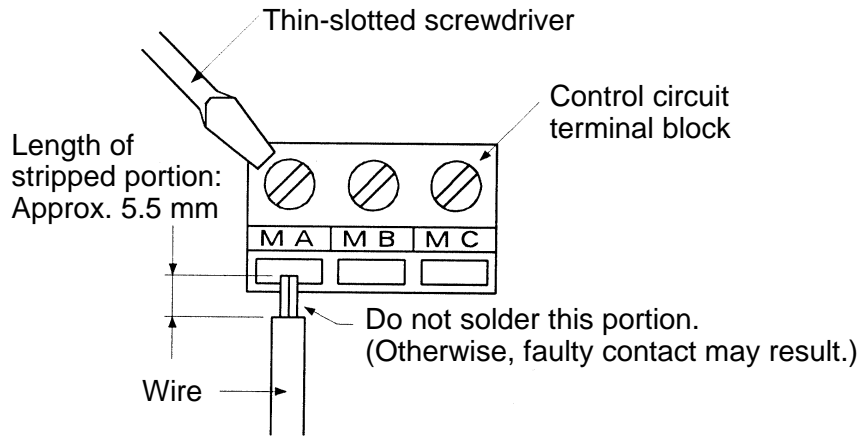

■ **Wiring Frequency Reference Input Terminals**

If frequency references are input using a D/A Unit (digital-to-analog converter) or external power supply, wire the frequency reference input terminals (FR and FC) as described below.

● **Wires to be Used**

Always use twisted-pair shielded wires to prevent malfunctions due to noise.

Wire type	Wire size	Wire to be used
Single wire	0.5 to 1.25 mm ²	Polyethylene-insulated cable for instrumentation (with shield)
Stranded wire	0.5 to 1.25 mm ²	

● Wiring Method

- The wiring procedure is the same as for sequence input/output terminals, described previously.
- Always separate the cables from the main circuit cables and other power cables.
- Connect the shield to the ground terminal of the Inverter. Do not connect to the controller.
- Insulate the shield with tape to prevent it from coming into contact with other signal lines and devices.

■ Tightening Torque of Control Circuit Terminals

Tighten the control circuit terminals to the torque of 0.5 N·m which is the same torque as for the M3 screws.

Note 1. Applying a torque of greater than 0.5 N·m may damage the terminal block.

Note 2. If the tightening torque is insufficient, wires may be disconnected.

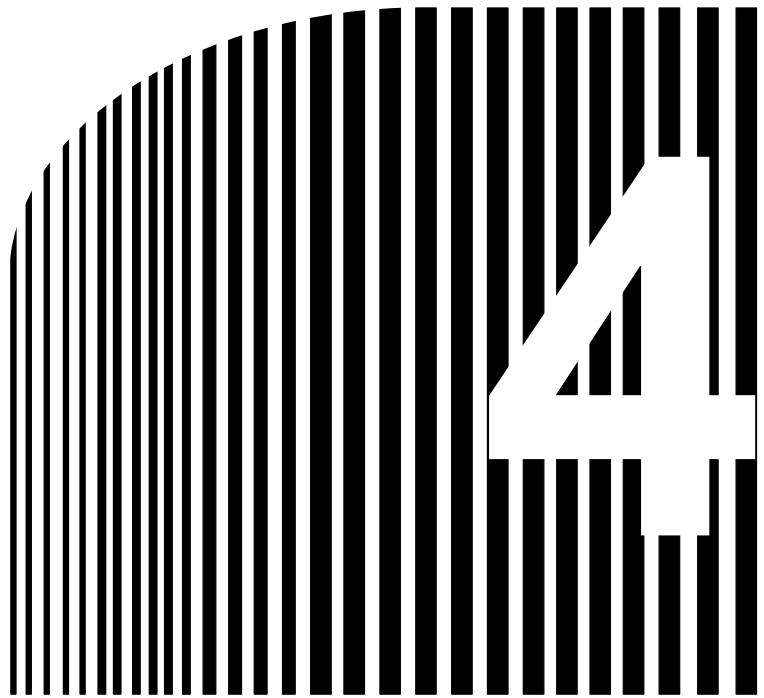

Chapter 4

• Preparing for Operation •

- 4-1 Preparation Procedure
- 4-2 Using the Digital Operator
- 4-3 Test Run

4-1 Preparation Procedure

1. Installation:

Install the Inverter according to installation conditions. Refer to *page 3-2*.

Check that all the installation conditions are met.

2. Wiring:

Connect the Inverter to power supply and peripheral devices. Refer to *page 3-6*.

Select peripheral devices that meet the specifications, and wire them correctly.

3. Turning the Power On:

Check the necessary items, then turn the power on.

Always check that the power voltage is correct and the power input terminals (R, S, and T) are wired correctly.

Power voltage

200-VAC class: Three-phase, 200 to 230 VAC, 50/60 Hz

400-VAC class: Three-phase, 380 to 460 VAC, 50/60 Hz

When a 3G3EV-AB M is used in single-phase input mode, the power voltage must be as follows: single-phase, 200 to 240 VAC, 50/60 Hz (use terminals R and S)

Check that the motor output terminals (U, V, and W) and motor are connected correctly.

Check that the control circuit terminals and controller are connected correctly.

4. Checking Display Status:

Check the Inverter for errors.

If everything is normal, the indicators below become as follows when the power is turned on:

RUN indicator: Flashing

ALARM indicator: Not lit

Constant item indicators: "FREF," "FOUT," or "IOUT" is lit.

Data display: Data corresponding to the constant item indicators is displayed.

If an error exists, the ALARM indicator lights up. In this case, take the necessary action as described in *Section 5 Operation*.

5. Setting Constants:

Use the Digital Operator to set constants required for operation. Refer to *page 4-3*.

Specify each constant as described in this manual.

6. Test Run:

Perform a no-load test run and an actual loading test run to check that the motor and peripheral devices operate normally. Refer to *page 4-39*.

Check the direction of motor rotation and check that the limit switches operate normally. Operate the Inverter with the Digital Operator first, then with the controller.

7. Production Run:

The Inverter is ready to run. If any error has occurred, refer to *Section 5 Operation*.

4-2 Using the Digital Operator

4-2-1 Name and Function of Each Component

■ Name of Each Component

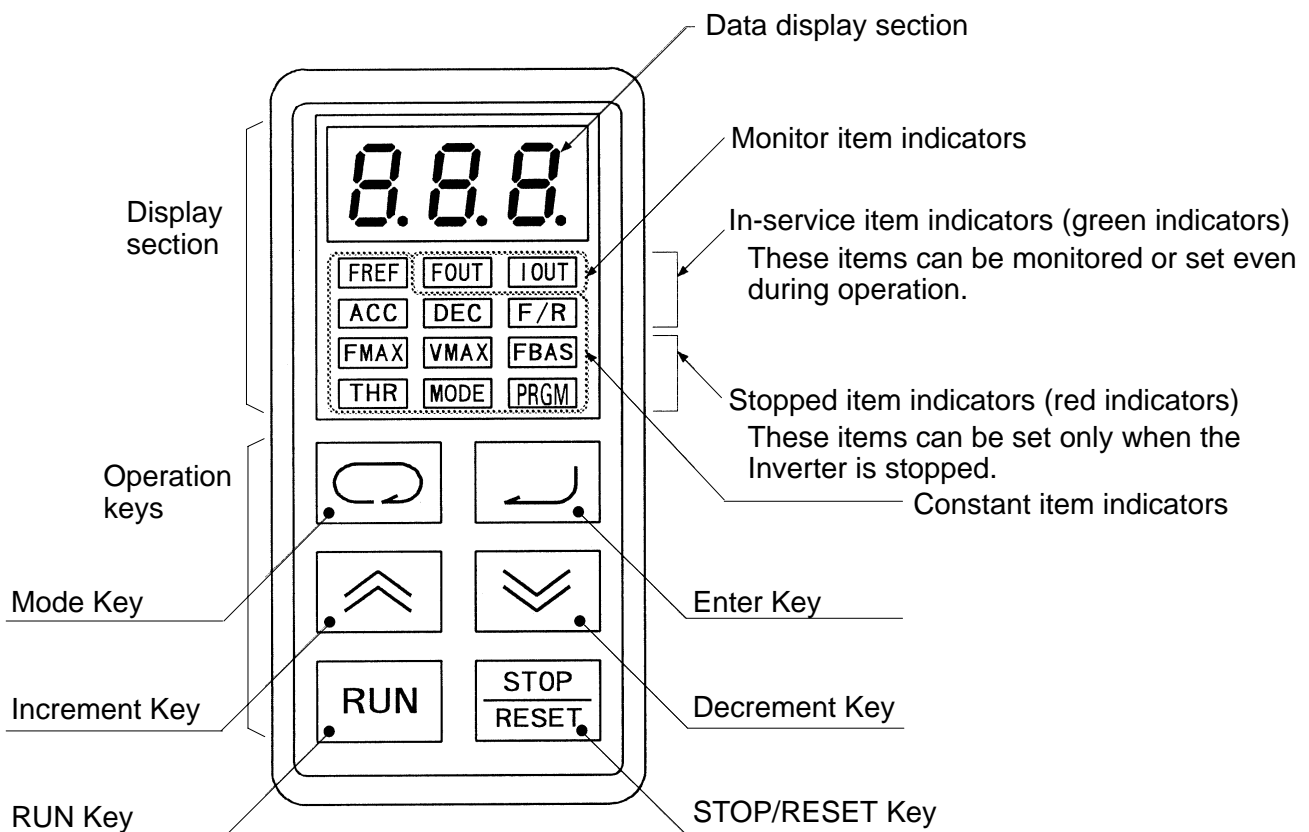

■ Function of Each Component

● Display Sections

Data display section	Reference frequency values, output frequency values, output current values, constant settings, and error codes are displayed.
Monitor item indicators	<div style="border: 1px solid black; padding: 2px; display: inline-block;">FOUT</div> When this indicator is lit, an output frequency value (Hz) is displayed in the data display section. <div style="border: 1px solid black; padding: 2px; display: inline-block;">IOUT</div> When this indicator is lit, an output current value (effective current: A) is displayed in the data display section.
Constant item indicators	The value set in the constant corresponding to the lit indicator is displayed in the data display section. A new value can be set.





Note In-service item indicators (green indicators):

These items can be monitored or the constant for each item can be set even during operation.

Stopped item indicators (red indicators):

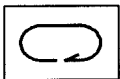
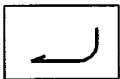
Constants for these items can be set only when the Inverter is stopped. In this display, the direction of motor rotation is displayed during operation.

● Operation Keys

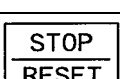
	Mode Key	Press this key to switch between monitor item indicators and constant item indicators.
	Enter Key	Press this key to register the value set in a constant.
	Increment Key	Press this key to increase a constant no. or the value of a constant.
	Decrement Key	Press this key to decrease a constant no. or the value of a constant.
	RUN Key	Press this key to start the Inverter. (This key is valid only when Digital Operator run mode is selected and all indicators in the stopped item indicators are not lit.)
	STOP/RESET Key	Press this key to stop the Inverter. (This key is valid only when Digital Operator run mode is selected.) Also, press this key to reset the Inverter when an error has occurred. Note The reset will work only when the RUN command is OFF.

Note When the constant n01 is set to “0,” no items other than FREF and n01 can be set. If settings cannot be changed using the operation keys, set n01 to “1.”

4-2-2 Outline of Operation

■ Switching Data Display during Operation

Press the Mode Key to switch data display.
 During operation, only the items in the in-service item indicators section can be monitored and the constants for these items can be set.
 If the power is turned off when the FOUT or IOOUT indicator is lit, the same indicator lights up next time the power is turned on. Otherwise, the FREF indicator always lights up.

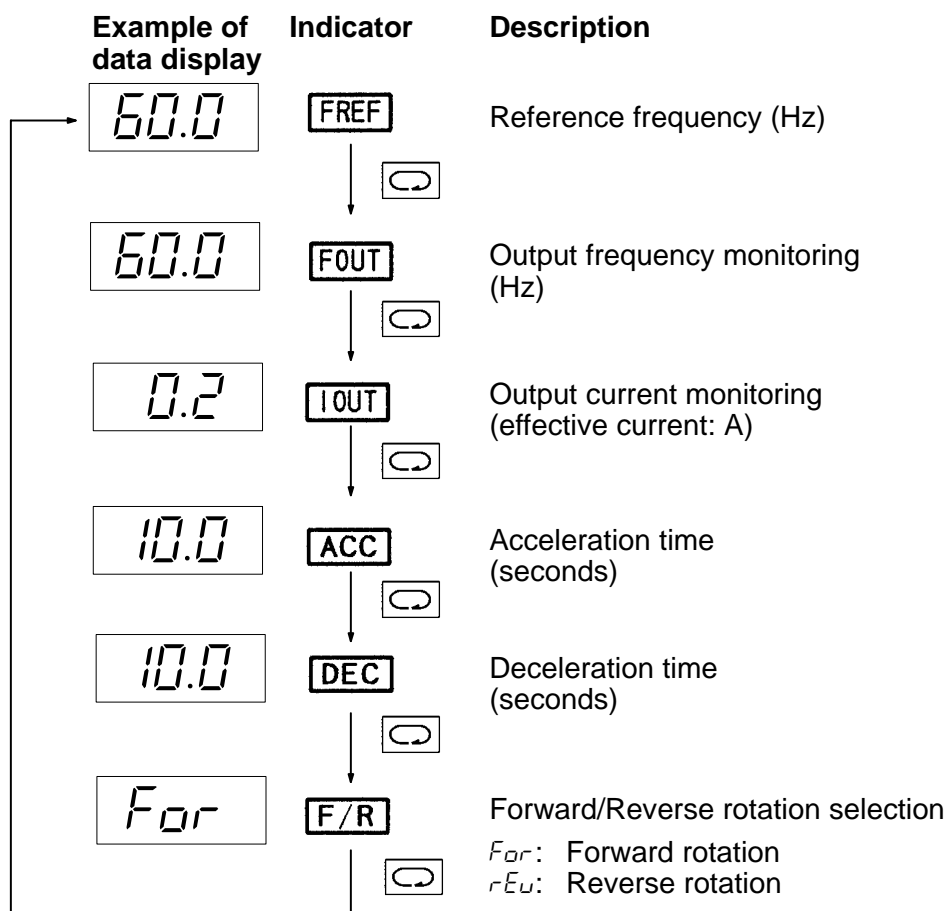

■ Switching Data Display when Inverter is Stopped

Press the Mode Key to switch data display.
 When the Inverter is stopped, all items can be monitored and the constant for each item can be set.

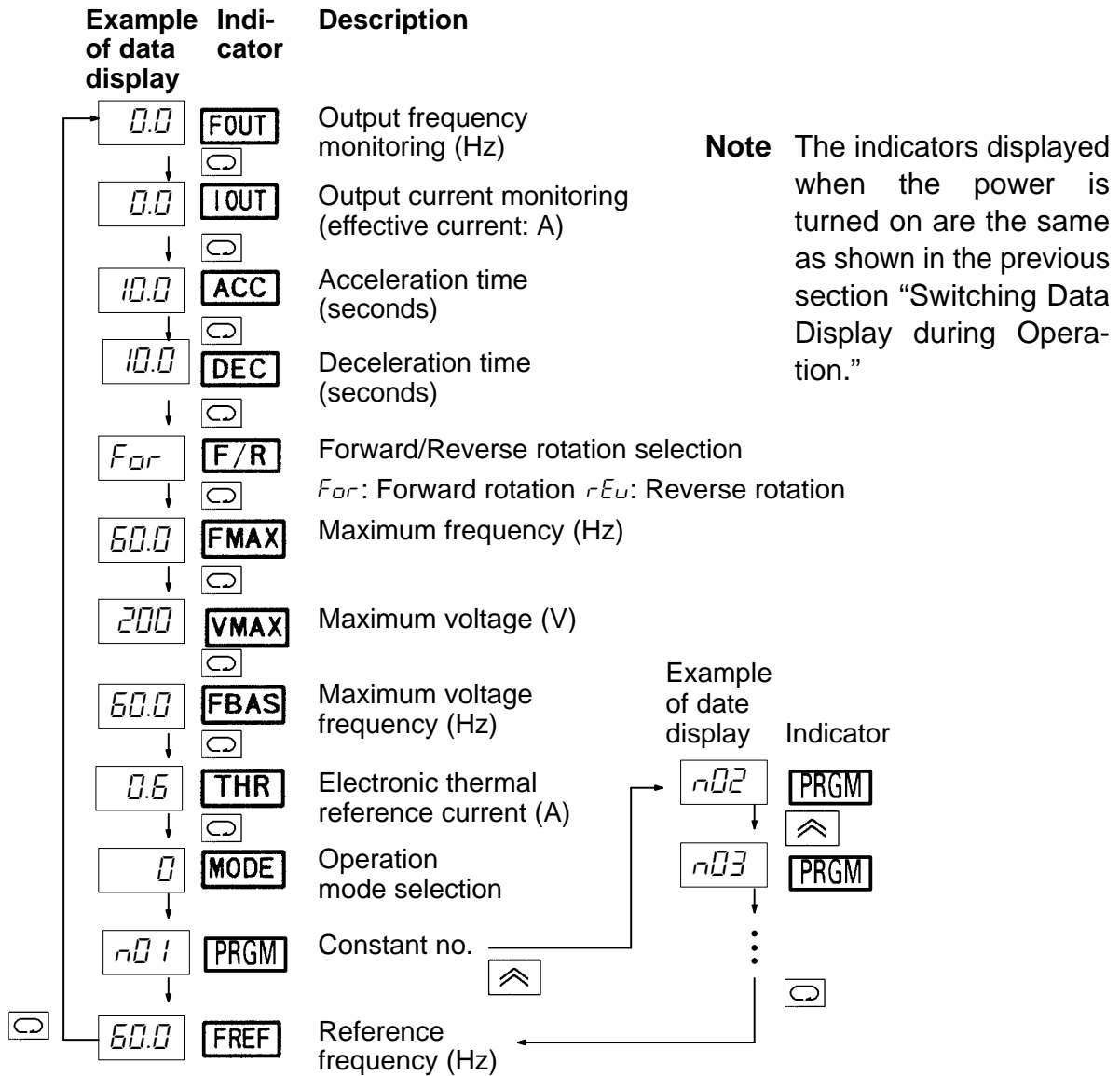

■ Monitor Display

The 3G3EV allows the user to monitor the reference frequency, output frequency, output current, and the direction of rotation.

● Operation Method

Key operation	Indicator	Example of data display	Description
			Press the Mode Key until the FREF indicator lights up. The reference frequency (Hz) is displayed.
			Press the Mode Key. The output frequency (Hz) is displayed.
			Press the Mode Key. The output current value (effective current: A) is displayed.

Note 1. The direction of rotation can be always monitored during operation. The indicators in the lower two rows of the display section flash indicating the direction of rotation. The indicator flashing speed varies according to the speed of rotation.

Indicator flashing sequence during forward rotation

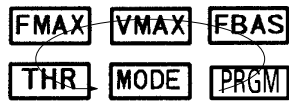

The indicators flash counterclockwise when the motor rotates in the forward direction.

Note 2. The constant item indicators section has the F/R indicator, but this indicator is used to indicate a command when the Inverter is operated with the Digital Operator.

4-2-3 Setting Constants

The 3G3EV (Multi-function Model) allows the user to set about 60 different constants. The constants for basic operations are allocated to dedicated indicators, so the user need not refer to the constant nos. The constants allocated to dedicated indicators can be also set by lighting the PRGM indicator.





Note that the operation methods using dedicated indicators and the PRGM indicator are different.

■ Setting Constants

● Setting Constants Using a Dedicated Indicator

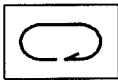
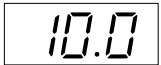
Example:

Changing acceleration time from 10 seconds to 50 seconds.

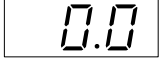
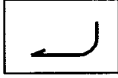
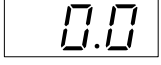
Key operation	Indicator	Example of data display	Explanation
	ACC		Press the Mode Key until the ACC indicator lights up.
	ACC	Flashing 	Press the Increment Key. The data display section flashes (indicating that the data is yet to be registered).
	ACC	Flashing 	Press the Increment Key until "50.0" appears in the data display section. Holding down the key changes data quickly.
	ACC		Press the Enter Key to complete the setting procedure.

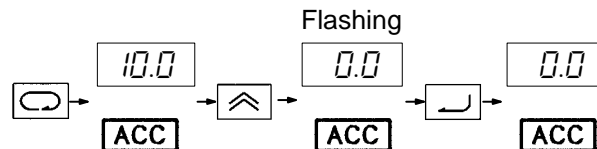

Note If the new data is not to be registered, press the Mode Key instead of the Enter Key. The new data becomes invalid and the next item is displayed.

● Setting Constants Using the PRGM Indicator

Example:

Changing the value of constant no. 02 (operation mode selection) to “3.”

Key operation	Indicator	Example of data display	Explanation
	PRGM	n01	Press the Mode Key until the PRGM indicator lights up.
	PRGM	n02	Press the Increment Key. “n02” appears in the data display section.
	PRGM	0	Press the Enter Key. The value of constant no. 02 is displayed.
	PRGM	Flashing 3	Change the value to “3” by pressing the Increment Key. The data display section flashes (indicating that the value is yet to be registered).
	PRGM	3	Press the Enter Key. The data display section stops flashing.
	PRGM	n02	After approximately 0.5 second, the data display section returns to the constant no. display (“n02”).

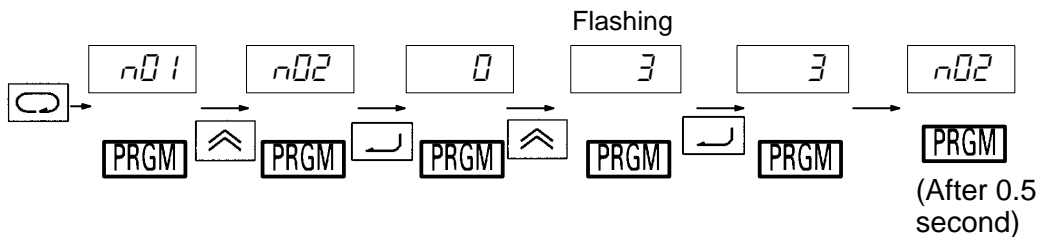

Note 1. If the new data is not to be registered, press the Mode Key instead of the Enter Key. The new data becomes invalid and the constant no. display (“n02”) is returned.

Note 2. Holding down the Increment Key or Decrement Key changes data quickly.

■ List of Constants

Constant no.	Dedicated indicator	Description	Setting range	Factory setting
n01		Constant write-inhibit selection/constant initialization	0, 1, 8, 9	1
n02	MODE	Operation mode selection	0 to 5	0
n03		Interrupt mode selection	0, 1	0
n04	F/R	Forward/reverse rotation selection	For, rEv	For

Constant no.	Dedicated indicator	Description	Setting range	Factory setting
n05		Reverse rotation-inhibit selection	0, 1	0
n06		Multi-function input selection 1 (S1)	0 to 14	1
n07		Multi-function input selection 2 (S2)	1 to 14	2
n08		Multi-function input selection 3 (S3)	1 to 15	4
n09		Multi-function output selection 1 (MA and MB)	0 to 10	1
n10		Multi-function output selection 2 (PA)	0 to 10	0
n11	FREF	Frequency reference 1	0.0 to 400	6.0 (Hz)
n12	FREF	Frequency reference 2	0.0 to 400	0.0 (Hz)
n13	FREF	Frequency reference 3	0.0 to 400	0.0 (Hz)
n14	FREF	Frequency reference 4	0.0 to 400	0.0 (Hz)
n15	FREF	Frequency reference 5	0.0 to 400	0.0 (Hz)
n16	FREF	Frequency reference 6	0.0 to 400	0.0 (Hz)
n17	FREF	Frequency reference 7	0.0 to 400	0.0 (Hz)
n18	FREF	Frequency reference 8	0.0 to 400	0.0 (Hz)
n19		Inching frequency command	0.0 to 400	6.0 (Hz)
n20	ACC	Acceleration time 1	0.0 to 999	10.0 (seconds)
n21	DEC	Deceleration time 1	0.0 to 999	10.0 (seconds)
n22	ACC	Acceleration time 2	0.0 to 999	10.0 (seconds)
n23	DEC	Deceleration time 2	0.0 to 999	10.0 (seconds)
n24	FMAX	Maximum frequency	50.0 to 400	60.0 (Hz)
n25	VMAX	Maximum voltage	1 to 255 (see note 1)	200 (V) (see note 1)
n26	FBAS	Maximum voltage frequency	0.6 to 400	60.0 (Hz)
n27		Intermediate output frequency	0.1 to 399	1.5 (Hz)
n28		Intermediate output frequency voltage	1 to 255 (see note 1)	12 (V) (see note 1)
n29		Minimum output frequency	0.1 to 10.0	1.5 (Hz)
n30		Minimum output frequency voltage	1 to 50 (see note 1)	12 (V) (see note 1)

Constant no.	Dedicated indicator	Description	Setting range	Factory setting
n31	THR	Electronic thermal reference current	0.0 to see note 2	See note 2
n32		Electronic thermal protection	0 to 4	0
n33		Stall prevention during deceleration	0, 1	0
n34		Stall prevention level during acceleration	30 to 200	170 (%)
n35		Stall prevention level during operation	30 to 200	160 (%)
n36		Operation after recovery from instantaneous power interruption	0, 1, 2	0
n37		Carrier frequency	1, 2, 3, 4 (see note 3)	4 (see note 4)
n38		Automatic torque boost gain	0.0 to 3.0	1.0
n39		Frequency reference gain	0.10 to 2.55	1.00 (times)
n40		Frequency reference bias	-99 to 99	0 (%)
n41		Frequency reference upper limit	0 to 110	100 (%)
n42		Frequency reference lower limit	0 to 110	0 (%)
n43		Frequency reference input terminal	0, 1	0
n44		Multi-function analog output	0, 1	0
n45		Multi-function analog output gain	0.00 to 2.00	0.30
n46		DC control current	0 to 100	50 (%)
n47		Interruption DC control time	0.0 to 5.0	0.5 (seconds)
n48		Startup DC control time	0.0 to 5.0	0.0 (seconds)
n49		S-shape acceleration and deceleration characteristic	0 to 3	0
n50		Over-torque detection	0 to 4	0
n51		Over-torque detection level	30 to 200	160 (%)
n52		Over-torque detection time	0.1 to 10.0	0.1 (seconds)
n53		Frequency detection level	0.0 to 400	0.0 (Hz)
n54		Slip compensation gain	0.0 to 9.9	0.0 (%)
n55		Motor current with no load	0 to 99	40 (%)
n56		Jump frequency 1	0.0 to 400	0.0 (Hz)
n57		Jump frequency 2	0.0 to 400	0.0 (Hz)
n58		Jump frequency 3	0.0 to 400	0.0 (Hz)

Constant no.	Dedicated indicator	Description	Setting range	Factory setting
n59		Jump width	0.0 to 25.5	1.0 (Hz)
n60		Number of fault retries	0 to 10	0 (times)
n61		Stop Key selection	0, 1	0
n62		Slip compensation primary delay time	0.0 to 25.5	2.0
n63		UP/DOWN command frequency memory	0, 1	0
n64		Operator's frequency setting method	0, 1	0
n68		Error history	(Display only)	
n69		PROM number (for manufacturer's reference)	(Display only)	

Note 1. The upper limit of the setting range and the factory setting for the 400-VAC class are double the above values.

Note 2. The setting range and factory setting for n31 (electronic thermal reference current) depend on the Inverter model. For details, refer to *page 4-24*. Normally, set the rated motor amperage in n31.

Note 3. The setting range for the 400-VAC models is "1 to 5."

Note 4. The factory setting for the 3G3EV-A4015-CUE is "3."

Note 5. Displaying the constant no. corresponding to an indicator in the "Dedicated indicator" column lights the indicator.

Note 6. Constant no. 02 (n02) and subsequent constants can be set only when constant no. 01 (n01) is set to 1.

Constants in the shaded areas in the above table may not be usable depending on the PROM number (software version). Use constant no. 69 (n69) to refer to the PROM number for the models used and make the appropriate settings.

Constant no.	PROM no. (contents of n69)	
	219 or lower	220 or higher
n27	Setting range: 0.5 to 399	Setting range: 0.1 to 399
n29	Setting range: 0.5 to 10.0	Setting range: 0.1 to 10.0
n39	Setting range: 0.10 to 2.00	Setting range: 0.10 to 2.55
n63	No	Yes
n64	No	Yes

Note "Yes" indicates that the constant can be set.
 "No" indicates that the constant cannot be set.

■ Details of Each Constant

n01	Constant Write-Inhibit Selection/Constant Initialization		
Setting range	0, 1, 8, 9	Factory setting	1

One of the following four values can be selected:

Value	Description
0	Only n01 can be set.
1	Constants n01 to n68 can be displayed and set.
8	All constants are returned to factory settings.
9	The Inverter is initialized in 3-wire sequence mode.

Note 1. If other constants are to be set, always set “1” in n01. The items with the dedicated indicators can be set independently of constant No. 01 (n01).

Note 2. Setting “9” (3-wire sequence mode) in n01 allows the user to start and stop the Inverter with automatic recovery type push-button switches.

Example of 3-wire Sequence Mode

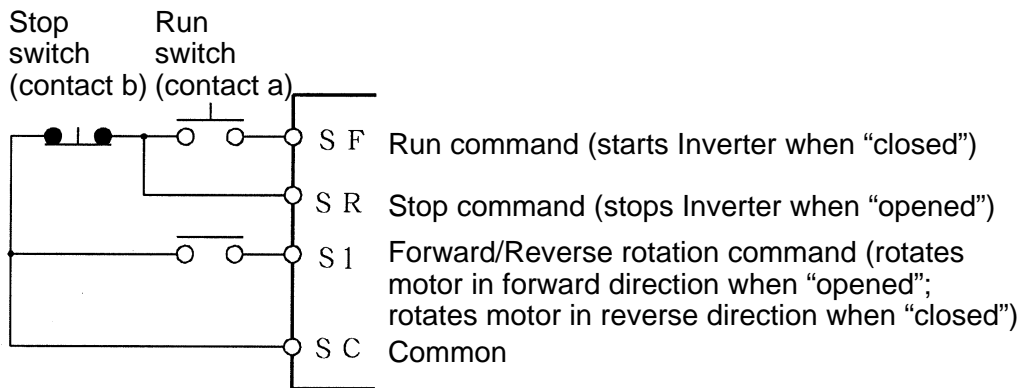

Example of Operation

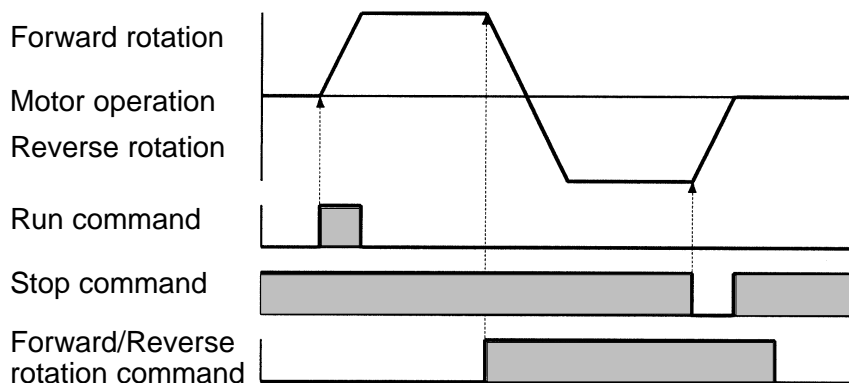

n02	MODE Operation Mode Selection		
Setting range	0 to 5	Factory setting	0

This constant is used to specify whether the Inverter is to be operated with a Digital Operator or external signals.

Value	Run command	Frequency reference	DIP switch setting
0	Digital Operator	Digital Operator (n11)	OFF
1	Control terminal	Digital Operator (n11)	OFF
2	Digital Operator	Control terminal (voltage input)	OFF
3	Control terminal	Control terminal (voltage input)	OFF
4	Digital Operator	Control terminal (amperage input)	ON
5	Control terminal	Control terminal (amperage input)	ON

Note 1. The above setting operation can be performed when constant no. 02 is selected. This operation is also possible when the dedicated indicator (“MODE”) is lit.

Note 2. The DIP switch is located inside the Inverter. Use this switch to change the setting when frequency references are to be input in terms of amperage (4 to 20 mA). For details, refer to *Section 7-2 Frequency Reference by Amperage Input*. For voltage input, never set the DIP switch to ON. Doing so may damage the equipment.

Note 3. If the frequency references (to be set to 2, 3, 4 or 5) are set through the control terminals, analog command input will be treated as frequency reference 1. If the multi-step speed command is used for multi-function input, frequency references 2 to 8 will be available.

n03	Interruption Mode Selection		
Setting range	0, 1	Factory setting	0

This constant is used to specify the interruption mode when the STOP/RESET Key is pressed or the operation command is OFF.

Value	Description
0	Frequency deceleration stop
1	Free running

Example of Frequency Deceleration Stop

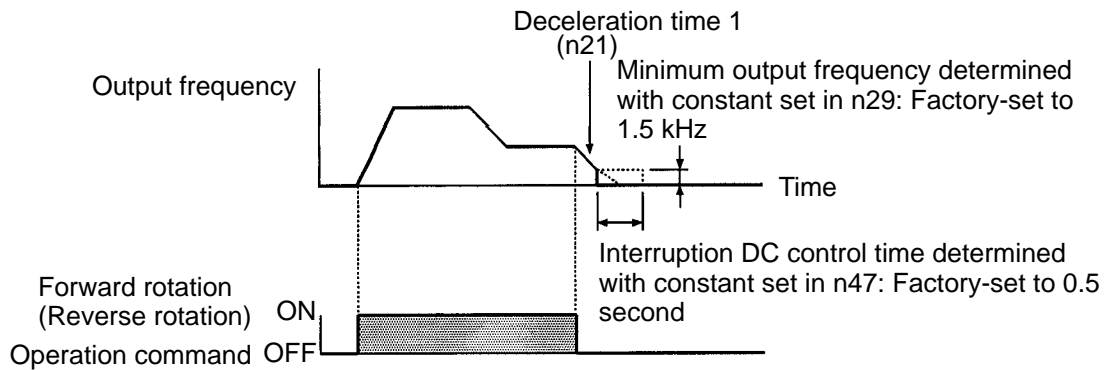

Note If the RUN signal is input again during a deceleration stop, deceleration will be stopped at the point of the input and acceleration will proceed at that frequency.

Example of Free Running

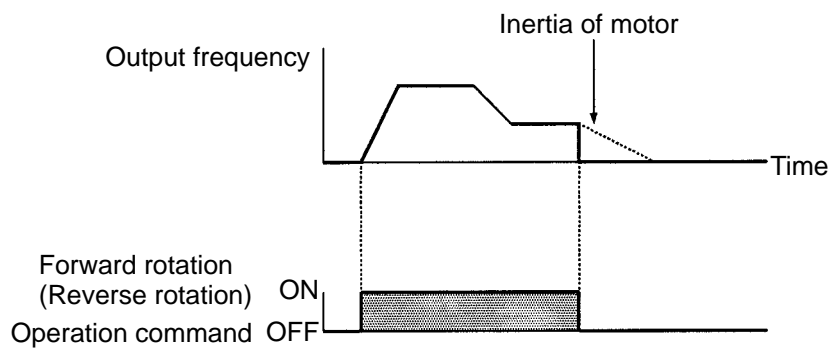

Note Do not input a RUN signal during a free-running stop if the motor's rotation speed is not sufficiently slowed. If a RUN signal is input under these conditions, a main circuit overvoltage (OV) or overcurrent (OC) will be detected.

To restart a free-running motor, set a speed search command in one of the multi-function inputs 1 to 3 (n06 to n08), use the speed search to detect the speed of the free running motor, and then accelerate smoothly.

n0	[F/R] Forward/Reverse Rotation Selection		
Setting range	F_{or} , rE_u	Factory setting	F_{or} (forward rotation)

This constant is used to specify the direction of motor rotation when the Inverter is operated with the Digital Operator.

Value	Description
F_{or}	Forward rotation
rE_u	Reverse rotation

Note 1. While the Inverter is being operated with the Digital Operator, the direction of motor rotation can be changed by lighting the F/R indicator with the Mode Key first, pressing the Increment or Decrement Key to change the setting, then pressing the Enter Key.

Note 2. The direction (forward/reverse) of motor rotation depends on the motor model used. Refer to the instruction manual for the motor.

n0	Reverse Rotation-inhibit Selection		
Setting range	0, 1	Factory setting	0

This constant is used to specify whether to enable or disable the reverse rotation command sent to the Inverter from the control circuit terminal or Digital Operator. If the constant is set to “not accept,” no reverse rotation command will be accepted by the Inverter. The constant should be set to “not accept” when the Inverter is applied to systems that prohibit the reverse rotation of the Inverter.

Value	Description
0	Accept
1	Not accept

n06	Multi-function Input Selection 1		
Setting range	0 to 14	Factory setting	1 (Fault reset)

n0	Multi-function Input Selection 2		
Setting range	0 to 14	Factory setting	2 (External fault: Contact a)

n0	Multi-function Input Selection 3		
Setting range	0 to 15	Factory setting	4 (Multi-step speed command 1)

One of the following values can be selected for each of the multi-function input constants set in n06, n07, and n08.

Value	Description
0	Forward/reverse rotation command (3-wire sequence)
1	Fault reset (fault reset when ON)
2	External fault (contact a: external fault when ON)
3	External fault (contact b: external fault when OFF)
4	Multi-step speed command 1
5	Multi-step speed command 2
6	Multi-step speed command 3 (also used as acceleration/deceleration time changeover command)
7	Inching command
8	Acceleration/Deceleration time changeover command (acceleration and deceleration time: 2 when ON)
9	External base block command (base block when ON)
10	External base block command (base block when OFF)
11	Search command (Searching starts from maximum frequency)
12	Search command (Searching starts from preset frequency)
13	Acceleration/Deceleration-inhibit command (ON: Maintaining output frequency with no acceleration or deceleration)
14	Local or remote selection (see note 2)
15	Up or down command (set with n08 only) (see note 3)

Note 1. Each of the above values can be used for only one multi-function input constant.

Note 2. If the multi-function input constant is set to 14 (local or remote selection), an external signal can be used to select the Digital Operator or control terminals for the operation of the Inverter. The Digital Operator or control terminals can be, however, selected only when the operation of the Inverter is interrupted.
 OFF: The Inverter is operated according to the run mode set in n02.
 ON: The Inverter is controlled with the Digital Operator.

Note 3. If 15 is set in n08, the constant set in n07 will be invalid, in which case multi-function input 2 (S2) will accept the up command and multi-function input 3 (S3) will accept the down command.

Control circuit terminal S2	ON	OFF	OFF	ON
Control circuit terminal S3	OFF	ON	OFF	ON
Run condition	Acceleration	Decelera- tion	Hold	Hold

The following is the frequency variable range with the up or down command.
 Lower-limit frequency: Minimum output frequency determined with constant set in n29 or frequency reference lower limit determined with constant set in n42, whichever is larger.

Upper-limit frequency: Maximum frequency determined with constant set in n24 x frequency reference upper limit determined with constant set in n41/100.

If a frequency lower than the lower-limit frequency is designated, the lower-limit frequency will be output and if a frequency higher than the upper-limit frequency is designated, the upper-limit frequency will be output.

The acceleration or deceleration rate with the up or down command will conform to the constants set in n21 to n24 for the acceleration or deceleration time.

Adjust the output frequency with the up or down command. The Inverter accepts the up or down command as frequency instruction 1 and the Inverter begins changing its output frequency starting with the lower-limit frequency.

If frequency command 2 to 8 or the inching command is input while the Inverter is increasing or decreasing its output frequency, the Inverter will give priority to the command.

Note 4. If constants of 4, 5, and 6 are set in n06 to n08 respectively, the Inverter will be in 8-step speed operation.

Selected Frequency Command =
 $1 + (\text{multi-step speed command 1}) + (\text{multi-step speed command 2}) \times 2 + (\text{multi-step speed command 3}) \times 4$

Any of the above multi-step speed commands will be set to 1 when the multi-step speed command is ON and 0 when the multi-step speed command is OFF.

Multi-step Speed Operation Example

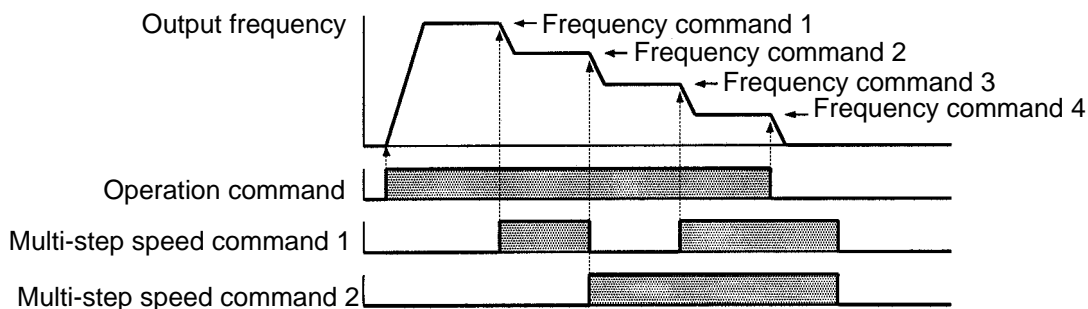

Note Multi-step speed command 3 is also used as the acceleration/deceleration time changeover command. When a frequency command (i.e., frequency command 5 to 8) turning ON multi-step speed command 3 is used, the Inverter will be in acceleration or deceleration operation with the constants set in n22 and n23 for acceleration and deceleration time 2.

n0	Multi-function Output Selection 1 (MA and MB)		
Setting range	0 to 10	Factory setting	1 (Operation in progress)

n10	Multi-function Output Selection 2 (PA)		
Setting range	0 to 10	Factory setting	0 (Fault occurrence)

One of the following values can be specified for the multi-function contact output (MA and MB) and multi-function photocoupler output (PA).

Value	Description
0	Fault occurrence (when ON)
1	Operation in progress (with RUN command input or inverter output)
2	Frequency detection (see note 1)
3	Idling
4	Frequency detection (output frequency is same or higher than frequency detection level determined with constant set in n53.)
5	Frequency detection (output frequency is same or lower than frequency detection level determined with constant set in n53.)
6	Over-torque being monitored
7	Base block in progress
8	UV in progress (undervoltage being monitored)
9	Speed search in progress
10	Run mode (see note 2)

Note 1. The output is turned ON when the difference between the reference frequency and the output frequency falls within 2 Hz. The output is turned OFF when the difference is ± 4 Hz or more.

Note 2. The output is turned ON when LOCAL is selected with the Digital Operator.

Note 3. Use “operation in progress” (set value: 1) or “idling” (set value: 3) setting for the timing for stopping the motor using a brake. To specify a precise stop timing, set “frequency detection 1” (set value: 4) or “frequency detection 2” (set value: 5), and set the frequency detection level (n53).

n11	FREF Frequency Reference 1
Setting range	0.0 to 400 (Hz) Factory setting 6.0 (Hz)

n12 to n18	FREF Frequency References 2 to 8
Setting range	0.0 to 400 (Hz) Factory setting 0.0 (Hz)

- These constants are used to set reference frequency values.
- The unit of setting is as follows:
 0.0 to 99.9 (Hz): 0.1 (Hz)
 100 to 400 (Hz): 1 (Hz)
- The reference frequency value can be changed even during operation. To change the reference frequency value, light the FREF indicator with the Mode Key first, press the Increment or Decrement Key to change the value, then press the Enter Key.
- To change the n12 to n18 settings during operation, select the desired reference frequency with the multi-step speed command, then perform the above operation.
- To use n11 (frequency reference 1) and n12 (frequency reference 2), set “4” (multi-step speed command 1) in one of n06 to n08 (multi-function input selection 1 to 3).
- To use n11 to n14 (frequency references 1 to 4), set “4” (multi-step speed command 1) and “5” (multi-step speed command 2) in two of n06 to n08 (multi-function input selection 1 to 3).
- To use n11 to n18 (frequency references 1 to 8), set “4” (multi-step speed command 1), “5” (multi-step speed command 2), and “6” (multi-step speed command 3) in n06 to n08 (multi-function input selection 1 to 3).

n1	Inching Frequency Command
Setting range	0.0 to 400 (Hz) Factory setting 6.0 (Hz)

- This constant is effective when the multi-function input is set to the inching command.
- When the operation command is input while the inching command is ON, the motor will operate at the frequency conforming to the preset inching frequency.

n20	ACC Acceleration Time 1
Setting range	0.0 to 999 (seconds) Factory setting 10.0 (seconds)

n21	DEC	Deceleration Time 1	
Setting range	0.0 to 999 (seconds)	Factory setting	10.0 (seconds)

n22	ACC	Acceleration Time 2	
Setting range	0.0 to 999 (seconds)	Factory setting	10.0 (seconds)

n23	DEC	Deceleration Time 2	
Setting range	0.0 to 999 (seconds)	Factory setting	10.0 (seconds)

- These constants are used to set acceleration time (required to increase the output frequency from the stopped state to the maximum frequency) and deceleration time (required to decrease the output frequency from the maximum frequency to the stopped state).
(Set the maximum frequency in n24.)
- The unit of setting is as follows:
0.0 to 99.9 (seconds): 0.1 (second)
100 to 999 (seconds): 1 (second)
- Acceleration and deceleration times can be changed even during operation. If, for example, acceleration time is to be changed, light the ACC indicator with the Mode Key first, press the Increment or Decrement Key to change the value, then press the Enter Key. Deceleration time can be also changed in the same way. (Light the DEC indicator before changing the deceleration time.)
These constant settings are always valid regardless of whether the Inverter is operated with the Digital Operator or control input.

Example of n20, n21, n22, and n23 Settings

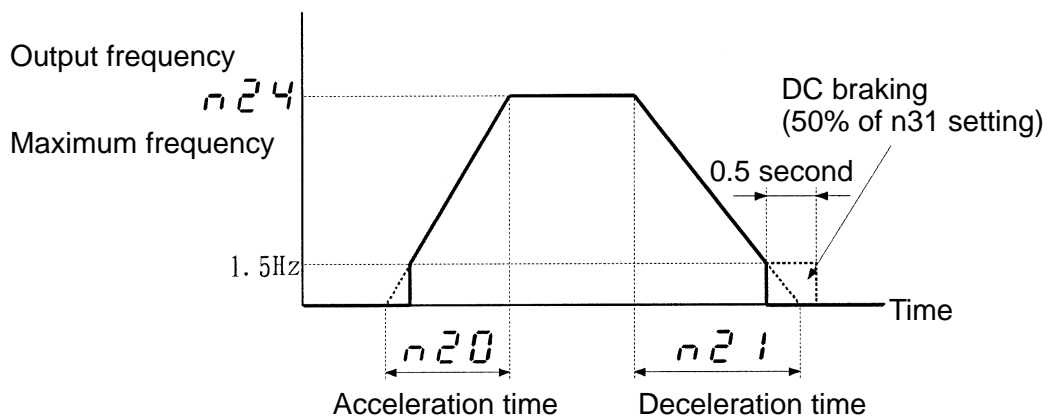

n24	FMAX Maximum Frequency		
Setting range	50.0 to 400 (Hz)	Factory setting	60.0 (Hz)
Unit of setting	50.0 to 99.9 (Hz) : 0.1 (Hz) 100 to 400 (Hz) : 1 (Hz)		

n25	VMAX Maximum Voltage		
Setting range	1 to 255 (510) (V)	Factory setting	200 (400) (V)
Unit of setting	1 (V)		

n26	FBAS Maximum Voltage Frequency (Basic Frequency)		
Setting range	1.6 to 400 (Hz)	Factory setting	60.0 (Hz)
Unit of setting	1.6 to 99.9 (Hz) : 0.1 (Hz) 100 to 400 (Hz) : 1 (Hz)		

Note The values in parentheses are for the 400-VAC class.

- These three constants are used to set a V/f pattern.
- Check the motor specifications and set each constant as follows:
 n24: Maximum frequency or rated frequency
 n25: Rated voltage
 n26: Rated frequency
- The value set in n24 (maximum frequency) must be equal to or greater than the value set in n26 (maximum voltage frequency). Otherwise, an error will result.

Example of n24, n25, and n26 Settings

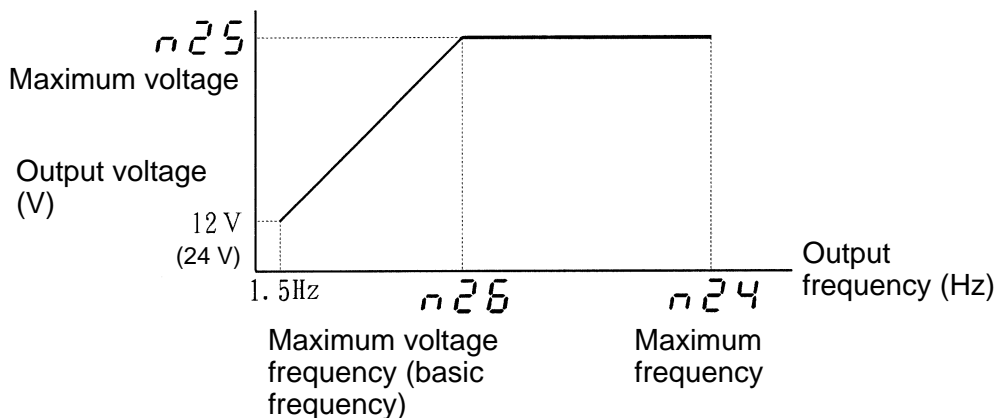

$n2$	Intermediate Output Frequency		
Setting range	0.1 to 399 (Hz)	Factory setting	1.5 (Hz)
Unit of setting	0.1 to 99.9 (Hz) : 0.1 (Hz) 100 to 399 (Hz) : 1 (Hz)		

$n2$	Intermediate Output Frequency Voltage		
Setting range	1 to 255 (510) (V)	Factory setting	12 (24) (V)
Unit of setting	1 (V)		

$n2$	Minimum Output Frequency		
Setting range	0.1 to 10.0 (Hz)	Factory setting	1.5 (Hz)
Unit of setting	0.1 (Hz)		

$n30$	Minimum Output Frequency Voltage		
Setting range	1 to 50 (100) (V)	Factory setting	12 (24) (V)
Unit of setting	1 (V)		

Note The values in parentheses are for the 400-VAC class.

- These constants are effective for the control of any machine the load characteristic of which changes with the rotation of the motor incorporated by the machine, such as a fan and pump. Set the V/f pattern so that it will conform to the torque and frequency characteristics of the motor.
- These constants must satisfy the following condition, otherwise an error will result:
 $n29 \leq n27 < n26 \leq n24$
- If the constant set in $n29$ and that set in $n27$ are the same, the constant set in $n28$ will be ignored.

Example of $n27$, $n28$, $n29$, and $n30$ Settings

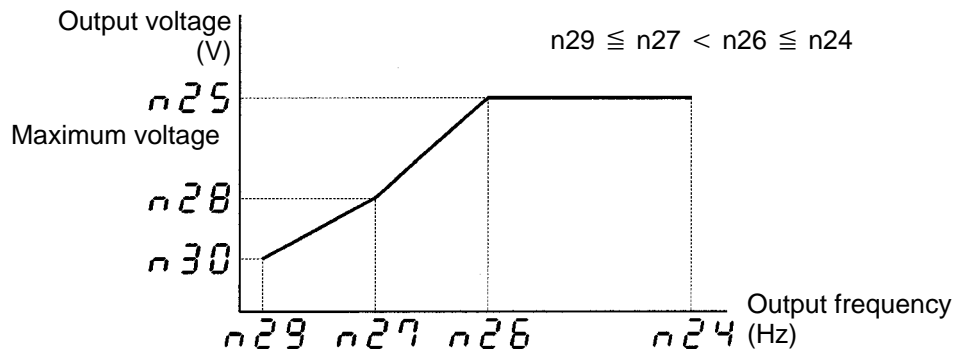

n31	THR Electronic Thermal Reference Current		
Setting range	0.0 to (see note 1) (A)	Factory setting	See note 2
Unit of setting	0.1 (A)		

- This constant is used to set an electronic thermal reference value to protect the motor from overheating.
Set the rated motor amperage in this constant.
- If 0.0 is set in this constant, “no thermal protection” is assumed, so motor overload will not be detected.
- The setting range and factory setting for this constant are as follows:

Note 1. This can be set to a maximum of 120% of the Inverter rated current.

Note 2. Set to the normal rated current of the maximum applicable motor.

n32	Electronic Thermal Protection		
Setting range	0 to 4	Factory setting	0

- This constant is used to set an electronic thermal characteristic.
- If 4 is set in this constant, “no thermal protection” is assumed, so motor overload will not be detected.

Value	Description
0	Standard motor with standard ratings
1	Standard motor with short-time ratings
2	Dedicated motor with standard ratings
3	Dedicated motor with short-time ratings
4	No thermal protection

Note If a single Inverter is used to operate more than one motor, 4 must be set in n32 or 0.0 must be set n31 and a thermal relay must be connected to each of the motors.

n33	Stall Prevention During Deceleration		
Setting range	0, 1	Factory setting	0

This constant is used to select the action to prevent overvoltage during deceleration.

Value	Description
0	Stall prevention during deceleration
1	No stall prevention during deceleration

Note 1. If a braking resistor is to be connected, always set “1” (no stall prevention during deceleration) in this constant.

Note 2. If “0” (stall prevention during deceleration) is set in this constant, deceleration time will be automatically lengthened to prevent overvoltage.

Example of Stall Prevention During Deceleration

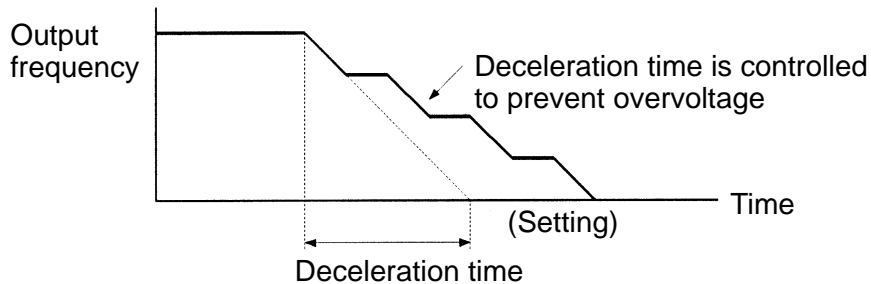

<i>n3</i>	Stall Prevention Level During Acceleration		
Setting range	30 to 200 (%)	Factory setting	170 (%)
Unit of setting	1 (%)		

<i>n3</i>	Stall Prevention Level During Operation		
Setting range	30 to 200 (%)	Factory setting	160 (%)
Unit of setting	1 (%)		

- These constants are used to decrease the output frequency so that the Inverter will continue operating without stalling.
- Set the constants in percent based on the rated inverter current as 100 percent.

Example of Stall Prevention During Acceleration

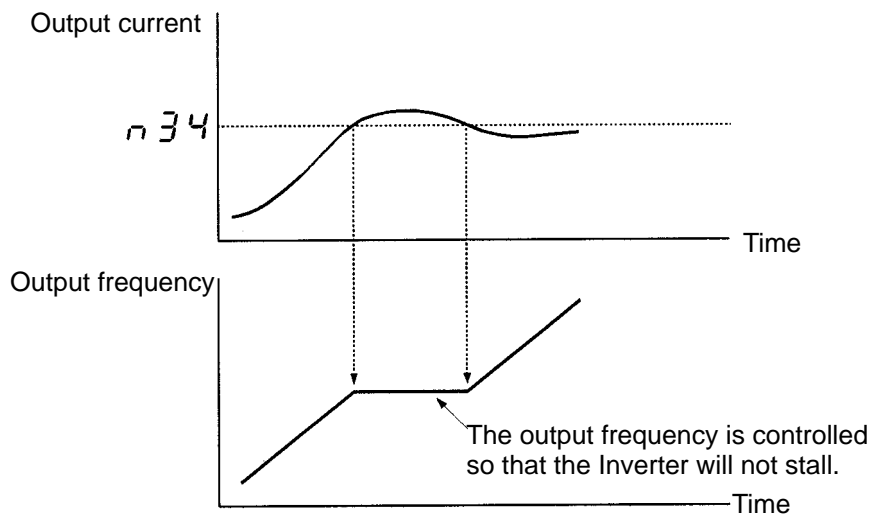

Example of Stall Prevention During Operation

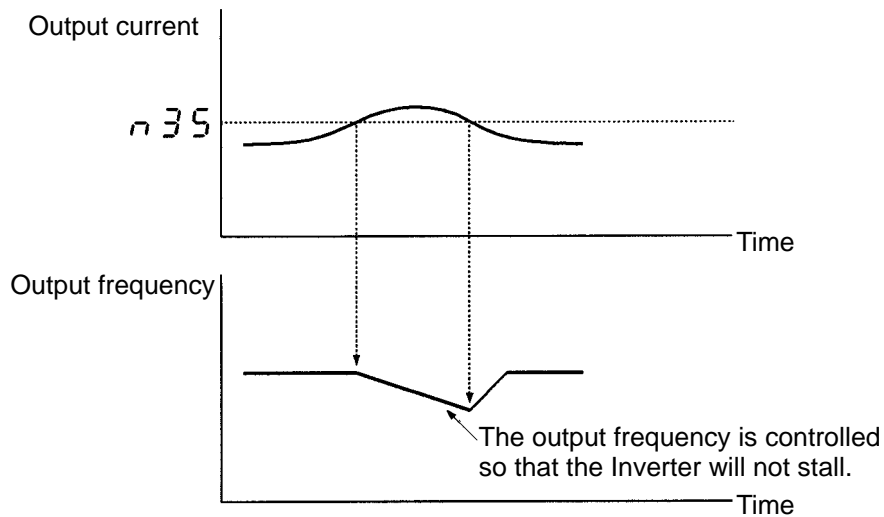

n36	Operation After Recovery from Power Interruption		
Setting range	0, 1, 2	Factory setting	0

This constant is used to select the processing to be performed after recovery from an instantaneous power interruption.

Value	Description
0	Discontinues operation.
1	Continues operation only if power interruption is within 0.5 second.
2	Continues operation unconditionally (with no error output).

Note If “1” or “2” is selected to continue operation, the Inverter automatically searches the motor speed (even when the motor is in a free-running state) and continues smooth operation. This function is called the speed search function.

Example of Speed Search Function

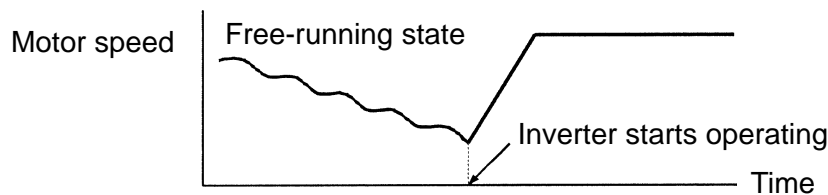

$n3$	Carrier Frequency		
Setting range	1, 2, 3, 4 (see note 1)	Factory setting	4 (10 kHz) (see note 2)

This constant is used to set a pulse-width-modulated (PWM) carrier frequency.

Value	Carrier frequency
1	2.5 (kHz)
2	5 (kHz)
3	7.5 (kHz)
4	10 (kHz)
5	12.5 (kHz)

Note 1. The setting range for the 400-VAC class is “1 to 5.”

Note 2. The factory setting for the 3G3EV-A4015-CUE is “3.”

Note 3. As the cable between the Inverter and the motor becomes longer, a high-frequency leakage current from the cable increases, causing the Inverter output current to increase as well. This may also affect peripheral devices. To prevent this, adjust the carrier frequency according to the following standards:

Cable length of 50 meters or less: 10 kHz or less

Cable length of 50 to 100 meters: 5 kHz or less

Note 4. With the 400-VAC class, the continuous output current cannot be used to 100% of the rated value if the constant is set to “5” for Inverters of 0.75 kW or less or if it is set to “4” or “5” for an Inverter of 1.5 kW.

Set the constant so that the continuous output current does not exceed the values shown in the following tables.

400-VAC Inverters of 0.75 kW or Less

Carrier frequency set value	Max. continuous output current
1 to 4	Up to 100% of the rated output
5	Up to 90% of the rated output

400-VAC Inverter of 1.5 kW

Carrier frequency set value	Max. continuous output current
1 to 3	Up to 100% of the rated output
4	Up to 85% of the rated output
5	Up to 75% of the rated output

n3	Automatic Torque Boost Gain		
Setting range	0.0 to 3.0	Factory setting	1.0
Unit of setting	0.1		

- There is no need to set this constant during the usual operation of the Inverter.
- Set this constant to a large value if the wiring distance between the motor and Inverter is large. Set this constant to a small value if the motor vibrates.

n3	Frequency Reference Gain		
Setting range	0.10 to 2.55 (times)	Factory setting	1.00 (times)
Unit of setting	0.01 (times)		

n4	Frequency Reference Bias		
Setting range	-99 to 99 (%)	Factory setting	0 (%)
Unit of setting	1 (%)		

- These constants are used to set the relationship between analog voltage and reference frequencies when frequency references are input through control terminals FR and FC.
- Frequency Reference Gain (n39): Specify the input voltage corresponding to the maximum frequency (n24) as a multiple of 10 V.
- Frequency Reference Bias (n40): Specify the reference frequency corresponding to input voltage 0 V as a percentage of the maximum frequency (n24).

Example of Frequency Reference Gain and Bias

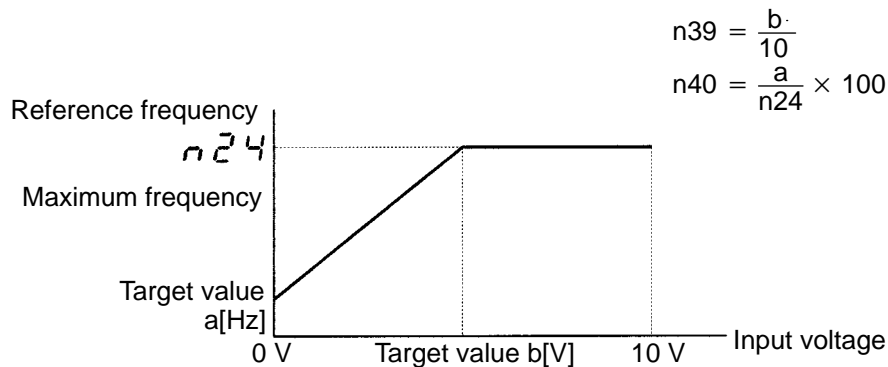

n 1	Frequency Reference Upper Limit		
Setting range	0 to 110 (%)	Factory setting	100 (%)
Unit of setting	1 (%)		

n 2	Frequency Reference Lower Limit		
Setting range	0 to 110 (%)	Factory setting	0 (%)
Unit of setting	1 (%)		

- Set constants in percentage in n41 and n42 based on the constant set in n24 for the maximum frequency as 100 percent.
- If 0 is set in n41 or n42, the Inverter will continue operating with the constant set in n42. If the constant set in n42 is smaller than the constant set in n29 for the minimum output frequency, the Inverter will not operate.

Example of Frequency Reference Upper and Lower Limits

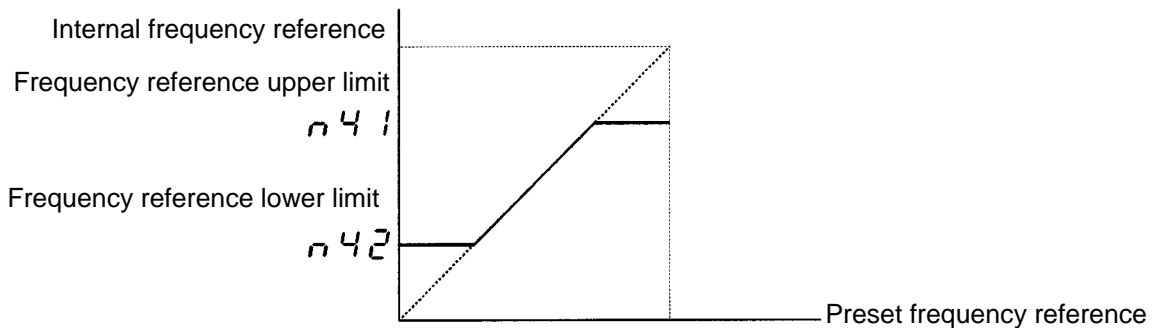

n 3	Frequency Reference Input Terminal		
Setting range	0, 1	Factory setting	0

This constant can be used to enable the FR terminal to have the fault reset function if the multi-function input terminals are all occupied with commands, such as multi-step speed commands 1 and 2.

Value	Description
0	Enables the FR terminal to work as a frequency reference terminal.
1	Enables the FR terminal to work as the fault reset input terminal.

n43 = 0

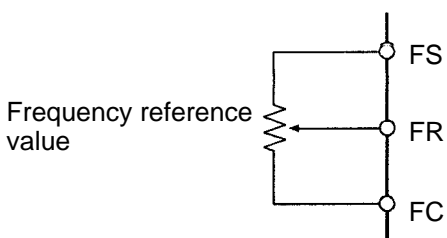

n43 = 1

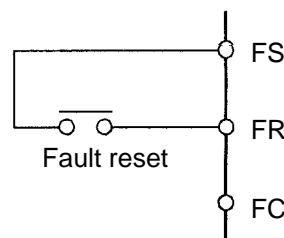

n	Multi-function Analog Output		
Setting range	0, 1	Factory setting	0

This constant is used to select the contents of the analog outputs (AM and AC) for monitoring.

Value	Description
0	Output frequency
1	Output current

Note The output level can be set with the constant set in n45 for the multi-function analog output gain.

n	Multi-function Analog Output Gain		
Setting range	0.00 to 2.00	Factory setting	0.30
Unit of setting	0.01		

This constant is used to set the ratio between the analog output voltage and output frequency (or output current).

Relationship Between Analog Output Voltage and Output Frequency (Output Current)

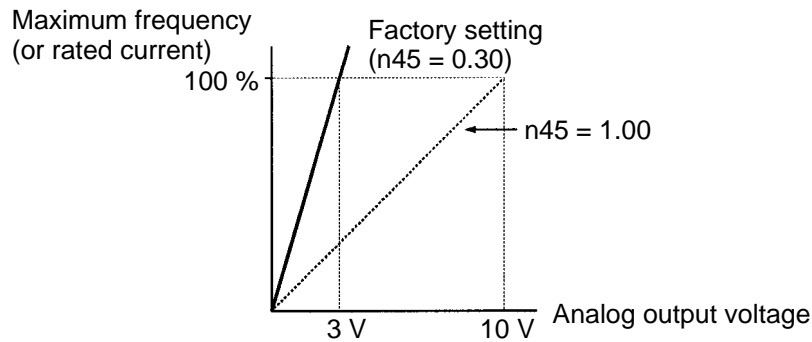

n 5	DC Control Current		
Setting range	0 to 100 (%)	Factory setting	50 (%)
Unit of setting	1 (%)		

n	Interruption DC Control Time		
Setting range	0.0 to 5.0 (seconds)	Factory setting	0.5 (seconds)
Unit of setting	0.1 (seconds)		

- These constants are effective when the interruption mode is set to frequency deceleration stop (i.e., 0 is set in n03).
- The constant in n46 must be set in percent for the DC control current based on the rated inverter current as 100 percent.

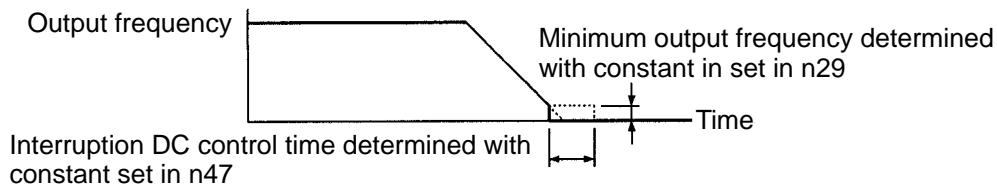

n	Startup DC Control Time		
Setting range	0.0 to 5.0 (seconds)	Factory setting	0.0 (seconds)
Unit of setting	0.1 (seconds)		

- This constant is used to stop the motor rotating with its inertia and enable the motor to start rotating again.
- The constant in n46 must be set for the DC control current for the motor to start rotating.
- If 0 is set in n48, no DC control is available.

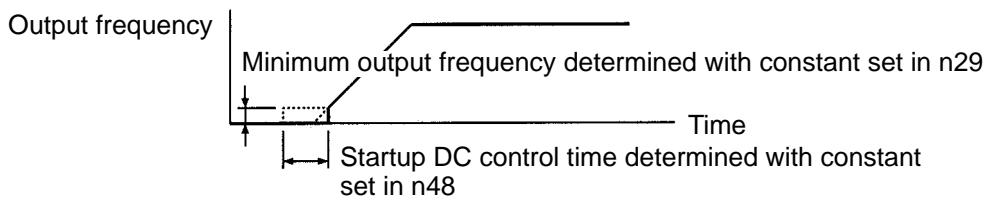

n	S-shape Acceleration and Deceleration Characteristic		
Setting range	0 to 3	Factory setting	0 (No S-shape acceleration or deceleration)

This constant is used for the s-shape acceleration and deceleration of the Inverter to decrease the shock of the machine connected to the Inverter when the machine starts or stops operating.

Value	Description
0	No s-shape acceleration or deceleration
1	S-shape characteristic time set to 0.2 second
2	S-shape characteristic time set to 0.5 second
3	S-shape characteristic time set to 1.0 second

Note If this constant is set to 1, 2, or 3, the acceleration or deceleration time will increase by 0.2, 0.5, or 1.0 second respectively.

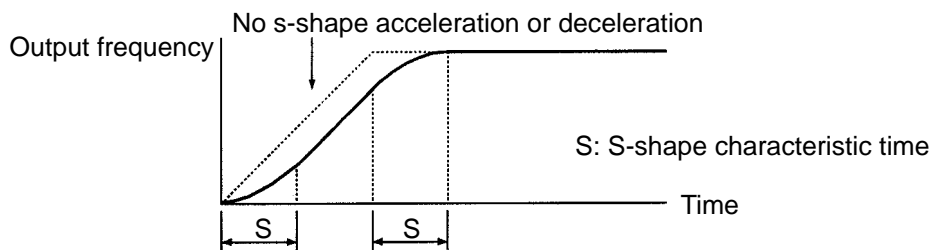

n 0	Over-torque Detection Function Selection		
Setting range	0 to 4	Factory setting	0

n 1	Over-torque Detection Level		
Setting range	30 to 200 (%)	Factory setting	160 (%)
Unit of setting	1 (%)		

n 2 Over-torque Detection Time			
Setting range	0.1 to 10 (seconds)	Factory setting	0.1 (seconds)
Unit of setting	0.1 (seconds)		

- When excessive load is applied to the equipment, the Inverter detects any increase in output current and displays the fault according to the n09 and n10 settings (multi-function output selection).
- n50 is used to specify whether over-torque is to be monitored and specify the action to be taken when over-torque is detected.

n50 setting	Description
0	Inverter does not monitor over-torque.
1	Inverter monitors over-torque only when speed is matched. It continues operation (issues warning) even after over-torque is detected.
2	Inverter monitors over-torque only when speed is matched. It discontinues operation (through protection function) when over-torque is detected.
3	Inverter always monitors over-torque during operation. It continues operation (issues warning) even after over-torque is detected.
4	Inverter always monitors over-torque during operation. It discontinues operation (through protection function) when over-torque is detected.

- n51 is used to set the over-torque detection level. Specify this value in terms of the percentage of the rated output current.
- n52 is used to set the over-torque detection time (in seconds).

n 3 Frequency Detection Level			
Setting range	0.4 to 400 (Hz)	Factory setting	0.0 (Hz)
Unit of setting	0.0 to 99.9 (Hz) : 0.1(Hz) 100 to 400 (Hz) : 1 (Hz)		

- When the output frequency drops below or exceeds the value set in n53, the Inverter displays the fault according to the n09 and n10 settings (multi-function output selection).
- To use the frequency detection function, always set “4” (output frequency ò frequency detection level set in n53) or “5” (output frequency ó frequency detection level set in n53) in n09 or n10 (multi-function output selection).

n Slip Compensation Gain			
Setting range	0.0 to 9.9 (%)	Factory setting	0.0 (%)
Unit of setting	0.1 (%)		

n	Motor Current with No Load		
Setting range	0 to 99 (%)	Factory setting	40 (%)
Unit of setting	1 (%)		

- The slip compensation function keeps the rotating speed of the motor constant if the load is heavy. Without this function, the motor will slip and the rotating speed of the motor will decrease if the load is heavy.
- If the output current of the Inverter is equal to the electronic thermal reference current (i.e., the rated current of the motor), add the compensation frequency equivalent to the rated slippage value of the motor to the output frequency.

- Refer to the following formulas to obtain the constants to be set in n54 and n55.
 $n54 = (\text{Synchronization speed} - \text{rated motor revolution}) / \text{synchronization speed} \times 100$
 $\text{Synchronization speed} = 120 / P \times f$
 P: No. of polls
 f: Rated frequency
 $n55 = (\text{Output current with no load} / \text{rated current of the motor}) \times 100$

- The compensation frequency (fc) can be obtained from the following.
 If the output frequency is lower than the constant set in n26 for the maximum voltage frequency, use the following formula to obtain the compensation frequency (fc).

$$fc = n26 \times n54 \times [\text{output current} - (n31 \times n55 / 100)] / [n31 - (n31 \times n55 / 100)]$$
 If the output frequency is equal to or higher than the constant set in n26 for the maximum voltage frequency, use the following formula to obtain the compensation frequency (fc).

$$fc = \text{output frequency} \times n54 \times [\text{output current} - (n31 \times n55 / 100)] / [n31 - (n31 \times n55 / 100)]$$
 n26: Maximum voltage frequency (Hz)
 n31: Electronic thermal reference current (A)

- Note 1.** The slip compensation function does not work if the output frequency is lower than the constant set in n29 for the minimum output frequency.
- Note 2.** The slip compensation function does not work if the Inverter is in regenerative operation.
- Note 3.** The slip compensation function does not work if 0.0 is set for the electronic thermal reference current.

n 5 to n	Jump Frequencies 1 to 3		
Setting range	0.0 to 400 (Hz)	Factory setting	0.0 (Hz)
Unit of setting	0.0 to 99.9 (Hz) : 0.1 (Hz) 100 to 400 (Hz) : 1 (Hz)		

n	Jump Width		
Setting range	0.0 to 25.5 (Hz)	Factory setting	1.0 (Hz)
Unit of setting	0.1 (Hz)		

- These constants are used to change the output frequency to prevent the resonance of the mechanical system connected to the Inverter.
- These constants are used effectively to create the dead band of a frequency reference.
- Set the constants in n56 to n58 for the central values of jumping frequencies. These constants must satisfy the following condition, otherwise an error will result:
 $n56 \geq n57 \geq n58$
- The constant in n59 must be set for the jump width value so that the middle values of the jump widths will be the central values of the required jumping frequencies.

Example of Frequency Jump Function

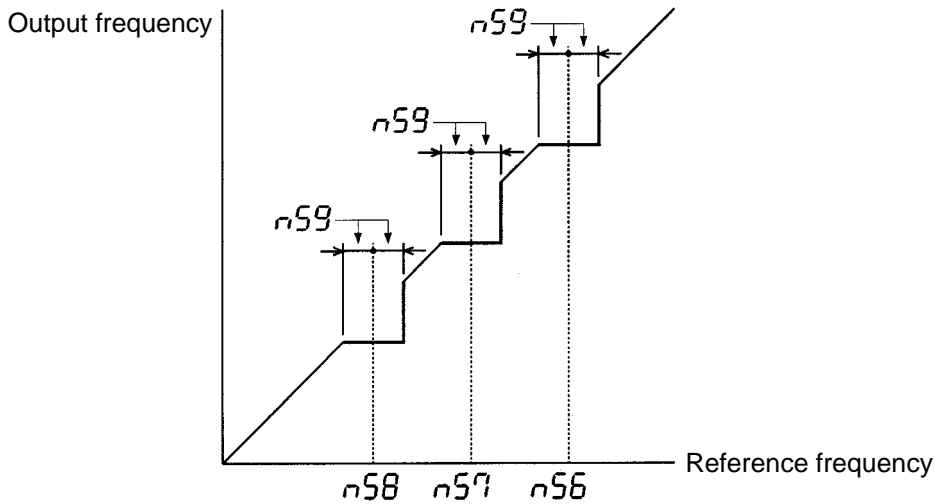

n50	Number of Fault Retries		
Setting range	0 to 10 (times)	Factory setting	0 (times)

Caution The Inverter may be damaged if the fault retry function is used.
Protect the Inverter as described below before using the fault retry function:

Be sure to connect an NFB (no-fuse breaker) to the Inverter.

Provide sequence circuitry to the Inverter and the machines of the system connected to the Inverter so that the machines will stop operating when the Inverter has an operational error.

- The fault retry function enables the Inverter to start operating automatically after the Inverter stops operating due to external errors. This function can be used only if the user does not want to interrupt the mechanical system, even if it means that this function may damage the Inverter.
- Set the number of retries.
- The fault retry function detects overcurrent and overvoltage errors only. If the Inverter has any other error, the fault retry function will not work. Instead, the protective mechanism will work instantly.
- The number of fault retries are cleared in the following cases.
 1. If the Inverter operates normally for 10 minutes after the fault retry function is triggered.
 2. If the Inverter is reset after the Inverter has any error, the protective mechanism is actuated, and the cause of the error is removed.
 3. If the Inverter is turned off and on.

<i>n51</i>	Stop Key Selection		
Setting range	0, 1	Factory setting	0

- When inputting Inverter operation from the control terminals, the Stop Key on the Digital Operator can be set to “enabled” or “disabled.”

Value	Description
0	Stop Key enabled
1	Stop key disabled

Note When operating the Inverter from the Digital Operator, the Stop Key is always enabled irrespective of its setting.

<i>n62</i>	Slip Compensation Primary Delay Time		
Setting range	0.0 to 25.5	Factory setting	2.0

- This constant is used to adjust the operation of slip compensation function.
- When the slip compensation function is used, the Inverter may oscillate with the load. In such a case, use constant n62.
- If vibration occurs, increase the setting of n62.
- When the constant is set to “0.0,” the Inverter will perform the same operation as when the constant is set to the factory setting of “2.0.”

n63	UP/DOWN Command Frequency Memory		
Setting range	0, 1	Factory setting	0

- This constant is enabled when the Multi-function Input Selection 3 (n08) is set to UP/DOWN command function (15).
- This constant can save the frequency command adjusted by the UP/DOWN command in its memory. (The Inverter starts rotation at the previously-set frequency when an operation input is given after restarting the power supply.)

Value	Description
0	Memorizes the frequency
1	Does not memorize the frequency

- For clearing the memorized frequency, either set the constant to “0” or initialize again. When re-adjusting, directly input the UP/DOWN command.

Note This constant is available for models with a PROM number (n69) of “220” or higher.

n6	Operator’s Frequency Setting Method		
Setting range	0, 1	Factory setting	0

- Used for setting the frequency from the Digital Operator.
- Select the Enter Key operation when setting the frequency command from the Digital Operator.

Value	Description
0	Enter Key required for changing frequency
1	Enter Key not required for changing frequency (may be changed using Increment and Decrement Keys.)

Note This constant is available for models with a PROM number (n69) of “220” or higher.

n5	Error History
This constant can only be displayed. It cannot be set.	

- Information about the last error is recorded in this constant.
- Recorded are Inverter errors and other errors that actuate a protective mechanism. Warning (automatically recovered error) is not recorded.
- If no error has occurred, the indicator is not lit.
- All error codes are listed below.

Error code	Description	Error category
o	Overcurrent (OC)	Errors that actuate protective mechanism
ou	Main circuit overvoltage (OV)	
u1	Main circuit undervoltage (UV1)	
u2	Control power supply fault (UV2)	
o	Radiation fin overheated (OH)	
o 1	Motor overload (OL1)	
o 2	Inverter overload (OL2)	
o 3	Over-torque (OL3)	
EF1	External fault (EF1)	Inverter errors
FD0	Initial memory error	
FD1	ROM error	
FD	Constant error	
FD	A/D converter error	---
FD6	Option error	

n5	PROM Number (for Manufacturer's Reference)
This constant can only be displayed. It cannot be set.	

The software version can be confirmed.

Constants may not be usable depending on the PROM number. Refer to the PROM number for the models used and make the appropriate settings.

Constant no.	PROM no. (contents of n69)	
	219 or lower	220 or higher
n27	Setting range: 0.5 to 399	Setting range: 0.1 to 399
n29	Setting range: 0.5 to 10.0	Setting range: 0.1 to 10.0
n39	Setting range: 0.10 to 2.00	Setting range: 0.10 to 2.55
n63	No	Yes
n64	No	Yes

Note "Yes" indicates that the constant can be set.
 "No" indicates that the constant cannot be set.

4-3 Test Run

After wiring is complete, perform a test run of the Inverter as follows. First, start the motor through the Digital Operator without connecting the motor to the mechanical system. Next, connect the motor to the mechanical system and perform a test run. Finally, operate the controller to make sure that the sequence of operations is correct.

This section only describes how to perform a test run using the Digital Operator.

1	Checking Wiring
----------	------------------------

- Check that terminals R, S, and T receive power supply.
 - 200-VAC Class
 - Three-phase input: 200 to 230 VAC, 50/60 Hz
 - Single-phase input: 200 to 240 VAC, 50/60 Hz (terminals R and S)
(Single-phase input is only applicable to 3G3EV-AB M.)
 - 400-VAC Class
 - Three-phase input: 380 to 460 VAC, 50/60 Hz
- Check that terminals U, V, and W are correctly connected to the motor power cables.
- Do not connect the mechanical system to the motor. (The motor must be in no-load status.)
- If signal lines are connected to control terminals, turn terminals SF and SR off.

2	Turning Power On and Checking Indicator Display
----------	--

- Check that the ALARM indicator is not lit.
- Check that the RUN indicator is flashing.

3	Initializing Constants	FREF n01
----------	-------------------------------	-----------------

- Set “8” or “9” (3-wire sequence mode) in constant no. 01 to initialize constants.

4	Setting a V/f Pattern	FMAX VMAX FBAS
----------	------------------------------	-------------------------------------

- Set the maximum frequency (“FMAX” or constant no. 24), maximum voltage (“VMAX” or constant no. 25), and maximum voltage frequency (“FBAS” or constant no. 26) according to the operating conditions.

5	Setting Rated Motor Amperage	THR
----------	-------------------------------------	------------

- Set the rated motor amperage in constant no. 31 (electronic thermal reference current) or with the “THR” indicator lit.

6	Setting the Reference Frequency	FREF
----------	--	-------------

- Set the frequency corresponding to the motor speed in constant no. 11 (frequency reference 1) or with the “FREF” indicator lit.

7	Operating the Inverter with the Digital Operator
----------	---

- Press the RUN Key to rotate the motor in the forward direction. (If the PRGM indicator is lit in the constant item indicators section, press the Mode Key once to light the FREF indicator. If a red indicator in the stopped item indicators section is lit, the run command cannot be accepted.)
- Check that the motor rotates smoothly without making noise.
- Check that the direction of rotation is correct.

8	Checking Output Frequency and Amperage	FOUT IOUT
----------	---	-------------------------

- Light the FOUT indicator (output frequency monitor) and make sure that the displayed value matches the reference frequency.
- Light the IOUT indicator (output current monitor) and check for overcurrent.

9	Checking Operation during Reverse Rotation	F/R
----------	---	------------

- Rotate the motor in the reverse direction and check the same items as above.

10	Checking Operation with Mechanical System Connected
-----------	--

- Press the STOP/RESET Key to stop the motor.
- Connect the mechanical system to the motor and check the same items as above.

11	Checking Operation Performed by Controller	MODE
-----------	---	-------------

- Light the MODE indicator and set the actual operation mode.
- Operate the Inverter with the controller, check for noise resulting from mechanical resonance, and check that the sequence of operations is correct.

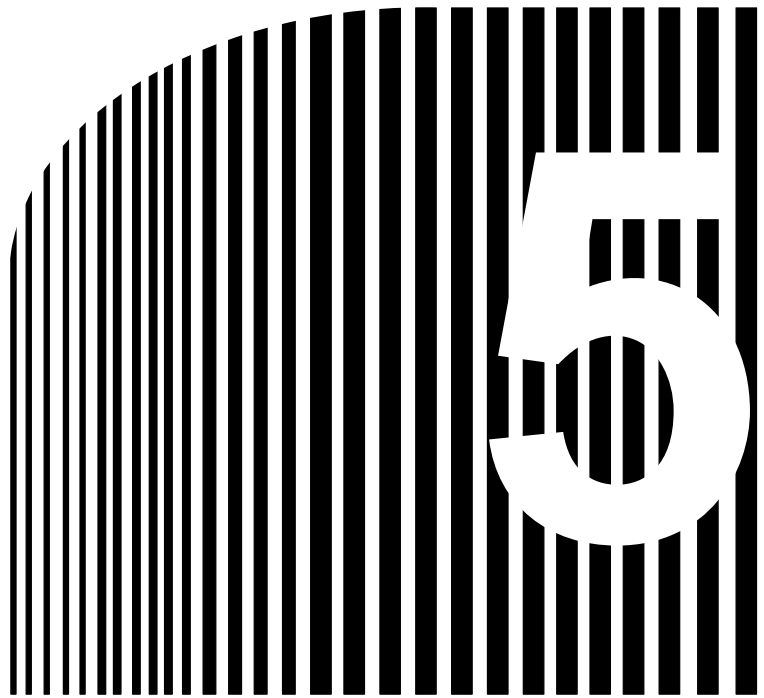

Chapter 5

• Operation •

5-1 Protective and Diagnostic Functions

5-2 Troubleshooting

5-3 Maintenance and Inspection

5-1 Protective and Diagnostic Functions

The RUN and ALARM indicators on the front panel of the Inverter indicate the current status of the Inverter and the data display section displays information about an error that has occurred.

■ List of Error Codes

Inverter status	Indicator		Data display	Description
	RUN	ALARM		
Normal	Flashes	Not lit	---	Ready to run
	Lit	Not lit	---	Normal operation in progress
Warning	Flashes	Flashes	<i>EF</i>	Simultaneous input of forward and reverse rotation commands
			Lit	Flashes
	<i>ou</i>	Main circuit overvoltage (OV)		
	<i>o</i>	Radiation fin overheated (OH)		
	<i>SrP</i>	Digital Operator stopped (STP)		
	<i>o 3</i>	Over-torque (OL3)		
		External base block in progress (bb)		
		<i>Er</i>	Sequence error (SEr)	
Protective mechanism actuated	Not lit	Lit	<i>o</i>	Overcurrent (OC)
			<i>ou</i>	Main circuit overvoltage (OV)
			<i>u 1</i>	Main circuit undervoltage (UV1)
			<i>u 2</i>	Control power supply fault (UV2)
			<i>o</i>	Radiation fin overheated (OH)
			<i>o 1</i>	Motor overload (OL1)
			<i>o 2</i>	Inverter overload (OL2)
			<i>o 3</i>	Over-torque (OL3)
			<i>EF 1</i>	External fault (EF1)
Inverter error	Not lit	Lit	<i>F00</i>	Initial memory error
			<i>F01</i>	ROM error
			<i>F0</i>	Constant error
			<i>F0</i>	A/D converter error
			<i>F05</i>	Option error
	Not lit	Not lit	(Not lit)	Control circuit error

Note EF2 or EF3 will be displayed if an external error is input from multi-function input 2 or 3.

■ Data Display and Action to be Taken when Warning Status Arises

The ALARM indicator flashes when warning status arises. The data display section also flashes.

When warning status arises, no error code is output.

Eliminating the cause recovers the system automatically.

Data display	Description	Action
<i>EF</i> flashing	Simultaneous input of forward and reverse rotation commands Forward and reverse rotation commands were simultaneously input for 0.5 second or more.	<ul style="list-style-type: none"> • Review the sequence.
<i>U</i> flashing	Main circuit undervoltage (UV) The DC voltage of the main circuit dropped below the low-voltage detection level when the Inverter was stopped.	<ul style="list-style-type: none"> • Check the power voltage. • Check the power input line for disconnection. • Check the terminal block screws for looseness.
<i>OU</i> flashing	Main circuit overvoltage (OV) The DC voltage of the main circuit exceeded the overvoltage detection level when the Inverter was stopped.	<ul style="list-style-type: none"> • Check the power voltage.
<i>O</i> flashing	Radiation fin overheated (OH) The radiation fin overheated when the Inverter was stopped.	<ul style="list-style-type: none"> • Check the ambient temperature. • Install a cooling fan or air conditioner.
<i>STP</i> flashing (see note)	Digital Operator stopped (STP) The STOP/RESET Key on the Digital Operator was pressed while the Inverter was being operated using control circuit terminals SF and SR.	<ul style="list-style-type: none"> • Open both SF and SR.
<i>OL3</i> flashing	Over-torque (OL3) The flow of current exceeded the value determined with the constant set in n51 for more than the specified period determined with the constant set in n52.	<ul style="list-style-type: none"> • Make sure that the n51 and n52 settings are appropriate. • Check the operating status of the mechanical system and remove the cause of the error.
flashing	External base block in progress (bb) An external base block signal was input.	<ul style="list-style-type: none"> • Make sure that the sequence circuit is appropriate.

Data display	Description	Action
E_r flashing	Sequence error (SEr) A local or remote selection signal was input to the Inverter in operation.	• Make sure that the sequence circuit is appropriate.

Note The interruption method of the Inverter with the EF or STP error conforms to the constant set in n03.

■ Data Display and Action to be Taken when Protective Mechanism is Actuated

The ALARM indicator lights up when the protective mechanism is actuated. In this event, Inverter output is shut off, and the motor coasts to a stop.

Check the cause of the error, take the necessary action, and perform fault reset or turn the power off, then on. The reset will not work while a RUN command (forward or reverse) is in effect. Wait until the RUN command is OFF before resetting the Inverter.

Data display	Description	Cause and action
<p>□</p>	<p>Overcurrent (OC) The Inverter output current instantaneously exceeded 250% of the rated amperage.</p>	<ul style="list-style-type: none"> • The output side of the Inverter is shorted or grounded. • Load inertia is excessive. • The acceleration and deceleration time settings are too short. • A special motor is used. • The motor was started during free running. • The magnetic contactor on the output side of the Inverter was opened and closed. <p style="text-align: center;">↓</p> <ul style="list-style-type: none"> • Determine the cause of the error, take the necessary action, and reset the system.
<p>□U</p>	<p>Main circuit overvoltage (OV) Because regenerative energy from the motor was excessive, the DC voltage of the main circuit exceeded approximately 410 V. (400-VAC Class, 820 V)</p>	<ul style="list-style-type: none"> • The deceleration time setting is too short. <p style="text-align: center;">↓</p> <ul style="list-style-type: none"> • Increase the deceleration time. • Connect a braking resistor (or braking resistor unit). <ul style="list-style-type: none"> • The regenerative energy becomes excessive when returning from the overshoot during acceleration. <p style="text-align: center;">↓</p> <ul style="list-style-type: none"> • Connect a braking resistor (or braking resistor unit).

Data display	Description	Cause and action
u1	<p>Main circuit undervoltage (UV1) The DC voltage of the main circuit dropped below the specified level. 3G3EV-A2 M: Approximately 200 V or less 3G3EV-AB M: Approximately 160 V or less 3G3EV-A4 M-CUE: Approximately 400 V or less</p>	<ul style="list-style-type: none"> • The input power voltage dropped. • Open-phase occurred. • An instantaneous power interruption occurred. <p style="text-align: center;">↓</p> <ul style="list-style-type: none"> • Check the power voltage. • Check the power input line for disconnection. • Check the terminal block screws for looseness.
u2	<p>Control power supply fault (UV2) A voltage fault occurred in control power supply.</p>	<ul style="list-style-type: none"> • Turn the power off, then on. • If this problem persists, replace the Unit.
o	<p>Radiation fin overheated (OH) The radiation fin overheated because of ambient temperature rise or Inverter temperature rise due to overload.</p>	<ul style="list-style-type: none"> • Load is excessive. ⇒ Reduce the load. • The V/f characteristics are inappropriate. ⇒ Reset constant Nos. 24 to 26. • The acceleration/deceleration time or cycle time is too short. ⇒ Increase the acceleration/deceleration time or cycle time. • The ambient temperature is too high. ⇒ Install a cooling fan or air conditioner.

Data display	Description	Cause and action
<p>o 1</p>	<p>Motor overload (OL1) The electronic thermal relay actuated the motor overload protection function.</p>	<ul style="list-style-type: none"> • Review the load size, V/f characteristics, acceleration/deceleration time, and cycle time. • Set the rated motor amperage in constant No. 31 (electronic thermal reference current). • When increasing the output voltage in the low speed range to increase the startup torque, the increased voltage was excessive (V/f characteristics setting error). • Decrease the setting of constant No. 30 (minimum output frequency voltage). • The maximum voltage frequency (FBAS) was set too low (V/f characteristics setting error) and caused overcurrent. • Set the maximum voltage frequency to the rated motor frequency. • Operated more than one motor with one Inverter. • Set constant No. 31 (electronic thermal reference current) to “0.0 (A).”
<p>o 2</p>	<p>Inverter overload (OL2) The electronic thermal relay actuated the Inverter overload protection function.</p>	<ul style="list-style-type: none"> • Review the load size, V/f characteristics, acceleration/deceleration time, and cycle time. • Review the Inverter capacity.
<p>o 3</p>	<p>Over-torque (OL3) A current exceeding the value set in n51 flowed for more than the time set in n52.</p>	<ul style="list-style-type: none"> • Check if the n51 and n52 settings are appropriate. • Check the machine use status, and eliminate the cause of the problem.
<p>EF 1</p>	<p>External fault (EF1) The Inverter received abnormal input from external circuits.</p>	<ul style="list-style-type: none"> • Review the external circuits. • Review the external sequence. • Check the signal line of multi-function contact input for disconnection.

■ **Data Display and Action to be Taken when Inverter Error Occurs**

The first character of an error code is always “F” when an Inverter error occurs. (However, all indicators are not lit when a control circuit error occurs.)

If an Inverter error occurs, turn the power off, then on. If the problem persists, replace the Unit.

Data display	Description	Action
<i>F00</i>	Initial memory error	<ul style="list-style-type: none"> • Turn the power off, then on.
<i>F01</i>	ROM error	<ul style="list-style-type: none"> • If the problem persists, replace the Unit.
<i>F0</i>	Constant error	<ul style="list-style-type: none"> • Write down all the constant settings, initialize the constants, and reset the constants. • Turn the power off, then on. • If the problem persists, replace the Unit.
<i>F0</i>	A/D converter error	<ul style="list-style-type: none"> • Turn the power off, then on. • If the problem persists, replace the Unit.
<i>F06</i>	Option error The Digital Operator has an error or faulty contact.	<ul style="list-style-type: none"> • Turn the power off, then reinstall the Digital Operator. • If the problem persists, replace the Unit.
(Not lit)	Control circuit error An error occurred in the control power supply or hardware.	<ul style="list-style-type: none"> • Check the power cables. • Replace the Unit.

5-2 Troubleshooting

If the Inverter or motor does not operate properly when the system is started, constant settings or wiring may be incorrect. In this case, take the appropriate action as described below. (If an error code is displayed, refer to 5-1 *Protective and Diagnostic Functions*.)

5-2-1 Constants Fail to Set

■ *Err* is Displayed in the Data Display Section.

- If an attempt is made to set a value outside the allowable range, *Err* is displayed in the data display section. The value is canceled and the data display section redisplayes the original value. For example, this error occurs when:
 - An attempt is made to set a reference frequency value higher than the maximum frequency value.
 - The relationship among the constants set in n29 for the minimum output frequency, n27 for the intermediate output frequency, n26 for the maximum voltage frequency, and n24 for the maximum frequency are not correct.
 - The relationship among jump frequencies 1 to 3 determined with the constants set in n56 to n58 is not correct.

Check the setting range, then set the constant correctly.

■ The Display Does Not Change when the Increment or Decrement Key is Pressed.

- Value "0" is set in n01 (constant write-inhibit selection)
Set "1" in n01.
- The Digital Operator is not connected properly.
Turn the power off. After all indicators on the front panel go off, remove the Digital Operator, then reinstall it.

5-2-2 Motor Fails to Operate

■ The Motor Does Not Operate when the RUN Key on the Digital Operator is Pressed.

- Operation mode was not selected correctly.
If "1," "3," or "5" is set in n02, the motor does not operate when the RUN Key on the Digital Operator is pressed.
Always set "0," "2," or "4" in n02.

- The reference frequency is too low.

When the reference frequency is lower than the minimum output frequency determined with the constant set in n29, the Inverter cannot operate, in which case change the reference frequency so that the reference frequency will be equivalent to or higher than the minimum output frequency.

- The sequence input method is wrong.

If the 3-wire sequence input mode is selected as an external terminal function instead of the actual 2-wire sequence input mode, the motor will not run, in which case change the constant or change to the sequence input that matches the constant setting.

■ The Motor Does Not Operate when an External Run Signal is Input.

- Operation mode is selected incorrectly.

If “0,” “2,” or “4” is set in n02, the motor does not operate when a run signal is input. Always set “1,” “3,” or “5” in n02.

- The reference frequency is too low.

When the reference frequency is lower than the minimum output frequency determined with the constant set in n29, the Inverter cannot operate, in which case change the reference frequency so that the reference frequency will be equivalent to or higher than the minimum output frequency.

■ The Motor Stops during Acceleration or when a Load is Connected.

- Load is too high.

The 3G3EV has a stall prevention function and full automatic torque boost function. However, if the acceleration or load is too large, the motor response limit will be exceeded.

To prevent this, increase acceleration time or reduce load. Motor capacity should be also increased.

■ Motor Rotates in Single Direction

- If “1” is set in n05 for the reverse rotation-inhibit selection, no reverse rotation command will be accepted, in which case set 0 in n05.

5-2-3 Motor Rotates in the Wrong Direction

- The motor output line is connected incorrectly.

If terminals U, V, and W on the Inverter are correctly connected to terminals U, V, and W on the motor, the motor rotates in the forward direction when a forward rotation command is input. Since the forward direction of rotation depends on the motor manufacturer and model, check the motor specifications.

To reverse the direction of rotation, switch the wires of two phases of U, V, and W as shown below.

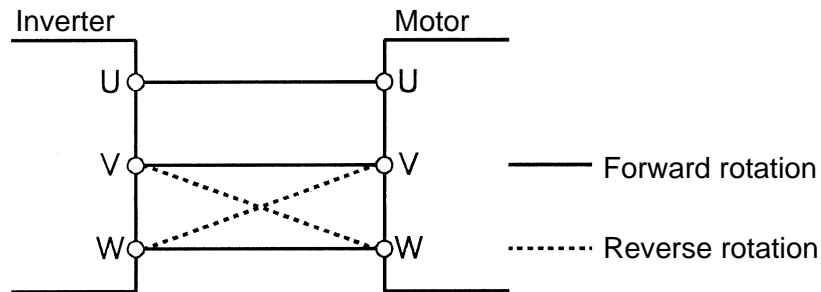

5-2-4 Motor Deceleration is Too Slow

■ Deceleration Time is Too Long Even if a Braking Resistor is Connected.

- Value 0 (stall prevention during deceleration) is set in n33.

When a braking resistor is connected, always set “1” (no stall prevention during deceleration) in n33. If “0” is set, the braking resistor will not be used.

- The deceleration time set in n21 is too long.

Check the deceleration time setting.

- Motor torque is insufficient.

If the constant settings are normal and overvoltage does not occur, motor capacity is insufficient.

Motor capacity should be increased.

5-2-5 Vertical-axis Load Drops when Brakes are Applied

- **The sequence is incorrect.**

The Inverter goes into DC braking status for 0.5 seconds after deceleration is completed. (This is the factory-set default.) To make sure that the brake holds, use the frequency detection function and apply the brake only when the detected frequency drops to 3 to 5 Hz or lower. Also at startup, use the frequency detection function, and release the brake only when the detected frequency is 3 to 5 Hz or higher.

- **The DC braking is insufficient.**

If the DC braking power is insufficient, adjust parameter n46 (DC injection braking current).

- **An inappropriate brake is being used.**

The holding brake is designed only for holding, not for braking. If the holding brake is used for braking, the brake pad will wear out much faster than designed. Use an appropriate brake for braking.

5-2-6 Motor Burns

- The dielectric strength of the motor is insufficient.

Surge arises when the motor (inductive load) is connected to the output side of the Inverter. Normally, the maximum surge voltage is approximately three times the power voltage. Therefore, the dielectric strength of the motor to be used must be higher than the maximum surge voltage.

It is recommended that motors specifically for Inverters be used, especially for the 400-VAC-class Inverters.

5-2-7 Controller Receives Noise when Inverter is Started

- Noise derives from Inverter switching.

Take the following actions to prevent noise:

- Reduce the carrier frequency of the Inverter.

The number of internal switching times is reduced, so noise can be reduced to some extent.

- Improve the frame ground.

A current generated by internal switching normally leaks into the frame ground. Therefore, connect the ground terminal with a sufficiently thick and short wire of 100 Ω or less.

- Install an input noise filter.

Install an input noise filter (3G3EV-PLNF) on the power input side of the Inverter.

- Install an output noise filter.

Install an output noise filter (3G3IV-PLF) on the output side of the Inverter.

- Provide a separate power supply for the sensor.

If the sensor malfunctions, provide a dedicated power supply for the sensor and install a noise filter on the power supply. For the signal line, use a shielded cable.

5-2-8 AM Radio Receives Noise when Inverter is Started

- Noise derives from Inverter switching.

Take the following actions to prevent noise:

- Reduce the carrier frequency of the Inverter.

The number of internal switching times is reduced, so noise can be reduced to some extent.

- Install an input noise filter.

Install an input noise filter (3G3EV-PLNF) on the power input side of the Inverter.

- Install an output noise filter.

Install an output noise filter (3G3IV-PLF) on the output side of the Inverter.

- Use metal box and piping.

Metal can block off radio waves. Therefore, enclose the Inverter with a metal (steel) box to prevent radio waves from being emitted from the Inverter.

5-2-9 Ground Fault Interrupter is Actuated when Inverter is Started

- Leakage current flows through the Inverter.

Because switching is performed inside the Inverter, a leakage current flows through the Inverter. This leakage current may actuate the ground fault interrupter, shutting the power off.

Use a ground fault interrupter with a high leakage-current detection value (sensitivity amperage of 200 mA or more, operating time of 0.1 second or more) or the one with high-frequency countermeasures (for Inverter).

Reducing the carrier frequency value is also relatively effective.

Note also that a leakage current increases in proportion to the cable length. Normally, an approximately 5 mA leakage current is generated per meter (cable length).

5-2-10 Mechanical System Makes Noise

- The carrier frequency and the natural frequency of the mechanical system resonates.

Take the following actions:

- Frequency Jump

Use the frequency jump function with the constants set in n56 to n59 to change the output frequency to prevent the resonance of the mechanical system.

- Adjust the carrier frequency.

Adjusting the carrier frequency (n37) may prevent resonance from occurring.

- Install vibration-proof rubber.

Install vibration-proof rubber on the motor base.

5-2-11 Motor Rotates after Output of Inverter is Turned Off

- Insufficient DC Control

After the Inverter is in deceleration stop operation, the motor can continue rotating at low revolution if the DC control of the Inverter is insufficient.

In such cases, adjust the DC control as described below.

- Increase the constant set in n46 for the DC control current to a larger value.

- Set the constant of the interruption DC control time in n47 to a larger value.

5-2-12 Overvoltage is Detected When Fan is Turned On or Revolution of Fan Decreases

- Insufficient DC Control

Overvoltage can be detected when the fan is turned on or the revolution of the fan decreases if the fan is turned on while the fan is rotating.

To prevent this, use the DC control function and decrease the revolution of the fan before turning the fan on or increase the constant set in n48 for the startup DC control time to a larger value.

5-2-13 Output Frequency Does Not Reach Reference Frequency

- The reference frequency is within the jump frequency.

If the jump function is used, the output frequency stays within the jump frequency.

Make sure that jump frequencies 1 to 3 determined with the constants set in n56 to n58 and the constant set in n59 for the jump width are appropriate.

- The preset output frequency exceeds the upper-limit frequency.

The upper-limit frequency can be obtained from the following formula.

[Maximum frequency determined with constant set in n24] x [frequency reference upper limit determined with constant set in n41]/[100 (Hz)]

Make sure that the constants set in n24 and n41 are correct.

5-2-14 Motor Does Not Operate with EF Warning

- EF Warning (simultaneous input of forward and reverse commands) is a warning alarm that is issued when forward and reverse commands are simultaneously input for longer than 500 ms. Check the Inverter's sequence input.
- The Inverter input may be set to the ON state due to the current leaked in from the control output.

Under the wiring condition shown below, if the control output power supply is lower than 24 VDC or if it is set to OFF, current may flow in the direction shown by the arrows and may operate the Inverter input. In such a case, insert a diode in the A section shown below.

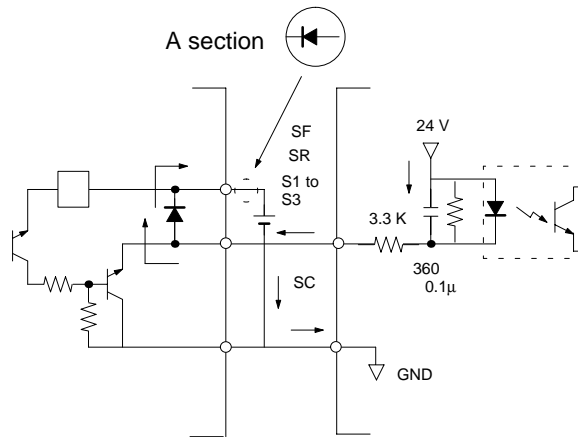

5-3 Maintenance and Inspection

■ Daily Inspection

While the system is operating, check the following items:

- Check the motor for noise.
- Check for abnormal heating.
- Check if the ambient temperature is too high.
- Check if the output current monitor display indicates a higher value than usual.

■ Regular Maintenance

Check the items below during regular maintenance.

Before starting inspection, always turn the power off, then wait at least one minute after all indicators on the front panel go off. Touching terminals immediately after turning the power off may cause an electrical shock.

- Check the terminal block screws for looseness.
- Check if electrically conductive dust or oil mist adheres to the terminal block.
- Check the Inverter set screws for looseness.
- Check if dust or dirt builds up on the heat sink (aluminum portion on the rear of the Unit).
- Check if dust builds up in the air vents.
- Check if the appearance is normal.
- Check if the cooling fan for the control panel operates normally. (Check for noise or abnormal vibration, and also check if the total hours of operation has exceeded the value shown in the specifications.)

■ Regular Parts Maintenance

An Inverter consists of many different parts. It can provide its full performance only when these parts operate normally. Some electronic parts require maintenance depending on the service conditions. To allow the Inverter to operate normally over an extended period of time, always perform regular inspection and parts replacement according to the service life of each part.

Regular inspection intervals vary according to the Inverter installation environment and service conditions.

The maintenance interval for this Inverter is shown below. Use this information as a guide to regular maintenance.

The standard interval for regular maintenance is as follows:

Electrolytic capacitor: Approximately 5 years (8 hours of operation per day)

As for service conditions, it is assumed that the ambient temperature of the Inverter is 40°C, and the Inverter is used under rated operating conditions (rated torque) and is installed as specified in the User's Manual.

To extend maintenance intervals, ambient temperatures should be lowered, and power-on time should be minimized.

Note For the maintenance method, contact your nearest local sales representative.

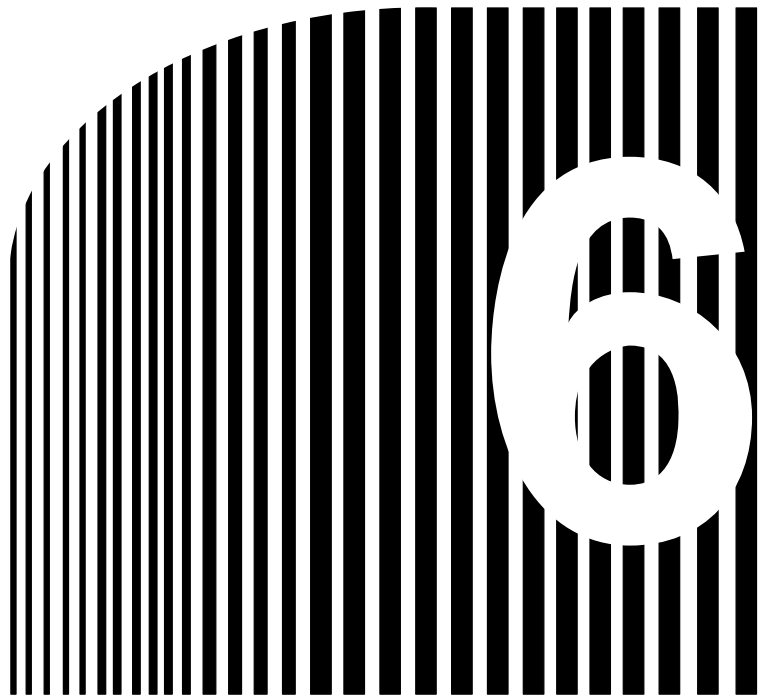

Chapter 6

• Specifications •

6-1 Specifications of Main Unit

6-1 Specifications of Main Unit

■ Rating

Three phase, 200 VAC	Model 3G3EV-		A2001M(-■)	A2002M(-■)	A2004M(-■)	A2007M(-■)	A2015M(-■)
	Power supply	Rated voltage and frequency	Three-phase, 200 to 230 VAC, 50/60 Hz				
		Allowable voltage fluctuation	-15% to 10 %				
		Allowable frequency fluctuation	±5%				
	Heating value (W)		11.9	18.8	33.2	51.7	71.6
	Weight (kg)		0.5	0.6	0.9	1.3	1.5
Single phase/ Three phase, 200 VAC	Model 3G3EV-		AB001M(-■)	AB002M(-■)	AB004M(-■)	AB007M(-■)	AB015M(-■)
	Power supply	Rated voltage and frequency	Single-phase, 200 to 240 VAC, 50/60 Hz Three-phase, 200 to 230 VAC, 50/60 Hz				
		Allowable voltage fluctuation	-15% to 10 %				
		Allowable frequency fluctuation	±5%				
	Heating value (W)		12.6	20.3	25.3	55.3	78.4
	Weight (kg)		0.5	0.6	1.3	1.3	2.0
Maximum applicable motor capacity (kW)		0.1	0.2	0.4	0.75	1.5	
Output specifications	Rated output capacity (kVA)		0.3	0.6	1.1	1.9	2.7
	Rated output current (A)		0.8	1.5	3.0	5.0	7.0
	Rated output voltage		Three-phase, 200 to 230 VAC (Corresponds to the input voltage)				
	Maximum output frequency		400 Hz (Parameter setting)				
Cooling method		Self-cooling					

Three phase, 400 VAC	Model 3G3EV-		---	A4002(-■)	A4004(-■)	A4007(-■)	A4015(-■)
	Power supply	Rated voltage and frequency	Three-phase, 380 to 460 VAC, 50/60 Hz				
		Allowable voltage fluctuation	-15% to 10 %				
		Allowable frequency fluctuation	±5%				
	Heating value (W)		---	25.5	34.7	56.0	78.5
Weight (kg)		---	1.0	1.0	1.5	2.0	
Maximum applicable motor capacity (kW)		---	0.2 (0.37)	0.4 (0.55)	0.75 (1.1)	1.5 (1.5)	
Output specifications	Rated output capacity (kVA)	---	0.9	1.4	2.6	3.7	
	Rated output current (A)	---	1.2	1.8	3.4	4.8	
	Rated output voltage	Three-phase, 380 to 460 VAC (Corresponds to the input voltage)					
	Maximum output frequency	400 Hz (Parameter setting)					
Cooling method		Self-cooling					

■ General Specifications

Installation type	Panel mounting
Installation site	Indoor (free from corrosive gases and dust)
Ambient temperature for operation	-10° to 50°C
Humidity	90% or less (no-condensing)
Ambient temperature for storage	-20° to 60°C
Altitude	1,000 m max.
Vibration resistance	Less than 20 Hz: 9.8 m/s ² or less 20 to 50 Hz: 1.96 m/s ² or less
Cable length between Inverter and motor	100 m max.

■ Control Characteristics

Control method	Sine-wave PWM method (automatic torque boost)
Frequency control range	0.5 to 400 Hz
Frequency accuracy (temperature fluctuation)	Digital command: ±0.01% (−10°C to 50°C) Analog command: ±1% (25 ±10°C)
Frequency setting resolution	Digital command: 0.1 Hz (less than 100 Hz), 1 Hz (100 Hz or more) Analog command: 0.06 Hz (60 Hz)
Frequency output resolution	0.1 Hz (operation resolution)
Overload resistance	1 minute or less when 150% of rated output current is received
Frequency setting signal	0 to 10 VDC (20 kΩ) or 4 to 20 mA (250 Ω) Note This setting can be switched using the internal DIP switch.
Acceleration/Deceleration time	0.0 to 999 seconds (acceleration and deceleration times are set separately)
Braking torque (continuous regenerative braking)	Approximately 20% Note 125% to 220% when braking resistor is externally installed.
Voltage/Frequency characteristics	Simple V/f pattern setting

■ Protection Functions

Motor protection	Electronic thermal protection
Instantaneous overcurrent protection	When 250% of the rated output amperage is exceeded
Overload protection	When 150% of the rated output amperage is exceeded for one minute
Overvoltage protection	Stops the system when DC voltage of the main circuit exceeds approximately 410 V (400-VAC Class approximately 820 V)
Voltage drop protection	3G3EV-A2■ M: Stops the system when voltage drops below approximately 200 V 3G3EV-AB■ M: Stops the system when voltage drops below approximately 160 V 3G3EV-A4■ M: Stops the system when voltage drops below approximately 400 V
Protection from instantaneous power interruption	Stops the system when a power interruption lasts for 15 ms or more. Operation can be continued by setting constant No. 36 as follows: <ul style="list-style-type: none"> • Operation is continued if a power interruption only lasts for approximately 0.5 second or less. • Operation is continued unconditionally.
Radiation fin overheat protection	Detects a fin temperature of 110 ±10°C
Ground protection	Overcurrent level protection

■ Operation Specifications

<p>Control input</p>	<p>Three photocoupler input terminals (24 VDC, 8 mA)</p> <ul style="list-style-type: none"> • Forward/stop [SF] • Reverse/stop [SR] • Multi-function input [S1] (set in constant No. 06) • Multi-function input [S2] (set in constant No. 07) • Multi-function input [S3] (set in constant No. 08) <p>Note When 3-wire sequence mode (constant No. 01 = “9”) is selected, the terminals become as follows:</p> <ul style="list-style-type: none"> • Run command [SF] • Stop command [SR] • Forward/reverse rotation command [S1] <hr/> <p>One analog input terminal (0 to 10 VDC or 4 to 20 mA)</p> <ul style="list-style-type: none"> • Frequency reference input [Between FC and FR]
<p>Control output</p>	<p>One SPDT relay contact output terminal [MA, MB] (30 VDC and 1A; 250 VAC and 1A)</p> <ul style="list-style-type: none"> • Multi-function contact output (set in constant No. 09) <hr/> <p>One photocoupler input terminal [PA] (48 VDC, 50 mA)</p> <ul style="list-style-type: none"> • Multi-function photocoupler output (set in constant No. 10)
<p>Analog output</p>	<p>One analog voltage output [AM] (0 to 10 VDC, 2 mA)</p> <ul style="list-style-type: none"> • Multi-functional analog output (Constant No. 44 is used to set the function and constant No. 45 is used to set the multiplying factor.) <p>The output frequency or output current can be monitored. The Inverter is factory-set to output frequency monitoring.</p>

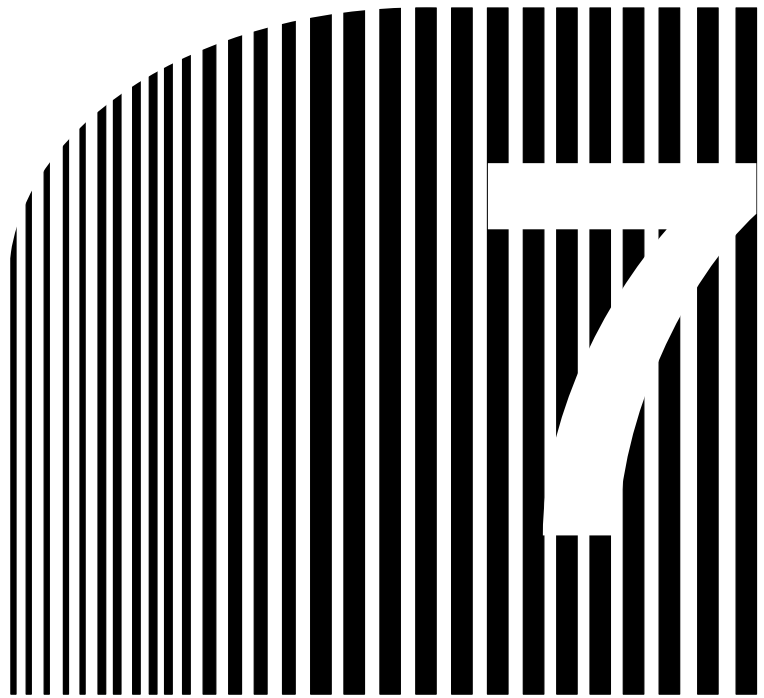

Chapter 7

• Appendix A •

7-1 Notes on Using Inverter for Motor

7-2 Frequency Reference by Amperage Input

7-3 List of Product Models

7-1 Notes on Using Inverter for Motor

■ Using Inverter for Existing Standard Motor

When a standard motor is operated with this Inverter, a power loss is slightly higher than when operated with a commercial power supply.

In addition, cooling effects also decline in the low-speed range, resulting in an increase in the motor temperature. Therefore, motor torque should be reduced in the low speed range.

The figure on the right-hand side shows allowable load characteristics of a standard motor.

If 100% torque is continuously required in the low-speed range, use a special motor for use with Inverters.

Allowable Load Characteristics of Standard Motor

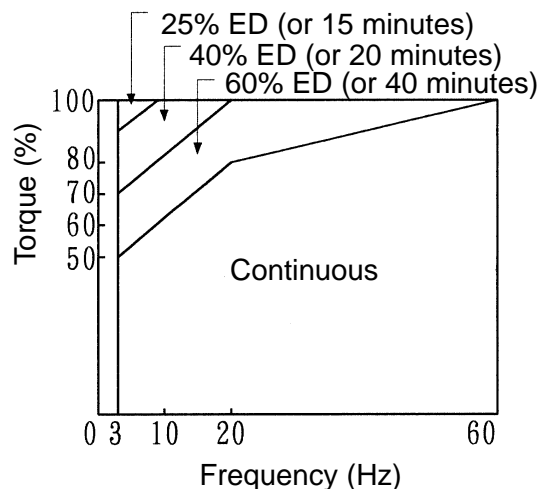

● High-speed Operation

When using the motor at a high speed (60 Hz or more), note that problems may arise in dynamic balance, bearing durability, and so on.

● Torque Characteristics

When the motor is operated with the Inverter, torque characteristics differ from when operated with a commercial power supply. Check the load torque characteristics of the machine to be used with the motor.

● **Vibration**

The 3G3EV series employs high carrier PWM control to reduce motor vibration. When the motor is operated with this Inverter, motor vibration is almost the same as when operated with a commercial power supply.

However, motor vibration may become greater in the following cases:

- **Resonance with the natural frequency of mechanical system**

Take special care when a machine that has been operated at a constant speed is to be operated in variable speed mode. If resonance occurs, install vibration-proof rubber on the motor base.

- **Imbalanced rotor**

Take special care when the motor is operated at a high speed (60 Hz or more).

● **Noise**

Noise is almost the same as when the motor is operated with a commercial power supply. However, motor noise becomes louder when the motor is operated at a speed higher than the rated speed (60 Hz).

■ **Using Inverter for Special Motors**

● **Pole-changing Motor**

The rated amperage of pole-changing motors differs from that of standard motors. Select, therefore, an appropriate Inverter according to the maximum amperage of the motor to be used. Before changing the number of poles, always make sure that the motor has stopped. Otherwise, the overvoltage protection or overcurrent protection mechanism will be actuated, resulting in an error.

● **Submersible Motor**

The rated amperage of submersible motors is higher than that of standard motors. Therefore, always select an Inverter by checking its rated amperage. When the distance between the motor and the Inverter is long, use a cable thick enough to prevent motor torque reduction.

● **Explosion-proof Motor**

When an explosion-proof motor or increased safety type motor is to be used, it must be subject to an explosion-proof test in conjunction with the Inverter. This is also applicable when an existing explosion-proof motor is to be operated with the Inverter. However, since the Inverter itself is not explosion-proof, always install it in a safe place.

● Gearmotor

The speed range for continuous operation differs according to the lubrication method and motor manufacturer. In particular, continuous operation of an oil-lubricated motor in the low speed range may result in burning. If the motor is to be operated at a speed higher than 60 Hz, consult with the manufacturer.

● Synchronous Motor

This motor is not suitable for Inverter control. If a group of synchronous motors is individually turned on and off, synchronism may be lost.

● Single-phase Motor

This motor is not suitable for Inverter control. It should be replaced with a three-phase motor.

■ Power Transmission Mechanism (Speed Reducers, Belts, Chains, and so on)

If an oil-lubricated gearbox or speed reducer is used in the power transmission mechanism, note that oil lubrication will be affected when the motor operates only in the low speed range. Note also that the power transmission mechanism will make noise and experience problems with service life and durability if the motor is operated at a speed higher than 60 Hz.

7-2 Frequency Reference by Amperage Input

Frequency references can be input in terms of amperage (4 to 20 mA) by changing the setting of the DIP switch inside the Inverter.

■ Using the DIP Switch**1. Changing constant settings**

Before using the DIP switch, always set “4” or “5” in constant no. 02 (operation mode selection).

Note n02 = 4: Run commands are input through the Digital Operator, and frequency references are input through control terminals.

n02 = 5: Both run commands and frequency references are input through control terminals.

2. Turning power off

Turn the power off, wait at least one minute after all indicators on the front panel go off, then perform the following tasks.

3. Removing the Digital Operator

Insert a finger in the recessed section below the Digital Operator, then lift the underneath of the Digital Operator.

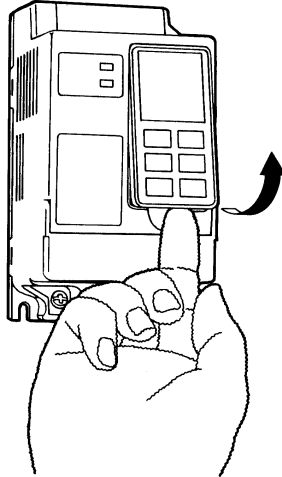

When the connector comes off, grip the lower edges of the Digital Operator, and slide it down until it comes off.

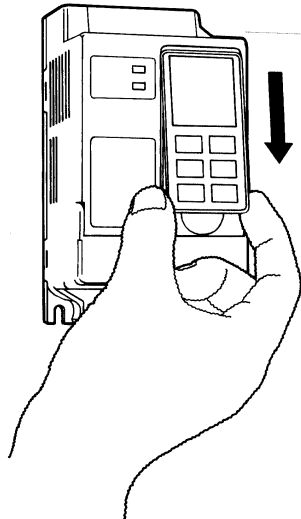

4. Checking the DIP switch setting

The DIP switch is located in the lower part of the recessed section from which the Digital Operator was removed.

“SW1” is marked near the switch.

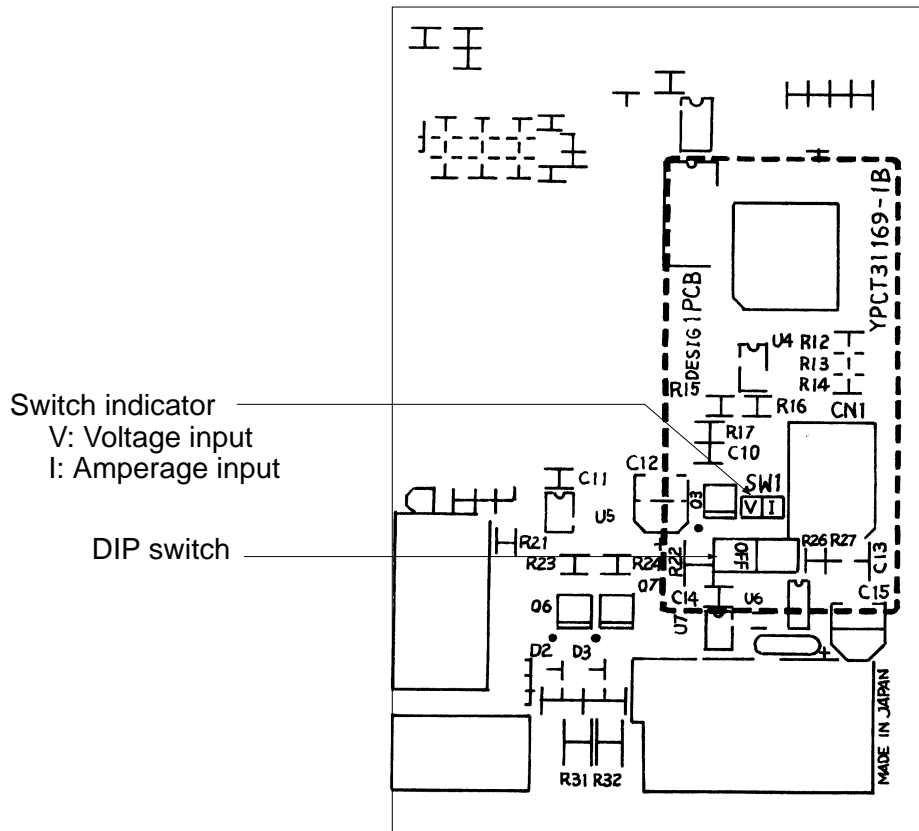

5. Changing the DIP switch setting

To use amperage input mode, set this switch to ON by sliding it to the right.

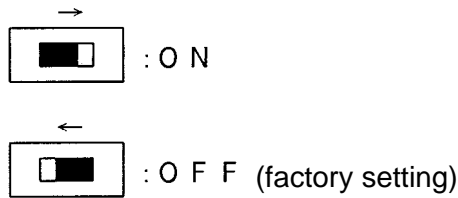

6. Reinstalling the Digital Operator

After changing the switch setting, reinstall the Digital Operator by reversing the removal procedure. Make sure that the Digital Operator snaps in the connector.

Caution If frequency references are input in terms of voltage, never change the DIP switch setting (OFF). If voltage is input when the DIP switch is set to ON, the resistor may burn, resulting in damage to the equipment.

7-3 List of Product Models

■ Inverter

Specifications		Model	
Standard models	Three-phase 200-VAC input	0.1 kW	3G3EV-A2001(-)
		0.2 kW	3G3EV-A2002(-)
		0.4 kW	3G3EV-A2004(-)
		0.75 kW	3G3EV-A2007(-)
		1.5 kW	3G3EV-A2015(-)
	Single/Three-phase 200-VAC input	0.1 kW	3G3EV-AB001(-)
		0.2 kW	3G3EV-AB002(-)
		0.4 kW	3G3EV-AB004(-)
		0.75 kW	3G3EV-AB007(-)
1.5 kW		3G3EV-AB015(-)	
Three-phase 400-VAC input	0.2 kW	3G3EV-A4002(-)	
	0.4 kW	3G3EV-A4004(-)	
	0.75 kW	3G3EV-A4007(-)	
	1.5 kW	3G3EV-A4015(-)	
Multi-function models	Three-phase 200-VAC input	0.1 kW	3G3EV-A2001M(-)
		0.2 kW	3G3EV-A2002M(-)
		0.4 kW	3G3EV-A2004M(-)
		0.75 kW	3G3EV-A2007M(-)
		1.5 kW	3G3EV-A2015M(-)
	Single/Three-phase 200-VAC input	0.1 kW	3G3EV-AB001M(-)
		0.2 kW	3G3EV-AB002M(-)
		0.4 kW	3G3EV-AB004M(-)
		0.75 kW	3G3EV-AB007M(-)
1.5 kW		3G3EV-AB015M(-)	
Three-phase 400-VAC input	0.2 kW	3G3EV-A4002M(-)	
	0.4 kW	3G3EV-A4004M(-)	
	0.75 kW	3G3EV-A4007M(-)	
	1.5 kW	3G3EV-A4015M(-)	
SYSMAC BUS models	Three-phase 200-VAC input	0.1 kW	3G3EV-A2001R(-)
		0.2 kW	3G3EV-A2002R(-)
		0.4 kW	3G3EV-A2004R(-)
		0.75 kW	3G3EV-A2007R(-)
		1.5 kW	3G3EV-A2015R(-)
	Single/Three-phase 200-VAC input	0.1 kW	3G3EV-AB001R(-)
		0.2 kW	3G3EV-AB002R(-)
		0.4 kW	3G3EV-AB004R(-)
		0.75 kW	3G3EV-AB007R(-)

■ Braking Resistor (Duty Cycle 3% ED)

Specifications			Model
200-VAC Class	0.1 kW/0.2 kW	400 Ω	3G3IV-PERF150WJ401
	0.4 kW/0.75 kW	200 Ω	3G3IV-PERF150WJ201
	1.5 kW	100 Ω	3G3IV-PERF150WJ101
400-VAC Class	0.75 kW or less	750 Ω	3G3IV-PERF150WJ751
	1.5 kW	400 Ω	3G3IV-PERF150WJ401

■ Braking Resistor Unit (Duty Cycle 10% ED)

Specifications			Model
200-VAC Class	0.4kW/0.75 kW	200 Ω, 70 W	3G3IV-PLKEB20P7
	1.5 kW	100 Ω, 260 W	3G3IV-PLKEB21P5
400-VAC Class	0.75 kW or less	750 Ω, 70 W	3G3IV-PLKEB40P7
	1.5 kW	400 Ω, 260 W	3G3IV-PLKEB41P5

■ AC Reactor (for Three-Phase)

Specifications			Model
Three-phase 200 V	0.1/0.2 kW	2 A 7.0 mH	3G3IV-PUZBAB2A7.0MH
	0.4 kW	2.5 A 4.2 mH	3G3IV-PUZBAB2.5A4.2MH
	0.75 kW	5 A 2.1 mH	3G3IV-PUZBAB5A2.1MH
	1.5 kW	10 A 1.1 mH	3G3IV-PUZBAB10A1.1MH
Three-phase 400 V	0.2/0.4 kW	1.3 A 18.0 mH	3G3IV-PUZBAB1.3A18.0MH
	0.75 kW	2.5 A 8.4 mH	3G3IV-PUZBAB2.5A8.4MH
	1.5 kW	5 A 4.2 mH	3G3IV-PUZBAB5A4.2MH

■ Simple Input Noise Filter

Specifications			Model
Three-phase 200 V	0.1 to 0.75 kW	10 A	3G3EV-PLNFD2103DY
	1.5 kW	15 A	3G3EV-PLNFD2153DY
Single-phase 200 V	0.1 to 0.2 kW	10 A	3G3EV-PLNFB2102DY
	0.4 kW	15 A	3G3EV-PLNFB2152DY
	0.75 kW	20 A	3G3EV-PLNFB2202DY
	1.5 kW	30 A	3G3EV-PLNFB2302DY
Three-phase 400 V	0.2 to 0.75 kW	5 A	3G3EV-PLNFD4053DY
	1.5 kW	10 A	3G3EV-PLNFD4103DY

■ Output Noise Filter

Specifications			Model
Three-phase 200 V	0.1 to 1.5 kW	10 A	3G3IV-PLF310KA
Three-phase 400 V	0.2 to 1.5 kW	10 A	3G3IV-PLF310KB

■ Variable Resistor Unit

Specifications		Model
3G3EV	2 k Ω 0.5 W	3G3EV-PETX3200

■ DIN Track

Specifications	Model
3G3EV-A2001(-) to 3G3EV-A2004(-) 3G3EV-AB001(-) and 3G3EV-AB002(-)	3G3IV-PEZZ08122A
3G3EV-A2007(-) to 3G3EV-A2015(-) 3G3EV-AB004(-) and 3G3EV-AB007(-) 3G3EV-A4002(-) to 3G3EV-A4007(-)	3G3IV-PEZZ08122B

■ English Digital Operator Seals

Specifications		Model
For 3G3EV	A set of 5 seals	3G3EV-PJVOP120ES

List of Constants Used with 3G3EV

Multi-function Model

Constant no.	Indicators	Description	Setting range		Setting
n01		Constant write-inhibit selection /constant initialization	0: Only n01 can be set. 1: All constants can be set. 8: Constant settings are initialized. 9: Inverter is initialized in 3-wire sequence mode.		
n02	MODE	Mode operation selection		Run command	Frequency reference
			0	Digital Operator	Digital Operator
			1	Control terminal	Digital Operator
			2	Digital Operator	Control terminal (voltage input)
			3	Control terminal	Control terminal (voltage input)
			4	Digital Operator	Control terminal (amperage input)
			5	Control terminal	Control terminal (amperage input)
n03		Stop mode selection	0: Deceleration stop 1: Free running		
n04	F/R	Forward /Reverse rotation selection	<i>F_{or}</i> : forward rotation <i>r_{Ev}</i> : reverse rotation		
n05		Reverse rotation-inhibit selection	0: Accept 1: Not accept		
n06		Multi-function input selection 1	0: Forward/reverse rotation command 1: Fault reset 2: External fault (external fault when ON) 3: External fault (external fault when OFF) 4: Multi-step speed command 1 5: Multi-step speed command 2 6: Multi-step speed command 3 7: Inching command 8: Acceleration/Deceleration time changeover command 9: External base block command (base block when ON)		

Constant no.	Indicators	Description	Setting range	Setting
			10: External base block command (base block when OFF) 11: Search command from maximum frequency 12: Search command from preset frequency 13: Acceleration/Deceleration-inhibit command 14: Local/Remote changeover command	
n07		Multi-function input selection 2	1 to 14: Same as for n06 Invalid when n08 = 15	[2]
n08		Multi-function input selection 3	1 to 14: Same as for n06 15: Up/Down command	[4]
n09		Multi-function output selection 1 (MA, MB)	0: Fault occurrence 1: Operation in progress 2: Frequency matching 3: Idling 4: Frequency detection Output frequency \geq frequency detection level determined with constant set in n53 5: Frequency detection Output frequency \leq frequency detection level determined with constant set in n53 6: Over-torque being monitored 7: Base block in progress 8: Undervoltage (UV) being monitored 9: Speed search 10: Run mode	
n10		Multi-function input selection 2 (PA)	0 to 10: Same as for n09	[0]
n11	<input type="checkbox"/> FREF	Frequency reference 1	0.0 to 400 (Hz)	[6.0]
n12	<input type="checkbox"/> FREF	Frequency reference 2	0.0 to 400 (Hz)	[0.0]
n13	<input type="checkbox"/> FREF	Frequency reference 3	0.0 to 400 (Hz)	[0.0]
n14	<input type="checkbox"/> FREF	Frequency reference 4	0.0 to 400 (Hz)	[0.0]
n15	<input type="checkbox"/> FREF	Frequency reference 5	0.0 to 400 (Hz)	[0.0]

Constant no.	Indicators	Description	Setting range	Setting
n16	FREF	Frequency reference 6	0.0 to 400 (Hz)	[0.0]
n17	FREF	Frequency reference 7	0.0 to 400 (Hz)	[0.0]
n18	FREF	Frequency reference 8	0.0 to 400 (Hz)	[0.0]
n19		Inching frequency command	0.0 to 400 (Hz)	[6.0]
n20	ACC	Acceleration time 1	0.0 to 999 (seconds)	[10.0]
n21	DEC	Deceleration time 1	0.0 to 999 (seconds)	[10.0]
n22	ACC	Acceleration time 2	0.0 to 999 (seconds)	[10.0]
n23	DEC	Deceleration time 2	0.0 to 999 (seconds)	[10.0]
n24	FMAX	Maximum frequency	50.0 to 400 (Hz)	[60.0]
n25	VMAX	Maximum voltage	1 to 255 (V) (see note 1)	[200]
n26	FBAS	Maximum voltage frequency (basic frequency)	0.6 to 400 (Hz)	[60.0]
n27		Intermediate output frequency	0.1 to 399 (Hz)	[1.5]
n28		Intermediate output frequency voltage	1 to 255 (V) (see note 1)	[12]
n29		Minimum output frequency	0.1 to 10.0 (Hz)	[1.5]
n30		Minimum output frequency voltage	1 to 50 (V) (see note 1)	[12]
n31	THR	Electronic thermal reference current	0.0 to 120% of rated Inverter amperage Specify the rated motor amperage.	
n32		Electronic thermal protection	0: Standard motor with standard ratings 1: Standard motor with short-time ratings 2: Dedicated motor with standard ratings	

Constant no.	Indicators	Description	Setting range	Setting
			3: Dedicated motor with short-time ratings 4: No thermal protection	
n33		Stall prevention during deceleration	0: Stall prevention 1: No stall prevention	
n34		Stall prevention level during acceleration	30 to 200 (%) [170] (Based on the rated inverter current as 100 percent)	
n35		Stall prevention level during operation	30 to 200 (%) [160] (Based on the rated inverter current at 100 percent)	
n36		Operation after recovery from instantaneous power interruption	0: Discontinues operation. 1: Continues operation only if the power interruption is within 0.5 second. 2: Continues operation unconditionally.	
n37		Carrier frequency	1: 2.5 (kHz) (see note 2) 2: 5 (kHz) 3: 7.5 (kHz) 4: 10 (kHz)	
n38		Automatic torque boost gain	0.0 to 3.0 [1.0]	
n39		Frequency reference gain	0.10 to 2.55 (times) [1.00]	
n40		Frequency reference bias	-99 to 99 (%) [0]	
n41		Frequency reference upper limit	0 to 110 (%) [100]	
n42		Frequency reference lower limit	0 to 110 (%) [0]	
n43		Frequency reference input terminal	0: Frequency reference 1: Fault reset	
n44		Multi-function analog output	0: Output frequency 1: Output current	

Constant no.	Indicators	Description	Setting range	Setting
n45		Multi-function analog output gain	0.00 to 2.00 [0.30]	
n46		DC control current	0 to 100 (%) [50]	
n47		Interruption DC control time	0.0 to 5.0 (seconds) [0.5]	
n48		Startup DC control time	0.0 to 5.0 (seconds) [0.0]	
n49		S-shape acceleration and deceleration characteristic	0: No s-shape acceleration or deceleration 1: S-shape characteristic time set to 0.2 second 2: S-shape characteristic time set to 0.5 second 3: S-shape characteristic time set to 1.0 second	
n50		Over-torque detection function selection	0: Inverter does not monitor over-torque. 1: Inverter monitors over-torque only when speed is matched. It continues operation even when over-torque is detected. 2: Inverter monitors over-torque only when speed is matched. It discontinues operation when over-torque is detected. 3: Inverter always monitors over-torque during operation. It continues operation even when over-torque is detected. 4: Inverter always monitors over-torque during operation. It discontinues operation when over-torque is detected.	
n51		Over-torque detection level	30 to 200 (%) [160]	
n52		Over-torque detection time	0.1 to 10.0 (seconds) [0.1]	
n53		Frequency detection level	0.0 to 400 (Hz) [0.0]	
n54		Slip compensation gain	0.0 to 9.9 (%) [0.0]	

Constant no.	Indicators	Description	Setting range	Setting
n55		Motor current with no load	0 to 99 (%)	[40]
n56		Jump frequency 1	0.0 to 400 (Hz)	[0.0]
n57		Jump frequency 2	0.0 to 400 (Hz)	[0.0]
n58		Jump frequency 3	0.0 to 400 (Hz)	[0.0]
n59		Jump width	0.0 to 25.5 (Hz)	[1.0]
n60		Number of fault retries	0 to 10 (times)	[0]
n61		Stop Key selection	0, 1	[0]
n62		Slip compensation primary delay time	0.0 to 25.5	[2.0]
n63		UP/DOWN command frequency memory	0, 1	[0]
n64		Operator's frequency setting method	0, 1	[0]

Note 1. The upper limit of setting range and the factory settings for the 400-VAC-class Inverters are double the above values.

Note 2. The setting range of the 400-VAC-class Inverter is “1 to 5.” The factory setting of the 3G3EV-A4015M-CUE is “3.”

Note 3. Values in shaded sections or values in brackets represent factory settings.