

## Multi-maintenance Counter

## H8BM

### Nine Built-in Counters/Timers to Measure Equipment Utilization

- Up to nine Counters can be used as counters or accumulative timers.
- Can be used as a multi-stage preset counter.
- Individual outputs to indicate maintenance timing.
- Pre-forecast/Forecast and machine stoppage output provided.
- IP54F enclosure rating for resistance to oil and water.
- Compact, short-body: 72 x 72 x 79 mm (DIN).
- Directly connectable to 2-wire DC sensors.



### Ordering Information

Number of stages	Output	Model
3-stage setting	NPN	H8BM-B
	PNP	H8BM-BP
1-stage setting	NPN	H8BM-BD
	PNP	H8BD-BDP

### ■ Accessories (Order Separately) Replacement Parts

Name	Model
Hard Protective Cover	Y92A-72C
Rubber Packing	Y92S-25

A Hard Protective Cover and Rubber Packing are supplied with the Counter.

### Short Bar

Short Bar	Y92S-26
-----------	---------

When the Counter is used as a multi-stage preset counter, wiring will be facilitated if Counter inputs 1 through 9 are short-circuited with the following Short Bar.

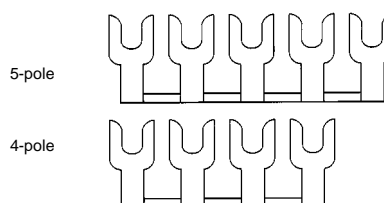

Both the 5-pole and 4-pole Short Bars are used to short-circuit the 9 Counter inputs.

# Specifications

Item	H8BM-B, H8BM-BP	H8BM-BD, H8BM-BDP
<b>Classification</b>	3-stage setting	1-stage setting
<b>Mounting method</b>	Flush mounting	
<b>External connections</b>	Screw terminals	
<b>Enclosure ratings</b>	IP54F (panel surface)	
<b>Display mode</b>	Up display	
<b>Output mode</b>	F mode	
<b>Reset system</b>	External, manual resets	
<b>Timing function</b>	Yes	
<b>Input signal method</b>	Voltage inputs: High and low signal voltages (count, reset, re-monitor, counter select, I/O inhibit)	
<b>Control output</b>	No-contact outputs: NPN outputs (RUN, forecast, machine stoppage) (PNP outputs for -BP)	No-contact outputs: NPN outputs (RUN, forecast) (PNP outputs for -BDP)
<b>Display</b>	Count, preset value, counter number, and error codes displayed on 7-segment LCD Power-ON, mode, reset, I/O inhibit, and re-monitor modes displayed on LCD characters Output indication on LCD characters and LEDs	
<b>LCD with backlight</b>	Yes	
<b>Built-in counter number</b>	9 (counters 1 to 9) (see Note 1)	
<b>Number of stages</b>	3 stages (see Note 2)	1 stage (see Note 5)
<b>Digits</b>	Forecast value: 6 digits (999999) Pre-forecast value: -5 digits (see Note 3) Machine stoppage: +5 digits (see Note 4)	6 digits (999999)
<b>Max. time settings</b>	Forecast value: 99999.9 hr (0.1 hr or more) Pre-forecast value: -9999.9 hr (see Note 3) Machine stoppage: +9999.9 hr (see Note 4)	99999.9 hr (0.1 hr or more)
<b>Memory backup</b>	Backup time for power interruption: Approx. 10 years at 25°C	
<b>Approved standards</b>	UL508, CSA C22.2 No.14	

- Note:**
- Each channel operates on an separate I/O.
  - Pre-forecast: Displayed only on LCD (No external output is provided.)  
Forecast: Displayed on LCD and LED and output (Output for each Counter)  
Machine stoppage: Displayed on LCD and LED and output  
(Output when the count value of one or more of Counters 1 to 9 has reached its machine stoppage value.)
  - The pre-forecast value is set as a negative offset in respect to the forecast value.
  - The machine stoppage value is set as a positive offset in respect to the forecast value.
  - This model operates on the forecast value only.

## ■ Ratings

<b>Rated voltage</b>	24 VDC
<b>Operating voltage range</b>	85% to 110% of rated voltage (see Note 1)
<b>Power consumption</b>	Approx. 1.8 W (at 24 VDC) (see Note 2)
<b>Max. counting speed</b>	30 cps (ON:OFF = 1:1)
<b>Min. input signal width</b>	Counter No. selection input: 16.7 ms max. Reset input: 100 ms max. Re-monitor input: 30 ms max. Output number request input: 30 ms max. I/O inhibit input: 16.7 ms max.
<b>One-shot output time</b>	20 ms (see Note 3)
<b>Count, reset, re-monitor, output number request, and I/O inhibit input</b>	Voltage input (see Note 4) (input resistance: approx. 2.2 kΩ) High level: 16 to 30 VDC Low level: 0 to 3 VDC
<b>Control output</b>	Open-collector output: 100 mA max. at 30 VDC max.
<b>Case color</b>	Light gray (Munsell 5Y3/1)

- Note:**
- Ripple content: 20% max.
  - On power application, an inrush current of approx. 1.2 A flows into the Counter.
  - This signal is output as a carry signal when the Counter is used as a totalizing counter.
  - This signal can also be used as a no-voltage input signal depending on the wiring (refer to Input Connections).

■ Characteristics

<b>Insulation resistance</b>	100 MΩ min. (at 250 VDC) (between current-carrying terminals and exposed non-current-carrying metal parts)
<b>Dielectric strength</b>	1,000 VAC, 50/60 Hz for 1 min (between current-carrying terminals and exposed non-current-carrying metal parts)
<b>Impulse withstand voltage</b>	1 kV (between power terminals) 1.5 kV (between current-carrying terminals and exposed non-current-carrying metal parts)
<b>Noise immunity</b>	±1 kV (between power terminals) and ±600 V (between input terminals), square-wave noise via noise simulator (pulse width: 100 ns/1 μs, 1-ns rise)
<b>Static immunity</b>	Malfunction: 8 kV; destruction: 15 kV
<b>Vibration resistance</b>	Destruction: 10 to 55 Hz with 0.75 mm single amplitude in three directions Malfunction: 10 to 55 Hz with 0.5 mm single amplitude in three directions
<b>Shock resistance</b>	Destruction: 294 m/s <sup>2</sup> Malfunction: 196 m/s <sup>2</sup>
<b>Ambient temperature</b>	Operating: -10°C to 55°C (with no icing) Storage: -25°C to 65°C (with no icing)
<b>Ambient humidity</b>	Operating: 35% to 85%
<b>Weight</b>	Approx. 290 g

■ Block Diagram

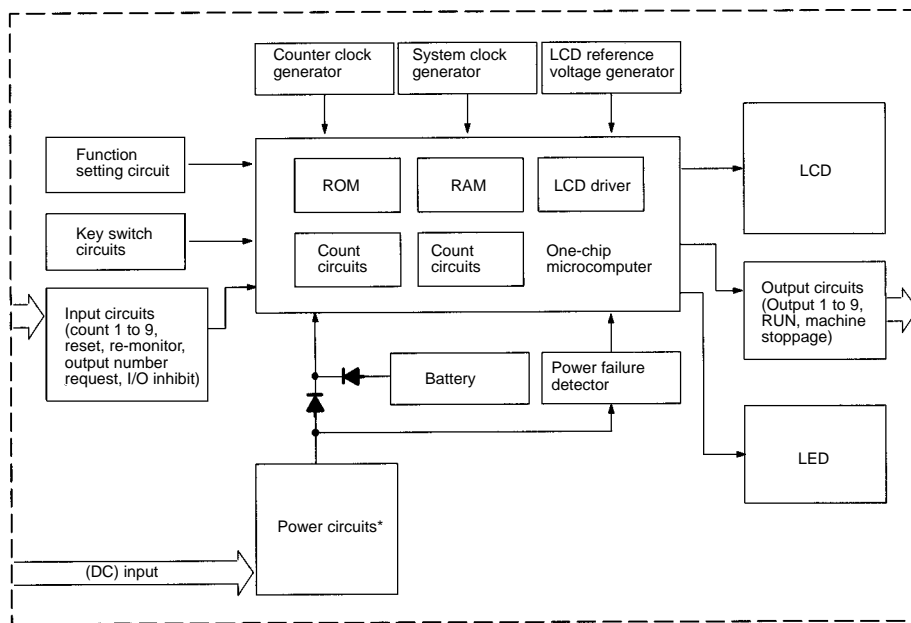

Although the input terminals are electrically insulated from the internal circuit, do not conduct an insulation resistance test on these terminals.

■ I/O Functions

Inputs

<b>Count (1 to 9)</b>	Input count values. Used as time count input signals when Counter is used as timer. Maximum counting speed: 30 Hz (minimum signal width: 16.7 ms)
<b>Reset</b>	Resets displayed count (timing) value of a specified Counter. Counter under reset does not operate and its output is turned OFF. Reset signal input during re-monitor input restores reset count (timing) value of the specified Counter. While reset signal is ON, RST indicator lights.
<b>Re-monitor</b>	Reset count (timing) value of specified Counter can be re-monitored, and restored by reset input. While re-monitor signal is ON, RCV indicator lights.
<b>Counter No. select</b>	Specifies Counter whose count (timing) value is to be displayed.
<b>I/O inhibit</b>	Inhibits count inputs of all Counters. Turns OFF all forecast outputs, RUN outputs, and machine stoppage outputs. While I/O inhibit signal is ON, INHB indicator lights.

Outputs

<b>Forecast (1 to 9)</b>	Each of these outputs turns ON when its forecast value has been reached. When Counter is used as totalizing counter, output one-shot signals as carry signals. Retain outputs until count values are reset.
<b>RUN</b>	Turns ON when Counter is operating normally.
<b>Machine stoppage</b>	Turns ON when count value of one Counter has reached set machine stoppage value. Retains output until count value is reset.

**Note:** The input and output signals are enabled when power is applied to the Counter. During a power failure, the input signals are disabled, and the output signals are turned OFF.

Nomenclature

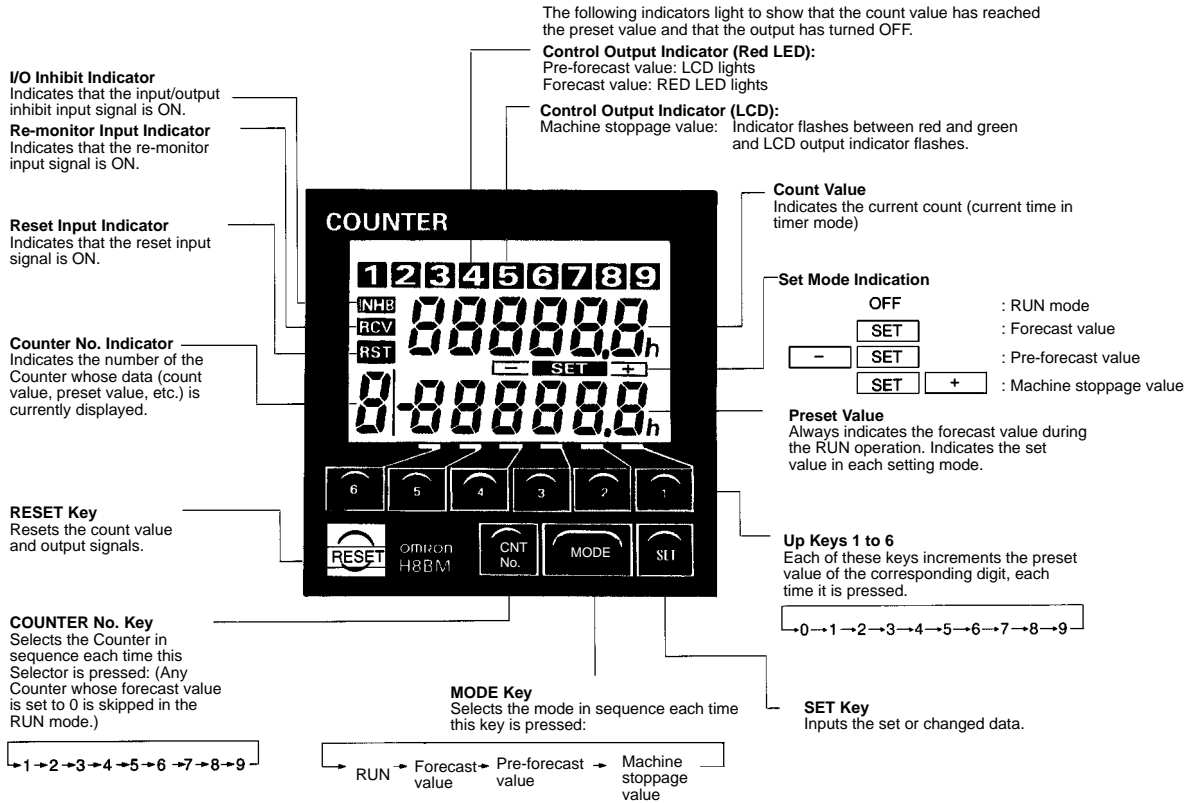

**Note:** Models with only 1-stage setting (H8BM-□D□) are not provided with pre-forecast and machine stoppage output function; only the forecast output function is provided.

# Operation

## ■ Operation

### 1. Selecting Counter/Timer Operation

Whether each Counter operates as a counter or a timer can be specified on a DIP switch provided on the side panel of the Counter. Open the lid of the switch compartment on the side of the Counter. Set each DIP switch pin as necessary by referring to the following figure:

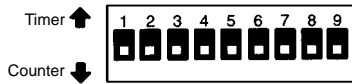

The setting of the DIP switch is read on power application.

**Note:** The setting of the DIP switch that is used to select the counter or timer operation of each Counter is read on power application. Setting change of this DIP switch while the Counter is operating will be ignored. Power must be turned off then back on again after changing settings.

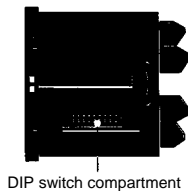

### 2. Changing Mode

Each time the MODE Key is pressed, the mode changes as follows:

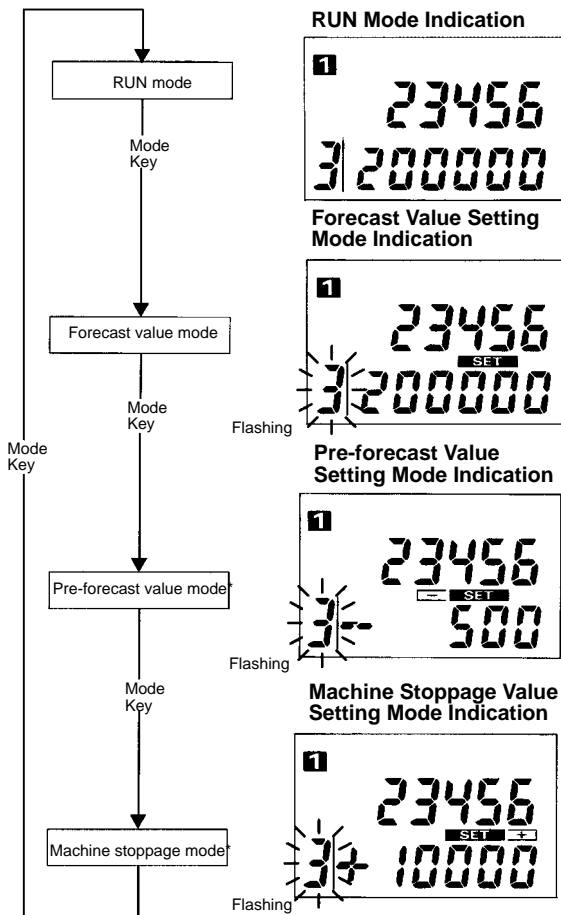

- Note:**
1. The modes marked \* are not provided on the 1-stage type Counter.
  2. I/O operations are always performed regardless of the mode.
  3. If no key is pressed for 1 minute in each mode, the RUN mode is automatically restored.

### 3. Setting/Changing Data (3-stage Type)

#### Setting/Changing Forecast Value

1. Press the MODE Key to enter the forecast value setting mode. The same Counter number as in the RUN mode is displayed.

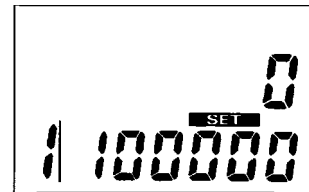

2. Press the COUNTER No. Key to select the Counter whose data is to be set or changed. The Counters are selected in sequence each time the COUNTER No. Key is pressed. A Counter can also be selected by inputting the Counter No. selection.

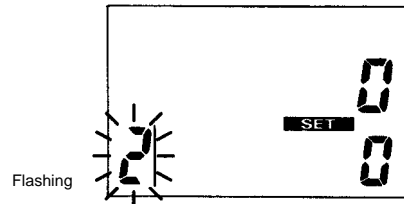
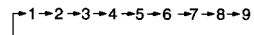

3. Use the Up Keys (1 to 6) to change the values of the digits. When an Up Key is pressed, the corresponding digit starts flashing. The preset value is zero-suppressed. Each time the Up Key is pressed, the specified value increment as:

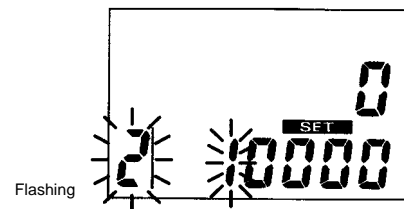
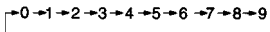

In the following example, the forecast value of Counter 2 is set to 35000.

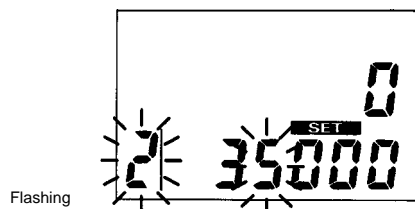

- Press the SET Key to determine the set value. If a Key is pressed within 5 seconds after the SET Key has been pressed, the RUN mode is automatically restored. Key inputs made during the 5 seconds are valid.

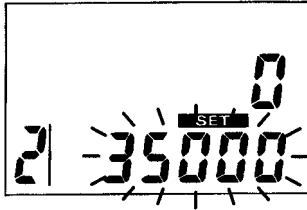

After the set forecast value has flashed, the display is changed automatically as below.

**RUN Mode Indication**

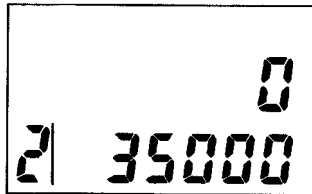

**4. Resetting Count Value**

**Resetting Value for Each Counter**

- Select the Counter whose count value is to be reset by either pressing the COUNTER No Key or inputting the Counter No. select. The count value can be reset in any mode.



- Either press the RESET Key or input the reset signal. The count value of the selected Counter will be reset to 0.



**5. Re-monitoring Count Value**

A count value that has been reset by mistake can be recovered. (ex. Recover previously reset count value "23456" of Counter No. 3)

- Turn ON the re-monitor input. The count value which was reset will be displayed. At this time, the count value is only displayed and not recovered internally. The Counter whose count value is displayed remains in the RUN mode.

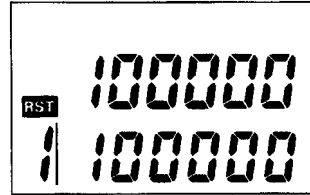

- Press the COUNTER No. Key (or apply the Counter No. select input) to access the Counter whose count value is to be recovered. If the count value does not need to be recovered, the following operations are not necessary.



- Press the RESET Key (or apply the reset input). The recovered value will flash 3 times, and the count value that was reset will be recovered for the designated Counter only. While the recovery input is ON, the recovered count value will remain displayed. However, the internal mechanism of the Counter will continue operating from the count value before resetting.

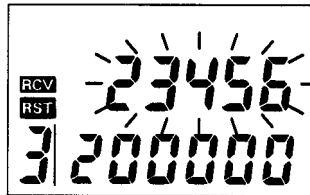

- Turn OFF the re-monitor input to restore normal operation.

**6. Checking Count Values (RUN Mode)**

Select the Counter whose count value is to be checked by pressing the COUNTER No. Key in the RUN mode, or by inputting the Counter No. select. The Counter number changes in sequence each time the COUNTER No. Key is pressed. However, any Counter not used (whose forecast value is set to 0) will be skipped.

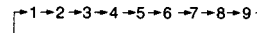

### 7. Count Value Display

While the count input is ON, the period on the count value display flashes. The timer operation measures time by totaling the ON time of the count input.

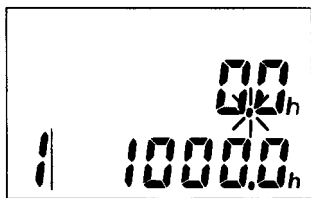

### 8. Output Indicator

The status of the pre-forecast, forecast, and machine stoppage outputs is displayed as follows:

- Pre-forecast:** The number of the Counter whose count value has reached the pre-forecast value is displayed on the LCD. The pre-forecast is only displayed on LCD as a message and no actual output is issued.

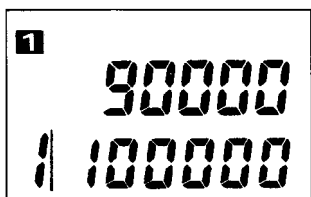

- Forecast Output:** A red indicator lights above the number of the Counter whose count value is displayed on the LCD.

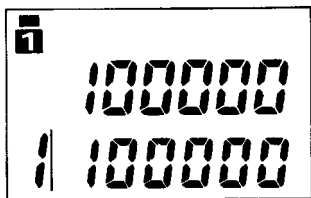

- Machine Stoppage Output:** The background alternately lights in red and green, and the number of the Counter whose machine stoppage output is issued is flashed on the LCD.

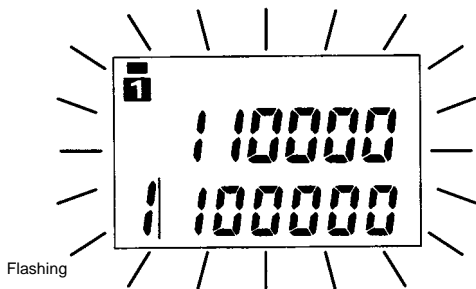

**Note:** When any of the pre-forecast, forecast, and machine stoppage outputs of a Counter has turned ON, the Counter number of that Counter is automatically displayed. When an attempt to reset the count value is made at this time, the count value of only the Counter whose count value is currently displayed is reset (in RUN mode only).

### 9. Clearing Settings

- The count values of all the Counters can be cleared by simultaneously holding down the RESET Key and COUNTER No. Key for 3 seconds.

The same function is effected if the Counter number select input and reset input are simultaneously applied for 3 seconds.

- The count value, pre-forecast value, forecast value, and machine stoppage value of all the Counters can be cleared by simultaneously holding down the RESET and SET Keys for 3 seconds.

### 10. When Used as Totalizing Counter/Timer Counter

By setting the forecast value of a Counter to 999999 (99999.9 hr), the Counter can be used as a totalizing counter/timer. The machine stoppage output of this Counter is not issued. When used as a totalizing counter, the forecast output of this Counter issues a one-shot output for 20 ms as a carry signal when the count value changes from 999999 to 0.

### 11. Self-diagnostic Function

The following displays will appear if an error occurs.

Display	Meaning	Output status	Recovery	Setting after recovery
E1	CPU Error	OFF	Press RESET Key	Normal counter operation is recovered using count and set values from before the error.
E2	Memory Error			Factory setting

■ Timing Charts

Counter (3-stage Preset Operation)

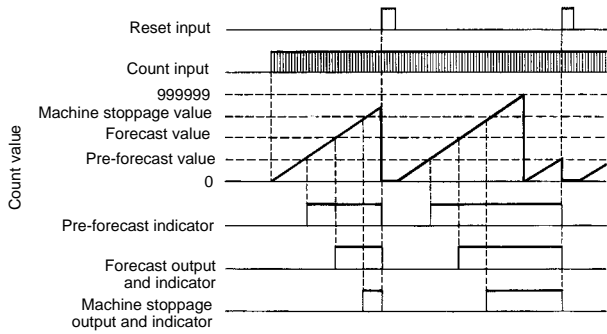

Timer (3-stage Preset Operation)

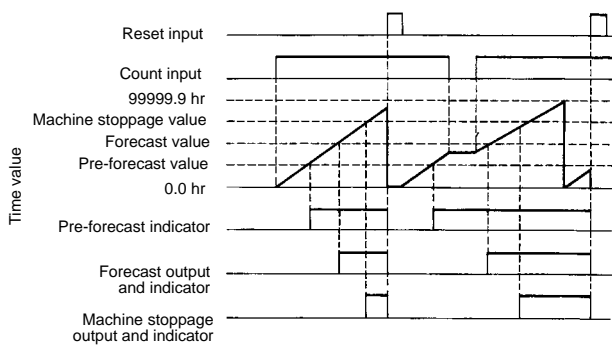

Totalizing Counter Operation

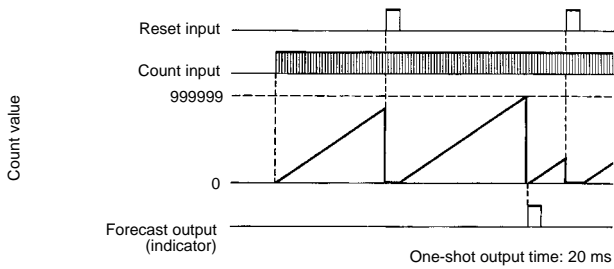

Totalizing Timer Operation

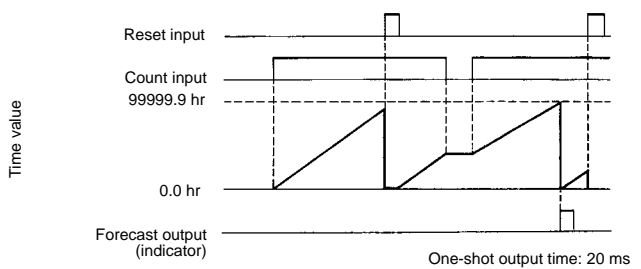

Dimensions

Note: All units are in millimeters unless otherwise indicated.

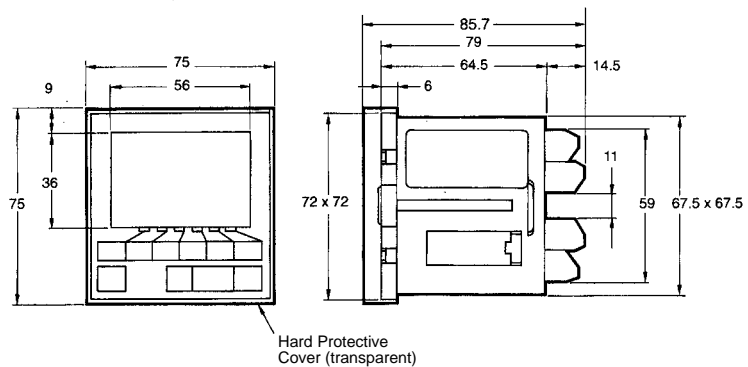
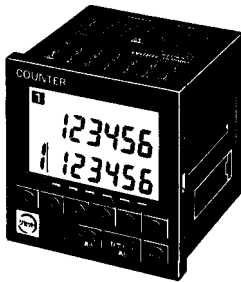

Panel Cutouts

Panel cutout is as shown below (according to DIN43700). The mounting panel thickness should be 1 to 5 mm.

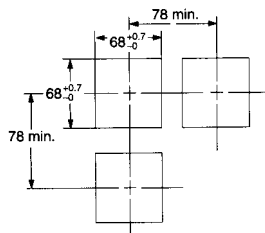



# Installation

## ■ Mounting

To mount the Counter, attach the two fixtures supplied as accessories to the left and right sides of the Counter, and securely tighten the knurled screws on the brackets. If any other screws are used to attach the brackets, or if the knurled screws are excessively tightened with a tool, damage may result.

Provide enough space around the Counter when mounting it to ensure a proper working space.

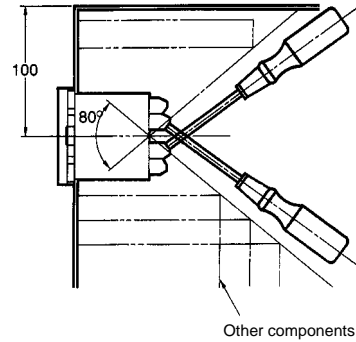
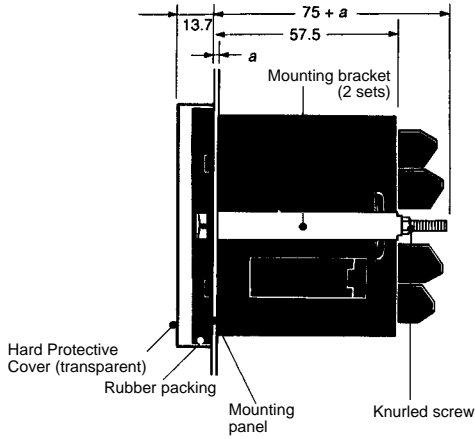

## ■ Terminal Arrangement

22	23	24	25	26	27	28
15	16	17	18	19	20	21
8	9	10	11	12	13	14
1	2	3	4	5	6	7

22	23	24	25	26	27	28
Reset input	Count No. selection	Count input 1	Count input 2	Count input 3	Count input 4	Count input 5
15	16	17	18	19	20	21
Re-monitor input	I/O inhibit input	Count input 6	Count input 7	Count input 8	Count input 9	Input COM
8	9	10	11	12	13	14
RUN output	Machine stoppage output	Forecast output 1	Forecast output 2	Forecast output 3	Forecast output 4	Forecast output 5
1	2	3	4	5	6	7
Power supply: 0 V	Power supply: 24 V	Forecast output 6	Forecast output 7	Forecast output 8	Forecast output 9	Output COM

■ Connections

NPN Output

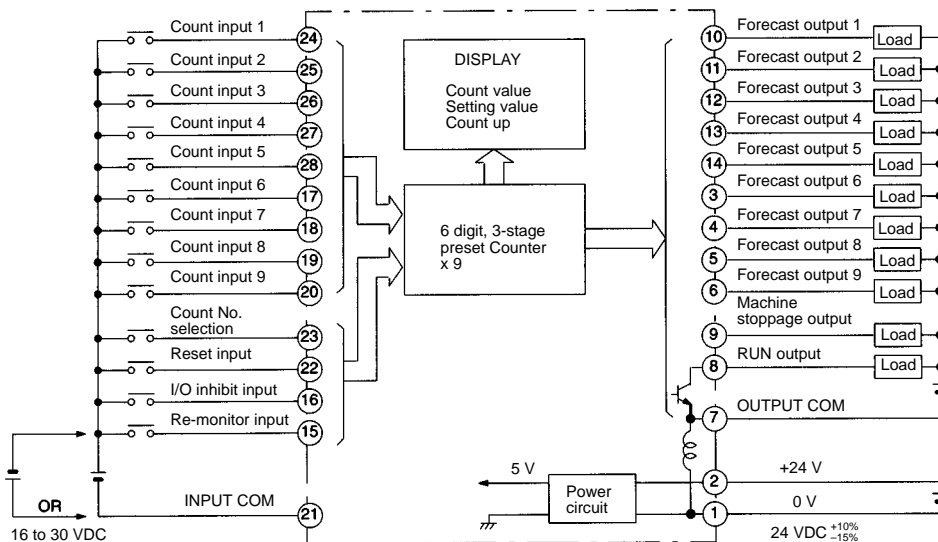

**Note:** Short-circuit terminals 1 and 7 when the power source of the Counter is shared.  
 H8BM-BD/-BDP outputs the forecast and machine stoppage values simultaneously.

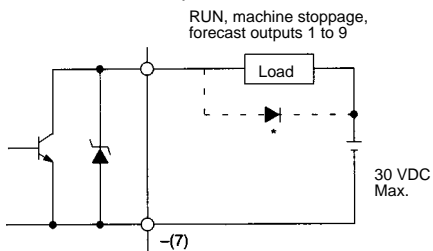

\* Connect a diode to suppress Counter surge when an inductive load is connected.

**Note:** When the load is short-circuited, the internal circuits may be damaged.

PNP Output

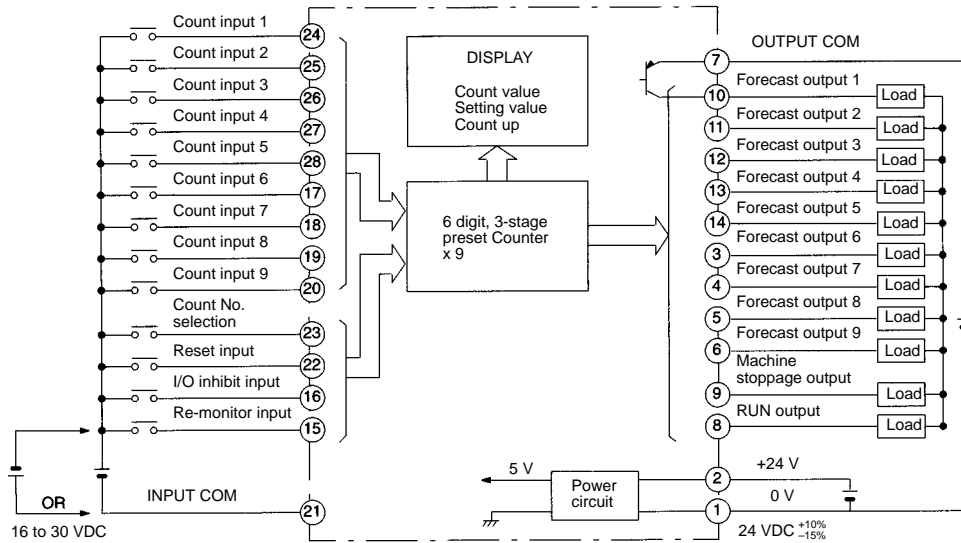

**Note:** H8BM-BD/-BDP outputs the forecast and machine stoppage values simultaneously.

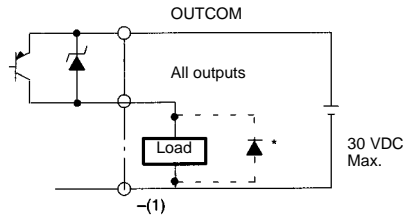

\* Connect a diode to suppress Counter surge when an inductive load is connected.

**Note:** When the load is short-circuited, the internal circuits may be damaged.

<b>Output</b>	RUN, machine stoppage, forecast 1 to 9
<b>Output method</b>	Open collector
<b>Applicable voltage</b>	30 V max.
<b>Rated current</b>	100 mA
<b>Residual voltage</b>	2 V max.
<b>Leakage current</b>	100 $\mu$ A max.

■ I/O Connections

Input Circuits

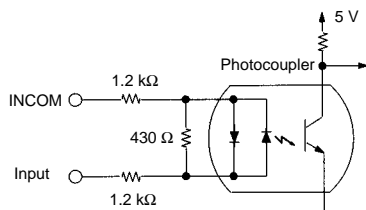

The input terminals are electrically insulated from the internal circuits.

Output Circuits

NPN Type

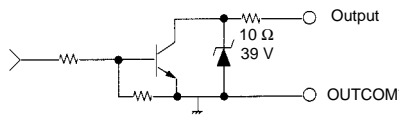

The OUT COM and 0 V terminals are internally connected.

PNP Type

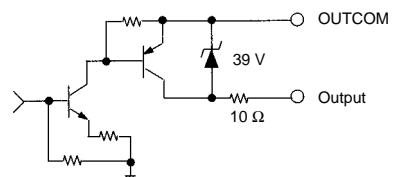

**Example of Input Connections (Solid-state Switches)**

**Two-wire Sensors**

The count input, counter No. select input, reset input, I/O inhibit input, and re-monitor input signals are enabled when voltage is applied.

**Note:** Use the following two-wire sensors:

1. High-level; transistor ON  
Min. switching capacity: 5 mA max.  
Residual voltage: 4 V max.
2. Low-level; transistor OFF  
Leakage current: 1.5 mA max.
3. Power voltage range: 20.4 to 30 VDC

Use of the OMRON TL-XD or E2E-XD-N Sensors is recommended.

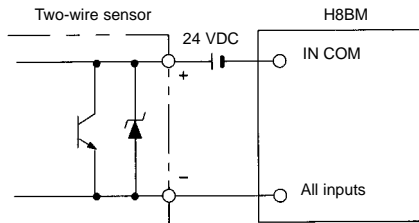
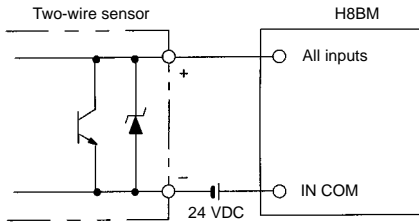

**Three-wire Sensors**

**NPN Type**

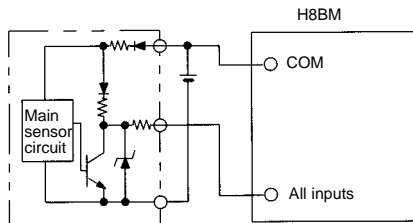
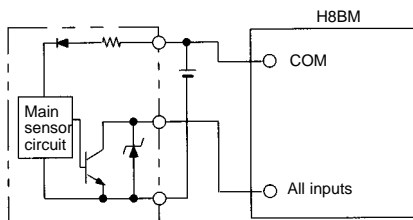

**PNP Type**

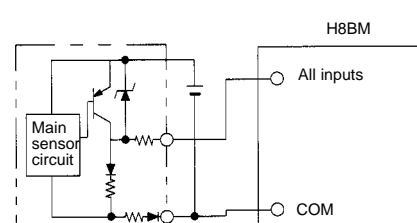
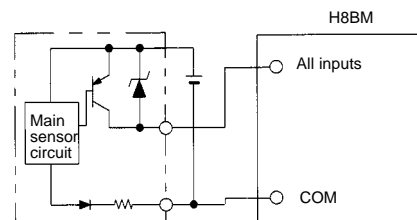

**Contact Switch Connection**

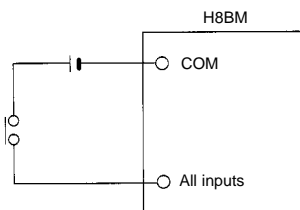
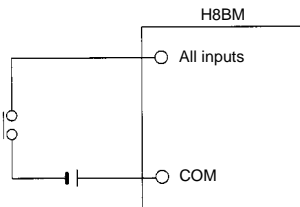

\*H: Contact ON.

\*Use contact that can break 13 mA, 30 V

# Precautions

## ■ Power Supply

- The power supply and input circuits are electrically insulated inside the Counter.
- When turning the power on and off, input signal reception is sometimes not possible as shown in the diagram below. The unstable period will vary with power supply voltage and the load conditions on external power supplies.

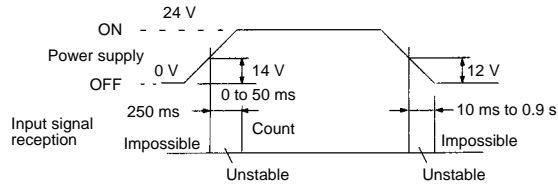

- Turn on or off the operating power source all at once by using switch or relay contact.

## ■ Operating Environment

- The front panel of the Counter is dust-proof and oil-proof. However, if the Counter is exposed to a large quantity of water or oil for a long time, the internal components may be affected.
- When using the Counter in a location where excessive noise is generated keep the Counter, input devices, and input wiring as far away as possible from the noise source and power lines. Use of shielded cable as input signal lines is recommended.
- Organic solvents (such as paint thinner), as well as strong acids or strong alkalies can damage the housing of the Counter.

## ■ Others

- To conduct a dielectric strength test between the electric circuits and non-current-carrying metal parts with the Counter installed in the control panel, either disconnect the Counter from the circuit, or short-circuit all the terminals of the Counter (this is to prevent the test voltage from sneaking into the Counter and prevent the internal circuitry of the Counter from being damaged in case the insulation of some device in the control panel ruptures.
- The terminal screw is M3 x 5. Use the solderless terminal as shown in the following illustration.



### ⚠ Caution

This product contains a lithium battery. Lithium batteries explode if incinerated. Dispose of the Counter as a non-combustible item.

**ALL DIMENSIONS SHOWN ARE IN MILLIMETERS.**

To convert millimeters into inches, multiply by 0.03937. To convert grams into ounces, multiply by 0.03527.

Cat. No. M042-E1-1D In the interest of product improvement, specifications are subject to change without notice.

## OMRON Corporation

Industrial Automation Company

Measuring and Supervisory Controls Department  
Shiokoji Horikawa, Shimogyo-ku,  
Kyoto, 600-8530 Japan  
Tel: (81)75-344-7108/Fax: (81)75-344-7189

Printed in Japan  
0101-0.5C (0499)