

Electromagnetic Counter

CSKE

Compact and Economical Totalizing Counter

- Four mounting methods
- Three supply voltages for AC models and five for DC models
- DC models can be driven by a single-phase, full-wave rectified power source
- Six-digit and seven-digit models available



Ordering Information

Mounting method*	Surface mounting I	Flush mounting I	Surface mounting II	Flush mounting II	
Operating mode	Up counting				
External connection	BY lead wires				
Count input	Contact (voltage) input				
Digit drive system	Half-digit drive system				
Number of digits and model	6	CSKE-6R	CSKE-6F	CSKE-6RL	CSKE-6Y
	7	CSKE-7R	CSKE-7F	CSKE-7RL	CSKE-7Y

- Note:**
1. When placing your order, specify the desired supply voltage listed in *Specifications* and a UL listed model if required, in addition to the model number.
 2. If a UL listed model is required, specify this in your order in addition to the desired model number.

* Mounting Method

Surface mounting I (-R models)	Flush mounting I (-F models)	Surface mounting II (-RL models)	Flush mounting II (-Y models)

Specifications

■ Ratings

Supply voltage (see note)	24, 48, 100 VAC, 50/60 Hz 6, 12, 24, 48, 100 VDC (Can be used with a single-phase, full-wave rectified power source. Contains 48% ripple max.)
Operating voltage range	85 to 110% of rated supply voltage
Power consumption	AC: approx. 2 VA DC: approx. 2 W
Maximum counting speed	10 cps (contact input) Minimum signal width: 50 ms min. (Duty factor: 1:1)

Note: The DC models have no polarity.

■ Characteristics

Insulation resistance	100 M Ω min. (at 500 VDC)
Dielectric strength	1,500 VAC, 50/60 Hz for 1 minute
Vibration resistance	Destruction: 10 to 25 Hz, 2 mm double amplitude Malfunction: 10 to 55 Hz, 0.5 mm double amplitude
Shock resistance	Destruction: 300 m/s ² (approx. 30 G) Malfunction: 50 m/s ² (approx. 5 G)
Ambient temperature	Operating: -10°C to 40°C
Ambient humidity	45% to 85%
Life expectancy	10,000,000 counts
Approved standards (see note)	UL508, CSA C22.2 No.14
Weight	Approx. 100 g

Note: These standards apply to the -US models only.

Dimensions

CSKE-6R CSKE-7R

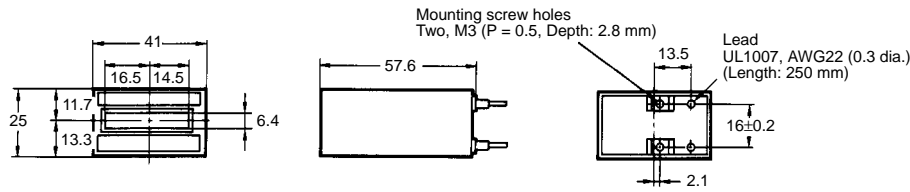

CSKE-6F CSKE-7F

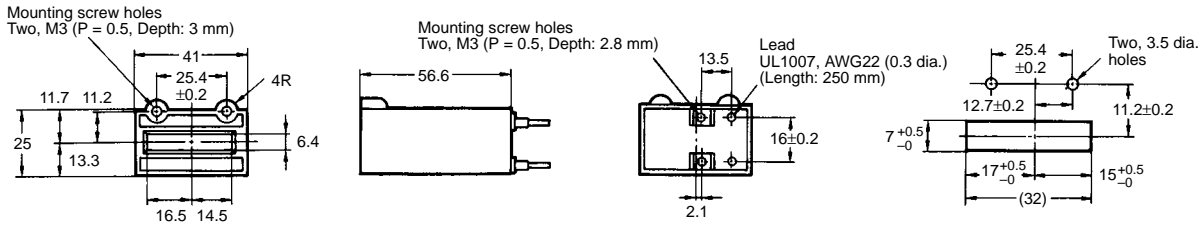

CSKE-6RL CSKE-7RL

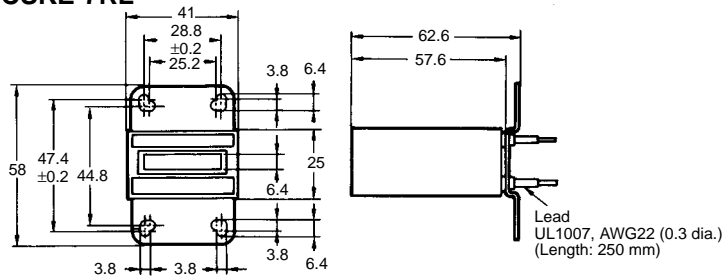

CSKE-6Y CSKE-7Y

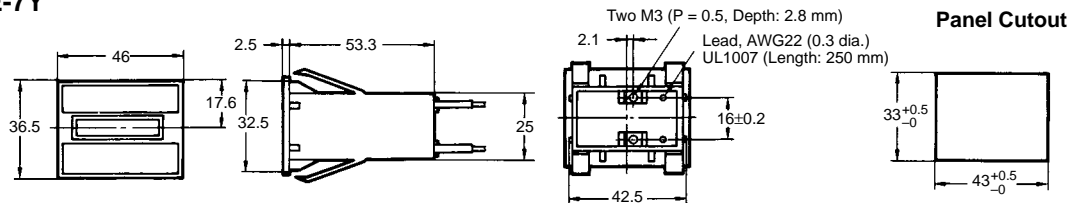

Precautions

Mounting/Connection

Whenever possible, install the Counter at an environment where it is not subject to heavy vibration, dust, and corrosive gases. When mounting the Counter on a panel with screws, do not apply excessive force on the screws when tightening, but be sure to tighten the screws securely. To flush-mount the Counter (a -Y model), insert it into the cutout on the mounting panel, until its class catch securely.

Use lead wires approximately 250 mm long. Do not stretch the leads with excessive force. Insulate the leads with insulation tape, etc.

When mounting the Counter using its screw holes, use screws that fit the holes properly. Also when determining the length of the screws, take the thickness of the mounting panel into consideration.

Supply Voltage

The Counter operates on a voltage 85% to 110% of the rated supply voltage. If the supply voltage exceeds or drops below this range, the Counter may malfunction. The DC models can operate with a ripple factor of 48% or less; so, they can be driven by a single-phase, full-wave rectified power source, whose waveform is shown below.

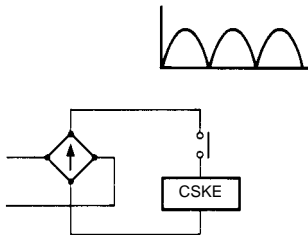

Count Signal

(1) Contact Input

When using a contact input device to input the count signal, carefully select the input device. Use the current capacity and life of the contact of the input device as criteria for the selection. It is recommended to connect a protective circuit across the contacts of the input device, or a surge absorber across the Counter's coil, so that surges are absorbed and the life of the contacts are extended.

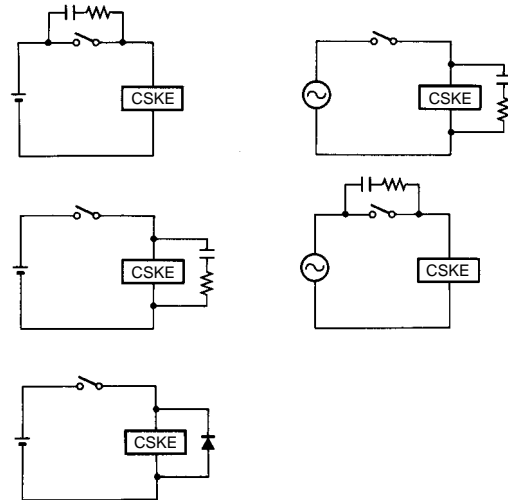

(2) Solid-state Input

When a solid-state input device is used, a surge absorber is necessary to protect the Counter drive transistor from being adversely affected by noises. If a diode is used as the surge absorber, the reset time of the Counter will be prolonged and, as a result, the Counter's response speed will be slowed down. If an RC network is used, the response characteristics of the Counter will be better as compared when a diode is used, but the counterelectromotive force cannot be completely reduced to zero.

Diode

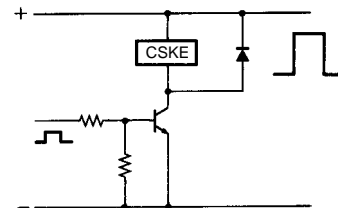

RC network

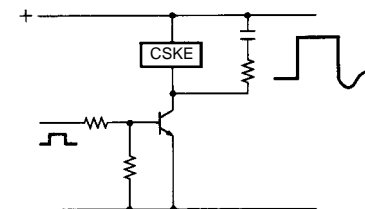

ALL DIMENSIONS SHOWN ARE IN MILLIMETERS.

To convert millimeters into inches, multiply by 0.03937. To convert grams into ounces, multiply by 0.03527.

Cat. No. M024-E1-1B In the interest of product improvement, specifications are subject to change without notice.

OMRON Corporation

Industrial Automation Company

Measuring and Supervisory Controls Division
28th Fl., Crystal Tower Bldg.,
1-2-27, Shiromi, Chuo-ku,
Osaka 540-6028 Japan
Phone: (81)6-6949-6035 Fax: (81)6-6949-6069

Printed in Japan
0499-0.5C (0499)