

OMRON

Fixed Mount Multi Code Reader

FQ-CR1□□□□□-M

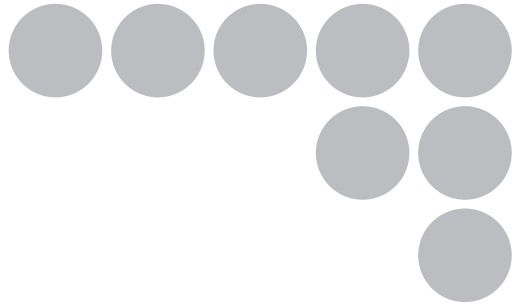

User's Manual



Cat. No. Z329-E1-02

Introduction

Thank you for purchasing the FQ-CR1.

This manual provides information regarding functions, performance and operating methods that are required for using the FQ-CR1.

When using the FQ-CR1, be sure to observe the following:

- The FQ-CR1 must be operated by personnel knowledgeable in electrical engineering.
- To ensure correct use, please read this manual thoroughly to deepen your understanding of the product.
- Please keep this manual in a safe place so that it can be referred to whenever necessary.

User's Manual

APPLICATION CONSIDERATIONS
(Please Read)

Introduction

1

Installation and Connections

2

Taking Images

3

Setting Up Inspections

4

Testing and Saving Settings

5

Operation

6

Convenient Functions

7

Communications with External Devices

8

Troubleshooting

9

Appendices

10

READ AND UNDERSTAND THIS DOCUMENT

Please read and understand this document before using the products. Please consult your OMRON representative if you have any questions or comments.

WARRANTY

OMRON's exclusive warranty is that the products are free from defects in materials and workmanship for a period of one year (or other period if specified) from date of sale by OMRON.

OMRON MAKES NO WARRANTY OR REPRESENTATION, EXPRESS OR IMPLIED, REGARDING NON-INFRINGEMENT, MERCHANTABILITY, OR FITNESS FOR PARTICULAR PURPOSE OF THE PRODUCTS. ANY BUYER OR USER ACKNOWLEDGES THAT THE BUYER OR USER ALONE HAS DETERMINED THAT THE PRODUCTS WILL SUITABLY MEET THE REQUIREMENTS OF THEIR INTENDED USE. OMRON DISCLAIMS ALL OTHER WARRANTIES, EXPRESS OR IMPLIED.

LIMITATIONS OF LIABILITY

OMRON SHALL NOT BE RESPONSIBLE FOR SPECIAL, INDIRECT, OR CONSEQUENTIAL DAMAGES, LOSS OF PROFITS OR COMMERCIAL LOSS IN ANY WAY CONNECTED WITH THE PRODUCTS, WHETHER SUCH CLAIM IS BASED ON CONTRACT, WARRANTY, NEGLIGENCE, OR STRICT LIABILITY.

In no event shall responsibility of OMRON for any act exceed the individual price of the product on which liability is asserted.

IN NO EVENT SHALL OMRON BE RESPONSIBLE FOR WARRANTY, REPAIR, OR OTHER CLAIMS REGARDING THE PRODUCTS UNLESS OMRON'S ANALYSIS CONFIRMS THAT THE PRODUCTS WERE PROPERLY HANDLED, STORED, INSTALLED, AND MAINTAINED AND NOT SUBJECT TO CONTAMINATION, ABUSE, MISUSE, OR INAPPROPRIATE MODIFICATION OR REPAIR.

SUITABILITY FOR USE

THE PRODUCTS CONTAINED IN THIS DOCUMENT ARE NOT SAFETY RATED. THEY ARE NOT DESIGNED OR RATED FOR ENSURING SAFETY OF PERSONS, AND SHOULD NOT BE RELIED UPON AS A SAFETY COMPONENT OR PROTECTIVE DEVICE FOR SUCH PURPOSES.

Please refer to separate catalogs for OMRON's safety rated products.

OMRON shall not be responsible for conformity with any standards, codes, or regulations that apply to the combination of products in the customer's application or use of the product.

At the customer's request, OMRON will provide applicable third party certification documents identifying ratings and limitations of use that apply to the products. This information by itself is not sufficient for a complete determination of the suitability of the products in combination with the end product, machine, system, or other application or use.

The following are some examples of applications for which particular attention must be given. This is not intended to be an exhaustive list of all possible uses of the products, nor is it intended to imply that the uses listed may be suitable for the products:

- Outdoor use, uses involving potential chemical contamination or electrical interference, or conditions or uses not described in this document.

- Nuclear energy control systems, combustion systems, railroad systems, aviation systems, medical equipment, amusement machines, vehicles, safety equipment, and installations subject to separate industry or government regulations.
- Systems, machines, and equipment that could present a risk to life or property.

Please know and observe all prohibitions of use applicable to the products.

NEVER USE THE PRODUCTS FOR AN APPLICATION INVOLVING SERIOUS RISK TO LIFE OR PROPERTY WITHOUT ENSURING THAT THE SYSTEM AS A WHOLE HAS BEEN DESIGNED TO ADDRESS THE RISKS, AND THAT THE OMRON PRODUCT IS PROPERLY RATED AND INSTALLED FOR THE INTENDED USE WITHIN THE OVERALL EQUIPMENT OR SYSTEM.

PERFORMANCE DATA

Performance data given in this document is provided as a guide for the user in determining suitability and does not constitute a warranty. It may represent the result of OMRON's test conditions, and the users must correlate it to actual application requirements. Actual performance is subject to the OMRON Warranty and Limitations of Liability.

CHANGE IN SPECIFICATIONS

Product specifications and accessories may be changed at any time based on improvements and other reasons.

It is our practice to change model numbers when published ratings or features are changed, or when significant construction changes are made. However, some specifications of the product may be changed without any notice. When in doubt, special model numbers may be assigned to fix or establish key specifications for your application on your request. Please consult with your OMRON representative at any time to confirm actual specifications of purchased products.

DIMENSIONS AND WEIGHTS

Dimensions and weights are nominal and are not to be used for manufacturing purposes, even when tolerances are shown.

ERRORS AND OMISSIONS

The information in this document has been carefully checked and is believed to be accurate; however, no responsibility is assumed for clerical, typographical, or proofreading errors, or omissions.

PROGRAMMABLE PRODUCTS

OMRON shall not be responsible for the user's programming of a programmable product, or any consequence thereof.

COPYRIGHT AND COPY PERMISSION

This document shall not be copied for sales or promotions without permission.

This document is protected by copyright and is intended solely for use in conjunction with the product. Please notify us before copying or reproducing this document in any manner, for any other purpose. If copying or transmitting this document to another, please copy or transmit it in its entirety.

Meanings of Signal Words

The following signal words are used in this manual.



Indicates a potentially hazardous situation which, if not avoided, will result in minor or moderate injury, or may result in serious injury or death. Additionally there may be significant property damage.

Meanings of Alert Symbols

The following alert symbols are used in this manual

	Indicates general prohibitions for which there is no specific symbol.
	Indicates the possibility of laser radiation.
	Indicates the possibility of explosion under specific conditions.
	Indicates prohibition when there is a risk of minor injury from electrical shock or other source if the product is disassembled.



This product is not designed or rated for ensuring safety of persons.
Do not use it for such purposes.



The Sensor emits visible light, which may adversely affect the eyes in rare instances.
Do not look directly into the light emitted from the Sensor. When the subject is a specular reflective object, protect your eyes from reflected light.



A lithium ion battery is built into the Touch Finder and may occasionally combust, explode, or burn if not treated properly.
Dispose of the Touch Finder as industrial waste, and never disassemble, apply pressure that would deform, heat to 100 °C or higher, or incinerate the Touch Finder.



High-voltage parts inside; danger of electrical shock. Do not open the product cover.



Precautions for Safe Use

The following points are important to ensure safety, so make sure that they are strictly observed.

1. Installation Environment

- Do not use the product in environments where it can be exposed to inflammable/explosive gas.
- To secure the safety of operation and maintenance, do not install the product close to high-voltage devices and power devices.
- Install the product in such a way that its ventilation holes are not blocked.
- Tighten mounting screws at the torque specified in this manual.

2. Power Supply and Wiring

- The power supply voltage must be within the rated range (24 VDC \pm 10%), and an AC voltage must not be used.
- Reverse connection of the power supply is not allowed. Do not short the load of the open collector output.
- The load must be within the rated range.
- High-voltage lines and power lines must be wired separately from this product. Wiring them together or placing them in the same duct may cause induction, resulting in malfunction or damage.
- Use the products within the power supply voltages specified in this manual.
- Use the specified size of crimp terminals to wire connections. Do not connect wires that have been simply twisted together directly to the power supply or terminal block.
- Use a DC power supply with safety measures against high voltages (safety extra low-voltage circuit).
- Use independent power sources for the products. Do not use a shared power source.
- Tighten mounting screws at the torque specified in this manual.
- Always turn OFF the power supply before connecting or disconnecting cables or the power supply wiring.

3. Battery

- Do not short the positive and negative terminals of the Battery.
- Do not use the Touch Finder in an environment that exceeds the operating temperature range of the Battery. If the Touch Finder is used at temperatures that exceed the operating temperature range, the protective device may activate and prevent charging.
- Do not connect the Battery directly to a power supply or car cigarette lighter socket.
- Do not use the Touch Finder with any other type of battery.
- Turn OFF the power supply immediately if the Battery leaks or produces an odor. Electrolyte leaked from the Battery may ignite, possibly causing smoke, rupture, or fire.
- If during usage, charging, or storage, the Battery produces an odor, heats, becomes discolored, becomes misshapen, or exhibits any other unusual conditions, remove it and do not use it. Continuing to use such a Battery may result in the Battery heating, smoking, rupturing, or igniting.
- If the Touch Finder (FQ□-D31) will be installed permanently or semi-permanently, remove the Battery (FQ-BAT1). If the rated temperature is exceeded with the Battery inserted, the protective circuit may activate and stop the Touch Finder.

4. AC Adapter

- Use an AC cable that is suitable for the power supply and power voltage you are using.
- Do not touch the power plug with a wet hand. Doing so may result in electrical shock.
- If you notice an abnormal condition, such as smoke, abnormal heating of the outer surface, or a strange odor, immediately stop using the AC Adapter, turn OFF the power, and remove the power plug from the outlet.
Consult your dealer, as it is dangerous to attempt to repair the AC Adapter yourself.
- If the AC Adapter is dropped or damaged, turn OFF the power, remove the power plug from the outlet, and contact your dealer. There is a risk of fire if you continue using the AC Adapter.

5. Handling

- Connector Cover

Always attach the connector cover when you disconnect the cable. If you do not attach the connector cover, foreign matter may enter the connection, causing malfunctions or damage.

- Lens Cap

Always attach a C-mount lens cap to the lens mount when you remove the lens. If dust or dirt adhere to the imaging elements, false detection or failure may occur.

- Sensor Waterproof Sheets

Do not remove or damage the waterproof sheets on the sides of the Sensor. Doing so may allow dust, dirt, or water drops to enter the Sensor and damage it.

6. EMC Standard

- EN61326-1

- Electromagnetic environment : Industrial electromagnetic environment (EN/IEC 61326-1 Table 2)

- The following condition is applied to the immunity test of this product

: If the level of disturbance of the video is such that characters on the monitor are readable, the test is a pass.

7. Other

- Do not use this product in safety circuits associated with nuclear power and human life.

- Do not disassemble, repair, modify, deform by pressure, or incinerate this product.

- Dispose of this product as industrial waste.

- Connect the special products (Sensor, Touch Finder, Cables). The product might break down or malfunction if you use a part not included in the special products.

- If you notice an abnormal condition, such as a strange odor, extreme heating of any product, or smoke, immediately stop using the product, turn OFF the power, and consult your dealer.

- The Sensor surfaces become hot during use. Do not touch them.

- Do not drop or subject the products to shock.

- Use the special Sensor (FQ-CR1), Touch Finder (FQ□-D), Cables (FQ-WN and FQ-WD), Battery (FQ-BAT1), and AC Adapter (FQ-AC). Using other than the specified products may cause fire, burning, malfunction or failure.

- If the product has a lock mechanism, always make sure it is locked before using the product.

Precautions for Correct Use

Observe the following precautions to prevent failure to operate, malfunctions, or undesirable effects on product performance.

1. Installation Site

Do not install this product in locations subjected to the following conditions:

- Ambient temperature outside the rating
- Rapid temperature fluctuations (causing condensation)
- Relative humidity outside the range of 35 to 85%
- Direct vibration or shock
- Strong ambient light (such as other laser beams, light from arc-welding machines, or ultraviolet light)
- Direct sunlight or near heaters
- Strong magnetic or electric field

Also, do not install this product in locations subjected to the following conditions to ensure its protective performance as described in the specifications:

- Presence of corrosive or flammable gases
- Presence of dust, salt, or iron particles
- Water, oil, or chemical fumes or spray, or mist atmospheres

Installing and Using a Sensor

- The front-panel plate may occasionally become fogged from the inside if the Sensor is used in location with high humidity and the temperature changes drastically.
- Do not install any objects except for the special mounting brackets within the dotted lines in the following figure. The front-panel plate may become fogged from the inside.

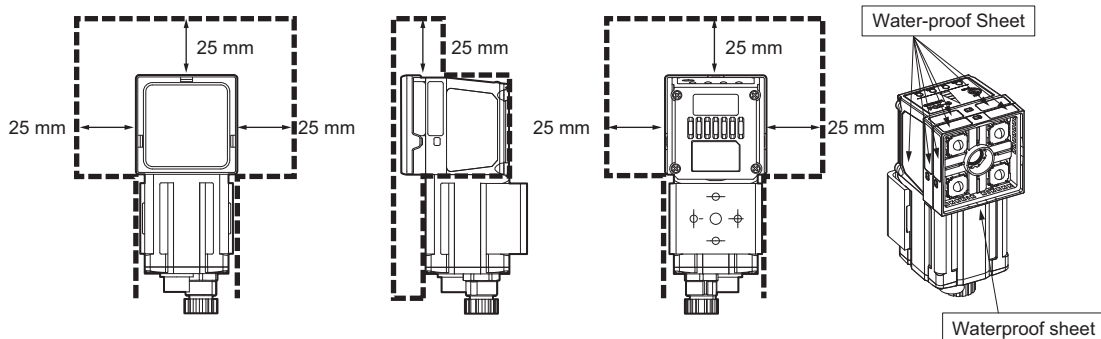

2. Power Supply, Connection, and Wiring

- When using a commercially available switching regulator, make sure that the FG terminal is grounded.
- If surge currents are present in the power lines, connect surge absorbers that suit the operating environment.
- Before turning ON the power after the product is connected, make sure that the power supply voltage is correct, there are no incorrect connections (e.g. load short-circuit) and the load current is appropriate. Incorrect wiring may result in breakdown of the product.
- For cables, use only the special products specified in this manual.

 p.191, p.192

- Use only combinations of the Sensor and Touch Finder specified in this manual. Using other combinations may cause malfunction or damage.
- Do not turn the power OFF in the following instances. Doing so will damage data that is in the process of being saved.
 - While data is being saved in internal memory
 - While data is being saved on the SD card
- The LCD panel has been made using precision technology, and sometimes a few pixels are missing in the panel. This is due to the structure of the LCD panel, and is not a malfunction.

- **Imaging Elements**

Due to the specifications of the CMOS image sensors that are used in the Vision Sensor, lines may appear in images for some measurement conditions or gain settings. These do not indicate defects or faults in the Vision Sensor. Also, there may be some pixel defects, but these do not indicate defects or faults in the Vision Sensor.

3. Battery

- Do not use or charge the Battery with other than the specified products.
- Do not charge the Battery with other than the specified AC adapter.
- When using the Touch Finder, the battery cover screw must be tightened.

4. AC Adapter

- During maintenance and when not using the Touch Finder for an extended time, remove the power plug from the outlet.
- Do not bend the power cable past its natural bending radius.
- Do not use the AC Adapter with other than the specified products.
- If a voltage higher than 380 V is applied, there is a risk that the capacitor will be damaged, the pressure valve will open, and vaporized gas will be emitted. If there is a possibility that a voltage higher than 380 V will be applied, use a protective device.

5. Maintenance and Inspection

Do not use thinner, benzene, acetone or kerosene to clean the Sensor and Touch Finder. If large dust particles adhere to the Camera, use a blower brush (used to clean camera lenses) to blow them off. Do not use breath from your mouth to blow the dust off. To remove dust particles from the Camera, wipe gently with a soft cloth (for cleaning lenses) moistened with a small amount of alcohol. Do not use excessive force to wipe off dust particles. Scratches to the Camera might cause error.

Editor's Note

■ Meaning of Symbols

Menu items that are displayed on the Touch Finder LCD screen, and windows, dialog boxes and other GUI elements displayed on the PC are indicated enclosed by brackets "[]".

■ Visual Aids

Important

Indicates points that are important to achieve the full product performance, such as operational precautions.

Note

Indicates application procedures.



Indicates pages where related information can be found.

Table of Contents

1. Introduction

1-1 FQ-CR1 Fixed Mount Multi Code Readers	12
1-2 Measurement Process	13
1-3 Startup Display and Display Elements	14
1-4 Basic Operational Flow.....	16

2. Installation and Connections

2-1 System Configuration	18
2-2 Part Names and Functions.....	19
2-3 Installation	21
2-4 Wiring	27
2-5 Setting Up Ethernet.....	32

3. Taking Images

3-1 Selecting a Sensor for Configuration	36
3-2 Adjusting Image Quality	37
3-3 Adjusting the Object Position	42
3-4 Preventing Mutual Interference of Multiple Sensors	46

4. Setting Up Inspections

4-1 Inspection Item Selection Guide	48
4-2 Setup Procedure for Inspection Items	49
4-3 Configuring Inspection Items.....	50
4-4 Reading Bar Codes.....	52
4-5 Reading 2D-codes.....	58
4-6 Calculations and Judgements Using Inspection Item Data	64

5. Testing and Saving Settings

5-1 Performing Test Measurements.....	74
5-2 Shortening the Measurement Takt Time.....	76
5-3 Adjusting the Judgement Parameters.....	77
5-4 Checking a List of All Inspection Item Results	78

5-5 Saving Data to the Sensor	79
-------------------------------------	----

6. Operation

6-1 Starting Operation.....	82
6-2 Configuring the Run Mode Display	84
6-3 Checking the Trend of Measurement Results with Graphs	86
6-4 Adjusting Judgement Parameters during Operation.....	89

7. Convenient Functions

7-1 Changing the Scene to Change the Line Process	92
7-2 Display Functions	94
7-3 Monitoring the Signal I/O Status	97
7-4 Connecting to More Than One Sensor	98
7-5 Logging Measurement Data and Image Data	102
7-6 Saving Sensor Settings	109
7-7 SD Card Operations	110
7-8 Convenient Functions for Operation.....	112
7-9 Convenient Functions for Setup	114
7-10 Functions Related to the System.....	115

8. Communications with External Devices

8-1 Controlling/Outputting in Parallel	118
8-2 Outputting/Controlling with Ethernet	135

9. Troubleshooting

9-1 Error Table.....	162
9-2 Basic Troubleshooting	164

10. Appendices

10-1 Menu Tables.....	166
10-2 External Reference Parameters	178
10-3 Specifications and Dimensions	182
10-4 Updating the Software	193
Index.....	195
Revision History	198

Introduction

1-1 FQ-CR1 Fixed Mount Multi Code Readers	12
1-2 Measurement Process	13
1-3 Startup Display and Display Elements	14
1-4 Basic Operational Flow	16

1-1 FQ-CR1 Fixed Mount Multi Code Readers

The FQ-CR1 is a Fixed Mount Multi Code Reader created by adding bar code and 2D-code inspection functions to the integrated processing FQ-series Sensor. Once configured, they are used stand-alone for quality inspection of presence, position, and other product characteristics. To set up or monitor the sensors, either the touch screen based console 'Touch Finder' or a 'PC Tool' can be used.

FQ-CR1 Sensor

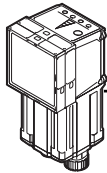

Includes the camera, lighting, measurement processor, and I/O functions. After the Sensor has been set up, it can be operated alone to perform measurements without the Touch Finder or PC Tool.

Setup, Image Confirmation, and Logging Tools

Touch Finder



Used to check images and set the judgement parameters. It can also be used to save measurement results and check status during operation.

PC Tool



The same functions as those that are provided by the Touch Finder can be performed from a computer. The PC Tool is available free of charge.

1-2 Measurement Process

This section describes the basic flow of the measurement process.

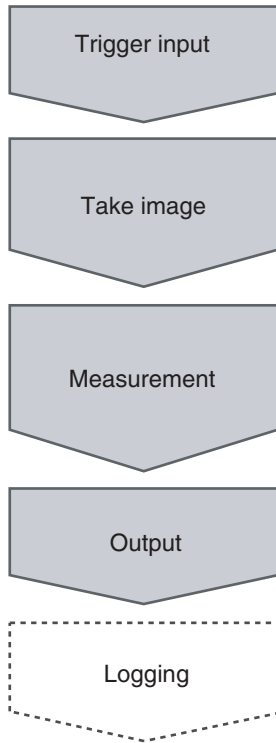

- The measurement is started by inputting a trigger signal from an external device.
- Images are taken according to the trigger.
- The image is measured to see if it matches the configured settings.
- You can also perform calculations based on the measurement results from inspection items.
- The overall judgement of all inspection items are output using OR logic.
- You can output detailed measurement results from the inspection items. (An Ethernet connection is required.)
- Measurement data and image data can be logged in memory in the Sensor or in an SD card.

1-3 Startup Display and Display Elements

Startup Display

1 The Sensor is automatically detected by the Touch Finder when power supply to the Sensor and Touch Finder is turned ON.

The Auto Connect Display will appear if the Sensor cannot be detected. Check that cables are connected correctly to the Sensor and Touch Finder, and then press [Auto connect].



Note

If the Sensor is still not detected after pressing [Auto Connect], refer to the following information.

 The Sensor cannot be detected: p. 164

2 When the Sensor is detected, the following display will appear.

- The Setup Mode will appear if a Sensor that has not been set up is connected.
- The Run Mode will appear if a Sensor that has been set up is connected.

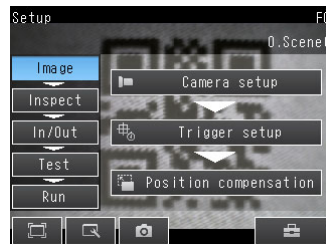

Note

When the Touch Finder is started, IP addresses are automatically set for each Sensor. To allocate specific IP addresses, set the IP address of each Sensor and the Touch Finder.

 Setting Up Ethernet: p. 32

Display Elements

This Sensor has a Setup Mode and a Run Mode.
Refer to the following information for menu items.

 p. 166

Setup Mode

In Setup Mode, you can set the image conditions, judgement parameters, and I/O settings for the Sensor.

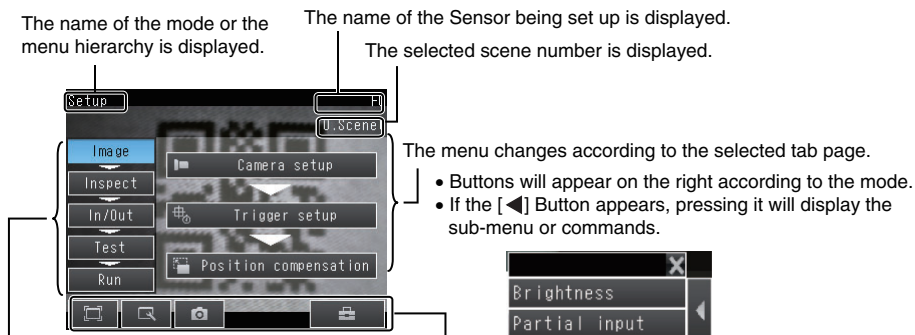

The name of the mode or the menu hierarchy is displayed.

The name of the Sensor being set up is displayed.

The selected scene number is displayed.







The menu changes according to the selected tab page.

- Buttons will appear on the right according to the mode.
- If the [Left Arrow] Button appears, pressing it will display the sub-menu or commands.

The setup flow is shown by these five tabs.

[Image]: Used to adjust the image.
[Inspect]: Used to set the inspection items.
[In/Out]: Used to set the I/O.
[Test]: Used to test and adjust the set measurements.
[Run]: Used to switch to Run Mode.

This button menu is always displayed.

-  Only-image Button: Used to select either displaying the camera image and messages, or only the camera image.
-  Display Button: Used to select the source of the image or to zoom the image.
 Display Functions: p. 94
-  Capture Button: Used to capture the current screen to the SD card.
 p. 113
-  Tool Button: Used to call functions, such as saving data or select scenes.

Note

The Display Button can be used to switch between the following images.

- Live: The live image is displayed.
- Freeze: The image that was taken last is displayed.
- Log: An image saved in internal memory is displayed.
- Logging image file: An image saved on an SD card is displayed.

Run Mode

In Run Mode, measurements are performed, and measurement results are output.

 p. 81

1-4 Basic Operational Flow

The following flow shows the basic operation of FQ-CR1 Sensors.

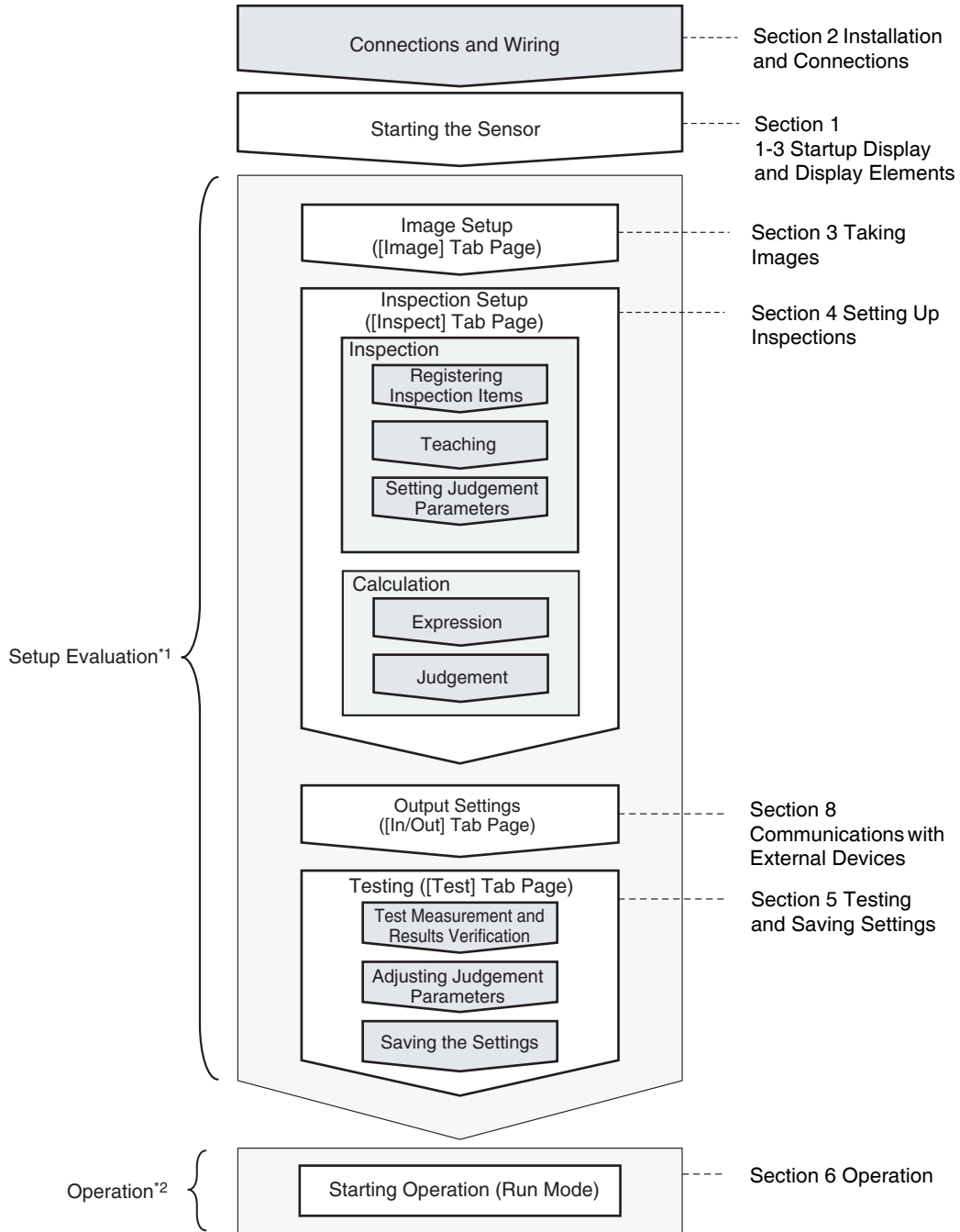

*1: In Setup Mode, the Sensor can be set up and adjusted, but it does not output signals on the I/O lines.

*2: In Run Mode, the Sensor performs measurements and outputs signals on the I/O lines.

Installation and Connections

2-1 System Configuration	18
2-2 Part Names and Functions	19
2-3 Installation	21
2-4 Wiring	27
2-5 Setting Up Ethernet	32

2-1 System Configuration

Parallel Interface Connection

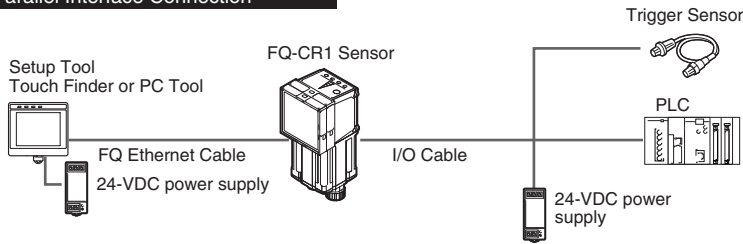

Connecting to Ethernet

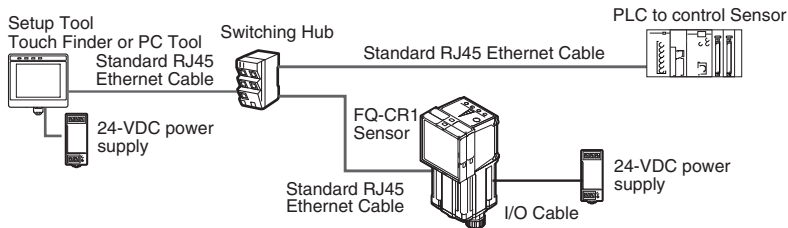

Multiple Connection Sensors

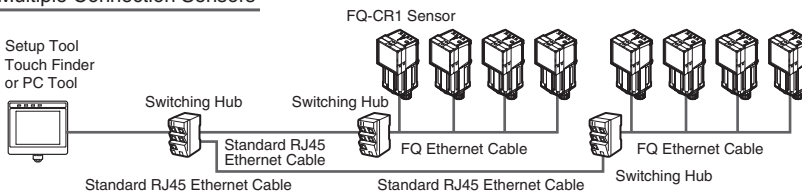

Product	Model number	Remarks
FQ-CR1 Sensor	FQ-CR1□□□□□-M	This is the Sensor.
Touch Finder	FQ□-D□□	This is a setup console. (Software version must be 1.6 or higher)
PC Tool	---	The PC Tool can be used instead of the Touch Finder. (Software version must be 1.6 or higher) If you register as a member, you can download the free PC Tool as a special service to purchasers. Refer to the <i>Member Registration Sheet</i> that is enclosed with the Sensor for the member registration procedure and the download procedure for special member software.
FQ Ethernet Cable	FQ-WN0□□	Connects the Sensors to external devices such as the Touch Finder, computers, and PLCs.
Standard RJ45 Ethernet Cable ^{*1}	---	Connects the Switching Hub to the Touch Finder, computers, and PLCs. Use a connector that complies with the FCC RJ45 standard. (STP (shielded twisted-pair) cable, category 5e or 6, impedance: 100 Ω)
I/O Cable	FQ-WD0□□	Connects the Sensor to the power supply and external devices.
Switching Hub	W4S1-0□□	Used to connect multiple Sensors to one Touch Finder or PC Tool.

*1: The shape and dimensions of the Ethernet connector plug and jack are specified in ISO/IEC8877:1992 (JIS X 5110:1996) and RJ-45 of the FCC regulations. To prevent connector connection failures, the structure of the jack of this product does not allow insertion of plugs that do not comply with the standard. If a commercially available plug cannot be inserted, it is likely that the plug is non-compliant.

Important

Do not connect network devices other than PLCs on the same network as the Touch Finder or computer. If another device is connected, the responsiveness of displays and settings of the Touch Finder or computer may become slow.

2-2 Part Names and Functions

FQ-CR1 Sensor

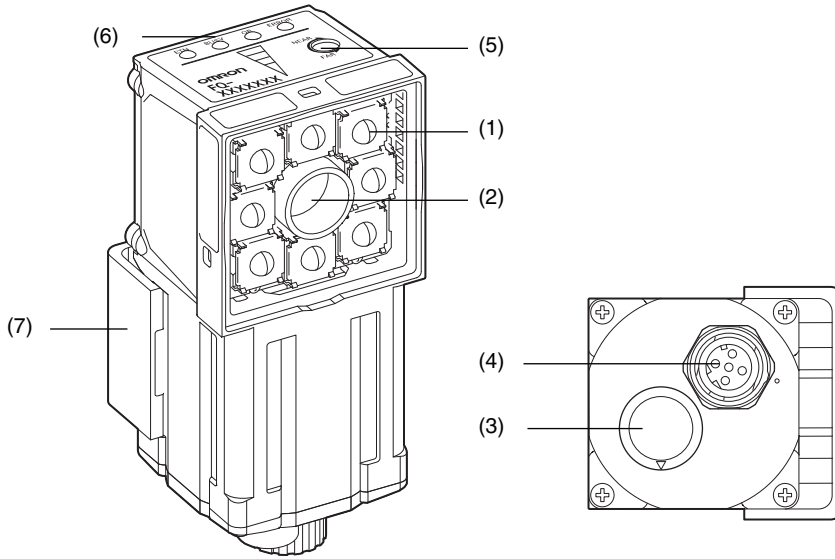

No.	Name	Description	
(1)	Lighting	LEDs for illumination	
(2)	Camera lens	This lens can be focused.	
(3)	I/O Cable connector	An I/O Cable is used to connect the Sensor to the power supply and external I/O.	
(4)	Ethernet cable connector	An Ethernet cable is used to connect the Sensor to external devices such as PLCs, the Touch Finder, or computers.	
(5)	Focus adjustment screw	Used to adjust the focus of the image.	
(6)	Operation indicators	OR	Lights orange when the OR output signal turns ON.
		ETN	Lights orange during Ethernet communications.
		ERROR	Lights red when an error occurs.  9-1 Error Table p. 162.
		BUSY	Lights green when the Sensor is executing a process.
(7)	Mounting Bracket	Used to mount the Sensor. The Mounting Bracket can be attached to the front, left side, right side, or back of the Sensor.	

Touch Finder

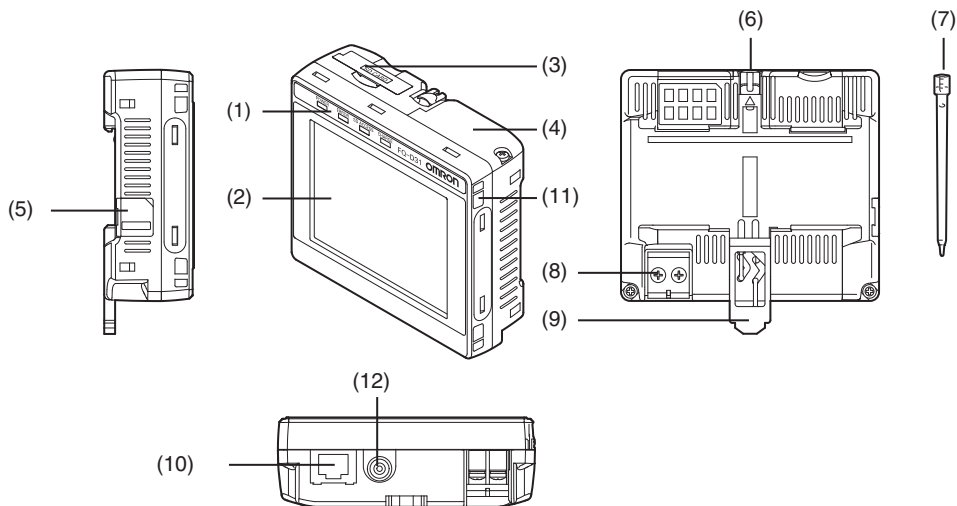

No.	Name	Description
(1)	Operation indicators	POWER Lights green when the Touch Finder is turned ON.
		ERROR Lights red when an error occurs. 9-1 Error Table p. 162.
		SD ACCESS Lights yellow when an SD card is inserted. Flashes yellow when the SD card is being accessed.
		CHARGE* ¹ Lights orange when the Battery is charging.
(2)	LCD/touch panel	Displays the setting menu, measurement results, and images input by the camera.
(3)	SD card slot	An SD card can be inserted.
(4)	Battery cover* ¹	The Battery is inserted behind this cover. Remove the cover when mounting or removing the Battery.
(5)	Power supply switch	Used to turn the Touch Finder ON and OFF.
(6)	Touch pen holder	The touch pen can be stored here when it is not being used.
(7)	Touch pen	Used to operate the touch panel.
(8)	DC power supply connector	Used to connect a DC power supply. p. 29
(9)	Slider	Used to mount the Touch Finder to a DIN Track.
(10)	Ethernet port	Used when connecting the Touch Finder to the Sensor with an Ethernet cable. Insert the connector until it locks in place.
(11)	Strap holder	This is a holder for attaching the strap.
(12)	AC power supply connector* ¹	Used to connect the AC adapter.

*1: Applicable to the FQ-D31 only.

2-3 Installation

Installing the Sensor

Installation Procedure

- 1** Align the tabs on one side of the Mounting Bracket with the slot on the Sensor.
The FQ-XL Mounting Bracket can be attached to the back, side, or front of the Sensor.
- 2** Press the Mounting Bracket onto the Sensor until the other tabs click into place.
- 3** Use the following optical charts to check the field of view and installation distance of the Sensor so that it is mounted at the correct position.
Tightening torque (M4): 1.2 N·m

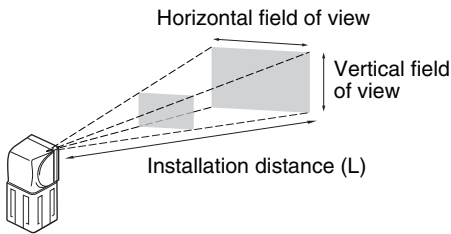
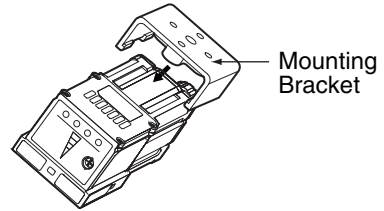

The optical chart indicates the horizontal field of view. The vertical field of view will be approximately 60% of the horizontal field of view.

Note: The tolerance is $\pm 10\%$.

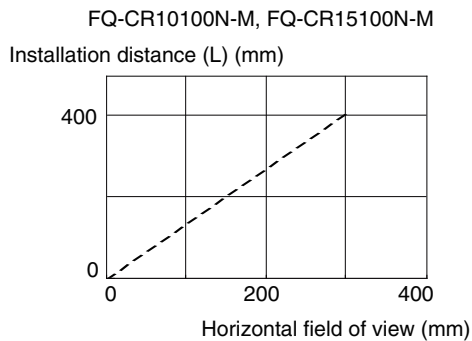
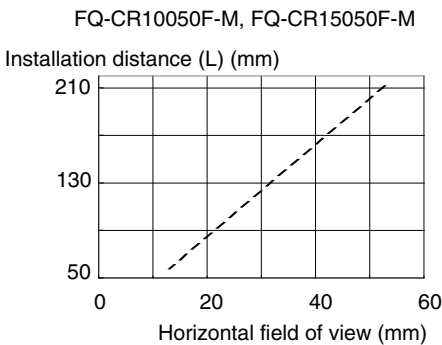
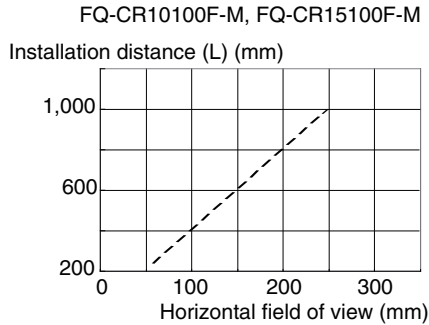
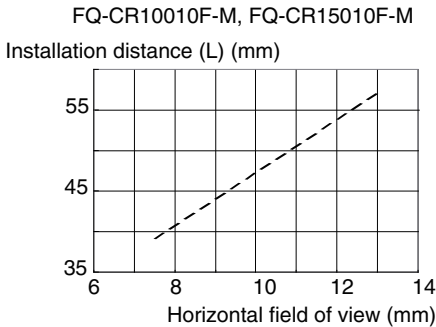

Important

- There is a certain amount of deviation among Sensors in the center of the optical axis. For this reason, when installing the Sensor, check the center of the image and the field of view on the LCD monitor of the Touch Finder and in the PC Tool.

Installing and Using a Sensor

The front-panel plate may occasionally become fogged from the inside if the Sensor is used in location with high humidity and the temperature changes drastically.

Do not install any objects except for the special mounting brackets within the dotted lines in the following figure. The front-panel plate may become fogged from the inside.

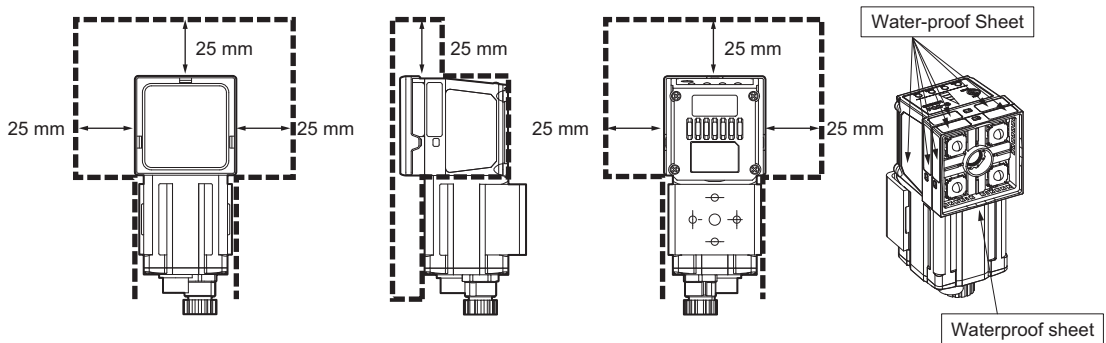

Removal Procedure

- 1** Insert a flat-blade screwdriver between the Mounting Bracket and the Sensor case on either side and remove the Mounting Bracket.

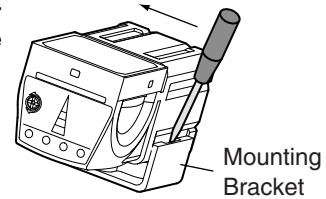

Installing the Touch Finder

Installation Precautions

Install the Touch Finder in the following orientation to allow sufficient heat dissipation.

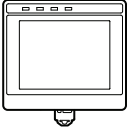

Do not mount it in the following orientations.

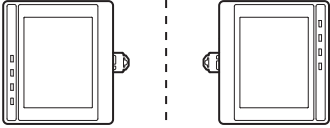

Important

- To improve ventilation, leave space on both sides of the Touch Finder. The distance between the Touch Finder and other devices should be at least that shown in the following diagram.

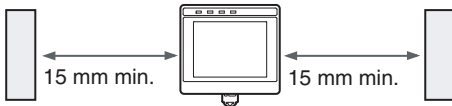

- Make sure that the ambient temperature is 50°C or lower. If it exceeds 50°C, install a cooling fan or an air conditioner and maintain the temperature at 50°C or lower.
- To prevent interference by noise, do not mount the Sensor on panels which contain high-voltage devices.
- To keep the level of noise from the surrounding environment to a minimum, install the Sensor and Touch Finder at least 10 m away from power lines.

Mounting to DIN Track

Installation Procedure

- 1** Press the slider on the Touch Finder to the top.
- 2** Hook the clip at the top of the Touch Finder on to the DIN Track.
- 3** Press the Touch Finder onto the DIN Track until the bottom clip clicks into place.

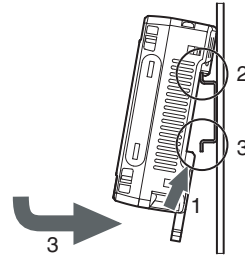

Important

- Attach End Plates (sold separately) on the sides of the Touch Finder on the DIN Track.
- If other devices will be installed next to the Touch Finder on the same DIN Track, make sure that sufficient space is kept between the devices as indicated on previous page.
- Always hook the clip at the top of the Touch Finder on the DIN Track first. If the lower clip is hooked on first, the Touch Finder will not be mounted very securely.

Removal Procedure

- 1** Pull down on the slider on the Touch Finder.
- 2** Lift the Touch Finder at the bottom and remove it from the DIN Track.

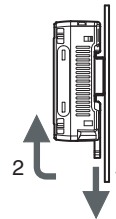

Mounting to a Control Panel

The Touch Finder can be mounted on a panel using the FQ-XPM Panel Mounting Adapter.

Important

- Always turn OFF the Touch Finder power before attaching or detaching the Panel Mount Adapter. Attaching or detaching with the power turned ON may cause a failure.

- 1** Set the Touch Finder in the Panel Mount Adapter.

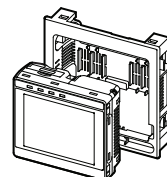

2 Press the slider up on the Touch Finder.

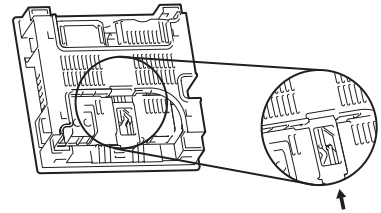

3 Create holes in the panel for mounting.
Refer to the following page for hole dimensions.

 p. 189

4 Connect the cable to the Touch Finder.

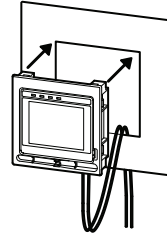

5 Mount the Touch Finder with the Panel Mount Adapter from the front of the panel.

6 Hook the hooks on the Mounting Bracket in the four holes of the Panel Mount Adapter and secure them with screws. (Tightening torque: 1.2 N·m)

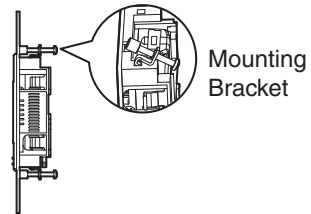

7 Check that the Touch Finder is attached properly to the Panel.

Using the Touch Finder as a Portable Device (with Battery)

The Touch Finder with a Battery can be used as a portable device. Use the strap when carrying it to prevent dropping it.

There are two types of straps (FQ-XH, sold separately), a Neck Strap and a Hand Strap.

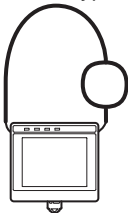

Neck Strap

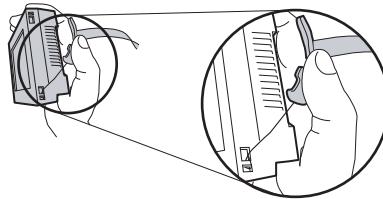

Hand Strap

1 Attach the Mini-strap to the Touch Finder.

There are a total of four holes for attaching the Mini-strap on the left and on the right of the Touch Finder.

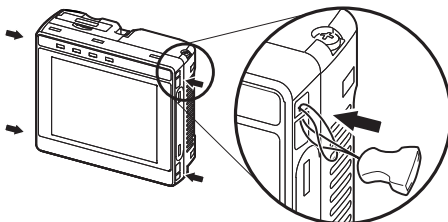

2 Connect the Neck Strap or Hand Strap to the Mini-strap.

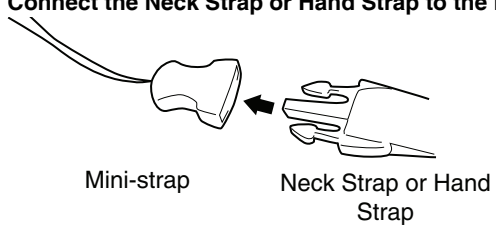

2-4 Wiring

Wiring the Sensor

Connect the I/O Cable to the I/O Cable connector located at the bottom of the Sensor.

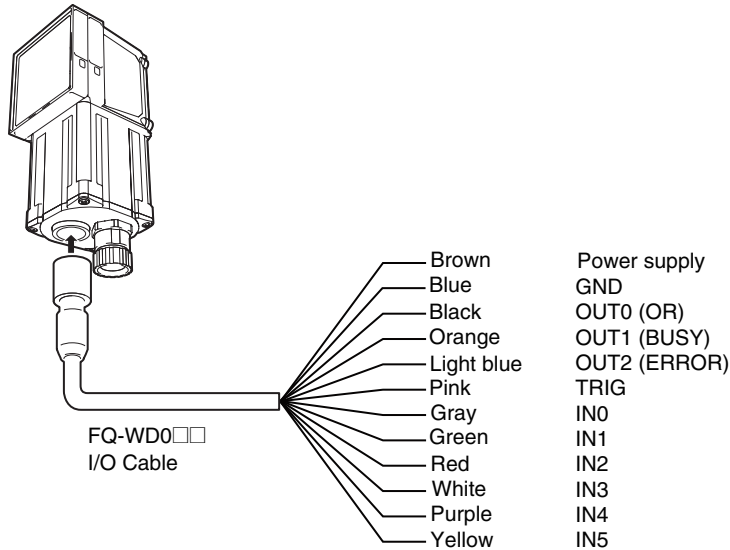

Important

Cut off lines that are not required so that they do not come into contact the other signal lines.

Classification	Signal	Application
Power supply	Power supply (24 V)	These terminals are for the external power supply (24 V).
	GND	Important Wire the power supply separately from other devices. If the wiring for other devices is placed together or in the same duct as the wiring for the Sensor, the influences of electromagnetic induction may cause the Sensor to malfunction or may damage it.
Inputs	TRIG	This terminal is the trigger signal input.
	IN0 to IN5	These are the command input terminals.
Outputs	OUT0 (OR)	By default, this is the OR output signal (overall judgement). The assignment can be changed to an individual judgement signal from OR0 to OR31.
	OUT1 (BUSY)	By default, this is the BUSY output signal. The assignment can be changed to an individual judgement signal from OR0 to OR31.
	OUT2 (ERROR)	By default, this is the ERROR output signal. The assignment can be changed to an individual judgement signal from OR0 to OR31.

Note

The assignments of I/O signals can be changed.



Section 8 Communications with External Devices: p. 117

I/O Signal Circuit Diagrams

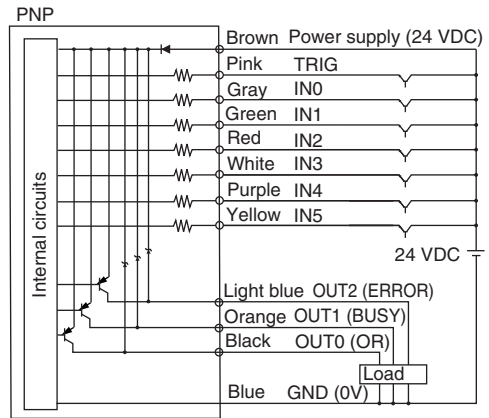
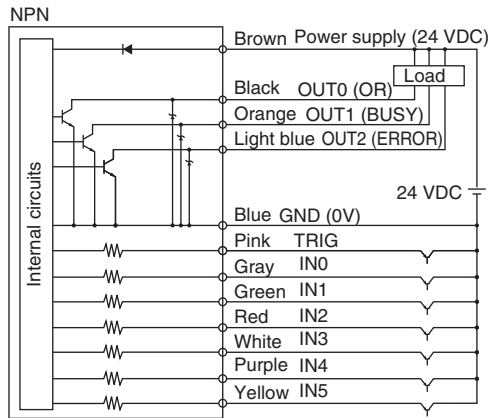

Important

Preventing Chattering

- The Sensor is equipped with an anti-chattering function, but if the chattering is 100 μ s or longer, a faulty input may occur. (Input signals of 99 μ s or shorter are ignored. Signals of 100 μ s or longer are treated as input signals.)
- Use no-contact output devices (e.g., SSR or PLC transistor output) for the input signals. If contacts (e.g., relay) are used, chattering may cause the trigger to be input again during execution of a measurement.

Power Supply Specifications When a Switching Regulator Is Connected

Use a power supply that meets the following specifications. (The power supply is sold separately.)

Item	Description	
		FQ-CR1□010F-M FQ-CR1□050F-M
Recommended Power Supply	S8VS-03024□ (DC24V 1.25A)	S8VS-06024□ (DC24V 2.5A)
External power supply terminal screws	M4 (tightening torque: 1.2 N·m)	

Important

Supply power from a DC power supply for which measures have been applied to prevent high voltages (e.g., a safety extra low voltage circuit).

If UL certification is required for the overall system, use a UL Class II DC power supply.

Attaching the LED Warning Label

Attach the enclosed LED warning label to the cable or other location. The LED warning label must be attached to a location that is readily visible from the Sensor.

Attachment Example

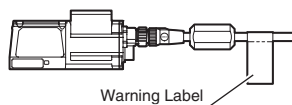

Warning Label

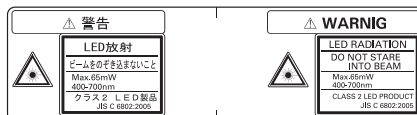

Wiring the Touch Finder

Power Supply Wiring

Connecting the Power Supply

- 1** Loosen the two terminal screws using a Phillips screwdriver.
- 2** Attach crimp terminals to the power lines. Secure the positive and negative lines as indicated using M3 screws.
Power supply tightening torque: 0.54 N·m
- 3** In environments where there is excessive noise, attach a ferrite core (ZCAT1730-0730 from TDK or the equivalent) to the power supply cable.

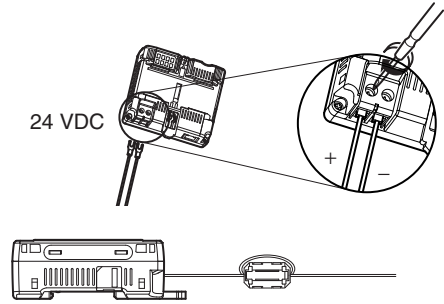

When you attach the ferrite core to the power supply cable, wrap the cable only one time.

Turning ON the Touch Finder

- 1** Remove the cover from the power switch on the left side of the Touch Finder.
- 2** Press the switch toward *ON*.

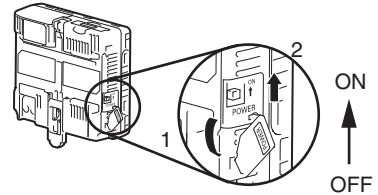

Power Supply Specifications

Use a power supply that meets the following specifications. (The power supply is sold separately.)

Item	Description
Recommended Power Supply	S8VS-01524□ (24 VDC, 0.65 A)
External power supply terminal screws	M4 (tightening torque: 1.2 N·m)
Recommended power line wire size	AWG16 to AWG22 (length of 5 m max.)

Important

- Supply power from a DC power supply for which measures have been applied to prevent high voltages (e.g., a safety extra low voltage circuit).
If UL certification is required for the overall system, use a UL Class II DC power supply.
- When using the FQ-D31, do not connect a switching regulator and AC Adapter (FQ-AC□) at the same time.

Charging the Battery

This section describes how to charge and install the FQ□-D31 Battery and provides applicable precautions.

Charge the Battery while it is attached to the Touch Finder.

Use the AC adapter to charge the battery.

Mounting the Battery in the Touch Finder

- 1** Remove the screw from the battery cover on the top of the Touch Finder, slide the cover in the direction of the arrow, and open the battery cover.

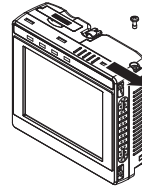

- 2** Face the rounded side of the battery toward the back of the Touch Finder and insert the battery.

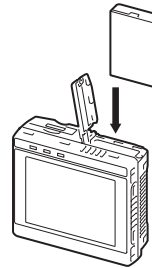

Important

Do not insert the battery in the wrong orientation.

- 3** Close the battery cover, slide the battery cover in the direction of the arrow, and tighten the screw on the battery cover.

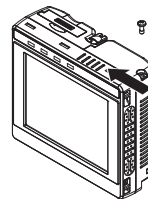

- 4** Attach the AC adapter to the Touch Finder to start charging the battery.

The CHARGE indicator will be lit while the battery is being charged. It will go out when charging the battery has been completed.

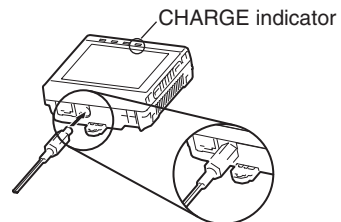

Note

The Touch Finder will operate even if the AC adapter is connected when no battery is mounted in the Touch Finder.

Important

- If the Touch Finder (FQ□-D31) will be installed permanently or semi-permanently, remove the Battery (FQ-BAT1). If the rated temperature is exceeded with the Battery inserted, the protective circuit may activate and stop the Touch Finder.
- The battery complies with the following recycling regulation.

Japan



Li-ion00

EU



Taiwan



- California regulations concerning perchlorate:

This product is a lithium battery that contains perchlorate, which is regulated by the State of California. Please comply with these regulations. For details see the following URL:

www.dtsc.ca.gov/hazardouswaste/perchlorate/

2-5 Setting Up Ethernet

Connecting to Sensors from the Touch Finder

Configurations Consisting of Only Sensors and the Touch Finder

When the Sensor is used with a Touch Finder, IP addresses are automatically assigned. No settings are required to use Ethernet.

Connections on Existing Networks

If a Sensor or Touch Finder is connected to a network where a PLC or computer is already connected, the Ethernet must be set to be compatible with the existing network.

- Setting Fixed IP Addresses

- Sensor

▶  (Setup Mode) – [Sensor settings] – [Network] – [Ethernet]

- 1** Set [Auto connection] to [OFF].
- 2** Set the IP address and subnet mask according to the network settings.

- Touch Finder

▶  (Setup Mode) – [TF settings] – [Ethernet] – [Auto]

- 1** Press [OFF].
- 2** Set the IP address and subnet mask according to the network settings.

Connecting to Sensors from External Devices Such as PLCs

Set the IP address of the Sensor according to the network where the external devices, such as PLCs, are connected.

Configurations Consisting of Only Sensors and a Computer (PC Tool)

If the configuration consists only of Sensors and a Touch Finder, set the network settings on the computer as described below.

(No IP address settings are required on the Sensors.)

▶  (Setup Mode) – [Sensor settings] – [Network] – [Ethernet]

1 Set [Auto] to [OFF].

2 Set the IP address and subnet mask according to the network where the external devices, such as PLCs, are connected.

Note

If you connect OMRON CS/CJ-series PLCs to the Ethernet, the following default IP addresses are assigned to the PLCs.

- IP address: 192.168.250.*node_address*

Connecting to Sensors from a Computer Using the PC Tool

Configurations Consisting of Only Sensors and a Computer (PC Tool)

If the configuration consists only of Sensors and a Touch Finder, set the network settings on the computer as described below.

(No IP address settings are required on the Sensors.)

The following procedure is for Windows XP.

1 Select [Control Panel] from the Windows Start Menu.

2 Click [Network and Internet Connections] in the control panel and then double-click [Network Connections].

3 Right-click the [Local Area Connection] icon and select [Properties].

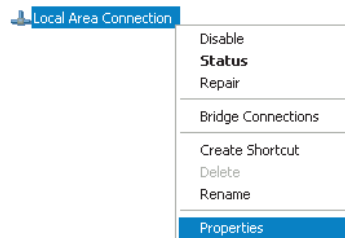

4 On the [General] Tab Page, double-click *Internet Protocol (TCP/IC)*.

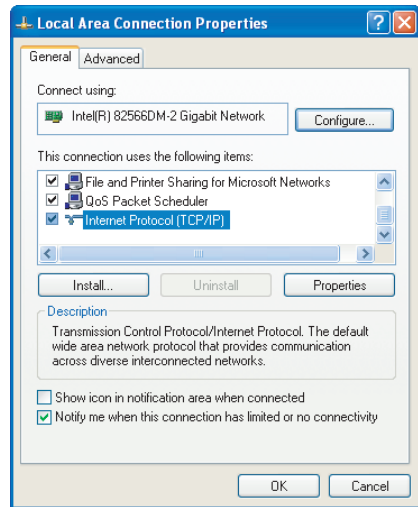

5 Select the *Use the following IP address* Option and enter the following IP address and subnet mask.

- IP address: 10.5.5.101
- Subnet mask: 255.255.255.0

6 Click the [OK] Button. This completes the settings.

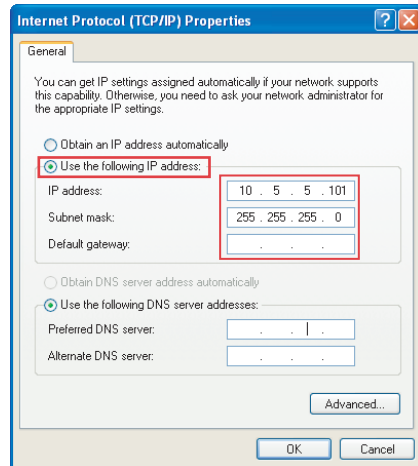

Connections on Existing Networks

Set the Ethernet settings of the Sensors and the computer (PC Tool) to the same settings as the existing network. Refer to *Connecting to Sensors from the Touch Finder* on page 32 for the IP address settings in the Sensors.

Note



- If you connect the PC Tool to a Sensor on a different network through a router, set fixed IP addresses.
- If you use an EtherNet/IP connections, set fixed IP address for the Sensors.

Taking Images

3-1 Selecting a Sensor for Configuration	36
3-2 Adjusting Image Quality.	37
3-3 Adjusting the Object Position	42
3-4 Preventing Mutual Interference of Multiple Sensors	46

3-1 Selecting a Sensor for Configuration

If multiple Sensors are connected to a single Touch Finder or computer, a list of the Sensors that are connected is displayed by default. Use the following procedure to change to the Sensor to set up.

- 1 Press  - [Switch Sensor].
- 2 Press the image of the Sensor to be set up.
 will be displayed for Sensors that are not yet set.

Note

Once the Touch Finder detects and records a Sensor, the display order for showing more than one Sensor is fixed. Even if the system configuration is changed to reduce the number of Sensors, the previous display location will remain for Sensors that were removed. To update displays of multiple Sensors to the current connection status, press [] - [Auto connect] on the right of the display in step 2, above, to automatically reconnect.

- 3 Press  - [Sensor settings] to return to Setup Mode.

- 4 Press [Yes].

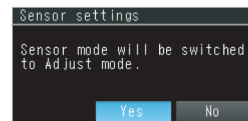
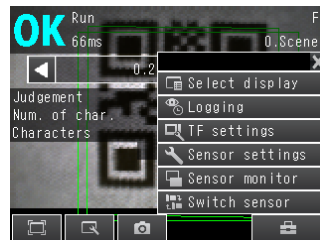
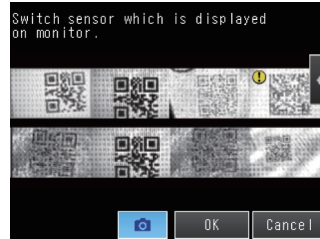

Note

There are different methods that you can use to connect the Sensors. For example, you can automatically connect to the Sensors that are recognized by the Touch Finder, or you can manually register the Sensors to connect.

 7-4 Connecting to More Than One Sensor: p. 98

3-2 Adjusting Image Quality

Adjusting the Focus

► [Image] – [Camera setup]

1 Display the Camera Setup Display.

The focus can be seen as a numerical value. The higher the value, the better the focus.



Focus Level

2 Manually adjust the focus using the focus adjustment screw on the Sensor while checking the image and focus value on the Touch Finder.

In the default settings, the field of view is set to the narrowest setting.

3 Press [Back].

Focus adjustment screw

Turn clockwise to focus on closer objects.
(The field of view will narrow.)

Turn the screw counterclockwise to focus on objects at a distance.
(The field of view will widen.)

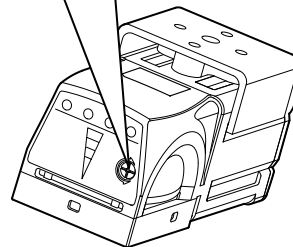

Important

- Turn the focus adjustment screw clockwise or counterclockwise a little bit to make sure that it has not already reached the dead stop. Do not force the screw if it does not rotate anymore. This will damage the Sensor.
- Do not turn the focus adjustment knob with a force that is greater than 0.1 N·m. This may damage it.

Adjusting the Brightness

To achieve stable measurements, the brightness of the camera image must be adjusted so that the characteristic to be measured is clearly visible.

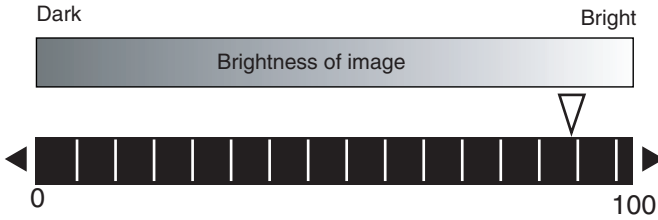

► [Image] – [Camera setup]

1 Press [◀] – [Brightness] on the right side of the display.

2 Move the bar to the left or right to adjust the brightness.

Moving it to the right will make the image brighter, while moving it to the left will reduce the brightness of the image.

Press [AUTO] to automatically adjust the brightness according to the image.



3 Press [OK].

Important

- The exposure time will be longer for larger values. This may cause the image to blur if the object is moving fast. If the Sensor is used on a high-speed line, check that the images are not blurred under actual operating conditions.
- If the brightness changes inconsistently with each image, turn ON the Brightness Correction Mode.

► [Image] – [◀] – [Brightness correction]

When the Brightness Correction Mode is ON, the brightness will be consistent but the timing when images are taken will be delayed by 25 ms. Make sure that appropriate images of the measured objects are taken when the Brightness Correction Mode is ON.

Timing Chart When the Brightness Correction Mode Is ON

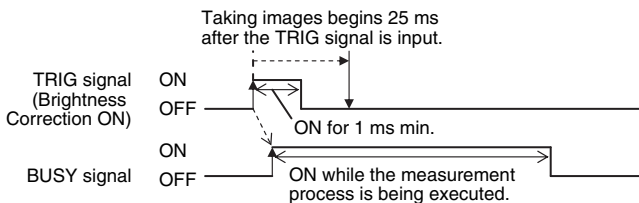

Reference Timing Chart When the Brightness Correction Mode Is OFF: p. 119

Taking Clear Images of Moving Objects

For quick moving objects, the effect of blurring can be reduced by decreasing the exposure time.

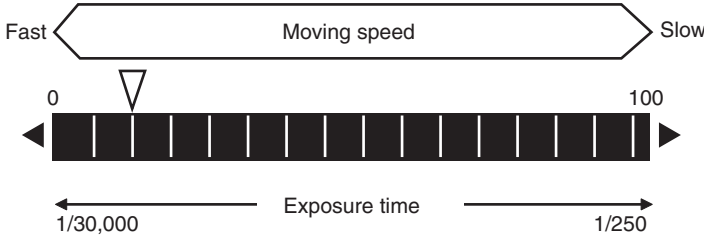

► [Image] – [Camera setup] – [◀] – [Brightness]

Adjusting the Brightness: p. 38

Important

The image becomes darker the smaller the exposure time. If the Sensor is used in a dark environment, make sure that the darkness of the image does not cause the measurements to be unstable.

Improving the Image Quality of Metallic and other Shiny Surfaces

When objects with shiny surfaces are being measured, the lighting may be reflected off the surface and affect the image.

To remove reflections, one of the following two functions can be used.

Function	Description
HDR (High Dynamic Range)	If objects have contrasting light and dark areas, the dynamic range can be made wider to improve the quality of the images.
Polarizing filter	Specular reflections can be eliminated from an image by attaching a polarizing filter to the Sensor.

• Selection Tips

- | | |
|---|----------------------------|
| • When the measurement object is not moving | → Use the HDR function. |
| • When the measurement object is moving | → Use a polarizing filter. |

HDR Function

The HDR function is used for objects that have a large difference between light and dark areas. For this kind of object, clear images cannot be achieved with the standard brightness setting. The HDR function combines several images of different brightnesses (exposure times) so that the resulting image has a lower degree of contrast and can be measured stably for the desired characteristic.

Inputting Images with a Limit Range of Brightness

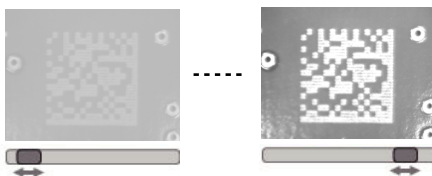

Combining Images to Create an Image with a Wide Dynamic Range

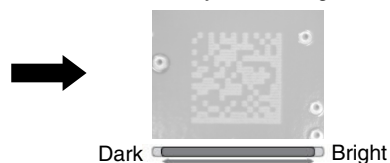

Observe the following precautions.

- Use the HDR function only for objects that are not moving to avoid image blurring.
Several images are taken with different shutter speeds and combined. If the object moves while the image is being taken, the image will become blurred.
- Images with different brightnesses are combined, so the resulting image will have a lower degree of contrast.

► **[Image] – [Camera setup]**

1 Press [◀] – [Brightness] on the right side of the display.

2 Press [◀] – [HDR] on the right side of the display.

The best HDR mode will be selected automatically.

The enabled range will appear in blue on the brightness adjustment bar.

3 Press the [OK] Button.



Note

- If the measurement object is changed after setting the HDR function, press the [AUTO] Button to automatically set the HDR mode again.
- If the automatic selection does not achieve the desired results, press [◀] – [HDR] on the right side of the display and manually set the best HDR mode. As shown below, the higher the level, the wider the combined dynamic range will be.

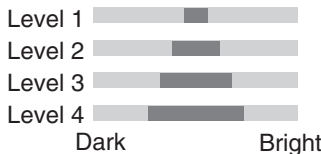

- If the reflections cannot be sufficiently removed using the HDR function, use a polarizing filter as well.

Using a Polarizing Filter

Specular reflections can be eliminated from an image by attaching a FQ-XF1 Polarizing Filter to the Sensor.

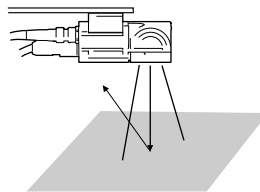

Observe the following precautions.

- The image will be darker compared to when no filter is used.
- If the image becomes too dark, adjust the brightness.

📖 p. 38

• **Mounting the Filter**

1 Hook the filter in the hole at the top of the Sensor.

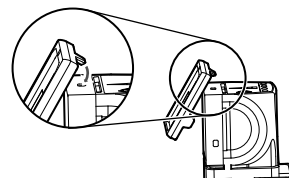

- 2** Using the top section as a pivot point, pull down the filter so that it attaches to the Sensor.

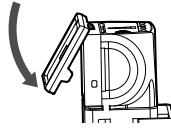

3-3 Adjusting the Object Position

If objects are moving, the position in the image of the characteristic that is to be measured will vary according to the timing of the trigger signal. The FQ-CR1 Sensor offers two different ways to adjust this position variation.

Function	Description	Reference
Position compensation	If the timing of the trigger is accurate, the FQ-CR1 Sensor can correct variations in the position of the object for each measurement with the Position Compensation function.	p. 42
Trigger delay	A delay can be applied from when the trigger (the TRIG signal) is input until when the image is input, to synchronize the timing of image input with the speed of the moving objects.	p. 44

Position Compensation

The FQ-CR1 Sensor performs measurements in measurement regions that are set to a fixed shape and position by the operator. A measurement is not performed properly if the object is not positioned inside this measurement region (e.g., the result will be NG even if the object is OK). In machines in which the position of the object varies for each image, stable measurements would be impossible. To cope this problem, the Position Compensation function aligns the whole image so that the object to be measured is moved exactly to the measurement region.

- Reference position (as set by the operator)
The measurement object is properly within the measurement region.

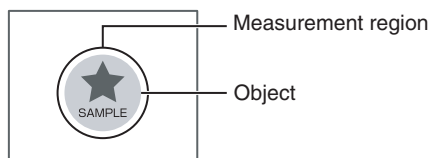

- Object is out of place:
The measurement object is outside the measurement region.

The image is aligned so that the object is returned to the reference position before performing measurements.

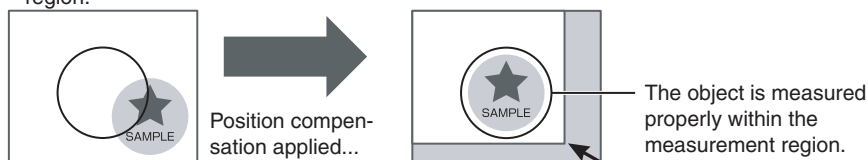

► [Image] – [Position compensation] – [Mode on/off]

- 1 Press [ON] for [Mode on/off]
- 2 Press [Settings].
- 3 Press [Teach].
- 4 Adjust the image so that the measurement object is in the center.
- 5 Press [◀] – [Model region].
- 6 Move the rectangle so that the characteristic part for position compensation is inside it.
- 7 Press [OK].
- 8 Press [Teach].
The characteristic part and reference position for position compensation will be registered.
- 9 Press [OK] to save the settings.

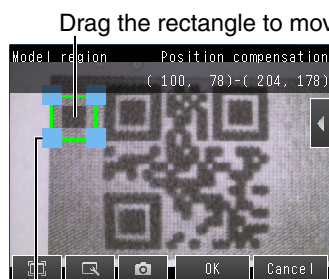

Drag a corner to size the rectangle.

Adjusting the Judgement Parameters

Set how similar the image must be to the registered image for position compensation to be applied.

► [Image] – [Position compensation] – [Settings] – [Judgement]

1 Set the correlation range for an OK judgement.

• Measurement Data That Can Be Used for External Outputs and Calculations

The following values can be output to external devices or used in calculations as measurement data.

Expression text string	Data name	Description	Data range
JG	Judgement	This is the judgement result.	-2: No judgement (not measured), 0: Judgement is OK, -1: Judgement is NG, -13: Teaching not performed error, -14: Figure not registered error, -15: Out of range error
X	Position X	This is the X coordinate of the position where the model was found.	-99999.9999 to 99999.9999
Y	Position Y	This is the Y coordinate of the position where the model was found.	-99999.9999 to 99999.9999
CR	Correlation	This value indicates how similar the image is to the image registered as reference.	0 to 100
SX	Reference position X	This is the X coordinate of the position where the model was registered.	-99999.9999 to 99999.9999
SY	Reference position Y	This is the Y coordinate of the position where the model was registered.	-99999.9999 to 99999.9999
DX	Scroll X	X coordinate of measured position – X reference position	-99999.9999 to 99999.9999
DY	Scroll Y	Y coordinate of measured position – Y reference position	-99999.9999 to 99999.9999

 4-6 Calculations and Judgements Using Inspection Item Data: p. 64

Measures to Stabilize Position Correction

• Low Mark Contrast and Inconsistent Correlations

Areas with high contrast are registered as model registration sections.
Or, adjust the brightness to increase the contrast of the mark.

 Making dark images brighter: p. 38

• Inconsistent Marks and Inconsistent Correlations

Inconsistent portions can be masked so that are omitted from matching.

Increasing the Speed of Position Compensation

The following method can be used to reduce processing time.

- Reduce the range in which searches are performed for the model.

Adjusting the Image Timing

The internal timing for taking an image can be set to be delayed in relation to the external trigger signal. This can be used to adjust the object position in the image, e.g., if an external trigger sensor is used. If the object position still varies in the image the Position Compensation function must also be used.

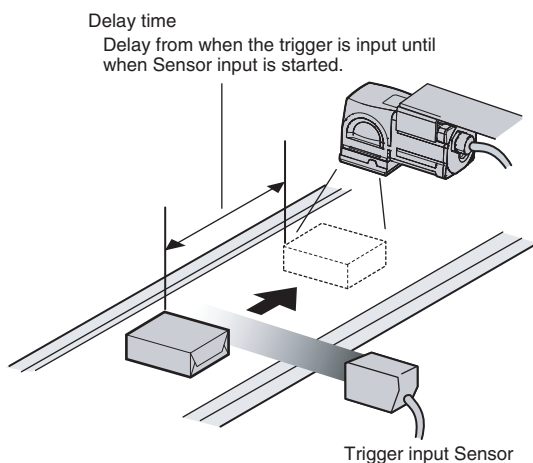

► [Image] – [Trigger setup] – [Trigger delay]

- 1 A TRIG signal is input.**
Images are input continuously.
- 2 Select the image with the measurement object in the center using [◀] and [▶].**
- 3 Press the image.**
- 4 Press [OK].**

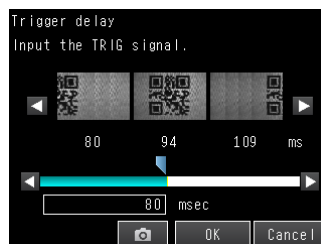

Note

The delay time can be set using the adjustment bar or by directly entering a value.

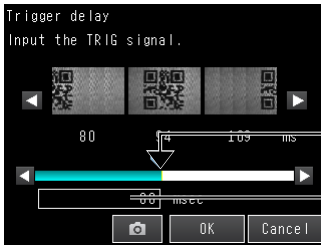

Move the bar to the left or right.

Or

Directly input the delay time.

3-4 Preventing Mutual Interference of Multiple Sensors

When the same trigger signal is input to multiple Sensors, the lighting from one Sensor may affect the measurements of the other Sensors. This is called mutual interference. This kind of interference can be prevented offsetting the image input timing of each Sensor from when the trigger signal is received.

Example:

A trigger (i.e., the TRIG signal) is input to Sensor 0 and Sensor 1 at the same time.

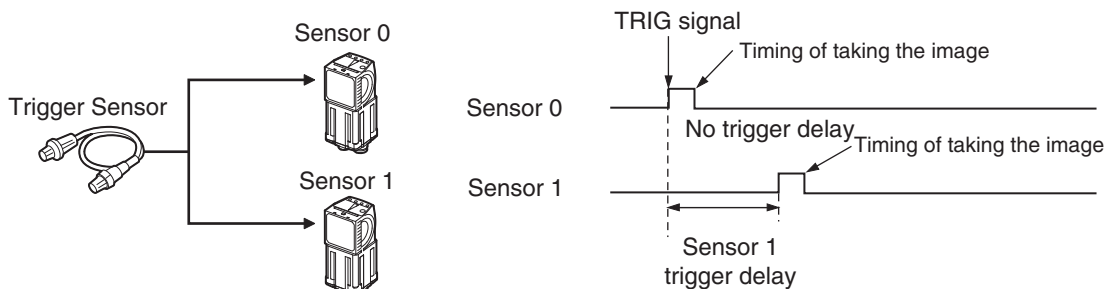

Sensor 0 immediately begins image input when the trigger is input.
Sensor 1 begins image input after the specified time has passed.

1 Change to the setup for to Sensor 1.

p. 36

2 Press [Image] – [Trigger setup] – [Trigger delay].

3 Set the trigger input delay time for Sensor 1.

p. 44

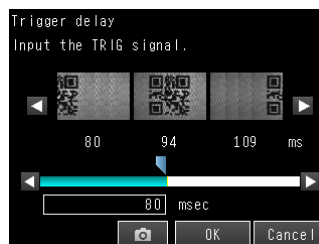

Important



- The delay time for preventing mutual interference must be longer than the shutter time.
When the lighting built into the Sensor is used, the shutter time is 4 ms max. Therefore make the delay at least 4 ms.

Setting Up Inspections

4-1 Inspection Item Selection Guide	48
4-2 Setup Procedure for Inspection Items	49
4-3 Configuring Inspection Items	50
4-4 Reading Bar Codes	52
4-5 Reading 2D-codes	58
4-6 Calculations and Judgements Using Inspection Item Data	64

4-1 Inspection Item Selection Guide

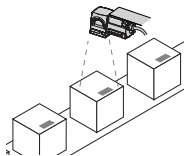
The FQ-CR1 Sensor uses inspection items to judge measurement objects. There are five different measurement objects. Select the best inspection items for the characteristics of the measurement object that are being judged.

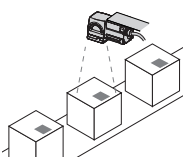
Inspection	Example	Inspection items used	Reference
Judging according to bar code 	Checking product information  <div style="display: flex; justify-content: space-around; margin-top: 10px;"> <div style="text-align: center;">OK 12345</div> <div style="text-align: center;">NG 12346</div> </div>	Bar code	p. 52
Judging according to 2D-code 	Checking product information  <div style="display: flex; justify-content: space-around; margin-top: 10px;"> <div style="text-align: center;">OK 12345</div> <div style="text-align: center;">NG 12346</div> </div>	2D-code	p. 58

4-2 Setup Procedure for Inspection Items

The basic steps for setting up inspection items are shown below.

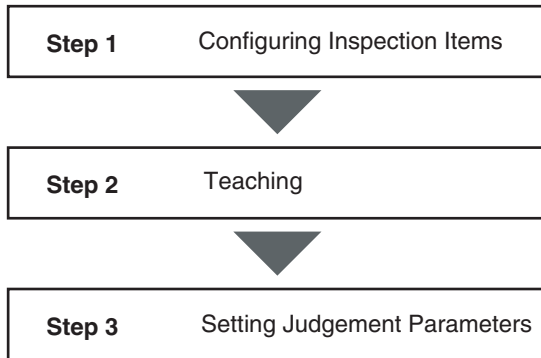

If measurements are unstable

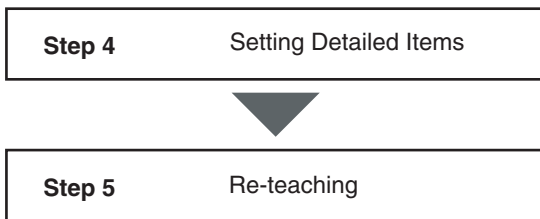

4-3 Configuring Inspection Items

Adding New Inspection Items

1 Press [Inspect] – [Inspection].

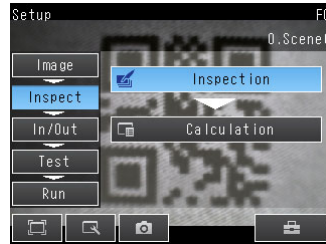

2 Press an unused inspection item number.



3 Press [Add item.] on the menu.

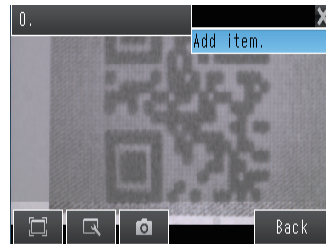

4 Select an inspection item, such as [2D-code].

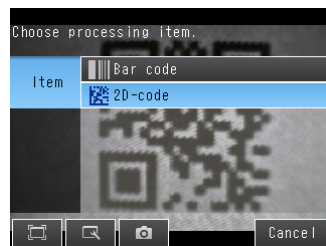

When registering multiple inspection items, press the inspection item number after 1--- and set it in the same way.

Note

If more than six inspection items are set, drag the  icon at the bottom of the menu up to display the next inspection item numbers.

Modifying Existing Inspection Items

1 Press the number of the inspection item to be set.



2 Press [Modify] on the menu.

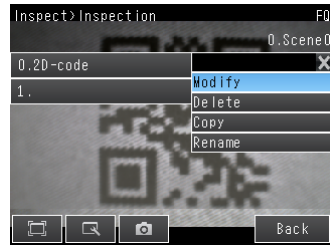

Deleting Inspection Items

1 Press the number of the inspection item to be deleted.

2 Press [Delete] on the menu.



Note

- Executing Similar Measurements in Different Places
 → Copy an inspection item that is already registered: [Copy].
 → Change the name of an inspection item: [Rename].

4-4 Reading Bar Codes

Bar Codes

Bar codes are read and verified. You can output the result of reading and/or verifying bar codes to external devices. The following nine code types can be read.

JAN/EAN/UPC, Code39, Codabar (NW-7), ITF (Interleaved 2 of 5), Code 93, Code128/GS1-128, GS1 DataBar* (Truncated, Stacked, Omni-directional, Stacked Omni-directional, Limited, Expanded, Expanded Stacked), Pharmacode, GS1-128 Composite Code (CC-A,CC-B,CC-C)

* GS1 DataBar is a code in which the name has been changed from the previous RSS.

Note

Setup

Draw the measurement region, then execute AUTO setting. The barcode type and some of the decode conditions are automatically set.

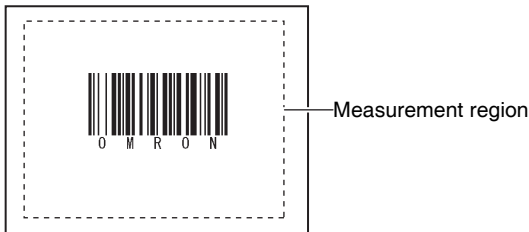

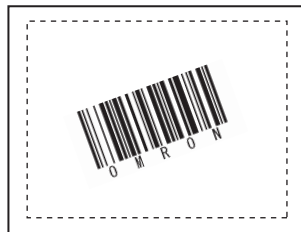

Measurement

One barcode is read in a single measurement region. When the measurement region contains multiple barcodes, the result of the first barcode to be read is output.



Important

Reading will end in error if the barcode type is incorrectly set. Set the barcode type before starting reading. When AUTO setting is executed, the captured barcode is read, and the following items can be set:

- Code type  Setting Decode Settings: p. 56
- Direction (for Pharma only)  Setting Decode Settings: p. 56
- Reverse decode (for Pharma only)  Setting Decode Settings: p. 56

Setup Procedure for Bar Code

Step 1 Selecting the Inspection Item

► [Inspect] – [Inspection]

- 1 Press an unused inspection item number and press [Add item.].
- 2 Press [Bar code].

 4-3 Configuring Inspection Items: p. 50

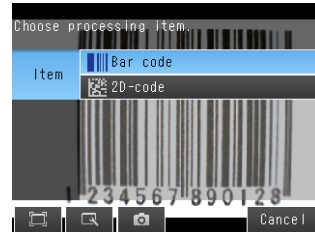

Step 2 Teaching

Teaching means to store the region and the bar code in the region as master data for the measurement.

- 1 Press [Teach].
- 2 Input an image of the bar code to be registered.
- 3 Register master data.

Master data can be registered automatically or manually.

Auto:

Master data is registered using actual codes. Input an image of the applicable bar code and press [TEACH] to read the code and register the result as master data.

Manual:

Up to 32 characters can be registered in a text string. Control codes can also be registered.

Register master data of a text string of up to 32 characters using a software keyboard.

Input a text string and press [TEACH]. Check the ASCII table for characters that can be used. Double-byte characters, single-byte kana characters or control codes cannot be input.

The following characters can be used as wild cards.

*: Wild card of a text string that includes 0 digit.

?: Single-character wild card

 ASCII code table: p. 54

Note ASCII code table

The following table shows the ASCII codes that can be used for manual registration of master data and also for registering characters of Limits.

		Upper 4 bits					
		2	3	4	5	6	7
Lower 4 bits	0	S P	0	@	P	`	p
	1	!	1	A	Q	a	q
	2	"	2	B	R	b	r
	3		3	C	S	c	s
	4		4	D	T	d	t
	5		5	E	U	e	u
	6	&	6	F	V	f	v
	7	'	7	G	W	g	w
	8		8	H	X	h	x
	9		9	I	Y	i	y
	A	*	:	J	Z	j	z
	B	+	;	K	[k	{
	C	,	<	L	¥	l	!
	D	-	=	M]	m	}
	E	.	>	N	^	n	~
	F	/	?	O	_	o	

If more than one master data exist, register each by repeating the procedure above.

Step 3 Adjusting Judgment Parameters

▶ [Inspect] – [Inspection] – [Add item.] – [Bar code] – [Settings] Tab Page

- 1 Press [Judgment].
- 2 Set the range within which the number of characters and text strings are judged as OK.
Continuous measurements will be performed for the images that are displayed.
- 3 Press [OK] to enter the value.



Item	Parameter	Setting	Description
Judgment Parameter	Num. of characters	0 to 1024	Set the upper and lower limits for an OK judgment of the number of characters read.
	Characters	32 characters max. (default *)	Set a text string for an OK judgment of the text string read.

Detail Settings



► [Inspect] – [Inspection] – [Add item.] – [Bar code] – [Details] Tab Page

Press [Function settings].

Setting Function Settings

Set the function settings (verification on/off, verified master data, partial verif. on/off, partial verification setup, string output on/off, error string, partial output on/off and output string setup).

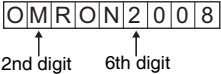
Specify these settings as necessary.

Setup Item	Setting Value	Description
Verification on/off	OFF (default value)	When set to ON, verification with the master data is executed.
	ON	
Verified master data	All master data (default value)	Selects the master data to be used for verification.
	Master data 0 to 31	
Partial verif. on/off	OFF (default value)	The number of digits in the read results to be verified with the master data can be limited. When [Partial verification] is set to ON, set the first and last compared digit positions. Up to 32 characters can be set as the number of digits. Example: First compared digit 2, last compared digit 6
	ON	
Partial verification setup	1 to 1024 (Default First digit: 1, last digit: 1024)	 <p>The text string used for verification becomes "MRON2".</p>
String output on/off	OFF (default value)	Sets whether or not to output the reading result via Ethernet.
	ON	
Error string	Max. 20 digits (default value: NG)	Sets the text string to be output when a read error occurs.  ASCII code table: p. 54
Partial output on/off	OFF (default value)	Sets whether or not to specify a range in the read data to output from when [Output characters] is set to ON.
	ON	
Output string setup	1 to 1024 (default value first digit:1 last digit:1)	Sets the first and last digit positions to output. If the read text string contains non-targeted digits, the error string is output.

Note Output function of the read results

- The output order

If both the calculation and reading results are being output via Ethernet, the reading result (text string) is output after the calculation result is output.

Example: Output of read results together with two expressions

Read result: ABC

[Expression] - [Data0]: 123

[Expression] - [Data1]: 456

The output order is as follows:

123 (field separator) 456 (record separator) ABC (record separator) CR

- Code conversion

The following character codes need to be converted for output. The texts after conversion are output.

Character code	Before conversion	After conversion
Space	&h20	&h8540
CR	&h0D	&h8541
LF	&h0A	&h8542
NULL	&h00	&h8543
FF	&hFF	&h8544

Setting Decode Settings

Press [Decode settings].

Be sure to always specify the code type. Specify other items as necessary. If master data is automatically registered, the code type, the composite codes on/off setting, and the read direction are automatically set.

Setup Item	Setting Value	Description
Code type	JAN/EAN/UPC (default value)	Selects the type of barcode to be read.
	Code39	
	Codebar	
	ITF	
	Code93	
	Code128/GS1-128	
	GS1 DataBar	
	Pharmacode	
Timeout	1 to 9999 ms (default value: 9999)	Sets the timeout time in read processing. A read error occurs if measurement does not end after the preset timeout time is exceeded.
Composite codes on/off	OFF (default value)	Sets whether or not to support composite codes. This item is enabled only when the following barcode types are selected: Code128/GS1-128, GS1-DataBar
	ON	
Check digit on/off	OFF	Selects whether or not to insert a check digit. This item is enabled only when the following barcode types are selected: Codebar, Code39, ITF (Interleaved 2 of 5). When the other codes are selected, this item is set to ON.
	ON (default value)	
Direction	Horizontal mode (default value)	Selects the reading direction. This item is enabled only when Pharmacode is selected as the barcode type.
	Vertical mode	
Reverse on/off	OFF (default value)	Sets whether or not to use the reverse mode. This item is enabled only when Pharmacode is selected as the barcode type.
	ON	

Unstable Reading Results

Reading Is Unstable Due to Low Contrast

Adjust the brightness to improve the contrast of the bar code.

 Adjusting the Brightness: p. 38

Measurement Data That Can Be Used for External Outputs and Calculations

Expression text string	Data name	Description	Data range
JG	Judgment	This is the judgment result.	-2: No judgment (not measured), 0: Judgment is OK, 1: Judgment is NG, 13: Teaching not performed error, 14: Figure not registered error, 15: Out of range error
IN	Index	The verification result (master data No.) is output.	-2: Verification OFF, or reading error -1: Verification is NG, 0 to 31: Master data No.
N	Num. of characters	The number of characters read is output.	0 to 1024

Measurement Data That Can Be Logged (Bar Code)

The following values can be logged as measurement data.

Measured item	Range of value	Description
Num. of characters	0 to 1024	The number of characters read is output.

Errors

Errors in Teaching

A teaching error message is displayed if bar codes cannot be read during an automatic registration. The reading may be unstable due to low contrast. Adjust the brightness to improve the contrast of the bar code.

 Adjusting the Brightness: p. 38

4-5 Reading 2D-codes

2D-codes

2D-codes are read and verified. You can output the result of reading and/or verifying 2D-codes to external devices. The following five code types can be read.

DataMatrix (EC200), QR Code, MicroQR Code, PDF417, MicroPDF417

Note

Setup

Draw the measurement region, then execute AUTO setting. The code type and some of the decode conditions are automatically set.



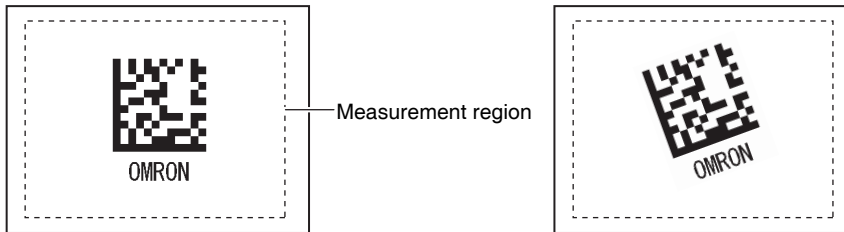

Measurement

One 2D barcode is read in a single measurement region. When the measurement region contains multiple 2D codes, the result of the first 2D code to be read is output.



Important

Reading will end in error if the 2D Code type is incorrectly set. Set the code type before starting reading. When AUTO setting is executed, the captured 2D barcode is read, and the following items can be set:

- Code type  Setting Decode Settings: p. 62
- Mirror  Setting Decode Settings: p. 62
- Code color (for Data Matrix and PDF417 only)  Setting Decode Settings: p. 62
- Shape (for Data Matrix only)  Setting Decode Settings: p. 62

Setup Procedure for 2D-code

Step 1 Selecting the Inspection Item

► [Inspect] – [Inspection]

- 1** Press an unused inspection item number and press [Add item.].
- 2** Press [2D-code].

 4-3 Configuring Inspection Items: p. 50



Step 2 Teaching

Teaching means to store the region and the 2D-code in the region as master data for the measurement.

- 1** Press [Teach].
- 2** Input an image of the 2D-code to be registered.
- 3** Register master data.

Master data can be registered automatically or manually.

Auto:

Master data is registered using actual codes. Input an image of the applicable 2D-code and press [TEACH] to read the code and register the result as master data.

Manual:

Up to 32 characters can be registered in a text string. Control codes can also be registered.

Register master data of a text string of up to 32 characters using a software keyboard.

Input a text string and press [TEACH]. Check the ASCII table for characters that can be used. Double-byte characters, single-byte kana characters or control codes cannot be input.

The following characters can be used as wild cards.

*: Wild card of a text string that includes 0 digit.

?: Single-character wild card

 ASCII code table: p. 60

Note ASCII code table

The following table shows the ASCII codes that can be used for manual registration of master data and also for registering characters of Limits.

		Upper 4 bits					
		2	3	4	5	6	7
Lower 4 bits	0	S P	0	@	P	`	p
	1	!	1	A	Q	a	q
	2	"	2	B	R	b	r
	3		3	C	S	c	s
	4		4	D	T	d	t
	5		5	E	U	e	u
	6	&	6	F	V	f	v
	7	'	7	G	W	g	w
	8		8	H	X	h	x
	9		9	I	Y	i	y
	A	*	:	J	Z	j	z
	B	+	;	K	[k	{
	C	,	<	L	¥	l	!
	D	-	=	M]	m	}
	E	.	>	N	^	n	~
	F	/	?	O	_	o	

If more than one master data exist, register each by repeating the procedure above.

Step 3 Adjusting Judgment Parameters

► [Inspect] – [Inspection] – [Add item.] – [2D-code] – [Settings] Tab Page

- 1** Press [Judgment].
- 2** Set the number of characters and text strings that are to be judged as OK.
Continuous measurements will be performed for the images that are displayed.
- 3** Press [OK] to enter the value.

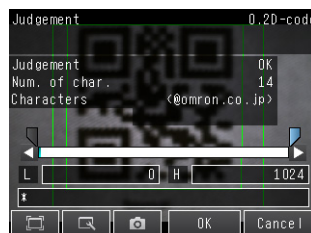

Item	Parameter	Setting	Description
Judgment Parameter	Num. of characters	0 to 1024	Set the upper and lower limits for an OK judgment of the number of characters read.
	Characters	32 characters max. (default *)	Set a text string for an OK judgment of the text string read.

Detail Settings

► [Inspect] – [Inspection] – [Add item.] – [2D-code] – [Details] Tab Page

Press [Function settings].

Setting Function Settings

Set the function settings (verification on/off, verified master data, partial verif. on/off, partial verification setup, string output on/off, error string, partial output on/off and output string setup).

Specify these settings as necessary.

Setup Item	Setting Value	Description									
Verification on/off	OFF (default value)	When set to ON, verification with the master data is executed.									
	ON										
Verified master data	All master data (default value)	Selects the model (master data) to be used for verification.									
	Master data 0 to 31										
Partial verif. on/off	OFF (default value)	The number of digits in the read results to be verified with the master data can be limited. When [Partial verification] is set to ON, set the first and last compared digit positions. Up to 32 characters can be set as the number of digits. Example: First compared digit 2, last compared digit 6									
	ON										
Partial verification setup	1 to 1024 (default value first digit:1 last digit:1024)	<div style="text-align: center;"> <table border="1" style="margin: auto;"> <tr> <td>O</td><td>M</td><td>R</td><td>O</td><td>N</td><td>2</td><td>0</td><td>0</td><td>8</td> </tr> </table> <p style="margin: 5px auto 0 auto;"> ↑ ↑ 2nd digit 6th digit </p> </div> <p>The text string used for verification becomes "MRON2".</p>	O	M	R	O	N	2	0	0	8
O	M	R	O	N	2	0	0	8			
String output on/off	OFF (default value)	Sets whether or not to output the reading result via Ethernet.									
	ON										
Error string	Max. 20 digits (default value: NG)	Sets the text string to be output when a read error occurs. ASCII code table: p. 60									
Partial output on/off	OFF (default value)	Sets whether or not to specify a range in the read data to output from when [Output characters] is set to ON.									
	ON										
Output string setup	1 to 1024 (default value first digit:1 last digit:1024)	Sets the first and last digit positions to output. If the read text string contains non-targeted digits, the error string is output.									

Note **Output function of the read results**

- The output order

If both the calculation and reading results are being output via Ethernet, the reading result (text string) is output after the calculation result is output.

Example: Output of read results together with two expressions

Read result: ABC

[Expression] - [Data0]: 123

[Expression] - [Data1]: 456

The output order is as follows:

123 (field separator) 456 (record separator) ABC (record separator) CR

- Code conversion

The following character codes need to be converted for output. The texts after conversion are output.

Character code	Before conversion	After conversion
Space	&h20	&h8540
CR	&h0D	&h8541
LF	&h0A	&h8542
NULL	&h00	&h8543
FF	&hFF	&h8544

Setting Decode Settings

Press [Decode settings].

Be sure to always specify the code type. Specify other items as necessary. If master data is automatically registered, the code type, reverse setting, code color setting, and shape (Data Matrix) are automatically set.

Setup Item	Setting Value	Description
Code type	Data Matrix	Selects the type of 2D Code to be read.
	QR Code	
	MicroQR Code	
	PDF417	
	MicroPDF417	
Timeout	1 to 9999 ms (default value: 9999)	Sets the timeout time in read processing. A read error occurs if measurement does not end after the preset timeout time is exceeded.
Reverse	Normal (default value)	Sets normal or reverse as the image orientation.
	Reverse	
Code color	Black	Specifies the code color. This item is enabled only when the following barcode types are selected: Data Matrix, QR Code, MicroQR Code
	White	
	Auto (default value)	
Shape (Data Matrix)	Square (default value)	Specifies the code shape. This item is enabled only when the following barcode types are selected: Data Matrix
	Square or Rectangle	

Unstable Reading Results

Reading Is Unstable Due to Low Contrast

Adjust the brightness to improve the contrast of the bar code.

 Adjusting the Brightness: p. 38

Measurement Data That Can Be Used for External Outputs and Calculations

Expression text string	Data name	Description	Data range
JG	Judgment	This is the judgment result.	-2: No judgment (not measured), 0: Judgment is OK, 1: Judgment is NG, 13: Teaching not performed error, 14: Figure not registered error, 15: Out of range error
IN	Index	The verification result (master data No.) is output.	-2: Verification OFF, or reading error -1: Verification is NG, 0 to 31: Master data No.
N	Num. of characters	The number of characters read is output.	0 to 1024

Measurement Data That Can Be Logged

The following values can be logged as measurement data.

Measured item	Range of value	Description
Num. of characters	0 to 1024	The number of characters read is output.

Errors

Errors in Teaching

If 2D-codes cannot be read during an automatic registration, a teaching error message is displayed. The reading may be unstable due to low contrast. Adjust the brightness to improve the contrast of the 2D-code.

 Adjusting the Brightness: p. 38

4-6 Calculations and Judgements Using Inspection Item Data

You can set inspection item judgement results and measurement data with the Calculation menu command to use them in basic arithmetic operations and functions. The judgement results of the calculations are reflected in the overall judgement.

Calculation

Use the Calculation menu command to set the calculation expressions and the judgement parameters for the calculation results.

Expression

You can get up to 32 expressions. You can also combine expressions.

You can use the following values in calculations.

- Inspection item data (measurement data, reference values, and judgement results)
- Constants
- Other calculation results

Judgement

Upper and lower limit values are used for the judgement of calculation results (D0 to D31). Each calculation judgement result (J0 to J31) is turned ON if the result falls within the upper and lower limits. The OR logic of these results will be the overall judgement result JG.

Outputting the Calculation Results

The overall judgement (JG) of the calculations are reflected in the overall judgement of the inspection item. The calculation results (D0 to 31) can be output as Ethernet outputs or it can be output by using logging.

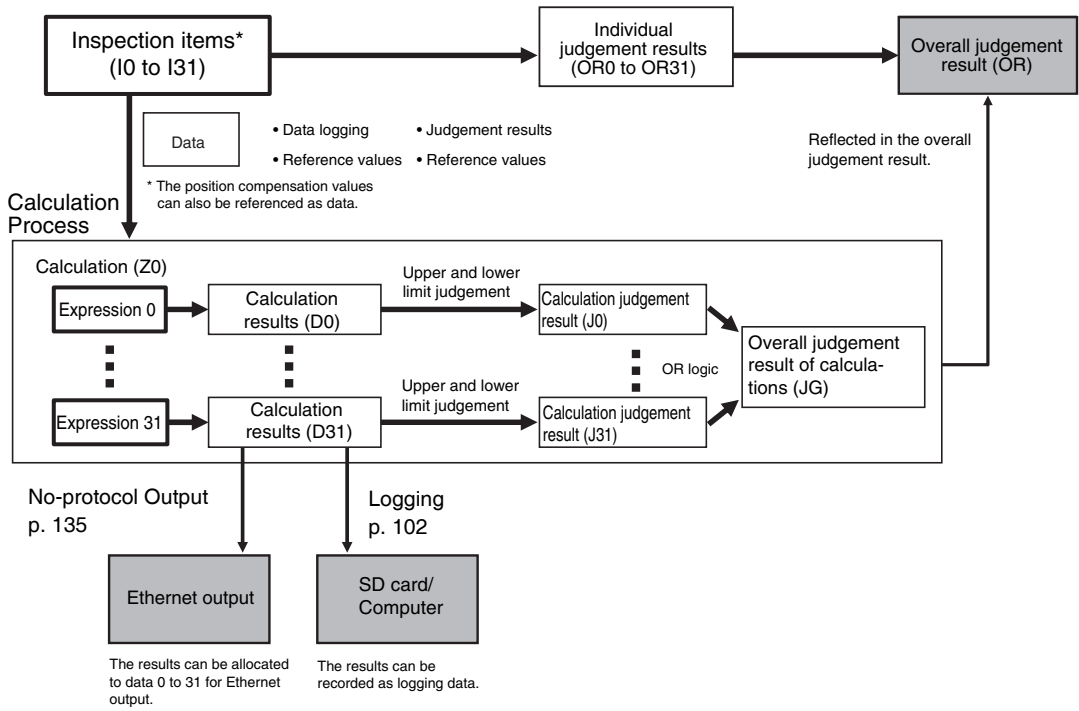

Examples for Calculation

Calculating the Sum of the Num. of Characters Read for Two 2D-codes in the Region

The sum of the num. of characters read is calculated with the expression below using the two 2D-codes of inspection item 0 and inspection item 1.



- Region 0 (Num. of characters of the 2D-code of inspection item 0): (I0.N)
- Region 1 (Num. of characters of the 2D-code of inspection item 1): (I1.N)
- Total sum of the num. of characters of the 2D-codes = I0.N+I1.N

Procedure (Calculation)

- 1 Press [Inspect] – [Calculation].

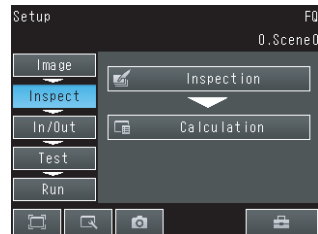

Setting Expressions

- 1 Press [Expression] on the [Settings] Tab Page.

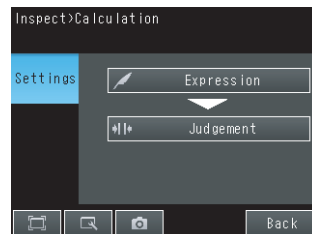

2 Press the expression number that you want to use.



3 Press [Modify] on the menu.



Note

Performing Similar Calculations At Different Locations

- [Rename] The name of the calculation can be changed. (16 characters max.)
- [Copy] Previously registered calculation expressions can be copied.

4 Set the expression by selecting items from the [Data], [Const.], and [Math.] Tab Pages.

The expression will be displayed in the space under [Expression settings].

Do not exceed 255 characters in the expression.

Item	Description
Const.	Press this to input constants or a mathematical operator. The following operators can be used: + (addition), - (subtraction), × (multiplication), and / (division).
Data	Press this to use measurement data, reference values, and judgement results of other items.
Math.	Press this to use functions.

Expression Notation

Expressions must have the following notation.

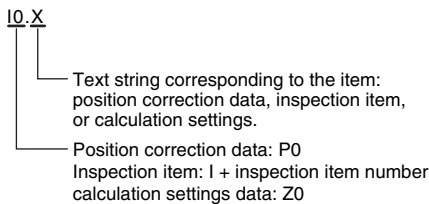

Example: Finding the distance between the centers of gravity of inspection item 1 and inspection item 2 using a function.

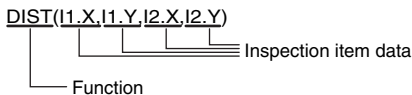

Example: Subtracting 120 from the calculation result of expression 0.

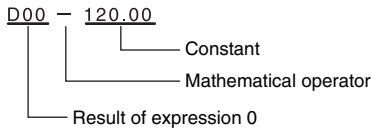

Example: Adding the judgement result of inspection items 0 and 1.

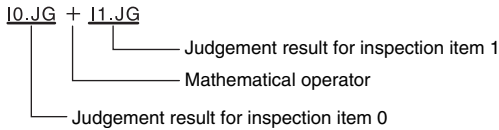

Function List

The following functions can be used in calculations.

Function	Description
SIN	Finds the sine. The result is a value between -1 and 1 . The angle in the expression is in degrees. $SIN(\text{angle})$
COS	Finds the cosine. The result is a value between -1 and 1 . The angle in the expression is in degrees. $COS(\text{angle})$
ATAN	Finds the arctangent of the value (Y component, X component). The result is a radian value between $-\pi$ and π . $ANGL(Y_component, X_component)$ Example: Finding the angle between the straight line joining the centers of region 0 and region 1 and horizontal. $ATAN(R1.Y-R0.Y, R1.X-R0.X)$ If the two arguments are both 0, the result is 0 and the judgement is NG.
AND	Finds the logical AND. If one of the arguments is 0, the calculation result is 0. Otherwise it is -1 . $AND(\text{argument}_1, \text{argument}_2)$
OR	Finds the logical OR. If both of the arguments are 0, the calculation result is 0. Otherwise it is -1 . $OR(\text{argument}_1, \text{argument}_2)$
NOT	Applies a logical NOT operation. If the argument is 0, the calculation result is -1 . Otherwise it is 0. $NOT(\text{argument})$
ABS	Finds the absolute value. $ABS(\text{argument})$
MAX	Returns the larger of the two arguments. $MAX(\text{argument}_1, \text{argument}_2)$
MIN	Returns the smaller of the two arguments. $MAX(\text{argument}_1, \text{argument}_2)$

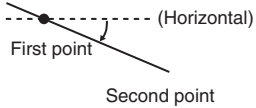
Function	Description
ANGL	<p>Finds the angle of the straight line joining two points (the center of gravity and center of the model). The angle against the horizontal is found. The result is a value between -180 and 180.</p> <p><i>ANGL(Y_component, X_component)</i></p> <p>Example: Finding the angle of the straight line joining the centers of region 0 and region 1</p> <p><i>ANGL(R1.Y-R0.Y, R1.X-R0.X)</i></p>  <p>If the two arguments are both 0, the result is 0 and the judgement is NG.</p>
MOD	<p>Finds the remainder after dividing a non-ordinal number with an ordinal number.</p> <p><i>MOD(non-ordinal, ordinal)</i></p> <p>If any of the arguments are real numbers, the decimals are rounded off before calculating the remainder. The remainder is the result of dividing integers.</p> <p>Example: <i>MOD(13,4)</i> ... Result: 1 (remainder when 13 is divided by 4)</p> <p><i>MOD(25.68,6.99)</i> ... Result: 5 (remainder when 26 is divided by 7)</p>
SQRT	<p>Finds the square root.</p> <p>If the argument is negative, the result is 0. The judgement will be NG.</p> <p><i>SQRT(argument)</i></p>
DIST	<ul style="list-style-type: none"> Finds the distance between two points. <p><i>DIST(first_position_X, first_position_Y, second_position_X, second_position_Y)</i></p> <p>Example: Finding the distance between the centers of gravity of region 0 and region 1</p> <p><i>DIST(R0.X, R0.Y, R1.X, R1.Y)</i></p> <p>The following calculation is performed internally.</p> $\sqrt{(R1.X-R0.X)^2+(R1.Y-R0.Y)^2}$ <ul style="list-style-type: none"> Finds the length of a perpendicular line from point (x,y) to line $ax + by + c = 0$. <p><i>DIST(X_coordinate_of_point, Y_coordinate_of_point, coefficient_a_of_line, coefficient_b_of_line, coefficient_c_of_line)</i></p>

Setting Judgement Parameters for Expressions

1 Press [Judgement] on the [Settings] Tab Page.



2 Press an expression between 0 to 31 and set the corresponding judgement parameters using the slider.

3 Press the [OK] Button.

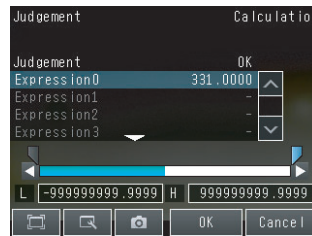

Inspection Item Data That Can Be Used in Expressions

Inspection item	Data name	Expression text string	Data range	Default
Position compensation	Judgement	JG	-2: No judgement (not measured) 0: Judgement is OK -1: Judgement is NG -13: Teaching not performed error -14: Figure not registered error -15: Out of range error	-2
	Position X	X	-99999.9999 to 99999.9999	0
	Position Y	Y	-99999.9999 to 99999.9999	0
	Correlation	CR	0 to 100	0
	Reference position X	SX	-99999.9999 to 99999.9999	0
	Reference position Y	SY	-99999.9999 to 99999.9999	0
	Scroll X	DX	-99999.9999 to 99999.9999	0
	Scroll Y	DY	-99999.9999 to 99999.9999	0
Bar code	Judgement	JG	-2: No judgement (not measured), 0: Judgement is OK, -1: Judgement is NG, -13: Teaching not performed error, -14: Figure not registered error, -5: Out of range error	-2
	Index	IN	-2: Verification OFF, or reading error, -1: Verification is NG, 0 to 31: Master data No.	-2
	Num. of characters	N	0 to 1024	0
2D-code	Judgement	JG	-2: No judgement (not measured), 0: Judgement is OK, -1: Judgement is NG, -13: Teaching not performed error, -14: Figure not registered error, -15: Out of range error	-2
	Index	IN	-2: Verification OFF, or reading error -1: Verification is NG, 0 to 31: Master data No.	-2
	Num. of characters	N	0 to 1024	0

The following values can be specified as calculation data to output them.

Data name	Expression text string	Description
Judgement	JG	This is the judgement result. It is the OR logic of the judgement results of all expressions.
Data 0	D00	This is the result of expression 0.
Data 1	D01	This is the result of expression 1.
Data 2	D02	This is the result of expression 2.
Data 3	D03	This is the result of expression 3.
Data 4	D04	This is the result of expression 4.
Data 5	D05	This is the result of expression 5.
Data 6	D06	This is the result of expression 6.
Data 7	D07	This is the result of expression 7.
Data 8	D08	This is the result of expression 8.

Data name	Expression text string	Description
Data 9	D09	This is the result of expression 9.
Data 10	D10	This is the result of expression 10.
Data 11	D11	This is the result of expression 11.
Data 12	D12	This is the result of expression 12.
Data 13	D13	This is the result of expression 13.
Data 14	D14	This is the result of expression 14.
Data 15	D15	This is the result of expression 15.
Data 16	D16	This is the result of expression 16.
Data 17	D17	This is the result of expression 17.
Data 18	D18	This is the result of expression 18.
Data 19	D19	This is the result of expression 19.
Data 20	D20	This is the result of expression 20.
Data 21	D21	This is the result of expression 21.
Data 22	D22	This is the result of expression 22.
Data 23	D23	This is the result of expression 23.
Data 24	D24	This is the result of expression 24.
Data 25	D25	This is the result of expression 25.
Data 26	D26	This is the result of expression 26.
Data 27	D27	This is the result of expression 27.
Data 28	D28	This is the result of expression 28.
Data 29	D29	This is the result of expression 29.
Data 30	D30	This is the result of expression 30.
Data 31	D31	This is the result of expression 31.

Measurement Data That Can Be Logged

The following values can be logged as measurement data.

Parameter	Setting	Description
Results 0 to 31	-999999999.9999 to 999999999.9999	This is the results of expressions 1 to 31.

Testing and Saving Settings

5-1 Performing Test Measurements	74
5-2 Shortening the Measurement Takt Time	76
5-3 Adjusting the Judgement Parameters	77
5-4 Checking a List of All Inspection Item Results	78
5-5 Saving Data to the Sensor	79

5-1 Performing Test Measurements

After completing the settings in the [Image], [Inspect], and [In/Out] Tab Pages, move to the [Test] Tab Page. The displayed image is measured automatically. This is called a test measurement. A test measurement is used to verify that the settings that have been made will produce stable results and, if necessary, to fine-tune the settings. An overall judgement of all inspection items can be performed.

Test measurements can be performed for through images (default) or saved images.

Performing Test Measurements with Samples

► [Test] – [Continuous test]

- 1 Press [Graphics+Details].
- 2 Input an image of a previously prepared object. Check the judgement results.
- 3 When you finish checking the results, press [Back].

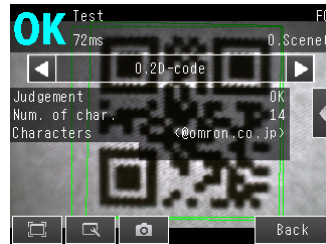

Note

The same five types of displays are available for the [Continuous test] on the [Test] Tab Page, i.e., [Graphic], [Graphics + Details], [All results/region], [Trend monitor], and [Histogram]. Press the [Back] Button to access the menu to change the display.

 Changing the Run Mode display: p. 84

Performing Test Measurements with Saved Images (Re-measuring)

This Sensor can save measured images in the Sensor's built-in memory or on an SD card. Test measurements can be performed using these saved images.

This function is useful for adjusting the judgement parameters when objects are not available.

► [Test] – [Continuous test] – (Any display)

- 1 Press  - .

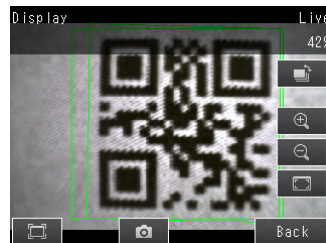

2 Select [Log] or [Logging image file].

memory: Press *Log*.

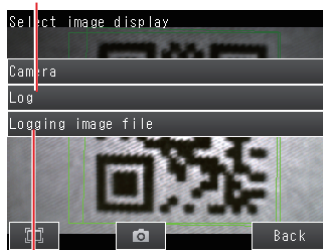

Images on the SD card:
Press *Logging image file*.

3 The display switches to the saved image and measurements are taken again.



 Saving images: p. 114

5-2 Shortening the Measurement Takt Time

Checking the Measurement Takt Time

The measurement time of this Sensor can be checked from the Setup or Run Mode display.

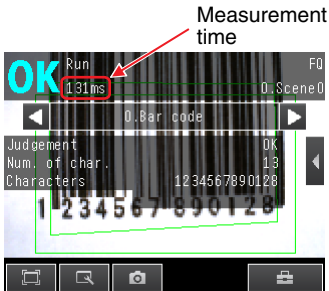

The measurement time is the time taken from when a trigger is input until when all measurement processes are executed.

During the measurement time, this Sensor will not accept the next trigger. This means that the measurement time is the basic measurement takt time.

Inputting a trigger

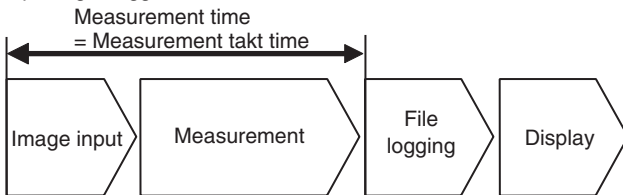

Increasing Image Input Speed

With the partial input function, it is possible to input only images that are in the region that is necessary for measurements.

The image measurement region becomes smaller and thus the image input time is shortened.

► [Image] – [Camera setup]

- 1 Press [◀] – [Partial input] on the right side of the display.
- 2 Change the input size.
- 3 Press [OK].
- 4 Press [Back].



Important

If you use partial input, perform teaching again.

5-3 Adjusting the Judgement Parameters

Adjusting Judgement Parameters While Looking at Measurement Results

If correct judgements are not possible, you can move directly from the Setup Mode display to the judgement parameters display to make adjustments.

► [Test] – [Continuous test] – (Either display)

- 1 Press [◀] – [Adjust judgement] on the right of the display.
- 2 Adjust the judgement parameters.

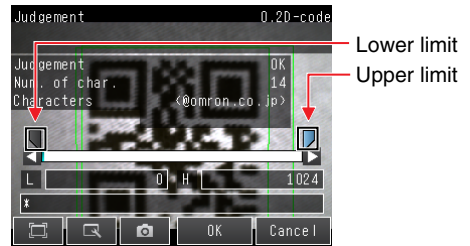

5-4 Checking a List of All Inspection Item Results

Individual judgement results for all inspection items can be checked in a list. The individual inspection items can be selected to change the judgement parameters.

► [Test] – [Continuous test]

1 Press [All results/region] to display the list.



Note

Judgement parameters can also be changed from this display. Select an inspection item and press [◀] – [Adjust judgement].

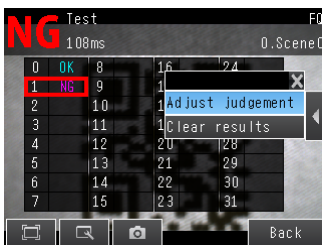

5-5 Saving Data to the Sensor

Until you have saved your settings explicitly to the memory in the FQ-CR1 Sensor, the settings are only stored temporarily. They will be lost if the power is turned OFF. Execute [Save data] after you have finished making your settings. The FQ-CR1 Sensor will remind you to do so with a message if you switch from Setup Mode to Run Mode. You can use this feature to keep the previous settings and discard the new settings if desired, but keep in mind that all settings that are not saved explicitly are replaced by the settings that are stored in the memory of the FQ-CR1 Sensor the next time you turn ON the FQ-CR1 Sensor.

Important



Do not turn the power supply OFF while data is being saved. The data that is being saved may become corrupted.

► [Test]

- 1 Press [Save data].
- 2 Press [Yes].



Note

- Scene data and system data can be saved in this way.
 Scene data and system data details: p. 109
- Measurement data and image data cannot be saved in this way.
 Logging measurement data: p. 102
- Settings data can also be backed up to an external memory.
 Saving settings: p. 109

MEMO

Operation

6-1 Starting Operation	82
6-2 Configuring the Run Mode Display.....	84
6-3 Checking the Trend of Measurement Results with Graphs	86
6-4 Adjusting Judgement Parameters during Operation	89

6-1 Starting Operation

When test measurements and adjustments in Setup Mode have been finished, the display moves to Run Mode and actual measurements begin. In Run Mode, the Sensor operates stand-alone and outputs the measurement judgement results on the I/O lines accordingly to the settings. If the Touch Finder or the PC Tool is connected via network to the Sensor, the operation of the Sensor can be monitored in the following ways.

Run Mode Display



Moving to Run Mode

You can move from Setup Mode to Run Mode by using the following procedure.

- 1 Press [Run].**
- 2 Press [Switch to Run mode.].**
- 3 Press [Yes].**
If you press [No], the setting will not be saved and you will move to Run Mode.

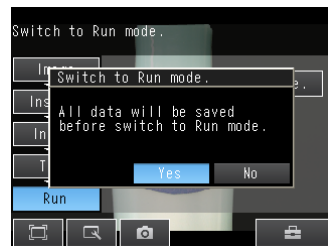

Note

- Returning to Setup Mode

Press  and press [Sensor settings].

- Signal Status When Moving to Run Mode

When moving to Run Mode, the signal will change as shown below and data can be input from and output to an external device.

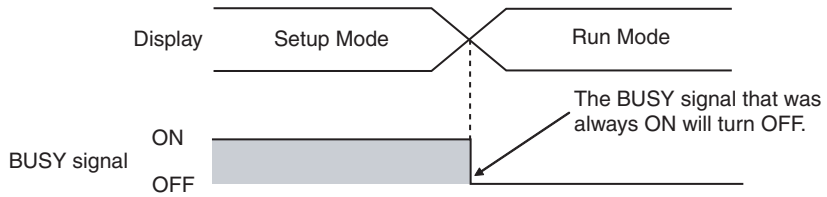

6-2 Configuring the Run Mode Display

There are six types of displays that can be used, as shown below. Select the display as desired.

Checking the Judgement Results of Inspection Items

Graphics



The image and region currently being measured will appear.

Graphics + Details



In addition to [Graphics] display, individual judgement results and measurement values of selected inspection items will appear.

Checking the Overall Judgement Result History

Statistical data



The currently measured image and history of the overall judgement results (measurement count, NG count, and NG rate) will appear.

Checking the Judgements of All Inspection Items in a List

All results/region



The judgement results of all inspection items can be checked in a list.

Displaying Measurement Result Histories

Trend monitor



The statistical data for the currently selected inspection item can be checked against time.

p. 86

Histogram

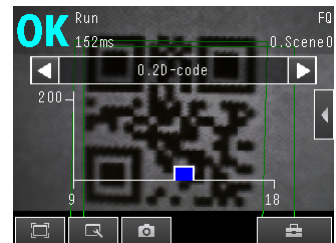

The distribution of measurement results of the currently selected inspection item can be checked.

p. 87

(Run Mode) – [Select display]

The following displays are convenient if more than one Sensor is connected.

Multi sensor

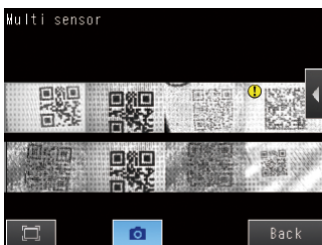

Displays the measurement results of all connected Sensors.
Green display: OK, Red display: NG

NG sensor

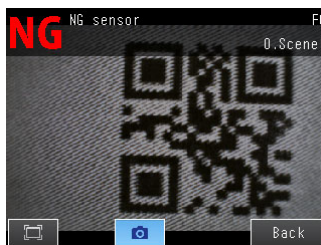

Automatically changes to the display for any Sensor with an NG result.

(Run Mode) – [Sensor monitor]

Specifying the Startup Run Mode Display

The display that appears when power supply is turned ON can be set.
The default setting is [Graphics].

▶  (Setup Mode or Run Mode) – [TF settings] – [Startup display] – [Display pattern]

Note

You can set the scene to be displayed when the power supply is turned ON.

 Setting the Startup Scene: p. 93

Displaying the Inspection Item Results

You can scroll through the measurement results of all the configured inspection items by using the following operations.

Switches to the previous inspection item.

Switches to the next inspection item.

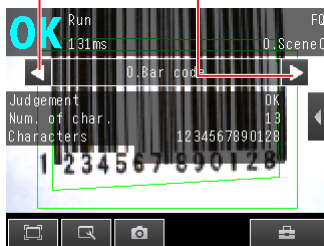

Note

The following are also displayed in addition to the measurement results for each inspection item.

- Camera input: The image that is being measured is displayed.
- Position comp.: The result of position compensation is displayed.
- All Region: The measurement regions for all inspection items are displayed.
- Calculation: Displays the results for each expression registered to an inspection item.

6-3 Checking the Trend of Measurement Results with Graphs

Measurement result histories can be checked using the trend monitor and histograms.

To display trend monitors or histograms in Run Mode, you must make the following setting in advance in Setup Mode.

►  (Setup Mode) – [TF settings] – [Logging setting] – [ON]

Trend Monitor

Changes in the measurement values of the selected inspection item against time can be observed from the graph. It becomes possible to predict when malfunctions may occur or to analyze the cause of the malfunction by checking the trends in the measurement values. The most recent 1,000 measurement values are displayed on the graph.

• [Trend Monitor] Display

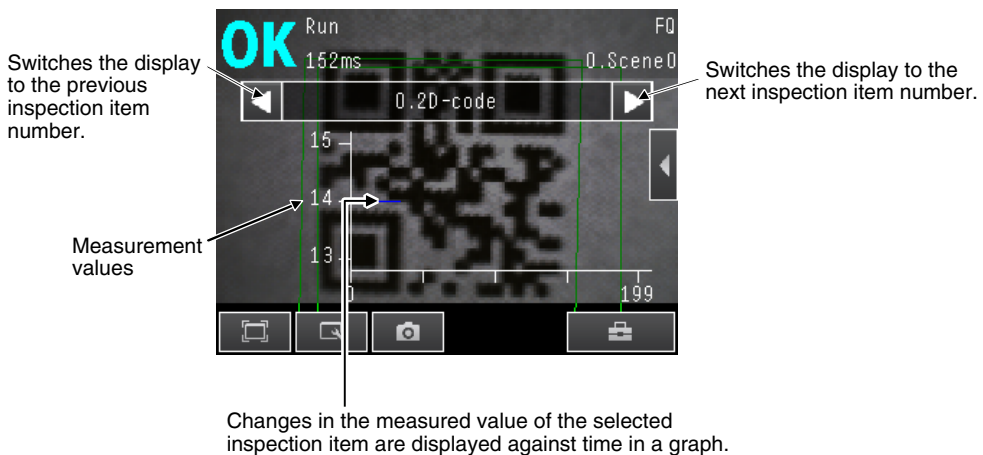

►  (Run Mode) – [Select display] – [Trend monitor]

Arranging the Trend Monitor Display

The display range for the vertical axis and display conditions for the horizontal axis can be changed. However, the display range and the number of data settings are disabled when a display other than the trend monitor is displayed.

• Disabling Automatic Selection of the Display Range

- 1 Press [◀] – [Auto display] on the right of the trend monitor.
- 2 Press [OFF].

• Changing the Display Range of the Vertical Axis

- 1 Press [◀] – [Display range] on the right of the trend monitor.
- 2 Set the minimum and maximum values of the measurement values.

• Changing the Number of Values That Are Displayed

- 1 Press [◀] – [Number of data] on the right of the trend monitor.
- 2 Select the number of values from 200, 400, and 1,000.

Note

- Trend monitor data is held until the power supply is turned OFF.
- You can select whether to display all data on the trend monitor or only data for which the overall judgement is NG. Logging settings are applied to the trend monitor as well. However, they are not applied to trend monitor when it is displayed in Setup Mode.



Check recent measurement trends (recent results logging): p. 105

Histograms

The distribution of each measurement value can be checked on a histogram. The most recent 1,000 measurement values are displayed on a graph.

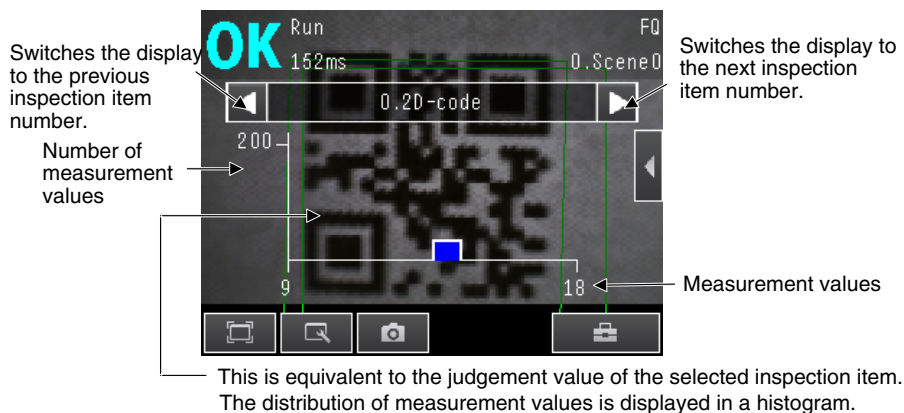

- ▶ (Run Mode) – [Select display] – [Histogram]

Arranging Histogram Display

The display range on the horizontal axis and the number of data on the vertical axis of the histogram can be changed.

• Disabling Automatic Adjustment of the Display Range

- 1 Press [◀] – [Auto display] on the right of the histogram.
- 2 Press [OFF].

• Changing the Display Range of the Horizontal Axis

- 1 Press [◀] – [Display range] on the right of the histogram.
- 2 Select the maximum measurement value, the minimum measurement value, and the class.

• **Changing the Number of Data on the Vertical Axis**

- 1** Press [] – [Number of data] on the right of the histogram.
- 2** Select the maximum number of data to display.

Note

-
- Histogram data is held until the power supply is turned OFF.
 - You can select whether to display all data in the histogram or only data for which the overall judgement is NG. Logging settings are applied to the histogram as well. However, they are not applied to histograms displayed in Setup Mode.



Check recent measurement trends (recent results logging): p. 105

6-4 Adjusting Judgement Parameters during Operation

This Sensor enables judgement parameters to be adjusted while measurements are being performed. Downtime can be eliminated with this feature because the production line does not have to be stopped while making adjustments.

Preparations

This function is switched OFF as a default to prevent it from inadvertently working during operation. Turn ON the function if you want to use it.

▶  (Setup Mode) – [Sensor settings] – [Adjustment mode in Run]

- 1 Press [ON].

Changing the Judgement Parameters in Run Mode

This section describes how to change the judgement parameters without stopping measurement in Run Mode.

▶ **Run Mode**

- 1 Select the inspection item for which you want to adjust the judgement parameters using the ◀ and ▶ Buttons.

- 2 Press [◀] – [Adjust judgement].



- 3 Change the adjustment parameters with the slider.
- 4 Press [OK].
The judgement results with the changed judgement parameters will appear.



Important

The changed judgement parameters will not be reflected in the measurement result until [OK] is pressed.

MEMO

Convenient Functions

7-1 Changing the Scene to Change the Line Process	92
7-2 Display Functions	94
7-3 Monitoring the Signal I/O Status	97
7-4 Connecting to More Than One Sensor	98
7-5 Logging Measurement Data and Image Data	102
7-6 Saving Sensor Settings.....	109
7-7 SD Card Operations.....	110
7-8 Convenient Functions for Operation	112
7-9 Convenient Functions for Setup	114
7-10 Functions Related to the System	115

7-1 Changing the Scene to Change the Line Process

What Are Scenes?

With an FQ-CR1 Sensor, the inspection items that can be processed at the same time are registered as scenes. A command input from an external device or a touch panel operation can be used to select a certain scene.

If a scene is registered for each type of measurement object or inspection, the line process can be changed simply by changing the scene when the measurement object or inspection changes.

A maximum of 32 scenes can be created.

Example:

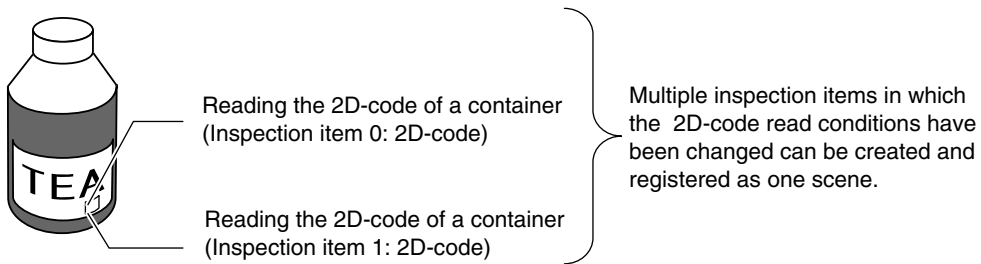

Line Process Changes:

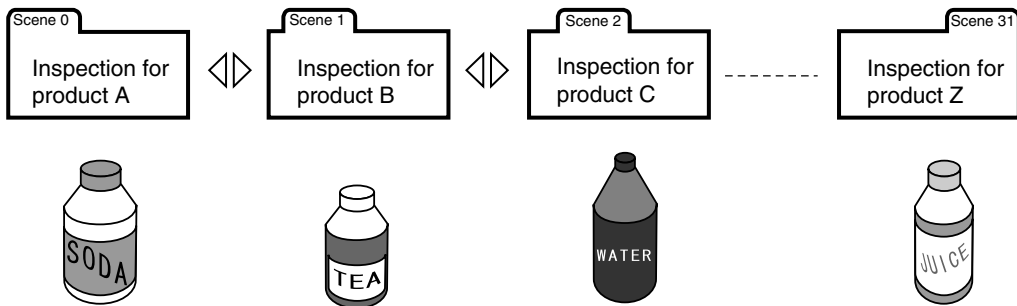

• Settings Included with Scenes

The following settings are changed when the scene is changed: Camera image ([Image] Tab Page) and Inspection Items ([Inspect] Tab Page). The settings related to external I/O specifications that are included in the output settings and the system settings for the overall Sensor are used for all of the scenes.

Refer to the following information for the data that is included in the scene data.

10-1 Menu Tables: p. 166

Creating New Scenes

The default scene number is 0. To create another scene, use the following procedure to switch the scene and then make the settings.

▶  (Setup Mode) – [Select scene]

- 1 Press the number of the scene to change to and then press [Select].
- 2 The scene will change. Make the settings for the scene.

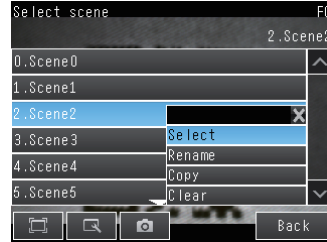



Changing Scene Names, Copying Scenes, and Deleting Scenes

▶  (Setup Mode) – [Select scene]

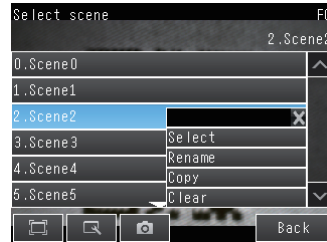
- 1 Press the number of the scene and then press [Rename], [Copy], or [Clear].
- 2 To change the name, enter a new scene name in 15 alphanumeric characters or less.
To copy a scene, press the number of the scene to copy.



Switching Scenes from an External Device

- Controlling with Parallel Inputs
 -  Changing the Scene: p. 129
- Controlling with Ethernet Inputs
 -  Command Details: p. 142

Setting the Startup Scene

▶  (Setup Mode) – [Sensor settings] – [Startup settings]

The following items can be set.

Item	Purpose	Setting range
Startup mode	Select whether the startup scene number is set manually.	ON OFF (The scene number when the settings were saved will be the startup scene number. The startup mode is set to OFF in the default settings.)
Startup scene	Set the scene number to use at startup.	0 to 31

7-2 Display Functions

The procedures given in this section can be used to make the Sensor easier to use and the display easier to see.

Image Zoom

The display can be zoomed in or out to make the image easier to see.

▶ (Setup Mode or Run Mode)



- Enlarges the display.
- Reduces the display.
- Fits the image to the display size.

Press [Back] to end setting the display.

Displaying a Live Image

You can display a live image to check the image that is input by the Sensor in realtime.

▶ (Setup Mode)

- 1 Press .
- 2 Press [Camera].
- 3 Press [Live].
- 4 Press the [Back] Button to return to the [Display] Display.



Displaying a Frozen Image

You can display a frozen image to stop image refreshing and display the last image that was input.

▶ (Setup Mode)

- 1 Press .
- 2 Press [Camera].
- 3 Press [Freeze].
- 4 Press the [Back] Button to return to the [Display] Display.



Displaying a Saved Image

You can display an image that was saved in internal memory in the Sensor or in an SD card. This can be done to configure inspection items or to check measurements using saved images.

▶ (Setup Mode)

- 1 Press  .
- 2 Images in the Sensor's built-in memory: Press [Log].
Images on the SD card: Press [Logging image file].
- 3 Press the [Back] Button to return to the [Display] Display.



Note

Refer to the following information for the procedures to save images.

 Logging Measurement Data: p. 102

Updating the Display and Measurement Results Only for NG Measurement Results

In Run Mode, you can specify updating the display of the image and measurement results only when the measurement result is NG.

▶ (Run Mode)

- 1 Press  .
- 2 Press [Last NG image].
- 3 Press [Back].



Change the following setting to display the last NG image after restarting.

▶ (Setup Mode or Run Mode) - [TF Settings] - [Startup display] - [Display update mode]

- 1 Press [Last NG image].



Note

If an operation to change the display is performed (e.g., if the display pattern is changed or the inspection item is changed) when displaying images for NG results is set, the display will change to refreshing the most recent measurement results and the most recent NG display will disappear.
To ensure that you can check the NG results, log the NG results.



Checking Recent Measurement Trends (Recent Results Logging): p. 105

Automatically Changing to the Display for Any Sensor with an NG Result

You can change the settings to automatically display the Sensor for which the measurement result is NG if more than one Sensor is connected.

- ▶  (Run Mode) – [Sensor monitor] – [NG Sensor]

Hiding the Menu

You can hide the menu and display only the image on the Touch Finder or PC Tool to check the part of the image hidden behind the menu.

If you press the icon again, the menu will be displayed.

- ▶  (Setup Mode or Run Mode)

Turning ON/OFF the Touch Finder Backlight

You can use Eco Mode to turn OFF the LCD backlight and reduce the power consumed by the Touch Finder whenever there is no operation on the Touch Finder for 30 seconds or longer. The LCD backlight will turn ON whenever any part of the touch panel is pressed.

- ▶  (Setup Mode or Run Mode) – [TF settings] – [LCD Backlight] – [ECO mode]

Changing the Brightness of the Touch Finder

The brightness of the LCD backlight can be changed to any of five levels.

- ▶  (Setup Mode or Run Mode) – [TF settings] – [LCD Backlight] – [Brightness]

7-3 Monitoring the Signal I/O Status

You can check if the I/O connections are working normally.

► [In/Out] – [I/O monitor] – [I/O Monitor]

- 1** The I/O status of the external devices will be displayed.
- 2** Press the [OK] Button to return to the [I/O monitor] Display.

Input Signals (TRIG and IN0 to IN5)
Signals that are displayed in red are currently being input from the external devices to the Sensor.

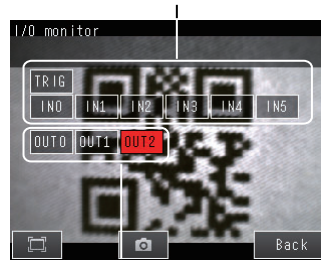

Output Signals
(OUT0, OUT1, and OUT2)
Signals that are displayed in red are currently being output from the Sensor to the external devices.
You can turn the signals ON and OFF by pressing them to test the outputs.

7-4 Connecting to More Than One Sensor

You can connect up to eight Sensors to one Touch Finder or computer.

This sections describes how to connect more than one Sensor to a Touch Finder or computer.

Setting the Sensors to Connect

Use the following setting to connect more than one Sensor to a Touch Finder.

Automatically Connecting Sensors

The Touch Finder can detect Sensors and automatically connect to them in the order that it detects them. The Touch Finder can detect up to 32 Sensors and it can connect to up to eight Sensors at the same time. Set this parameter to [OFF] to connect to only a specific Sensor.

► (Setup Mode or Run Mode) – [TF settings]

- 1 Set [Auto sensor detection] to [ON].

Note

If there are more than eight Sensors available for connection, use [Specify sensor] to select the Sensors to connect.

 3-1 Selecting a Sensor for Configuration: p. 36

Registering the Sensors to Connect

You can set any of the Sensors for connection to the Touch Finder and register them.

► (Run Mode) – [Sensor monitor] – [Multi sensor]

- 1 Press [] – [Specify sensor] on the right of the display.

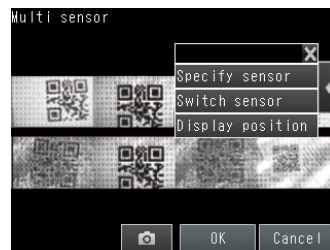

- 2 Press a blank line and then press [Add].

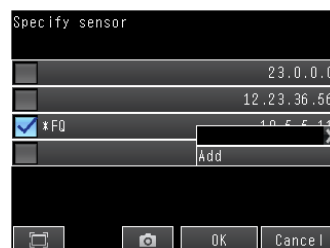

- 3 Enter the IP address.
- 4 Press the IP address that you entered, and then press [Comm. test] to confirm that connection is possible.

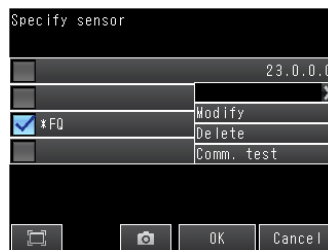

Selecting the Sensors to Connect

You can select the Sensors to connect to the Touch Finder from a list.

▶ (Run Mode) – [Sensor monitor] – [Multi sensor]

- 1 Press [◀] – [Specify sensor] on the right of the display.
- 2 Press the check boxes of the Sensors to connect to select them.

Note

- The Sensors that can be set are indicated by an asterisk before the Sensor name.
- You cannot select the check box if a Sensor that was registered by the user cannot be detected.
- The names of Sensors that are on the same network as the Touch Finder are given in parentheses.

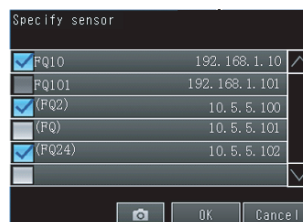





Selecting the Display When More Than One Sensor Is Connected

Selecting the Display When More Than One Sensor Is Connected

You can select the display to appear on the Touch Finder when more than one Sensor is connected.

►  (Setup Mode or Run Mode) – [TF Settings] – [Startup display] – [Startup screen type]

1 Select one of the following display types.

Display type	Description
Multi Sensor	<p>Simultaneously displays the images from up to eight detected Sensors. The display positions for Sensors that are not connected will remain blank.</p> <ul style="list-style-type: none"> The Sensors are connected in the order that they are detected. You can change the display positions of the Sensors.  Specifying Sensor Display Positions for Multiple Sensors ([Multi Sensor] or [Auto] Only): p. 100 If there are more than eight Sensors that can be connected, select the Sensors to connect from the list of Sensors  Selecting the Sensors to Connect: p. 99 Register the Sensor to connect to display a specific Sensor.  Registering the Sensors to Connect: p. 98
NG sensor	Of the connected Sensors, displays the image from the Sensor that most recently had an NG result.
Single sensor	<p>Displays the image from only one Sensor. Of the Sensors, the image from only the Sensor that is specified in [Sensor selection] is displayed. If a Sensor is not specified in [Sensor selection], the image from the first Sensor that is detected will be displayed.</p>  Specifying the Sensors to Connect Continuously: p. 113
Auto (default)	Automatically adjusts the display according to the number of Sensors that are detected. If more than one Sensor is detected, the images from up to eight Sensors are displayed at the same time. If eight Sensors are connected, the display is the same as that for [Multi sensor].

Specifying Sensor Display Positions for Multiple Sensors ([Multi Sensor] or [Auto] Only)

If [Startup screen type] is set to [Multi sensor] or [Auto],*1 you can specify the position of the image on a split display for each Sensor that is displayed.

*1 This can be done only when the maximum number of Sensors (eight) are connected.

►  (Run Mode) – [Sensor monitor] – [Multi sensor]

- Press [◀] – [Display position] on the right of the display.
- Press the display of the Sensor for which to specify the display position. A list of numbers for the display positions will be displayed.
- Select a number from the list of display positions. The display for the Sensor will be displayed in the position that corresponds to the specified number.



Note

The display positions that are set with [Display position] are cleared when the power supply to the Touch Finder is turned OFF.

However, if the Sensor status is changed (by changing from Setup Mode to Run Mode), the current settings for [Display position] are saved in the Touch Finder. Therefore, the next time the same Sensors are connected, they will be displayed in the same positions.

If a previously connected Sensor is not detected, either the display position will be blank, or if [Auto sensor detection] is set to [ON], the Touch Finder will display another Sensor that it has detected.

If a previously connected Sensor is then detected by the Touch Finder, it will display the image from it in the previous display position.

7-5 Logging Measurement Data and Image Data

There are two ways to log data. Data can be temporarily saved in memory inside the Sensor (called recent results logging) or large amounts of data can be saved in SD cards or other external media (called file logging). The amounts of data that can be logged are given in the following table.

Logged data	Recent results logging	File logging
Measurement data (Measured values and calculation results)	1,000 measurement values max.	Up to the capacity of the external memory
Image data (Measured values and calculation results)	20 images max.	

Logging All Data (File Logging)

Large amounts of measurement and image data can be saved in files in external memory (SD cards or computer).

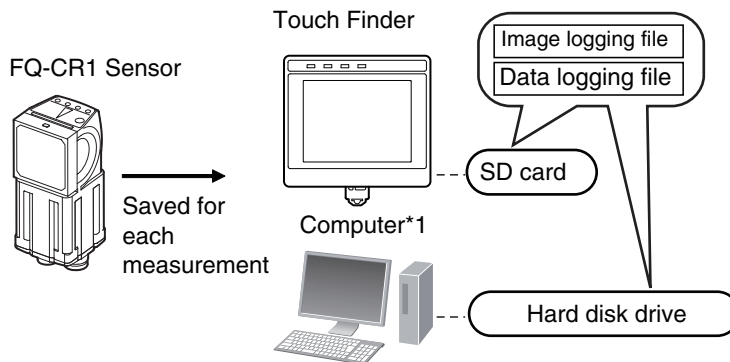

*1: Image data and measurement data can be logged in the same way as for the Touch Finder by installing the PC Tool for FQ.

System Configuration: p. 18

Note

Only the data for the Sensor that is currently being displayed will be logged even if more than one Sensor is connected.

If multiple sensors are displayed, or if the most recent NG sensor is displayed, only the results of the sensor that was displayed before changing to the other sensor monitor screen will continue to be logged. Simultaneous logging of the results of multiple sensors is not possible.

Setting the Data To Be Logged

You can select the data to be logged.

► [In/Out] – [Log setting]

- 1 Press the data for which to change the logging parameter.
- 2 Change the logging parameter and then press [Back].

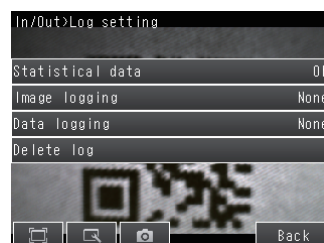

Item	Description
Image logging	<ul style="list-style-type: none"> • All: All images will be logged regardless of the measurement results. • Only NG: Only images for which the overall judgement was NG will be logged. • None: No images will be logged (default).
Data logging	<ul style="list-style-type: none"> • All: All measurement data (Measured values and calculation results) will be logged regardless of the measurement results. • Only NG: Only measurement data (Measured values and calculation results) for which the overall judgement was NG will be logged. • None: No measurement data (Measured values and calculation results) will be logged (default).

Note

The logging parameter settings are the same for file logging and recent results logging.

Enabling File Logging

You must enable file logging before you can execute it.

(Setup Mode) – [TF settings] – [Logging setting]

1 Press [ON].

Starting and Stopping Logging

After logging is started (i.e., set to ON), the specified image data and measurement data will be saved in the SD card or computer hard disk each time measurements are performed.

(Run Mode)

1 Press [Logging].

2 Press [Image logging] or [Data logging].

3 Press [ON] to start logging.

Press [OFF] to stop logging.

4 Press [Back].

Storage Locations and File Names for Logged File Data

Data	Storage location	File name
Image logging (image data)	\sensor_name\ LOGIMAGE\number ^{*1, *2}	img_YYYY_MM_DD-HH_MM_SS.IFZ ^{*3} Example: The following name would be used for measurements performed at 10:10:21 pm on May 10, 2012: img_2012_05_10-22_10_21.IFZ
Data logging (measurement data)	\sensor_name\LOGDATA ^{*2}	File name_YYYY_MM_DD-HH_MM_SS.CSV ^{*4} Example: The following name would be used for measurements performed at 10:10:21 pm on May 10, 2012: 2012_05_10-22_10_21.CSV

*1: A five-digit number is assigned as a name to the image data storage folder in the order of folder creation as shown below.

Up to 100 images are stored in each folder.

00000
00001
⋮

*2: Files are stored in the following folder when the PC Tool is used.

My Documents\OMRON FQ\SDCard

- *3: You can change the “img” at the beginning of the file name.
- *4: You can add a character string to the beginning of the file name.

- Setting the File Name for Logged Data

You can set a character string to add to the beginning of the file name for logged data.

Image data: You can change the “img_” at the beginning of the file name for logged data to another text string.

Measurement data: You can add a character string to the beginning of the file name for logged data.

▶  (Setup Mode or Run Mode) – [TF settings] – [File format]

- 1 Select the item for which to add to or change the file name and then press [Logging image file] or [Logging data file].
- 2 Press [File name prefix].
- 3 Enter the file name (up to 15 alphanumeric characters) and press [OK].
- 4 Press [OK].

- File format

Image logging: Image data is saved in a special format for OMRON Vision Sensors. (The file name extension is IFZ.)

Data logging: Measurement data is saved in the following CSV format.

```
<Date*1>,<Time*1>,<Measurement value for inspection item 0>,<Measurement value for inspection item 1>,...,<Measurement value for inspection item 31>,<D0 of expression 0>, ..., <D31 of expression 31>Delimiter
                                     ↑
                                     Field separator
Record separator ↑
```

*1: The date is given in the following format: 2010/6/1 (for June 1, 2010). The time is given in the following format: 12:01:20 (for 12:01 and 20 seconds pm).

Changing the File Format

The output CSV file format can be changed according to the external device.

Item	Symbol
Field separator	None, comma (default), tab, space, or semicolon
Decimal symbol	None, point (default), or comma
Record separator	None, comma, tab, space, or CR or CF+LF (default)

Use the following menu command to change the output CSV file format.

▶  (Setup Mode or Run Mode) – [TF settings] – [File format] – [Logging data file] – [Output format]

Ensuring That All Measurement Results Are Logged in External Memory

To ensure that all measurement results are actually saved, change the settings so that the BUSY signal remains ON until logging has been completed. During operation, do not input the next trigger until the BUSY signal turns OFF.

▶ [In/Out] – [I/O setting] – [I/O terminals] – [Output] Tab Page – [BUSY output]

Change the BUSY output parameter to [Data logging].

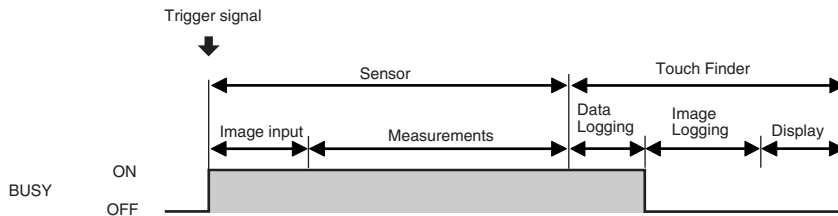

Note

- File logging cannot be used when performing continuous measurements.
- If you use the PC Tool, the logging time may vary by up to 100 ms depending on the application conditions of your computer.
- If logging data to an SD card, the write time varies depending on the amount of the available space on the SD card.
Reference value: For SDHC class 4, the time required to write image data is approx. 200 to 800 ms.

Checking Recent Measurement Trends (Recent Results Logging)

The most recent measurement results can be logged inside the Sensor. Even if data is not logged in external memory, such as an SD card, trends in measurement results can be easily checked on the Touch Finder. However, if the power supply is turned OFF or the scene is changed, this data will be lost.

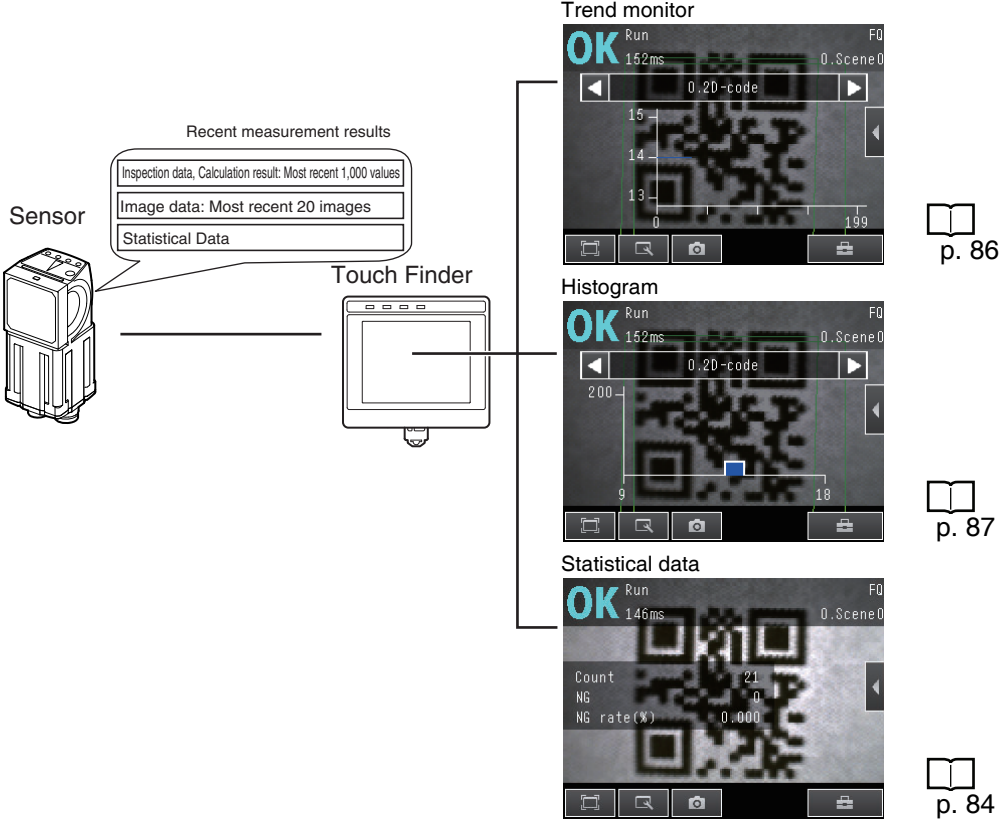



Setting the Data To Be Logged

Use the following procedure to set the statistical data, image data, and measurement data that will be logged.

► [In/Out] – [Log setting]

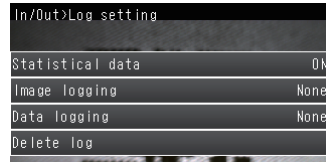
- 1** Press the data for which to change the logging parameters.
- 2** Change the logging parameter and then press [Back].



Item	Description
Statistical Data	Statistical data, such as the number of measurements, the number of NG overall judgements, and the NG rate, since the power supply was turned ON will be logged. <ul style="list-style-type: none"> • ON: Statistical data will be displayed (default). • OFF: Statistical data will not be displayed.
Image logging	These are the same as for file logging.
Data logging	 Logging All Data (File Logging): p. 102

Note

The logging parameters for image data and measurement data are the same as those for file logging.

Starting Logging

Logging will be started as soon as the data to be logged has been set.

If the settings are saved, logging will start automatically the next time the power supply is turned ON.

Checking the Results of Logging

The results of logging can be checked using the trend monitors, histograms, or statistical data.

 p. 84

Use the following menu command to check the measurement images.

-  (Setup Mode) –  – [Log]

Deleting Logged Data

The logged data will be deleted when the power supply to the Sensor is turned OFF or the scene is changed. The logged data can also be deleted without turning OFF the power supply.

• Setup Mode

► [In/Out] – [Log setting]

- 1** Press [Delete Log].

Saving Logged Recent Results Data in a File

Although the logged recent results data will be deleted when the power supply is turned OFF, it can be saved in a file in external memory.

The most recent 1,000 measurement values and the most recent 20 images will be saved.

►  (Setup Mode) – [Save to file] – [Logging] Tab Page

1 Press the data to save.

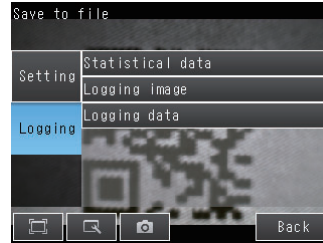

2 The following display will appear if [Logging image] is pressed.

Select whether to save the most recently logged image or to save all of the data that is logged in the Sensor.



The file storage locations and file format are given in the following table.

Item	Storage location	File name
Statistical data	\sensor_name\LOGDATA* ¹	YYYY_MM_DD-HH_MM_SS.CSV Example: The following name would be used for files saved at 10:10:21 pm on March 10, 2010. 2010_03_10-22_10_21.CSV
Logging data		
Logging image	\sensor_name\LOGIMAGE* ¹	YYYY_MM_DD-HH_MM_NNN.IFZ Example: The following name would be used for files saved at 10:10:21 pm on March 10, 2010. 2010_03_10-22_10_21_000.IFZ "NNN" is a serial number that is added when images are logged at the same time.

* Files are stored in the following folder when the PC Tool is used.

\My Documents\OMRON FQ\ SDCard

• File format

Statistical data: The data is saved in the following CSV format.

Number of measurements, number of OKs, number of NGs, OK rate, NG rate (delimiter)

Logging image: Image data is saved in a special format for OMRON Vision Sensors.
(The file name extension is IFZ.)

Logging data: Measurement data is saved in the following CSV format.

<Data number*1>,<Measurement value for inspection item 0>,<Measurement value for inspection item 1>,...,<Measurement value for inspection item 31>.

<D0 of expression 0>, ..., <D31 of expression 31>Delimiter
↑
Field separator
Record separator

*1: Data number 1 is always the data for the oldest measurement and data number 1,000 is always the most recent.

Note

- The saved recent measurement data cannot be loaded back into the Sensor and displayed on a trend monitor or histogram.
- The data and time are not recorded with the measurement data.
The file name is created from the time when the file is saved. It does not indicate when the measurement was made.

Important

The recent measurement data will be cleared if the scene is changed.

Changing the File Format

The output CSV file format can be changed as shown below according to the external device.

 Changing the File Format: p. 104

7-6 Saving Sensor Settings

The Sensor settings are saved in flash memory inside the Sensor.

This section describes how to back up the settings in and restore them from an SD card or other external memory.

Backing Up Settings in External Memory

▶ (Setup Mode) – [Save to file] – [Setting] Tab Page

- 1 Press the data to save.
- 2 Enter the file name in 15 characters or less.
After entering the file name, press [OK]. The data will be saved and the display will return to [Save to file].

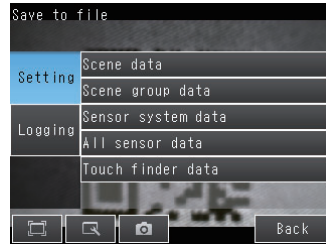

Applicable Data

Data	Storage location	Description
Scene data (The file name extension is SCN.)	\sensor_name\SCN	The following data is backed up for each scene. • Settings for all inspection items • Order of inspection items
Scene group data (The file name extension is SGP.)	\sensor_name\SGP	All scene data is backed up.
Sensor system data (The file name extension is SYD.)	\sensor_name\SYD	All system data in the Sensor is backed up. The system data is the same for all scenes.
All Sensor data (The file name extension is BKD.)	\sensor_name\BKD	All settings in the Sensor (all scene data and Sensor system data) is backed up.
Touch Finder data (The file name extension is MSD.)	MSD	All settings in the Touch Finder are backed up.

For the PC Tool, data will be saved in the following folder: \\.\My Documents\OMRON FQ

Restoring Data to the Sensor from External Memory

▶ (Setup Mode) – [Load from file]

- 1 Press the data to be restored.
- 2 The selected data will be read from external memory and displayed.
Press the file to load.

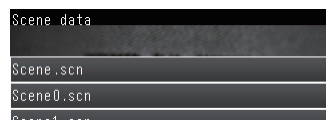
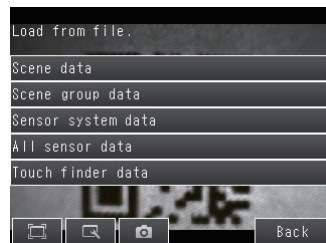

7-7 SD Card Operations

With an FQ-CR1 Sensor, the following folders are automatically created in the SD card according to the data that is saved. The specified data is saved in files in these folders.

Storage folder*1	Data
\sensor_name\SCN	Scene data (The file name extension is SCN.)
\sensor_name\SGP	Scene group data (The file name extension is SGP.)
\sensor_name\SYD	Sensor system data (The file name extension is SYD.)
\sensor_name\BKD	All sensor data (The file name extension is BKD.)
\MSD	Touch Finder data (The file name extension is MSD.)
\sensor_name\LOGIMAGE	Image data (The file name extension is IFZ.)
\sensor_name\LOGDATA	Statistical data and measurement data (The file name extension is CSV.)
\CAPTURE	Captured images (The file name extension is BMP.)

*1: For the PC Tool, data will be saved in the following folder: \\.\My Documents\OMRON FQ

Note

The PC Tool does not support SD card operations.

Inserting and Removing SD Cards

Inserting an SD Card in the Touch Finder

- 1** Open the cover to the SD card slot on the top of the Touch Finder.
- 2** Insert the SD card with the back of the SD card facing the front of the Touch Finder and press it in until it clicks into place.
- 3** Close the cover to the SD card slot.

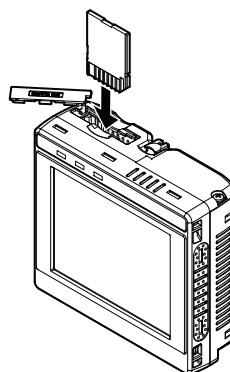
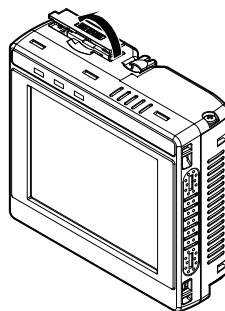

Removing an SD Card from the Touch Finder

- 1 Open the cover to the SD card slot on the top of the Touch Finder.
- 2 Press in on the SD card until you hear a click.
- 3 Pull out the SD card.
- 4 Close the cover to the SD card slot.

- Never remove the SD card while data is being saved or read. The data on the SD card may be corrupted.

Important

Do not restart or turn OFF the power supply to the Sensor or Touch Finder while a message is being displayed saying that data is being saved to or read from the SD card. The settings or system data may be corrupted.

Checking the Available Space on the SD Card

Before saving data to the SD card, use the following display to make sure that there is sufficient space available on the SD card.

- ▶  (Setup Mode or Run Mode) – [TF settings] – [SD card] – [SD card information]

The following information in the SD card inserted in the Touch Finder can be checked.

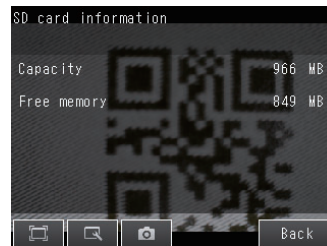

Formatting an SD Card

- ▶  (Setup Mode or Run Mode) – [TF settings] – [SD card] – [Format]

Press [Yes] to start formatting.



7-8 Convenient Functions for Operation

This section describes the functions that can be used during Sensor operation.

Setting a Password to Prevent Unwanted Changes

A password can be set to prevent unwanted changes to settings.

If a password is set, you cannot change from Run Mode to Setup Mode without entering the password.

Setting a Password

▶  (Setup Mode) – [Sensor settings] – [Password settings]

- 1 Press [Password on/off] and press [ON].
- 2 Press [Enter password].
- 3 Enter a password containing up to 15 characters and press [OK].

Clearing the Password

▶  (Setup Mode) – [Sensor settings] – [Password settings]

Press [Password on/off] and press [OFF].

Entering the password when switching from [Run] Mode to [Setup] Mode.

- 1 If a password is set and you try to change from Run Mode to Setup Mode, the following password entry display will appear.

▶  (Setup Mode) – [Sensor settings]

- 2 Press the text box. A keyboard display will appear. Enter the password and press [OK]. If the password is correct, the Setup Mode will be displayed.

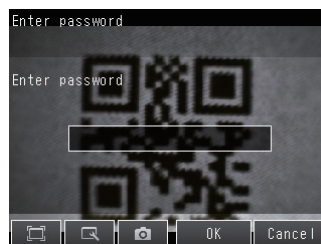

Important

- This password restricts only the operation to switch from Run Mode to Setup Mode. It does not restrict other operations.
- If you forget the password, contact your OMRON representative for the procedure to clear the password.
- The password is deleted when the Sensor is initialized.

Capturing the Displayed Image

The current display on the Touch Finder or PC Tool can be captured and used in text files and other files on the computer.

The captured images are saved in external memory*1 as bit maps.

*1: Images captured on the Touch Finder are saved in the SD card. Images captured with the PC Tool are saved in the computer's hard disk drive.

▶ (Setup Mode or Run Mode)

The image that is being displayed when the button is pressed is saved in external memory.

• Storage Location and File Names

Storage location	File name
VCAPTURE	YYYY_MM_DD-HH_MM_SS_MS.BMP Example: The following name would be used for an image that was captured at 10:10:21.350 pm on March 10, 2010. 2010_03_10-22_10_21_350.BMP

Important

Make sure an SD card is inserted in the Touch Finder before capturing display images.

Note

For the PC Tool, data will be saved in the following folder: \\.\My Documents\OMRON FQ

Setting the Startup Run Display Pattern

You can select the startup run display pattern.

▶ (Setup Mode or Run Mode) – [TF settings] – [Startup display] – [Display pattern]

- 1 Select from the following: [Graphics], [Graphics + Details], [Statistical data], [All results/region], [Trend monitor], or [Histogram].

Specifying the Sensors to Connect Continuously

You can specify one Sensor to connect to the Touch Finder.

The Touch Finder will connect to that Sensor each time the Touch Finder is started.

▶ (Setup Mode or Run Mode) – [TF settings] – [Startup display]

- 1 Set [Specify sensor] to [ON].
- 2 Set [Sensor selection] to the IP address of the Sensor.

Note

If the Touch Finder cannot connect to the specified Sensor when the Touch Finder is started, it will continue to retry until a connection is made.

If connection to the specified Sensor is not possible, press the [Cancel] Button to cancel connecting to the specified Sensor.

7-9 Convenient Functions for Setup

This section describes the functions that can be used when setting inspection items.

Making Settings with Stored Images

With an FQ-CR1 Sensor, judgement parameters can be set by using the following images.

- Images saved in internal Sensor memory
- Logging image files in an SD card

Saving Image Data

• Temporarily Saving Images in the Sensor

The measured images can be temporarily saved inside the Sensor. These images are held until the Sensor power supply is turned OFF.

▶ **[In/Out]** – **[Log setting]** – **[Image logging]**

 Setting Logging Parameters for Image Data: p. 105

• Saving Images in the Sensor to an SD Card

The images that are temporarily saved inside the Sensor can be saved to an SD card.

▶  **(Setup Mode)** – **[Save to file]** – **[Logging] Tab Page**

1 Press **[Logging image]**.

2 Select whether to save the most recently logged image or to save all of the data that is logged in the Sensor.

Storage location	File name
\\sensor_name\LOGIMAGE	YYYY_MM_DD-HH_MM_SS.IFZ Example: The following name would be used for files saved at 10:10:21 pm on March 10, 2010. 2010_03_10-22_10_21.IFZ

• Saving Images in an SD Card

The image data can be saved in the SD card each time measurements are performed.

▶  **(Run Mode)** – **[Logging]**

 Logging All Data (File Logging): p. 102

Displaying Image Data

• Images Saved in Internal Sensor Memory

▶  **(Setup Mode)** –  – **[Log]**

• Logging Image Files in a SD Card

▶  **(Setup Mode)** –  – **[Logging image file]**

 Arranging the Display - Displaying a Saved Image: p. 95

7-10 Functions Related to the System

This section describes system settings.

Turning OFF the Integrated Sensor Lighting

The internal light can be turned OFF to use external illumination.

▶  [Image] – [Camera setup] – [] – [Lighting control]

Press [OFF].

Switching the Display Language

Any of the following languages can be selected for display on the Touch Panel or PC Tool.

Japanese, English, German, French, Italian, Spanish, Traditional Chinese, Simplified Chinese, or Korean

▶  (Setup Mode or Run Mode) – [TF settings] – [Language]

Press the language to be displayed.

Setting the Time on the Touch Finder

You can set the date and time.

▶  (Setup Mode or Run Mode) – [TF settings] – [Time settings]

Initializing the Sensor and Touch Finder

• Initializing the Sensor

▶  (Setup Mode) – [Sensor settings] – [Initialize]

• Initializing the Touch Finder

▶  (Setup Mode or Run Mode) – [TF settings] – [Initialize]

Restarting the Sensor and Touch Finder

• Restarting the Sensor

▶  (Setup Mode) – [Sensor settings] – [Restart]

• Restarting the Touch Finder

▶  (Setup Mode or Run Mode) – [TF settings] – [Restart]

Checking Versions

- **Checking the Sensor Version**

▶  (Setup Mode) – [Sensor settings] – [Information]

- **Checking the Touch Finder Version**

▶  (Setup Mode or Run Mode) – [TF settings] – [Information]

Checking the Touch Finder Battery Level

▶  (Setup Mode or Run Mode) – [TF settings] – [Battery level]

Important

- The battery level is displayed only for a Touch Finder with a DC/AC/battery power supply (FQ-D31).
- The settings will be lost if the battery runs out while you are making the settings. If the battery level is low, save the settings and charge the battery immediately.

Changing the Sensor Name

An alphanumeric name can be assigned to a Sensor to make it easier to recognize. This is convenient when more than one Sensor is connected.

▶  (Setup Mode) – [Sensor settings] – [Information] – [◀] – [Rename]

Checking Available Memory in the Sensor

If a setting cannot be made, check the amount of memory that is available in the Sensor.

▶  (Setup Mode) – [Sensor settings] – [Information] – [◀] – [Memory State]

Correcting the Touch Screen Positions of the Touch Finder

Use this function to correct the touch screen positions if they are offset from the opposite position.

▶  (Setup Mode) – [TF settings] – [Touch screen calib]

Setting the Resolution of Measurement Objects Displayed on the PC Tool

Use this function to set the resolution of measurement object that are displayed on the Touch Finder on the PC.

▶  (Run Mode) – [TF settings] – [Resolution]

Communications with External Devices

8-1 Controlling/Outputting in Parallel	118
8-2 Outputting/Controlling with Ethernet	135

8-1 Controlling/Outputting in Parallel

Operation with Default Configuration

This section describes the basic connections and signal flow with external devices. With the default settings, the Sensor operates in the following manner.

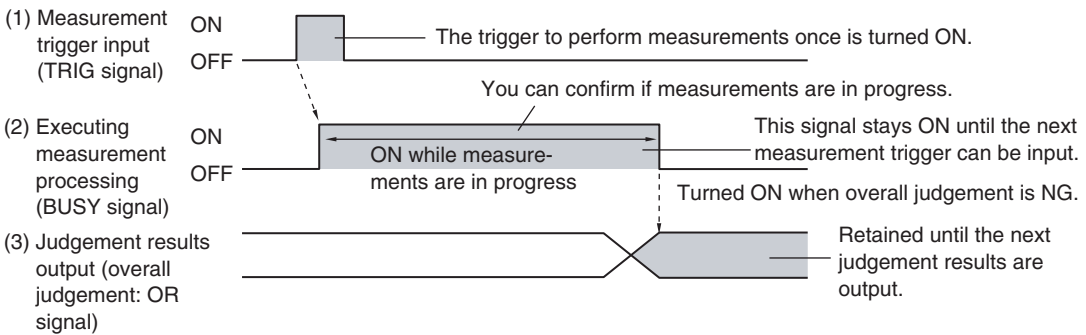
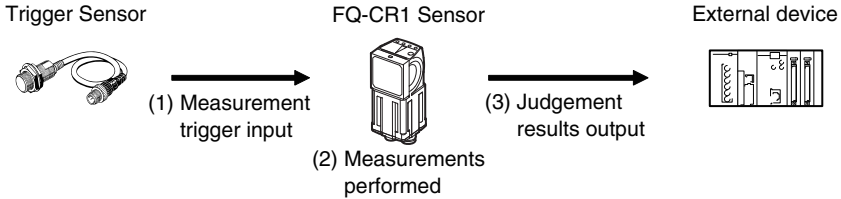

Important

- Create the ladder program to control the TRIG and IN5 input signals so that they do not turn ON while the BUSY signal is ON. If not, a TRIG input error will occur and the ERROR signal will turn ON.
- Operation When the Sensor Power Supply Is Turned ON

The BUSY signal will operate as shown below when the Sensor's power supply is turned ON.

Create the ladder program in the PLC or other external device so that the BUSY signal is ignored while it turns OFF, ON, and OFF again for up to 5 s after the power supply is turned ON.

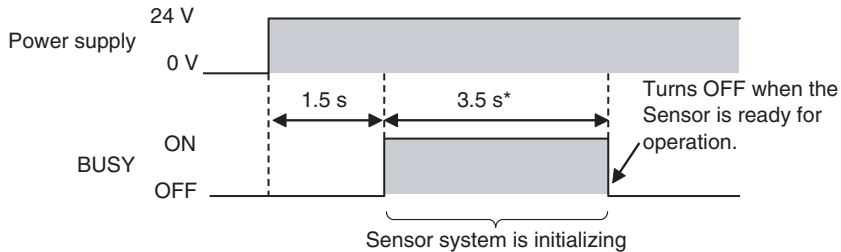

* Depends on the scene data.

Configuring the Operation

The following settings can be selected depending on the system configuration and application.

Type of change	Change	Reference
Changing the type of measurement trigger	Performing continuous measurements	p. 121
Changing the output method of the judgement results	Obtaining individual judgement results	p. 124
	Adjust the judgement output timing	p. 126
	Changing the judgement output ON conditions	p. 128
Changing the polarity of the BUSY output	Reversing the polarity of the BUSY signal	p. 128

Setting the Measurement Trigger

The measurement trigger can be chosen from the following two types:

- One-shot measurement: One measurement is performed for each external trigger.
- Continuous measurement: Measurements are performed continuously.

Performing One Measurement for Each External Trigger

A measurement trigger is input as the TRIG signal from a proximity sensor, PLC, or other external device. One measurement is performed when the TRIG signal turns ON.

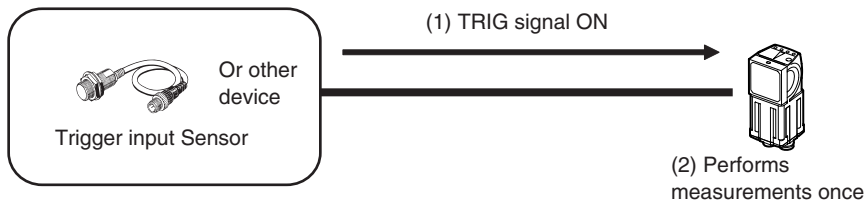

Wiring

Color	Signal	Description
Pink	TRIG	Trigger signal
Black	OUT0 (OR)	Overall judgement (default assignment)
Orange	OUT1 (BUSY)	Processing in progress (default assignment)

The signals shown at the left are used.

Refer to the following information for signal wiring.



Wiring: p. 27

Timing Chart

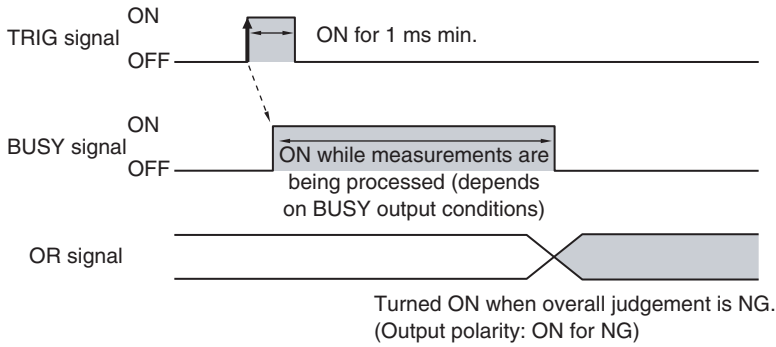

1. Turn ON the TRIG signal while the BUSY signal is OFF.
2. Measurement begins and the BUSY signal is turned ON during the measurement process.
3. When the measurement has been finished, the measurement result is output using an OR signal, and the BUSY signal is turned OFF. *1

*1: You can also set the signal to be turned OFF after data logging, image logging, or displaying results in the [BUSY output].

Important

When the Brightness Correction Mode is ON, the timing when images are taken is delayed.



Timing Chart When the Brightness Correction Mode Is ON: p. 38

Sample Ladder Program

The following sample program is used to input a TRIG signal to perform a single measurement. A single measurement will be performed when W0.00 turns ON.

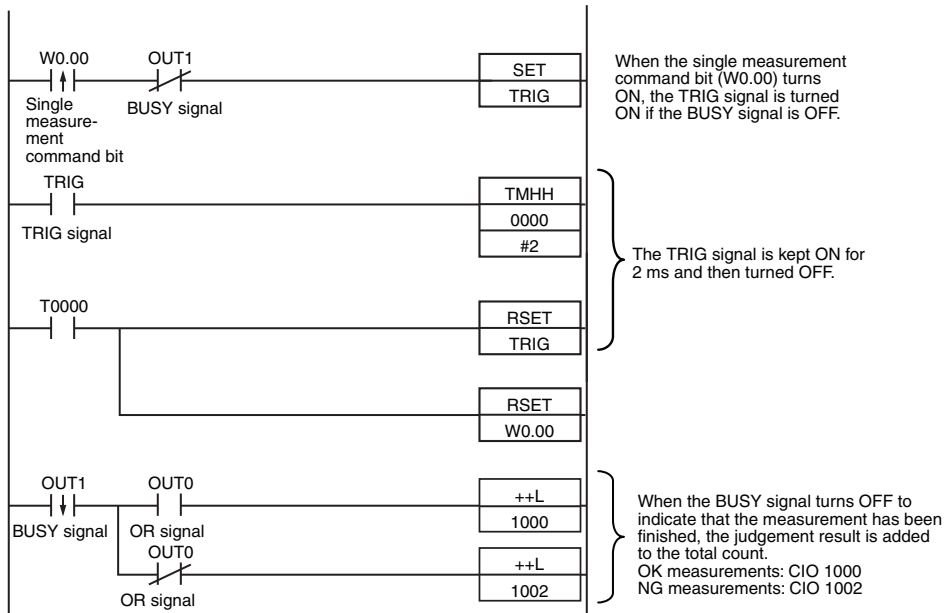

• I/O Signal Allocations

Signal		Address
Output signals	OUT0 (OR signal)	CIO 0.00
	OUT1 (BUSY signal)	CIO 0.01
Input signals	TRIG	CIO 1.00

Important

The BUSY signal will remain ON while the measurement is being executed.

Performing Continuous Measurements

Continuous measurements are performed while the continuous measurement command is input from an external device.

Immediately after a measurement is performed, the next measurement is performed.

This is repeated while a continuous measurement command is input with the IN0 to IN5 signals.

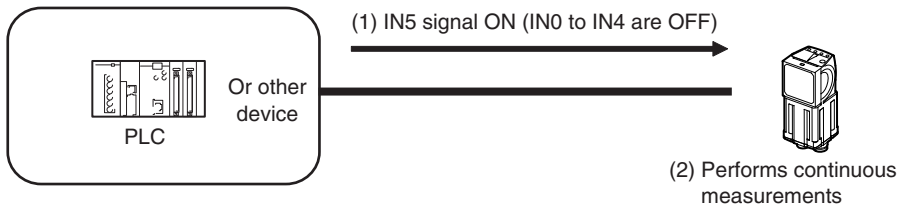

Note

This function can be used only when the input mode is set to Expanded Mode.

Wiring

Color	Signal	State	Description
Gray	IN0	OFF	Command parameters for continuous measurements
Green	IN1	OFF	
Red	IN2	OFF	
White	IN3	OFF	
Purple	IN4	OFF	
Yellow	IN5	ON	Command input for continuous measurements
Black	OUT0 (OR)	--	Overall judgement (default assignment)
Orange	OUT1 (BUSY)	--	Processing in progress (default assignment)

The signals shown at the left are used. Refer to the following information for signal wiring.



Wiring: p. 27

Timing Chart

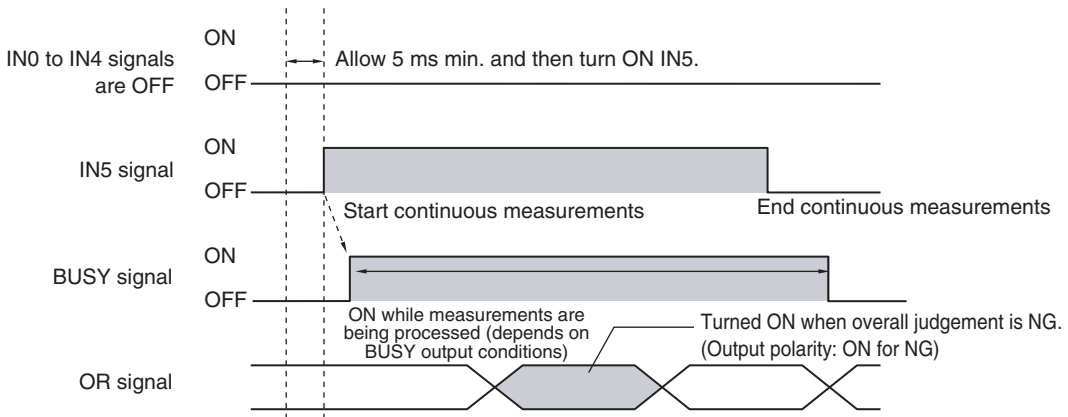

1. Turn ON IN5 while IN0 to IN4 are OFF. If status is held while the BUSY signal is OFF, continuous measurements will begin and the BUSY signal will remain ON while continuous measurements are being performed.
2. Continuous measurements end when IN5 is turned OFF.

Settings

► [In/Out] – [I/O setting] – [I/O terminals] – [Input] – [Input mode]

Press [Expanded mode].

Sample Ladder Program

The following sample program is used to input a IN5 signal to perform continuous measurements. Continuous measurements will be started when W0.00 turns ON and stopped when W0.01 turns ON.

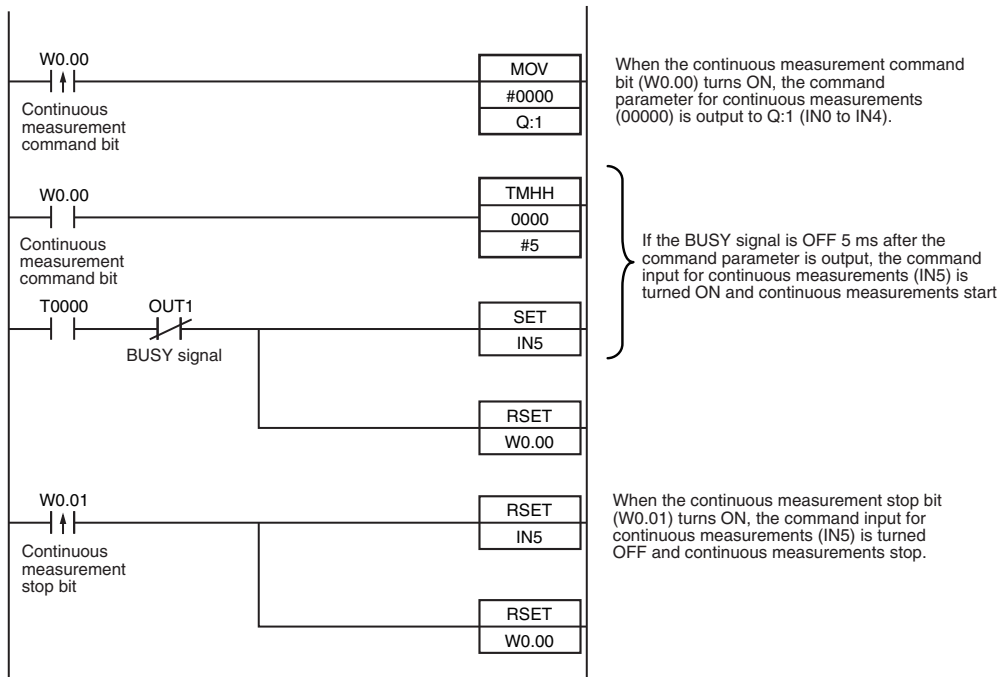

• I/O Signal Allocations

Signal		Address
Output signals	OUT1 (BUSY signal)	CIO 0.01
Input signals	IN0	CIO 1.08
	IN1	CIO 1.09
	IN2	CIO 1.10
	IN3	CIO 1.11
	IN4	CIO 1.12
	IN5	CIO 1.15

Setting the Outputs

Using the Overall Judgement Result

When the results of the inspection items are judged, if even one individual judgement result is NG, the OR output signal is turned ON.

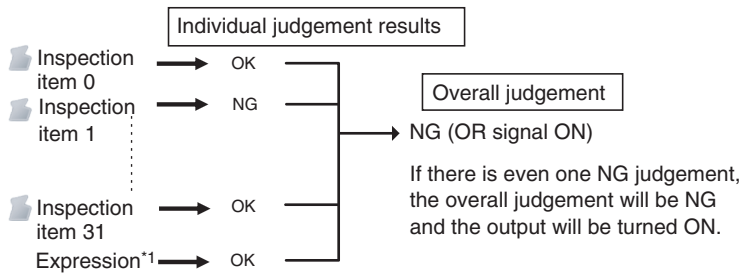

*1: When judgement results from calculations are set to be reflected in overall judgement.

Note

The overall judgement result output signal can also be turned ON when all individual judgement results are OK.

Changing the judgement output ON condition: p. 128

Wiring

Color	Signal	Description
Black	OUT0 (OR)	Overall judgement (default assignment)

The signals shown at the left are used. Refer to the following information for signal wiring.

2-4 Wiring: p. 27

Timing Chart

The OR signal that is output is held until the next overall judgement is output.

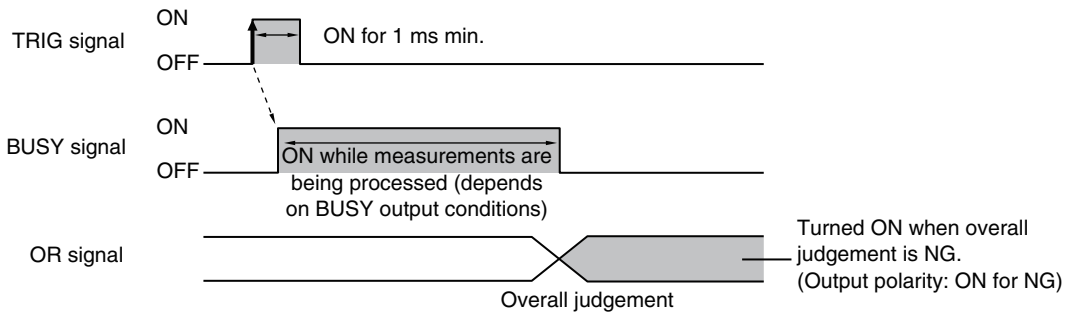

Note

The timing for updating the OR signal and the ON time after judgement processing can be adjusted.



Adjusting the judgement output timing: p. 126

Obtaining Individual Judgement Results

Up to three judgement results of individual inspection items (individual judgement signals OR0 to OR31) can be assigned to terminals OUT0 to OUT2 and output to external devices.

Output terminal	Output signals that can be assigned
OUT0	<ul style="list-style-type: none"> OR (Total judgement)...(default) OR0 (Item 0 judgement) to OR31 (Item 31 judgement)
OUT1	<ul style="list-style-type: none"> BUSY (default) OR0 (Item 0 judgement) to OR31 (Item 31 judgement)
OUT2	<ul style="list-style-type: none"> ERROR (default) OR0 (Item 0 judgement) to OR31 (Item 31 judgement)

Wiring

Example: Signals are assigned to terminals OUT0 to OUT2 as shown below.

- OUT0: Inspection number 2 (OR2)
- OUT1: Inspection number 5 (OR5)
- OUT2: Inspection number 14 (OR14)

Color	Signal	Description
Black	OUT0 (OR2)	Outputs the judgement for OR2.
Orange	OUT1 (OR5)	Outputs the judgement for OR5.
Light blue	OUT2 (OR14)	Outputs the judgement for OR14.

The signals shown at the left are used.

Refer to the following information for signal wiring.



2-4 Wiring: p. 27

As described above, if terminals OUT0 to OUT2 are all assigned to individual judgement output signals, the BUSY signal and ERROR signal assigned as the default settings will no longer be output.

Timing Chart

Output OR0 to OR31 signals are held until the next judgement output.

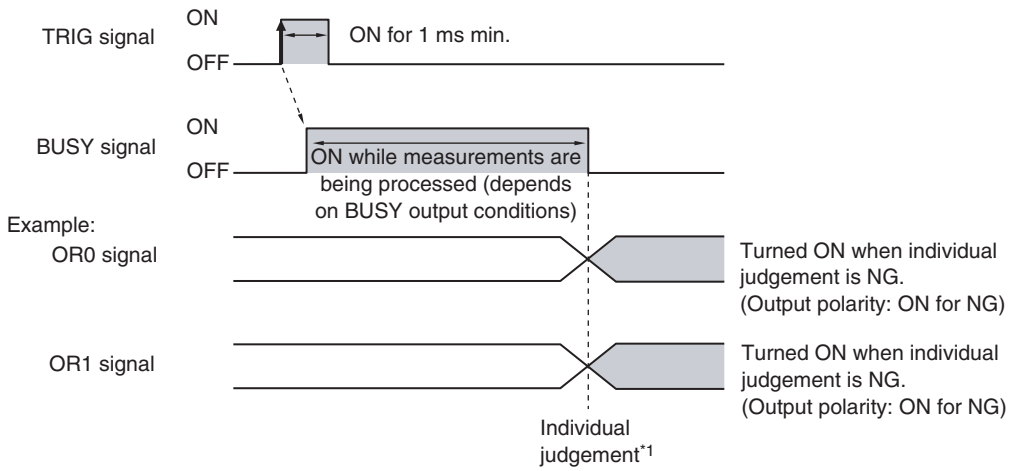

*1: The timing for updating the OR signal is when the measurement results are finalized, regardless of the output settings of the BUSY signal (BUSY output conditions).

Note

The timing for updating the OR0 to OR31 signals and the ON time after judgement processing can be changed.

Adjusting the judgement output timing: p. 126

Settings

► [In/Out] – [I/O setting] – [I/O terminals] – [Output]

- 1** Press [OUT0].
- 2** Press [OR2 (Item 2 judgement)].
OR2 output signal was assigned to OUT0.
- 3** Assign the others in the following manner.
OUT1: OR5
OUT2: OR14

Adjusting the Judgement Output Timing

The output timing of the OR signal or OR0 to OR31 signals can be selected from two modes depending on the external device.

Selecting the OFF Timing

- Level output (default)

The status of the output OR signal is held until the next OR signal is output.

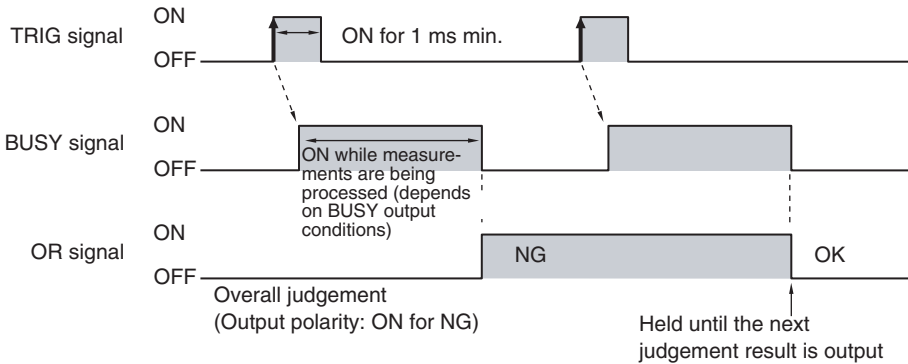

- One-shot output

The status of the output OR signal is turned OFF after a specified time has passed. (Setting range: 0 to 1,000 ms)

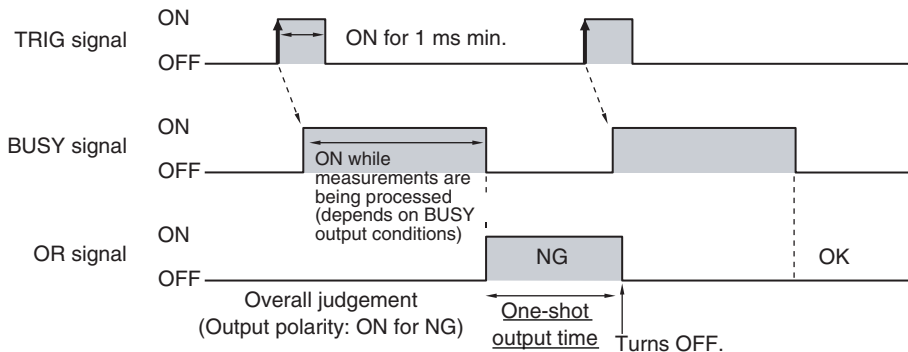

Delaying the Output Timing

When using one-shot output, the output timing of the OR signal can be delayed. (Setting range: 0 to 1,000 ms)

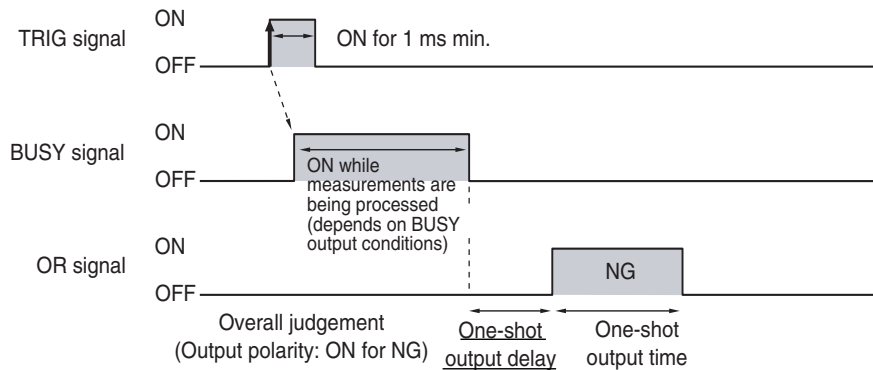

Settings

► [In/Out] – [I/O setting] – [I/O terminals] – [Output]

- 1 Press [Output mode] and press [Level output] or [One-shot output].
- 2 Press [Output delay] and set the one-shot output delay.
- 3 Press [OK].



- 4 Press [Output time] and set the one-shot output time.
- 5 Press [OK].

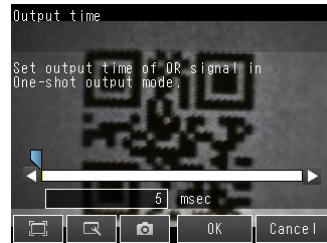

Item		Description
Output mode	One-shot output	After the measurement results are finalized, if the judgement output ON condition is met, the OR signal is turned ON for the one-shot output time. It is then turned OFF once the specified time has expired.
	Level output (default)	The judgement is output after measurement results are finalized and the ON/OFF status of the OR signal is held until it is changed for the next measurement result.
Output delay		When one-shot output mode is selected, this parameter sets the delay from when a measurement is completed until when the OR signal turns ON. (Setting range: 0 to 1,000 ms)
Output time		When one-shot output mode is selected, this parameter sets the time that the OR signal is ON. (Setting range: 1 to 1,000 ms)

Important

When one-shot output is selected as the output mode, make the following value smaller than the trigger input period.

- One-shot delay time + One-shot output time

Changing the Judgement Output ON Conditions

The ON condition for the OR signal or the OR0 to OR31 signals can be set to be output when the judgement results are OK or when they are NG. The default setting is when they are NG.

Settings

► [In/Out] – [I/O setting] – [I/O terminals] – [Output] – [Output polarity]

Item		Description
Output polarity	OK: ON	The output is turned ON if the judgement is OK. For the overall judgement, the output is turned ON if all judgements are OK.
	NG: ON (default)	The output is turned ON if the judgement is NG. For the overall judgement, the output is turned ON if even one judgements is NG.

Changing the Polarity of the BUSY Output

The Sensor turns ON the BUSY output signal during measurements and other processing to indicate that a measurement trigger cannot be received. The polarity of the BUSY signal can be reversed so that it is ON only when a trigger signal can be received.

Settings

► [In/Out] – [I/O setting] – [I/O terminals] – [Output] – [BUSY polarity]

Item		Description
BUSY polarity	BUSY: ON (default)	The BUSY signal is ON while the Sensor is processing data.
	READY: ON	The BUSY signal is ON while the Sensor can receive a trigger signal.

Important

All timing charts in this manual show the operation of the BUSY signal at the default setting. If you change the polarity of the BUSY signal, take this into consideration when reading the timing charts.

Changing the BUSY Output Condition

The end timing of the BUSY signal can be changed.

► [In/Out] – [I/O setting] – [I/O terminals] – [Output] Tab Page – [BUSY output]

Item		Description
BUSY output	Measurement (default)	The BUSY signal turns OFF when the measurement is completed.
	Data logging	The BUSY signal turns OFF when data logging is completed.
	Image logging	The BUSY signal turns OFF when image logging is completed.
	Result display	The BUSY signal turns OFF when the result display is completed.

Controlling the Sensor from an External Device

The following Sensor functions can be controlled with command inputs from an external device without connecting the Touch Finder.

Function	Description	Reference
Switching the scene	This command changes the scene when the line process changes.	p. 129
Clearing an error	This command turns the ERROR signal OFF.	p. 131
Continuous measurement	Continuous measurement is performed while this command is input.	p. 121
Automatic teaching	This command performs automatic teaching of bar codes and 2D-codes.	p. 132

Changing the Scene

This section describes how to change the line process by changing the scene.

Wiring

Color	Signal	State		Description
		Input Mode		
		Standard Mode	Expanded Mode	
Gray	IN0	Scene number (0 to 31)	Scene number (0 to 15)	Specifies the scene number.
Green	IN1			
Red	IN2			
White	IN3			
Purple	IN4			
Yellow	IN5	ON		Trigger to change the scene
Orange	OUT1 (BUSY)	--		Processing in progress (default)

The signals shown at the left are used. Refer to the following information for signal wiring.



2-4 Wiring: p. 27

Timing Chart

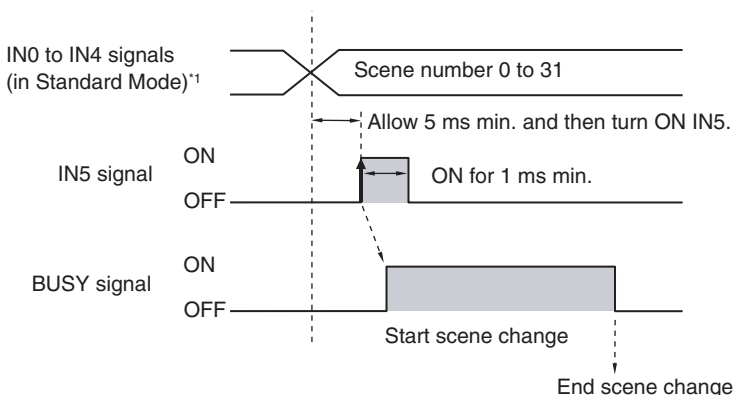

*1: In Expanded Mode, specify scene numbers 0 to 15 using the IN0 to IN3 signals.

- 1 Specify the scene number with the IN0 to IN4 signals. (Standard Mode)
- 2 Turn ON the IN5 signal while the BUSY signal is ON to change the scene to the specified scene.
- 3 The BUSY signal turns ON while the scene is being switched.

Settings

► [In/Out] – [I/O setting] – [I/O terminals] – [Input] – [Input mode]

The scene numbers that can be used depend on the input mode.

[Standard mode] (default): Scene 0 to 31

[Expanded mode]: Scene 0 to 15

Sample Ladder Program

This sample program is used to change the scene when the input mode is set to Expanded Mode. The scene changes to scene 1 when W0.00 turns ON.

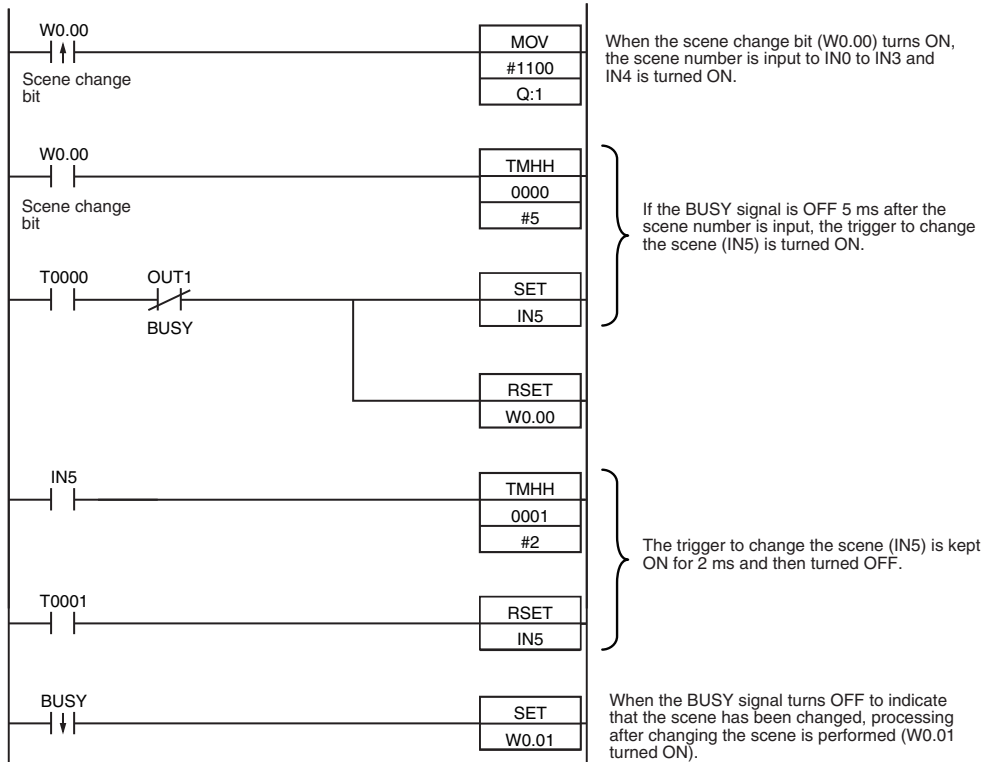

• I/O Signal Allocations

Signal		Address
Output signals	OUT1 (BUSY signal)	CIO 0.01
Input signals	IN0	CIO 1.08
	IN1	CIO 1.09
	IN2	CIO 1.10
	IN3	CIO 1.11
	IN4	CIO 1.12
	IN5	CIO 1.15

Note

The BUSY signal will be ON while the scene it being changed.

Important

If the cycle time is too long, the PLC may not be able to detect when the BUSY signal is ON. If necessary, turn OFF W0.00 after a suitable time elapses.

Turning the ERROR Signal OFF

The ERROR signal turns ON when an error occurs.

After removing the cause of the error, turn the ERROR signal OFF using one of the following methods.

Method 1: Input an error clear command from an external device such as a PLC.

Method 2: Input a measurement trigger again.

(For example, turn the TRIG signal ON during a one-shot measurement.)

The ERROR signal will turn OFF when measurement is executed correctly.

Note

This function can be used in Run Mode only.

Settings

► **[In/Out] – [I/O setting] – [I/O terminals] – [Input] – [Input mode]**

Press [Expand mode].

Wiring

Color	Signal	State	Description
Gray	IN0	OFF	Command parameter for clearing errors
Green	IN1	OFF	
Red	IN2	ON	
White	IN3	OFF	
Purple	IN4	OFF	
Yellow	IN5	ON	Command input for clearing errors
Orange	OUT1 (BUSY)	--	Processing in progress (default)
Light blue	OUT2 (ERROR)	--	ERROR signal (default)

The signals shown at the left are used.

Refer to the following information for signal wiring.



2-4 Wiring: p. 27

Timing Chart

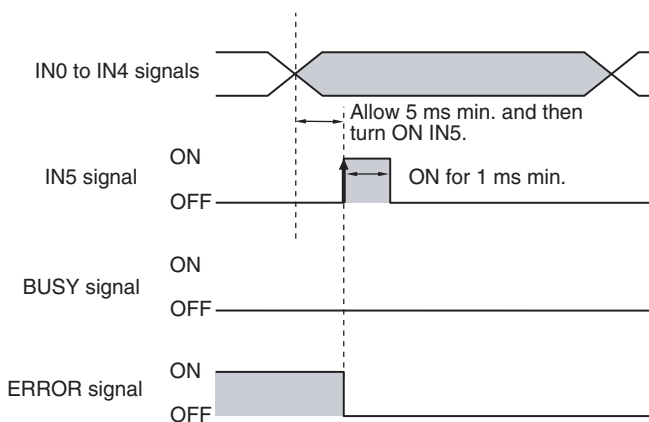

1 Turn OFF IN0 to IN1 and IN3 to IN4 and turn ON IN2.

2 Turn ON the IN5 signal while the BUSY signal is OFF to clear the error.

Performing Automatic Teaching

The bar code and 2D-code parameters can be automatically set with commands from an external device, such as a PLC, based on the image that was just input when the line process was changed.

Inspection item	Re-registered data
Bar code	Code type, read direction selection, reverse on/off
2D-code	Code type, reverse, code color (DataMatrix, PDF417 only), shape (DataMatrix)

Note

- Application is possibly only from the Run Mode.
- If the parameter is applicable to more than one inspection item, automatic teaching will be performed for all applicable inspection items.
- While master data is registered with teaching during an automatic registration from a display, no master data is registered with automatic teaching by IN1.

Settings

▶ **[In/Out] - [I/O setting] - [I/O terminals] - [Input] - [Input mode]**

Press [Expand mode].

Wiring

Color	Signal	State	Description
Gray	IN0	OFF	Command parameter for automatic teaching
Green	IN1	ON	
Red	IN2	OFF	
White	IN3	OFF	
Purple	IN4	OFF	
Yellow	IN5	ON	Command input for automatic teaching
Yellow	OUT1 (BUSY)	--	Processing in progress (default)

The signals shown at the left are used.

Refer to the following information for signal wiring.

 2-4 Wiring: p. 27

Timing Chart

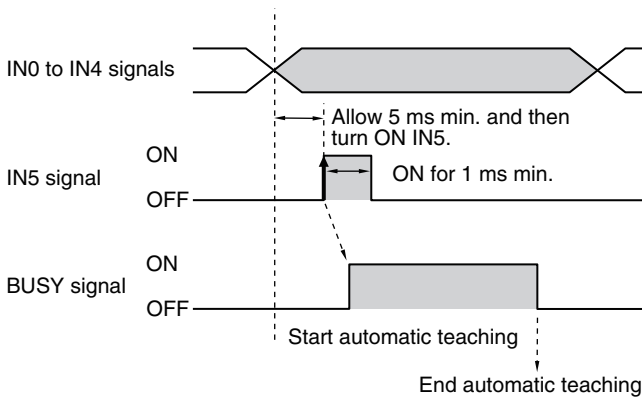

- 1 Turn OFF IN0, IN2 to IN4 and turn ON IN1.
- 2 Turn ON the IN5 signal while the BUSY signal is OFF to perform automatic teaching from the image that was just input.
- 3 The BUSY signal turns ON while the automatic teaching is being performed.

Sample Ladder Program

This sample program is used to input IN5 for automatic teaching.

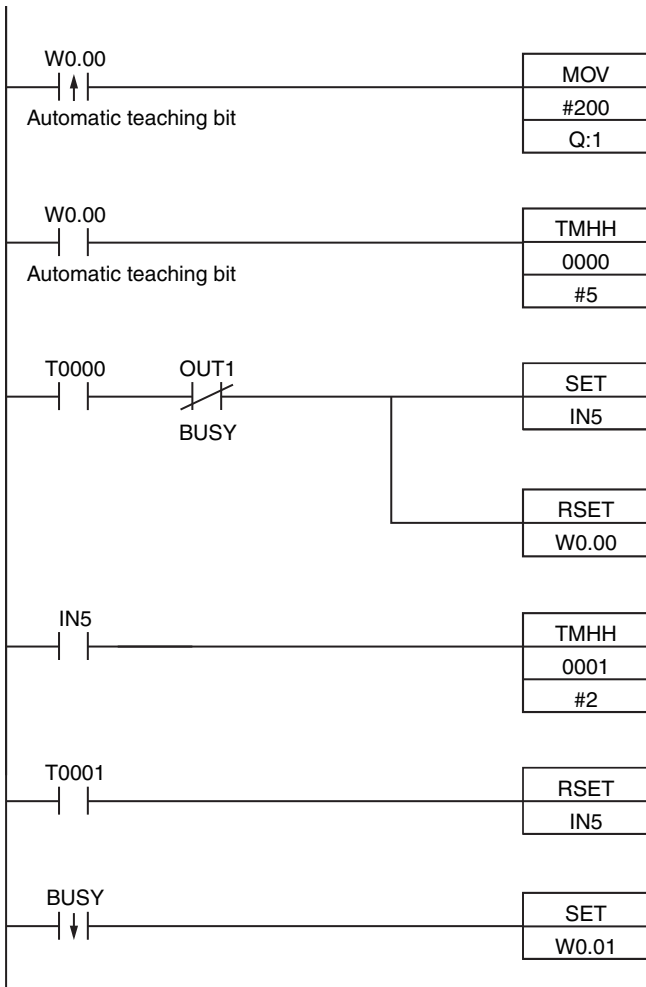

When the automatic teaching bit (W0.00) turns ON, IN1 is turned ON.

If the BUSY signal is OFF 5 ms after IN1 turns ON, the trigger for automatic teaching (IN5) is turned ON.

The trigger for automatic teaching (IN5) is kept ON for 2 ms and then turned OFF.

When the BUSY signal turns OFF to indicate that automatic teaching is completed, processing after automatic teaching is performed (W0.01 turned ON).

•I/O Signal Allocations

Signal		Address
Output signals	OUT1 (BUSY signal)	CIO 0.01
Input signals	IN0	CIO 1.08
	IN1	CIO 1.09
	IN2	CIO 1.10
	IN3	CIO 1.11
	IN4	CIO 1.12
	IN5	CIO 1.15

Note

The BUSY signal will be ON while the automatic teaching is being performed.

Important

If the cycle time is too long, the PLC may not be able to detect when the BUSY signal is ON. If necessary, turn OFF W0.00 after a suitable time elapses.

8-2 Outputting/Controlling with Ethernet

Data can be input and output to external devices via Ethernet (TCP communications). The two methods are described below.

- No-protocol Data Output

Data that is already specified for output is automatically output from the Sensor to Ethernet when an overall judgement result is output. Up to 32 data can be output in the specified format (ASCII format or binary format).



- No-protocol Command/Response Method

The external device sends a command to the Sensor and receives a response from the Sensor.

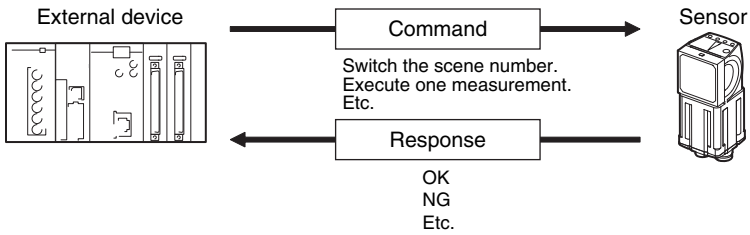

Connections

Connect the Switching Hub and PLC using an FQ-WN□□ Special Ethernet Cable.

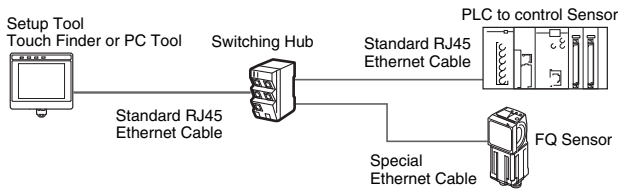

Important

When connecting more than one Sensor, set the IP addresses so that the same IP address is not used for more than one Sensor.

Setting Network Settings in the Sensor

This section describes how to set the IP address and other network settings in the Vision Sensor. Refer to the following section for details.

 2-5 Setting Up Ethernet: p. 32

Note

The port number is always 9876.

Setting the Data to Output via Ethernet

Allocate the data to output via Ethernet according to the output method for the Ethernet as shown below.

- No-protocol Command/Response Method

When executing one-shot measurements and continuous measurements with commands (MEASURE or M, MEASURE/C or M/C), set the data to output via Ethernet as a response.

- No-protocol Data Output

Set in advance the data to output via Ethernet after the measurements (32 max.).

Data That Can Be Output

Up to 32 data can be output (data 0 to data 31). The measurement data from position compensation and inspection items that can be output and the results from the expression settings can be output. For data that can be output, refer to the *Measurement Data That Can Be Used for External Outputs and Calculations* for each inspection item.

Allocating Output Data

Allocate Ethernet output data to data 0 to 31. This section describes the setting procedure when the num. of characters of [0.2D-code] is output to data 0.

► [In/Out] – [I/O setting] – [Ethernet] – [Output data set]

1 Press [0. Data 0].

2 Press [Settings].

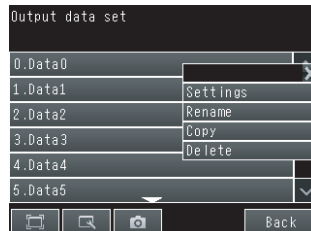

3 Press [0.2D-code].



4 Press [Num. of char. N].



This process is repeated to register data 1 or higher. The settings are enabled after restarting the Sensor.

Note

Measurement data of inspection items for which logging is not supported can be logged by using the Ethernet output settings. Set the measurement data of inspection items for which logging is not supported as calculation parameters using the Calculation menu command, and use them as the calculation results. Allocate the results to Ethernet outputs. In this way, measurement data can be logged as calculation results.

Outputting Data to an External Device Using No-protocol Communications

Setting the Data To Output Automatically

Refer to *Setting the Data to Output via Ethernet*.

Setting the Data Format

▶ **[In/Out] – [I/O setting] – [Ethernet]**

- 1** Press [Output form].
- 2** Set the output format to ASCII or binary.
- 3** Set the data format.

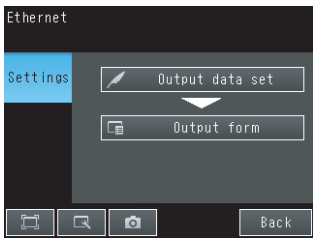

• **When Output Format Is ASCII**

Set the parameters for integer digits, decimal digits, negative numbers, 0 suppression, the field separator, and the record separator.

• **Output Format**

Measured value of data 0	,	Measured value of data 1	,	...	Measured value of data 7	CR
--------------------------	---	--------------------------	---	-----	--------------------------	----

Note

The data output method, digits, and data separators can be changed as needed.

Example: Integer digits: 5, decimal digits: 3, negative number expression: -, field separator: comma, record separator: CR

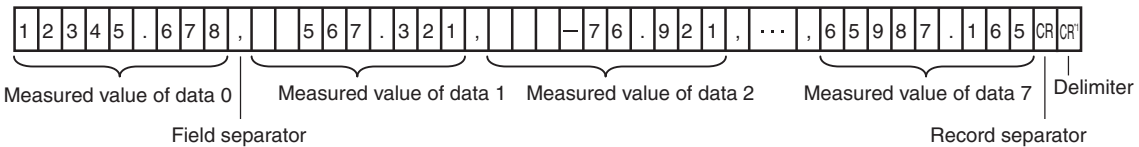

*1 Because the record separator is set to CR, only one record is output for each measurement. A blank line (CR: delimiter) will therefore be entered after the record separator. If you do not want a blank line, set the record separator to None.

Note

The field separator is not output unless the data continues.

The following range of values can be output.

$$-999,999,999.9999 \leq \text{Measured value} \leq 999,999,999.9999$$

If the measured value is lower than $-999,999,999.9999$, then $-999,999,999.9999$ is output.

If the measured value is higher than $999,999,999.9999$, then $999,999,999.9999$ is output.

The following values are output if JG (Judge) is set.

- OK: 0
- NG: -1

Note

Data that is output after measurement is output until the last data even after the measurement is finished. Data output is not interrupted midway.

• When Output Format Is Binary

- Set the numerical expression.
- Select either fixed decimal or floating-point decimal.

• Output Format

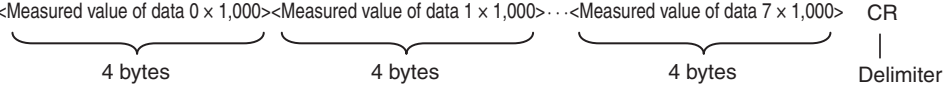

The measurement data multiplied by 1,000 is output continuously at 4 bytes per data. Negative numbers are output as two's complements.

Example: When Data 0 Is 256.324 and Data 1 Is -1.000.

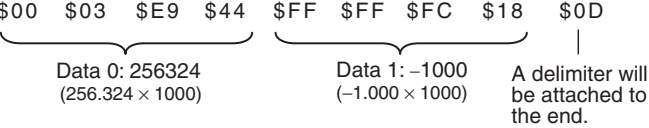

Note

Binary output does not use data separators, i.e., field separators or record separators. These separators are used only for ASCII output.

The following range of values can be output.

$$-2,147,483.648 \leq \text{Measured value} \leq 2,147,483.647$$

If the measured value is lower than $-2,147,483.648$, then $-2,147,483.648$ is output.

If the measured value is higher than $2,147,483.648$, then $2,147,483.648$ is output.

The following values are output if JG (Judge) is set.

- OK: 0 (0×1000)
- NG: -1000 (-1×1000)

Note

Data that is output after measurement is output until the last data even after the measurement is finished. Data output is not interrupted midway.

Command Format

This section describes the command format for no-protocol communications.

Commands defined in the command list can be used.

Set commands and parameters in ASCII.

If the command has an argument parameter, set the parameter after inserting a space (0x20).

If it has multiple parameters, insert a space before each parameter.

Place a delimiter at the end of the command. No space is required before the delimiter.

The delimiter is always CR.

<Command Format>

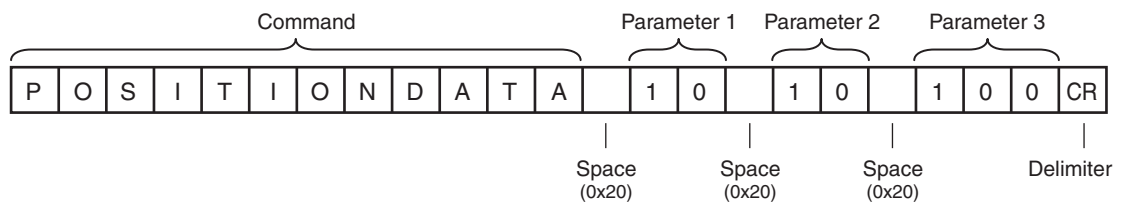

<Response Format>

If a parameter is attached, the parameter and delimiter are output when the command is processed normally, and the command execution result is OK. A delimiter is inserted at the end of the response.

The delimiter is always CR.

Command Execution Result

Parameter

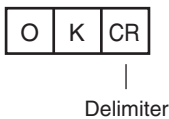
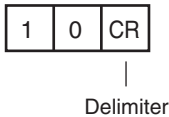

If the command is not processed normally, the command execution result is NG.

Command Execution Result

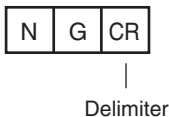

An error occurs in the following cases.

- A non-existent command was specified.
- The number of parameters is incorrect.
- The parameter range is incorrect.
- The parameter content is incorrect.
- Operation could not be performed normally for the operation command.

Command List

The following table lists the no-protocol commands.

Commands that can be used in no-protocol Ethernet communications are listed below.

Type of command	Command	Abbreviation	Function	Reference
Scene control commands	SCENE	S	Acquires the current scene number.	p. 142
	SCENE <i>Scene_number</i>	S <i>Scene_number</i>	Changes the scene number being used.	p. 143
Measurement control commands	MEASURE	M	Executes one measurement.	p. 144
	MEASURE/C	M/C	Starts continuous measurements.	p. 145
	MEASURE/E	M/E	Ends continuous measurements.	p. 146
Data acquisition/setting commands	POSITIONDATA <i>External_reference_data_number</i>	PD <i>External_reference_data_number</i>	Acquires the position compensation data.	p. 147
	POSITIONDATA <i>External_reference_data_number</i> <i>Set_value</i>	PD <i>External_reference_data_number</i> <i>Set_value</i>	Sets the position compensation data.	p. 148
	ITEMDATA <i>Inspection_item_number</i> <i>External_reference_data_number</i>	ID <i>Inspection_item_number</i> <i>External_reference_data_number</i>	Acquires the inspection item data.	p. 149
	ITEMDATA <i>Inspection_item_number</i> <i>External_reference_data_number</i> <i>Set_value</i>	ID <i>Inspection_item_number</i> <i>External_reference_data_number</i> <i>Set_value</i>	Sets the inspection item data.	p. 150
	ITEMDATA2 <i>Inspection_item_number</i> <i>External_reference_data_number</i>	ID2 <i>Inspection_item_number</i> <i>External_reference_data_number</i>	Acquires the text string data of the specified inspection item.	p. 151
	ITEMDATA2 <i>Inspection_item_number</i> <i>External_reference_data_number</i> <i>Text_strings</i>	ID2 <i>Inspection_item_number</i> <i>External_reference_data_number</i> <i>Text_strings</i>	Sets the text string data of the specified inspection item.	p. 152
Setting acquisition command	VERGET/S	None	Acquires the version information of the Sensor software.	p. 153
	VERGET/H	None	Acquires the Sensor model information.	p. 154
	ERRGET	None	Acquires the latest error code of the Sensor.	p. 155
Utility commands	CLRMEAS	None	Clears the measurement values.	p. 156
	CLRERR	None	Clears the error output status (error signal and error indicator).	p. 157
	RESET	None	Restarts the Sensor.	p. 158

Command Details

Scene Control Commands

● SCENE or S

Acquire Scene Number

This command acquires the scene number currently being used.

<Command Format>

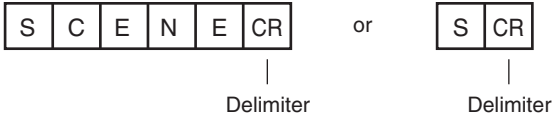

<Response Format>

When the Command Is Processed Normally

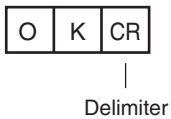
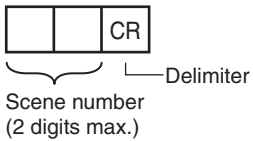

When the Command Is Not Processed Normally

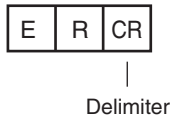

<Parameter Descriptions>

Scene number	The acquired scene number (currently used scene number) is returned.
--------------	--

Example:

When Scene 0 Is Being Used

<Command>



<Response>

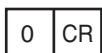

Change Scene Number

This command changes the scene number to use.

<Command Format>

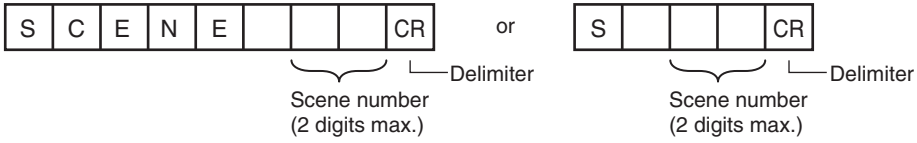

<Response Format>

When the Command Is Processed Normally

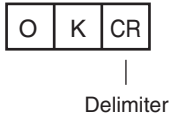

When the Command Is Not Processed Normally

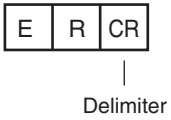

<Parameter Descriptions>

Scene number	Specifies the scene number (0 to 31) to change to.
--------------	--

Measurement Control and Measurement Acquisition Commands

● MEASURE or M

Execute Measurement

This command executes one measurement.

If Ethernet output is not set, only the measurement is performed.

If Ethernet output is set, the measurement is performed and the result is returned as response data.

<Command Format>



<Response Format>

When the Command Is Processed Normally



|
Delimiter

When the Command Is Not Processed Normally



|
Delimiter

<Parameter Descriptions>

Measurement result	<p>The measurement result is output as the response when Ethernet output is set. The measurement result is not output when Ethernet output is not set.</p> <p> Reference: <i>Setting the Data to Output via Ethernet</i> (p. 137)</p>
--------------------	--

Start Continuous Measurements

This command starts continuous measurements.

If Ethernet output is not set, only continuous measurement is performed.

If Ethernet output is set, continuous measurement is performed and the results corresponding to the number of measurements made are returned as response data.

<Command Format>

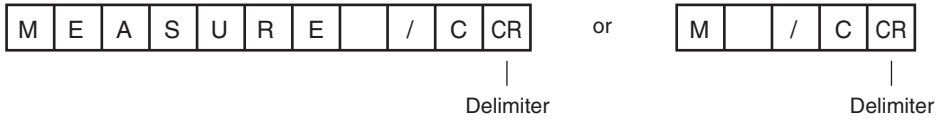

<Response Format>

When the Command Is Processed Normally

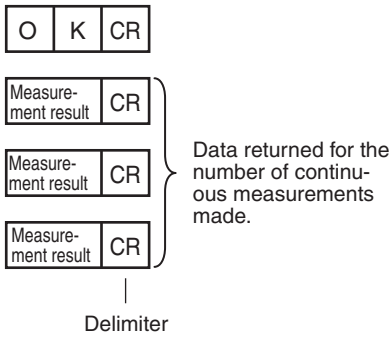

When the Command Is Not Processed Normally

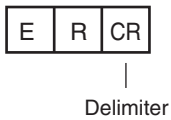

<Parameter Descriptions>

Measurement result	<p>The measurement results corresponding to the number of measurements made are output when Ethernet output is set.</p> <p>The measurement result is not output when Ethernet output is not set.</p> <p> Reference: <i>Setting the Data to Output via Ethernet</i> (p. 137)</p>
--------------------	--

End Continuous Measurements

The command ends continuous measurements.

<Command Format>

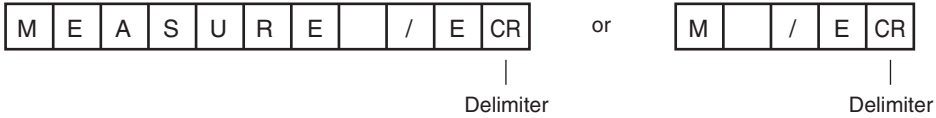

<Response Format>

When the Command Is Processed Normally

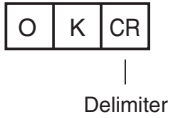

When the Command Is Not Processed Normally

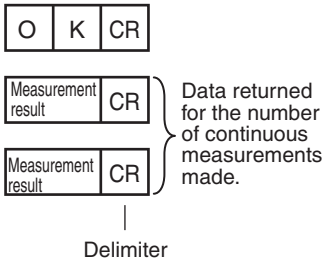

Note

Set the Ethernet output to output measurement results.
If Ethernet output is not set, only the command response is output.

 Reference: *Setting the Data to Output via Ethernet* (p. 137)

Data Acquisition/Setting Commands

● POSITIONDATA or PD

Acquire Position Compensation Data

The command acquires position compensation parameters and measurement values.

<Command Format>

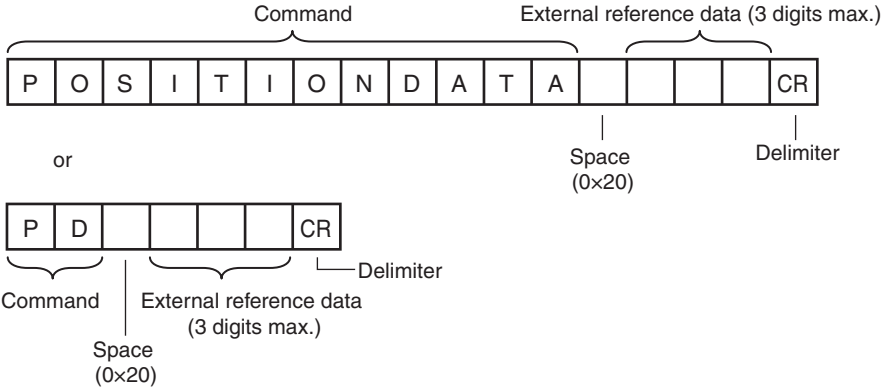

<Response Format>

When the Command Is Processed Normally

Acquired value	CR
----------------	----

O	K	CR
---	---	----

Delimiter

When the Command Is Not Processed Normally

E	R	CR
---	---	----

Delimiter

<Parameter Descriptions>

Data number	Specifies the data number. Refer to 10-2 External Reference Parameters (p. 178) for details.
Acquired value	The position compensation data and threshold value are returned. Refer to 10-2 External Reference Parameters (p. 178) for details.

Sets the Position Compensation Data.

The command sets position compensation parameters and measurement values.

<Command Format>

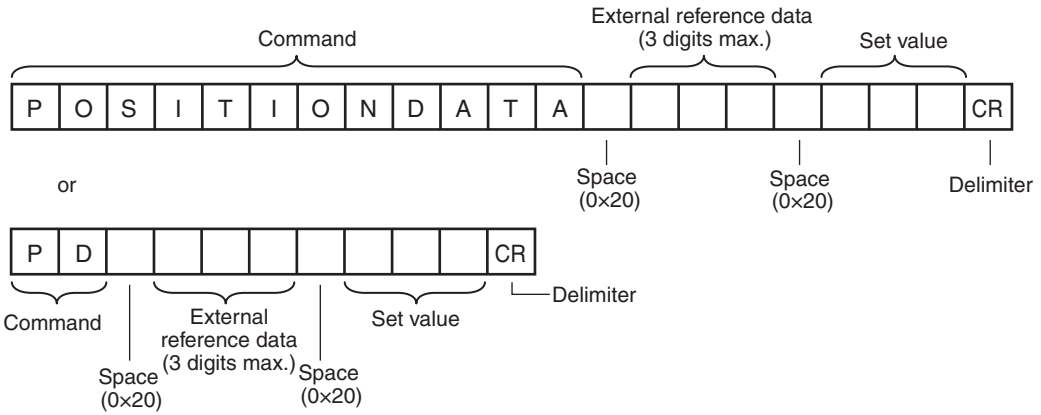

<Response Format>

When the Command Is Processed Normally

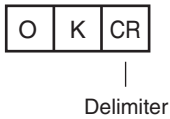

When the Command Is Not Processed Normally

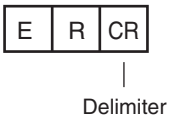

<Parameter Descriptions>

External reference data number	Specifies the external reference data number. Refer to 10-2 External Reference Parameters (p. 178) for details.
Setting	Specifies the set value. Refer to 10-2 External Reference Parameters (p. 178) for details.

● ITEM DATA or ID

Acquire Inspection Item Data

This command acquires the parameters and measurement values of the specified inspection item.

<Command Format>

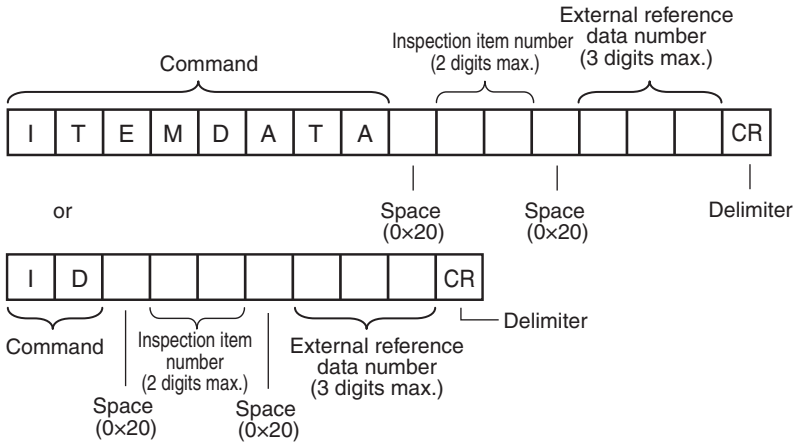

<Response Format>

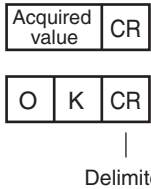

When the Command Is Processed Normally

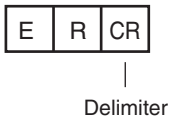

When the Command Is Not Processed Normally



<Parameter Descriptions>

Inspection item number	Specifies the inspection item number. (0 to 31)
External reference data number	Specifies the external reference data number. (0 to 999)  Refer to <i>10-2 External Reference Parameters</i> (p. 178) for details.
Acquired value	Returns the data for the specified inspection item.  Refer to <i>10-2 External Reference Parameters</i> (p. 178) for details.

Set Inspection Item Data

This command sets the parameters and measurement values of the specified inspection item.

<Command Format>

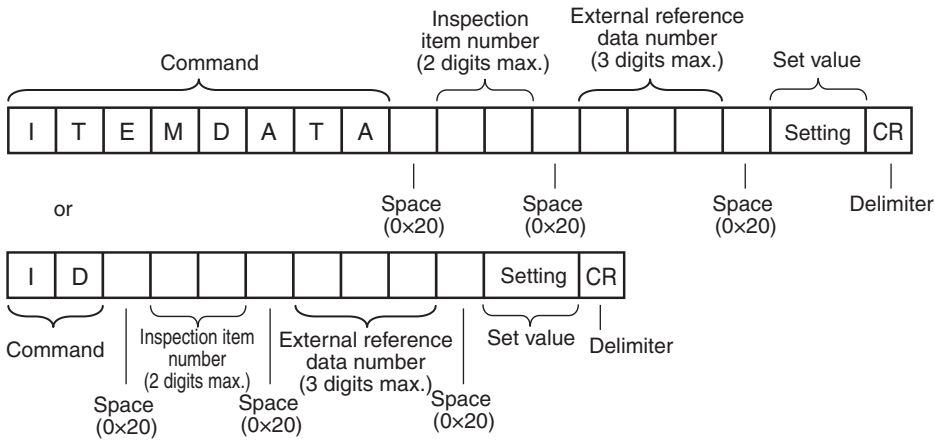

<Response Format>

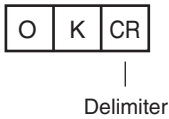

When the Command Is Processed Normally

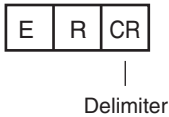

When the Command Is Not Processed Normally



<Parameter Descriptions>

Inspection item number	Specifies the inspection item number. (0 to 31)
External reference data number	Specifies the external reference data number. (0 to 999)  Refer to <i>10-2 External Reference Parameters</i> (p. 178) for details.
Acquired value	Returns the data for the specified inspection item.  Refer to <i>10-2 External Reference Parameters</i> (p. 178) for details.

● ITEM DATA 2 command or ID2

Acquire Inspection Item Text String Data

This command acquires the text string data of the specified inspection item.

<Command Format>

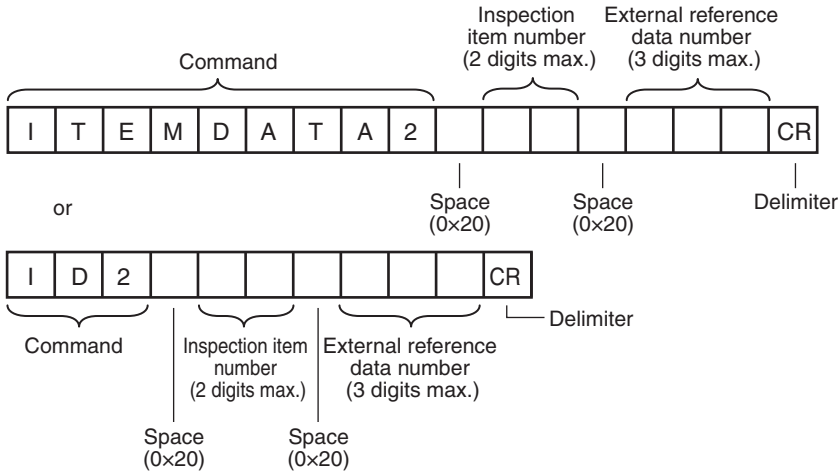

<Response Format>

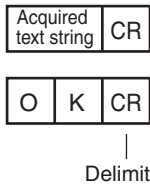

When the Command Is Processed Normally

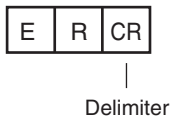

When the Command Is Not Processed Normally



<Parameter Descriptions>

Inspection item number	Specifies the inspection item number. (0 to 31)
External reference data number	Specifies the external reference data number. (0 to 999)  Refer to 10-2 External Reference Parameters (p. 178) for details.
Acquired text string	Returns the text string data for the specified inspection item.  Refer to 10-2 External Reference Parameters (p. 178) for details.

Set Inspection Item Text String Data

This command sets the text string data for the specified inspection item.

<Command Format>

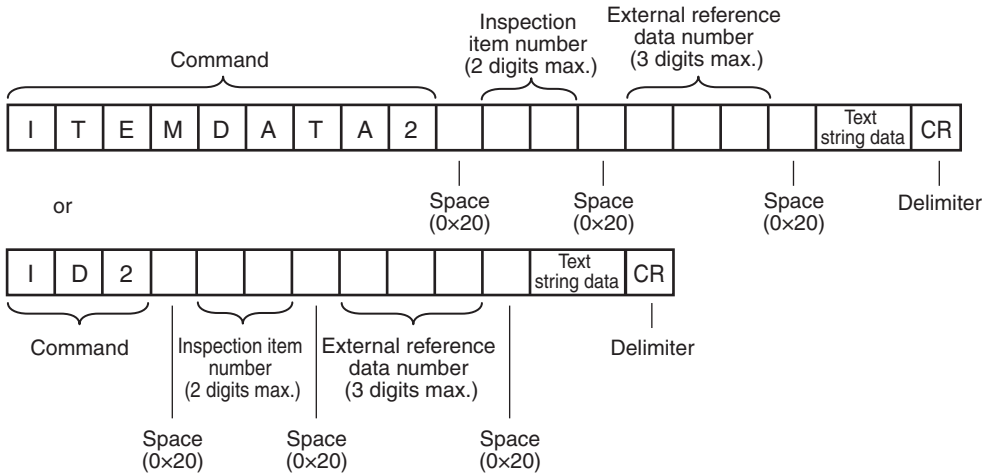

<Response Format>

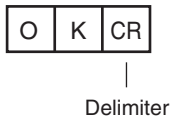

When the Command Is Processed Normally

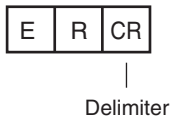

When the Command Is Not Processed Normally



<Parameter Descriptions>

Inspection item number	Specifies the inspection item number. (0 to 31)
External reference data number	Specifies the external reference data number. (0 to 999)  Refer to <i>10-2 External Reference Parameters</i> (p. 178) for details.
Text string data	Specifies the text string data for the specified inspection item.  Refer to <i>10-2 External Reference Parameters</i> (p. 178) for details.

● VERGET

Acquire Software Version

This command acquires the version information of the Sensor software.

<Command Format>

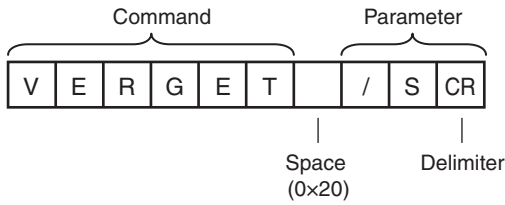

<Response Format>

When the Command Is Processed Normally

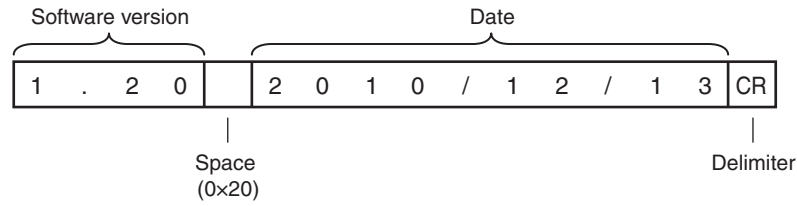

Delimiter

When the Command Is Not Processed Normally



Delimiter

<Parameter Descriptions>

Software version	Returns the software version. Example: When the software version is 1.20, the response is 1.20.
Date	Returns the date. Example: When the date is 13 December 2010, the response is 2010/12/13.

Acquire Sensor Model

This command acquires the Sensor model.

<Command Format>

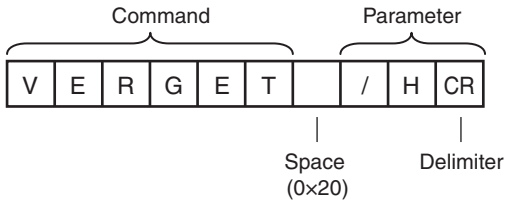

<Response Format>

When the Command Is Processed Normally

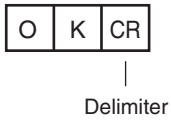
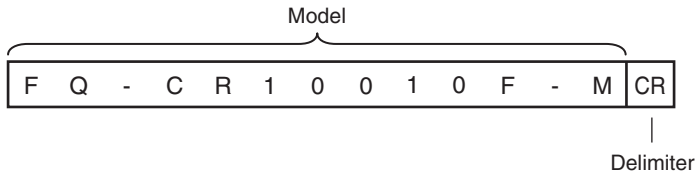

When the Command Is Not Processed Normally

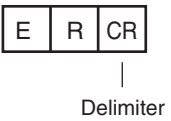

<Parameter Descriptions>

Model	Returns the model. Example: When the model is FQ-CR10010F-M, the response is FQ-CR10010F-M.
-------	--

● ERRGET

Acquire Error Information

This command acquires the latest error code from the Sensor.

<Command Format>

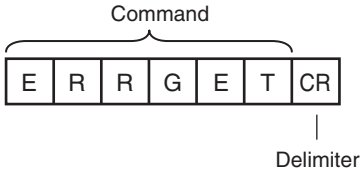

<Response Format>

When the Command Is Processed Normally

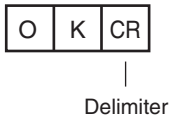
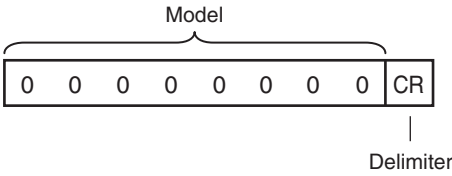

When the Command Is Not Processed Normally

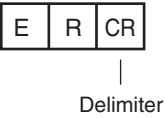

<Parameter Descriptions>

Error code	Returns the latest error code. If there is no error history, the response is 00000000.  Refer to <i>9-1 Error Table</i> (p. 162) for details.
------------	---

● CLRMEAS

Clear Measurement Values

This command clears the measurement values.

<Command Format>

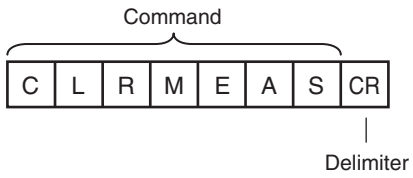

<Response Format>

When the Command Is Processed Normally

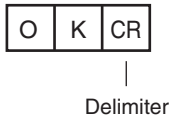

When the Command Is Not Processed Normally

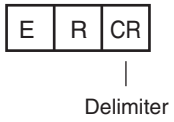

● CLRERR

Clear Errors

This command clears the error output status (error output and error indicator).

<Command Format>

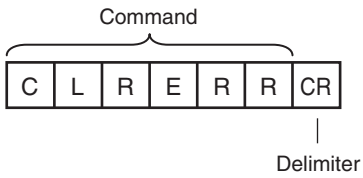

<Response Format>

When the Command Is Processed Normally

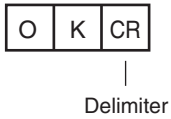

When the Command Is Not Processed Normally

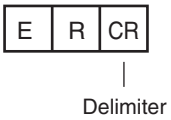

● RESET

Restarts the Sensor.

This command restarts the Sensor.

<Command Format>

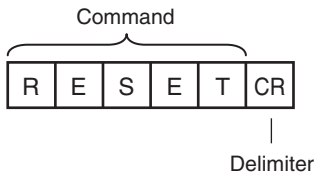

<Response Format>

When the Command Is Processed Normally

If process is completed normally, the Sensor is restarted. There is therefore no response.

When the Command Is Not Processed Normally

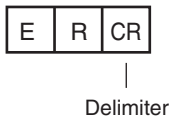

Communications Example

An example of the communications log when a computer is connected and communications is performed with a no-protocol command from a terminal application is shown below.

Example 1: Changing Scenes (Scene number 1 is specified.)

```
S_1
  |
  |-----Space
OK
```

Example 2: Acquiring inspection item data (Acquires the 2D-code judgement result registered to inspection item 10)

```
ITEMDATA_10 0
  |
  |-----Space
0
OK
```

Example 3: Measurement when Ethernet Output Is Not Set

```
M
OK
```

Example 4: Measurement when Ethernet Output Is Set

```
M
OK
    1.0000      0.0000      0.0000      306.0000
M
OK
    2.0000      0.0000      0.0000      0.0000
```

MEMO

Troubleshooting

9-1 Error Table.....	162
9-2 Basic Troubleshooting.....	164



9-1 Error Table

Error History

Up to 100 errors will be stored in the error history in the Sensor or Touch Finder.

This section describes the causes of and measures for errors that are stored in the error history.

Errors Stored in the Error History

Error in error history	Cause	Points to check	Measures to perform
TRIG input error  ERR (Error code: 01040302)	The TRIG signal was input while the BUSY signal was ON.	<ul style="list-style-type: none"> • Check the program in the PLC or other host to see if an interlock or similar measure has been implemented. • If a relay or other device with contacts is being used as the input device, see if chattering has occurred. 	<ul style="list-style-type: none"> • Program interlocks to control the TRIG and IN5 input signals so that they do not turn ON while the BUSY signal is ON. • Switch from a device with contacts (e.g., relay) to a device without contacts (e.g., SSR or PLC transistor output).
IN input error  ERR (Error code: 11020900)	The IN5 signal was input while the BUSY signal was ON.		
Scene data error  ERR (Error code: 01030800)	The scene could not be switched for an input signal from an external device.	---	The scene data to be switched to is corrupted. Reset the scene data from the beginning.
Logging error (Error code: 02160702, 02160703)	All of the data was not saved when logging data to a file.	Check to see if the BUSY output parameter is set to <i>Measurement</i> .	Set the BUSY output parameter to <i>Data logging</i> or <i>Image logging</i> .
SD card output error (Error code: None)	A write to the SD card failed.	Check to see if the SD card is locked. Check to see if there is sufficient space available on the SD card.	Unlock the SD card. Delete unnecessary files from the SD card.

 ERR If an error that is indicated by this icon occurs, the ERROR operation indicator will light and the ERROR signal will turn ON.

Checking the Error Histories

• Checking the History of Errors That Have Occurred in the Sensor

- ▶  (Setup Mode) – [Sensor settings] – [Error history] – [View history]

Errors will be displayed in order with the most recent ones on top.

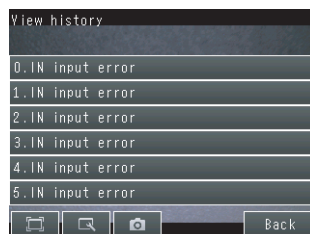

• Checking the Log of Errors That Have Occurred in the Touch Finder

- ▶  (Setup Mode or Run Mode) – [TF settings] – [Error history] – [View history]

Clearing the Error Histories

• Deleting the History of Errors That Were Detected in the Sensor

- ▶  (Setup Mode) – [Sensor settings] – [Error history] – [Delete history]

• Deleting the History of Errors That Were Detected in the Touch Finder

- ▶  (Setup Mode or Run Mode) – [TF settings] – [Error history] – [Delete history]

Note

Refer to the following information for the measures to take when errors occur.

 Errors Stored in the Error History: p. 162

Checking the Latest Error Information (for No-protocol Connection to Ethernet)

The error code of the latest error can be acquired as a response using the error information acquisition command (ERRGET).

- Error Codes: p. 162
- Error Information Acquisition Command (ERRGET): p. 155

Error Messages

If an error occurs while making settings on the Touch Finder, an error message will appear on the display. For these errors, the ERR indicator on the Sensor will not light, the ERROR signal will not be output, and the error will not be recorded in the error history. Follow the instructions that are given in the error message.

If the following messages appear, the hardware may be faulty. Contact your OMRON representative.

- System error.
- Application system error. Please reboot.
- Failed to startup.

9-2 Basic Troubleshooting

Problem	Measures to perform	Reference
The Sensor or Touch Finder will not start.	Check the power supply capacity to see if it is sufficient.	---
The Sensor cannot be detected.	Check the Ethernet cable to see if it is connected correctly.	---
	Check the Ethernet settings to see if they are correct between the devices.	p. 32
	Check if there are any Sensors that were not detected by the Sensor connection check.	p. 175
	Check the communications cable to see if it is disconnected.	---
	Check the switching hubs to see if any of them are faulty. (If switching hubs are used.)	---
The results display is not updated.	Check to see if the TRIG signal is being correctly input to the Sensor.	p. 97
	Check to see if the most recent NG result is being displayed.	p. 14
Updating the results display is slow.	If other devices are connected to the same network as the Sensor, disconnect the other devices from the network and check the update speed. If the update speed returns to normal, check the specifications of the disconnected devices and take suitable measures.	---
	If there are power lines running in parallel with the Ethernet cable or if there are inverters or other sources of noise near the communications cable, separate the communications cable from them and check the update speed. Noise may be adversely affecting the communications response.	---
Data is not logged properly.	Check to see if the logging setting in the Sensor are correct.	p. 102
	If logging to an SD card is not possible, check the available space on the SD card and check to see if the SD card is write-protected.	p. 110
The ERROR indicator lights.	Check the error history to see what error has occurred and take suitable measures.	p. 162
The image brightness does not stabilize.	Turn ON the brightness correction mode. When the Brightness Correction Mode is ON, the timing when images are taken changes. Check that the images of the measured objects taken when the Brightness Correction Mode is ON are appropriate.	p. 38

Appendices

10-1 Menu Tables	166
10-2 External Reference Parameters.....	178
10-3 Specifications and Dimensions.....	182
10-4 Updating the Software.....	193
Index.....	195
Revision History.....	198

10-1 Menu Tables

Image Tab Page

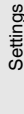
Menu command		Description	Setting range	Data	Reference	
Camera setup	Focus	The value shown here is used as a reference when adjusting the focus with the focus adjustment screw.	---	---	p. 37	
		Brightness	Adjusts the brightness of the image.	AUTO or 1 to 100	Scene	p. 38
		HDR	Suppresses reflections and differences in brightness.	OFF (default) or 1 to 4	Scene	p. 39
		Brightness correction	Use to stabilize the brightness.	ON or OFF (default)	Scene	p. 164
		Partial input	Used to make the image input range smaller.	752 × 8 to 752 × 480	Scene	p. 76
		Lighting control	Turns the light in the Sensor ON and OFF.	ON (default) or OFF	Scene	p. 115
Trigger setup	Trigger delay	Adjusts the time until the Camera shutter opens after the trigger signal is received.	0 to 163 ms (default: 0)	System	p. 44	
Position compensation	Mode ON/OFF	Adjusts the position of the measurement object before measurement.	ON or OFF (default)	Scene	p. 42	
		Teach	Performs teaching and sets the judgement parameters.			---
		Model region				
		Insp. region				
Judgement	Correlation: 0 to 100 (Defaults: Upper limit: 100, Lower limit: 60)	p. 43				

Inspect Tab Page

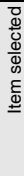
Menu command		Description	Setting range	Data	Reference	
Inspection		Add item	Used to add, modify, delete, copy, or change the name of an inspection item.	Bar code, 2D-code	---	p. 50
		Modify	---	---	---	p. 51
		Delete	---	---	---	p. 51
		Copy	---	---	---	
		Rename	15 alphanumeric characters	---	---	

Menu command		Description	Setting range	Data	Reference			
Inspection Settings	Teach (Bar code) Select master data	Insp. region width	Adjusts the size and position of the measurement region.	---	Scene	p. 53		
		Master data 0 to 31	Auto	Automatically registers the master data.	---	Scene	p. 53	
			Manual	Manually registers the master data.	---	Scene	p. 53	
			Clear	Deletes/copies the master data or changes the name of the master data.	---	Scene	---	
			Copy					
			Rename					
		(2D-code) Select master data	Insp. region width	Adjusts the size and position of the measurement region.	---	Scene	p. 59	
			Master data 0 to 31	Auto	Automatically registers the master data.	---	Scene	p. 59
				Manual	Manually registers the master data.	---	Scene	p. 59
				Clear	Deletes/copies the master data or changes the name of the master data.	---	Scene	---
	Copy							
	Rename							
	Judgement		Used to specify the parameters for an OK judgement for individual judgements. The range for the reference value to judge OK is specified.		0 to 100 (Defaults: Upper limit: 100, Lower limit: 60)	Scene	---	
				Num. of characters (For bar code)	1 to 1024 (Defaults: Upper limit: 1024, Lower limit: 1)			p. 54
				Characters (For bar code)	32 characters max. (Default*)			
				Num. of characters (For 2D-code)	1 to 1024 (Defaults: Upper limit: 1024, Lower limit: 1)			p. 60
		Characters (For 2D-code)		32 characters max. (Default*)				

Menu command		Description	Setting range	Data	Reference	
Inspection Details (For bar code)	Function settings	Verification on/off	Sets whether or not to perform verification against the master data.	ON, OFF (default)	Scene	p. 55
		Verified master data	Selects the master data to be used for verification.	All master data (default), Master data 0 to 31	Scene	
		Partial verif. on/off	Sets whether or not to specify partial verification.	ON, OFF (default)	Scene	
		Partial verification setup	Specifies Partial verification setup.	1 to 1024 (Default First digit: 1, last digit: 1024)	Scene	
		String output on/off	Specifies whether or not to ethernet output the reading result.	ON, OFF (default)	Scene	
		Error string	Sets the text string to be output when a read error occurs.	20 characters max. (Default: NG)	Scene	
		Partial output on/off	Sets whether or not to specify a range in the read data to output from when [Output characters] is set to ON.	ON, OFF (default)	Scene	
		Output string setup	Sets the first and last digit positions to output. If the read text string contains non-targeted digits, the error string is output.	1 to 1024 (Default First digit: 1, last digit: 1024)	Scene	
	Decode settings	Code type	Selects the code to be read.	JAN/EAN/UPC, Code39, Codabar, ITF, Code 93, Code128/GS1-128, GS1 DataBar, Pharmacode	Scene	p. 56
		Timeout	Sets the timeout time (ms) for read processing.	1 to 9999 (Default: 9999)	Scene	
		Composite codes on/off	Specifies Composite codes on or off.	ON, OFF (default)	Scene	
		Check digit on/off	Specifies Check digit on or off.	ON (default) or OFF	Scene	
		Direction	Selects the read direction.	Horizontal mode (default), Vertical mode	Scene	
		Reverse on/off	Specifies whether or not to use the reverse mode.	ON, OFF (default)	Scene	

Menu command		Description	Setting range	Data	Reference	
Inspection	Details (For 2D-code)	Function settings				
		Verification on/off	Sets whether or not to perform verification against the master data.	ON, OFF (default)	Scene	p. 61
		Verified master data	Selects the master data to be used for verification.	All master data (default), Master data 0 to 31	Scene	
		Partial verif. on/off	Sets whether or not to specify partial verification.	ON, OFF (default)	Scene	
		Partial verification setup	Specifies Partial verification setup.	1 to 1024 (Default First digit: 1, last digit: 1024)	Scene	
		String output on/off	Specifies whether or not to ethernet output the reading result.	ON, OFF (default)	Scene	
		Error string	Sets the text string to be output when a read error occurs.	20 characters max. (Default: NG)	Scene	
		Partial output on/off	Sets whether or not to specify a range in the read data to output from when [Output characters] is set to ON.	ON, OFF (default)	Scene	
	Output string setup	Sets the first and last digit positions to output. If the read text string contains non-targeted digits, the error string is output.	1 to 1024 (Default First digit: 1, last digit: 1024)	Scene		
	Decode settings	Code type	Selects the code to be read.	Data Matrix, QR Code, MicroQR Code, PDF417, MicroPDF417	Scene	p. 62
		Timeout	Sets the timeout time (ms) for read processing.	1 to 9999 (Default: 9999)	Scene	
		Reverse	Specifies normal or reverse.	Normal (default), Reverse	Scene	
		Code color	Specifies the code color.	Black, White, Auto (default)	Scene	
		Shape (Data-Matrix)	Specifies the shape of the code.	Square (default), Square or Rect.	Scene	
	Calculation	Settings	Expression			
[MENU]						
Expression 0 to expression 31			Sets the number of the expression for which to set a calculation.	---	Scene	p. 66
Expression settings			Sets the expressions.	---	Scene	
Const.			Inputs constants or mathematical operators.	0 to 9, calculation symbol () / * - , + T J G	Scene	p. 66
Data			Uses the measurement result of other items.	Inspection item, calculation symbols () / * - , + T J G	Scene	p. 71
Math.			Uses functions in expressions.	SIN, COS, ATAN, AND, OR, NOT, ABS, MAX, MIN, MOD, SQRT, ANGL (angle of straight line joining two points), DIST (distance between two points), calculation symbols () / * - , + T J G	Scene	p. 68
Rename			Deletes/copies the expression or changes the expression name.	---	Scene	p. 66
Copy				---	Scene	
Delete				---	Scene	
Judgement	Specifies the parameters for judgement of results.		Scene	p. 70		

In/Out Tab Page

Menu command		Description	Setting range	Data	Reference		
Log setting	Statistical data	Sets whether to record the number of measurements and the number of NG overall judgements.	ON (default) or OFF	System	p. 106		
	Image logging	Sets the parameter to log measurement image data.	All, Only NG, or None (default)	System	p. 102 p. 106		
	Data logging	Sets the parameter to log measurement data from inspection items.	All (default), Only NG, or None (default)	System			
	Delete Log	Resets the log data without turning OFF the power supply.	---	---	p. 106		
I/O setting	I/O terminals	Output	OUT0	Used to assign output signals to OUT0, OUT1, and OUT2.	OR (Total judgement) (default) or OR0 (Item0 judgement) to OR31 (Item31 judgement)	System	p. 124
			OUT1		BUSY (default) or OR0 (Item0 judgement) to OR31 (Item31 judgement)	System	
			OUT2		ERROR (default) or OR0 (Item0 judgement) to OR31 (Item31 judgement)	System	
		Output polarity	Sets the ON condition for the OR signal.	OK: ON or NG: ON (default)	System	p. 128	
		Output mode	Sets the output timing for the judgement result.	One-shot output or Level output (default)	System	p. 126	
		Output delay	When one-shot output mode is selected, this parameter sets the delay from when measurement processing is completed until when the OR signal turns ON.	0 to 1,000 ms (default: 0 ms)	System		
		Output time	When one-shot output mode is selected, this parameter sets the time that the OR signal is ON.	0 to 1,000 ms (default: 5 ms)	System		
		BUSY output	Specifies when to turn OFF the BUSY signal after starting measurement processing.	Measurement (default), Data logging, Image logging, or Result display	System	p. 104	
		BUSY polarity	Sets the ON condition for the BUSY signal output.	BUSY: ON (default), READY: ON	System	p. 128	
		Input	Input mode	Specifies whether to use functions other than scene switching for external parallel commands.	Standard mode (default) or Expanded mode	System	p. 129

Menu command		Description	Setting range	Data	Reference		
I/O setting	Ethernet	Output data set	---	Data 0 to data 31	---	p. 137	
		[MENU] Settings	Sets data to output to selected data number.	Text strings of the set inspection items and expressions.	---		
		[MENU] Rename	Changes the name of the selected data number.	The name can be changed to a name with up to 15 alphanumeric characters.	---		
		[MENU] Copy	Copies the contents registered in the selected data number to another data number.	---	---		
		[MENU] Delete	Clears the content of the selected data number.	---	---		
	Output form		---	---	---	p. 138	
	Output form		Selects the format of the data to be output.	ASCII (default) or Binary	Scene		
	When output format is ASCII	Digits of integer	Sets the digits of the integer part, including the sign. However, + is not output for positive numbers. Example: Setting 4-digit data: -5963 is output as -999.	1 to 10 (Default: 6)	Scene		
		Digits of decimal	Sets the output digits for the decimal part. If it is set to 0, the decimal part is rounded off before the data is output.	0 to 4 (default: 4)	Scene		
		Minus	Selects what to display as the sign when the number is negative.	- (Default) or 8	Scene		
		0 suppress	Selects the method to adjust unused digits on the left in output data. ON: Zeros are inserted for unused digits. OFF: Spaces are inserted for unused digits. Example: The following examples are for when five integer digits and three decimal digits are set and the data is 100.000. ON: 00100.000 OFF: _100.000 (The underscore indicates a space.)	ON or OFF (default)	Scene		
	Output form	When Output Format Is ASCII	Field separator	Selects the separator to use between output data.	None (default), comma, tab, space, CR, LF, or CR+LF	Scene	p. 138
			Record separator	Selects the separator to use between sets of output data.	None (default), comma, tab, space, CR, LF, or CR+LF	Scene	p. 138
When output format is Binary		Decimal output form	Selects the numerical expression for binary output. Fixed-decimal-point data is multiplied by 1,000 and the result is output.	Floating-point decimal or fixed decimal (default)	Scene	p. 139	
I/O monitor	I/O monitor	Used to check I/O connections.	---	---	p. 97		

Test Tab Page

Menu command	Description	Setting range	Data	Reference	
Continuous test	Used to check the individual judgement results for the inspection items and to adjust the judgement parameters.	---	---	p. 74	
Graphic	Displays the input image.				
Graphics + Details	Displays the inspection item individual judgement results and measurement values.				
All results/Region	Displays the inspection item individual judgement results for all inspection items.			p. 78	
Trend Monitor	Displays the individual judgement results saved in the Sensor in a trend monitor.			p. 74	
Histogram	Displays the individual judgement results saved in the Sensor in a histogram.				
Adjust judgement	Adjusts judgement parameters without stopping measurements.	---	Scene	p. 77	
	Auto adjustment	OK Teach, NG Teach			
	Method	Threshold (minimum), Threshold (average) (default), or Threshold (maximum)			
Auto display (trend monitor and histogram only)	Same as the trend monitor and histogram for [Run] Mode.		---	p. 86 p. 87	
Display range (trend monitor and histogram only)					
Number of data (trend monitor only)					p. 86
Number of data (histogram only)					p. 87
Save data	Saves scene data and system data.	---	---	p. 79	

Run Tab Page (from Setup Display)

Menu command	Description	Setting range	Data	Reference
Switch to Run mode	Switches to Run Mode.	---	---	p. 82

Setup Mode

Menu command		Description	Setting range	Data	Reference	
Select scene	Select	Switches to a registered scene.	---	---	p. 92	
	Rename	Used to delete, copy, or change the name of a scene.	15 alphanumeric characters			
	Copy		---			
	Clear					
Save to file	Setting	Scene data	Saves scene data with an SCN file name extension.	---	p. 109	
		Scene group data	Saves all scene data with an SGP file name extension.			
		Sensor system data	Saves system data with an SYD file name extension.			
		All Sensor data	Saves all Sensor data with a BKD file name extension.			
		Touch Finder data	Saves Touch Finder data with an MSD file name extension.			
Logging	Setting	Statistical data	Saves statistical data with a CSV file name extension.	---	p. 102	
		Logging image	Saves image data with an IFZ file name extension.			
		Logging data	Saves measurement data with a CSV file name extension.			
Load from file	Scene data	Loads scene data.	---	---	p. 109	
	Scene group data	Loads scene group data.				
	Sensor system data	Loads system data.				
	All Sensor data	Loads all Sensor data.				
	Touch Finder data	Loads Touch Finder data.				
Sensor settings	Information		Used to check the Sensor information.	---	p. 116	
	Model	Version	Used to check the model and software version of the connected Sensor.	System		
		Name				Displays the name of the connected Sensor.
	MAC address		Used to check the MAC address of the connected Sensor.	---		
		Rename	Used to change the name of a connected Sensor.	15 alphanumeric characters max.	---	p. 116
		Memory state	Used to check the status of Sensor memory.	---	---	p. 116
	Error history	View history	Displays a history of errors that have occurred in the Sensor.	---	System	p. 162
Delete history		Deletes the error history.	---		---	p. 163

Menu command		Description	Setting range	Data	Reference		
Sensor settings	Startup settings	Startup mode	Sets whether the startup scene number is set manually.	ON or OFF (Scene number when settings were saved is startup scene number.)	System	p. 93	
		Startup scene	Set the scene number to use at startup.	0 to 31	System		
	Password settings	Password ON/OFF	Enables (ON) or disables (OFF) the password.	OFF (default) or ON	System	p. 112	
		Enter password	Sets a password.	15 characters max.	System		
	Adjustment mode in Run		Sets whether to adjust judgement parameters in Run Mode.	OFF (default) or ON	---	p. 89	
	Network settings	Ethernet					p. 32
		Auto		Selects whether to use the automatic IP address setting method.	ON (default) or OFF	System	
		IP address		Enter the IP address of the Sensor. (Enabled when automatic setting is OFF.)	a.b.c.d a: 1 to 223 b: 0 to 255 c: 0 to 255 d: 2 to 254 (Default: 10.5.5.100)	System	p. 32
		Subnet mask		Inputs the subnet mask. (Enabled when automatic setting is OFF.)	0.0.0.0 to 255.255.255.255 (Default: 255.255.255.0)	System	p. 32
	Initialize		Initializes the Sensor settings and saved data.	---	---	p. 115	
Restart		Restarts the Sensor	---	---			
Update		Updates the Sensor system to the most recent data.	---	---			
TF settings	Information		Used to check the Touch Finder information.	---	System	p. 116	
	Model		Used to check the Touch Finder model.	---	---	p. 116	
	Version		Used to check the software version of the Touch Finder.	---	---		
	MAC address		Used to check the MAC address of the Touch Finder.	---	---		
	Memory state		Used to check the Touch Finder memory state.	---	---	p. 116	
	Error history	View history	Displays a history of errors that have occurred in the Touch Finder.	---	System	p. 162	
		Delete history	Deletes the error history.	---	---		
Battery level		Used to check the battery level.	---	---	p. 116		

Menu command			Description	Setting range	Data	Reference	
TF settings	File format	Logging image file	File name prefix	You can set a character string to add to the beginning of the file name for logged data.	---	---	p. 103
		Logging data file	File name prefix				
	Output format		Used to set the output format for output log data to a file.	---	---	p. 104	
	Field separator			None, Comma (default), Tab, Space, Colon, Semicolon, CR, or CR+LF	---		
	Decimal symbol			None, Point (default), or Comma	---		
		Record separator		None, Comma, Tab, Space, Colon, Semicolon, CR, or CR+LF (default)	---		
	SD card	SD card information	Displays the capacity and remaining memory in the SD card.	---	---	p. 111	
		Format	Formats an SD card.	---	---	p. 111	
	Startup display	Startup screen type	You can select the display to appear on the Touch Finder when more than one Sensor is connected.	Multi Sensor, NG sensor, Single sensor, Auto (default)	---	p. 100	
		Specify sensor	You can specify one Sensor to connect to the Touch Finder.	ON, OFF (default)	---	p. 113	
		Display pattern	Sets the display to use in Run Mode.	Graphic, Graphics + Details, All results/Region, Statistical data, Trend monitor, Histogram	System	p. 85	
		Display update mode	Sets the image to update in Run Mode.	Latest image, Last NG image		p. 95	
LCD backlight	Brightness	Sets the brightness.	0 to 5	System	p. 96		
	ECO mode	Enables (ON) or disables (OFF) ECO Mode.	ON, OFF	System	p. 96		
Ethernet				---	System	p. 32	
	Specify sensor	You can set any of the Sensors for connection to the Touch Finder and register them.	0.0.0.0 to 223.255.255.254 (default: 0.0.0.0)			p. 98, p. 99	
	IP address	Inputs the IP address of the Touch Finder.	a.b.c.d a: 1 to 223 b: 0 to 255 c: 0 to 255 d: 0 to 255 (Default: 10.5.5.100)			p. 32	
	Subnet mask	Inputs the subnet mask.	0.0.0.0 to 255.255.255.255 (Default: 255.255.255.0)			p. 32	
	Search unreachable sensors	Displays the IP address if the same IP address is used for more than one Sensor or if there is Sensor that is not in the subnet. You can change this IP address and subnet mask. This setting is valid only when automatic setting of the Sensor's IP address is OFF.	---	---	---		
Auto sensor detection			The Touch Finder can detect Sensors and automatically connect to them in the order that it detects them.	ON (default), OFF		p. 98	
Logging setting			You must enable file logging before you can execute it.	ON (default), OFF		p. 103	







Menu command		Description	Setting range	Data	Reference
TF settings	Language	Changes the language to display on the Touch Finder.	English, German, French, Italian, Spanish, Traditional Chinese, Simplified Chinese, Korean, or Japanese (The default language is selected at startup.)	System	p. 115
	Time settings	Used to set the current date and time.	Default: Selected at startup.	System	p. 115
	Touch screen calib	Used when there is an offset between the touch screen positions and pointers.	---	---	p. 116
	Initialize	Initializes the Touch Finder settings.	---	---	p. 115
	Restart	Restarts the Touch Finder.	---	---	p. 115
	Update	Updates the Touch Finder system to the most recent data.	---	---	p. 193

Run Mode

Menu command		Description	Setting range	Data	Reference	
Select display	Graphic	Displays the input image.	---	---	p. 84	
	Graphics + Details	Displays the inspection item individual judgement results and measurement values.		---		
	Statistical data	Displays the total number of measurements and the total number of NG over all judgements and the NG ratio from when the power supply was turned ON.				
	All results/Region	Displays the inspection item individual judgement results for all inspection items.		---		
	Trend Monitor	Displays the individual judgement results saved in the Sensor in a trend monitor.		---		p. 86
	Histogram	Displays the individual judgement results saved in the Sensor in a histogram.		---		p. 87
	 Adjust judgement (Except for statistical data)	Adjusts judgement parameters without stopping measurements.	---	---	p. 89	
	Auto display (trend monitor and histogram only)	Automatically sets the display range according to the measurement results.	OFF or ON (default)	---	p. 86, p. 87	
	Display range (trend monitor and histogram only)	Changes the display range of measurement values.	-999,999,999 to 999,999,999		p. 86, p. 87	
	Number of data (trend monitor only)	Changes the number of displayed measurement values.	200, 400, or 1,000 (default: 200)		p. 86	
	Number of data (histogram only)	Changes the number of displayed measurement values (i.e., the vertical display range of the histogram).	5 to 1,000	---	p. 87	
	Clear results (graphic or graphic + details list)	Clears the measurement results of the inspection items.	---	---	---	
	Delete stats (total data)	Clears the total results of the inspection items.	---	---	---	
Logging	Image logging	Starts and stops logging in external memory.	ON: Start or OFF: Stop	---	p. 102	
	Data logging		ON: Start or OFF: Stop	---		

Menu command		Description	Setting range	Data	Reference
TF settings		The same as for Setup Mode. (This does not apply to the PC Tool.) The resolution of the measurement image can be set on the PC Tool.		---	p. 115
Sensor setting		Switches to Setup Mode.	---	---	p. 82
Sensor monitor	Multi sensor	Simultaneously displays the images for multiple connected Sensors.	---	---	p. 84
	NG sensor	From multiple connected Sensors, displays the image of only the Sensors with NG results.	---	---	
Switch sensor	Select	Switches to the selected Sensor.	---	---	---
	Connections	Displays the name of the Sensor detected by the Touch Finder and the connection status.			
	 Auto connect	Automatically detects and connects the Sensors that are connected.			

Common Menu Commands

Menu command		Description	Setting range	Data	Reference
	Only-image Button	Hides text and displays only the image.	---	---	p. 96
Display Button	 Zoom-in Button	Enlarges the image display.	---	---	p. 94
	 Zoom-out Button	Reduces the image display.			
	 FIT Button	Fits the image to the display size.			
	Display Button 	Changes the image display method.			
	Capture Button	Used to capture the current display and save it in external memory, e.g., an SD card.	---	---	p. 113

10-2 External Reference Parameters

Position compensation

External reference number	Data name	Setting/Acquisition	Data range	Default	Expression text string	Logged data/Judgement parameter
0	Judgement	Acquisition only	-2: No judgement (not measured), 0: Judgement is OK, -1: Judgement is NG, -13: Teaching not performed error, -14: Figure not registered error, -15: Out of range error	-2	JG	---
5	Scroll X	Acquisition only	-99999.9999 to 99999.9999	0	DX	---
6	Scroll Y	Acquisition only	-99999.9999 to 99999.9999	0	DY	---
8	Position X	Acquisition only	-99999.9999 to 99999.9999	0	X	---
9	Position Y	Acquisition only	-99999.9999 to 99999.9999	0	Y	---
11	Reference position X	Acquisition only	-99999.9999 to 99999.9999	0	SX	---
12	Reference position Y	Acquisition only	-99999.9999 to 99999.9999	0	SY	---
14	Correlation	Acquisition only	0 to 100	0	CR	---
124	Reference position X	Setting/Acquisition	0 to 99999.9999	0	---	---
125	Reference position Y	Setting/Acquisition	0 to 99999.9999	0	---	---
166	Correlation judgement upper limit	Setting/Acquisition	0 to 100	100	---	Adjust judgement
167	Correlation judgement lower limit	Setting/Acquisition	0 to 100	60	---	

Bar code

External reference number	Data name	Setting/Acquisition	Data range	Default	Expression text string	Logged data/Judgement parameter
0	Judgement	Acquisition only	-2: No judgement (not measured), 0: Judgement is OK, 1: Judgement is NG, 13: Teaching not performed error, 14: Figure not registered error, 15: Out of range error	-2	JG	---
5	Index No.	Acquisition only	-2: Verification OFF, or reading error -1: Verification is NG, 0 to 31: Master data No.	-2	IN	---
6	Num. of characters	Acquisition only	0 to 1024	0	N	Logged data
7 ^{*1}	Characters	Acquisition only	32 characters max.	0	---	---
120	Verification on/off	Settings/Acquisition	0: None 1: Enable	0	---	---

External reference number	Data name	Setting/Acquisition	Data range	Default	Expression text string	Logged data/Judgement parameter
121	Verified master data	Settings/Acquisition	0: Verify all master data 1: Verify master data 0 2: Verify master data 1 ⋮ 31: Verify master data 31	0	---	---
122	Partial verif. on/off	Settings/Acquisition	0: None 1: Enable	0	---	---
123	Last compared digit	Settings/Acquisition	1 to 1024	1024	---	---
124	First compared digit	Settings/Acquisition	1 to 1024	1	---	---
125	String output on/off	Settings/Acquisition	0: None 1: Enable	0	---	---
126	Error string size (bytes)	Settings/Acquisition	1 to 20	2	---	---
127 ^{*1}	Error string	Settings/Acquisition	20 characters max	NG	---	---
128	Partial output on/off	Settings/Acquisition	0: None 1: Enable	0	---	---
129	Output last digit	Settings/Acquisition	1 to 1024	1024	---	---
130	Output first digit	Settings/Acquisition	1 to 1024	1	---	---
131	Code type	Settings/Acquisition	0: JAN/EAN/UPC 1: Code 39 2: Codabar 3: ITF 4: Code 93 5: Code128/GS1-128 6: GS1 DataBar 7: Pharmacode	0	---	---
132	Timeout time (ms)	Settings/Acquisition	1 to 9999	9999	---	---
133	Check digit on/off	Settings/Acquisition	0: None 1: Enable	1	---	---
134	Composite codes on/off	Settings/Acquisition	0: None 1: Enable	0	---	Adjust judgement
135	Direction	Settings/Acquisition	0: Horizontal mode 1: Vertical mode	0	---	---
136	Reverse on/off	Settings/Acquisition	0: None 1: Enable	0	---	---
137	Num. of characters	Settings/Acquisition	1 to 1024	1024	---	---
138	Lower limit of the Num. of characters	Settings/Acquisition	1 to 1024	0	---	Adjust judgement
139	Characters size (bytes)	Settings/Acquisition	1 to 32	1	---	---
140 ^{*1}	Characters threshold	Settings/Acquisition	32 characters max.	*	---	Adjust judgement
150	Selected master number	Settings/Acquisition	1 to 31	0	---	---
200+3N (N=0 to 31) ^{*1}	Rename master data N	Settings/Acquisition	16 characters max.	None	---	---

External reference number	Data name	Setting/Acquisition	Data range	Default	Expression text string	Logged data/Judgement parameter
201+3N (N=0 to 31) ^{*1}	Num. of master data characters N	Acquisition only	0 to 32	0	---	---
202+3N (N=0 to 31)	Master data N	Settings/Acquisition	32 characters max.	None	---	---

*1 Use the ITEMDATA2 command to set and/or acquire a text string.

2D-code

External reference number	Data name	Setting/Acquisition	Data range	Default	Expression text string	Logged data/Judgement parameter
0	Judgement	Acquisition only	0: Judgement is OK, 1: Judgement is NG, 13: Teaching not performed error, 14: Figure not registered error, 15: Out of range error	-2	JG	---
5	Index No.	Acquisition only	-2: Verification OFF, or reading error -1: Verification is NG, 0 to 31: Master data No.	-2	IN	---
6	Num. of characters	Acquisition only	0 to 1024	0	N	Logged data
7 ^{*1}	Characters	Acquisition only	32 characters max.	0	---	---
120	Verification on/off	Settings/Acquisition	0: None 1: Enable	0	---	---
121	Verified master data	Settings/Acquisition	0: Verify all master data 1: Verify master data 0 2: Verify master data 1 ⋮	0	---	---
122	Partial verif. on/off	Settings/Acquisition	0: None 1: Enable	0	---	---
123	Last compared digit	Settings/Acquisition	1 to 1024	1024	---	---
124	First compared digit	Settings/Acquisition	1 to 1024	1	---	---
125	String output on/off	Settings/Acquisition	0: None 1: Enable	0	---	---
126	Error string size (bytes)	Settings/Acquisition	1 to 20	2	---	---
127 ^{*1}	Error string	Settings/Acquisition	20 characters max.	NG	---	---
128	Partial output on/off	Settings/Acquisition	0: None 1: Enable	0	---	---
129	Output last digit	Settings/Acquisition	1 to 1024	1024	---	---
130	Output first digit	Settings/Acquisition	1 to 1024	1	---	---
131	Code type	Settings/Acquisition	0: Data Matrix 1: QR Code 2: MicroQR Code 3: PDF417 4: MicroPDF417	0	---	---

External reference number	Data name	Setting/Acquisition	Data range	Default	Expression text string	Logged data/Judgement parameter
132	Timeout time (ms)	Settings/Acquisition	1 to 9999	9999	---	---
133	Reverse	Settings/Acquisition	0: Normal 1: Reverse	0	---	---
134	Code color (Data Matrix, PDF417 only)	Settings/Acquisition	0: Black 1: White 2: Auto	2	---	---
135	Shape (DataMatrix only)	Settings/Acquisition	0: Square 1: Square or Rect.	0	---	---
136	Upper limit of the Num. of characters	Settings/Acquisition	0 to 1024	1024	---	Adjust judgement
137	Lower limit of the Num. of characters	Settings/Acquisition	0 to 1024	0	---	Adjust judgement
138	Characters size (bytes)	Settings/Acquisition	1 to 32	1	---	---
139 ^{*1}	Characters threshold	Settings/Acquisition	32 characters max.	*	---	Adjust judgement
150	Selected master number	Settings/Acquisition	0 to 31	0	---	---
200+3N (N=0 to 31) ^{*1}	Rename master data N	Settings/Acquisition	16 characters max.	None	---	---
201+3N (N=0 to 31)	Num. of master data characters N	Acquisition only	0 to 32	0	---	---
202+3N (N=0 to 31) ^{*1}	Master data N	Settings/Acquisition	32 characters max.	None	---	---

*1 Use the ITEMDATA2 command to set and/or acquire a text string.

10-3 Specifications and Dimensions

Sensor

Specifications

Item		Description
Model	NPN	FQ-CR10□□□□-M
	PNP	FQ-CR15□□□□-M
Field of view		Refer to Table 1.
Installation distance		Refer to Table 1.
Minimum resolution		FQ-CR1□010F-M: 0.040mm FQ-CR1□050F-M: 0.070mm FQ-CR1□100F-M: 0.282mm FQ-CR1□100N-M: 0.155mm
Main functions	Inspection items	Bar code (JAN/EAN/UPC, Code39, Codabar (NW-7), ITF (Interleaved 2 of 5), Code 93, Code128/GS1-128, GS1 DataBar* (Truncated, Stacked, Omni-directional, Stacked Omni-directional, Limited, Expanded, Expanded Stacked), Pharmacode, GS1-128 Composite Code (CC-A,CC-B,CC-C)), 2D-code (DataMatrix (EC200), QR Code, MicroQR Code, PDF417, MicroPDF417)
	Number of simultaneous measurements	32
	Position compensation	Supported
	Number of registered scenes	32
Image input	Image processing method	Monochrome
	Image filter	High dynamic range (HDR) and polarizing filter (attachment)
	Image elements	1/3-inch Monochrome CMOS
	Shutter	1/250 to 1/30,000
	Processing resolution	752 × 480
Lighting	Lighting method	Pulse
	Lighting color	White
Data logging	Measurement data	In Sensor: 1,000 items (If a Touch Finder is used, results can be saved up to the capacity of an SD card.)
	Images	In Sensor: 20 images (If a Touch Finder is used, images can be saved up to the capacity of an SD card.)
Auxiliary function		Math (arithmetic, calculation functions, trigonometric functions, and logic functions)
Measurement trigger		External trigger (single or continuous)

Item	Description	
I/O specifications	Input signals	7 signals <ul style="list-style-type: none"> • Single measurement input (TRIG) • Control command input (IN0 to IN5)
	Output signals	3 signals <ul style="list-style-type: none"> • Control output (BUSY) • Overall judgement output (OR) • Error output (ERROR) Note: The three output signals can be allocated for the judgements of individual inspection items.
	Ethernet specifications	100Base-TX/10Base-T Numerical outputs and control commands are supported with no-protocol communications.
	Input specifications	Refer to Table 2.
	Output specifications	
	Connection method	Special connector cables Power supply and I/O: 1 cable (FQ-WD□□□□) Touch Finder and computer: 1 cable (FQ-WN□□□□)
Indications	Judgement results indicator (color: orange), ERROR indicator (color: red), and BUSY indicator (color: green)	
Ratings	Power supply voltage	20.4 to 26.4 VDC (including ripple)
	Insulation resistance	Between all lead wires and case: 0.5 MΩ (at 250 V)
	Current consumption	2.4 A max.
Environmental immunity	Ambient temperature range	Operating: 0 to 50°C Storage: -25 to 65°C (with no icing or condensation)
	Ambient humidity range	Operating and storage: 35% to 85% (with no condensation)
	Ambient atmosphere	No corrosive gas
	Vibration resistance (destruction)	10 to 150 Hz, single amplitude: 0.35 mm, X/Y/Z directions 8 min each, 10 times
	Shock resistance (destruction)	150 m/s ² 3 times each in 6 direction (up, down, right, left, forward, and backward)
	Degree of protection	IEC 60529 IP67 (Except when Polarizing Filter Attachment is mounted or connector cap is removed.)
Materials	Sensor: PBT, PC, SUS Mounting Bracket: PBT Polarizing Filter Attachment: PBT, PC Ethernet connector: Oil-resistance vinyl compound I/O connector: Lead-free heat-resistant PVC	
Weight	Depends on field of view and installation distance. Refer to Table 1.	
Accessories	Mounting Bracket (FQ-XL)(1) Polarizing Filter Attachment (FQ-XF1) (1) Instruction Manual Member Registration Sheet	
LED class ²	Risk Group 2	

Table 1

NPN	PNP	Field of view (H×V) *1	Installation distance	Number of LEDs	Weight
FQ-CR10010F-M	FQ-CR15010F-M	7.5 × 4.7 to 13 × 8.2 mm	38 to 57 mm	4	200 g max.
FQ-CR10050F-M	FQ-CR15050F-M	13 × 8.2 to 53 × 33 mm	56 to 215 mm	4	
FQ-CR10100F-M	FQ-CR15100F-M	53 × 33 to 240 × 153 mm	220 to 970 mm	8	
FQ-CR10100N-M	FQ-CR15100N-M	29 × 18 to 300 × 191 mm	32 to 380 mm	8	

*1: Tolerance: ±10% max.

*2: Applicable standards: IEC62471-2

Table 2

Item	NPN	PNP
Input specifications	ON: Shorted to 0 V, or 1.5 V max. OFF: Open (leakage current: 0.1 mA max.)	ON: Shorted to power supply voltage, or power supply voltage -1.5 V max. OFF: Open (leakage current: 0.1 mA max.)
Output specifications	NPN open collector 30 VDC, 50 mA max., residual voltage: 1.2 V max.	PNP open collector 30 VDC, 50 mA max., residual voltage: 1.2 V max.

Dimensions

FQ-CR10010F-M/-CR10050F-M
 FQ-CR15010F-M/-CR15050F-M

(Unit: mm)

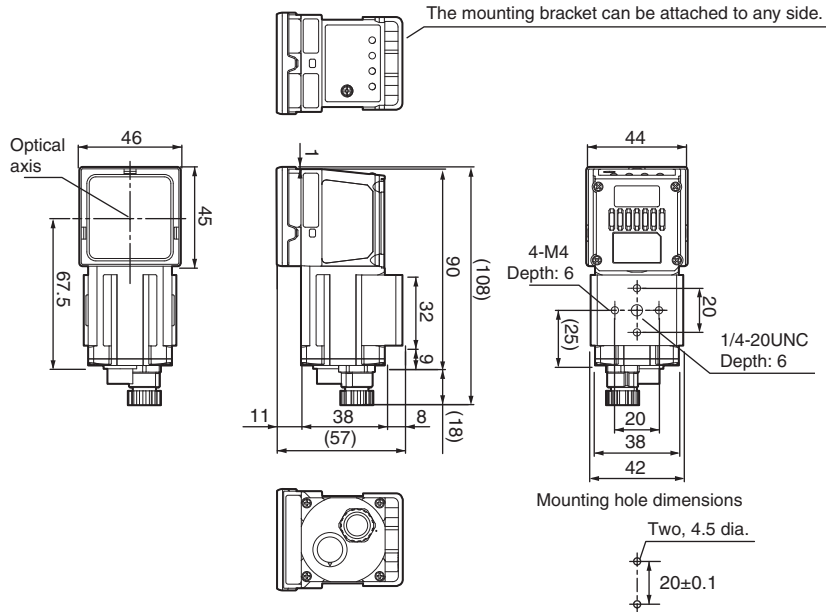

FQ-CR10100F-M/-CR10100N-M
 FQ-CR15100F-M/-CR15100N-M

(Unit: mm)

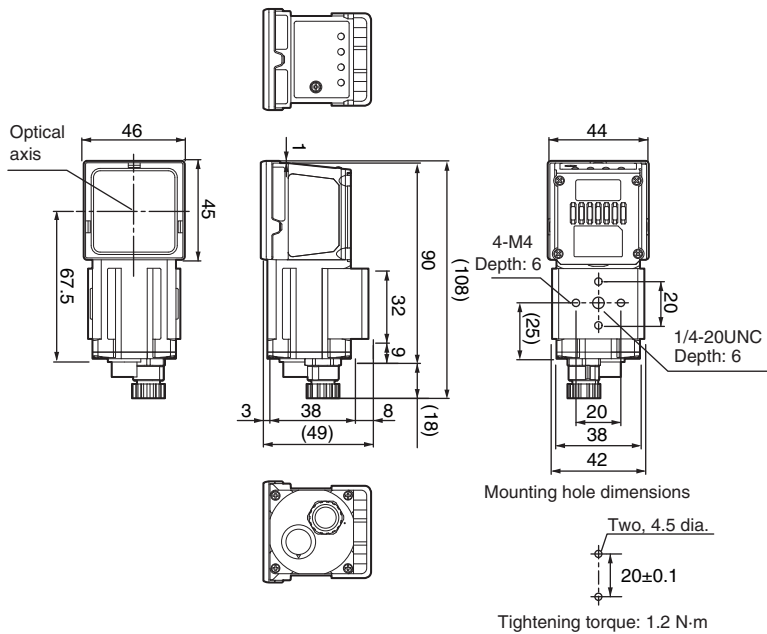

Touch Finder

Specifications

Item		Model with DC power supply		Model with AC/DC/battery power supply	
		FQ2-D30		FQ2-D31	
Number of connectable Sensors		8 max.			
Main functions	Types of measurement displays		Last result display, last NG display, trend monitor, histograms		
	Types of display images		Through, frozen, zoom-in, and zoom-out images		
	Data logging		Measurement results, measured images		
	Menu language		English, German, French, Italian, Spanish, Traditional Chinese, Simplified Chinese, Korean, or Japanese		
Indications	LCD	Display device	3.5-inch TFT color LCD		
		Pixels	320 × 240		
		Display colors	16,777,216		
	Backlight	Life expectancy ¹	50,000 hours at 25°C		
		Brightness adjustment	Provided		
		Screen saver	Provided (The time setting can be changed.)		
	Indicators		Power indicator (color: green): POWER Error indicator (color: red): ERROR SD card access indicator (color: yellow): SD ACCESS	Power indicator (color: green): POWER Error indicator (color: red): ERROR SD card access indicator (color: yellow): SD ACCESS Charge indicator (color: orange): CHARGE	
	Operation interface	Touch screen	Method	Resistance film	
Life expectancy ²			1,000,000 operations		
External interface	Ethernet		100BASE-TX/10BASE-T		
	SD card		SDHC-compliant, Class 4 or higher recommended		
Ratings	Power supply voltage		DC power connection: 20.4 to 26.4 VDC (including ripple)	DC power connection: 20.4 to 26.4 VDC (including ripple) AC adapter (manufactured by Sino-American Japan Co., Ltd) connection: 100 to 240 VAC, 50/60 Hz Battery connection: FQ-BAT1 Battery (1 cell, 3.7 V)	
	Continuous operation on Battery ³		---	1.5 h	
	Current consumption		DC power connection: 0.2 A	DC power connection: 0.2 A, Charging battery: 0.4 A	
	Insulation resistance		Between all lead wires and case: 0.5 MΩ (at 250 V)		

Item		Model with DC power supply	Model with AC/DC/battery power supply
		FQ2-D30	FQ2-D31
Environmental immunity	Ambient temperature range	Operating: 0 to 50°C Storage: -25 to 65°C (with no icing or condensation)	Operating: 0 to 50°C when mounted to DIN Track or panel 0 to 40°C when operated on a Battery Storage: -25 to 65°C (with no icing or condensation)
	Ambient humidity range	Operating and storage: 35% to 85% (with no condensation)	
	Ambient atmosphere	No corrosive gas	
	Vibration resistance (destruction)	10 to 150 Hz, single amplitude: 0.35 mm, X/Y/Z directions 8 min each, 10 times	
	Shock resistance (destruction)	150 m/s ² 3 times each in 6 direction (up, down, right, left, forward, and backward)	
	Degree of protection	IEC 60529 IP20	
Weight		Approx. 270 g (without Battery and hand strap)	
Dimensions		95 × 85 × 32.5 mm	
Materials		Case: ABS	
Accessories		Touch Pen (FQ-XT), Instruction Manual	

- *1 This is a guideline for the time required for the brightness to diminish to half the initial brightness at room temperature and humidity. No guarantee is implied. The life of the backlight is greatly affected by the ambient temperature and humidity. It will be shorter at lower or higher temperatures.
- *2 This value is only a guideline. No guarantee is implied. The value will be affected by operating conditions.
- *3 This value is only a guideline. No guarantee is implied. The value will be affected by the operating environment and operating conditions.

• Battery Specifications

Item	FQ-BAT1
Battery type	Secondary lithium ion battery
Nominal capacity	1,800 mAh
Rated voltage	3.7 V
Dimensions	35.3 × 53.1 × 11.4 mm
Ambient temperature range	Operating: 0 to 40°C Storage: -25 to 65°C (with no icing or condensation)
Ambient humidity range	Operating and storage: 35% to 85% (with no condensation)
Charging method	Charged in Touch Finder (FQ-D31).
Charging time ^{*1}	2 h
Usage time ^{*1}	1.5 h
Battery backup life ^{*2}	300 charging cycles
Weight	50 g max.

- *1 This value is only a guideline. No guarantee is implied. The value will be affected by operating conditions
- *2 This is a guideline for the time required for the capacity of the Battery to be reduced to 60% of the initial capacity. No guarantee is implied. The value will be affected by the operating environment and operating conditions.

Dimensions

- FQ2-D30/-D31

(Unit: mm)

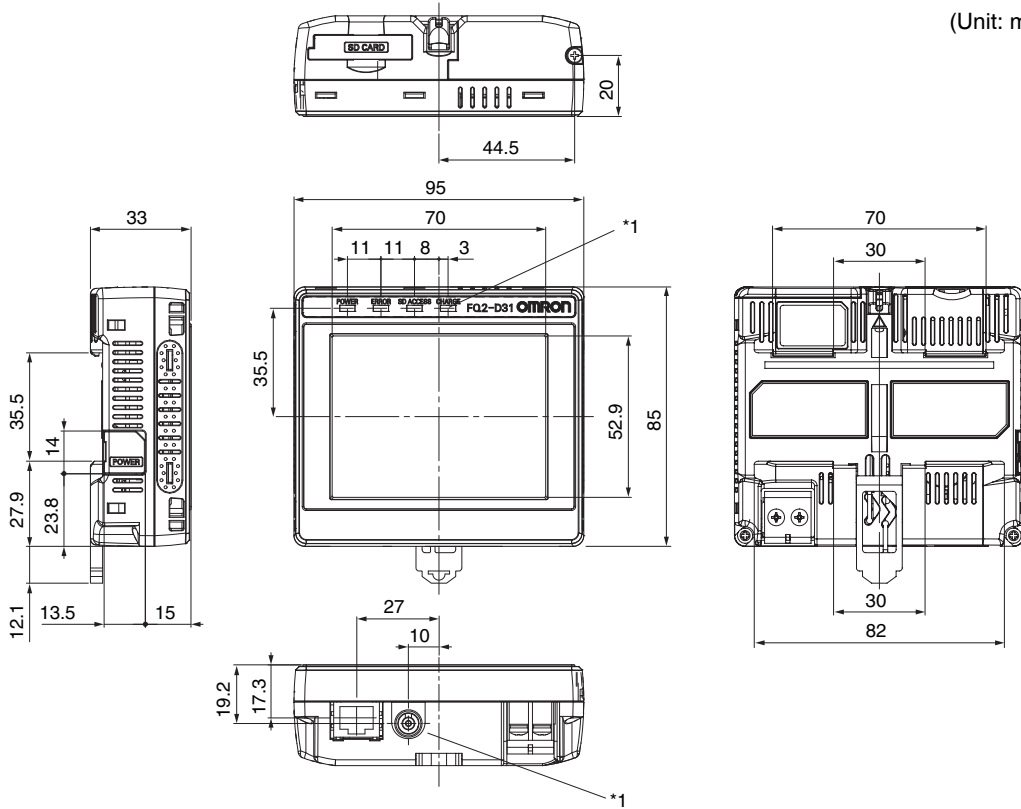

*1: Provided on the FQ2-D31 only.

- Panel Mounting Adapter (FQ-XPM)

(Unit: mm)

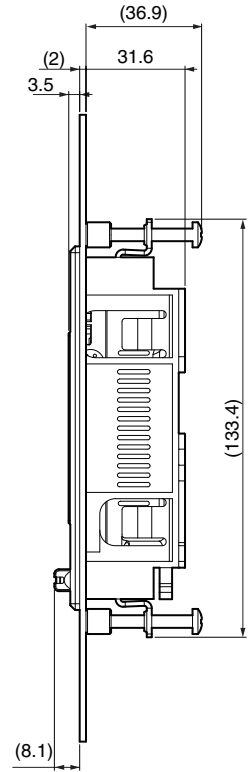
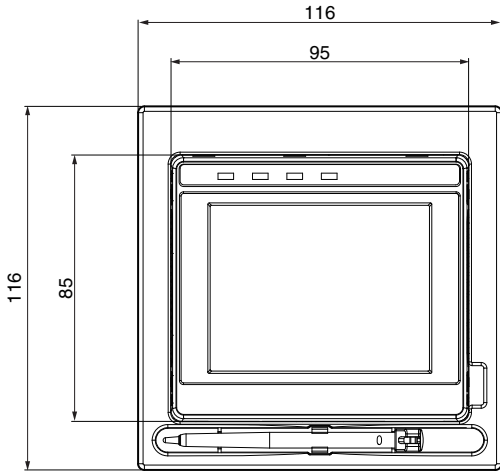

- Panel cutout dimensions

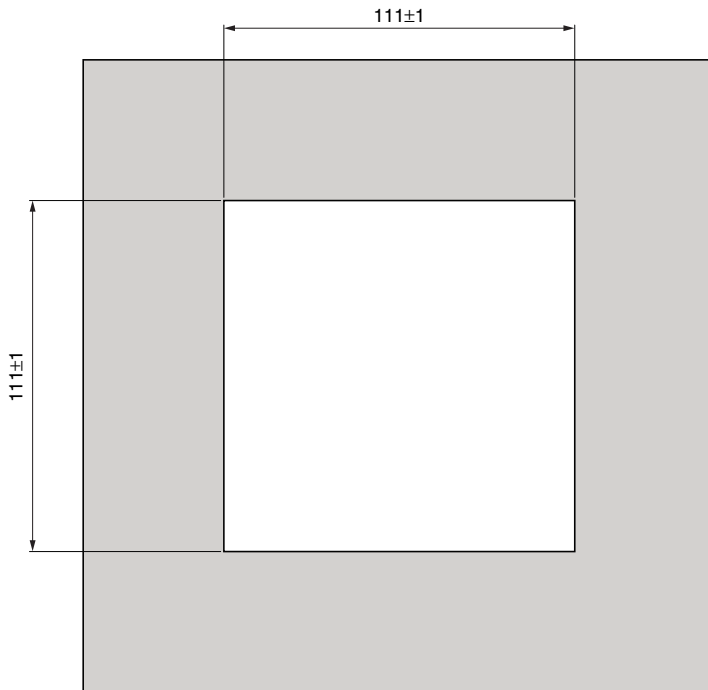

System Requirements for PC Tool for FQ

The system requirements for the PC Tool are given in the following table.

Item	Requirement
OS	<ul style="list-style-type: none"> Microsoft Windows XP Home Edition/Professional SP2 or higher^{*1} Microsoft Windows 7 Home Premium or higher^{*1}
Hardware	<ul style="list-style-type: none"> CPU: Core 2 Duo 1.06 GHz or the equivalent or higher RAM: 1 GB min. HDD: 500 MB min. available space^{*2} Monitor: 1,024 x 768 dots min.

*1. The Japanese and English versions support only 32-bit OS versions.

*2. Available space is also required separately for data logging.

Options

Specifications

• I/O Cables

Item	Model	FQ-WD002	FQ-WD010	FQ-WD020
Cable length		2 m	10 m	20 m
Cable type		Robot cable		
Wire gauge	Power line	AWG24	AWG24 to AWG20	
	Other lines	AWG28		
Cable diameter		6.4	6.4 to 6.7	
Minimum bending radius		41.4 mm		
Weight		100 g	500 g	1500 g

• FQ Ethernet Cable

Item	Model	FQ-WN002	FQ-WN010	FQ-WN020
Cable length		2 m	10 m	20 m
Cable type		Robot cable		
Minimum bending radius		40 mm		
Weight		125 g	620 g	1780 g

• AC Adapter

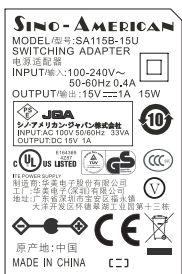
Item	Model	FQ-AC1	FQ-AC2	FQ-AC3	FQ-AC4	FQ-AC5	FQ-AC6
Plug type		A	A	A	C	BF	O
Certified standards		PSE	UL/CSA	CCC mark	---	---	---
Input voltage		100 to 240 VAC (90 to 264 VAC)					
Input current		0.4 A max., 100 VAC, 50 Hz when connected to maximum load					
Input frequency		47 to 63 Hz					
Output voltage		15 VDC±5%					
Output current		1 A max.					
Ambient temperature range		Operating: 0 to 40°C Storage: -20 to 65°C (with no icing or condensation)					
Ambient humidity range		Operating and storage: 35% to 80% (with no condensation)					
Material		Case: PPE					
Cable length		1.5 m					
Dimensions		78 × 50 × 30 mm (without power cable)					
Weight		Approx. 270 g					
Contents of label on AC Adapter		 <p>SINO-AMERICAN MODEL/型号: SA115B-15U SWITCHING ADAPTER 電源适配器 INPUT/输入: 100-240V~ 50-60Hz 0.4A OUTPUT/输出: 15V=1A 15W</p> <p>JSA シノアメリカン・ジャパン株式会社 INPUT/AC: 100V 50/60Hz 33VA OUTPUT/DC: 15V 1A</p> <p>UL LISTED 原産地: 中国 MADE IN CHINA</p>					

Dimensions

• I/O Cables

FQ-WD002

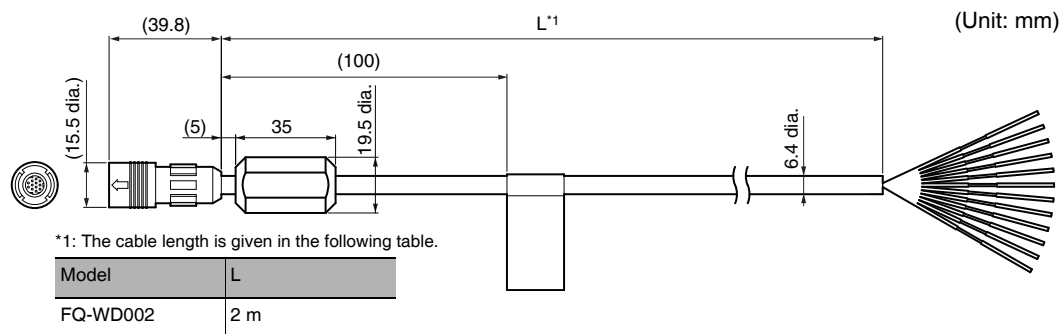

FQ-WD010/WD020

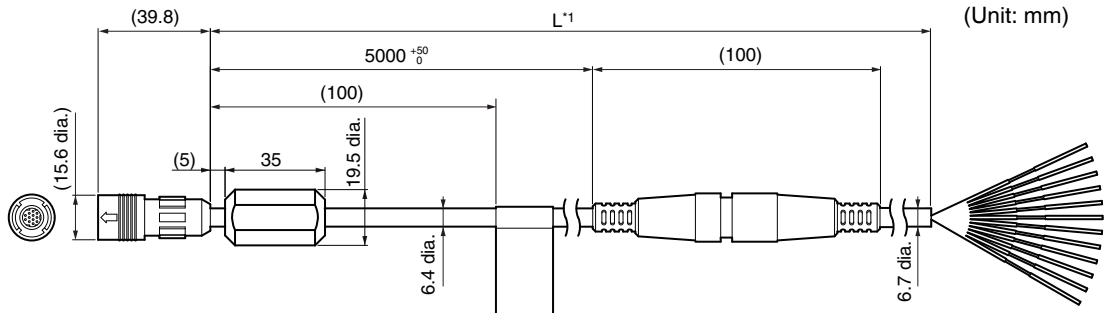

*1: The cable length is given in the following table.

Model	L
FQ-WD010	10 m
FQ-WD020	20 m

• FQ Ethernet Cable

FQ-WN002/WN010/WN020

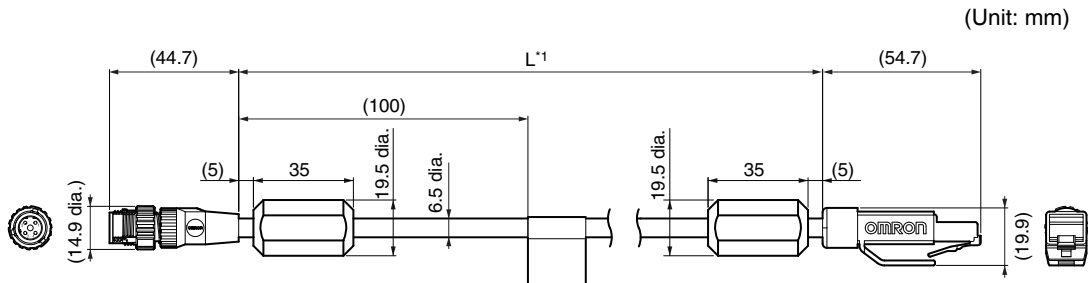

*1: The cable lengths are given in the following table.

Model	L
FQ-WN002	2 m
FQ-WN010	10 m
FQ-WN020	20 m

• AC Adapter

FQ-AC□

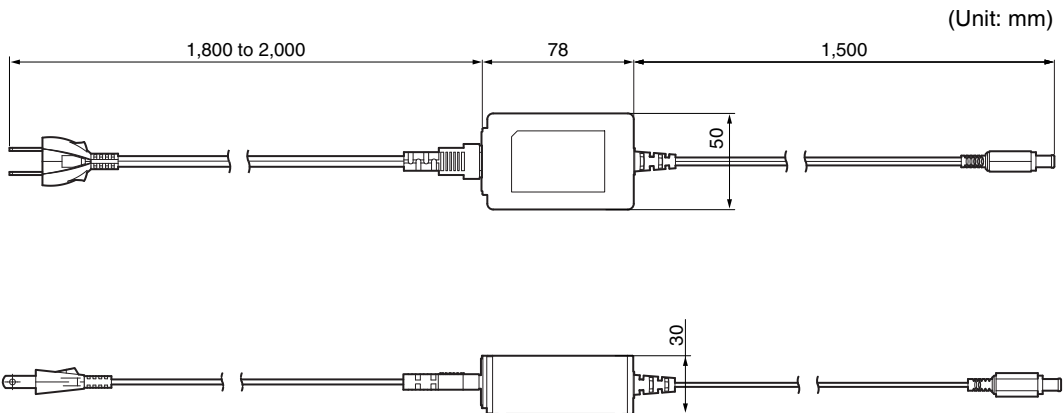

10-4 Updating the Software

The most recent version of the software and PC Tool can be downloaded from the following website for OMRON members. Refer to the *Member Registration Sheet* that is enclosed with the Sensor.



http://www.omron-cxone.com/vision_sys

After you download the software, use the following procedure to update.

- Updating from the PC Tool

- 1** Store the update file you obtained in the following directory.
\\...\My Documents\OMRON FQ\SDCard\UPDATE\SENSOR
- 2** To update the software in the Sensor, press  (Setup Mode) - [Sensor settings] - [Update].

- Updating from the Touch Finder

- 1** Place the update file that you obtained directly in the root folder of the SD card.
- 2** Insert an SD card into the Touch Finder.
- 3** To update the software in the Sensor, press  (Setup Mode) - [Sensor settings] - [Update].
- 4** To update the software in the Touch Finder, press  (Setup Mode) - [TF settings] - [Update].

The software will be updated automatically.

Important

Do not turn OFF the power supply until updating the software has been completed.
The Sensor or Touch Finder may not start normally if power is turned OFF during the update.

MEMO

Index

Numerics			
2D-code		58	
<hr/>			
A			
AC Adapter		191	
AC power supply connector			
Touch Finder		20	
adjusting parameters			
Adjustment mode in Run		89	
adjustment during operation		89	
all regions		85	
auto connect		14	
Automatic teaching		129	
<hr/>			
B			
backing up data		109	
backlight		96	
Bar code		52	
Battery		30	
specifications		187	
battery level		116	
brightness		38, 96	
BUSY output		104	
BUSY polarity		128	
BUSY: ON		128	
READY: ON		128	
BUSY signal		118	
<hr/>			
C			
camera input		85	
camera setup		37	
capturing		113	
changing line process			
using scenes		92	
Check digit on/off		56	
Code type (2D-code)		62	
Code type (Bar code)		56	
Composite codes on/off		56	
configuration		50	
connecting to more than one Sensor		98	
connection			
automatic		14	
CSV		104	
<hr/>			
D			
data			
backup		109	
saving		79, 109	
saving to file		109	
DC power supply connector			
Touch Finder		20	
decimal symbol		104	
deleting log		106	
display elements		15	
display language		115	
display patterns		85, 113	
display types			
Graphics		84	
Graphics + Details		84	
<hr/>			
Statistical data		84	
displaying image data		114	
<hr/>			
E			
ECO mode		96	
error history		162, 163	
deleting		163	
viewing		163	
ERROR signal		131	
errors			
clearing		129	
messages		163	
Ethernet		32	
Ethernet cable		190	
connector		19	
Ethernet port			
Touch Finder		20	
exposure time		39	
external trigger		119	
<hr/>			
F			
field separator		104	
file format		104	
files			
logging		102	
focus		37	
adjustment screw		37	
formatting SD cards		111	
FQ Ethernet Cable		190	
frozen images		94	
<hr/>			
G			
GUI			
language		115	
<hr/>			
H			
HDR function		39	
hiding menus		96	
high dynamic range		39	
histograms		87	
auto display		87	
display range			
class		87	
number of data		88	
<hr/>			
I			
I/O Cable		27	
connector		19	
I/O Cables		190	
I/O monitor		97	
image data			
logging		102	
image input			
increasing speed		76	
partial input		76	
images			
displaying last NG image		95	
displaying saved images		95	
frozen		94	
live		94	

updating	95
zooming in	94
zooming out	94
zooming to fit display	94
individual judgements	124
initialize	115
initializing	
Sensor and Touch Finder	115
input mode	170
inputs	
IN0 to IN5	27
TRIG	27
inspection items	48
copying	51
deleting	51
renaming	51
integrated Sensor lighting	115
IP address	34

J

judgements	
adjusting	77
all results/region	78
individual	124
overall	123

L

language	115
LCD backlight	96
level output	127
lighting	115
control	115
live images	94
loading data from files	109
logging	102, 103
deleting log	106
recent results	105
selecting data to be logged	102
settings	102
starting and stopping	103

M

MAC address	173, 174
measurement data	
logging	102
measurement time	76
measurements	
continuous	121, 129
takt time	76
Memory State	116
menus	
hiding	96
mounting	
control panel	24
DIN Track	24
Mounting Bracket	19
mutual interference	
preventing	46

N

NPN	28
-----	----

O

one-shot output	127
operation	81
operation indicators	
BUSY	19
CHARGE	20
ERROR	19, 20
ETN	19
OR	19
POWER	20
SD ACCESS	20
Touch Finder	20
Vision Sensor	19
optical charts	21
OR signal	118
output delay	127
output mode	127
output polarity	128
NG: ON	128
OK: ON	128
output time	127
outputs	
BUSY	27
ERROR	27
OR	27
OUT0	27
OUT1	27
OUT2	27
overall judgements	123

P

Panel Mounting Adapter	24, 189
password	112
PC Tool	18, 190
PNP	28
Polarizing Filter	
using	40
position compensation	42, 85
power supply switch	
Touch Finder	20
Preventing Mutual Interference of Multiple Sensors	46

R

record separator	104
re-measuring	74
renaming Sensor	116
restart	115
restarting	
Sensor and Touch Finder	115
Run Mode	15, 82

S

saved images	
displaying	95
saving data	79, 109
saving data to files	109
saving image data	114
scene data	
saving	109
scene group data	
saving	109

scenes	
changing	92
changing names	93
copying	93
deleting	93
switching	129
SD card	
available space	111
formatting	111
information	111
operations	110
slot	20
Sensor data	
saving all Sensor data	109
Sensor information	116
Sensor monitor	84
Sensor selection	113
Sensor system data	
saving	109
Sensors	
renaming	116
specifications	182
switching	36
Setup Mode	15
returning to Setup Mode	83
startup display	85
startup mode	93
startup scene	93
startup settings	93
statistical data	
logging	106
straps	25
subnet mask	34
Switch Sensor	36
Switching Hub	18
system configuration	18
<hr/>	
T	
test measurements	
continuous test	74
performing	74
Test Tab Page	74
time	
Touch Finder	115
Touch Finder	
information	116
model with AC/DC/battery power supply	186
model with DC power supply	186
time settings	115
Touch Finder data	
saving	109
trend monitor	86
Auto display	86
Display range	86
Number of data	87
TRIG signal	118
trigger delay	44, 46
<hr/>	
U	
updating	
software version	193

<hr/>	
V	
versions	116
<hr/>	
W	
wiring	27
Sensor	27
Touch Finder	29
<hr/>	
Z	
zooming	94

Revision History

A manual revision code appears as a suffix to the catalog number at the bottom of the front and back covers of this manual.

Cat. No. Z329-E1-02

↑
Revision code

Revision code	Date	Revised contents
01	August 2012	Original production
02	August 2015	Additions corresponding to change of EN standard.

OMRON Corporation Industrial Automation Company

Kyoto, JAPAN

Contact: www.ia.omron.com

Regional Headquarters

OMRON EUROPE B.V.

Sensor Business Unit

Carl-Benz-Str. 4, D-71154 Nufringen, Germany
Tel: (49) 7032-811-0/Fax: (49) 7032-811-199

OMRON ASIA PACIFIC PTE. LTD.

No. 438A Alexandra Road # 05-05/08 (Lobby 2),
Alexandra Technopark,
Singapore 119967
Tel: (65) 6835-3011/Fax: (65) 6835-2711

OMRON ELECTRONICS LLC

2895 Greenspoint Parkway, Suite 200
Hoffman Estates, IL 60169 U.S.A.
Tel: (1) 847-843-7900/Fax: (1) 847-843-7787

OMRON (CHINA) CO., LTD.

Room 2211, Bank of China Tower,
200 Yin Cheng Zhong Road,
PuDong New Area, Shanghai, 200120, China
Tel: (86) 21-5037-2222/Fax: (86) 21-5037-2200

Authorized Distributor:

© OMRON Corporation 2012 All Rights Reserved.
In the interest of product improvement,
specifications are subject to change without notice.

Cat. No. Z329-E1-02

0815