

NEW

OMRON

Digital Controllers

E5□N-H/-HT

Programmable Controllers Join the Series!



» Advanced Controllers That Support Temperature and Process Control with Higher Speed and Greater Precision

» Excellent Cost Performance from Controllers with Programmed Control

» Improved Viewing Angle and Contrast Ratio with New Liquid Crystal Display.

realizing

Programmable Models Now Added to the Series, Which Already Has Three Million Controllers in Service

The new models carry on the simple operation and low cost of the series.

A wide variety of applications can be handled by using program settings with up to 256 segments.

High-level of Basic Performance to Meet a Broad Range of Needs

High performance

High Precision

±0.1% PV

Thermocouple or Pt: ±0.1% PV,
Analog input: 0.1% FS

High-resolution for Measurements,
Fluctuation Detection,
and Logging of Temperature and Humidity
in Environmental Testing Equipment

High-speed Sampling Period

60 ms

Sampling Rate Sufficient to Handle
Rapid Increases in Temperature

Stable Control of Objects Requiring High-speed
Response by Handling Rapid Increases in
Temperature, Such As for Ceramic Heaters

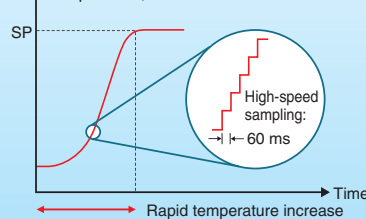

Five Digits and K Thermocouple

0.01°C Display

Five-digit PV/SV Display to
0.01°C for High Performance

Display to 0.01°C for Pt, K, J, or T.
Enables high-precision temperature control.



Programmable Models Added to Lineup to Support a Broader Range of Applications

Wide application

Up to 256 Segments

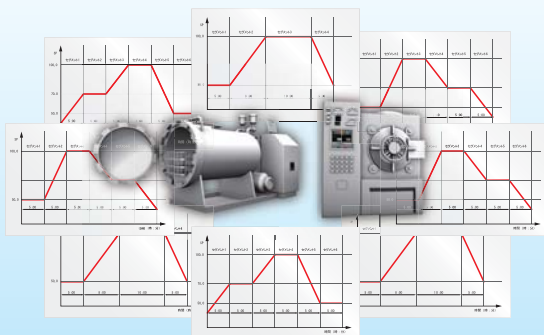

You can program up to
8 programs × 32 segments.

The CX-Thermo Support Software (Sold Separately)
Enables Easy Setting and Control of Programs.

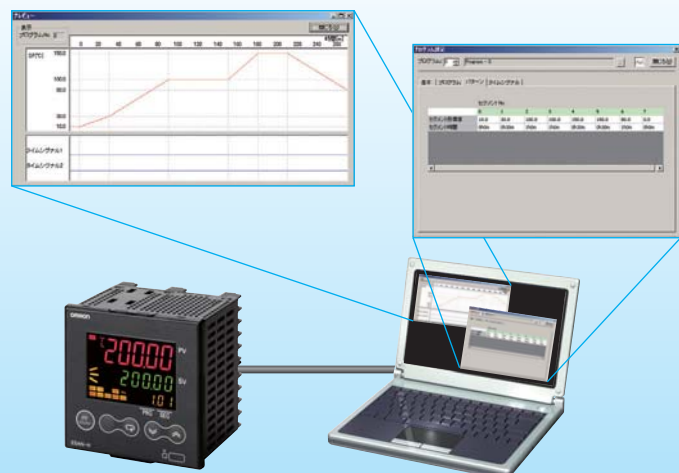

High Cost Performance Makes Selection Easy

Affordable price

Best Value in a Programmable Temperature Controller at an Affordable Price.



Easy Setting and Monitoring

Easy-to-use

Easy Parameter Setting on a Computer Using the CX-Thermo (Sold Separately)

Using the trend monitor enables easy adjustment and maintenance.

Parameter Masking

Customize the menu display to match the worksite. Display can be turned OFF for parameters that are not necessary to better match the worksite. This helps prevent incorrect operation for both the operator and the Controller.

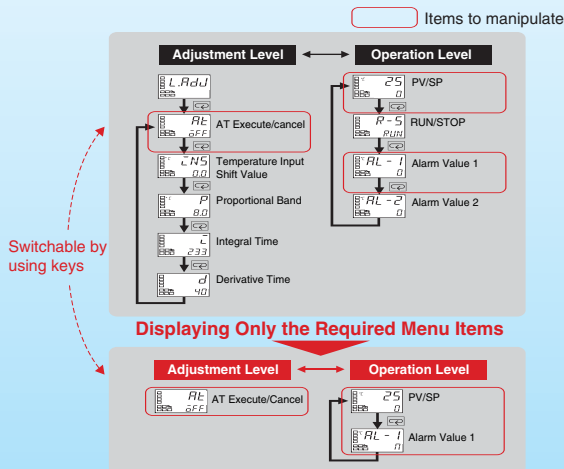

Infrared Communications Port

Perform communications with a computer by using the infrared communications port on the front panel (except for the E5CN-H and E5CN-HT). The ability to use CX-Thermo from the front panel after the Controller has been mounted to a control panel reduces maintenance time.



Easy Logic Operations

Easily perform logic operations without a PLC. Effectively use limited I/O by combining I/O bit status and alarm status through AND and OR logic operations or by inverting event input logic.

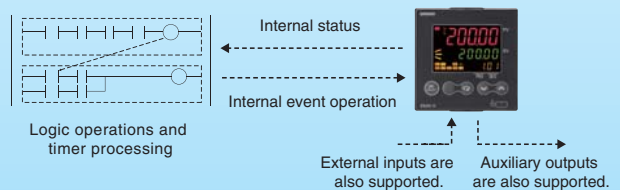

New Liquid Crystal Display Provides Superior Visibility

High visibility

New, High-visibility Display That Is Ideal for High-performance Temperature Controllers

From



Previous Display

To

Sharp Black!

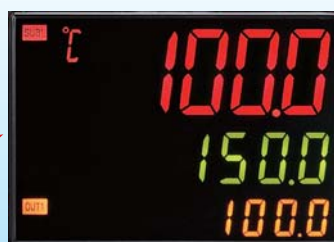

New Liquid Crystal Display

Wider Viewing Angle

The new liquid crystal display provides a wider viewing angle. This also enables a wider range of mounting locations.

Improved Contrast Ratio

Visibility remains stable regardless of the light intensity level at the worksite.

Application Examples

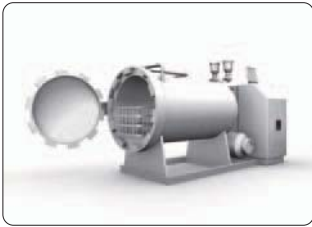

Sterilization Equipment for Food and Pharmaceuticals



Heating Ovens



Scientific Equipment

Support is provided for more applications:
 Solar cell manufacturing equipment,
 Secondary battery manufacturing equipment,
 Semiconductor manufacturing equipment,
 Electronic component manufacturing equipment,
 Food processing equipment, etc.

Product Lineup

Price	Advanced Type			Programmable Type		
	E5CN-H	E5EN-H	E5AN-H	E5CN-HT	E5EN-HT	E5AN-HT
Size and display	48 x 48mm	48 x 96mm	96 x 96mm	48 x 48mm	48 x 96mm	96 x 96mm
	2 displays	3 displays		2 displays	3 displays	
	Changing PV color, status displays					
Simple operation	Support Software port on bottom	Infrared Support Software port on front and Support Software port on bottom		Support Software port on bottom	Infrared Support Software port on front and Support Software port on bottom	
	Auto-tuning, self-tuning, and robust tuning			Auto-tuning and robust tuning		
Easy maintenance	Models with fully universal inputs (thermocouple, Pt, or analog can be selected)					
	Loop burnout detection and PV change ratio alarm					
	Heater (single-phase or three-phase) burnout alarm, heater short alarm, heater overcurrent alarm, and alarm delay					
	Degree of protection for front: IP66					
High speed and high precision	Five-digit display: Display to 0.01°C for Pt, K, J, or T inputs, display to 0.1°C for full range.					
	Sampling period: 60 ms					
	Thermocouple, Pt, or analog: 0.1%					
Advanced controls	Banks (Switch between 8 SPs, 8 alarm settings, and 8 PID sets.)			Selectable from 8 PID sets		
	Event inputs: 2 max.	Event inputs: 2 or 4 max.		Event inputs: 2 max.	Event inputs: 2 or 4 max.	
	Event input assignments: Bank change, RUN/STOP, auto/manual switch, program start, invert direct/reverse operation, 100% AT execute/cancel, 40% AT execute/cancel, setting change enable/disable, communications write enable/disable, and alarm latch cancel	Event input assignments: Remote SP mode and local SP mode, in addition to the functions at the left		Event input assignments: Program number switch, run/reset, reset, run, auto/manual switch, hold/clear hold, hold, advance, program SP mode/fix SP mode, wait enable/disable, invert direct/reverse operation, 100% AT execute/cancel, 40% AT execute/cancel, setting change enable/disable, communications write enable/disable, alarm latch cancel	Event input assignments: Program SP mode/remote SP mode and remote SP mode/fix SP mode, in addition to the functions at the left	
	Simple programming (16 segments)	Remote SP		Program control functions: 8 programs x 32 segments, time setting of 0 hours 0 minutes to 99 hours 59 minutes or 0 minutes 0 seconds to 99 minutes 59 seconds, alarm setting for each program, time signals, waits, program repeats, program links, and other functions can be set.	Remote SP	
Variations	—	Models with position-proportional control are available.		—	Models with position-proportional control are available.	
	The control output section is integrated into the Controller.	A Controller and Control Output Unit are combined.		The control output section is integrated into the Controller.	A Controller and Control Output Unit are combined.	
		1 or 2 control outputs			1 or 2 control outputs	
		2 auxiliary outputs			2 or 3 auxiliary outputs	

OMRON Corporation Industrial Automation Company
 Tokyo, JAPAN

Contact: www.ia.omron.com

Regional Headquarters

OMRON EUROPE B.V.
 Wegalaan 67-69-2132 JD Hoofddorp
 The Netherlands
 Tel: (31)2356-81-300/Fax: (31)2356-81-388

OMRON ELECTRONICS LLC
 One Commerce Drive Schaumburg,
 IL 60173-5302 U.S.A.
 Tel: (1) 847-843-7900/Fax: (1) 847-843-7787

OMRON ASIA PACIFIC PTE. LTD.
 No. 438A Alexandra Road # 05-05/08 (Lobby 2),
 Alexandra Technopark,
 Singapore 119967
 Tel: (65) 6835-3011/Fax: (65) 6835-2711

OMRON (CHINA) CO., LTD.
 Room 2211, Bank of China Tower,
 200 Yin Cheng Zhong Road,
 PuDong New Area, Shanghai, 200120, China
 Tel: (86) 21-5037-2222/Fax: (86) 21-5037-2200

Authorized Distributor:

© OMRON Corporation 2010 All Rights Reserved.
 In the interest of product improvement,
 specifications are subject to change without notice.

Cat. No. H171-E1-01

Printed in Japan
 1110