

**E5CN-HT**  
**E5AN-HT**  
**E5EN-HT**

## Digital Controllers

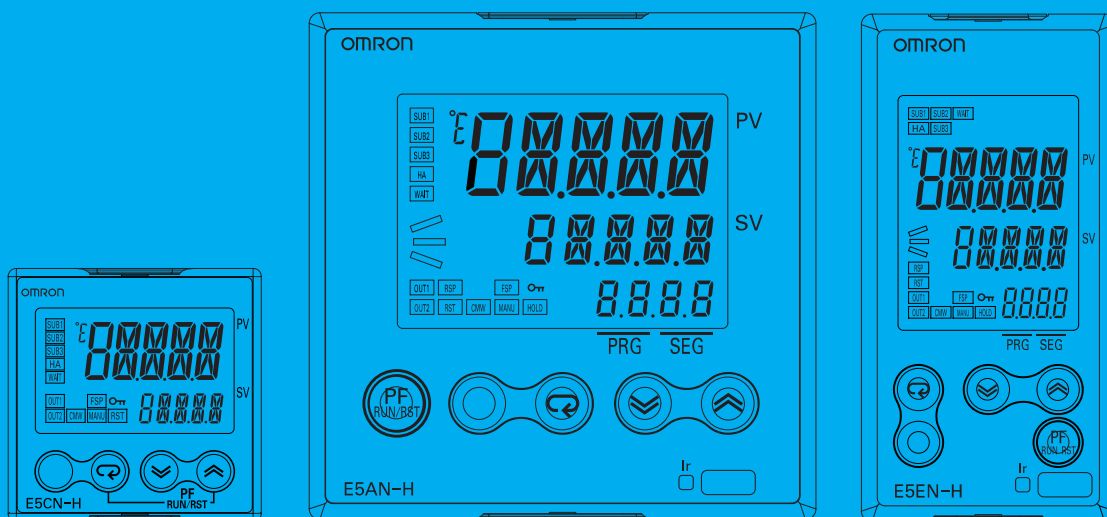

## User's Manual Programmable Type



**E5CN-HT**  
**E5AN-HT**  
**E5EN-HT**  
**Digital Controllers**

**User's Manual**

**Programmable Type**

*Revised February 2020*



# Preface

The E5CN-HT, E5AN-HT, and E5EN-HT are Programmable Digital Controllers. The main functions and characteristics of these Digital Controllers are as follows:

- Use the universal inputs to input from thermocouples or temperature-resistance thermometers, or to input analog voltage or analog current inputs.
- Either standard or heating/cooling control can be performed.
- Auto-tuning can be used to tune parameters.
- Event inputs can be used to switch programs, switch between run and reset status, switch between automatic and manual operation, and perform other operations.
- Heater burnout detection, heater short (HS) alarms, and heater overcurrent (OC) functions are supported. (Applicable to E5CN-HT, E5AN-HT, and E5EN-HT models with heater burnout detection function.)
- Communications are supported. (Applicable to E5CN-HT, E5AN-HT, and E5EN-HT models with communications.)
- User calibration of the sensor input is supported.
- User calibration of transfer output is supported. (Applicable to E5CN-HT, E5AN-HT, and E5EN-HT models with transfer outputs.)
- Use position-proportional control. (Applicable to the E5AN-HT and E5EN-HT.)
- Use a remote SP input (Applicable to the E5AN-HT and E5EN-HT.)
- The structure is waterproof (IP66).
- Conforms to UL, CSA, and IEC safety standards and EMC Directive.
- The PV display color can be switched to make process status easy to understand at a glance.
- Up to 8 programs (patterns) can be created and each program can have up to 32 segments (steps).

This manual describes the E5CN-HT, E5AN-HT, and E5EN-HT. Read this manual thoroughly and be sure you understand it before attempting to use the Digital Controller and use the Digital Controller correctly according to the information provided. Keep this manual in a safe place for easy reference. Refer to the following manual for further information on communications: *E5CN-HT/E5AN-HT/E5EN-HT Digital Controllers Communications Manual Programmable Type* (Cat. No. H170).

For information on the E5CN-H, E5AN-H, and E5EN-H Advanced Type Digital Controllers, refer to the *E5CN-H/E5AN-H/E5EN-H Digital Controllers Advanced Type User's Manual* (Cat. No. H157).

For information on the E5CN, E5AN, E5EN, and E5GN Basic Type Digital Controllers, refer to the *E5CN/E5AN/E5EN/E5GN Digital Controllers Basic Type User's Manual* (Cat. No. H156).

A PDF version of these manuals can be downloaded from the OMRON website.

<http://www.ia.omron.com>

## Visual Aids

The following headings appear in the left column of the manual to help you locate different types of information.

**Note** Indicates information of particular interest for efficient and convenient operation of the product.

**1,2,3...** 1. Indicates lists of one sort or another, such as procedures, checklists, etc.

**© OMRON, 2020**

All rights reserved. No part of this publication may be reproduced, stored in a retrieval system, or transmitted, in any form, or by any means, mechanical, electronic, photocopying, recording, or otherwise, without the prior written permission of OMRON.

No patent liability is assumed with respect to the use of the information contained herein. Moreover, because OMRON is constantly striving to improve its high-quality products, the information contained in this manual is subject to change without notice. Every precaution has been taken in the preparation of this manual. Nevertheless, OMRON assumes no responsibility for errors or omissions. Neither is any liability assumed for damages resulting from the use of the information contained in this publication.

# ***Terms and Conditions Agreement***

## ***Warranty, Limitations of Liability***

### **Warranties**

#### **● Exclusive Warranty**

Omron's exclusive warranty is that the Products will be free from defects in materials and workmanship for a period of twelve months from the date of sale by Omron (or such other period expressed in writing by Omron). Omron disclaims all other warranties, express or implied.

#### **● Limitations**

OMRON MAKES NO WARRANTY OR REPRESENTATION, EXPRESS OR IMPLIED, ABOUT NON-INFRINGEMENT, MERCHANTABILITY OR FITNESS FOR A PARTICULAR PURPOSE OF THE PRODUCTS. BUYER ACKNOWLEDGES THAT IT ALONE HAS DETERMINED THAT THE PRODUCTS WILL SUITABLY MEET THE REQUIREMENTS OF THEIR INTENDED USE.

Omron further disclaims all warranties and responsibility of any type for claims or expenses based on infringement by the Products or otherwise of any intellectual property right.

#### **● Buyer Remedy**

Omron's sole obligation hereunder shall be, at Omron's election, to (i) replace (in the form originally shipped with Buyer responsible for labor charges for removal or replacement thereof) the non-complying Product, (ii) repair the non-complying Product, or (iii) repay or credit Buyer an amount equal to the purchase price of the non-complying Product; provided that in no event shall Omron be responsible for warranty, repair, indemnity or any other claims or expenses regarding the Products unless Omron's analysis confirms that the Products were properly handled, stored, installed and maintained and not subject to contamination, abuse, misuse or inappropriate modification. Return of any Products by Buyer must be approved in writing by Omron before shipment. Omron Companies shall not be liable for the suitability or unsuitability or the results from the use of Products in combination with any electrical or electronic components, circuits, system assemblies or any other materials or substances or environments. Any advice, recommendations or information given orally or in writing, are not to be construed as an amendment or addition to the above warranty.

See <http://www.omron.com/global/> or contact your Omron representative for published information.

### **Limitation on Liability; Etc**

OMRON COMPANIES SHALL NOT BE LIABLE FOR SPECIAL, INDIRECT, INCIDENTAL, OR CONSEQUENTIAL DAMAGES, LOSS OF PROFITS OR PRODUCTION OR COMMERCIAL LOSS IN ANY WAY CONNECTED WITH THE PRODUCTS, WHETHER SUCH CLAIM IS BASED IN CONTRACT, WARRANTY, NEGLIGENCE OR STRICT LIABILITY.

Further, in no event shall liability of Omron Companies exceed the individual price of the Product on which liability is asserted.

# ***Application Considerations***

## **Suitability of Use**

Omron Companies shall not be responsible for conformity with any standards, codes or regulations which apply to the combination of the Product in the Buyer's application or use of the Product. At Buyer's request, Omron will provide applicable third party certification documents identifying ratings and limitations of use which apply to the Product. This information by itself is not sufficient for a complete determination of the suitability of the Product in combination with the end product, machine, system, or other application or use. Buyer shall be solely responsible for determining appropriateness of the particular Product with respect to Buyer's application, product or system. Buyer shall take application responsibility in all cases.

NEVER USE THE PRODUCT FOR AN APPLICATION INVOLVING SERIOUS RISK TO LIFE OR PROPERTY OR IN LARGE QUANTITIES WITHOUT ENSURING THAT THE SYSTEM AS A WHOLE HAS BEEN DESIGNED TO ADDRESS THE RISKS, AND THAT THE OMRON PRODUCT(S) IS PROPERLY RATED AND INSTALLED FOR THE INTENDED USE WITHIN THE OVERALL EQUIPMENT OR SYSTEM.

## **Programmable Products**

Omron Companies shall not be responsible for the user's programming of a programmable Product, or any consequence thereof.

## ***Disclaimers***

### **Performance Data**

Data presented in Omron Company websites, catalogs and other materials is provided as a guide for the user in determining suitability and does not constitute a warranty. It may represent the result of Omron's test conditions, and the user must correlate it to actual application requirements. Actual performance is subject to the Omron's Warranty and Limitations of Liability.

### **Change in Specifications**

Product specifications and accessories may be changed at any time based on improvements and other reasons. It is our practice to change part numbers when published ratings or features are changed, or when significant construction changes are made. However, some specifications of the Product may be changed without any notice. When in doubt, special part numbers may be assigned to fix or establish key specifications for your application. Please consult with your Omron's representative at any time to confirm actual specifications of purchased Product.

### **Errors and Omissions**

Information presented by Omron Companies has been checked and is believed to be accurate; however, no responsibility is assumed for clerical, typographical or proofreading errors or omissions.



## Safety Precautions

### ■ Definition of Precautionary Information

The following notation is used in this manual to provide precautions required to ensure safe usage of the product.

The safety precautions that are provided are extremely important to safety. Always read and heed the information provided in all safety precautions.

The following notation is used.







Indicates a potentially hazardous situation which, if not avoided, is likely to result in minor or moderate injury or in property damage.

### ■ Symbols

Symbol		Meaning
Caution		<b>General Caution</b> Indicates non-specific general cautions, warnings, and dangers.
		<b>Electrical Shock Caution</b> Indicates possibility of electric shock under specific conditions.
Prohibition		<b>General Prohibition</b> Indicates non-specific general prohibitions.
Mandatory Caution		<b>General Caution</b> Indicates non-specific general cautions, warnings, and dangers.

## ■ Safety Precautions

 <b>CAUTION</b>	
Do not touch the terminals while power is being supplied. Doing so may occasionally result in minor injury due to electric shock.	
Do not allow pieces of metal, wire clippings, or fine metallic shavings or filings from installation to enter the product. Doing so may occasionally result in electric shock, fire, or malfunction.	
Do not use the product where subject to flammable or explosive gas. Otherwise, minor injury from explosion may occasionally occur.	
Never disassemble, modify, or repair the product or touch any of the internal parts. Minor electric shock, fire, or malfunction may occasionally occur.	
<p><b>CAUTION - Risk of Fire and Electric Shock</b></p> <p>a) This product is UL listed as Open Type Process Control Equipment. It must be mounted in an enclosure that does not allow fire to escape externally.</p> <p>b) When using more than one shutoff switch, always turn OFF all the shutoff switches to ensure that no power is being supplied before servicing the product.</p> <p>c) Signal inputs are SELV, limited energy. (See note 1.)</p> <p>d) Caution: To reduce the risk of fire or electric shock, do not interconnect the outputs of different Class 2 circuits. (See note 2.)</p>	
<p>If the output relays are used past their life expectancy, contact fusing or burning may occasionally occur.</p> <p>Always consider the application conditions and use the output relays within their rated load and electrical life expectancy. The life expectancy of output relays varies considerably with the output load and switching conditions.</p>	

Note 1: An SELV circuit is one separated from the power supply with double insulation or reinforced insulation, that does not exceed 30 V r.m.s. and 42.4 V peak or 60 VDC.

Note 2: A class 2 power supply is one tested and certified by UL as having the current and voltage of the secondary output restricted to specific levels.

 **CAUTION**

Tighten the terminal screws to between 0.74 and 0.90 N·m. Loose screws may occasionally result in fire.

Set the parameters of the product so that they are suitable for the system being controlled. If they are not suitable, unexpected operation may occasionally result in property damage or accidents.

A malfunction in the Digital Controller may occasionally make control operations impossible or prevent alarm outputs, resulting in property damage. To maintain safety in the event of malfunction of the Digital Controller, take appropriate safety measures, such as installing a monitoring device on a separate line.

When inserting the body of the Digital Controller into the case, confirm that the hooks on the top and bottom are securely engaged with the case. If the body of the Digital Controller is not inserted properly, faulty contact in the terminal section or reduced water resistance may occasionally result in fire or malfunction.

When connecting the Control Output Unit to the socket, press it in until there is no gap between the Control Output Unit and the socket. Otherwise contact faults in the connector pins may occasionally result in fire or malfunction.



## Precautions for Safe Use

Be sure to observe the following precautions to prevent operation failure, malfunction, or adverse affects on the performance and functions of the product. Not doing so may occasionally result in unexpected events. Do not handle the Controller in ways that exceed product specifications.

- 1) The product is designed for indoor use only. Do not use or store the product in any of the following places.
  - Places directly subject to heat radiated from heating equipment.
  - Places subject to splashing liquid or oil atmosphere.
  - Places subject to direct sunlight.
  - Places subject to dust or corrosive gas (in particular, sulfide gas and ammonia gas).
  - Places subject to intense temperature change.
  - Places subject to icing and condensation.
  - Places subject to vibration and large shocks.
- 2) Use and store the Digital Controller within the rated ambient temperature and humidity.

Gang-mounting two or more Digital Controllers, or mounting Digital Controllers above each other may cause heat to build up inside the Digital Controllers, which will shorten their service life. In such a case, use forced cooling by fans or other means of air ventilation to cool down the Digital Controllers.
- 3) To allow heat to escape, do not block the area around the product. Do not block the ventilation holes on the product.
- 4) Be sure to wire properly with correct polarity of terminals.
- 5) Use specified size (M3.5, width 7.2 mm or less) crimped terminals for wiring. To connect bare wires, use stranded or solid copper wires with a gage of AWG24 to AWG14 (equal to cross-sectional areas of 0.205 to 2.081 mm<sup>2</sup>). (The stripping length is 5 to 6 mm.) Up to two wires of same size and type, or two crimp terminals can be inserted into a single terminal.
- 6) Do not wire the terminals which are not used.
- 7) To avoid inductive noise, keep the wiring for the Digital Controller's terminal block away from power cables carry high voltages or large currents. Also, do not wire power lines together with or parallel to Digital Controller wiring. Using shielded cables and using separate conduits or ducts is recommended.

Attach a surge suppressor or noise filter to peripheral devices that generate noise (in particular, motors, transformers, solenoids, magnetic coils or other equipment that have an inductance component).  
When a noise filter is used at the power supply, first check the voltage or current, and attach the noise filter as close as possible to the Digital controller.  
Allow as much space as possible between the Digital Controller and devices that generate powerful high frequencies (high-frequency welders, high-frequency sewing machines, etc.) or surge.
- 8) Use this product within the rated load and power supply.
- 9) Make sure that the rated voltage is attained within two seconds of turning ON the power using a switch or relay contact. If the voltage is applied gradually, the power may not be reset or output malfunctions may occur.
- 10) Make sure that the Digital Controller has 30 minutes or more to warm up after turning ON the power before starting actual control operations to ensure the correct temperature display.
- 11) A switch or circuit breaker should be provided close to this unit. The switch or circuit breaker should be within easy reach of the operator, and must be marked as a disconnecting means for this unit.
- 12) Always turn OFF the power supply before pulling out the interior of the product, and never touch nor apply shock to the terminals or electronic components. When inserting the interior of the product, do not allow the electronic components to touch the case.
- 13) Do not use paint thinner or similar chemical to clean with. Use standard grade alcohol.
- 14) Design system considering the 2 second of delay that the controller's output to be set after power ON.
- 15) The output may turn OFF when shifting to certain levels. Take this into consideration when performing control.

- 16) The number of nonvolatile memory write operations is limited. Therefore, use RAM write mode when frequently overwriting data during communications or other operations.
- 17) Always touch a grounded piece of metal before touching the Digital Controller to discharge static electricity from your body.
- 18) Do not remove the terminal block. Doing so may result in failure or malfunction.
- 19) Control outputs that are voltage outputs are not isolated from the internal circuits. When using a grounded thermocouple, do not connect any of the control output terminals to ground. (Doing so may result in an unwanted circuit path, causing error in the measured temperature.)
- 20) When replacing the body of the Digital Controller, check the condition of the terminals. If corroded terminals are used, contact failure in the terminals may cause the temperature inside the Digital Controller to increase, possibly resulting in fire. If the terminals are corroded, replace the case as well.
- 21) Use suitable tools when taking the Digital Controller apart for disposal. Sharp parts inside the Digital Controller may cause injury.
- 22) Check the specifications of the Control Output Unit and assemble it correctly.
- 23) When mounting the Control Output Unit, read and follow all relevant information in the product catalogs and manuals.
- 24) Do not continue to use the Controller if the front surface peels or becomes cracked.

## ● Service Life

Use the Digital Controller within the following temperature and humidity ranges:  
Temperature:  $-10$  to  $55^{\circ}\text{C}$  (with no icing or condensation), Humidity: 25% to 85%

If the Controller is installed inside a control board, the ambient temperature must be kept to under  $55^{\circ}\text{C}$ , including the temperature around the Controller.

The service life of electronic devices like Digital Controllers is determined not only by the number of times the relay is switched but also by the service life of internal electronic components. Component service life is affected by the ambient temperature: the higher the temperature, the shorter the service life and, the lower the temperature, the longer the service life. Therefore, the service life can be extended by lowering the temperature of the Digital Controller.

When two or more Digital Controllers are mounted horizontally close to each other or vertically next to one another, the internal temperature will increase due to heat radiated by the Digital Controllers and the service life will decrease. In such a case, use forced cooling by fans or other means of air ventilation to cool down the Digital Controllers. When providing forced cooling, however, be careful not to cool down the terminals sections alone to avoid measurement errors.

## ● Ambient Noise

To avoid inductive noise, keep the wiring for the Digital Controller's terminal block wiring away from power cables carrying high voltages or large currents. Also, do not wire power lines together with or parallel to Digital Controller wiring. Using shielded cables and using separate conduits or ducts is recommended.

Attach a surge suppressor or noise filter to peripheral devices that generate noise (in particular, motors, transformers, solenoids, magnetic coils or other equipment that have an inductance component). When a noise filter is used at the power supply, first check the voltage or current, and attach the noise filter as close as possible to the Digital Controller.

Allow as much space as possible between the Digital Controller and devices that generate powerful high frequencies (high-frequency welders, high-frequency sewing machines, etc.) or surge.

## ● Ensuring Measurement Accuracy

When extending or connecting the thermocouple lead wire, be sure to use compensating wires that match the thermocouple types.

When extending or connecting the lead wire of the platinum resistance thermometer, be sure to use wires that have low resistance and keep the resistance of the three lead wires the same.

Mount the Digital Controller so that it is horizontally level.

If the measurement accuracy is low, check to see if input shift has been set correctly.

## ● Waterproofing

The degree of protection is as shown below. Sections without any specification on their degree of protection or those with IP□0 are not waterproof.

Front panel: IP66

Rear case: IP20, Terminal section: IP00

To install the Controller so that it is waterproof, insert the Waterproof Packing. The degree of protection when the Waterproof Packing is used is IP66. To maintain an IP66 degree of protection, the Waterproof Packing should be periodically replaced because it may deteriorate, shrink, or harden depending on the operating environment. The replacement period will vary with the operating environment. Check the required period in the actual application. Use one year as a guideline. If the Waterproof Packing is not periodically replaced, waterproof performance may not be maintained. If a waterproof structure is not required, then the Waterproof Packing does not need to be installed.

## Precautions for Operation

- 1) It takes approximately two seconds for the outputs to turn ON from after the power supply is turned ON. Due consideration must be given to this time when incorporating Digital Controllers into a control panel or similar device.
- 2) Make sure that the Digital Controller has 30 minutes or more to warm up after turning ON the power before starting actual control operations to ensure the correct temperature display.
- 3) Avoid using the Controller in places near a radio, television set, or wireless installing. The Controller may cause radio disturbance for these devices.

## Preparations for Use

Be sure to thoroughly read and understand the manual provided with the product, and check the following points.

Timing	Check point	Details
Purchasing the product	Product appearance	After purchase, check that the product and packaging are not dented or otherwise damaged. Damaged internal parts may prevent optimum control.
	Product model and specifications	Make sure that the purchased product meets the required specifications.
Setting the Unit	Product installation location	Provide sufficient space around the product for heat dissipation. Do not block the vents on the product.
Wiring	Terminal wiring	Do not subject the terminal screws to excessive stress (force) when tightening them. Make sure that there are no loose screws after tightening terminal screws to the specified torque of 0.74 to 0.90 N·m.
		Be sure to confirm the polarity for each terminal before wiring the terminal block and connectors.
	Power supply inputs	Wire the power supply inputs correctly. Incorrect wiring will result in damage to the internal circuits.
Operating environment	Ambient temperature	The ambient operating temperature for the product is $-10$ to $55^{\circ}\text{C}$ (with no condensation or icing). To extend the service life of the product, install it in a location with an ambient temperature as low as possible. In locations exposed to high temperatures, if necessary, cool the products using a fan or other cooling method.
	Vibration and shock	Check whether the standards related to shock and vibration are satisfied at the installation environment. (Install the Digital Controller as far as possible from contactors, which can subject the Digital Controller to vibration or shock.)
	Foreign particles	Install the product in a location that is not subject to liquid or foreign particles entering the product.

# Conventions Used in This Manual

## Meanings of Abbreviations

The following abbreviations are used in parameter names, figures and in text explanations. These abbreviations mean the following:

Symbol	Term
PV	Process value
SP	Set point
SV	Set value
AT	Auto-tuning
HB	Heater burnout
HS	Heater short (See note 1.)
OC	Heater overcurrent
LBA	Loop burnout alarm
EU	Engineering unit (See note 2.)
RSP	Remote SP
FSP	Fixed SP
PSP	Program SP

- Note: (1)** A heater short indicates that the heater remains ON even when the control output from the Digital Controller is OFF because the SSR has failed or for any other reason.
- (2)** “EU” stands for Engineering Unit. EU is used as the minimum unit for engineering units such as °C, m, and g. The size of EU varies according to the input type.  
For example, when the input temperature setting range is –20.0 to +500.0°C, 1 EU is 0.1°C.  
For analog inputs, the size of EU varies according to the decimal point position of the scaling setting, and 1 EU becomes the minimum scaling unit.



## How to Read Display Symbols

The following tables show the correspondence between the symbols displayed on the displays and alphabet characters. The default is for 11-segment displays.

A	b	C	d	E	F	G	H	I	J	K	L	M
A	B	C	D	E	F	G	H	I	J	K	L	M

N	ō	P	Q	R	S	T	U	V	W	X	Y	Z
N	O	P	Q	R	S	T	U	V	W	X	Y	Z

The Character Select parameter in the advanced function setting level can be turned OFF to display the following 7-segment characters.

A	b	C	d	E	F	G	H	I	J	K	L	M
A	B	C	D	E	F	G	H	I	J	K	L	M

n	ō	P	q	r	S	T	U	v	Y	ū	Y	≡
N	O	P	Q	R	S	T	U	V	W	X	Y	Z



# TABLE OF CONTENTS

## SECTION 1

<b>Introduction</b> .....	<b>1</b>
1-1 Names of Parts .....	2
1-2 I/O Configuration and Main Functions .....	6
1-3 Setting Level Configuration and Key Operations .....	12
1-4 Communications Function .....	15
1-5 Insulation Block Diagrams .....	17

## SECTION 2

<b>Preparations</b> .....	<b>19</b>
2-1 Installation .....	20
2-2 Wiring Terminals .....	30
2-3 Using the Support Software Port .....	42
2-4 Using Infrared Communications .....	43

## SECTION 3

<b>Basic Operation</b> .....	<b>47</b>
3-1 Initial Setting Examples .....	48
3-2 Setting the Input Type .....	52
3-3 Selecting the Temperature Unit .....	54
3-4 Selecting PID Control or ON/OFF Control .....	54
3-5 Setting Output Specifications .....	55
3-6 Setting Programs .....	60
3-7 Using ON/OFF Control .....	63
3-8 Determining the PID Constants (AT or Manual Settings) .....	65
3-9 Alarm Outputs .....	71
3-10 Using Heater Burnout, Heater Short, and Heater Overcurrent Alarms .....	76
3-11 Setting the No. 3 Display .....	87
3-12 Starting and Stopping Operation (rtsm) .....	89
3-13 Adjusting Programs .....	91

## SECTION 4

<b>Applications Operations</b> .....	<b>93</b>
4-1 Shifting Input Values .....	95
4-2 Adjusting Alarms .....	98
4-3 Setting Scaling Upper and Lower Limits for Analog Inputs .....	100
4-4 Executing Heating/Cooling Control .....	101
4-5 Using Event Inputs .....	105
4-6 Setting the SP Upper and Lower Limit Values .....	110
4-7 Moving to the Advanced Function Setting Level .....	111
4-8 Using the Key Protect Level .....	113
4-9 PV Change Color .....	117
4-10 Alarm Delays .....	120
4-11 Loop Burnout Alarm .....	122

# TABLE OF CONTENTS

4-12	Performing Manual Control . . . . .	126
4-13	Using the Transfer Output . . . . .	132
4-14	Using PID Sets. . . . .	136
4-15	Program-related Functions. . . . .	138
4-16	Output Adjustment Functions . . . . .	148
4-17	Using the Extraction of Square Root Parameter . . . . .	151
4-18	Setting the Width of MV Variation . . . . .	152
4-19	Setting the PF Key . . . . .	154
4-20	Counting Control Output ON/OFF Operations . . . . .	157
4-21	Displaying PV/SV Status. . . . .	159
4-22	Using a Remote SP . . . . .	162
4-23	Position-proportional Control . . . . .	165
4-24	Logic Operations . . . . .	167
 <b>SECTION 5</b>		
<b>Parameters. . . . .</b>		<b>177</b>
5-1	Conventions Used in this Section . . . . .	178
5-2	Protect Level . . . . .	179
5-3	Operation Level . . . . .	183
5-4	Program Setting Level . . . . .	196
5-5	Adjustment Level. . . . .	206
5-6	PID Setting Level. . . . .	226
5-7	Monitor/Setting Item Level . . . . .	230
5-8	Manual Control Level . . . . .	232
5-9	Initial Setting Level . . . . .	234
5-10	Advanced Function Setting Level . . . . .	256
5-11	Communications Setting Level . . . . .	296
 <b>SECTION 6</b>		
<b>CALIBRATION . . . . .</b>		<b>297</b>
6-1	Parameter Structure . . . . .	298
6-2	User Calibration. . . . .	299
6-3	Thermocouple Calibration (Thermocouple/Resistance Thermometer Input) . . . . .	299
6-4	Platinum Resistance Thermometer Calibration (Thermocouple/Resistance Thermometer Input). . . . .	303
6-5	Calibrating Analog Input (Analog Input) . . . . .	304
6-6	Calibrating the Transfer Output. . . . .	306
6-7	Checking Indication Accuracy . . . . .	308
 <b>Appendix . . . . .</b>		<b>311</b>
 <b>Index. . . . .</b>		<b>359</b>
 <b>Revision History . . . . .</b>		<b>367</b>

## ***About this Manual:***

This manual describes the E5CN/AN/EN-HT Digital Controllers and includes the sections described below.

Please read this manual carefully and be sure you understand the information provided before attempting to set up or operate an E5CN/AN/EN-HT Digital Controller.

### **• Overview**

**Section 1** introduces the features, components, and main specifications of the E5CN/AN/EN-HT Digital Controllers.

### **• Setup**

**Section 2** describes the work required to prepare the E5CN/AN/EN-HT Digital Controllers for operation, including installation and wiring.

### **• Basic Operations**

**Section 3** describes the basic operation of the E5CN/AN/EN-HT Digital Controllers, including key operations to set parameters and descriptions of display elements based on specific control examples.

**Section 5** describes the individual parameters used to set up, control, and monitor operation.

### **• Operations for Applications**

**Sections 4 and 5** describes the operating methods required to get the most out of the E5CN-HT, E5AN-HT, or E5EN-HT, such as functions related to program operation.

### **• User Calibration**

**Section 6** describes how the user can calibrate the E5CN/AN/EN-HT Digital Controllers.

### **• Appendix**

The **Appendix** provides information for easy reference, including lists of parameters and settings.

 **WARNING** Failure to read and understand the information provided in this manual may result in personal injury or death, damage to the product, or product failure. Please read each section in its entirety and be sure you understand the information provided in the section and related sections before attempting any of the procedures or operations given.



# SECTION 1

## Introduction

This section introduces the features, components, and main specifications of the E5CN-H, E5AN-H, and E5EN-H Digital Controllers.

- 1-1 Names of Parts ..... 2
  - 1-1-1 Front Panel ..... 2
  - 1-1-2 Explanation of Indicators ..... 3
  - 1-1-3 Using the Keys ..... 5
- 1-2 I/O Configuration and Main Functions ..... 6
  - 1-2-1 I/O Configuration ..... 6
  - 1-2-2 Main Functions ..... 9
- 1-3 Setting Level Configuration and Key Operations ..... 12
  - 1-3-1 Selecting Parameters ..... 15
  - 1-3-2 Saving Settings ..... 15
- 1-4 Communications Function ..... 15
- 1-5 Insulation Block Diagrams ..... 17

# 1-1 Names of Parts

## 1-1-1 Front Panel

### E5CN-HT

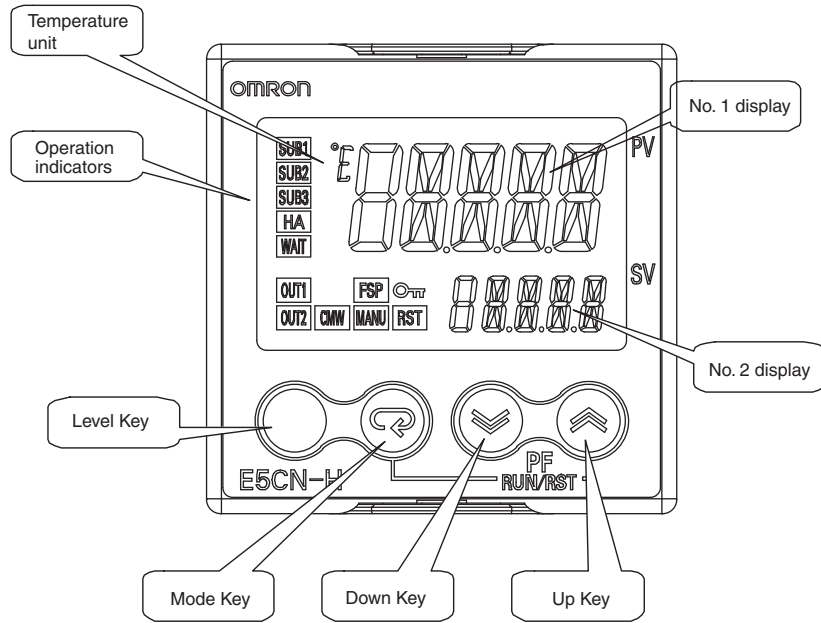

### E5AN-HT

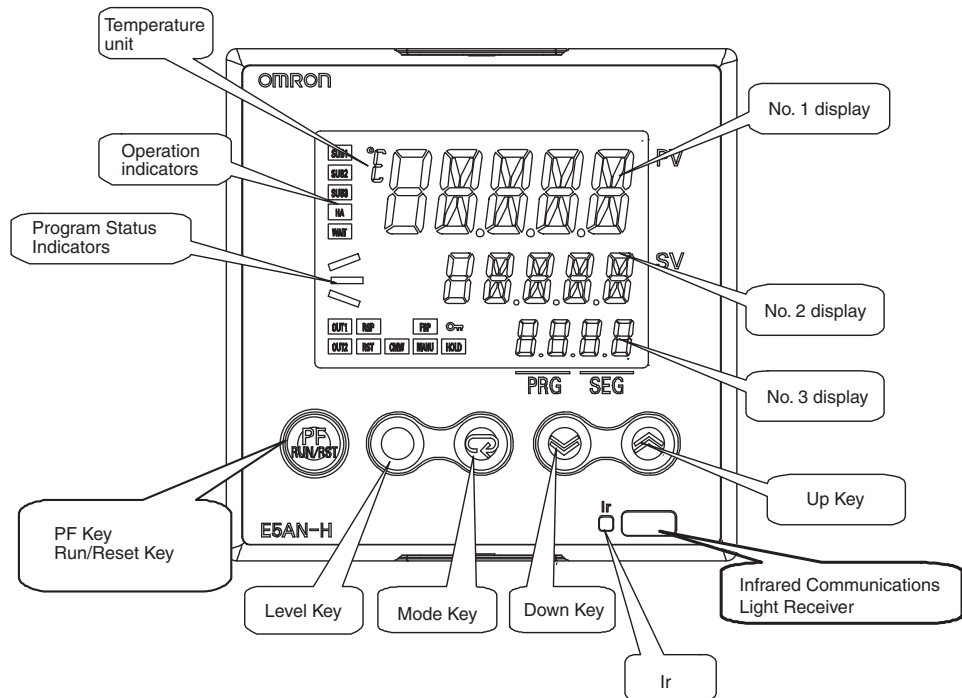



E5EN-HT

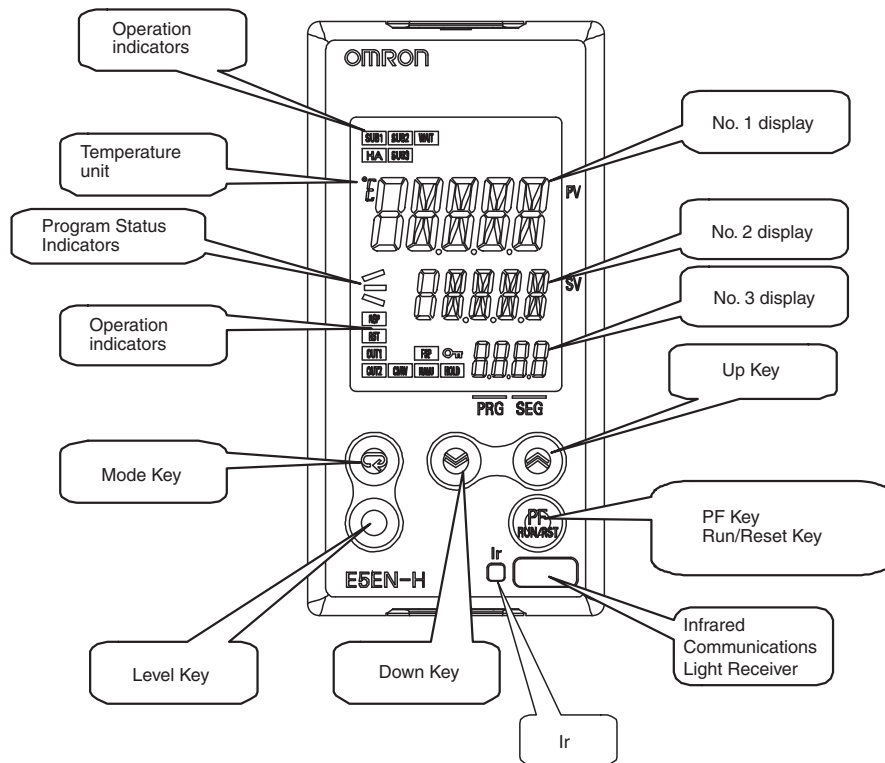



### 1-1-2 Explanation of Indicators

- No. 1 Display** Displays the process value or parameter name.  
Lights for approximately one second during startup.
- No. 2 Display** Displays the set point, parameter operation read value, or the variable input value.  
Lights for approximately one second during startup.  
The SP display will flash during auto-tuning.
- No. 3 Display (E5AN/EN-HT Only)** Displays the program number and segment number, etc.  
Lights for approximately one second during startup.

#### Operation Indicators

- 1,2,3...**
1. SUB1 (Sub 1)  
Lit while the function set for the Auxiliary Output 1 Assignment parameter is ON.  
SUB2 (Sub 2)  
Lit while the function set for the Auxiliary Output 2 Assignment parameter is ON.  
SUB3 (Sub 3)  
Lit while the function set for the Auxiliary Output 3 Assignment parameter is ON.
  2. HA (Heater Burnout, Heater Short Alarm, Heater Overcurrent Detection Output Display)  
Lights when a heater burnout, heater short alarm, or heater overcurrent occurs.

3. **OUT1 (Control Output 1)**  
Lit while the control output function assigned to control output 1 is ON.  
For a linear output, however, OFF only for a 0% output.  
With position-proportional models, OUT1 is lit while the "open" output is ON.  
**OUT2 (Control Output 2)**  
Lit while the control output function assigned to control output 2 is ON.  
For a linear output, however, OFF only for a 0% output.  
With position-proportional models, OUT2 is lit while the "close" output is ON.
4. **RST**  
Lit while the program is being reset  
The RST indicator lights when an event or key operation changes the run/reset status to reset during control operation.
5. **CMW (Communications Writing)**  
Lit while communications writing is enabled and is not lit when it is disabled.
6. **MANU (Manual Mode)**  
Lit while the auto/manual mode is set to manual mode.
7. ** (Key)**  
Lit while settings change protect is ON (i.e., when the  and  Keys are disabled by protected status.)
8. **RSP**  
Lit while the SP Mode parameter is set to Remote SP Mode. (This indicator is provided only on the E5AN-HT and E5EN-HT.)
9. **FSP**  
Lit while the SP Mode parameter is set to Fixed SP Mode.
10. **HOLD**  
Lit while the program is being held. (This indicator is provided only on the E5AN-HT and E5EN-HT.)
11. **WAIT**  
Lit while the program is in wait status.

**Temperature Unit**

The temperature unit is displayed when parameters are set to display a temperature. The display is determined by the currently set value of the Temperature Unit parameter.  $^{\circ}C$  indicates  $^{\circ}C$  and  $^{\circ}F$  indicates  $^{\circ}F$ .

**Program Status Indicators**

The program status indicators show the direction of change of the present SP in the present segment. The indicators light as follows: Rising segment: top indicator, constant-temperature segment: middle indicator, and falling segment: bottom indicator. These indicators will turn OFF if any of the following conditions are met.

- Reset status, standby status, not in Program SP Mode (i.e., in Remote or Fixed SP Mode), or operation completed status.

**Ir**

Indicates whether infrared communications is enabled. Lights when communications is enabled. Not lit when infrared communications is disabled.

- Infrared Communications Light Receiver  
Used when infrared cable is used.

### 1-1-3 Using the Keys

#### PF (Function or Run/Reset) Key (E5AN-HT and E5EN-HT Only)

This section describes the basic functions of the front panel keys.

This is a programmable function key. When it is pressed for at least 1 second, the function set in the PF Setting parameter will operate.

Example for When the PF Setting Parameter Is Set to R-R (Default: R-R):

With this setting, the PF Key operates as a Reverse Run/reset Key to switch between run status and reset status.

The status changes from reset to run status when the key is pressed for at least one second and changes from run to reset status when the key is pressed for at least two seconds.

#### Key

Press this key to move between setting levels. The level is selected in the following order: operation level, program setting level, adjustment level, PID setting level, and then operation level. From initial setting level you can go to and from communications setting level.

#### Key

Press this key to change parameters within a setting level.

The parameters can be reversed by holding down the key (moving one per second in reverse order).

#### Key

Each press of this key increments the value displayed on the No. 2 display or advances the setting. Holding the key down speeds up the incrementation.

#### Key



Each press of this key decrements values displayed on the No. 2 display or reverses the setting. Holding the key down speeds up the incrementation.

#### + Keys



Press these keys to change to the protect level. For details on operations involving holding these keys down simultaneously, refer to *1-3 Setting Level Configuration and Key Operations*. For details on the protect level, refer to *SECTION 5 Parameters*.

#### + Keys

#### + Keys

To restrict set value changes (in order to prevent accidental or incorrect operations), these key operations require simultaneously pressing the  key along with  or  key. This applies only to the parameter for the password to move to protect level. (Refer to page 182.)

#### + Keys (E5CN-HT Only)

The function that is set for the PF Setting parameter will operate when the Mode Key and Up Key are pressed at the same time for at least one second. They perform the same function as the PF Key. If you are using the E5CN-HT, use the + Keys whenever the manual says to use the PF Key.

## 1-2 I/O Configuration and Main Functions

### 1-2-1 I/O Configuration

E5CN-HT

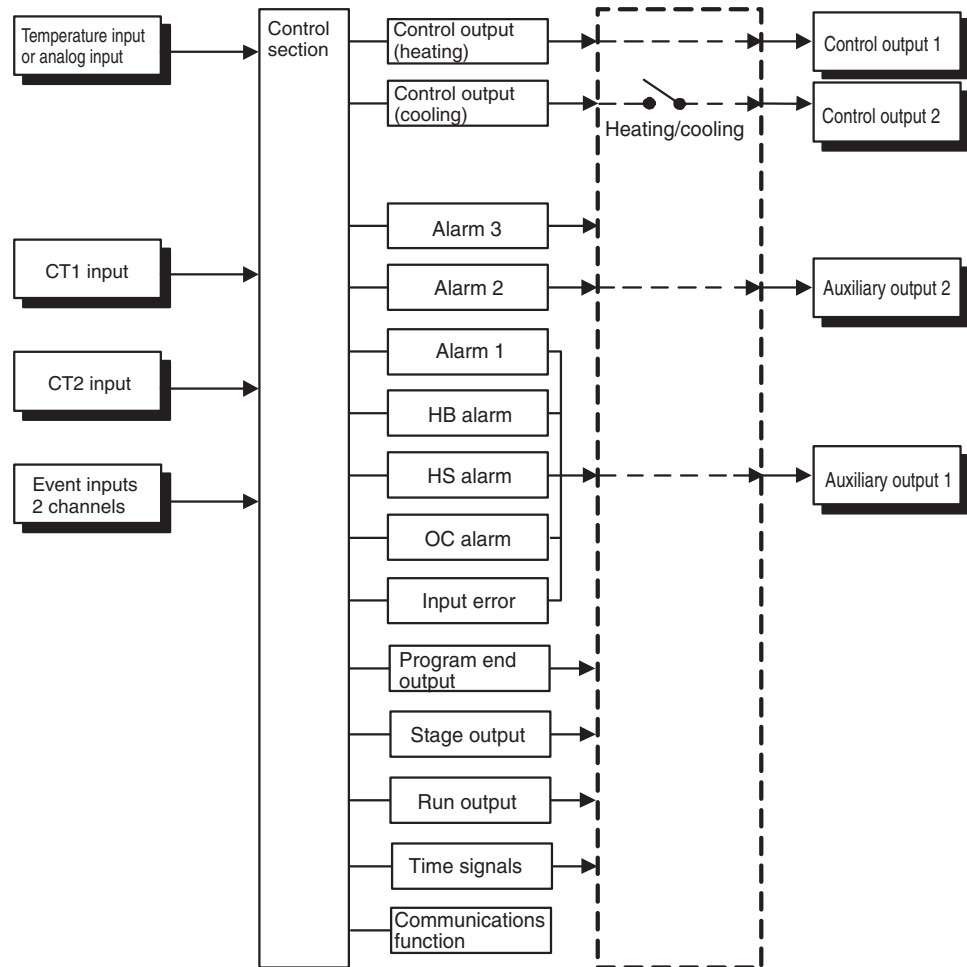

**Note** Functions can be assigned individually for each output by changing the set values for the Control Output 1 Assignment, the Control Output 2 Assignment, the Auxiliary Output 1 Assignment, and the Auxiliary Output 2 Assignment parameters in the advanced function setting level.

**Model Number Structure****Model Number Legends****Controllers**

**E5CN-□□□□M□-500**  
 1 2 3 4 5 6

- 1. Type**  
 H: Advanced  
 T: Programmable type
- 2. Control Output 1**  
 R: Relay output  
 Q: Voltage output  
 (for driving SSR)  
 C: Current output  
 V: Linear voltage output
- 3. Auxiliary Outputs**  
 2: Two outputs
- 4. Option 1**  
 M: Option Unit can be mounted.
- 5. Power Supply Voltage**  
 Blank: 100 to 240 VAC  
 D: 24 VAC/VDC
- 6. Terminal Cover**  
 -500: With terminal cover

**Option Units**

**E53-□□□□**  
 1 2 3 4

- 1. Applicable Controller**  
 CN: E5CN-HT, E5CN-H or E5CN
- 2. Function 1**  
 Blank: None  
 Q: Control output 2 (voltage output for driving SSR)  
 P: Power supply for sensor  
 C: Current output
- 3. Function 2**  
 Blank: None  
 H: Heater burnout/Heater short/  
 Heater overcurrent detection (CT1)  
 HH: Heater burnout/Heater short/  
 Heater overcurrent detection (CT2)  
 B: Two event inputs  
 03: RS-485 communications  
 H03: Heater burnout/Heater short/  
 Heater overcurrent detection (CT1)  
 + RS-485 communications  
 HB: Heater burnout/Heater short/  
 Heater overcurrent detection (CT1)  
 + Two event inputs  
 HH03: Heater burnout/Heater short/  
 Heater overcurrent detection (CT2)  
 + RS-485 communications  
 H01: Heater burnout/Heater short/  
 Heater overcurrent detection (CT1)/  
 RS-232C communications  
 F: Transfer output  
 BF: Two event inputs/Transfer output
- 4. Version**  
 N2: Available only to models released  
 after January 2008

E5AN/EN-HT

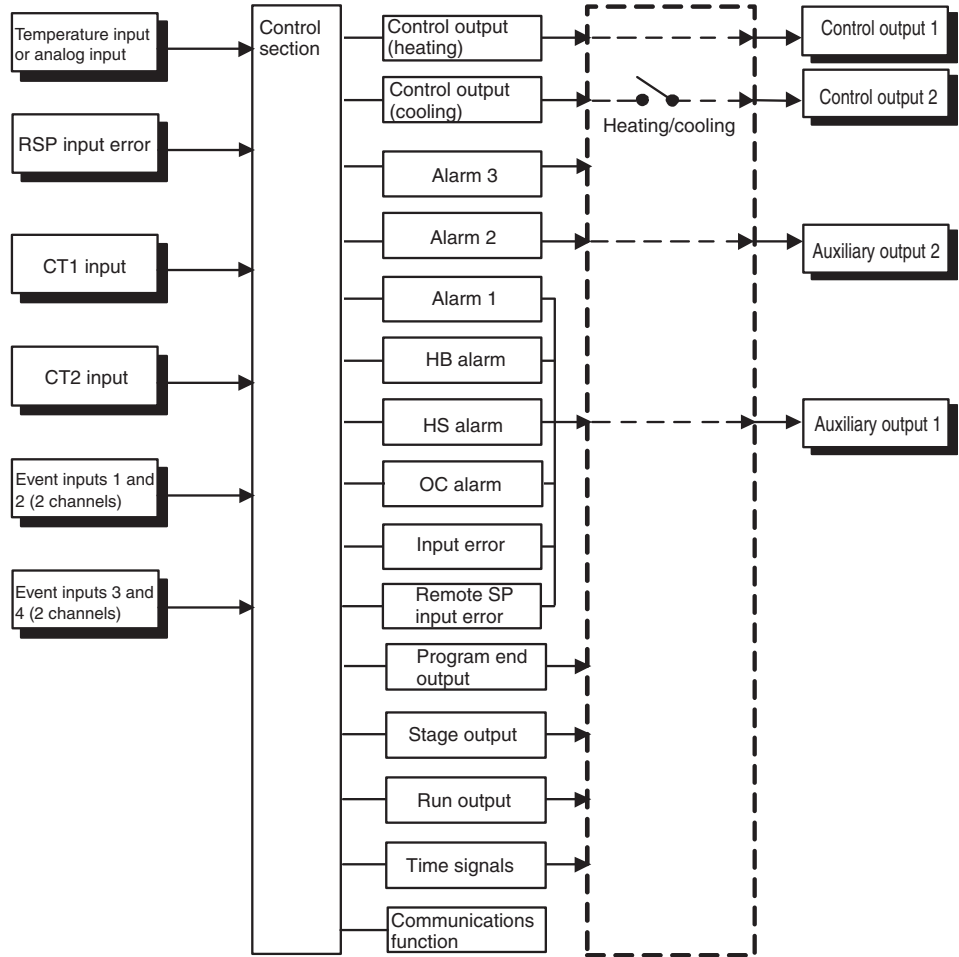

**Note** Functions can be assigned individually to each output by changing the set values for the Control Output 1 Assignment, Control Output 2 Assignment, Auxiliary Output 1 Assignment, Auxiliary Output 2 Assignment, and Auxiliary Output 3 Assignment parameters in the advanced function setting level.

## Model Number Structure

### Model Number Legends

#### Controllers

**E5AN/E5EN-**□□□□□□□□**M**□**-500**  
 1 2 3 4 5 6 7 8 9 10

- 1. Type**  
 H: Advanced  
 T: Programmable type
- 2. Control Mode**  
 Blank: Standard or heating/cooling control  
 P: Position-proportional control
- 3. Control Output 1**  
 A: Control Output Unit  
 R: Relay output
- 4. Control Output 2**  
 A: Control Output Unit  
 R: Relay output
- 5. Auxiliary Outputs**  
 2: Two outputs  
 3: Three outputs
- 6. Option 1**  
 Blank: None  
 H: Heater burnout/Heater short/  
 Heater overcurrent detection (CT1)  
 HH: Heater burnout/Heater short/  
 Heater overcurrent detection (CT2)
- 7. Option 2**  
 B: Two event inputs  
 BF: Event input + Transfer output
- 8. Option 3**  
 M: Option Unit can be mounted.
- 9. Power Supply Voltage**  
 Blank: 100 to 240 VAC  
 D: 24 VAC/VDC
- 10. Terminal Cover**  
 -500: With Terminal Cover

#### Option Units

**E53-**□  
 1

- 1. Function**  
 EN01: RS-232C  
 communications  
 EN02: RS-422  
 communications  
 EN03: RS-485  
 communications  
 AKB: Event input

#### Output Units

**E53-**□□  
 1 2

- 1. Control Output**  
 R: Relay output  
 Q: Voltage output  
 (for driving SSR)  
 Q3: Voltage output  
 (for driving SSR) +  
 24 VDC (NPN)  
 Q4: Voltage output  
 (for driving SSR) +  
 24 VDC (PNP)  
 C3: Current output +  
 4 to 20 mA DC  
 C3D: Current output +  
 0 to 20 mA DC  
 V34: Linear voltage output +  
 0 to 10 VDC  
 V35: Linear voltage output +  
 0 to 5 VDC
- 2. Version**  
 Blank: Available for  
 E5AN-HT/E5EN-HT  
 and E5AK/E5EK.  
 N: Available only for  
 E5AN-HT/E5EN-HT.

## 1-2-2 Main Functions

This section introduces the main E5□N-HT functions. For details on particular functions and how to use them, refer to *SECTION 3 Basic Operation* and following sections.

### Input Sensor Types

- The following input sensors can be connected.:  
 Thermocouple: K, J, T, E, L, U, N, R, S, B, W, PLII  
 Platinum resistance thermometer: Pt100, JPt100  
 Current input: 4 to 20 mA DC, 0 to 20 mA DC  
 Voltage input: 1 to 5 VDC, 0 to 5 V DC, 0 to 10 V DC

**Control Outputs**

- A control output can be a relay output, voltage output (for driving SSR), linear voltage output, or current output, depending on the model.
- With the E5CN-HT□2□□, auxiliary output 2 is used as control output (cooling) when heating/cooling control is selected. (It is also possible to allocate a different output.) Therefore, use auxiliary output 1 if an auxiliary output is required while using heating/cooling control.

**Alarms**

- Set the alarm type and alarm value or the alarm value upper and lower limits.
- If necessary, a more comprehensive alarm function can be achieved by setting a standby sequence, alarm hysteresis, auxiliary output close in alarm/open in alarm, alarm latch, alarm ON delay, and alarm OFF delay.
- If the Input Error Output parameter is set to ON, the output assigned to alarm 1 function will turn ON when an input error occurs.
- If the Remote SP Input Error Output parameter is set to ON, the output assigned to the alarm 1 function will turn ON when a remote SP input error occurs. The remote SP function is supported only by the E5AN-HT and E5EN-HT.

**Control Adjustment**

- Auto-tuning can be executed to easily set the optimum PID constants.

**Event Inputs**

- With the E5□N-HT□□□B, the following functions can be executed using event inputs. Any of the following can be specified: switching programs, run/reset, reset, run, switching automatic/manual operation, hold/clear hold, hold, advance, Program SP Mode/Remote SP Mode (E5AN-HT or E5EN-HT only), Remote SP Mode/Fixed SP Mode (E5AN-HT or E5EN-HT only), Program SP Mode/Fixed SP Mode, wait enable/disable, invert direct/reverse operation, 100% AT execute/cancel, 40% AT execution/cancel, setting change enable/disable, communications writing enable/disable, and alarm latch cancel.

**Heater Burnout, HS Alarm, and Heater Overcurrent**

- With the E53-CN□H□N2 or E53-CN□HH□N2 for the E5CN-H, or the E5AN/EN-HT□□H□-500 or E5AN/EN-HT□□HH□-500, the heater burnout detection function, HS alarm function, and heater overcurrent detection function can be used.

**Communications Functions**

- Communications functions utilizing CompoWay/F (See note 1.) or Modbus (See note 2.) can be used.

**RS-485 Interface**

Use the E53-CN□03N2 for the E5CN-H, or the E53-EN03 for the E5AN/EN-H.

**RS-232C Interface**

Use the E53-CN□01N2 for the E5CN-HT, or the E53-EN01 for the E5AN/EN-HT.

**RS-422 Interface (See note 3.)**

Use the E53-EN02 for the E5AN/EN-HT.

**Note**

- (1) CompoWay/F is an integrated general-purpose serial communications protocol developed by OMRON. It uses commands compliant with the well-established FINS, together with a consistent frame format on OMRON Programmable Controllers to facilitate communications between personal computers and components.
- (2) Modbus is a communications control method conforming to the RTU Mode of Modbus Protocol. Modbus is a registered trademark of Schneider Electric.
- (3) The E5CN-HT does not support the RS-422 interface.



<b>Transfer Output</b>	A 4 to 20-mA transfer output can be used with the E53-CN□FN2 for the E5CN-H, or the E5AN/EN-HT□□F-500.
<b>Remote SP Inputs</b>	Remote SP inputs can be used with the E5AN-HT and E5EN-HT.
<b>Infrared Communications</b>	When Support Software, such as CX-Thermo version 4.30 or later (EST2-2C-MV4 or later), is used, the personal computer can be connected to the Digital Controller using infrared communications.

### 1-3 Setting Level Configuration and Key Operations

Parameters are divided into groups, each called a level. Each of the set values (setting items) in these levels is called a parameter. The parameters on the E5CN/AN/EN-HT are divided into the following 9 levels.



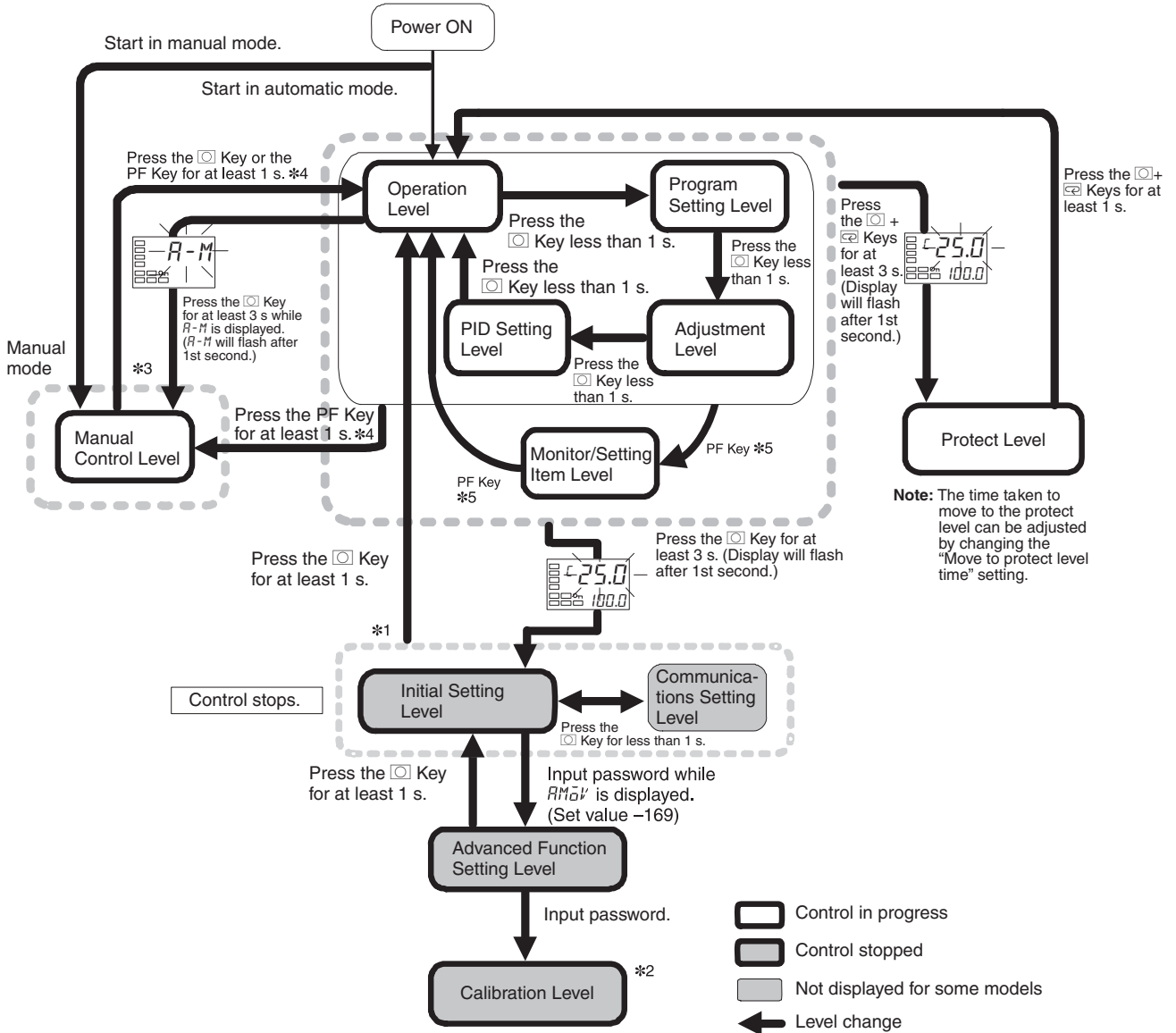

When the power is turned ON, all of the display lights for approximately one second.





Level	Control in progress	Control stopped
Protect level	Can be set.	---
Operation level	Can be set.	---
Program Setting Level	Can be set.	---
Adjustment level	Can be set.	---
PID setting level	Can be set.	---
Manual control level	Can be set.	---
Monitor/setting item level	Can be set.	---
Initial setting level	---	Can be set.
Advanced function setting level	---	Can be set.

Level	Control in progress	Control stopped
Calibration level	---	Can be set.
Communications setting level	---	Can be set.

Of these levels, the initial setting level, communications setting level, advanced function setting level, and calibration level can be used only when control is stopped. Control outputs are stopped when any of these four levels is selected.

- Note**
- (1) You can return to the operation level by executing a software reset.
  - (2) You cannot move to other levels by operating the keys on the front panel from the calibration level. You must turn OFF the power supply.
  - (3) From the manual control level, key operations can be used to move to the operation level only.
  - (4) When the PF Setting parameter is set to A-M. For the E5CN-HT, press the + Keys at the same time to implement the PF Key.
  - (5) When the PF Setting parameter is set to PFDP. For the E5CN-HT, press the + Keys at the same time to implement the PF Key.

#### Protect Level

- To switch to the protect level, simultaneously hold down the  and  Keys for at least 3 seconds from the operation level, the program setting level, adjustment level, or PID setting level. (See note.) This level is for preventing unwanted or accidental modification of parameters. Protected levels will not be displayed, and so the parameters in that level cannot be modified.

**Note** The key pressing time can be changed in Move to Protect Level parameter (advanced function setting level).

#### Operation Level

- The operation level is displayed when the power is turned ON. You can move to the protect level, initial setting level, or program setting level from this level.
- Operation level should be used during normal operation. The PV, MV, or other values can be monitored during operation. Hold and advance commands can also be used.

#### Program Setting Level









- To move to the program setting level, press the  Key once from the operation level for less than 1 s.
- In this level, the SPs, times, rates of rise, and other parameters are input for the programs. From the program setting level, you can move to the adjustment level, initial setting level, or protect level.

#### Adjustment Level

- To move to the adjustment level, press the  Key once from the program setting level for less than 1 s.
- This level is for entering set values and offset values for control. In addition to AT (auto-tuning), communications write enable/disable switching, hysteresis settings, SP settings, and input offset parameters, it includes HB alarm, HS alarm, OC alarm, and PID constants. From the adjustment level, you can move to the PID setting level, initial setting level, or protect level.

#### PID Setting Level

- To move to the PID setting level, press the  Key once from the adjustment level for less than 1 s.
- This level is used to input parameters such as the PID values for each PID set, MV upper and lower limits, and automatic selection range upper and lower limits. From the PID setting level, it is possible to move to the operation level, the initial setting level, or the protect level.





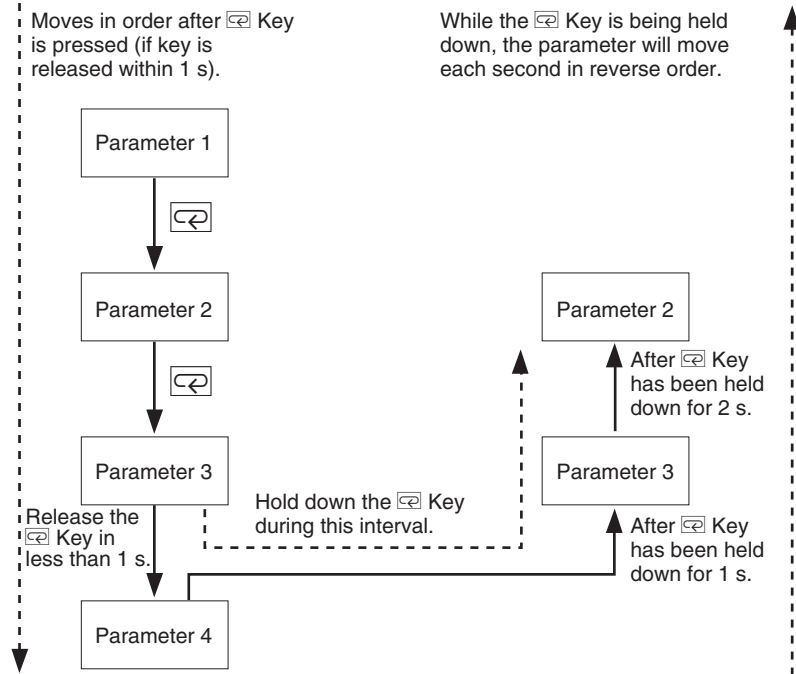

- Monitor/Setting Item Level**
- To switch to the monitor/setting item level, press the PF Key from the operation level, program setting level, adjustment level, or PID setting level. The contents set for monitor/setting items 1 to 5 can be displayed. You can move from the monitor/setting item level to the operation level or initial setting level. (E5AN/EN-H only.)
- Manual Control Level**
- When the  Key is pressed for at least 3 seconds from the operation level's auto/manual switching display, the manual control level will be displayed. (The MANU indicator will light.)
  - If the PF Setting parameter is set to A-M (auto/manual), the manual control level can be displayed by pressing the PF Key for more than one second from the operation level, adjustment level, program setting level, or PID setting level.
  - This is the level for changing the MV in manual mode.
  - To return to the operation level, press the  Key for at least one second. It is also possible to return to the operation level by pressing the PF Key for more than one second when the PF Setting is set to A-M.
- Initial Setting Level**
- To switch to the protect level, simultaneously hold down the  and  Keys for at least 3 seconds from the operation level, program setting level, adjustment level, or PID setting level. The PV display flashes after one second. This level is for specifying the input type and selecting the control method, control period, setting direct/reverse operation, setting the alarm types, etc. You can move to the advanced function setting level or communications setting level from this level. To return to the operation level, press the  Key for at least one second. To move to the communications setting level, press the  Key for less than one second.  
(When moving from the initial setting level to the operation level, all the indicators will light.)
- Note** Pressing the  Key for at least 3 seconds in the operation level's auto/manual switching display will move to the manual control level, and not the initial setting level.
- Advanced Function Setting Level**
- To move to the advanced function setting level, set the Initial Setting/Communications Protect parameter in the protect level to 0 (the default) and then, in the initial setting level, input the password (-169).
  - From the advanced function setting level, it is possible to move to the calibration level or to the initial setting level.
  - This level is for setting the automatic display return time and standby sequence, and it is the level for moving to the user calibration and other functions.
- Communications Setting Level**
- To move to the communications setting level from the initial setting level, press the  Key once (for less than 1 s). When using the communications function, set the communications conditions in this level. Communicating with a personal computer (host computer) allows set points to be read and written, and manipulated variables (MV) to be monitored.
- Calibration Level**
- To move to the calibration level, input the password (1201) from the advanced function setting level. The calibration level is for offsetting error in the input circuit.
  - You cannot move to other levels from the calibration level by operating the keys on the front panel. To cancel this level, turn the power OFF then back ON again.

### 1-3-1 Selecting Parameters

- Within each level, the parameter is changed in order (or in reverse order) each time the  Key is pressed. (In the calibration level, however, parameters cannot be changed in reverse order.) For details, refer to *SECTION 5 Parameters*.







### 1-3-2 Saving Settings

- If you press the  Key at the final parameter, the display returns to the top parameter for the current level.
- To change parameter settings, specify the setting using the  or  Key, and either leave the setting for at least two seconds or press the  Key. This saves the setting.
- When another level is selected after a setting has been changed, the contents of the parameter prior to the change is saved.
- When you turn the power OFF, you must first save the settings (by pressing the  Key). The settings are sometimes not changed by merely pressing the  or  Keys.

## 1-4 Communications Function

The E5CN-HT, E5AN-HT, and E5EN-HT Digital Controllers are provided with communications to enable parameters to be checked and set from a host computer. If communications is required, use a model that supports communications (E5□N-HT□□□03, E5□N-HT□□□01, or E5AN/EN-HT□□□02). For details on communications, refer to the *E5CN-HT/E5AN-HT/E5EN-HT Digital Controller Communications Manual Programmable Type* (Cat. No. H170). Use the following procedure to move to the communications setting level.

- 1,2,3...**
1. Press the  Key for at least three seconds to move from the operation level to the initial setting level.
  2. Press the  Key for less than one second to move from the initial setting level to the communications setting level.

3. Select the parameters as shown below by pressing the  Key.
4. Press the  or  Key to change the parameter setting.

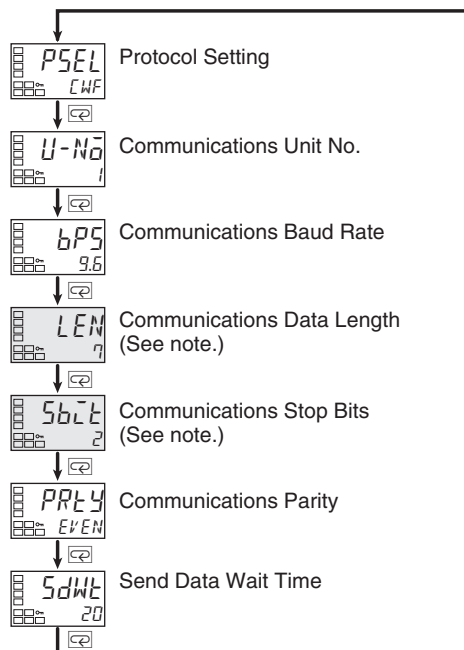

**Note** The Protocol Setting parameter is displayed only when CompoWay/F communications are being used.

**Setting Communications Data**

Match the communications specifications of the E5CN/AN/EN-HT and the host computer. If a 1:N connection is being used, ensure that the communications specifications for all devices in the system (except the communications Unit No.) are the same.

Parameter name	Symbol	Setting (monitor) value	Selection symbols	Default	Unit
Protocol Setting	PSEL	CompoWay/F, Modbus	CWF, Mod	CompoWay/F	None
Communications Unit No.	U-NO	0 to 99		1	None
Communications Baud Rate	bPS	1.2, 2.4, 4.8, 9.6, 19.2, 38.4, 57.6	1.2, 2.4, 4.8, 9.6, 19.2, 38.4, 57.6	9.6	kbps
Communications Data Length	LEN	7, 8		7	Bits
Communications Stop Bits	SbLT	1, 2		2	Bits
Communications Parity	PRTY	None, Even, Odd	NONE, EVEN, odd	Even	None
Send Data Wait Time	SdWE	0 to 99		20	ms

# 1-5 Insulation Block Diagrams

This section provides the insulation block diagrams for the E5CN-HT, E5AN-HT, and E5EN-HT.

## E5CN-HT

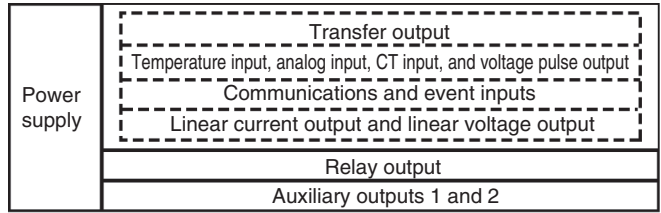

: reinforced insulation    
  : functional insulation

## E5AN/EN-HT

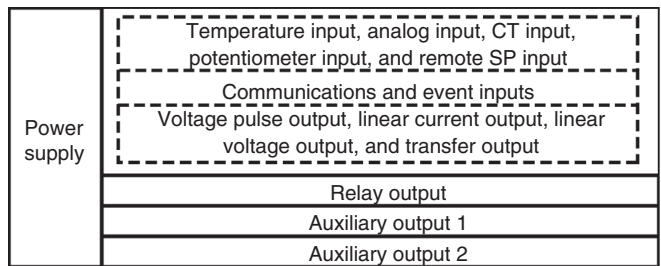

: reinforced insulation    
  : functional insulation





## SECTION 2 Preparations

This section describes the work required to prepare the E5CN-HT, E5AN-HT, and E5EN-HT Digital Controllers for operation, including installation and wiring.

2-1	Installation . . . . .	20
2-1-1	Dimensions . . . . .	20
2-1-2	Panel Cutout . . . . .	21
2-1-3	Mounting. . . . .	23
2-1-4	Removing the Digital Controller from the Case. . . . .	26
2-2	Wiring Terminals. . . . .	30
2-2-1	Terminal Arrangement . . . . .	30
2-2-2	Precautions when Wiring . . . . .	33
2-2-3	Wiring. . . . .	33
2-3	Using the Support Software Port. . . . .	42
2-4	Using Infrared Communications. . . . .	43

## 2-1 Installation

### 2-1-1 Dimensions

Unit: mm

#### E5CN-HT

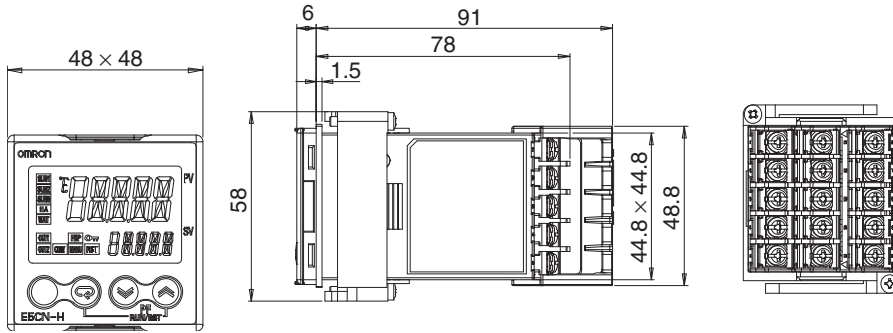

#### E5AN-HT

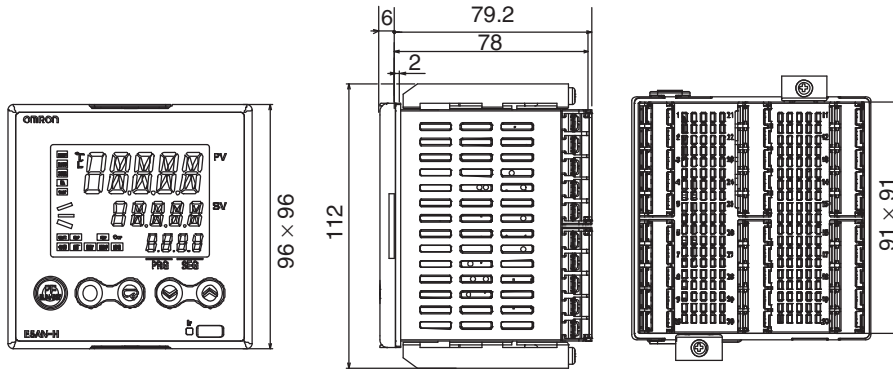

#### E5EN-HT

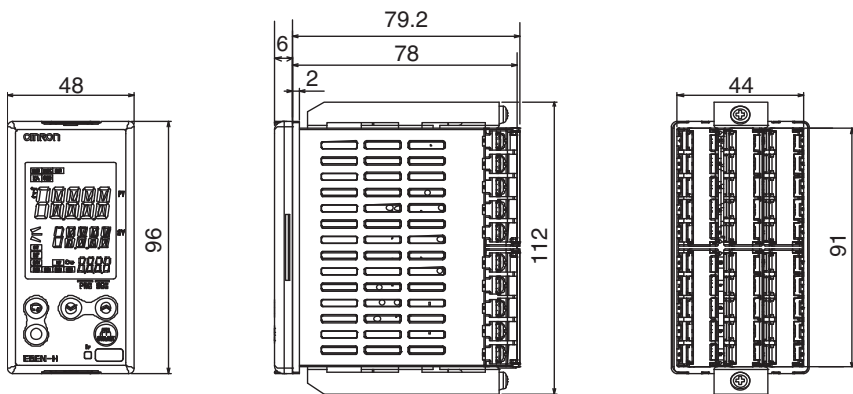

## 2-1-2 Panel Cutout

Unit: mm

### E5CN-HT

Individual Mounting

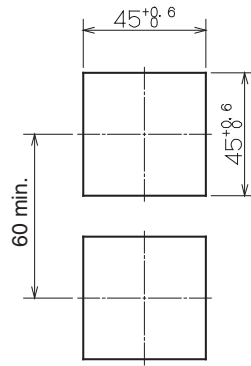

Group Mounting

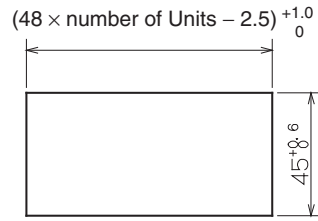

### E5AN-HT

Individual Mounting

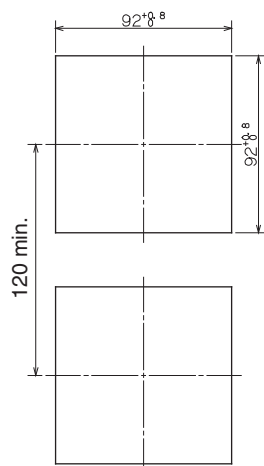

Group Mounting (See note.)

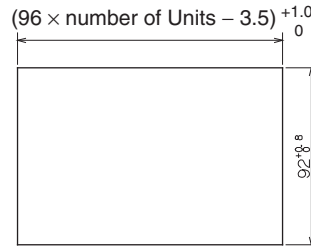

**Note** Group mounting is not possible if an E53-C3N or E53-C3DN Output Unit is used for control output 1 or 2. Mount at the intervals shown in the following diagram.

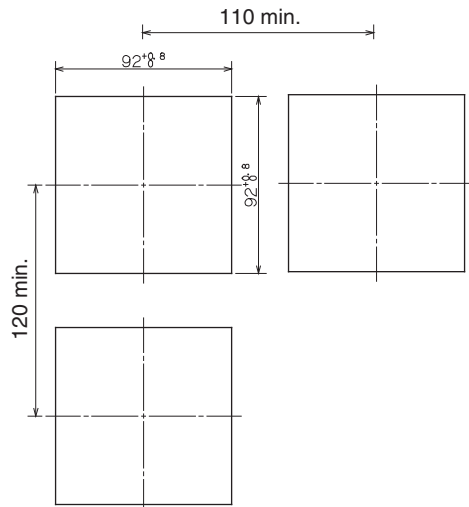

E5EN-HT

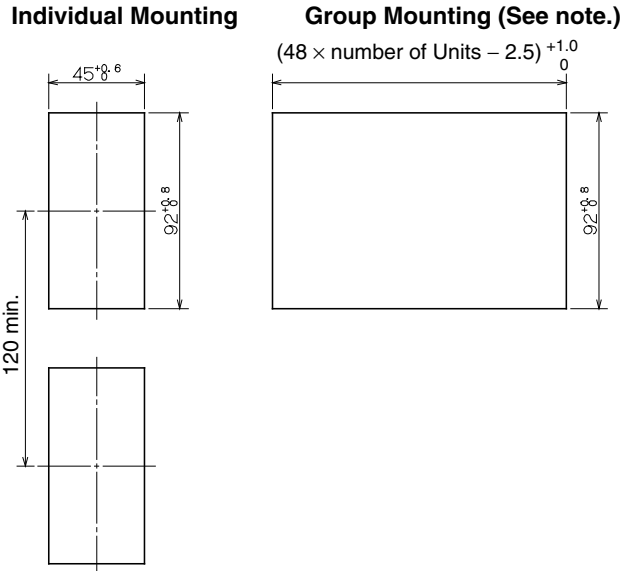

**Note** Group mounting is not possible if an E53-C3N or E53-C3DN Output Unit is used for control output 1 or 2. Mount at the intervals shown in the following diagram.

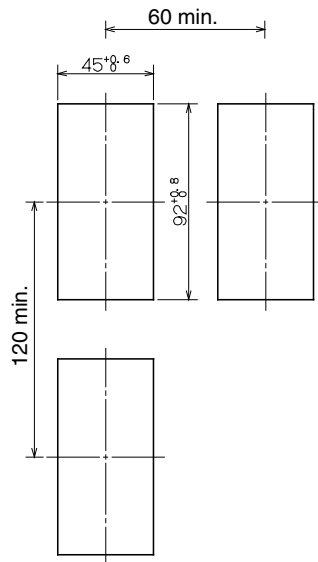

- Waterproofing is not possible when group mounting several Controllers.
- The recommended panel thickness is 1 to 5 mm for E5CN-HT, and 1 to 8 mm for E5AN/E5EN-HT.
- Units must not be group mounted vertically. Also, group mounting is not possible if an E53-C3N or E53-C3DN Output Unit is used for control output 1 or 2. (Observe the recommended mounting intervals.)
- When group mounting several Controllers, ensure that the surrounding temperature does not exceed the ambient operating temperature listed in the specifications.

## 2-1-3 Mounting

### E5CN-HT

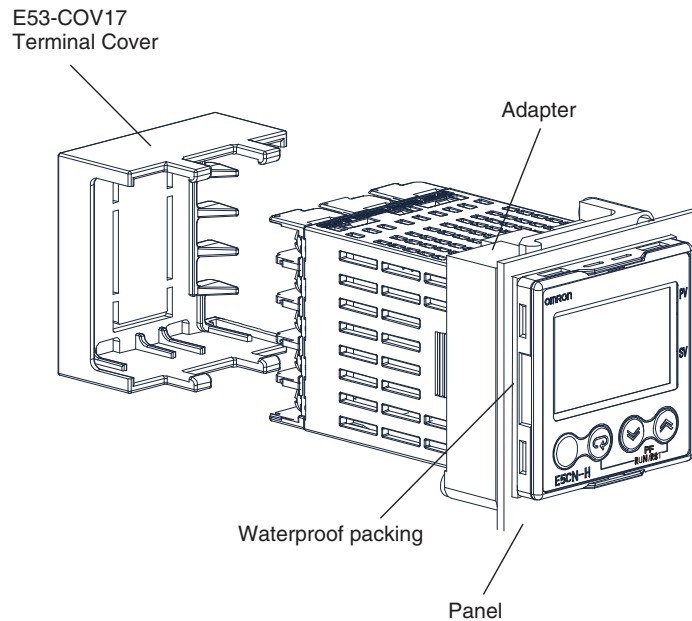

#### **Mounting to the Panel**

- 1,2,3...**
1. For waterproof mounting, waterproof packing must be installed on the Controller. Waterproofing is not possible when group mounting several Controllers. Waterproof packing is not necessary when there is no need for the waterproofing function.
  2. Insert the E5CN-HT into the mounting hole in the panel.
  3. Push the adapter from the terminals up to the panel, and temporarily fasten the E5CN-HT.
  4. Tighten the two fastening screws on the adapter. Alternately tighten the two screws little by little to maintain a balance. Tighten the screws to a torque of 0.29 to 0.39 N·m.

**Mounting the Terminal Cover**

Make sure that the "UP" mark is facing up, and then attach the E53-COV17 Terminal Cover to the holes on the top and bottom of the Digital Controller.

**E5AN/EN-HT**

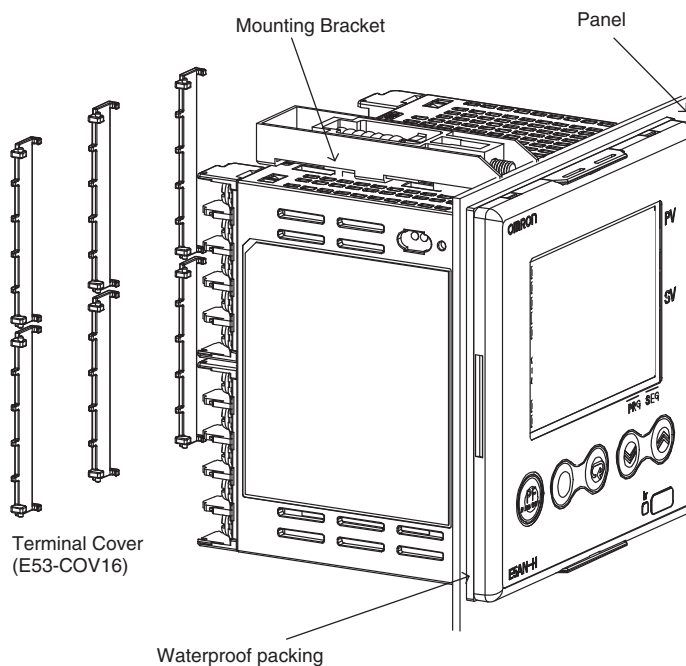

E5AN-HT

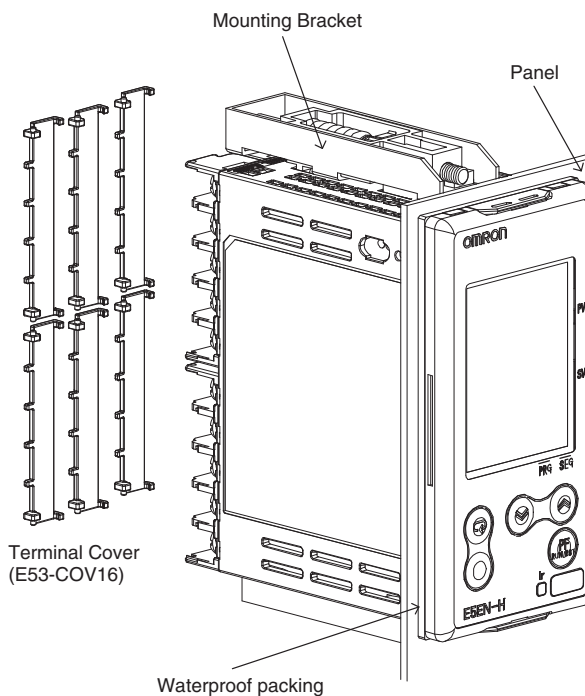

E5EN-HT

### **Mounting to the Panel**

- 1,2,3...
1. For waterproof mounting, waterproof packing must be installed on the Controller. Waterproofing is not possible when group mounting several Controllers. Waterproof packing is not necessary when there is no need for the waterproofing function.
  2. Insert the E5AN/E5EN-HT into the square mounting hole in the panel (thickness: 1 to 8 mm). Attach the Mounting Brackets provided with the product to the mounting grooves on the top and bottom surfaces of the rear case.
  3. Use a ratchet to alternately tighten the screws on the top and bottom Mounting Brackets little by little to maintain balance, until the ratchet turns freely.

### **Mounting the Terminal Cover**

Slightly bend the E53-COV16 Terminal Cover to attach it to the terminal block as shown in the following diagram. The Terminal Cover cannot be attached in the opposite direction.

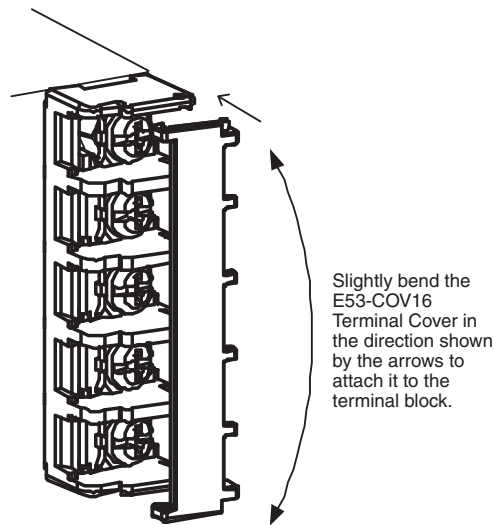

Enlarged Illustration of Terminal Section

### 2-1-4 Removing the Digital Controller from the Case

The body of the Digital Controller can be removed from the case to set Output Units or to perform maintenance. Check the specifications of the case and Digital Controller before removing the Digital Controller from the case.

**E5CN-HT**

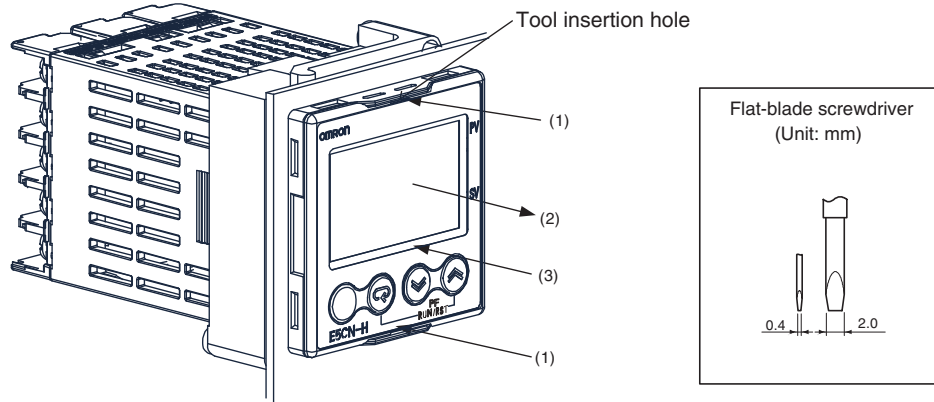

- 1,2,3...**
1. Insert a flat-blade screwdriver into the two tool insertion holes (one on the top and one on the bottom) to release the hooks.
  2. Insert the flat-blade screwdriver in the gap between the front panel and rear case, and pull out the front panel slightly. Hold the top and bottom of the front panel and carefully pull it out toward you, without applying unnecessary force.
  3. When inserting the body of the Digital Controller into the case, make sure the PCBs are parallel to each other, make sure that the sealing rubber is in place, and press the E5CN-HT all the way to the rear case. While pushing the E5CN-HT into place, push down on the hooks on the top and bottom surfaces of the rear case so that the hooks are securely locked in place. Be sure that electronic components do not come into contact with the case.

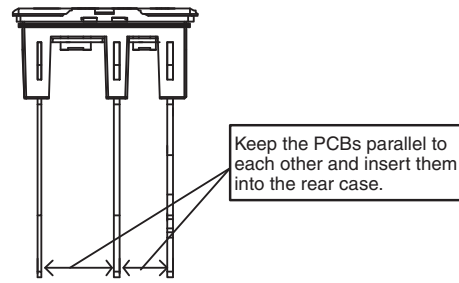

Bottom View of the E5CN-HT



E5AN/EN-HT

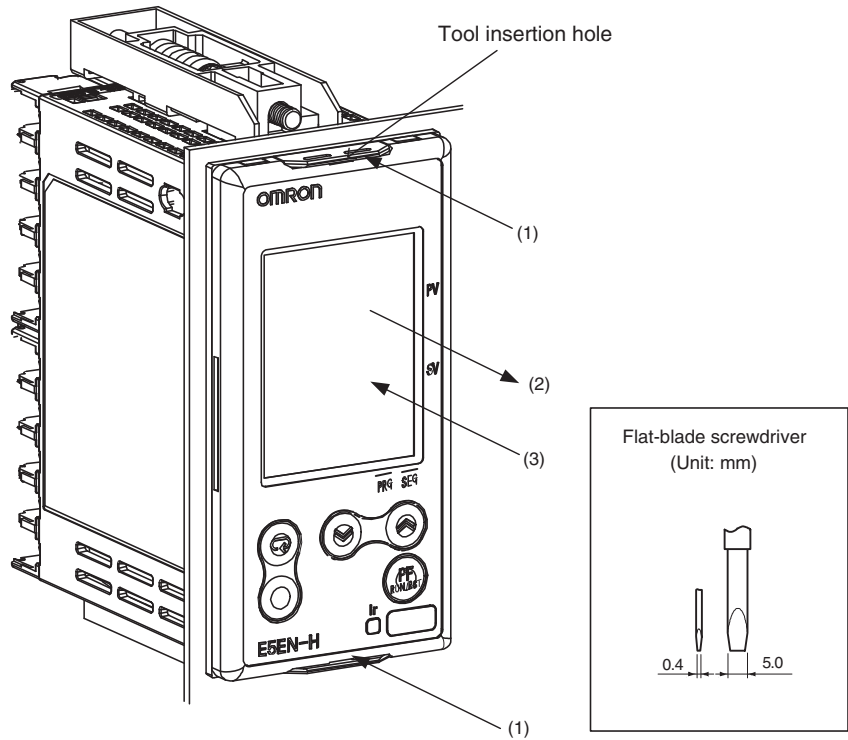
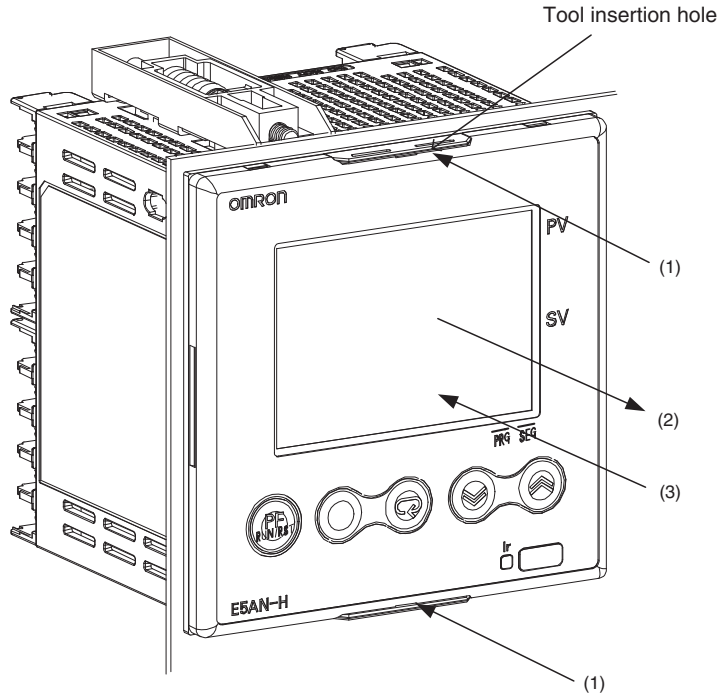

- 1,2,3...**
1. Insert a flat-blade screwdriver into the two tool insertion holes (one on the top and one on the bottom) to release the hooks.
  2. Insert a flat-blade screwdriver in the gap between the front panel and rear case (two on the top and two on the bottom), and use it to pry and pull out the front panel slightly. Then, pull out on the front panel gripping both sides. Be sure not to impose excessive force on the panel.

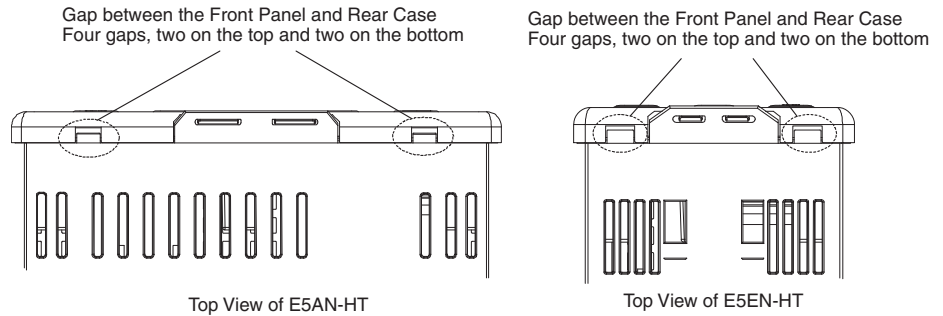

- When inserting the body of the Digital Controller into the case, make sure the PCBs are parallel to each other, make sure that the sealing rubber is in place, and press the E5AN/EN-HT toward the rear case until it snaps into position. While pressing the E5AN/EN-HT into place, press down on the hooks on the top and bottom surfaces of the rear case so that the hooks securely lock in place. Make sure that electronic components do not come into contact with the case.

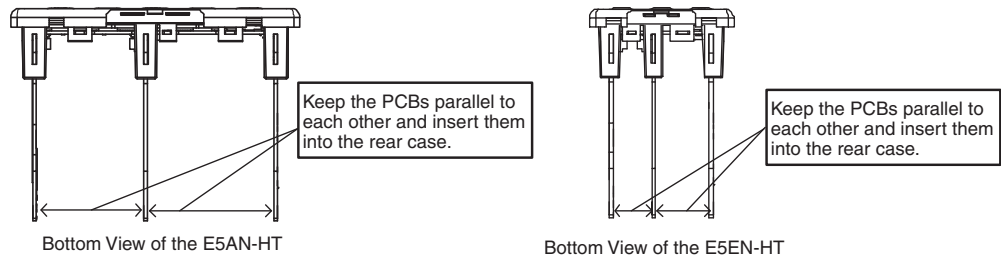

## Mounting Output Units

### Before Performing the Setup

- Confirm the type of Output Units that are to be set.
- For details on types of Output Units and the main specifications, refer to *Output Units* on page 35.
- For position-proportional models, the Output Units are already set. This setting operation is not required.
- When setting the Output Units, draw out the body of the Controller from the case and insert the Output Units into the sockets for control output 1 and 2.

### Setting Procedure

- Check the socket positions to be set using the following diagram.

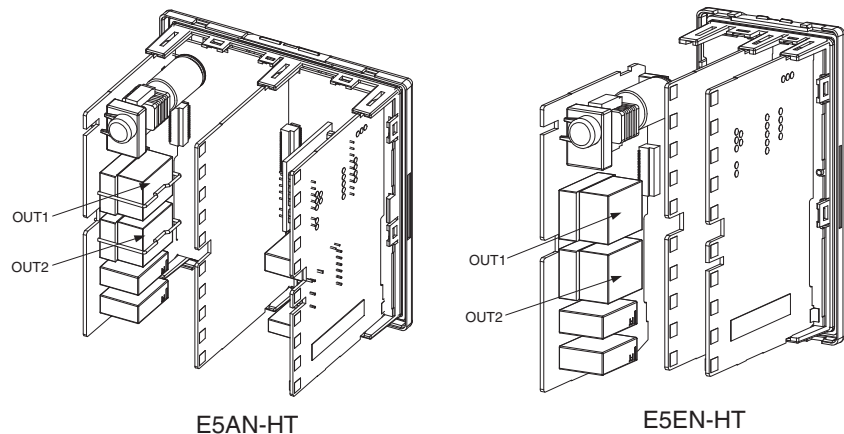

- 1,2,3... 1. While lifting the hooks securing the PCB on the front panel, remove the PCB to which the sockets are attached.

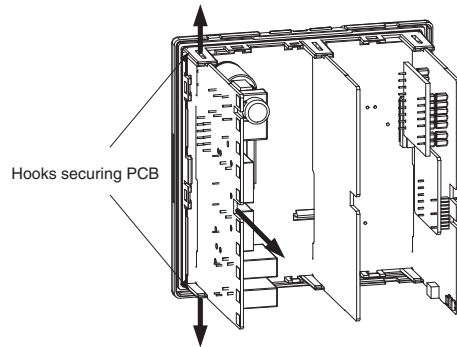

E5AN-HT

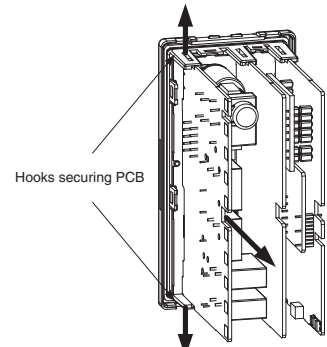

E5EN-HT

2. Set the Output Unit for control output 1 in the OUT1 socket. Set the Output Unit for control output 2 in the OUT2 socket.

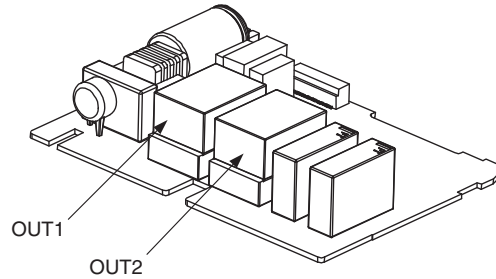

3. For the E5AN-HT, use the enclosed clamps to secure the Output Units. Do not use clamps for the E5EN-HT.

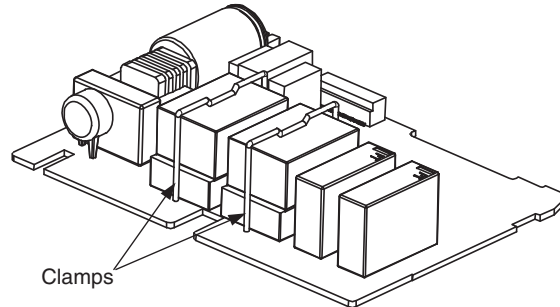

4. Set the PCB back in its original location, and make sure that the hooks securing the PCB are firmly in place.

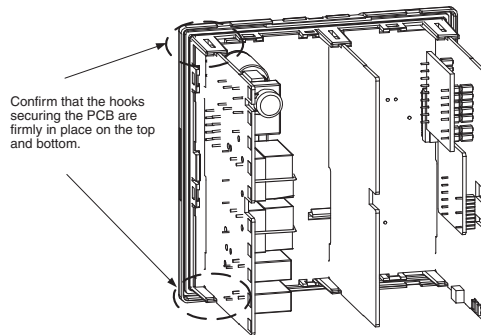

E5AN-HT

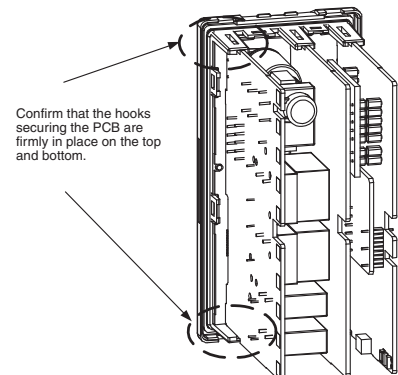

E5EN-HT

## 2-2 Wiring Terminals

Check the terminal arrangements for E5CN-HT terminals 1 to 15 and E5AN/EN-HT terminals 1 to 30 as marked on the product label and on the side of the case.

### 2-2-1 Terminal Arrangement

#### E5CN-HT

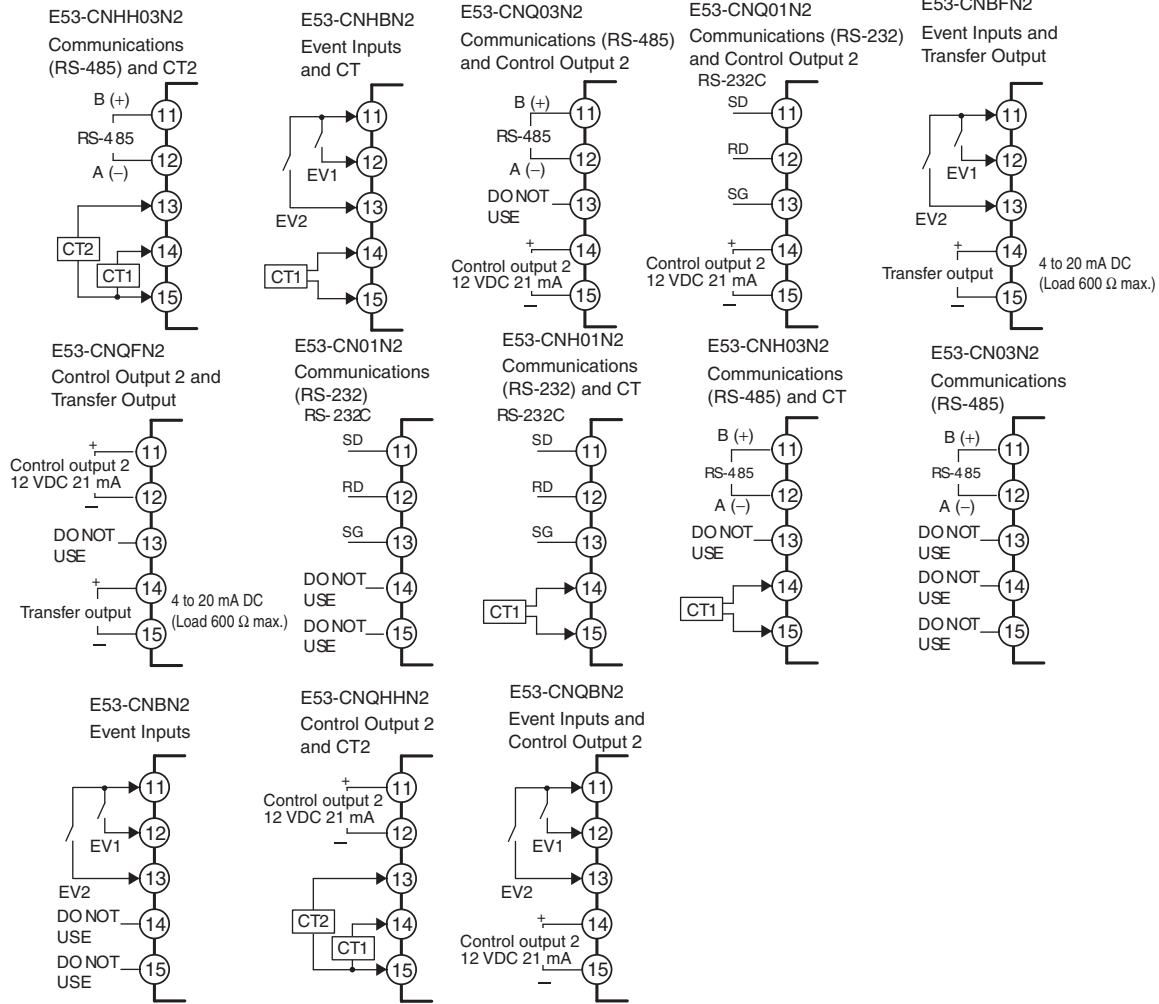
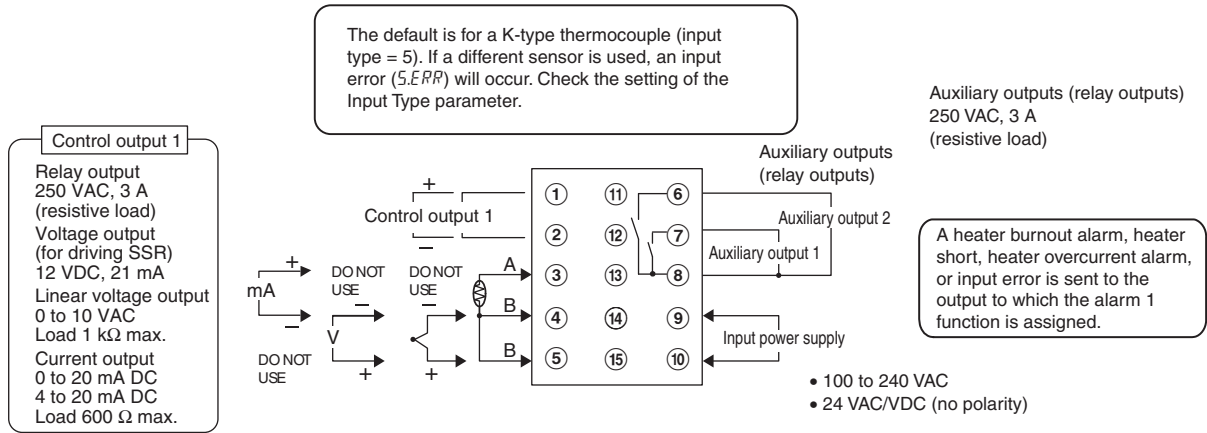

**Note** Wire all voltage input terminals correctly. The Digital Controller may fail if the voltage input terminals are wired incorrectly.

Control outputs that are voltage outputs are not isolated from the internal circuits. When using a grounded thermocouple, do not connect any of the control output terminals to ground. (If both are grounded, measurements will be unreliable due to sneak current.)

E5AN/EN-HT

100 to 240 VAC  
24 VAC/VDC (no polarity)

The default setting is for a K-type thermocouple (input type = 5). If a different sensor is used, an input error (5.ERR) will occur. Check the setting of the Input Type parameter.

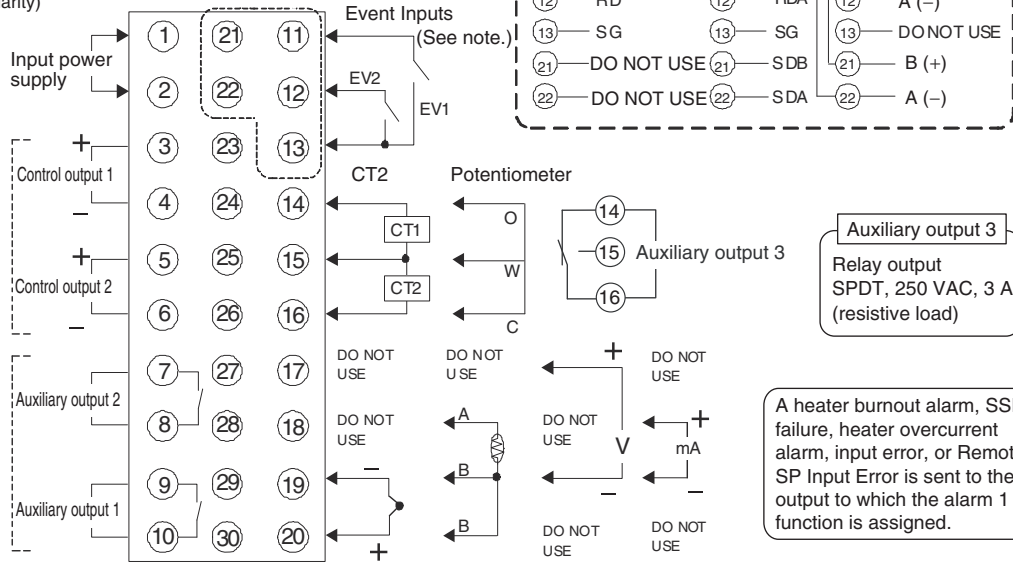

Auxiliary output 3  
Relay output  
SPDT, 250 VAC, 3 A  
(resistive load)

A heater burnout alarm, SSR failure, heater overcurrent alarm, input error, or Remote SP Input Error is sent to the output to which the alarm 1 function is assigned.

Note: When there are two event inputs, they use EV3 and EV4.

Control outputs 1, 2  
Control Output Unit  
Control outputs 1, 2  
Refer to page 32  
Models with Position-proportional Control  
Relay output  
250 VAC, 1 A  
(including inrush current)

Auxiliary outputs 1, 2, 3  
Relay output  
SPST-NO,  
250 VAC, 3 A  
(resistive load)

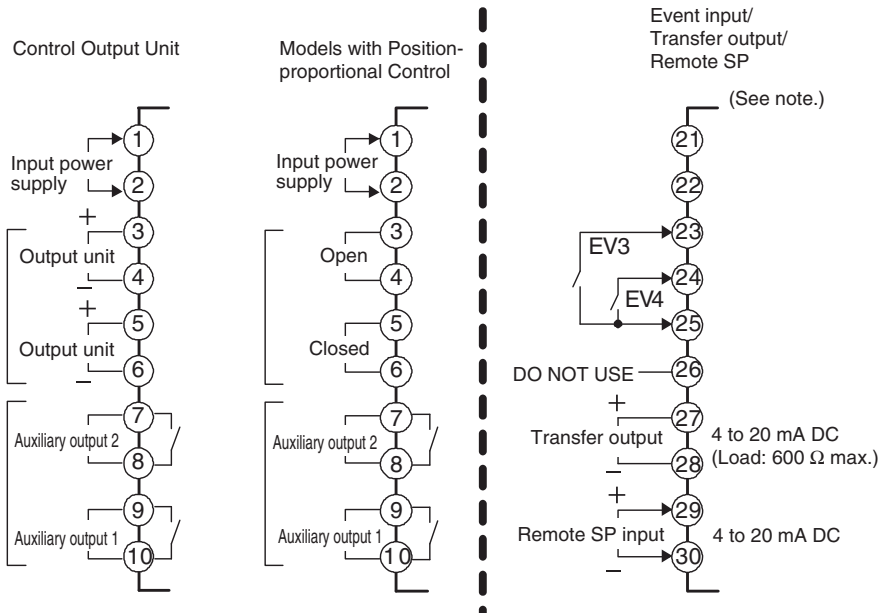

Note: On models that do not have the following functions, terminals 27 and 28 are blank terminals. Exercise caution when wiring.  
• Models with a transfer output (E5□N-□□□)

**Note** Wire all voltage input terminals correctly. The Digital Controller may fail if the voltage input terminals are wired incorrectly.

Control outputs that are voltage outputs are not isolated from the internal circuits. When using a grounded thermocouple, do not connect any of the control output terminals to ground. (If both are grounded, measurements will be unreliable due to sneak current.)

### 2-2-2 Precautions when Wiring

- Separate input leads and power lines in order to prevent external noise.
- Use AWG24 (cross-sectional area: 0.205 mm<sup>2</sup>) to AWG14 (cross-sectional area: 2.081 mm<sup>2</sup>) twisted-pair cable (stripping length: 5 to 6 mm).
- Use crimp terminals when wiring the terminals.
- Use the suitable wiring material and crimp tools for crimp terminals.
- Tighten the terminal screws to a torque of 0.74 to 0.90 N·m.
- Use the following types of crimp terminals for M3.5 screws.



**Note** Do not remove the terminal block. Doing so will result in malfunction or failure.

### 2-2-3 Wiring

In the connection diagrams, the left side of the terminal numbers represents the inside of the Controller and the right side represents the outside.

#### Power supply

- With the E5CN-HT, connect to terminals 9 and 10; with the E5AN-HT and E5EN-HT, connect pins 1 and 2. The following table shows the specifications.

Input power supply	E5CN-HT	E5AN/EN-HT
100 to 240 VAC, 50/60 Hz	8.5 VA	12 VA
24 VAC, 50/60 Hz	5.5 VA	8.5 VA
24 VDC (no polarity)	3.5 W	5.5 W

- These models have reinforced insulation between the input power supply, the relay outputs, and other terminals.

#### Input

- Make the connections as shown below, using terminals 3 to 5 for the E5CN-HT and pins 17 to 20 for the E5AN/EN-HT, and matching the input types.

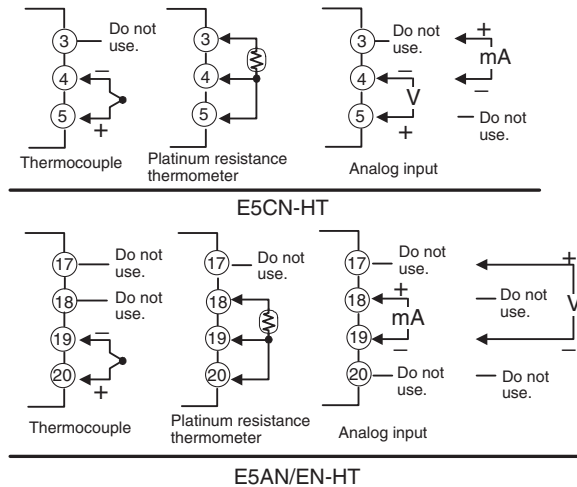

**Note** When wiring a voltage input, check the connected terminals carefully to make sure there are no mistakes. The Digital Controller may fail if the voltage input terminals are wired incorrectly.

**Control Output 1**

- Outputs are sent from terminals 1 and 2 with the E5CN-HT and from pins 3 and 4 with the E5AN/EN-HT. The following diagrams show the available outputs and their internal equalizing circuits.

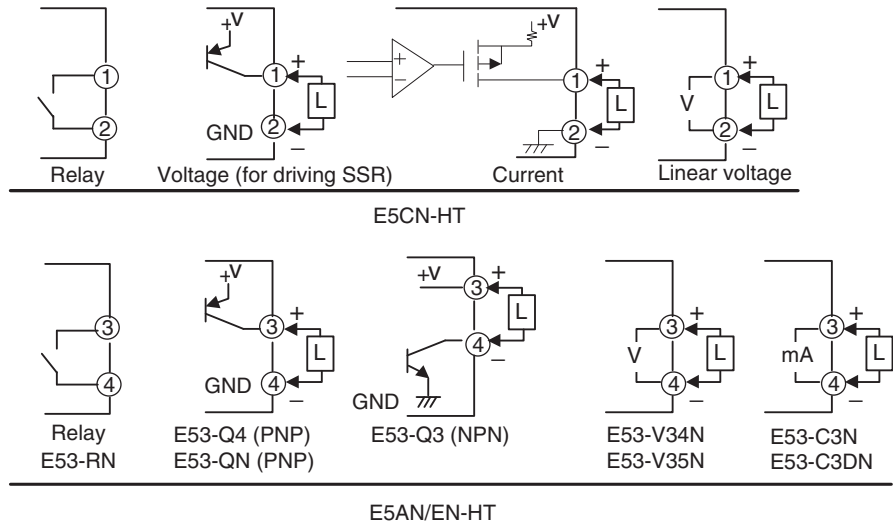

- The following table shows the specifications for each output type.

**E5CN-HT**

Output type	Specifications
Relay	250 VAC, 3 A (resistive load), electrical durability: 100,000 operations
Voltage (for driving SSR)	PNP type, 12 VDC $\pm$ 15%, 21 mA (with short-circuit protection)
Current	DC 4 to 20 mA/DC 0 to 20 mA, resistive load: 600 $\Omega$ max. Resolution: Approx. 10,000
Linear voltage	0 to 10 VDC, resistive load: 1 k $\Omega$ max. Resolution: Approx. 10,000

**E5AN/EN-HT**

Output type	Specifications
Relay (Position-proportional models)	250 VAC 1 A (including inrush current)



■ Output Units

Model	Output Type	Output method	Specifications
E53-RN	Relay	ON/OFF	250 VAC, 5 A (resistive load), Electrical life: 100,000 operations
E53-QN E53-Q3 E53-Q4	Voltage (PNP) Voltage (NPN) Voltage (PNP)	ON/OFF ON/OFF ON/OFF	PNP type, 12 VDC, 40 mA (with short-circuit protection) NPN type, 24 VDC, 20 mA (with short-circuit protection) PNP type, 24 VDC, 20 mA (with short-circuit protection)
E53-C3N E53-C3DN	4 to 20 mA 0 to 20 mA	Linear Linear	DC 4 to 20 mA, resistive load: 600 Ω max. Resolution: Approx. 10,000 DC 0 to 20 mA, resistive load: 600 Ω max. Resolution: Approx. 10,000
E53-V34N E53-V35N	0 to 10 V 0 to 5 V	Linear Linear	0 to 10 VDC, resistive load: 1 kΩ min. Resolution: Approx. 10,000 to 5 VDC, resistive load: 1 kΩ min. Resolution: Approx. 10,000

- The E5CN-HT voltage output (for driving SSR) is not electrically isolated from the internal circuits. When using a grounding thermocouple, do not connect any of the control output terminals to the ground. (If a control output terminal is connected to the ground, errors will occur in the measured temperature as a result of leakage current.) E5AN/EN-HT voltage outputs (for driving SSR), however, are functionally isolated from the internal circuits.

Control Output 2

- Outputs are sent from terminals 11, 12, 14, and 15 with the E5CN-HT, and from pins 5 and 6 with the E5AN/EN-HT. The following diagrams show the available outputs and their internal equalizing circuits.

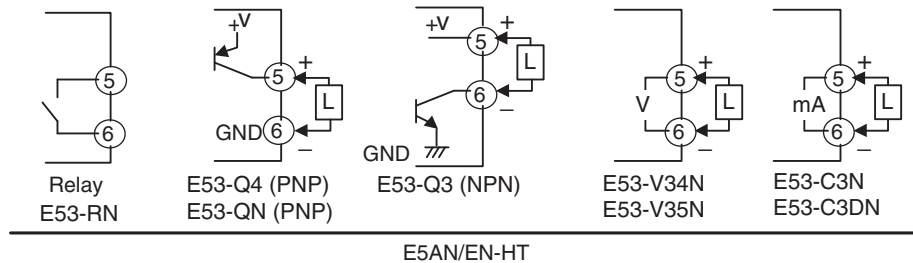
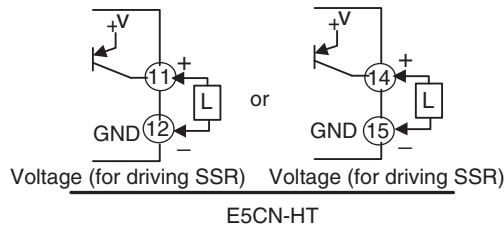

- The following table shows the specifications for each output type.

**E5CN-HT**

Output type	Specifications
Voltage (for driving SSR)	PNP type, 12 VDC ±15%, 21 mA (with short-circuit protection)

**E5AN/EN-HT**

Output type	Specifications
Relay (Position-proportional models)	250 VAC 1 A (including inrush current)

■ **Output Units**

Model	Output Type	Output method	Specifications
E53-RN	Relay	ON/OFF	250 VAC, 5 A (resistive load), Electrical life: 100,000 operations
E53-QN E53-Q3 E53-Q4	Voltage (PNP) Voltage (NPN) Voltage (PNP)	ON/OFF ON/OFF ON/OFF	PNP type, 12 VDC, 40 mA (with short-circuit protection) NPN type, 24 VDC, 20 mA (with short-circuit protection) PNP type, 24 VDC, 20 mA (with short-circuit protection)
E53-C3N E53-C3DN	4 to 20 mA 0 to 20 mA	Linear Linear	DC 4 to 20 mA, resistive load: 600 Ω max. Resolution: Approx. 10,000 DC 0 to 20 mA, resistive load: 600 Ω max. Resolution: Approx. 10,000
E53-V34N E53-V35N	0 to 10 V 0 to 5 V	Linear Linear	0 to 10 VDC, resistive load: 1 kΩ min. Resolution: Approx. 10,000 to 5 VDC, resistive load: 1 kΩ min. Resolution: Approx. 10,000

- The E5CN-HT voltage output (for driving SSR) is not electrically isolated from the internal circuits. When using a grounding thermocouple, do not connect any of the control output terminals to the ground. (If a control output terminal is connected to the ground, errors will occur in the measured temperature as a result of leakage current.) E5AN/EN-HT voltage outputs (for driving SSR), however, are functionally isolated from the internal circuits.
- Control output 2 of the E5CN-HT is a voltage output (for driving SSR) only, and outputs across terminals 11(+) and 12(-), or 14(+) and 15(-).
- Control output 1 (voltage output for driving SSR) and control output 2 (voltage output for driving SSR) are not isolated.
- On the E5CN-HT□2□-500, auxiliary output 1 (SUB1) is output across terminals 7 and 8, and auxiliary output 2 (SUB2) is output across terminals 6 and 8.
- On the E5AN/EN-HT□2□-500, auxiliary output 1 (SUB1) is output across terminals 9 and 10, auxiliary output 2 (SUB2) is output across terminals 7 and 8.
- On the E5AN/EN-HT□3□-500, auxiliary output 1 (SUB1) is output across terminals 9 and 10, auxiliary output 2 (SUB2) is output across terminals 7 and 8, and auxiliary output 3 (SUB3) is output across terminals 14, 15 and 16.
- When the Input Error Output parameter is set to ON, the output assigned to the alarm 1 function turns ON when an input error occurs.
- If the Remote SP Input Error Output parameter is set to ON, the output assigned to the alarm 1 function will turn ON when an RSP input error occurs.
- When the HB alarm, HS alarm, or heater overcurrent alarm is used with the E5CN-HT (with E53-CN□H/HH□N2), alarms are output to the output assigned to the alarm 1 function.

**Auxiliary Outputs 2, and 3**

- When the HB alarm, HS alarm, or heater overcurrent alarm is used with the E5AN-HT/EN-HT, alarms are output across terminals 9 and 10.
- On the E5CN-HT, when heating/cooling control is used, auxiliary output 2 becomes control output (cooling).
- On the E5AN-HT and E5EN-HT, when heating/cooling control is used, control output 2 becomes the control output (cooling).
- For models that have a heater burnout alarm, an OR of the alarm 1 function and the HB alarm, HS alarm, or heater overcurrent alarm is output. If the alarm 1 function is to be used for HB alarm only, set the alarm 1 type to 0 (i.e., do not use alarm 1 function).
- The following diagrams show the internal equalizing circuits for auxiliary outputs 1, 2, and 3.

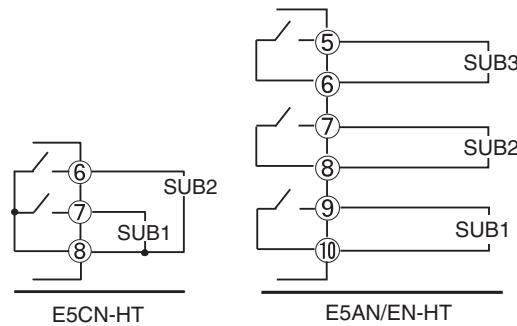

ALM1, 2, 3 can be output to auxiliary output 1, 2, 3 or changed with the advanced function setting level.

- The relay specifications are as follows:

E5□N-HT (SUB1, SUB2)	SPST-NO, 250 VAC, 3 A
E5□N-HT (SUB3)	SPDT, 250 VAC, 3 A

**Event Inputs**

- The E5□N-HT□□□B□ supports event inputs. When event inputs 1/2 are to be used, connect to terminals 11 to 13, and when event inputs 3/4 are to be used, connect to terminals 23 to 25.

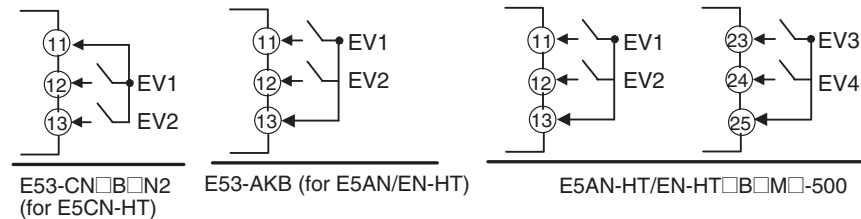

- Use event inputs under the following conditions:
- The outflow current is approximately 7 mA.

Contact inputON: 1 kΩ max., OFF: 100 kΩ min.
No-contact inputON: Residual voltage 1.5 V max.; OFF: Leakage current 0.1 mA max.

Polarities during no-contact input are as follows:

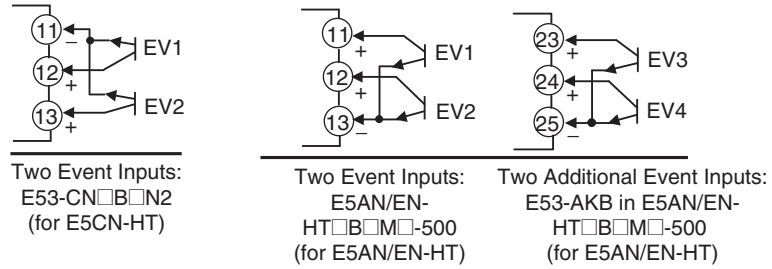

**CT Inputs**

- When the HB alarm, HS alarm, or heater overcurrent alarm is to be used with the E5CN-HT□M□-500 with an E53-CN□H□N2 Option Unit, connect a current transformer (CT) across terminals 14 and 15 or terminals 13 and 15 (no polarity).
- When the HB alarm, HS alarm, or heater overcurrent alarm is to be used with the E5AN/EN-HT□□H□-500 or E5AN/EN-HT□□HH□-500, connect a current transformer (CT) across terminals 14 and 15 or terminals 15 and 16 (no polarity).

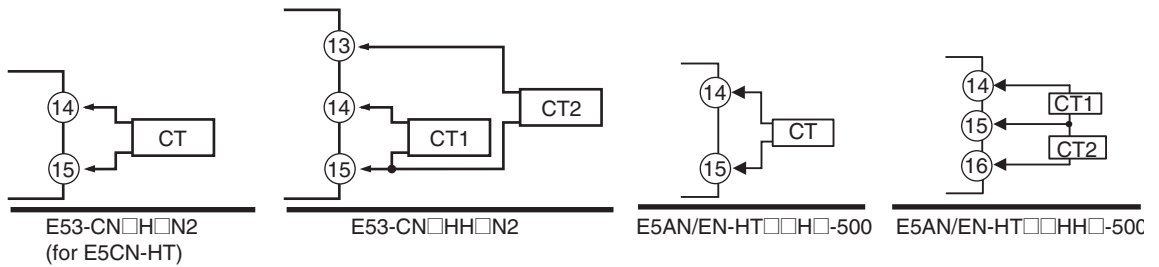

**Transfer Output**

- On the E5CN-HT□M□-500 with an E53-CN□FN2, the transfer output is output across terminals 14 and 15.
- On the E5AN/EN-HT□□F-500, transfer output is output across terminals 27 and 28.

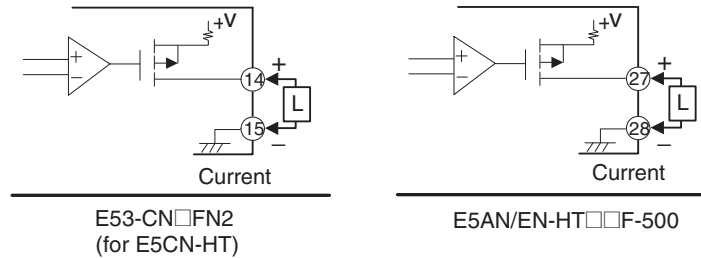

Output type	Specifications
Current	4 to 20 mA DC, Load: 600 Ω max., Resolution: 10,000

Even with models that do not have a transfer output, control outputs 1 or 2 can be used as a simple transfer output if it is a current output or linear output. For details on the operation, refer to 4-13 *Using the Transfer Output*.

Remote SP Input

- The E5AN-HT and E5EN-HT support remote SP inputs. To use remote SP, connect to terminals 29 and 30.

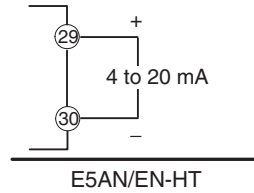

Remote SP inputs are not electrically isolated from the internal circuits. When using a grounding thermocouple, do not connect any of the remote SP input terminals to the ground. (If a remote SP input terminal is connected to the ground, errors will occur in the measured temperature as a result of leakage current.)

Communications

**RS-485**

- When communications are to be used with the E53-CN□03N2 for the E5CN-HT, or E53-EN03 for the E5AN/EN-HT, connect communications cable across terminals 11 and 12 or 21 and 22.

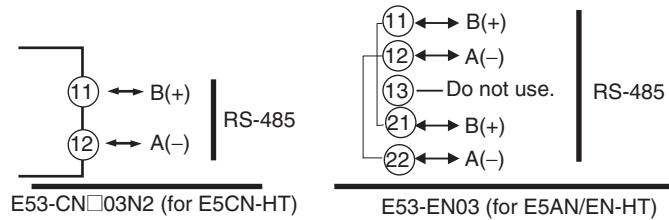

Specify both ends of the transmission path including the host computer as end nodes (that is, connect terminators to both ends). The minimum terminal resistance is 54 Ω.

**Communications Unit Connection Diagram**

**E5CN-HT**

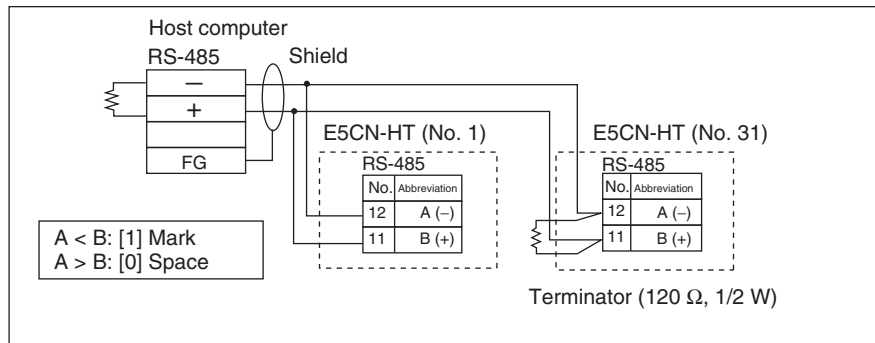

**E5AN/EN-HT**

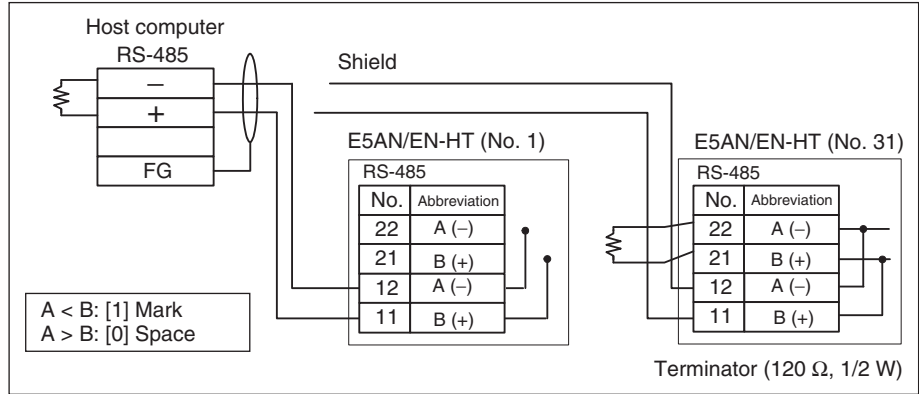

- The RS-485 connection can be either one-to-one or one-to-N. A maximum of 32 Units (including the host computer) can be connected in one-to-N systems. The maximum total cable length is 500 m. Use AWG24 (cross-sectional area: 0.205 mm<sup>2</sup>) to AWG14 (cross-sectional area: 2.081 mm<sup>2</sup>) shielded twisted-pair cable.

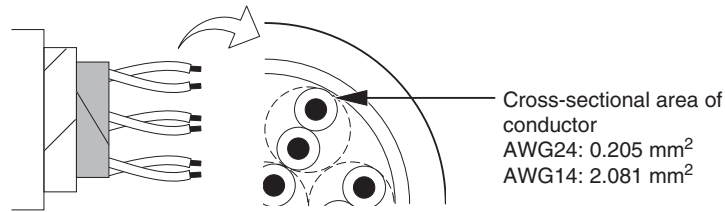

**RS-232C**

- When communications are to be used with the E53-CN□01N2 for the E5CN-HT, or the E53-EN01 for the E5AN/EN-HT, connect communications cable across terminals 11 to 13.

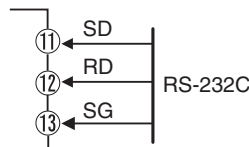

E53-CN□01N2 (for E5CN-HT)  
E53-EN01 (for E5AN/EN-HT)

Host computer  
RS-232C: 25-pin

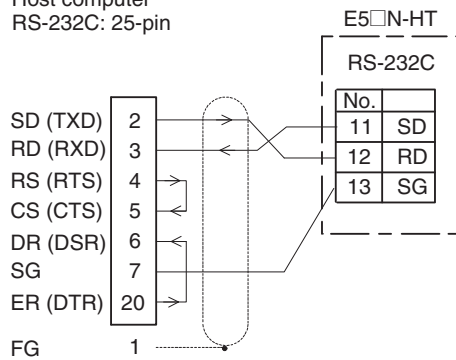

Host computer (DOS/V)  
RS-232C: 9-pin

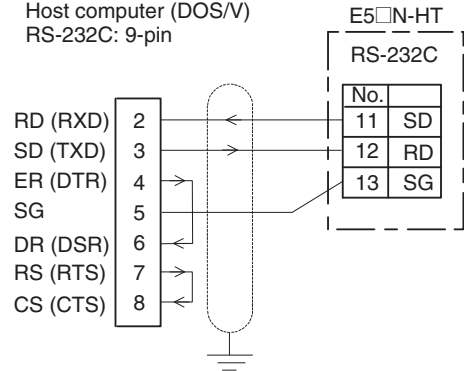

- A 1:1 connection is used. The maximum cable length is 15 m.
- Use AWG24 (cross-sectional area: 0.205 mm<sup>2</sup>) to AWG14 (cross-sectional area: 2.081 mm<sup>2</sup>) shielded twisted-pair cable.

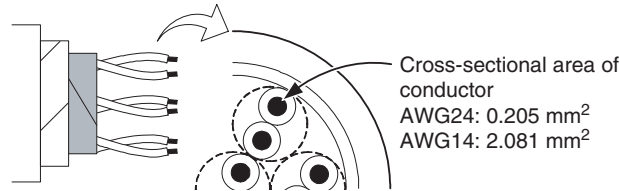

**RS-422 (E5AN/EN-HT Only)**

- When communications are to be used with the E53-EN02 for the E5AN/EN-HT, connect Communications Cable across terminals 11 to 13 and 21 to 22.

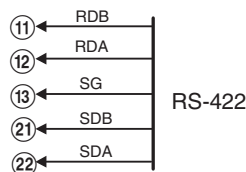

E5AN/EN-HT□M□-500  
 with an E53-EN02

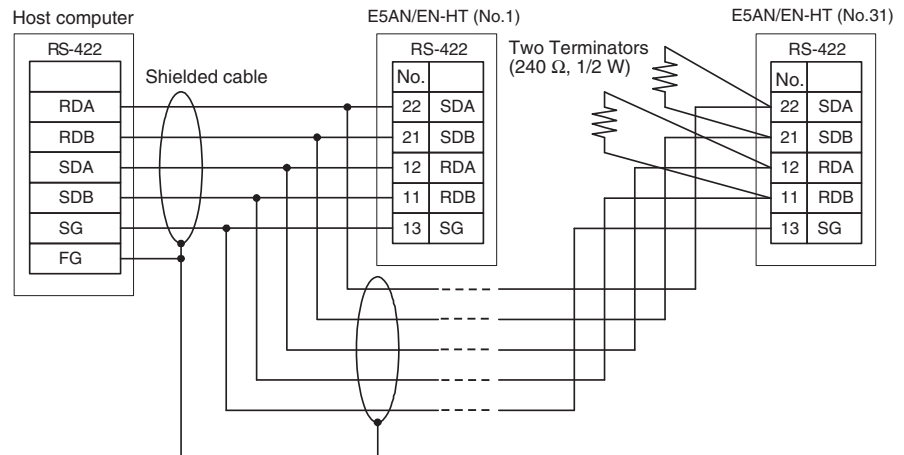

- A 1:1 or 1:N connection is used. When a 1:N connection is used, a maximum of 32 nodes including the host computer can be connected.
- Use AWG24 (cross-sectional area: 0.205 mm<sup>2</sup>) to AWG14 (cross-sectional area: 2.081 mm<sup>2</sup>) shielded twisted-pair cable.

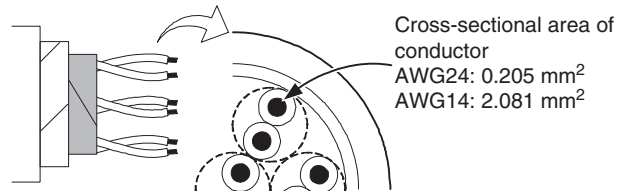

## 2-3 Using the Support Software Port

Use the communications port for Support Software to connect the personal computer to the Digital Controller when using EST2-2C-MV4 CX-Thermo or a version of CX-Thermo higher than 4.30, or other Support Software. The E58-CIFQ1 USB-Serial Conversion Cable is required to make the connection.

For information concerning the models that can be used with CX-Thermo, contact your OMRON sales representative.

### Procedure

Use the following procedure to connect the Digital Controller to the personal computer using the USB-Serial Conversion Cable. The USB-Serial Conversion Cable is used to communicate with the COM port of the personal computer. To perform communications using USB-Serial Conversion Cable, set the communications port (COM port) number to be used for the software to the COM port assigned to the Cable.

1,2,3...

1. Turn ON the power to the Digital Controller.

**Note** If the Cable is connected when the power to the Digital Controller is OFF, power will be supplied from the personal computer and impose a load on the internal circuits of the Digital Controller.

2. Connect the Cable.

Connect the personal computer's USB port with the Support Software port on the Digital Controller using the Cable.

- Digital Controller Connection Method

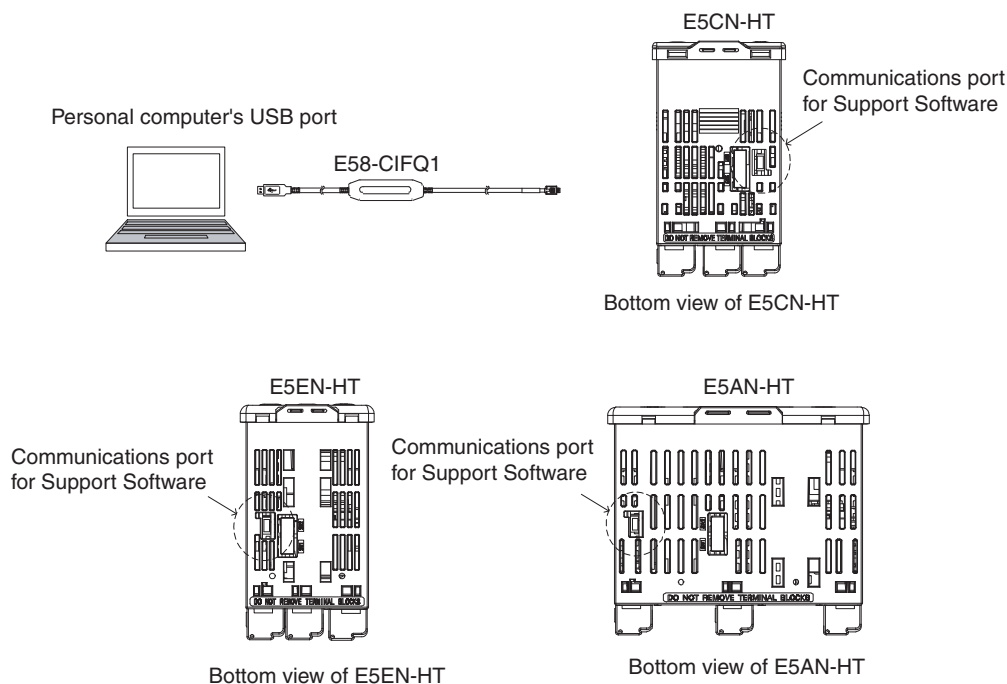

**Note** Hold the connector when inserting or disconnecting the Cable.

3. Install the driver.

Install the driver to enable the Cable to be used with the personal computer.

- Installation

When the Cable is connected with the personal computer, the OS detects the product as a new device. At this time, install the driver using the installation wizard. For details on installation methods, refer to the user's manual for the E58-CIFQ1 USB-Serial Conversion Cable.



## 4. Setting Setup Tool Communications Conditions

Set the communications port (COM port) number to be used for the CX-Thermo Setup Tool to the COM port number assigned to the USB-Serial Conversion Cable.

Refer to *3-3 CX-Thermo Operating Procedures (Online)* in the CX-Thermo help for details on setting the communications port (COM port) number.

Refer to the E58-CIFQ1 USB-Serial Conversion Cable *Instruction Manual* and *Setup Manual* for details on how to check the COM port assigned to the USB-Serial Conversion Cable.

The communications conditions for Setup Tool COM ports are fixed as shown in the table below. Set the communications conditions for the CX-Thermo Setup Tool according to the following table.

Parameter	Set value
Communications Unit No.	01
Communications baud rate	38.4 (kbps)
Communications data length	7 (bits)
Communications stop bits	2 (bits)
Communications parity	Even

## 2-4 Using Infrared Communications

When a Setup Tool, such as CX-Thermo version 4.30 or later (EST2-2C-MV4 or later), is used, the personal computer and Digital Controller can be connected using infrared communications. Using infrared communications enables the personal computer and Digital Controller to be connected from the front panel while ensuring a dust-tight and drip-tight structure. Use a USB-Infrared Conversion Cable, and connect it to the USB port at the personal computer. Infrared communications are supported only for the E5AN-HT and E5EN-HT. The infrared communications port and the Setup Tool port cannot be used at the same time.

For information concerning the models that can be used with the CX-Thermo, contact your OMRON sales representatives.

### Procedure

Use the following procedure to connect the Digital Controller to the personal computer using the USB-Infrared Conversion Cable. The USB-Infrared Conversion Cable is used to communicate with the COM port on the personal computer. To perform communications using the USB-Infrared Conversion Cable, set the communications port (COM port) number to be used for the Setup Tool (such as CX-Thermo) to the COM port assigned to the Cable.

- 1,2,3...**
1. Connecting the USB-Infrared Conversion Cable to the Personal Computer  
Connect the USB-Infrared Conversion Cable to the USB port on the personal computer.
  2. Install the driver  
Install the driver to enable the USB-Infrared Conversion Cable to be used with the personal computer.
    - Installation  
When the Cable is connected with the personal computer, the OS will detect it as a new device. At this time, install the driver using the installation wizard. For details on installation methods, refer to the *Instruction Sheet* and *Setup Manual* for the E58-CIFIR USB-Infrared Conversion Cable.

3. Enabling Digital Controller Infrared Communications

Mount the Digital Controller to the panel and wire it. Turn ON the power supply for the Digital Controller, go to the adjustment level, and set the Infrared Communications Use parameter to ON. When this parameter is set to ON, the Ir indicator on the front panel of the Digital Controller will light. This enables connecting to a personal computer using infrared communications.

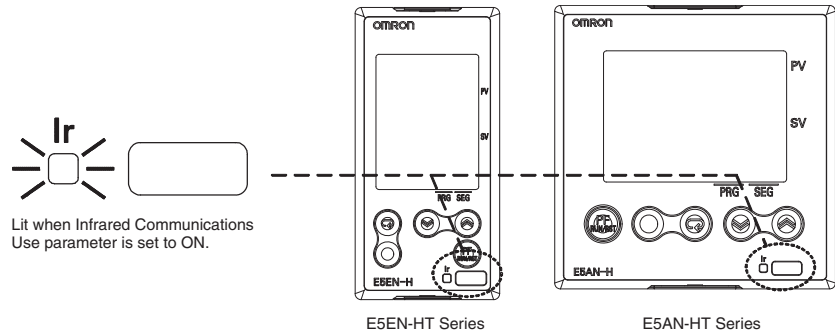

4. Connecting the USB-Infrared Conversion Cable to the Digital Controller

Mount the enclosed adapter to the Digital Controller. Hold the USB-Infrared Conversion Cable with the label side facing up, and insert the Cable into the adapter to the line specified on the label.

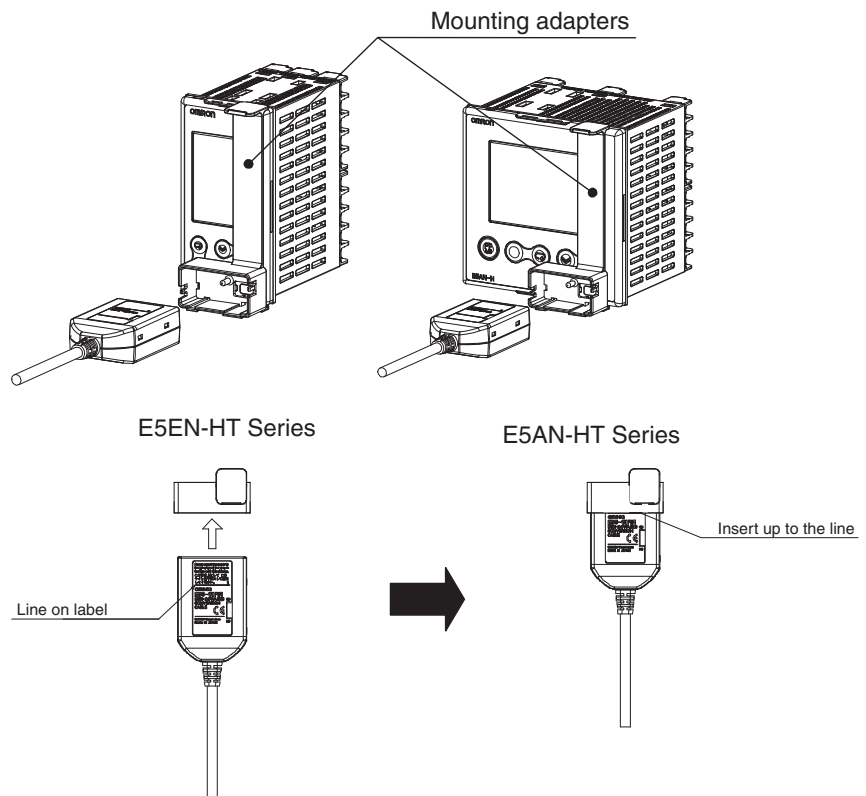

5. Setting the Setup Tool Communications Conditions

Set the communications port (COM port) number to be used for the CX-Thermo Setup Tool to the COM port number assigned to the USB-Infrared Conversion Cable.

Refer to the E58-CIFIR USB-Infrared Conversion Cable *Instruction Sheet*

and *Setup Manual* for details on checking the COM port assigned to the USB-Infrared Conversion Cable. The communications conditions for infrared COM ports are fixed as shown in the table below. Set the communications conditions for the CX-Thermo Setup Tool according to the following table.

Parameter	Set value
Communications Unit No.	01
Communications baud rate	38.4 (kbps)
Communications data length	7 (bits)
Communications stop bits	2 (bits)
Communications parity	Even

6. Checking the Settings

After completing all data transfers, be sure that the data is correct. Finally, remove the USB-Infrared Conversion Cable and mounting adapter from the Digital Controller and set the Infrared Communications Use parameter to OFF. Operation can now be started.

Turn ON the Infrared Communications Use parameter only when connected to the Setting Tool through infrared communications. Leave it set to OFF during normal operation.





# SECTION 3

## Basic Operation

This section describes the basic operation of the E5CN-H, E5AN-H, and E5EN-H Digital Controllers, including key operations to set parameters and descriptions of display elements based on specific control examples.

3-1	Initial Setting Examples . . . . .	48
3-2	Setting the Input Type . . . . .	52
3-2-1	Input Type . . . . .	52
3-3	Selecting the Temperature Unit . . . . .	54
3-3-1	Temperature Unit . . . . .	54
3-4	Selecting PID Control or ON/OFF Control . . . . .	54
3-5	Setting Output Specifications . . . . .	55
3-5-1	Control Periods . . . . .	55
3-5-2	Direct and Reverse Operation . . . . .	55
3-5-3	Assigned Output Functions . . . . .	56
3-6	Setting Programs . . . . .	60
3-6-1	Outline of Program Functions . . . . .	60
3-6-2	Program Settings . . . . .	60
3-6-3	Program Setting Example . . . . .	61
3-7	Using ON/OFF Control . . . . .	63
3-7-1	ON/OFF Control . . . . .	63
3-7-2	Settings . . . . .	64
3-8	Determining the PID Constants (AT or Manual Settings) . . . . .	65
3-8-1	AT (Auto-tuning) . . . . .	65
3-8-2	RT (Robust Tuning) . . . . .	68
3-8-3	Manual Setup . . . . .	70
3-9	Alarm Outputs . . . . .	71
3-9-1	Alarm Types . . . . .	72
3-9-2	Alarm Values . . . . .	74
3-10	Using Heater Burnout, Heater Short, and Heater Overcurrent Alarms . . . . .	76
3-10-1	Heater Burnout, Heater Short, and Heater Overcurrent Alarm Operations . . . . .	76
3-10-2	Installing Current Transformers (CT) . . . . .	77
3-10-3	Calculating Detection Current Values . . . . .	78
3-10-4	Application Examples . . . . .	79
3-10-5	Settings: HB Alarm . . . . .	83
3-10-6	Settings: Heater Short Alarm . . . . .	84
3-10-7	Settings: Heater Overcurrent Alarm . . . . .	85
3-11	Setting the No. 3 Display . . . . .	87
3-11-1	PV/SP Display Selection (spdp) . . . . .	87
3-12	Starting and Stopping Operation (rtsm) . . . . .	89
3-13	Adjusting Programs . . . . .	91
3-13-1	Changing the SP . . . . .	91
3-13-2	Changing the Time . . . . .	91

### 3-1 Initial Setting Examples



Initial hardware setup, including the sensor input type, alarm types, control periods, and other settings is done using parameter displays. The  and  Keys are used to switch between parameters, and the amount of time that you press the keys determines which parameter you move to.

This section describes 3 typical examples.

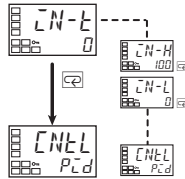

#### Explanation of Examples

##### Changing Parameters



A  image means that there are parameters. Continue pressing the  Key to change parameters until you reach the intended parameter.

##### Changing Numbers

 Numeric data and selections in each screen can be changed by using the  and  Keys.

Example 1 (Models with Standard or Heating/Cooling Control)

Input type: 5 (K thermocouple, -200.0°C to 1,300.0°C)  
 Control method: ON/OFF control  
 Alarm type: 2 (upper limit)  
 Alarm value 1: 20°C (deviation)

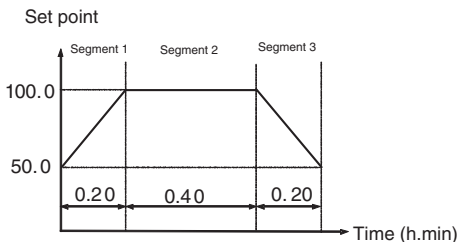

Parameter	Setting
Number of Segments Used (Program 0)	4
Program No.	0

Segment No.	0	1	2	3
Segment Set Point	50.0	100.0	100.0	50.0
Segment Time (h.min)	0.00	0.20	0.40	0.20

Setup Procedure

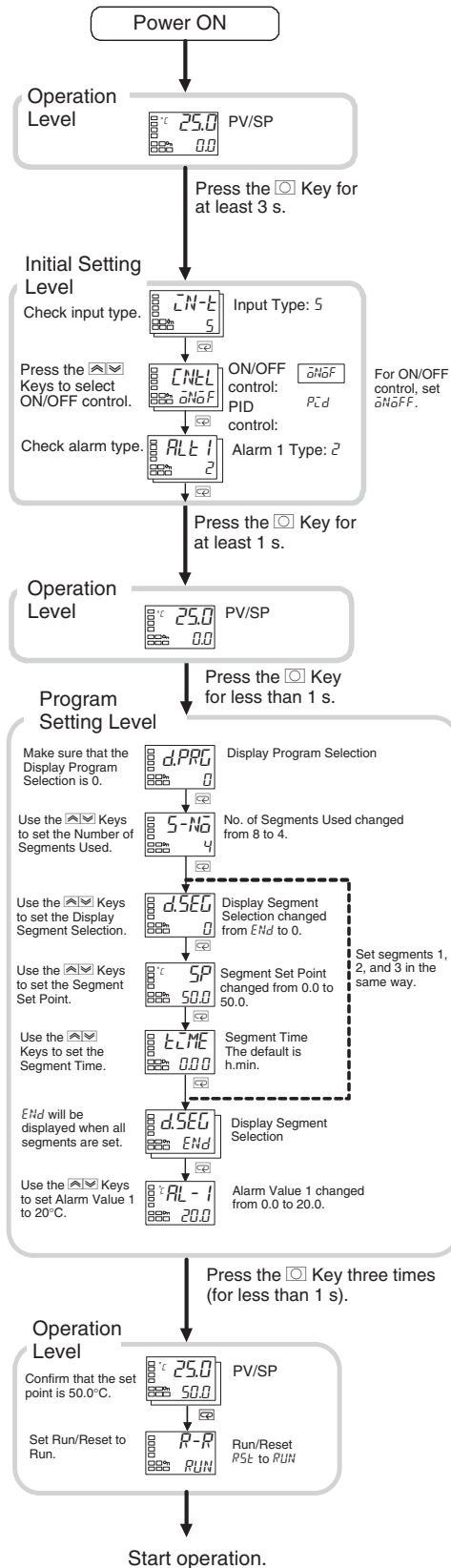
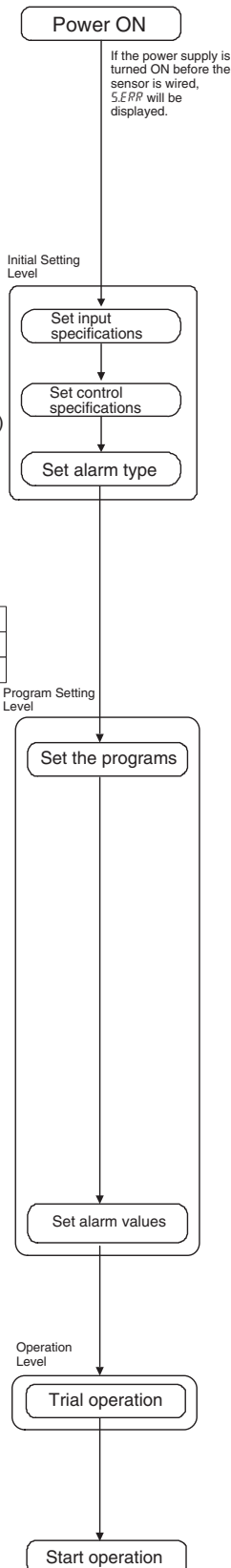

Example 2 (Models with Standard or Heating/Cooling Control)

Setup Procedure

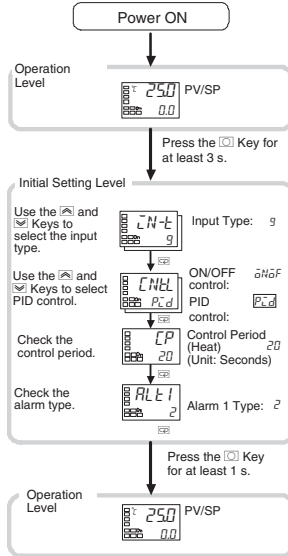
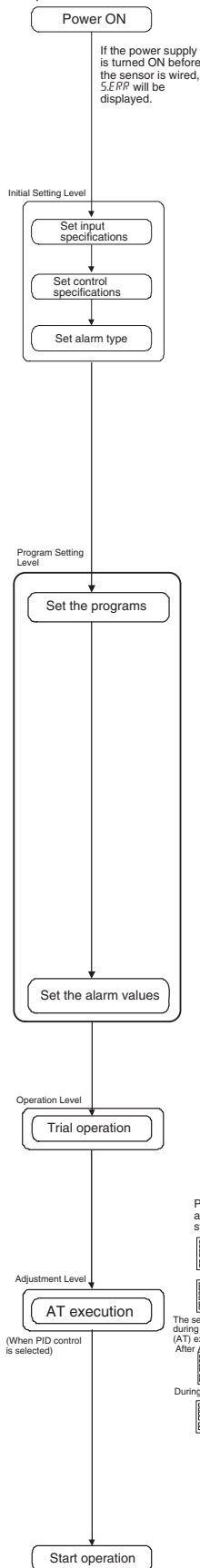

Input type: 9 (T thermocouple, -200.0°C to 400.0°C)  
 Control method: PID control  
 PID constants found using auto-tuning (AT).  
 Alarm type: 2 upper limit  
 Alarm value 1: 30°C

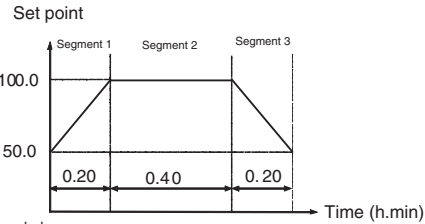

It is recommended that 20 seconds be set for a relay output and 2 seconds for an SSR voltage output.

Parameter	Setting
Number of Segments Used (Program 0)	4
Program No.	0

Segment No.	0	1	2	3
Segment Set Point	50.0	100.0	100.0	50.0
Segment Time (h.min)	0.00	0.20	0.40	0.20

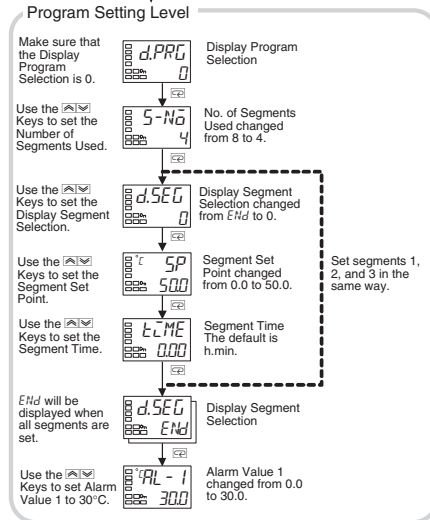

Set segments 1, 2, and 3 in the same way.

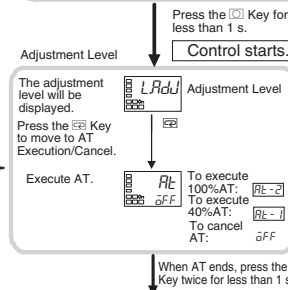
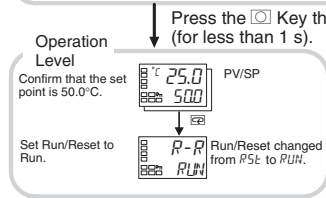

To execute 100% AT: select AL-2  
 To execute 40% AT: select AL-1  
 To cancel AT: select OFF: (AT cancel).

Execute AT for the SP that is the most important in control. For this program, AT is executed for 100.0°C.

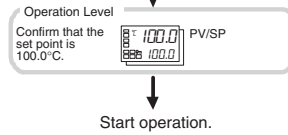



Example 3 (Models with Position-proportional Control)

Input type: 5 (K thermocouple, -200.0°C to 1,300.0°C)  
 Control method: Floating control (default)  
 Travel time: 45 s

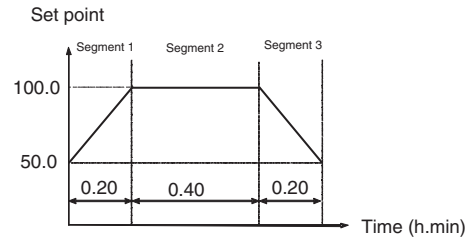
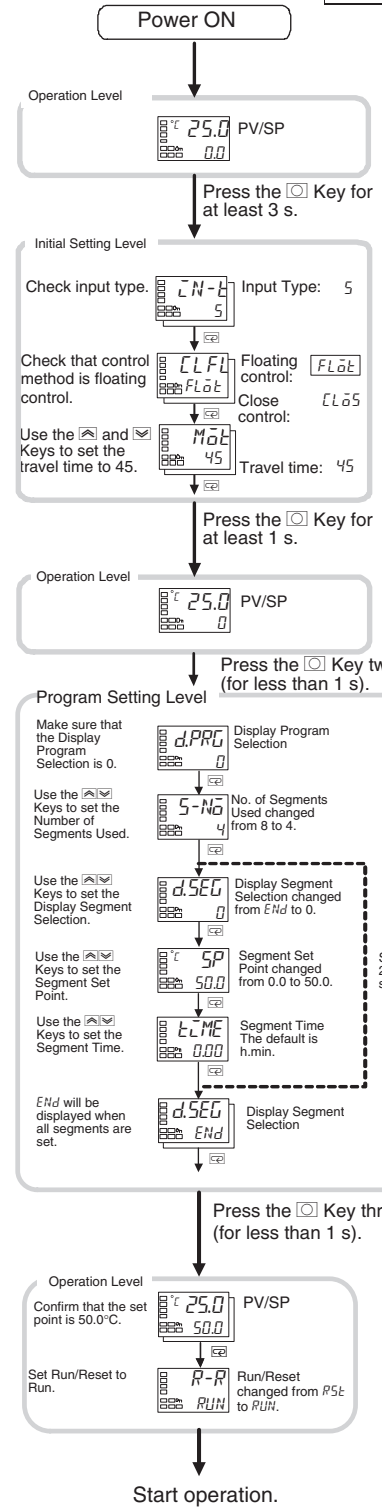
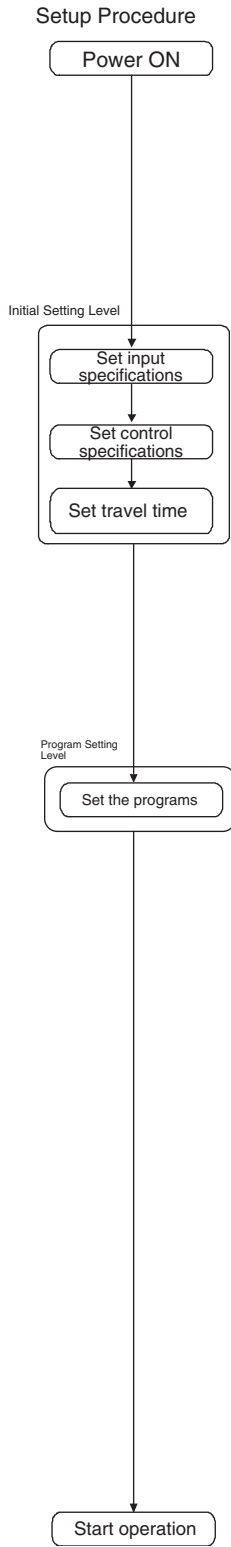

Parameter	Setting
Number of Segments Used (Program 0)	4
Program No.	0

Segment No.	0	1	2	3
Segment Set Point	50.0	100.0	100.0	50.0
Segment Time (h.min)	0.00	0.20	0.40	0.20

## 3-2 Setting the Input Type

The Controller supports 3 input types: platinum resistance thermometer, thermocouple, and analog inputs. Set the input type that matches the sensor that is used.

### 3-2-1 Input Type

The following example shows how to set a K thermocouple for -20.0 to 500.0°C.

#### Operating Procedure

Operation Level

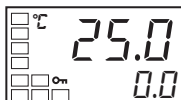

1. Press the Key for at least three seconds to move from the operation level to the initial setting level.

Initial Setting Level

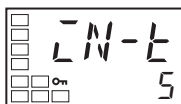

Input Type

2. Press the Key to enter the set value of the desired sensor. When you use a K thermocouple (-20.0 to 500.0°C), enter 6 as the set value.

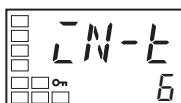

**Hint:** The key operation is saved two seconds after the change, or by pressing the or Key.

#### List of Input Types

Input type	Specifications	Set value	Input temperature setting range
Platinum resistance thermometer	Pt100	0	-200.0 to 850.0 (°C)/-300.0 to 1,500.0 (°F)
		1	-199.9 to 500.0 (°C)/-199.9 to 900.0 (°F)
		2	0.0 to 100.0 (°C)/0.0 to 210.0 (°F)
	JPt100	3	-199.9 to 500.0 (°C)/-199.9 to 900.0 (°F)
4		0.0 to 100.0 (°C)/0.0 to 210.0 (°F)	
Thermocouple	K	5	-200.0 to 1,300.0 (°C)/-300.0 to 2,300.0 (°F)
		6	-20.0 to 500.0 (°C)/0.0 to 900.0 (°F)
	J	7	-100.0 to 850.0 (°C)/-100.0 to 1,500.0 (°F)
		8	-20.0 to 400.0 (°C)/0.0 to 750.0 (°F)
	T	9	-200.0 to 400.0 (°C)/-300.0 to 700.0 (°F)
		10	-199.9 to 400.0 (°C)/-199.9 to 700.0 (°F)
	E	11	-200.0 to 600.0 (°C)/-300.0 to 1,100.0 (°F)
	L	12	-100.0 to 850.0 (°C)/-100.0 to 1,500.0 (°F)
	U	13	-200.0 to 400.0 (°C)/-300.0 to 700.0 (°F)
		14	-199.9 to 400.0 (°C)/-199.9 to 700.0 (°F)
	N	15	-200.0 to 1,300.0 (°C)/-300.0 to 2,300.0 (°F)
	R	16	0.0 to 1,700.0 (°C)/0.0 to 3,000.0 (°F)
	S	17	0.0 to 1,700.0 (°C)/0.0 to 3,000.0 (°F)
	B	18	100.0 to 1,800.0 (°C)/300.0 to 3,200.0 (°F)
	W	19	0.0 to 2,300.0 (°C)/0.0 to 3,200.0 (°F)
PLII	20	0.0 to 1,300.0 (°C)/0.0 to 2,300.0 (°F)	
K	21	-50.0 to 200.0 (°C)/-50.0 to 200.0 (°F)	
J	22	-50.0 to 200.0 (°C)/-50.0 to 200.0 (°F)	
T	23	-50.0 to 200.0 (°C)/-50.0 to 200.0 (°F)	

Input type	Specifications	Set value	Input temperature setting range
Platinum resistance thermometer	Pt100	24	-50.0 to 200.0 (°C)/-50.0 to 200.0 (°F)
Current input	4 to 20 mA	25	Either of the following ranges, by scaling: -19999 to 32400 -1999.9 to 3240.0 -199.99 to 324.00 -19.999 to 32.400
	0 to 20 mA	26	
Voltage input	1 to 5 V	27	
	0 to 5 V	28	
	0 to 10 V	29	

- The default is 5.
- If a platinum resistance thermometer is mistakenly connected while a setting for other than a platinum resistance thermometer is in effect, S.ERR will be displayed. To clear the S.ERR display, check the wiring and then turn the power OFF and back ON.

### 3-3 Selecting the Temperature Unit

#### 3-3-1 Temperature Unit

- Either °C or °F can be selected as the temperature unit.
- Set the temperature unit in the Temperature Unit parameter of the initial setting level. The default is  $\bar{C}$  (°C).

#### Operating Procedure

The following example shows how to select °C as the temperature unit.

Operation Level

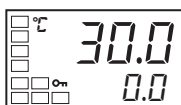

1. Press the  $\square$  Key for at least three seconds to move from the operation level to the initial setting level.

Initial Setting Level

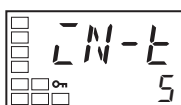

Input Type

2. Select the Temperature Unit parameter by pressing the  $\square$  Key. Press the  $\wedge$  or  $\vee$  Key to select either °C or °F.  
 $\bar{C}$ : °C  
 $\bar{F}$ : °F

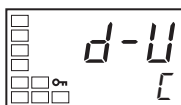

Temperature Unit

3. To return to the operation level, press the  $\square$  Key for at least one second.

### 3-4 Selecting PID Control or ON/OFF Control

#### 3-4-1 PID·ON/OFF ( $\bar{C}N\bar{E}L$ )

Two control methods are supported: 2-PID control and ON/OFF control. Switching between 2-PID control and ON/OFF control is executed by means of the PID ON/OFF parameter in the initial setting level. When this parameter is set to  $\bar{P}\bar{I}\bar{D}$ , 2-PID control is selected, and when set to  $\bar{O}\bar{N}\bar{O}\bar{F}\bar{F}$ , ON/OFF control, is selected. The default is  $\bar{P}\bar{I}\bar{D}$ . ON/OFF control is not displayed for position-proportional models.

#### 2-PID Control

Use auto-tuning to set the PID constants, or set them manually.

For PID control, set the PID constants in the Proportional Band (P), Integral Time (I), and Derivative Time (D) parameters.

#### ON/OFF Control

In ON/OFF control, the control output is turned ON when the process value is lower than the current set point, and the control output is turned OFF when the process value is higher than the current set point (reverse operation).

### 3-5 Setting Output Specifications

The following table shows the parameters related to outputs. Each of the parameters is described in detail following the table.

Parameter		Standard models	Position-proportional models
CP	Control Period (Heating)	●	
C-CP	Control Period (Cooling)	●	
REV	Direct/Reverse Operation	●	●
OUT1	Control Output 1 Assignment	●	
OUT2	Control Output 2 Assignment	●	
SUB1	Auxiliary Output 1 Assignment	●	●
SUB2	Auxiliary Output 2 Assignment	●	●
SUB3	Auxiliary Output 3 Assignment	●	

(●: Supported)

#### 3-5-1 Control Periods

 Control Period (Heating)

 Control Period (Cooling)

- Set the output periods (control periods). Though a shorter period provides better control performance, it is recommended that the control period be set to 20 seconds or longer for a relay output to preserve the service life of the relay. After the settings have been made in the initial setup, readjust the control period, as required, by means such as trial operation.
- Set the control periods in the Control Period (Heating) and Control Period (Cooling) parameters in the initial setting level. The default is 20 seconds.
- The Control Period (Cooling) parameter is used only for heating/cooling control.
- When the control output is used as a current output or linear voltage output, the Control Period settings cannot be used.
- The control period can be set for standard models only.

#### 3-5-2 Direct and Reverse Operation

- Direct operation increases the manipulated variable whenever the process value increases. Reverse operation decreases the manipulated variable whenever the process value increases.

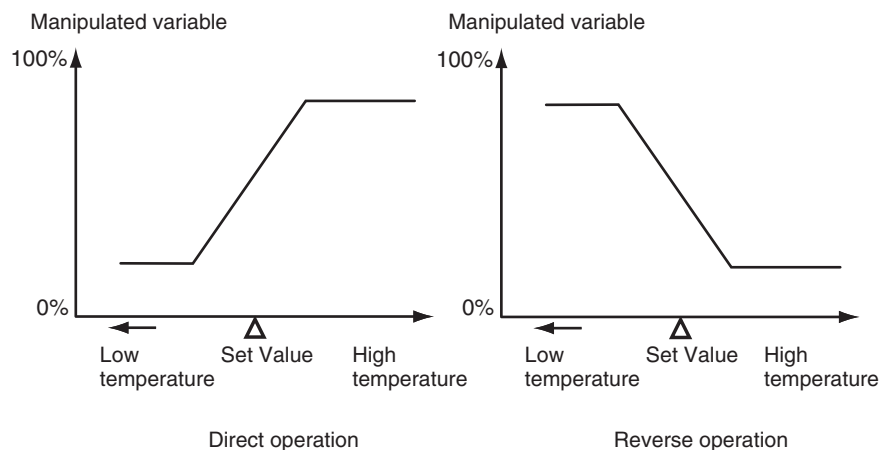

For example, when the process value (PV) is lower than the set point (SP) in a heating control system, the manipulated variable increases according to the difference between the PV and SP. Accordingly, reverse operation is used in a heating control system. Direct operation is used in a cooling control system, in which the operation is the opposite of a heating control system. For either direct or reverse operation, assign control output 1 to  $\bar{a}$  (control output (heating)).

- Direct/reverse operation is set in the Direct/Reverse Operation parameter in the initial setting level. The default is  $\bar{a}R-R$  (reverse operation).

**Operating Procedure**

In this example, the input type, temperature unit, direct/reverse operation, and control period (heat) parameters are checked.

Input type = 5 (K thermocouple)  
 Temperature unit = C (°C)  
 Direct/reverse operation =  $\bar{a}R-R$  (reverse operation)  
 Control period (heat) = 20 (seconds)

Operation Level

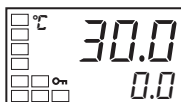

1. Press the Key for at least three seconds to move from the operation level to the initial setting level.

Initial Setting Level

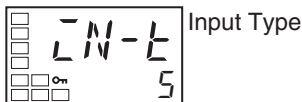

2. The input type is displayed. When the input type is being set for the first time, 5 (K thermocouple) is set. To select a different sensor, press the or Key.

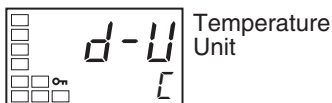

3. Select the Temperature Unit parameter by pressing the Key. The default is C (°C). To select F (°F), press the Key.

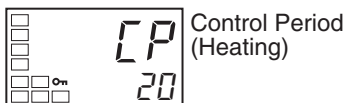

4. Select the Control Period (Heating) parameter by pressing the Key. The default is 20.



5. Select the Direct/Reverse Operation parameter by pressing the Key. The default is  $\bar{a}R-R$  (reverse operation). To select  $\bar{a}R-d$  (direct operation), press the Key.

Operation Level



6. To return to the operation level, press the Key for at least one second.

**3-5-3 Assigned Output Functions**

- Function assignments can be changed by changing the settings for control and auxiliary output assignments.
- The default function assignments for each output are shown below.

Parameter name	Symbol	Initial status
Control Output 1 Assignment	$\bar{a}Ut 1$	Control output (heating)
Control Output 2 Assignment	$\bar{a}Ut 2$	Not assigned.
Auxiliary Output 1 Assignment	$Sub 1$	Alarm 1

Parameter name	Symbol	Initial status
Auxiliary Output 2 Assignment	Sub2	Alarm 2
Auxiliary Output 3 Assignment (E5AN/EN-H only)	Sub3	Alarm 3

- Each output is automatically initialized as shown below by changing the control mode.

**Example: E5CN-HT**

Parameter name	Symbol	Without control output 2		With control output 2	
		Standard	Heating/cooling	Standard	Heating/cooling
Control Output 1 Assignment	OUT 1	Control output (heating)	Control output (heating)	Control output (heating)	Control output (heating)
Control Output 2 Assignment	OUT 2	Not assigned. (See note 1.)	Not assigned. (See note 1.)	Not assigned.	Control output (cooling)
Auxiliary Output 1 Assignment	Sub 1	Alarm 1	Alarm 1	Alarm 1	Alarm 1
Auxiliary Output 2 Assignment	Sub 2	Alarm 2	Control output (cooling)	Alarm 2	Alarm 2

**Note** (1) There is no control output 2 and no parameter assignment is displayed for that output.

■ **Alarms**

It will be specified in this section when an alarm must be assigned, i.e., when an alarm must be set for the Control Output 1 or 2 Assignment parameters, or for the Auxiliary Output 1 or 3 Assignment parameters. For example, if alarm 1 is set for the Control Output 1 Assignment parameter, then alarm 1 has been assigned.

Assigning a work bit to either control output 1 or 2 or to auxiliary output 1 to 3 is also considered to be the same as assigning alarms and time signals. For example, if work bit 1 is set for the Auxiliary Output 1 Assignment parameter, then alarms 1 to 3 and time signals 1 and 2 are assigned.

**Operating Procedure**

This procedure sets the following control and auxiliary output assignments. Control output 1: Control output (heating); Control output 2: Control output (cooling); Auxiliary output 1: Alarm 1; Auxiliary output 2: Alarm 2

Operation Level



1. Press the Key for at least three seconds to move from the operation level to the initial setting level.

Initial Setting Level

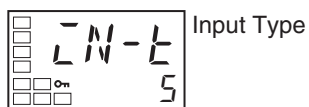

2. Select the Standard or Heating/Cooling parameter by pressing the Key.

Initial Setting Level



Initial Setting Level

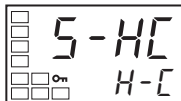

3. Press the Key to set the parameter to  $H-L$ .

**Note** The following output assignments do not need to be set because they are set automatically by changing the control mode, but they are shown here as a reference for checking the assignments for each output.



Move to Advanced Function Setting Level

4. Select the Move to Advanced Function Setting Level parameter by pressing the Key. (For details on moving between levels, refer to 4-7 Moving to the Advanced Function Setting Level.)

Advanced Function Setting Level

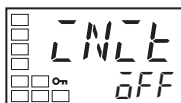

Parameter Initialization

5. Press the Key to enter the password ("169"), and move from the initial setting level to the advanced function setting level.

Advanced Function Setting Level



Control Output 1 Assignment

6. Select the Control Output 1 Assignment parameter by pressing the Key.



7. Press the or Key to set  $\bar{0}$ . (The default is  $\bar{0}$ .)

Advanced Function Setting Level

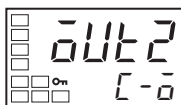

Control Output 2 Assignment

8. Select the Control Output 2 Assignment parameter by pressing the Key.

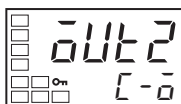

9. Press the or Key to set  $L-\bar{0}$ . (When  $H-L$  is selected for the Standard or Heating/Cooling parameter, the setting will be  $L-\bar{0}$ .)

Advanced Function Setting Level

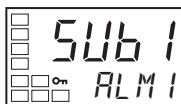

Auxiliary Output 1 Assignment

10. Select the Auxiliary Output 1 Assignment parameter by pressing the Key.

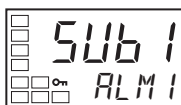

11. Press the or Key to set  $ALM 1$ . (The default is  $ALM 1$ .)

Advanced Function Setting Level

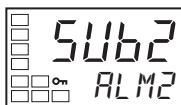

Auxiliary Output 2 Assignment

12. Select the Auxiliary Output 2 Assignment parameter by pressing the Key.

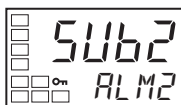

13. Press the or Key to set  $ALM 2$ . (The default is  $ALM 2$ .)



Initial Setting Level

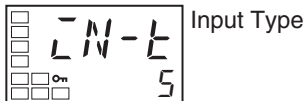

Operation Level



14. Press the Key for at least one second to move from the advanced function setting level to the initial setting level.
15. Press the Key for at least one second to move from the initial setting level to the operation level.

**Auxiliary Output**  
**Opening or Closing in**  
**Alarm (5b IN, 5b2N)**

- When “close in alarm” is set, the status of the auxiliary output is output unchanged. When “open in alarm” is set, the status of the auxiliary output function is reversed before being output.
- Each auxiliary output can be set independently.
- These settings are made in the Auxiliary Output 1 to 3 Open in Alarm parameters (advanced function setting level).
- The default is  $N-\bar{a}$ : Close in Alarm.
- When “open in alarm” is set for the alarm 1 output, the open in alarm status is also applied to heater burnout, HS alarm, heater overcurrent, and input error outputs.

	Auxiliary output functions 1 to 3	Auxiliary output	Indicators (SUB1 to SUB3)
Close in Alarm	ON	ON	Lit
	OFF	OFF	Not lit
Open in Alarm	ON	OFF	Lit
	OFF	ON	Not lit

- The alarm output will turn OFF (i.e., the relay contacts will open) when power is interrupted and for about two seconds after the power is turned ON regardless of the setting of the Auxiliary Output 1 to 3 Open in Alarm parameter.

## 3-6 Setting Programs

### 3-6-1 Outline of Program Functions

- Up to 8 programs (patterns) can be created and each program can have up to 32 segments (steps).

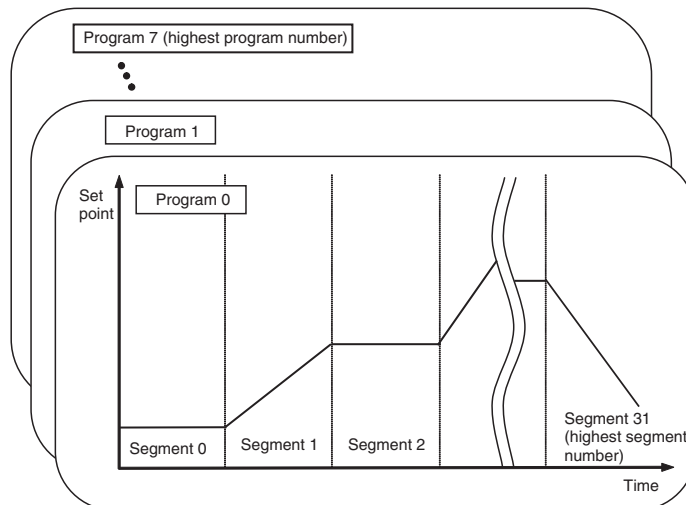

- Programming is possible either by setting the SP and time for each segment (step time programming) or by setting the target SP, rate of rise, and time for each segment (rate of rise programming).
- Program repetitions and a program link destination can be set for each program.
- You can hold measurements during operation, or advance operation to skip segments.
- If you set a wait band, each segment will wait until the PV reaches a specified band before operation moves to the next segment.
- Outputs can be assigned to time signal outputs, program end outputs, run outputs, or stage outputs.

### 3-6-2 Program Settings

Here, the procedure is given for using step time programming. For the procedure for rate of rise programming, refer to 4-15 *Program-related Functions*.

#### Selecting the Program Number (*d.PRL*)

- The Display Program Selection parameter specifies the number of the program to be set.
- The default is the number of the currently selected program.

#### Setting the Number of Segments Used (*5-Nā*)

- The Number of Segments Used parameter is used to set the number of segments used for the specified program.
- The default is 8.
- Once the number of segments set for the Number of Segments Used parameter have been executed, the program will be in operation completed status. If the setting of the Number of Segments Used parameter is changed to a value smaller than the segment currently being executed in the program, the program will immediately change to operation completed status.

#### Selecting the Segment to Set (*d.SEL*)

- Set the Display Segment Selection parameter to the number of the segment to set.

**Setting the Segment Set Points and Segment Times (SP) (LME)**

- The setting range is END or 0 to No. of Segments Used – 1. The default is END (segment setting completed).
- For step time programming, each segment has a Segment Set Point parameter and a Segment Time parameter. The number of settings is determined by the Number of Segments Used parameter.
- The setting range for the segment time is 0.00 to 99.59 (h.min or min.s). The default is 0.00.
- Segment 0 is a soak segment. To start from a ramp (increase or decrease), set the segment time for segment 0 to 0 so that actual operation starts from segment 1. (In this example, the Reset Operation parameter is set to stop control.)

**3-6-3 Program Setting Example**

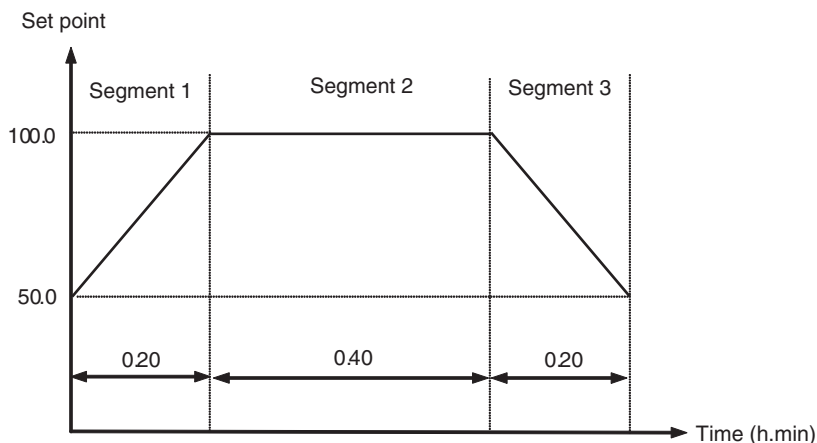

The following settings are used for the Number of Segments Used and Program No. parameters.

Parameter	Setting
Number of Segments Used (Program 1)	4
Program No.	1

The following settings are used for the Segment Set Point and Segment Time parameters for program 1.

Segment No.	0	1	2	3
Segment Set Point	50.0	100.0	100.0	50.0
Segment Time (h.min)	0.00	0.20	0.40	0.20

**Operating Procedure**

Operation Level



Program Setting Level



This procedure is used to set the program.

1. Press the Key to move from the operation level to the program setting level.
2. The Display Program Selection is displayed.
3. Press the Keys to change the setting to 1.

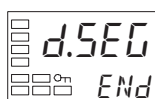
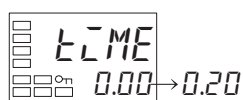
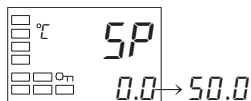
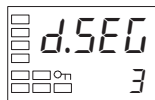
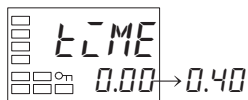
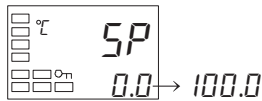
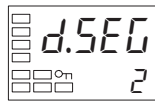
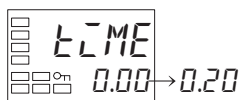
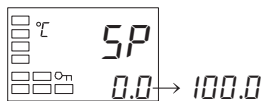
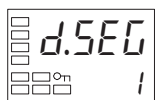
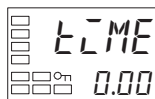
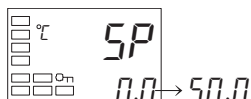
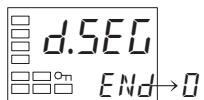
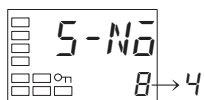

4. Press the Key to select the Number of Segments Used parameter.
5. Press the Keys to change the setting to 4.
6. Press the Key to select the Display Segment Selection parameter.
7. Press the Keys to change the setting to 0.
8. Press the Key to select the Segment Set Point parameter.
9. Press the Keys to change the setting to 50.0.
10. Press the Key to select the Segment Time parameter. Make sure that the setting is 0.00.
11. Press the Key to select the Display Segment Selection parameter. Make sure that the setting is 1.
12. Press the Key to select the Segment Set Point parameter.
13. Press the Keys to change the setting to 100.0.
14. Press the Key to select the Segment Time parameter.
15. Press the Keys to change the setting to 0.20.
16. Press the Key to select the Display Segment Selection parameter. Make sure that the setting is 2.
17. Press the Key to select the Segment Set Point parameter.
18. Press the Keys to change the setting to 100.0.
19. Press the Key to select the Segment Time parameter.
20. Press the Keys to change the setting to 0.40.
21. Press the Key to select the Display Segment Selection parameter. Make sure that the setting is 3.
22. Press the Key to select the Segment Set Point parameter.
23. Press the Keys to change the setting to 50.0.
24. Press the Key to select the Segment Time parameter.
25. Press the Keys to change the setting to 0.20.
26. Press the Key to end setting the program.

Operation Level



27. Press the  Key three times to move from the program setting level to the operation level.

## 3-7 Using ON/OFF Control

In ON/OFF control, the control output turns OFF when the temperature being controlled reaches the preset set point. When the manipulated variable turns OFF, the temperature begins to fall and the control turns ON again. This operation is repeated over a certain temperature range. At this time, how much the temperature must fall before control turns ON again is determined by the Hysteresis (Heating) parameter. Also, what direction the manipulated variable must be adjusted in response to an increase or decrease in the process value is determined by the Direct/Reverse Operation parameter.

### 3-7-1 ON/OFF Control

- Switching between 2-PID control and ON/OFF control is performed using the PID ON/OFF parameter in the initial setting level. When this parameter is set to  $P\bar{L}d$ , 2-PID control is selected, and when it is set to  $\bar{o}N\bar{o}F$ , ON/OFF control is selected. The default is  $P\bar{L}d$ .
- ON/OFF control can be set for standard models only.

#### Hysteresis (HY5) ([HY5])

- With ON/OFF control, hysteresis is used to stabilize operation when switching between ON and OFF. The control output (heating) and control output (cooling) functions are set in the Hysteresis (Heating) and Hysteresis (Cooling) parameters, respectively.
- In standard control (heating or cooling control), the setting of the Hysteresis (Heating) parameter in the adjustment level is used as the hysteresis regardless of whether the control type is heating control or cooling control.

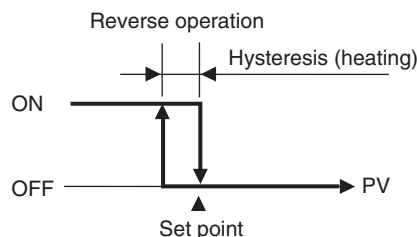

#### Three-position Control

- In heating/cooling control, a dead band (an area where both control outputs are 0) can be set to either the heating or cooling side. This makes it possible to use 3-position control.

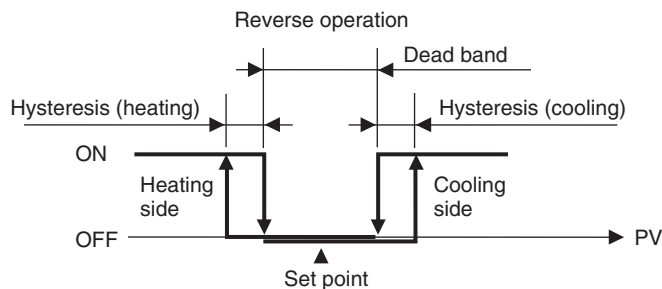

**Parameters**

Symbol	Parameter: level	Application
S-HC	Standard or Heating/Cooling: Initial setting level	Specifying control method
CNEL	PID ON/OFF: Initial setting level	Specifying control method
oREV	Direct/Reverse Operation: Initial setting level	Specifying control method
C-db	Dead Band: Adjustment level	Heating/cooling control
HYS	Hysteresis (Heating): Adjustment level	ON/OFF control
CHYS	Hysteresis (Cooling): Adjustment level	ON/OFF control

**3-7-2 Settings**

To execute ON/OFF control, set the Set Point, PID ON/OFF, and Hysteresis parameters.

**Setting the PID ON/OFF Parameter**

**Operating Procedure**

The following example shows how to change the PID ON/OFF parameter to *oNOFF* in the initial setting level.

Operation Level

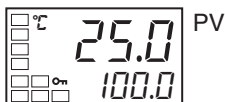

Initial Setting Level

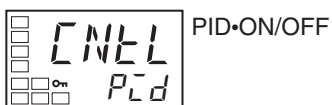
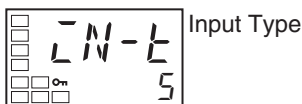

1. Press the Key for at least three seconds to move from the operation level to the initial setting level.
2. The Input Type parameter is displayed in the initial setting level.
3. Select the PID ON/OFF parameter by pressing the Key.
4. Use the and Keys to set onof.
5. To return to the operation level, press the Key for at least one second.

### Setting the Hysteresis

#### Operating Procedure

Set the hysteresis to 2.0°C.

Operation Level



1. Press the  Key twice to move from the operation level to the adjustment level.

Adjustment Level



2. The Adjustment Level Display parameter will be displayed in the adjustment level.

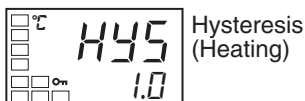

3. Select the Hysteresis (Heating) parameter by pressing the  Key.

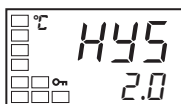

4. Press the  and  Keys to set the hysteresis (2.0 in this example). Either press the  Key or wait for at least two seconds after setting the hysteresis value to confirm the setting.

5. To return to the operation level, press the  Key twice.

## 3-8 Determining the PID Constants (AT or Manual Settings)

### 3-8-1 AT (Auto-tuning)



- When AT is executed, the optimum PID constants for the set point at that time are set automatically. A method (called the limit cycle method) for forcibly changing the manipulated variable and finding the characteristics of the control object is employed.

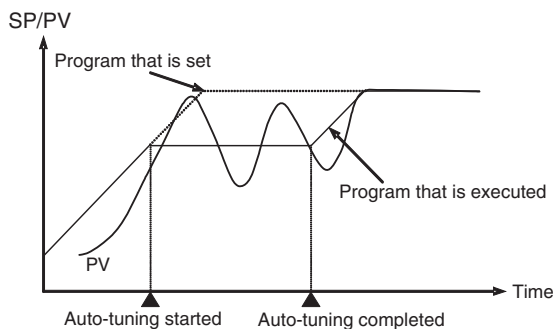

- Either 40% AT or 100% AT can be selected depending on the width of MV variation in the limit cycle. In the AT Execute/Cancel parameter, specify  $AT-2$  (100% AT) or  $AT-1$  (40% AT). To cancel AT, specify  $OFF$  (AT cancel).
- Only 100% AT can be executed for heating and cooling control or for floating control for position-proportional models.
- Auto-tuning cannot be executed while the program is reset (if the reset operation is set to stop control), while on standby (if the reset operation is set to stop control), during manual operation, and during ON/OFF control.
- The following operations are not possible during auto-tuning: changing settings, holding or releasing the program, and segment operations, such as advance operations.

- Auto-tuning will stop if the Run/Reset parameter is set to Reset and the Reset Operation parameter is set to stop control, or if you switch to manual operation.
- The following operation will be performed if the Reset Operation parameter is set to fixed SP operation.
  - If the Run/Reset parameter is changed to Reset during auto-tuning, the present SP will be changed to the fixed SP or the remote SP after autotuning has been completed.
  - If auto-tuning is executed while the Run/Reset parameter is set to Reset and the Run/Reset parameter is changed to Run during auto-tuning execution, the program will be started after completing auto-tuning.
- The results of AT are reflected in the Proportional Band (P), Integral Time (I), and Derivative Time (D) parameters for the PID set at the time AT execution starts. For details on PID sets, refer to *PID Sets* on page 136.

PID Setting Level

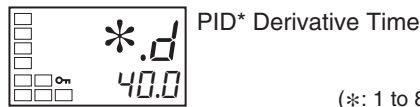
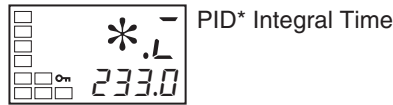
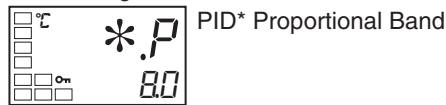

(\*: 1 to 8)

**AT Operations**

AT is started when either  $AL-2$  (100% AT) or  $AL-1$  (40% AT) is specified for the AT Execute/Cancel parameter. During execution, the AT Execute/Cancel parameter on the No. 1 display flashes. When AT ends, the AT Execute/Cancel parameter turns OFF, and the No. 1 display stops flashing.

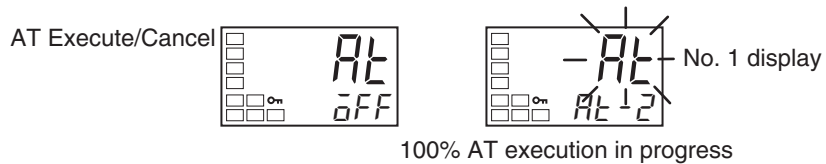

If you move to the operation level during AT execution, the No. 2 display flashes to indicate that AT is being executed.



Only the following parameters can be changed during auto-tuning: Communications Writing, Run/Reset, and AT Execute/Cancel. Other parameters cannot be changed.

**AT Calculated Gain**

The AT Calculated Gain parameter sets the gain for when PID values are calculated using AT. When emphasizing response, decrease the set value. When emphasizing stability, increase the set value.



**AT Hysteresis**

The AT Hysteresis parameter sets the hysteresis when switching ON and OFF for the limit cycle operation during auto-tuning.

**Limit Cycle MV Amplitude**

The Limit Cycle MV Amplitude parameter sets the MV amplitude for limit cycle operation during auto-tuning.

**Note** Disabled for 100% AT.

■ **40% AT (AL-1)**

The width of MV variation in the limit cycle can be changed in the Limit Cycle MV Amplitude parameter, but the AT execution time may be longer than for 100% AT. The limit cycle timing varies according to whether the deviation (DV) at the start of auto-tuning execution is less than 10% FS.

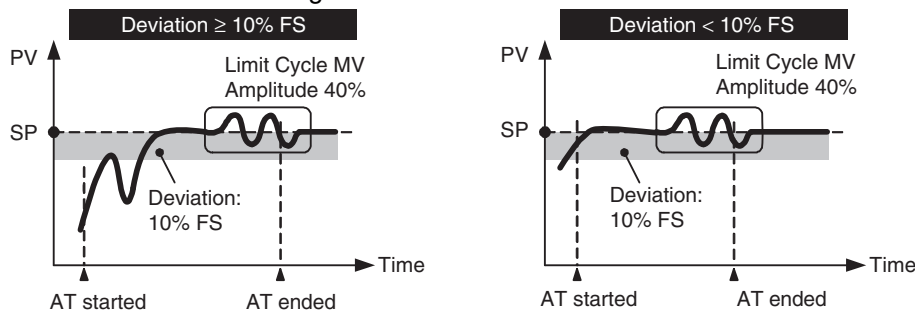

■ **100% AT (AL-2)**

Operation will be as shown in the following diagram, regardless of the deviation (DV) at the start of AT execution. To shorten the AT execution time, select 100% AT.

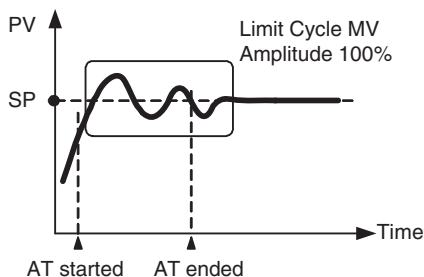

**Note** The Limit Cycle MV Amplitude parameter is disabled.

**Operating Procedure**

Adjustment Level

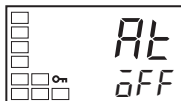
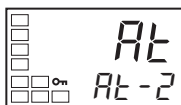

This procedure executes 100%AT.

1. Press the Key twice to move from the operation level to the adjustment level.  
Press the Key to select the AT Execute/Cancel parameter.
2. Press the Key to select AL-2. The No. 1 display for AT Execute/Cancel will flash during AT execution.
3. OFF will be displayed when AT ends.

Operation Level



4. To return to the operation level, press the  Key.

**Note** PID Constants

When control characteristics are already known, PID constants can be set directly to adjust control. PID constants are set in the Proportional Band (P), Integral Time (I), and Derivative Time (D) parameters, according to the Display PID Selection parameter setting in the PID setting level. Changing the Proportional Band (P), Integral Time (I), or Derivative Time (D) parameter settings in the adjustment level changes the settings in these parameters in the current PID set.

**3-8-2 RT (Robust Tuning)**

- When auto-tuning is executed with robust tuning selected, PID constants are automatically set that make it hard for control performance to degenerate even when the characteristics of the controlled object change.
- RT can be set in the advanced function setting level when PID control has been set.
- The RT mode cannot be selected while an analog input is set.
- Selecting the RT mode in the following cases will help to prevent hunting from occurring.
  - When the set temperature is not constant and is changed in a wide range.
  - When there are large variations in ambient temperatures due to factors such as seasonal changes or differences between day and night temperatures.
  - When there are large variations in ambient wind conditions and air flow.
  - When heater characteristics change depending on the temperature.
  - When an actuator with disproportional I/O, such as a phase-control-type power regulator, is used.
  - When a rapidly heating heater is used.
  - When the control object or sensor has much loss time.
  - When hunting occurs in normal mode for any reason.
- PID constants are initialized to the default settings by switching to RT mode.
- When the RT mode is selected, the derivative time setting unit becomes the second.

**RT Features**

- Even when hunting occurs for PID constants when auto-tuning is executed in normal mode, it is less likely to occur when auto-tuning is executed in RT Mode.

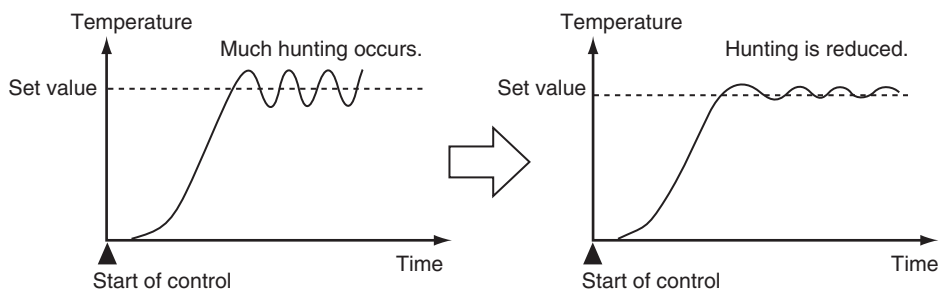

- When the temperature (PV) falls short of the set point for the PID constants when using auto-tuning in normal mode, executing auto-tuning in RT Mode tends to improve performance.

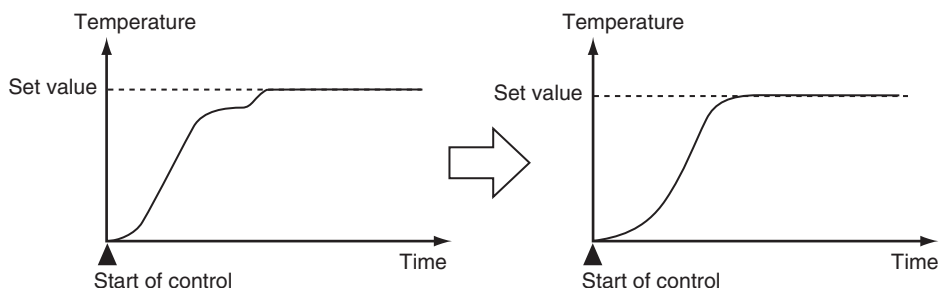

- When the manipulated variable (MV) is saturated, the amount of overshooting may be somewhat higher in comparison to PID control based on auto-tuning in normal mode.

**Operating Procedure**

This procedure selects RT mode.

Operation Level



1. Press the Key for at least three seconds to move from the operation level to the initial setting level.

Initial Setting Level

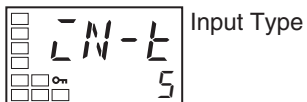

2. Select the Move to Advanced Function Setting Level parameter by pressing the Key.

Initial Setting Level



3. Use the Key to enter “-169” (the password).

Advanced Function Setting Level

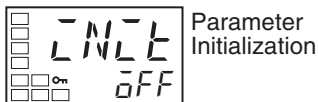

It is possible to move to the advanced function setting level by pressing the Key or leaving the setting for at least two seconds.

Advanced Function Setting Level

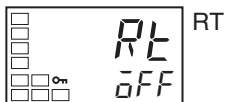

4. Press the Key to select RT.

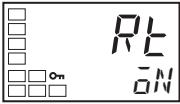

Initial Setting Level

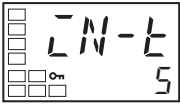

Input Type

Operation Level

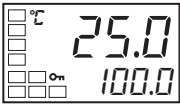

PV/SP

5. Press the Key to select  $\bar{a}N$ .  $\bar{a}FF$  is the default.

6. To return to the initial setting level, press the Key for at least one second.

7. To return to the operation level, press the Key for at least one second.

### 3-8-3 Manual Setup

PID constants can be manually and individually set in the Proportional Band (P), Integral Time (I), and Derivative Time (D) parameters, according to the Display PID Selection parameter set in the PID setting level. Changing the Proportional Band (P), Integral Time (I), or Derivative Time (D) parameter settings in the adjustment level changes the settings in the current PID set. For details on PID sets, refer to *PID Sets* on page 136.

#### Operating Procedure

In this example, the PID 2 Proportional Band parameter is set to 10.0, the PID 2 Integral Time parameter to 250, and the PID 2 Derivative Time parameter to 45.

PID Setting Level

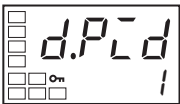

Display PID Selection

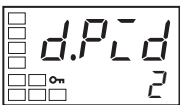

1. Press the Key to move from the operation level to the PID setting level.

2. Use the and Keys to set 2.

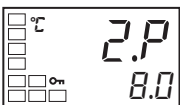

Proportional Band

3. Press the Key to select the PID 2 Proportional Band parameter.

4. Use the and Keys to set 10.0.

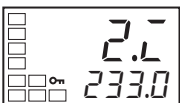

Integral Time

5. Press the Key to select the PID 2 Integral Time parameter.

6. Use the and Keys to set 250.0.

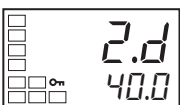
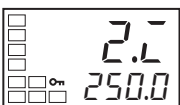

Derivative Time

7. Press the Key to select the PID 2 Derivative Time parameter.

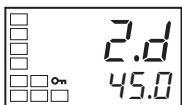

8. Use the and Keys to set 45.0.

9. To return to the operation level, press the Key.

**Note** Proportional Action  
 When PID constants I (integral time) and D (derivative time) are set to 0, control is executed according to proportional action. As the default, the center value of the proportional band becomes the set point.  
 Related parameter: Manual reset value (adjustment level)

■ **Changing P (Proportional Band)**

When P is increased		A slow rise and a longer rectification time will occur, but there will be no overshoot.
When P is decreased		Overshoot and hunting will occur, but the SP will be reached quickly and stabilize.

■ **Changing I (Integral Time)**

When P is increased		A longer time will be required to reach the SP. The rectification time will be longer, but there is less hunting, overshooting, and undershooting.
When P is decreased		Overshooting and undershooting will occur. Hunting will occur. A quick rise will occur.

■ **Changing D (Derivative Time)**

When P is increased		Less rectification time for overshooting and undershooting, but fine hunting will occur spontaneously.
When P is decreased		Overshooting and undershooting will be larger and more time will be required to return to the SP.



### 3-9 Alarm Outputs

- Alarms can be used with the E5CN-HT□2□□□ (two auxiliary outputs) or E5AN/EN-HT□2□□□ (two auxiliary outputs). Also, alarms 1 to 3 can be assigned to outputs using the Control Output 1/2 Assignment parameters to use alarms with models that have the following type of control outputs: relay outputs, voltage outputs (for driving SSR). Alarm outputs are determined by a combination of the following alarm output conditions: Alarm Type, Alarm Value, Alarm Hysteresis, and Standby Sequence.
- Alarm outputs are determined by a combination of Alarm Type, Alarm Value, and Alarm Hysteresis alarm output conditions. For details, refer to 4-2-1 Alarm Hysteresis (alh1 to alh3).

- This section describes the Alarm Type, Alarm Value, Upper-limit Alarm and Lower-limit Alarm parameters.

### 3-9-1 Alarm Types

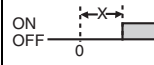
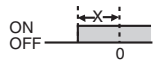
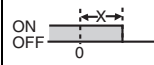
Set value	Alarm type	Alarm output operation		Function
		When alarm value X is positive	When alarm value X is negative	
0	Alarm function OFF	Output OFF		No alarm function.
1	Upper- and lower-limit (See note 1.)		See note 2.	The positive deviation in the SP is set using the alarm upper limit (H) and the negative deviation is set using the alarm lower limit (L). The alarm is ON when the PV is outside this deviation range.
2	Upper-limit			The alarm value (X) is set as a positive deviation in the SP. The alarm is ON when the PV is higher than the SP by the deviation or more.
3	Lower-limit			The alarm value (X) is set as a negative deviation in the SP. The alarm is ON when the PV is lower than the SP by the deviation or more.
4	Upper- and lower-limit range (See note 1.)		See note 3.	The positive deviation in the SP is set using the alarm upper limit (H) and the negative deviation is set using the alarm lower limit (L). The alarm is ON when the PV is inside this deviation range.
5	Upper- and lower-limit with standby sequence (See note 1.)		See note 4.	This alarm type adds a standby sequence to alarm type 1 (upper- and lower-limit alarm). (See note 7.)
6	Upper-limit with standby sequence			This alarm type adds a standby sequence to alarm type 2 (upper-limit alarm). (See note 7.)
7	Lower-limit with standby sequence			This alarm type adds a standby sequence to alarm type 3 (lower-limit alarm). (See note 7.)
8	Absolute-value upper-limit			This alarm type turns ON the alarm when the PV is higher than the alarm value (X), regardless of the value of the SP.
9	Absolute-value lower-limit			This alarm type turns ON the alarm when the PV is lower than the alarm value (X), regardless of the value of the SP.
10	Absolute-value upper-limit with standby sequence			This alarm type adds a standby sequence to alarm type 8 (absolute-value upper-limit alarm). (See note 7.)
11	Absolute-value lower-limit with standby sequence			This alarm type adds a standby sequence to alarm type 9 (absolute-value lower-limit alarm). (See note 7.)
12	LBA (alarm 1 type only)	---		(See note 8.)
13	PV change rate alarm	---		(See note 9.)

Set value	Alarm type	Alarm output operation		Function
		When alarm value X is positive	When alarm value X is negative	
14	Remote SP absolute value upper limit (See note 6.)			This alarm type turns ON the alarm when the remote SP (RSP) is higher than the alarm value (X). It also functions in Program SP Mode, Fixed SP Mode, and Remote SP Mode.
15	Remote SP absolute value lower limit (See note 6.)			This alarm type turns ON the alarm when the remote SP (RSP) is lower than the alarm value (X). It also functions in Program SP Mode, Fixed SP Mode, and Remote SP Mode.

**Note**

(1) With set values 1, 4, and 5, the upper- and lower-limit values can be set independently for each alarm type, and are expressed as “L” and “H.”

(2) Set value: 1 (Upper- and lower-limit alarm)

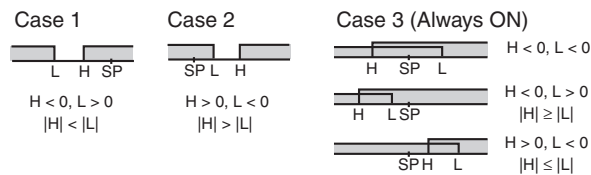

(3) Set value: 4 (Lower limit range)

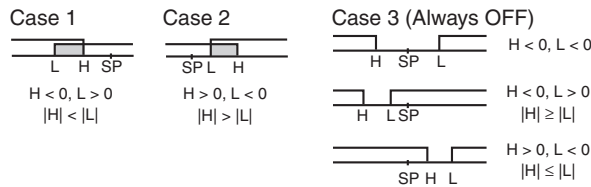

(4) Set value: 5 (Upper- and lower-limit with standby sequence)

- For the lower-limit alarms in cases 1 and 2 above, the alarm is always OFF if upper- and lower-limit hysteresis overlaps.
- In case 3, the alarm is always OFF.

(5) Set value: 5 (Upper- and lower-limit with standby sequence)

- The alarm is always OFF if upper- and lower-limit hysteresis overlaps.

(6) Displayed when remote SP input is used.

(7) For information on how standby sequences operate, refer to 4-2-2 Standby Sequence.

(8) Refer to 4-11-1 Loop Burnout Alarm (LBA).

(9) Refer to PV Change Rate Alarm on page 75.

- Set the alarm type independently for each alarm in the Alarm 1 to 3 Type parameters in the initial setting level. The default is 2 (Upper-limit alarm).
- When the Reset Operation parameter is set to stop control and operation being reset in Program SP Mode or operation is on standby, the applicable SP for a deviation alarm (alarm type 1 to 7) is the SP for segment 0.
- With rate of rise programming, if the Reset Operation parameter is set to stop control and the Segment Type parameter of segment 0 is set to Soak, the applicable SP for a deviation alarm (alarm type 1 to 7) is the PV.

### 3-9-2 Alarm Values

 Alarm Lower Limit

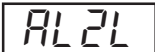



 Alarm Upper Limit

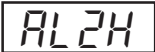



 Alarm Value

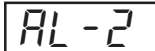

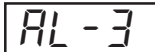

- Alarm values are indicated by “X” in the table on the previous page. When the upper and lower limits are set independently, “H” is displayed for upper limit values, and “L” is displayed for lower limit values.
- To set the alarm upper and lower limits for deviation, set the upper and lower limits in the Alarm 1 to 3 Upper Limit and Alarm 1 to 3 Lower Limit parameters.
- Alarm values can be set for each program. Select the program number in the Display Program Selection parameter in the program setting level, and set the Alarm Value, Alarm Value Upper Limit (1 to 3), and Alarm Value Lower Limit (1 to 3) parameters for that program.
- For the E5AN-HT or E5EN-HT, the current program number is displayed on the No. 3 display.

#### Operating Procedure

This procedure sets alarm 1 for program 1 as an upper-limit alarm.

The related parameters and settings are shown below. The alarm is output when the set point exceeds 10°C. (In this example, the temperature unit is °C.)

Alarm 1 type = 2 (Upper-limit alarm)

Alarm value 1 = 10

Initial Setting Level

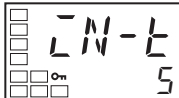
 Input Type

 Alarm 1 Type





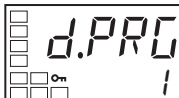

Operation Level

 PV/SP

Program Setting Level

 Display Program Selection



1. Press the  Key for at least three seconds to move from the operation level to the initial setting level.
2. Select the Alarm 1 Type parameter by pressing the  Key. Confirm that the set value is 2. The default value is 2 (Upper-limit alarm).
3. To return to the operation level, press the  Key for at least one second.
4. Press the  Key to move to the program setting level.
5. Use the  and  Keys to set 1.



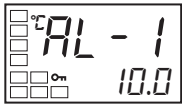

6. Press the Key to select the Alarm Value 1 parameter.

7. Use the Key to set 10.0.

**PV Change Rate Alarm**

The change width can be found for PV input values in any set period. Differences with previous values in each set period are calculated, and an alarm is output if the result exceeds the alarm value. The PV rate of change calculation period can be set in units of 60 ms.

If a positive value is set for the alarm value, the PV will operate as a change rate alarm in the rising direction. If a negative value is set, the PV will operate as a change rate alarm in the falling direction.

**Precaution**

If a shorter PV rate of change calculation period is set, outputs set for the PV change rate alarm function may repeatedly turn ON and OFF for a short period of time. It is therefore recommended that the PV change rate alarm be used with the alarm latch turned ON.

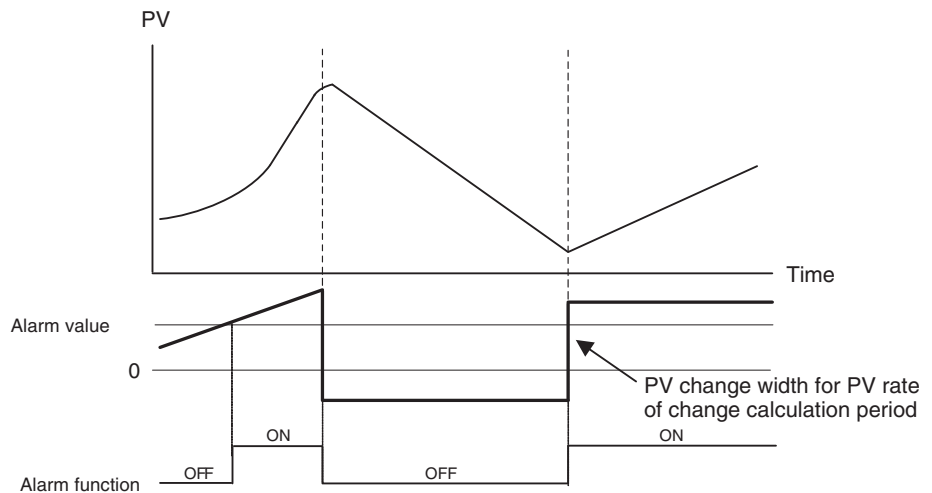

Parameter name	Setting range	Unit	Default
PV Rate of Change Calculation Period (PV <sub>RP</sub> )	1 to 999	Sampling cycle	17 (= 17 × 60 ms = 1,020 ms)

**SP Alarms When Remote SP Is Used**

RSP Absolute Upper Limit and RSP Absolute Lower Limit parameters were added for the E5AN-HT and E5EN-HT (with remote SP input). These parameters are used for the remote SP regardless of whether the SP mode is set to Program SP Mode, Fixed SP Mode, or Remote SP Mode.

## 3-10 Using Heater Burnout, Heater Short, and Heater Overcurrent Alarms

### 3-10-1 Heater Burnout, Heater Short, and Heater Overcurrent Alarm Operations

- Heater burnout detection and heater overcurrent detection are executed by measuring heater current while the control output (heating) is ON, and heater short detection is executed by measuring heater current while it is OFF. For details, refer to the following table. (Heater burnout detection, heater short detection, and heater overcurrent detection cannot be used with the control output for cooling.)
- These settings can be made for standard models only.

Control output (heating) status		Power to heater	HB alarm output	HS alarm output	Heater overcurrent alarm output
Control output (heating)	Operation indicator				
ON	Lit	Yes (Normal) (See note 1.)	OFF	---	---
		No (Heater burnout)	ON	---	---
OFF	Not lit	Yes (HS alarm)	---	ON	---
		No (Normal) (See note 2.)	---	OFF	---
ON	Lit	Normal	---	---	OFF
		Heater overcurrent status (See note 3.)	---	---	ON

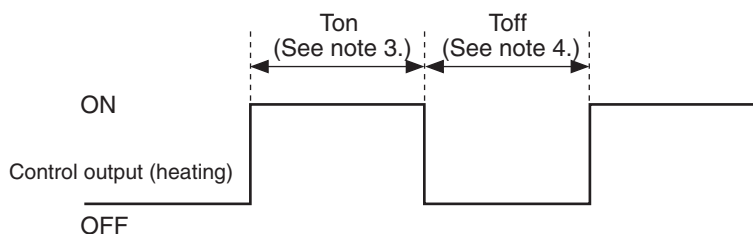

#### Note

- (1) In the above diagram, power is considered to be ON (normal) if the heater current is greater than the heater burnout detection current during the  $T_{on}$  interval. If the heater is burned out, the measured current decreases and falls below the heater burnout detection value. The output is then activated as the heater burnout alarm.
- (2) In the above diagram, power is considered to be OFF (normal) if the leakage current is less than the HS alarm current during the  $T_{off}$  interval. If the SSR output is short-circuited, the measured current increases beyond the HS alarm value. The output is then activated as the HS alarm.
- (3) In the above diagram, it is regarded as normal when the heater current is less than the heater overcurrent detection current during the  $T_{on}$  period. Current is increased when excessive current flows to the heater, causing the heater overcurrent detection value to be exceeded and an OC (heater overcurrent) alarm to be output.
- (4) Heater burnout and heater overcurrent are not detected if the control output (heating) ON time ( $T_{on}$ ) is 100 ms or less.
- (5) HS alarms are not detected if the control output (heating) OFF time ( $T_{off}$ ) is 100 ms or less.

- For Controllers with heater burnout, HS, and heater overcurrent alarms, an OR output is established between the ALM 1 function and the alarms. If the ALM1 function is to be used for the heater burnout, HS, and heater overcurrent alarms only, set 0 as the alarm 1 type (i.e., do not use ALM1).
- Turn the heater power ON simultaneously or before turning ON the E5□N-HT power. If the heater power is turned ON after turning ON the E5AN-HT power, the HB alarm will be activated.
- Control is continued even when the heater burnout, HS, or heater overcurrent alarm is active.
- The rated current value may sometimes differ slightly from the actual current flowing to the heater. Use the Heater Current 1 Value Monitor, Heater Current 2 Value Monitor, Leakage Current 1 Monitor, and Leakage Current 2 Monitor parameters to check the actual current being used.
- If there is little difference between the current in normal and abnormal states, detection may become unstable. To stabilize detection, set a current value difference of at least 1.0 A for heaters of less than 10.0 A, and at least 2.5 A for heaters of 10.0 A or more. If the heater current is too low, loop the load line several times through a CT, as shown in the diagram below. Looping it through once will double the detection current.

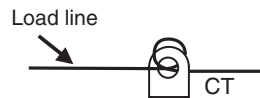

### 3-10-2 Installing Current Transformers (CT)

- This function can be used with E5□N-HT models that have the HB alarm, HS alarm, and OC alarm. For the E5CN-HT, connect the CT in advance to terminals 14 and 15 (CT1), or 13 and 15 (CT2). For the E5AN-HT/EN-HT, connect the CT in advance to terminals 14 and 15 (CT1) or 15 and 16 (CT2). Then pass the heater power line through the CT's hole. For specifications, models and dimensions of current transformers that can be used with this Controller, see *Appendix Current Transformer (CT)* on page 314.

#### Single-phase Heaters

For single-phase heaters, install the CT in the position shown in the following diagram.

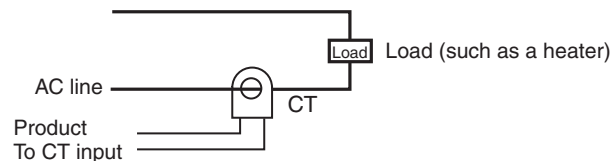

#### Three-phase Heaters (E5□N-HT□□HH□ 3- phase Heater Detection Models)

When a 3-phase power supply is used, regardless of the types of connecting lines, two current transformers (CTs) are required to detect heater burnout, HS, and OC.

- **Delta connecting lines: Refer to the following diagram for CT installation positions.**

**Note** Heater voltage fluctuations are not considered here, so be take that into account when setting the detection current.

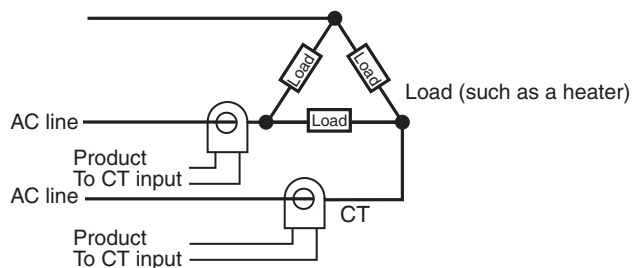

■ **Star connecting lines: Refer to the following diagram for CT installation positions.**

**Note** Heater voltage fluctuations are not considered here, so be take that into account when setting the detection current.

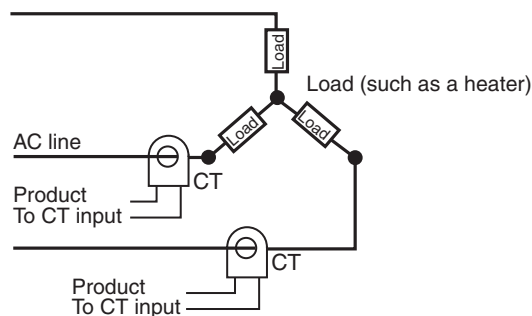

■ **V connecting lines: Refer to the following diagram for CT installation positions.**

**Note** Heater voltage fluctuations are not considered here, so be take that into account when setting the detection current.

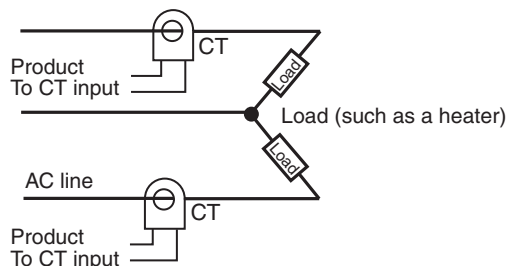

### 3-10-3 Calculating Detection Current Values

- Calculate the set value using the following equation:

$$\text{Heater Burnout Detection 1/2 set value} = \frac{\text{Normal current value} + \text{Burnout current value}}{2}$$

$$\text{HS Alarm 1/2 set value} = \frac{\text{Leakage current value (output OFF)} + \text{HS current value}}{2}$$

$$\text{Heater overcurrent 1/2 set value} = \frac{\text{Normal current value} + \text{Overcurrent value}}{2}$$

- To set the current for heater burnout when two or more heaters are connected through the CT, use the value from when the heater with the smallest current burns out. If all of the heaters have the same current, use the value from when any one of them burns out.

- Make sure that the following conditions are satisfied:  
 Heater with a current of less than 10.0 A:  
 (Current value at normal operation) – (Current value at heater burnout) ≥ 1 A  
 When the difference is less than 1 A, detection is unstable.  
 Heater with a current of 10.0 A or more:  
 (Current value at normal operation) – (Current value at heater burnout) ≥ 2.5 A  
 When the difference is less than 2.5 A, detection is unstable.
- The setting range is 0.1 to 49.9 A. Heater burnout, HS, and heater overcurrent are not detected when the set value is 0.0 or 50.0. When the set value is 0.0, the heater burnout alarm is always OFF, the HS alarm is always ON, and the heater overcurrent alarm is always ON. When the set value is 50.0, the heater burnout alarm is always ON, the HS alarm is always OFF, and the heater overcurrent alarm is always OFF.
- Set the total current value for normal heater operation to 50 A or less. When a current value of 55.0 A is exceeded, FFFF is displayed in the Heater Current 1 (or 2) Value Monitor and Leakage Current 1 (or 2) Monitor parameters.

### 3-10-4 Application Examples

#### Single-phase Heaters

Example: Using a 200-VAC, 1-kW Heater

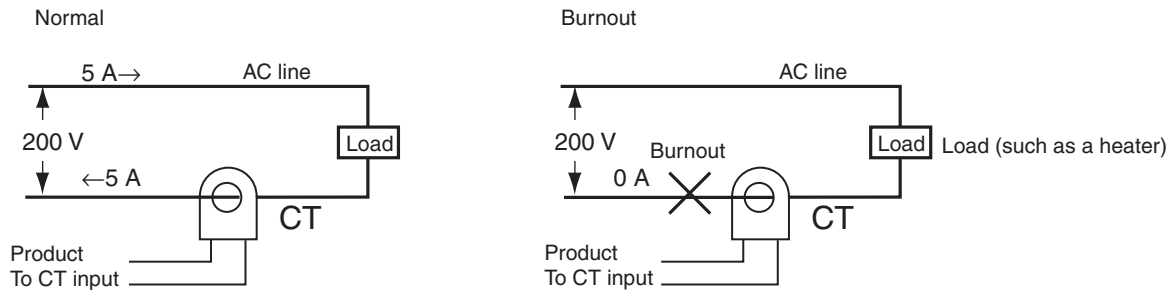

The heater power supply provides 5 A when the current is normal, and 0 A when there is a burnout, so the heater burnout detection current is calculated as follows:

$$\begin{aligned} \text{Heater burnout detection current} &= \frac{(\text{Normal current}) + (\text{Heater burnout current})}{2} \\ &= \frac{5 + 0}{2} = 2.5 \text{ [A]} \end{aligned}$$

Example: Using Three 200-VAC, 1-kW Heaters

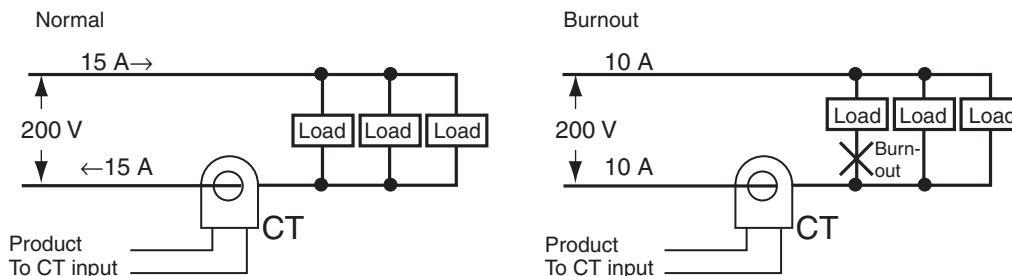

The heater power supply provides 15 A when the current is normal, and 10 A when there is a burnout, so the heater burnout detection current is calculated as follows:

$$\text{Heater burnout detection current} = \frac{(\text{Normal current}) + (\text{Heater burnout current})}{2}$$

$$= \frac{15 + 10}{2} = 12.5 \text{ [A]}$$

**Three-phase Heaters**

**Delta Connecting Lines**

Example: Using Three 200-VAC, 2-kW Heaters

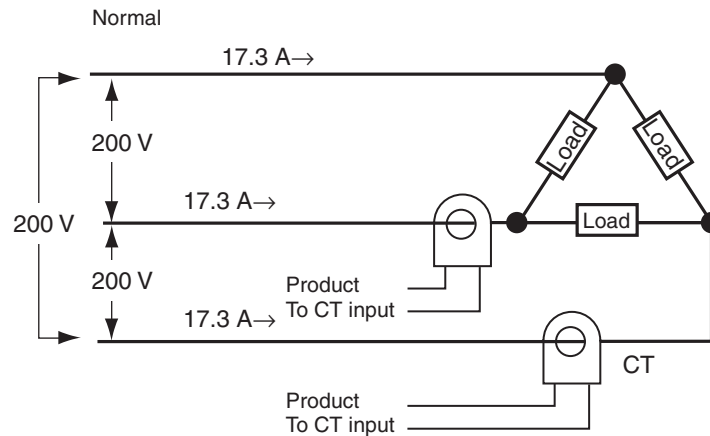

The current when each phase is normal is 17.3 A ( $\approx \sqrt{3} \times 10 \text{ A}$ ).

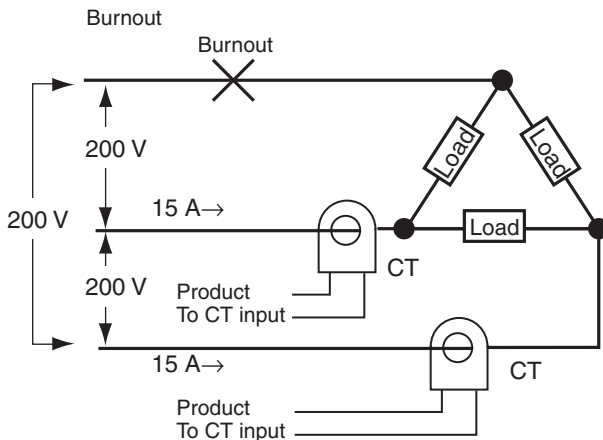

Current when there is a burnout =  $10 \text{ A} \times \sqrt{3} \times (\sqrt{3}/2) = 15 \text{ A}$

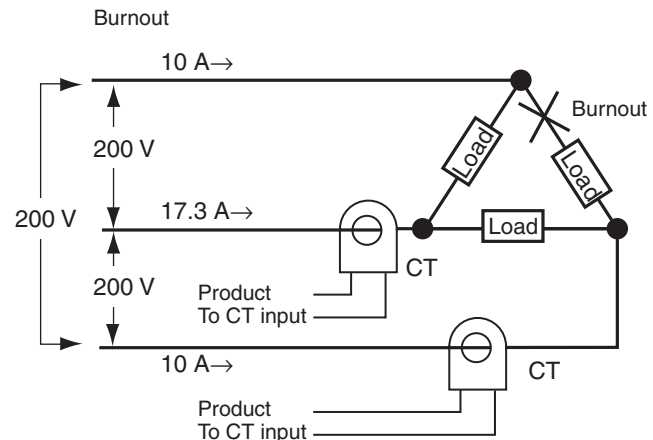

Current when there is a burnout =  $10 \text{ A} \times \sqrt{3} \times (1/\sqrt{3}) = 10 \text{ A}$

The heater burnout current when there is a burnout at the load line is as follows:

$$(\text{Heater burnout detection current}) = (17.3 + 15) / 2 \approx 16.1 \text{ [A]}$$

The heater burnout current when there is a burnout at the load is as follows:

$$(\text{Heater burnout detection current}) = (17.3 + 10) / 2 \approx 13.65 \text{ [A]}$$

To enable detection in either case, use 16.1 A as the heater burnout detection current.

**Star Connecting Lines**

Example: Using Three 200-VAC, 2-kW Heaters

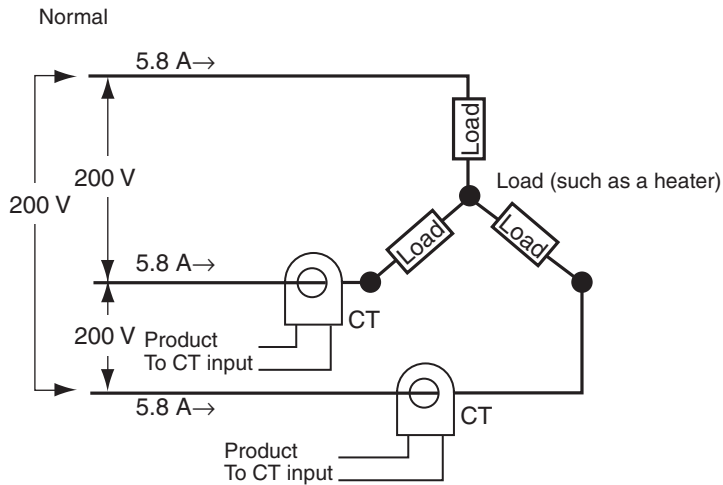

The current when each phase is normal is  $5.8 \text{ A} (\approx 10 \text{ A} \times (1/\sqrt{3}))$ .

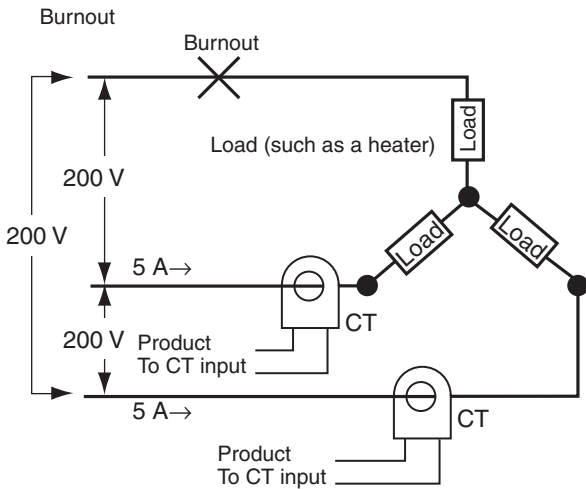

$$\text{Current when there is a burnout} = 10 \text{ A} \times (1/\sqrt{3}) \times (\sqrt{3}/2) = 5 \text{ A}$$

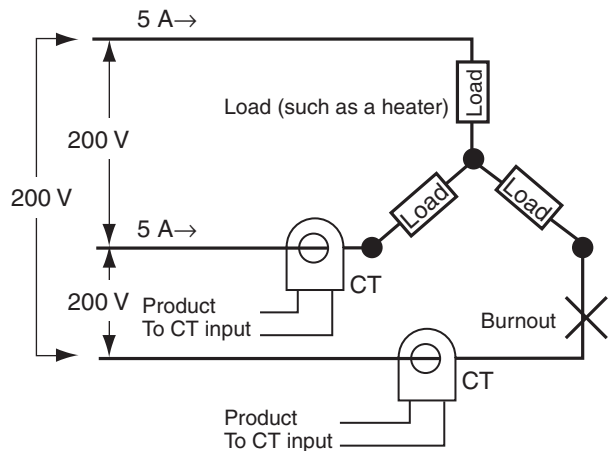

$$\text{Current when there is a burnout} = 10 \text{ A} \times (1/\sqrt{3}) \times (\sqrt{3}/2) = 5 \text{ A}$$

The heater burnout detection current for this connecting line is  $5.4 \text{ A} (= (5.8 + 5) / 2)$ .

**V Connecting Lines**

Example: Using Two 200-VAC, 2-kW Heaters

Normal

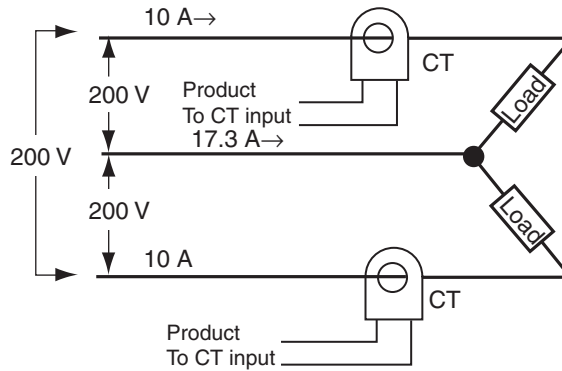

Burnout

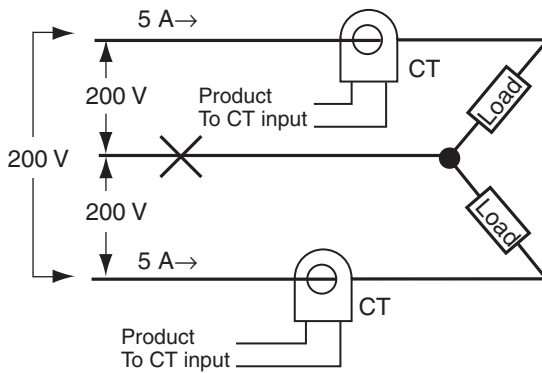

Current when there is a burnout =  $10\text{ A} \times (1/2)$   
= 5 A

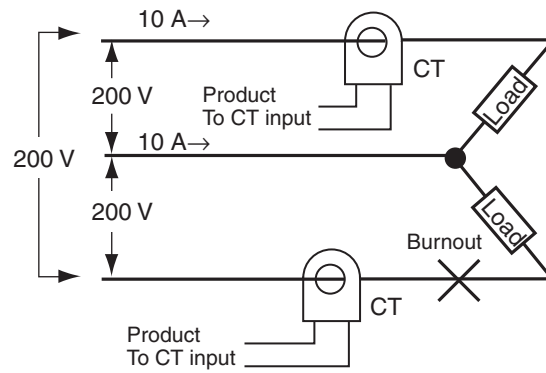

Current when there is a burnout = 0 A

The heater burnout current when there is a burnout at the common is as follows:

$$\text{Heater burnout detection current} = (10 + 5) / 2 \approx 7.5 \text{ [A]}$$

The heater burnout current when there is a burnout at the load is as follows:

$$\text{Heater burnout detection current} = (10 + 0) / 2 \approx 5 \text{ [A]}$$

To enable detection in either case, use 7.5 A as the heater burnout detection current.



### 3-10-5 Settings: HB Alarm



To activate the heater burnout alarm, set the HB ON/OFF parameter to ON in the advanced function setting level and set the Heater Burnout Detection 1 and Heater Burnout Detection 2 parameters in the adjustment level.

#### Operating Procedure

This procedure sets the Heater Burnout Detection 1 parameter to 2.5.

#### ■ Moving to the Advanced Function Setting Level

The Heater Burnout Detection parameter setting is already ON by default, so set the Heater Burnout Detection 1 parameter.

1. Move to the advanced function setting level.  
Press the  Key for at least three seconds to move from the operation level to the initial setting level.
2. Select Move to Advanced Function Setting Level by pressing the  Key. (For details on moving between levels, refer to 4-7 *Moving to the Advanced Function Setting Level*.)
3. Press the  Key to enter the password (-169), and move from the initial setting level to the advanced function setting level.

Operation Level



Initial Setting Level

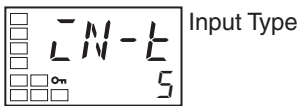

Initial Setting Level



Advanced Function Setting Level

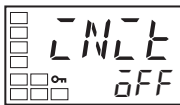





The top parameter in the advanced function setting level is displayed.



4. Select the Heater Burnout Detection parameter by pressing the  Key. Check that this parameter is set to ON (the default). Next, set the Heater Burnout Detection 1 parameter.

#### ■ Setting Heater Burnout Detection

5. Press the  Key for at least one second to move from the advanced function setting level to the initial setting level. Press the  key again for at least one second to move to the operation level.
6. Press the  Key twice for less than one second to move from the operation level to the adjustment level.
7. Select the Heater Current 1 Value Monitor parameter by pressing the  Key. Check the current value. Next, set the Heater Burnout Detection 1 parameter.
8. Select the Heater Burnout Detection 1 parameter by pressing the  Key. Refer to *Calculating Detection Current Values* on page 78 on when making the settings.

Operation Level



Adjustment Level



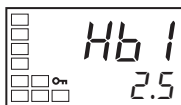

- For this example, set 2.5. To return to the operation level, press the Key twice.

### 3-10-6 Settings: Heater Short Alarm

To activate the HS alarm, set the HS Alarm Use parameter to ON in the advanced function setting level and set the HS Alarm 1 and HS Alarm 2 parameters in the adjustment level.

#### Operating Procedure

This procedure sets the HS Alarm 1 parameter to 2.5.

#### ■ Moving to the Advanced Function Setting Level

The HS Alarm Use parameter setting is already ON by default, so set the HS Alarm 1 parameter.

Operation Level



- Move to the advanced function setting level. Press the Key for at least three seconds to move from the operation level to the initial setting level.

Initial Setting Level

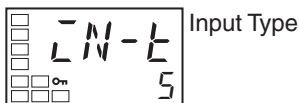

- Select Move to Advanced Function Setting Level by pressing the Key. (For details on moving between levels, refer to 4-7 Moving to the Advanced Function Setting Level.)

Initial Setting Level

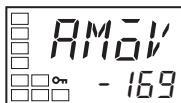

- Press the Key to enter the password (-169), and move from the initial setting level to the advanced function setting level.

Advanced Function Setting Level

The top parameter in the advanced function setting level is displayed.

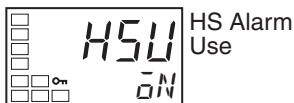

- Select the HS Alarm Use parameter by pressing the Key. Check that this parameter is set to ON (the default). Next, set the HS Alarm 1 parameter.

■ HS Alarm Settings

Operation Level



5. Press the Key for at least one second to move from the advanced function setting level to the initial setting level. Press the key again for at least one second to move to the operation level.

Adjustment Level



6. Press the Key twice for less than one second to move from the operation level to the adjustment level.



7. Select the Leakage Current 1 Monitor parameter by pressing the Key. Check the current value. Next, set the HS Alarm 1 parameter.

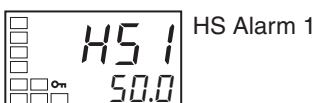

8. Select the HS Alarm 1 parameter by pressing the Key. Refer to *Calculating Detection Current Values* on page 78 when setting the values.



9. For this example, set 2.5. To return to the operation level, press the Key twice.

3-10-7 Settings: Heater Overcurrent Alarm

To activate heater overcurrent alarm, set the Heater Overcurrent Use parameter to ON in the advanced function setting level and set the Heater Overcurrent Detection 1 and Heater Overcurrent Detection 2 parameters in the adjustment level.

Operating Procedure

This procedure sets the Heater Overcurrent Detection 1 parameter to 20.0.

■ Moving to the Advanced Function Setting Level

The default setting for the Heater Overcurrent Use parameter is ON, so set the Heater Overcurrent Detection 1 parameter.

Operation Level



1. Move to the advanced function setting level. Press the Key for at least three seconds to move from the operation level to the initial setting level.

Initial Setting Level

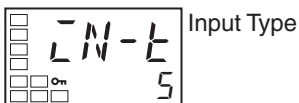

2. Press the Key to select the Move to Advanced Function Setting Level parameter. (For details on moving between levels, refer to 4-7.)

Initial Setting Level

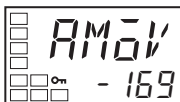

3. Press the Key to enter the password (-169), and move from the initial setting level to the advanced function setting level.

Advanced Function Setting Level

The top parameter in the advanced function setting level is displayed.



4. Press the Key to select the Heater Overcurrent Use parameter. Check that this parameter is set to ON (the default), and then set the Heater Overcurrent Detection 1 parameter.

■ Setting Heater Overcurrent Detection

Operation Level



5. Press the Key for at least one second to move from the advanced function setting level to the initial setting level. Press the key again for at least one second to move to the operation level.

Adjustment Level



6. Press the Key twice for less than one second to move from the operation level to the adjustment level.



7. Press the Key to select the Heater Current 1 Value Monitor parameter. Check the current value, and then set the Heater Overcurrent Detection parameter.



8. Press the Key to select the Heater Overcurrent Detection 1 parameter. Refer to *Calculating Detection Current Values* on page 78 when setting the values.



9. For this example, set 20.0. To return to the operation level, press the Key twice.

### 3-11 Setting the No. 3 Display

This section describes how to set the No. 3 Display (E5AN-HT/E5EN-HT only) when the PV and SP are displayed. The program number and segment number, or the MV can be displayed on the No. 3 display.

#### 3-11-1 PV/SP Display Selection (*SPdP*)

The following table shows the set values and display contents for the PV/SP Display selection.

Set value	Display contents
0	Only PV/SP is displayed (with no No. 3 display.)
1	The PV, SP, Program No., and Segment No., and the PV, SP, and MV (see note 2.) are displayed in order.
2	The PV, SP, MV (see note 2.) and the PV, SP, Program No., and Segment No. are displayed in order.
3	Only the PV, SP, Program No., and Segment No. are displayed.
4	Only PV/SP/MV is displayed. (See note 2.)
5	The PV, SP, Program No., and Segment No., and the PV, SP, and Remaining Segment Time are displayed in order.
6	The PV, SP, MV (see note 2.), and the PV, SP, and Remaining Segment Time are displayed in order.
7	Only the PV, SP, and Remaining Segment Time are displayed.

**Note**

- (1) The default setting is 3.
- (2) For details on setting the MV for heating and cooling control, refer to *MV Display for Heating and Cooling Control* below. The MV for position-proportional models becomes the value for opening the valve.

When 1, 2, 5, or 6 is selected, press the  Key to display the next value set for the PV/SP display (display 2).

Example: When the PV/SP Display Screen Parameter Is Set to 2

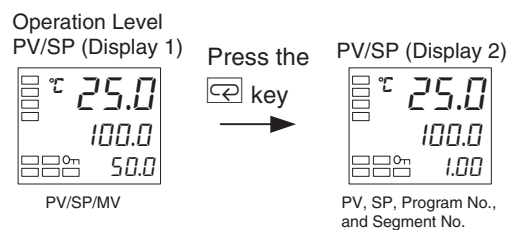

#### MV Display for Heating and Cooling Control

Select either the manipulated variable (heating) or manipulated variable (cooling) as the MV to be displayed for PV/SP/MV during heating and cooling control. This parameter is displayed only when heating/cooling control is being performed and PV/SP/MV is selected in the PV/SP Display Screen parameter or a Monitor/Setting Item Display parameter. This setting can be made for standard models only.

Parameter name	Set value	Symbol	Display contents
MV Display Selection	0	$\bar{a}$	Manipulated variable (heating)
	C-0	$\bar{c} - \bar{a}$	Manipulated variable (cooling)

**Operating Procedure**

This procedure displays the PV, SP, and MV and the PV, SP, program number, and segment number when the PV and SP are displayed. The PV/SP Display Screen Selection parameter is set to 2.

Operation Level

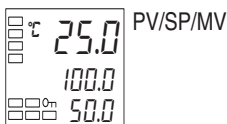

1. Press the Key for at least three seconds to move from the operation level to the initial setting level.

Initial Setting Level

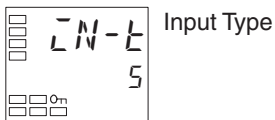

2. Press the Key to select the Move to Advanced Function Setting Level parameter.

Initial Setting Level

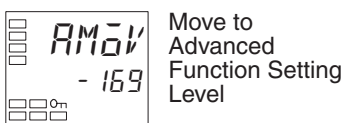

3. Use the Key to enter the password (“-169”). It is possible to move to the advanced function setting level by either pressing the Key or waiting two seconds without pressing any key.

Advanced Function Setting Level

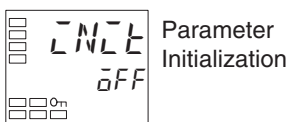

4. Press the Key to select the PV/SP Display Screen Selection parameter.

Advanced Function Setting Level

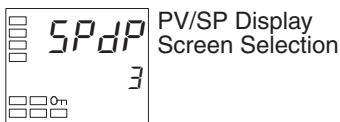

5. Use the and Keys to set 2.

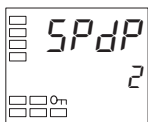

6. Press the Key for at least one second to move from the advanced function setting level to the initial setting level.

Initial Setting Level

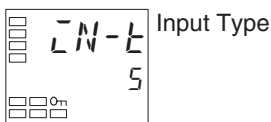

7. Press the Key for at least one second to move from the initial setting level to the operation level. The MV will be displayed on the No. 3 display.

Operation Level

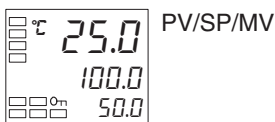

8. Press the Key to confirm that the program number and segment number are displayed on the No. 3 display.

Operation Level

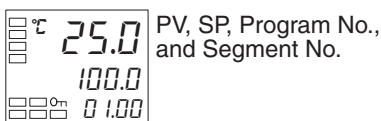

### 3-12 Starting and Stopping Operation (RTSM)

To start program operation, set the Run/Reset parameter to Run. To stop program operation, set the Run/Reset parameter to Reset. Program execution will stop while the Hold parameter is set to ON. The program number can be changed only in reset status. When a program is in reset status, the segment number will be 0, the elapsed program time will be 0, hold status will be cleared, the program repetition counter will be 0, the program number will be the selected program number, and auto-tuning will be canceled.

#### Reset Operation

The operation status when the Run/Reset parameter is set to Reset can be selected. Either of the two operations outlined below can be selected by using the Reset Operation parameter.

■ **Reset Operation = Stop Control**

When the Run/Reset parameter is changed to Reset, the program will be reset and operation will stop. To keep a control output active during reset status, set a MV in the MV at Reset parameter.

■ **Reset Operation = Fixed SP Operation**

The following diagram shows the status transitions when the Reset Operation parameter is set to Fixed SP Operation.

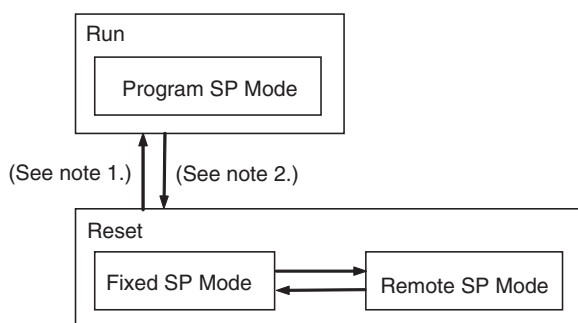

- Note**
- (1) When the Run/Reset parameter is changed to Run, operation will go to Program SP Mode regardless of the setting of the SP Mode parameter, and operation will start in Fixed SP or Remote SP Mode.
  - (2) When the Run/Reset parameter is changed to Reset, operation will go to Fixed SP or Remote SP Mode, and control will be performed for a fixed or remote SP. Operation will not stop.

If the Reset Operation parameter is set to Fixed SP Control, the segment 0 will be a ramp segment. The following table shows example settings.

Segment No.	0	1	2
Segment SP	100.0	100.0	50.0
Segment Time (h.min)	0.20	0.40	0.20

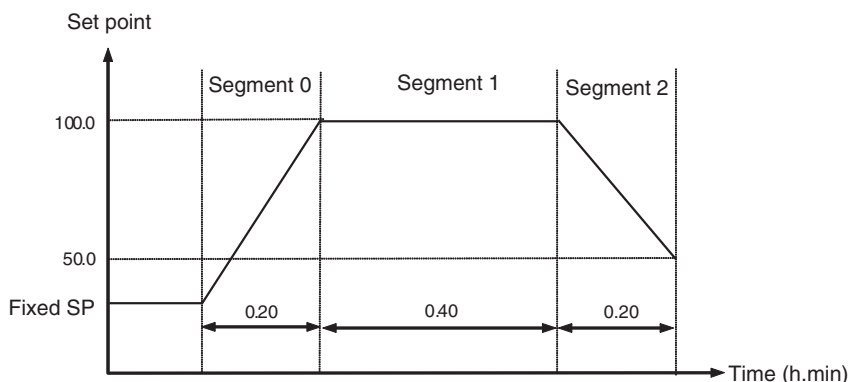

**Startup Operation**  
(P-āN)

- This parameter determines the operating status when the power is turned ON. You can select any of the following four settings. The specified startup operation is also used for software resets and when moving from initial setting level to operation level.

Set value	Operation
Continue	The status of the system before the power was interrupted (including moving to setup area 1) is resumed.
Reset	Control is always in reset status when the power is turned ON.
Run	The program (including any standby status) is always executed from the beginning when the power is turned ON.
Manual operation	Manual operation is used when the power is turned ON. (This setting cannot be selected when manual operation is disabled.)

- The following table shows what values are held depending on the Startup Operation parameter setting.

	Continue	Reset	Run	Manual
Program No.	Yes	Yes	Yes	Yes
Segment No.	Yes	---	---	Yes
Elapsed Program Time	Yes	---	---	Yes
Remaining Standby Time	Yes	---	---	Yes
			(See note 2.)	
Program Repetitions	Yes	---	---	Yes
Hold	Yes	---	---	Yes
Auto/Manual	Yes	Yes	Yes	---
Manual MV (See note 1.)	Yes	Yes	Yes	Yes (See note 3.)
Run/Reset	Yes	---	---	Yes

- Note**
- (1) For position-proportional models, the Direct Setting of Position-Proportional MV parameter must not be set to OFF. Applies only to the E5AN-HT or E5EN-HT.
  - (2) The Remaining Standby Time becomes the Standby Time.
  - (3) If power is interrupted in Auto Mode and the Reset Operation parameter is set to stop control, the MV will be output while the program is in reset status. If the Reset Operation parameter is set for fixed SP operation, the MV will be 0 (or OFF).



### 3-13 Adjusting Programs

The temperature vector will change if the program is changed during operation when the Step Time/Rate of Rise Programming parameter is set to Step Time. The following sections show how the temperature vector will be changed.

#### 3-13-1 Changing the SP

If the SP is changed during a segment, the present SP will move in a straight line with the changed SP as the target point.

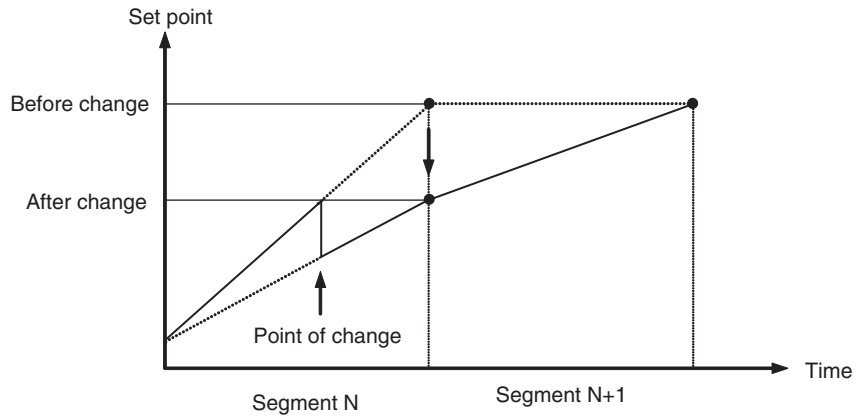

#### 3-13-2 Changing the Time

If the time is changed during a segment, the slope of the line along which the present SP moves will change because the time taken to reach the target will change.

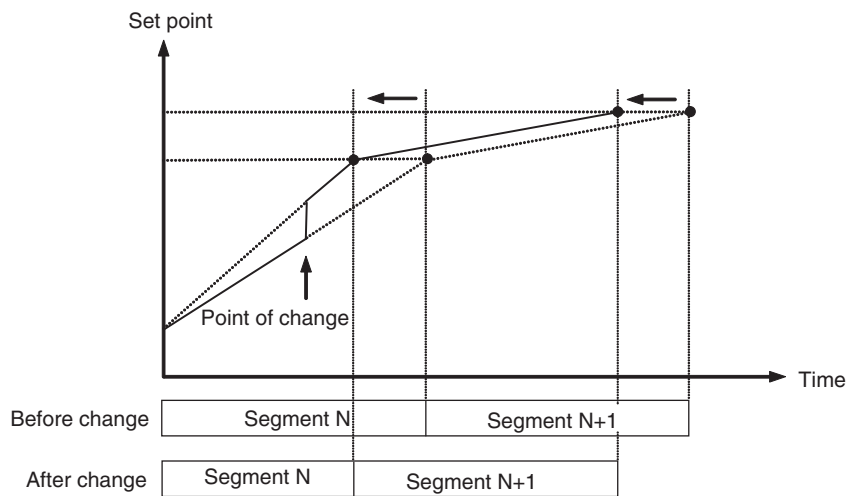

If the segment time after the change is shorter than the elapsed segment time, the program will immediately move to the next segment.



# SECTION 4

## Applications Operations

This section describes scaling, program-related functions, and other special functions that can be used to make the most of the functionality of the E5CN-H, E5AN-H, and E5EN-H Digital Controllers.

4-1	Shifting Input Values . . . . .	95
4-1-1	Shifting Inputs . . . . .	95
4-1-2	How to Calculate Input Shift Values for a 2-point Shift. . . . .	96
4-2	Adjusting Alarms . . . . .	98
4-2-1	Alarm Hysteresis (alh1 to alh3) . . . . .	98
4-2-2	Standby Sequence . . . . .	99
4-2-3	Alarm Latch (a1lt to a3lt) . . . . .	99
4-2-4	Close in Alarm/Open in Alarm (sb1n to sb3n) . . . . .	99
4-2-5	Alarm SP Function (alsp) . . . . .	99
4-3	Setting Scaling Upper and Lower Limits for Analog Inputs . . . . .	100
4-3-1	Analog Input . . . . .	100
4-4	Executing Heating/Cooling Control . . . . .	101
4-4-1	Heating/Cooling Control . . . . .	101
4-4-2	Settings . . . . .	103
4-5	Using Event Inputs . . . . .	105
4-5-1	Event Input Settings (ev-1 to ev-4) . . . . .	105
4-6	Setting the SP Upper and Lower Limit Values . . . . .	110
4-6-1	Set Point Limiter (sl-h) (sl-l) . . . . .	110
4-6-2	Setting . . . . .	111
4-7	Moving to the Advanced Function Setting Level . . . . .	111
4-8	Using the Key Protect Level . . . . .	113
4-8-1	Protection . . . . .	113
4-8-2	Entering the Password to Move to the Protect Level . . . . .	114
4-9	PV Change Color . . . . .	117
4-9-1	PV Color Change Function . . . . .	117
4-9-2	Setting . . . . .	118
4-10	Alarm Delays . . . . .	120
4-10-1	Alarm Delays . . . . .	120
4-11	Loop Burnout Alarm . . . . .	122
4-11-1	Loop Burnout Alarm (LBA) . . . . .	122
4-12	Performing Manual Control . . . . .	126
4-12-1	Manual Operation . . . . .	126
4-13	Using the Transfer Output . . . . .	132
4-13-1	Transfer Output Function . . . . .	132
4-14	Using PID Sets . . . . .	136
4-15	Program-related Functions . . . . .	138
4-15-1	Ramp Rate Programming . . . . .	138
4-15-2	Controlling the Program . . . . .	140

4-15-3	SP Mode (spmd) . . . . .	141
4-15-4	Wait (wt-b) . . . . .	142
4-15-5	Time signals . . . . .	143
4-15-6	Program Status Output . . . . .	144
4-15-7	Program Startup Operation . . . . .	145
4-15-8	Operation End Operation (eset). . . . .	147
4-15-9	Program SP Shift Value (psps) . . . . .	147
4-16	Output Adjustment Functions . . . . .	148
4-16-1	Output Limits (ol-h) (ol-l). . . . .	148
4-16-2	MV at Reset. . . . .	148
4-16-3	MV at PV Error. . . . .	149
4-17	Using the Extraction of Square Root Parameter . . . . .	151
4-18	Setting the Width of MV Variation . . . . .	152
4-19	Setting the PF Key . . . . .	154
4-19-1	PF Setting (Function Key). . . . .	154
4-20	Counting Control Output ON/OFF Operations . . . . .	157
4-20-1	Control Output ON/OFF Count Function . . . . .	157
4-21	Displaying PV/SV Status. . . . .	159
4-21-1	PV and SV Status Display Functions . . . . .	159
4-22	Using a Remote SP . . . . .	162
4-23	Position-proportional Control . . . . .	165
4-24	Logic Operations . . . . .	167
4-24-1	The Logic Operation Function (CX-Thermo). . . . .	167
4-24-2	Using Logic Operations . . . . .	167

## 4-1 Shifting Input Values

### 4-1-1 Shifting Inputs

Either a 1-point shift or a 2-point shift can be used to shift the input. The default setting is for a 1-point shift. To execute a 2-point shift, change the Input Shift Type parameter ( $\overline{I}S\overline{E}T$ ) setting (advanced function setting level) to  $\overline{I}N\overline{S}2$ .

There is no shift function for analog inputs. Use scaling for fine adjustments.

#### One-point shift



- With a 1-point shift, the value set for the Temperature Input Shift parameter (adjustment level) is applied to each point in the entire temperature input range. For example, if the input shift value is set to 1.2°C, the process value is treated as 201.2°C after the input shift is applied when the measured process value is 200°C.

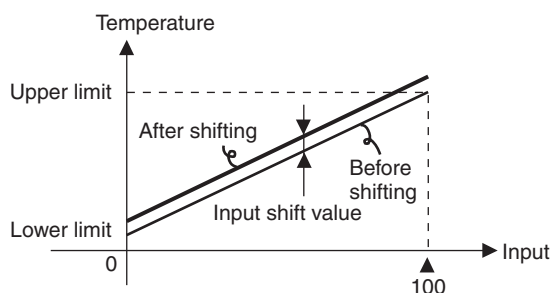

#### Operating Procedure

In this example, the input from a K sensor is shifted by 1°C using a 1-point input shift.

Operation Level

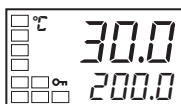

Operation Level

Adjustment Level



1. Press the  $\square$  Key twice to move from the operation level to the adjustment level.



2. Select the Temperature Input Shift parameter by pressing the  $\square$  Key.

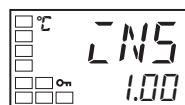

3. Press the  $\uparrow$  or  $\downarrow$  Key to set 1.00.

Operation Level

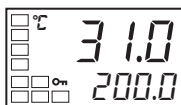

4. To return to the operation level, press the  $\square$  Key twice. The process value is 1°C larger than before the shift was applied.

**Two-point shift**

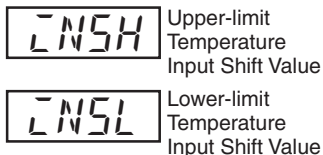

- Separate shift values can be set for the upper limit and lower limit of the sensor input range for an infrared sensor as well as for a thermocouple or platinum resistance thermometer with the Input Shift Type parameter (*ISP*) set to *NSP*. If different shift values are set for the upper limit and lower limit, then the slope of the line will be different before and after applying the input shift. For example, if the upper-limit value is set to 2°C and the lower-limit value is set to 1°C, the input temperature will be shifted by 1.5°C for a 50% input, i.e., by the average of the upper-limit and lower-limit values.
- Set the upper-limit value in the Upper-limit Temperature Input Shift Value parameter and the lower-limit value in the Lower-limit Temperature Input Shift Value parameter.

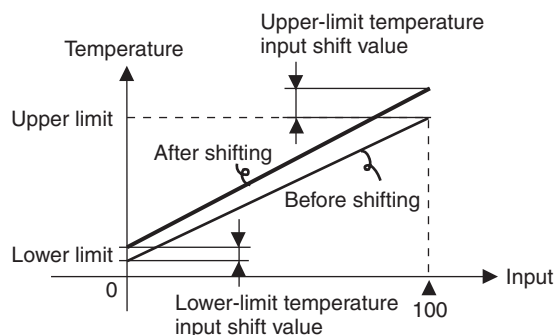

**4-1-2 How to Calculate Input Shift Values for a 2-point Shift**

Offset the readout value using a 1-point or 2-point shift as described in this section. This offset occurs because a bias current for detecting a Controller sensor error flows to the output impedance of the infrared temperature sensor.

**Method for a 1-point Shift**

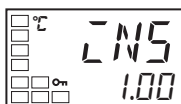

1,2,3...

1. In the configuration shown in *Figure 1*, bring the set point to near the value at which the temperature of the control target is to be controlled. Assume that the control target temperature (C) and the thermometer temperature (B) are the same.
2. Check the control target temperature (B) and the Controller readout (A). Subtract the Controller readout temperature (A) from the control target temperature (B), and set *NS* as the input shift value to the result. The shift is illustrated in *Figure 2*.

- After setting the input shift values, check the Controller readout (A) and the control target temperature (B). If they are approximately the same, this completes setting the input shift.

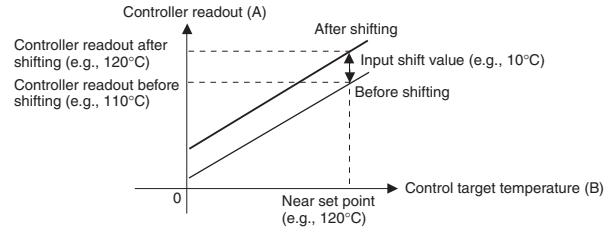
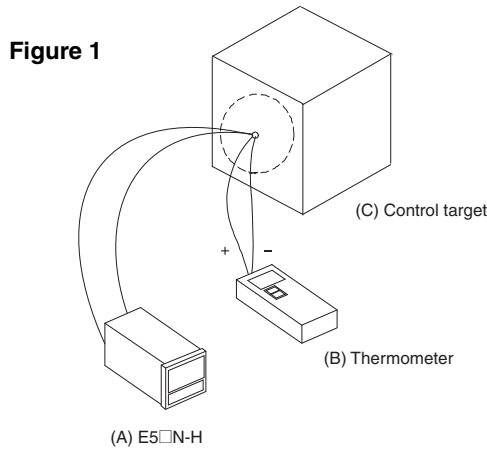

Figure 2 Illustration of 1-Point Shift

**Method for a 2-point Shift**

Use a 2-point input shift if you want to increase the accuracy of the readout values across the range of the Sensor.

1,2,3...

- Shift the Controller readout at two points, near room temperature and near the value at which the temperature of the control target is to be controlled. For this reason, check the thermometer temperature (B) and Controller readout (A) with the thermometer temperature near room temperature and near the set point.
- Y1 is the Controller readout at room temperature before shifting and X1 is the Controller readout at room temperature after shifting.
  - Y2 is the Controller readout at the set temperature before shifting and X2 is the Controller readout at the set temperature after shifting.
  - Set the upper-limit temperature input shift and the lower-limit temperature input shift using the following formulas based on the temperatures before shifting (Y1 and Y2), the temperatures after shifting (X1 and X2), the set temperature upper limit (YH), and the set temperature lower limit (YL). The shift is illustrated in Figure 3.

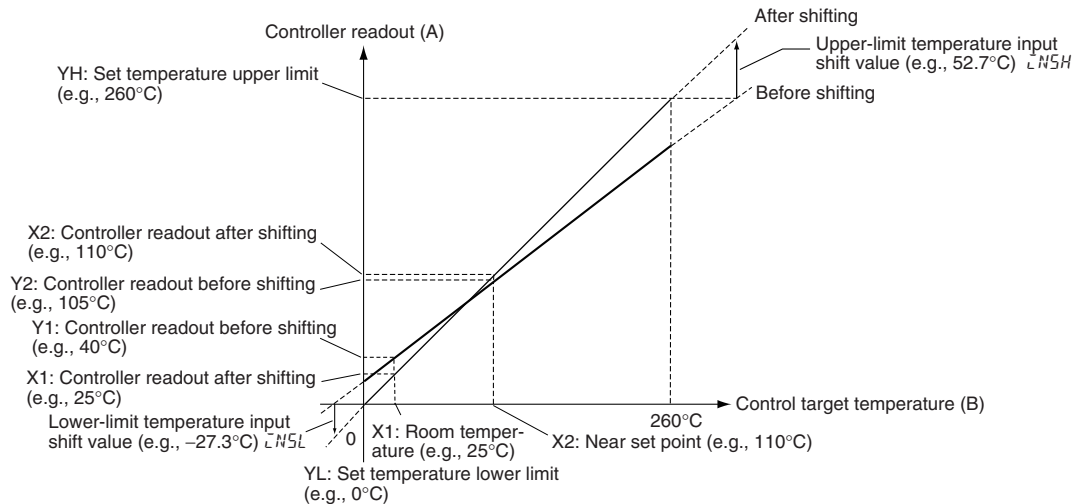

Figure 3 Illustration of 2-Point Shift

- a. Lower-limit temperature input shift value

$$\bar{L}NSL = \frac{YL - Y1}{Y2 - Y1} \times \{(X2 - Y2) - (X1 - Y1)\} + (X1 - Y1)$$

- b. Upper-limit temperature input shift value

$$\bar{L}NSH = \frac{YH - Y1}{Y2 - Y1} \times \{(X2 - Y2) - (X1 - Y1)\} + (X1 - Y1)$$

- After setting the calculated values to  $\bar{L}NSL$  and  $\bar{L}NSH$ , check the Digital Controller readout (A) and thermometer temperature (B).
- Here, offsets are set at two points, near room temperature and near the set point. To improve accuracy within the measurement temperature range, another point in the measurement temperature range other than the set point should be set instead of room temperature.

**Example of a 2-point Temperature Input Shift**

In this example, a K thermocouple from -200.0 to 1,300.0°C is used. In equations 1 and 2, the set temperature lower limit YL is -200°C and the set temperature upper limit YH is 1,300°C. Check the temperature of the control target.

The temperature input offset values can be calculated as shown below when the Digital Controller readout Y1 is 35°C for a room temperature X1 of 25°C and when the Digital Controller readout Y2 is 105°C for a set point temperature X2 of 110°C.

Lower-limit Temperature Input Shift Value

$$\bar{L}NSL = \frac{-200 - 35}{105 - 35} \times \{(110 - 105) - (25 - 35)\} + (25 - 35) = -60.35 \text{ (°C)}$$

Upper-limit Temperature Input Shift Value

$$\bar{L}NSH = \frac{1300 - 35}{105 - 35} \times \{(110 - 105) - (25 - 35)\} + (25 - 35) = 261.07 \text{ (°C)}$$

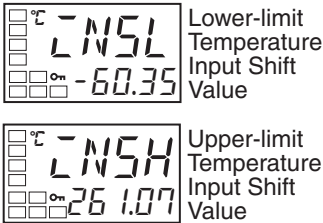

**4-2 Adjusting Alarms**

**4-2-1 Alarm Hysteresis (ALH1 to ALH3)**

- The hysteresis of alarm outputs when alarms are switched ON/OFF can be set as follows:

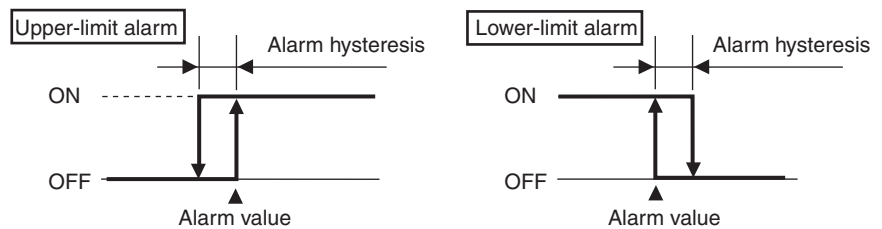

- Alarm hysteresis is set independently for each alarm in the Alarm 1 to 3 Hysteresis parameters (initial setting level).
- The default is 0.2 (°C/°F) when a temperature input is selected, and 0.02% FS when an analog input is selected.



### 4-2-2 Standby Sequence

- The standby sequence can be used so that an alarm will not be output until the process value leaves the alarm range once and then enters it again.
- For example, with a lower limit alarm, the process value will normally be below the set point, i.e., within the alarm range, when the power supply is turned ON, causing an alarm to be output. If the lower limit alarm with a standby sequence is selected, an alarm will not be output until the process value increases above the alarm set value, i.e., until it leaves the alarm range, and then falls back below the alarm set value.

#### Standby Sequence Reset

- The standby sequence is canceled when an alarm is output. It is, however, restarted later by the Standby Sequence Reset parameter (advanced function setting level). For details, refer to the Standby Sequence Reset parameter in *SECTION 5 Parameters*.

### 4-2-3 Alarm Latch (AL L to AL L)

- The alarm latch can be used to keep the alarm output ON until the latch is canceled regardless of the temperature once the alarm output has turned ON.

Any of the following methods can be used to clear the alarm latch.

- Turn OFF the power supply. (The alarm latch is also cleared by switching to the initial setting level, communications setting level, advanced function setting level, or calibration level.)
- Use the PF Key.
- Use an event input.

For details on setting the PF Key, refer to *4-19 Setting the PF Key*. For details on setting events, refer to *4-5 Using Event Inputs*.

### 4-2-4 Close in Alarm/Open in Alarm (sb IN to sb EN)

Refer to *Auxiliary Output Opening or Closing in Alarm (sb1n, sb2n)* in *3-5-3 Assigned Output Functions*.

### 4-2-5 Alarm SP Function (AL SP)

You can set either the present SP or the segment SP as the SP of a deviation alarm during ramp operation in Program SP Mode.

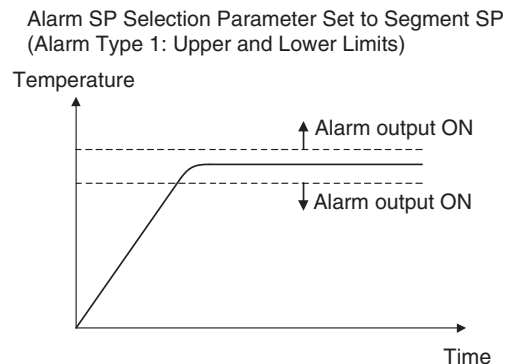
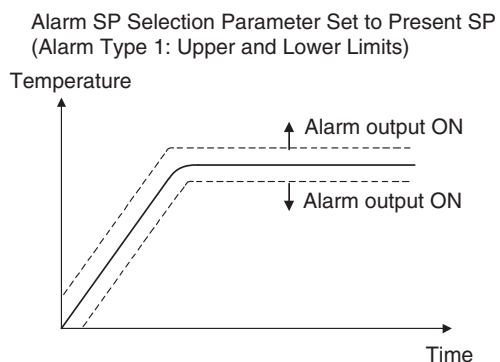

**Summary of Alarm Operation**

The following figure summarizes the operation of alarms when the Alarm Type parameter is set to “lower-limit alarm with standby sequence” and “close in alarm” is set.

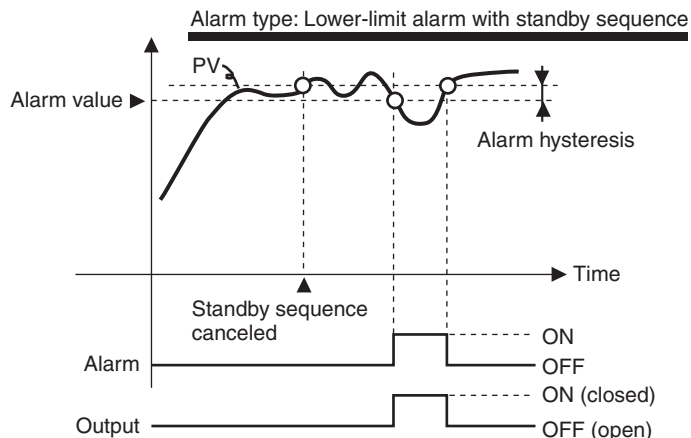

**Parameters**

Symbol	Parameter: level	Description
<i>RLH*</i>	Alarm 1 to 3 Hysteresis: Initial setting level	Alarm
<i>RESL</i>	Standby Sequence: Advanced function setting level	Alarm

Note \* = 1 to 3

**4-3 Setting Scaling Upper and Lower Limits for Analog Inputs**

**4-3-1 Analog Input**

LN-H

Scaling Upper Limit

LN-L

Scaling Lower Limit

dP

Decimal Point

- When an analog input is selected, scaling can be performed as needed by the control application.
- Scaling is set in the Scaling Upper Limit, Scaling Lower Limit, and Decimal Point parameters (initial setting level). These parameters cannot be used when a temperature input is selected.
- The Scaling Upper Limit parameter sets the physical quantity to be expressed by the upper limit value of input, and the Scaling Lower Limit parameter sets the physical quantity to be expressed by the lower-limit value of input. The Decimal Point parameter specifies the number of digits below the decimal point.
- The following figure shows a scaling example for a 4 to 20-mV analog input. After scaling, the temperature can be directly read. The decimal point is set to 1.

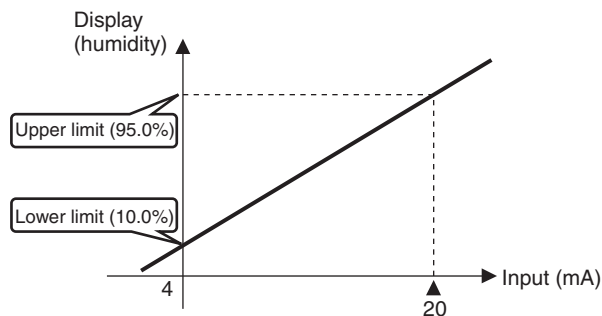

**Operating Procedure**

In this example scaling is set to display 4 to 20 mA as 10.0% to 95.0%.

Initial Setting Level

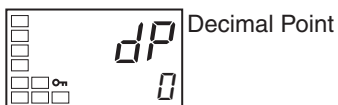
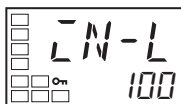
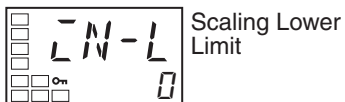
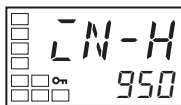
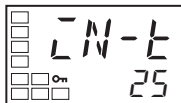
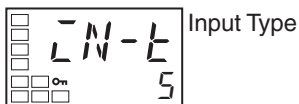

1. Press the Key for three seconds to move from the operation level to the initial setting level.
2. Press the and Keys to set 25.
3. Select Scaling Upper Limit parameter by pressing the Key.
4. Use the and Keys to set the parameter to 950.
5. Select the Scaling Lower Limit parameter by pressing the Key.
6. Press the and Keys to set 100.
7. Select the Decimal Point parameter by pressing the Key.
8. Press the and Keys to set 1.
9. To return to the operation level, press the Key for one second.

## 4-4 Executing Heating/Cooling Control

### 4-4-1 Heating/Cooling Control

Heating/cooling control (S-HC) operates when H-L (heating/cooling) is selected for the Standard or Heating/Cooling parameter for standard models. The following functions are assigned to outputs by default.

Parameter name	Symbol	Initial status
Control Output 1 Assignment	OUT 1	Control output for heating
Control Output 2 Assignment	OUT 2	Not assigned.
Auxiliary Output 1 Assignment	SUB 1	Alarm 1
Auxiliary Output 2 Assignment	SUB 2	Alarm 2
Auxiliary Output 3 Assignment (E5AN/EN-H only)	SUB 3	Alarm 3

Each output assignment is automatically initialized as shown below when the control mode is changed.

**Example: E5CN-H**

Parameter name	Symbol	Without control output 2		With control output 2	
		Standard	Heating/cooling	Standard	Heating/cooling
Control Output 1 Assignment	$\bar{a}U\bar{t}1$	Control output (heating)	Control output (heating)	Control output (heating)	Control output (heating)
Control Output 2 Assignment	$\bar{a}U\bar{t}2$	Not assigned. (See note.)	Not assigned. (See note.)	Not assigned.	Control output (cooling)
Auxiliary Output 1 Assignment	$SU\bar{b}1$	Alarm 1	Alarm 1	Alarm 1	Alarm 1
Auxiliary Output 2 Assignment	$SU\bar{b}2$	Alarm 2	Control output (cooling)	Alarm 2	Alarm 2

**Note** No parameter assignment is displayed because there is no control output 2.

- The heating/cooling operation of the control outputs will switch when the Direct/Reverse Operation parameter is set to “direct.”
- When DRS (Invert Direct/Reverse Operation) is assigned for an Event Input Assignment (1 to 4), control will start with the contents set for the Direct/Reverse Operation parameter inverted when the event input turns ON, and with the contents left according to the setting when the event input turns OFF. For details on event inputs and control combined with the Direct/Reverse Operation parameter, refer to *Control by Inverting Direct/Reverse Operation* on page 108.
- When heating/cooling control is selected, the Dead Band and Cooling Coefficient parameters can be used.

**Dead Band (L - db)**

- For heating/cooling control, the dead band is set with the set point as its center. The dead band width is the set value of the Dead Band parameter (adjustment level). Setting a negative value produces an overlapping band.
- If an overlapping band is set, the bumpless function may not operate when switching between manual operation and automatic operation.
- The default is 0.0 EU for a temperature input and 0.00% FS for an analog input.

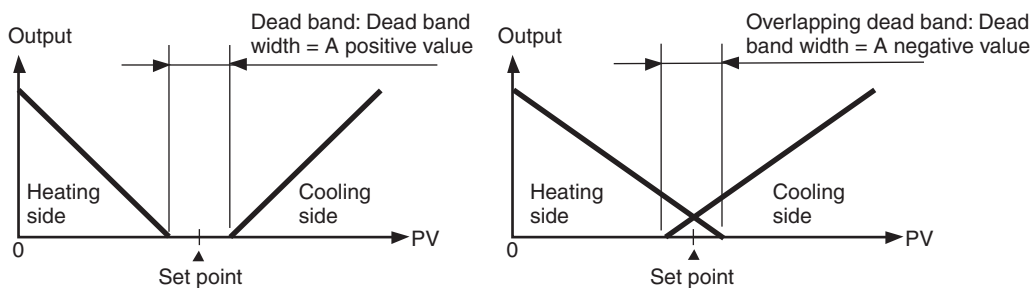

**Cooling Coefficient (L - SC)**

If the heating characteristics and cooling characteristics of the control object are very different and good control characteristics cannot be achieved with the same PID constants, the cooling coefficient can be used to adjust the proportional band (P) for the control output assigned to the cooling side. Use this to achieve balanced control between the heating side and cooling side. The proportional bands (P) for the control outputs assigned to the heating/cooling sides can be calculated using the following equations.

P for control output assigned to heating side = P

P for control output assigned to cooling side = P for control output assigned to heating side × cooling coefficient

The cooling coefficient is multiplied by the P for the control output assigned to the heating side to obtain control with characteristics that differ from those of the control output assigned to the heating side.

A cooling coefficient can be set for each PID set. To set the cooling coefficient, select the PID set number in the Display PID Selection parameter (PID setting level) and then set the Cooling Coefficient parameter. If the Cooling Coefficient parameter setting is changed in the adjustment level, the change will be reflected in the Cooling Coefficient parameter for the current PID set.

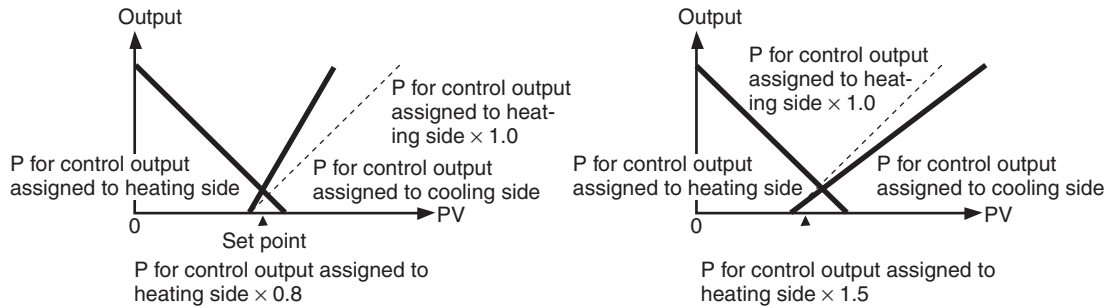

**Automatic Cooling Coefficient Adjustment**

By executing AT during heating/cooling control, the cooling coefficient can be automatically calculated along with the PID parameters.

Parameter name	Setting range	Default
Automatic Cooling Coefficient Adjustment	OFF: Disabled, ON: Enabled	OFF

**Note** If there is strong non-linear gain for the cooling characteristics, such as when cooling water boils for cooling control, it may not be possible to obtain the optimum cooling coefficient at the Controller, and control may take the form of oscillating waves. If that occurs, increase the proportional band or the cooling coefficient to improve control.

**4-4-2 Settings**

To set heating/cooling control, set the Standard or Heating/Cooling, Dead Band, and Cooling Coefficient parameters.

**Setting Heating/Cooling Control**

**Operating Procedure**

Standard or heating/cooling = Heating/cooling

Initial Setting Level

1. Press the  Key for at least three seconds to move from the operation level to the initial setting level.



2. Select "heating/cooling control" in the initial setting level.  
 5END: Standard control  
 H-ℓ: Heating/cooling control

**Setting the Cooling Coefficient**

**Operating Procedure**

PID 1 Cooling Coefficient = 10

PID Setting Level

1. Press the  Key three times to move from the operation level to the PID setting level. The current PID set number will be displayed. Use the  or  Key to select 1.



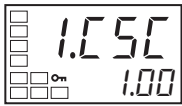

PID1 Cooling Coefficient

2. Select the PID1 Cooling Coefficient parameter by pressing the  Key.



3. Press the  and  Keys to set 10.00.

### Setting the Dead Band

#### Operating Procedure

Dead Band = 5

Adjustment Level

1. Press the  Key twice to select the Dead Band parameter in the adjustment level.



Dead Band

2. Use the  Key to set the parameter to 5.0.



## 4-5 Using Event Inputs

### 4-5-1 Event Input Settings (EV - 1 to EV - 4)

- Depending on the Controller, there are either two event inputs (event inputs 1 and 2 or 3 and 4) or four event inputs (event inputs 1 to 4). The number of event inputs that can be used varies. (Only the E5AN/EN-HT has event inputs 3 and 4.)
- Event inputs can be used for any of the following: switching programs, run/reset, reset, run, automatic/manual, hold/clear hold, hold, advance, Program SP Mode/Remote SP Mode (E5AN-HT or E5EN-HT only), Remote SP Mode/Fixed SP Mode (E5AN-HT or E5EN-HT only), Program SP Mode/Fixed SP Mode, wait enable/disable, invert direct/reverse operation, 100% AT execute/cancel, 40% AT execution/cancel, setting change enable/disable, communications writing enable/disable, and alarm latch cancel.
- Event inputs can be used on the following models:  
 Two Event Inputs;  
 E5CN-HT□M□-500 with the E53-CN□B□N2 for the E5CN-HT  
 E5AN/EN-HT□B□M□-500 for the E5AN/EN-HT  
 Four Event Inputs;  
 E5AN/EN-HT□B□M□-500 with the E53-AKB for the E5AN/EN-HT

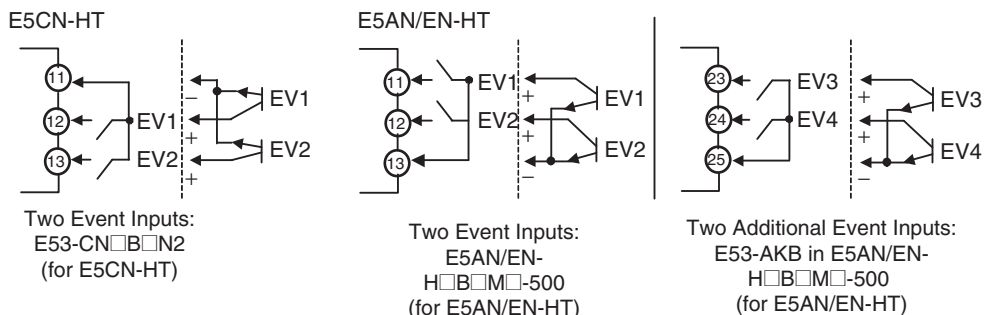

The following table shows the functions assigned when an Event Input Assignment (1 to 4) is displayed.

Setting	Function
NONE	None
RR-1	Run (OFF)/Reset (ON)
RR-2	Run (ON)/ Reset (OFF)
MANU	Auto/Manual
RSE	Reset
RUN	Run
HLd1	Hold/Clear Hold
HLd2	Hold
RdV	Advance (See note 1.)
PRG0	Program Number Switch 0 (See note 2.)
PRG1	Program Number Switch 1 (See note 2.)
PRG2	Program Number Switch 2 (See note 2.)
dRS	Invert Direct/Reverse Operation
SPM1	Program SP Mode/Remote SP Mode (See note 3.)
SPM2	Remote SP Mode/Fixed SP Mode (See note 3.)
SPM3	Program SP Mode/Fixed SP Mode

Setting	Function
$RE - 2$	100% AT Execute/Cancel
$RE - 1$	40% AT Execute/Cancel (See note 4.)
$WPE$	Setting Change Enable/Disable
$CMWE$	Communications Write Enable/Disable (See note 5.)
$LRE$	Alarm Latch Cancel
$WRE$	Wait Enable/Disable

- Note**
- (1) The event input must be turned OFF first before this function can be activated again. This function is enabled only during program operation.
  - (2) These functions are enabled only in reset status.
  - (3) These functions can be set for the E5AN-HT/E5EN-HT only.
  - (4) This function can be set for heating/cooling control, or for floating control for a Position-proportional Model, but the function will be disabled.
  - (5) This function can be selected only with models that support communications. Also, when a work bit is selected as event input data, Communications Write Enable/Disable parameter cannot be selected.

The same function cannot be assigned to more than one event input. For example, if Run/Reset is assigned to event input 1, it cannot be assigned to any other event input from event input 2 to 4. To assign it to another event input, you must first assign event input 1 to a function other than Run/Reset. Turn event inputs ON and OFF while the power is being supplied. Event input ON/OFF changes are detected for inputs of 50 ms or longer. (However, inputs of 250 ms or longer is determined using logic operation.)

The functions are described in detail below. Event inputs 1 and 2 are taken as examples. When using event inputs 3 and 4, substitute event input 3 for event input 1 and event input 4 for event input 2.

**Controller Run/Reset Status**

When the Event Input Assignment 1 or Event Input Assignment 2 parameter is set to RR-1 (Run (OFF)/Reset (ON)), control will start when event input 1 or 2 turns OFF. Control is stopped when the input turns ON. Alarm outputs, however, will be according to the PV. The RST (reset) indicator will light while control is stopped.

Setting	Input contact	Status
Event input 1 or 2	ON	RST
Event input 1 or 2	OFF	RUN



The operation will be as shown below if the parameter is set to RR-2 (Run (ON)/Reset (OFF)).

Setting	Input contact	Status
Event input 1 or 2	ON	RUN
Event input 1 or 2	OFF	RST



**Switching between Auto and Manual Control**

When the Event Input Assignment 1 or Event Input Assignment 2 parameter is set to MANU (auto/manual), manual control will start when event input 1 or 2 turns ON. Auto control will start when the input turns OFF.

The MANU indicator will light during manual control.

Setting	Input contact	Status
Event input 1 or 2	OFF	Automatic
Event input 1 or 2	ON	Manual



**Resetting a Program**

When the Event Input Assignment 1 or Event Input Assignment 2 parameter is set to RST (reset), control will stop when event input 1 or 2 turns ON. Alarm outputs, however, will be according to the PV. The RST (reset) indicator will light while control is stopped.

Setting	Input contact	Status
Event input 1 or 2	ON	RST
Event input 1 or 2	OFF	No change.



**Running a Program**

When the Event Input Assignment 1 or Event Input Assignment 2 parameter is set to RUN (run), control will start when event input 1 or 2 turns ON.

Setting	Input contact	Status
Event input 1 or 2	ON	RUN
Event input 1 or 2	OFF	No change.

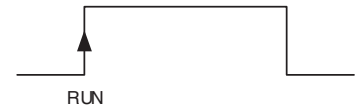

**Hold/Clear Hold**

When the Event Input Assignment 1 or Event Input Assignment 2 parameter is set to HLD1 (hold), hold status will be entered when event input 1 or 2 turns ON. Hold status will be cleared when the input turns OFF. This function is enabled only during program operation. The HOLD indicator will light during hold status.

Setting	Input contact	Status
Event input 1 or 2	ON	Hold
Event input 1 or 2	OFF	Hold cleared.



**Holding a Program**

When the Event Input Assignment 1 or Event Input Assignment 2 parameter is set to HLD2 (hold), hold status will be entered when event input 1 or 2 turns ON. This function is enabled only during program operation.

Setting	Input contact	Status
Event input 1 or 2	ON	Hold
Event input 1 or 2	OFF	No change.



**Advancing a Program**

When the Event Input Assignment 1 or Event Input Assignment 2 parameter is set to ADV (advance), the program will move to the next segment when event input 1 or 2 turns ON. The event input must be turned OFF first before this function can be activated again. This function is enabled only during program operation.

Setting	Input contact	Status
Event input 1 or 2	ON	Advance
Event input 1 or 2	OFF	No change.

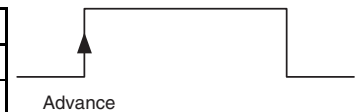

**Changing the Program**

The ON/OFF status of the event inputs can be used to specify the number of the program to change to. The relation between the ON/OFF status of the event inputs and the number of the selected program is shown in the following table. The status of any input that is not assigned is taken as OFF.

	Program number							
	0	1	2	3	4	5	6	7
Program Number Switch 0	OFF	ON	OFF	ON	OFF	ON	OFF	ON
Program Number Switch 1	OFF	OFF	ON	ON	OFF	OFF	ON	ON
Program Number Switch 2	OFF	OFF	OFF	OFF	ON	ON	ON	ON

**Control by Inverting Direct/Reverse Operation**

When DRS (Invert Direct/Reverse Operation) is set for the Event Input Assignment 1 or Event Input Assignment 2 parameter and the Direct/Reverse Operation parameter is set for reverse operation, control starts with direct operation (cooling control) when event input 1 or 2 turns ON and control starts with reverse operation (heating control) when the event input turns OFF.

Setting	Input contact	Direct/Reverse Operation parameter	Status
Event input 1 or 2	OFF	Direct operation (cooling)	Direct operation (cooling)
		Reverse operation (heating)	Reverse operation (heating)
Event input 1 or 2	ON	Direct operation (cooling)	Reverse operation (heating)
		Reverse operation (heating)	Direct operation (cooling)

**Switching between Program SP Mode and Remote SP Mode**

When the Event Input Assignment 1 or Event Input Assignment 2 parameter is set to SPM1 (Program SP Mode/Remote SP Mode), the remote SP (RSP) will be used as the SP while event input 1 or 2 is ON. While the input is OFF, the program SP (PSP) will be used as the SP. The RSP (remote SP) indicator will be lit while the remote SP is being used as the SP. (This indicator is provided only on the E5AN-HT and E5EN-HT.)

Setting	Input contact	Status
Event input 1 or 2	ON	Remote SP
Event input 1 or 2	OFF	Program SP



**Switching between Remote SP Mode and Fixed SP Mode**

When the Event Input Assignment 1 or Event Input Assignment 2 parameter is set to SPM2 (Remote SP Mode/Fixed SP Mode), the fixed SP (FSP) will be used as the SP while event input 1 or 2 is ON. While the input is OFF, the remote SP (RSP) will be used as the SP. The RSP (remote SP) indicator will be lit while the remote SP is being used as the SP. (This is supported only by the E5AN-HT and E5EN-HT.) The FSP (fixed SP) indicator will be lit while the fixed SP is being used as the SP.

Setting	Input contact	Status
Event input 1 or 2	ON	Fixed SP
Event input 1 or 2	OFF	Remote SP

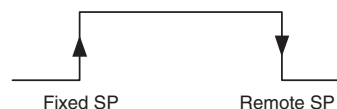

**Switching between Program SP Mode and Fixed SP Mode**

When the Event Input Assignment 1 or Event Input Assignment 2 parameter is set to SPM3 (Program SP Mode/Fixed SP Mode), the fixed SP (FSP) will be used as the SP while event input 1 or 2 is ON. While the input is OFF, the program SP (PSP) will be used as the SP. The FSP (fixed SP) indicator will be lit while the fixed SP is being used as the SP.

Setting	Input contact	Status
Event input 1 or 2	ON	Fixed SP
Event input 1 or 2	OFF	Program SP

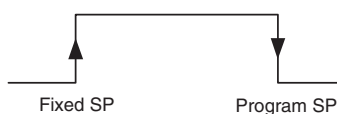

**Switching 100% AT Execute/Cancel**

When AT-2 (100% AT Execute/Cancel) is set for either the Event Input Assignment 1 or Event Input Assignment 2 parameter, 100% AT will be executed when event input 1 or 2 turns ON and will be cancelled when the input turns OFF.

Setting	Input contact	Status
Event input 1 or 2	OFF	100% AT cancelled
Event input 1 or 2	ON	100% AT executed

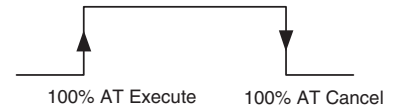

**Switching 40% AT Execute/Cancel**

When AT-1 (40% AT Execute/Cancel) is set for either the Event Input Assignment 1 or Event Input Assignment 2 parameter, 40% AT will be executed when event input 1 or 2 turns ON and will be cancelled when the input turns OFF.

Setting	Input contact	Status
Event input 1 or 2	OFF	40% AT cancelled
Event input 1 or 2	ON	40% AT executed

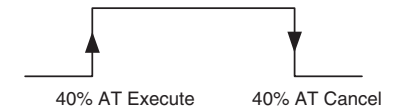

**Switching Setting Change Enable/Disable**

When WTPT (Setting Change Enable/Disable) is set for either the Event Input Assignment 1 or Event Input Assignment 2 parameter, the setting change will be disabled when event input 1 or 2 turns ON and will be enabled when the input turns OFF.

Setting	Input contact	Status
Event input 1 or 2	OFF	Enabled
Event input 1 or 2	ON	Disabled

**Switching Communications Write Enable/Disable**

Only event inputs 3 and 4 can be set to Communications Write Enable/Disable.

When CMWT (Communications Write Enable/Disable) is set for either the Event Input Assignment 3 or Event Input Assignment 4 parameter, communications writing will be enabled when event input 3 or 4 turns ON and will be disabled when the input turns OFF.

Setting	Input contact	Status
Event input 3 or 4	OFF	Disabled
Event input 3 or 4	ON	Enabled

**Switching Alarm Latch Cancel**

When LAT (Alarm Latch Cancel) is set for either the Event Input Assignment 1 or Event Input Assignment 2 parameter, all alarm latches (alarms 1 to 3, heater burnout, HS alarm, and heater overcurrent latch) will be cancelled when event input 1 or 2 turns ON.

Setting	Input contact	Status
Event input 1 or 2	OFF	---
Event input 1 or 2	ON	Cancelled

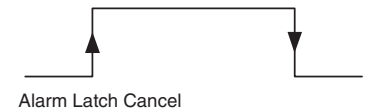

**Enabling and Disabling Wait Operation**

When the Event Input Assignment 1 or Event Input Assignment 2 parameter is set to WAIT (wait enable/disable), wait operation will be enabled when event input 1 or 2 turns ON. When the input turns OFF, wait operation will be disabled. This function is enabled only during program operation.

Setting	Input contact	Status
Event input 1 or 2	ON	Wait operation enabled.
Event input 1 or 2	OFF	Wait operation disabled.

**Parameters**

Symbol	Parameter: level	Description
EV-1	Event Input Assignment 1: Initial setting level	Function of event input function
EV-2	Event Input Assignment 2: Initial setting level	
EV-3	Event Input Assignment 3: Initial setting level	
EV-4	Event Input Assignment 4: Initial setting level	

**4-6 Setting the SP Upper and Lower Limit Values**

**4-6-1 Set Point Limiter (5L-H) (5L-L)**

The setting range of the SP is limited by the set point limiter. The limiter prevents you from unintentionally setting an abnormal SP. The upper- and lower-limit values of the set point limiter are set using the Set Point Upper Limit and Set Point Lower Limit parameters in the initial setting level. If the SP is outside of the specified range after the setting of the Set Point Upper Limit or Set Point Lower Limit parameter is changed, the SP will be automatically changed so that it is within the range. When the set point limiter is reset, the set point is forcibly changed to the upper- or lower-limit value of the set point limiter if the set point is out of the limiter range. Also, when the input type and the temperature unit, scaling upper-limit value, or lower-limit value are changed, the set point limiter is forcibly reset to the input setting range or the scaling upper- or lower-limit value.

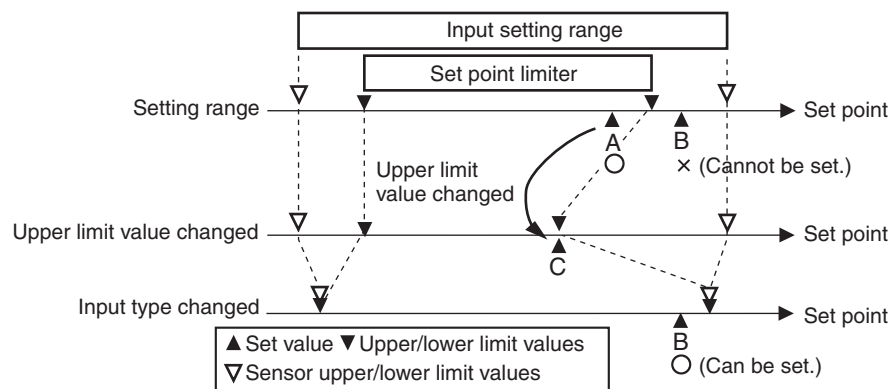

**Parameters**

Symbol	Parameter: level	Description
5L-H	Set Point Upper Limit: Initial setting level	To limit the SP setting
5L-L	Set Point Lower Limit: Initial setting level	To limit the SP setting

### 4-6-2 Setting

Set the set point upper and lower limits in the Set Point Upper Limit and Set Point Lower Limit parameters in the initial setting level. In this example, it is assumed that the input type is set to a K thermocouple with a temperature range of  $-200.0$  to  $1300.0^{\circ}\text{C}$ .

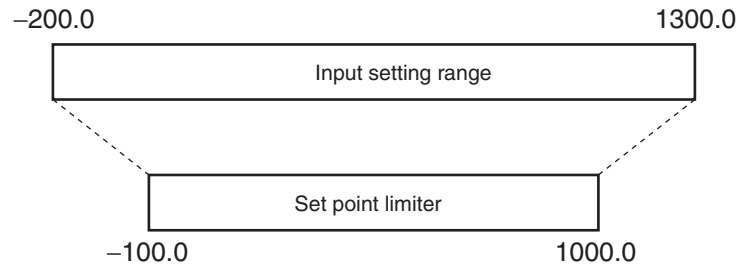

#### Setting the Set Point Upper-limit Value

##### Operating Procedure

Set Point Upper Limit = 1000

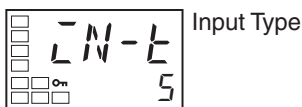

1. Press the Key for at least three seconds to move from the operation level to the initial setting level.

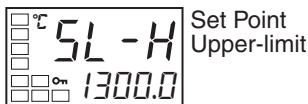

2. Select the Set Point Upper Limit parameter.

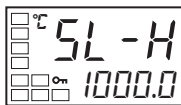

3. Use the and Keys to set the parameter to 1000.0.

#### Setting the Set Point Lower-limit Value

##### Operating Procedure

Set Point Lower Limit =  $-100$

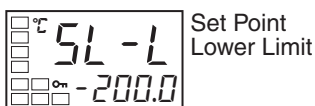

1. Select the Set Point Lower Limit parameter in the initial setting level.

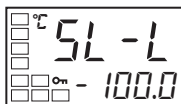

2. Use the and Keys to set the parameter to  $-100.0$ .

## 4-7 Moving to the Advanced Function Setting Level

Use the following procedure to move to the advanced function setting level.

- 1,2,3... 1. Press the and Keys simultaneously for at least three seconds in operation level.

**Note** The key pressing time can be changed in the Move to Protect Level Time parameter (advanced function setting level).

Protect Level



Operation/Adjustment Protect

2. The Controller moves to the protect level, and the Operation/Adjustment Protect parameter is displayed.

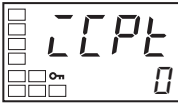

Initial Setting/Communications Protect

3. Press the Key once to move to the Initial Setting/Communications Protect parameter.

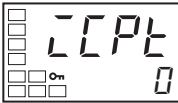

4. Set the set value to 0. The default setting is 0 (possible to reach).

Operation Level

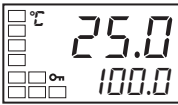

PV/SP

5. Press the and Keys simultaneously for at least one second to return to the operation level.

Initial Setting Level

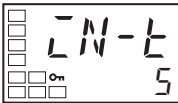

Input Type

6. Move to the advanced function setting level. Press the Key for at least three seconds to move from the operation level to the initial setting level.

Initial Setting Level

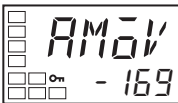

Move to Advanced Function Setting Level

7. Select the Move to Advanced Function Setting Level parameter by pressing the Key.

Advanced function setting level

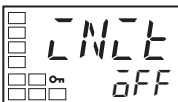

Parameter Initialization

8. Press the Key, enter the password (-169), and then either press the Key or leave the setting for at least two seconds to move to the advanced function setting level from the initial setting level.

Initial Setting Level

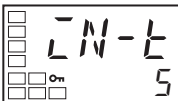

Input Type

9. To return to the initial setting level, press the Key for at least one second.

Operation Level



PV/SP

10. To return to the operation level, press the Key for at least one second.

## 4-8 Using the Key Protect Level

### 4-8-1 Protection

- To move to the protect level, press the  and M Keys at the same time for at least three seconds in the operation level, adjustment level, program setting level, or PID setting level. (See note.)

**Note** The key pressing time can be changed in the Move to Protect Level Time parameter (advanced function setting level).

- The protect level protects parameters that are not changed during Controller operation until operation is started to prevent them from being modified unintentionally.

There are four types of protection: operation/adjustment protect, initial setting/communications protect, setting change protect, and PF Key protect.

- The protect level settings restrict the range of parameters that can be used.

#### Operation/Adjustment Protect

The following table shows the relationship between set values and the range of protection.



Level		Set value					
		0	1	2	3	4	5
Operation level	PV	Can be displayed	Can be displayed	Can be displayed	Can be displayed	Can be displayed	Can be displayed
	PV/SP	Can be displayed and changed	Can be displayed and changed	Can be displayed and changed	Can be displayed and changed	Can be displayed and changed	Can be displayed
	Others	Can be displayed and changed	Can be displayed and changed	Can be displayed and changed	Cannot be displayed and moving to other levels is not possible	Cannot be displayed and moving to other levels is not possible	Cannot be displayed and moving to other levels is not possible
Program Setting Level		Can be displayed and changed	Can be displayed and changed	Can be displayed and changed	Cannot be displayed and moving to other levels is not possible	Cannot be displayed and moving to other levels is not possible	Cannot be displayed and moving to other levels is not possible
Adjustment level		Can be displayed and changed	Can be displayed and changed	Cannot be displayed and moving to other levels is not possible	Cannot be displayed and moving to other levels is not possible	Cannot be displayed and moving to other levels is not possible	Cannot be displayed and moving to other levels is not possible
PID Setting Level		Can be displayed and changed	Cannot be displayed and moving to other levels is not possible	Cannot be displayed and moving to other levels is not possible	Cannot be displayed and moving to other levels is not possible	Cannot be displayed and moving to other levels is not possible	Cannot be displayed and moving to other levels is not possible

- Parameters are not protected when the set value is set to 0.
- The default is 0.

**Initial Setting/  
Communications  
Protect**



This protect level restricts movement to the initial setting level, communications setting level, and advanced function setting level.

Set value	Initial setting level	Communications setting level	Advanced function setting level
0	Possible to reach	Possible to reach	Possible to reach
1	Possible to reach	Possible to reach	Not possible to reach
2	Not possible to reach	Not possible to reach	Not possible to reach

- The default is 0.

**Setting Change  
Protect**

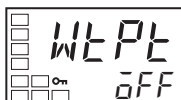

This protect level restricts key operations.

Set value	Description
OFF	Settings can be changed using key operations.
ON	Settings cannot be changed using key operations. (The protect level settings, however, can be changed.)

- The default is OFF.
- The all protect indication (On) will light when setting change protect is set.

**PF Key Protect**

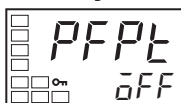

This protect level enables or disables PF Key operations.

Set value	Description
OFF	PF Key enabled.
ON	PF Key disabled (Operation as function key prohibited).

- The default is OFF.

**4-8-2 Entering the Password to Move to the Protect Level**

- Protect level can be moved to only by display the password display and entering the correct password. (The user can set any password in the Protect Level Password parameter. If no password is set (i.e., if the password is set to 0 in the Protect Level Password parameter), the password input display to move to protect level will not be displayed and the protect level can be moved to directly.

**Operating Procedure**

Use the following procedure to move to protect level.

■ **Example with a Password of 1234**

Operation Level



Protect Level

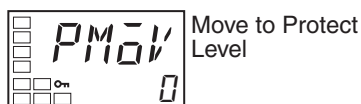

1. Press the and Keys simultaneously for at least the time set in the Move to Protect Level Time parameter to move from the operation level to the protect level.



2. Press the Key to set the parameter to 1234 (password input).



Protect Level



Operation/Adjustment Protect

3. Move to the Operation/Adjustment Protect parameter by pressing the or Key or leaving the setting for at least two seconds.

### ■ Example with No Password Set

Operation Level

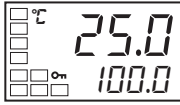

PV/SP

Protect Level



Operation/Adjustment Protect

Press the and Keys simultaneously for at least the time set in the Operation/Adjustment Protect parameter to move from the operation level to the protect level.

When a password is not set, the Operation/Adjustment Protect parameter will be displayed.

## Setting the Password

### Operating Procedure

Use the following procedure to set the password to move to the protect level.

### ■ Example To set the Password to 1234

Operation Level

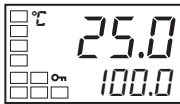

PV/SP

Protect Level



Operation/Adjustment Protect

1. Press the and Keys simultaneously for at least the time set in the Move to Protect Level Time parameter to move from the operation level to the protect level.

Protect Level



Password to Move to Protect Level

2. Select the Password to Move to Protect Level parameter by pressing the Key.



3. Press the and Keys to set the parameter to 1234. (To prevent setting the password incorrectly, the and Keys or and Keys must be pressed simultaneously to set the password.)

**Note** Protection cannot be cleared or changed without the password. Be careful not to forget it. If you forget the password, contact your OMRON sales representative.

## Communications

### Operation Command to Move to the Protect Level

- The Write Variable operation command can be used via communications to write the password to the Move to Protect Level parameter. When the correct password is written, the display will change to the Operation/Adjustment Protect parameter and writing the parameters in the protect level will be enabled.

### Note

- (1) If the Write Variable operation command is used to write the wrong password to the Move to Protect Level parameter after the correct parameter has been written, the Move to Protect Level parameter will be displayed

and any Write Variable operation commands to write parameters in the protect level will result in operation errors.

- (2) If a password is not set or if it is set to 0, the display will change to the Operation/Adjustment Protect parameter and writing the parameters in the protect level will be enabled immediately.

## 4-9 PV Change Color

### 4-9-1 PV Color Change Function

Use the PV color change function to change the color of the PV display (No. 1 display).

There are three display colors, orange, red, and green, and you can select from the following four modes and nine functions.



- Constant: This mode displays orange, red, or green all the time.
- Linked to Alarm 1: This mode switches the PV display color from red to green when alarm 1 turns ON or from green to red when alarm 1 turns ON.
- This mode links the color of the PV display to program operation. The color is red while the present SP is rising, orange while the present SP is constant, and green while the present SP is falling. The PV display color is orange when program operation is not being used.
- Linked to PV stable band: This mode switches the PV display color between red outside the PV stable band and green within PV stable band, or between green outside the PV stable band and red within PV stable band.  
Set the PV stable band in the PV Stable Band parameter (advanced function setting level).
- The default is *REd* (red).

The following tables shows the display functions that can be set using the PV color change function.

Mode	Setting	Function	PV change color		Application example
Constant	<i>ORg</i>	Orange	Constant: Orange		To match the display color with other Controller models
	<i>REd</i>	Red	Constant: Red		To match the display color with other Controller models
	<i>GRN</i>	Green	Constant: Green		To match the display color with other Controller models
Linked to alarm 1			<p>The diagram shows a horizontal axis for PV. A vertical dashed line indicates the Alarm value. A double-headed arrow above it shows the Alarm value range. A grey box labeled 'ALM1 lit' is positioned to the right of the Alarm value. An arrow labeled 'PV' points to the right. A vertical arrow labeled 'SP' points upwards from the PV axis.</p>		
			ALM1 not lit	ALM1 lit	Application example
	<i>R-G</i>	Red to Green	Red	Green	To display the PV reached signal
	<i>G-R</i>	Green to Red	Green	Red	To display error signals

Mode	Setting	Function	PV change color			Application example
Linked to PV stable band						
			Low	Within PV stable band	High	Application example
	$R-\underline{G},R$	Red to Green to Red	Red	Green	Red	To display stable status
	$\underline{G}-\bar{O},R$	Green to Orange to Red	Green	Orange	Red	To display stable status
	$\bar{O}-\underline{G},R$	Orange to Green to Red	Orange	Green	Red	To display stable status
Linked to program			Rising	Constant	Falling	Application example
	$R-\bar{O},\underline{G}$	Red to Orange to Green	Red	Orange	Green	Displaying program operation status

**PV Stable Band**



When the mode to link to the PV stable band is selected, the PV display color will change according to whether the present value (PV) is lower than, within, or higher than the PV stable band shown in the following figure. The PV stable band is set with the SP as the center, as shown below.

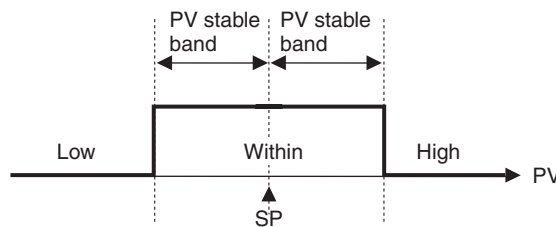

The default is 5.0 (°C/°F) for a temperature input and 5.0% FS for an analog input.

**4-9-2 Setting**

**Setting the PV Change Color to Indicate Stable Status**

To display the PV in a stable green display when the PV is within ±15.0°C of the set point to enable checking the control process at a glance, set the PV Change Color and PV Stable Band parameters.

PV change color =  $R-\underline{G},R$  (Red to Green to Red)

PV stable band = 15.0°C

**Operating Procedure**

Release the protection before setting the PV Change Color and PV Stable Band parameters to enable moving to advanced function setting level. (Refer to steps 1 to 8 on page 111.)

PV Change Color:  $R-\underline{G},R$  (Red to Green to Red)

PV Stable Band: 15.0 (°C)

Operation Level



Initial Setting Level

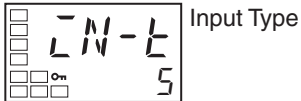

1. Press the Key for at least three seconds to move from the operation level to the initial setting level.

Initial Setting Level



2. Select the Move to Advanced Function Setting Level parameter by pressing the Key.
3. Use the Key to enter “-169” (the password).

Advanced Function Setting Level

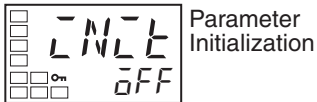

Move to the advanced function setting level by pressing the Key or leaving the setting for at least two seconds.

Advanced Function Setting Level

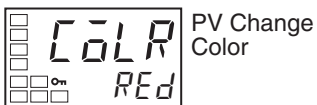

4. Select the PV Change Color parameter by pressing the Key.

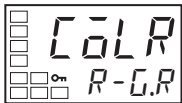

5. Press the Key to set the parameter to R-G-R.

Advanced Function Setting Level

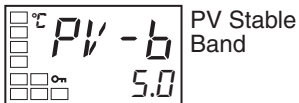

6. Select the PV Stable Band parameter by pressing the Key.

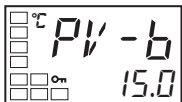

7. Use the Key to set the parameter to 15.0.

8. To return to the initial setting level, press the Key for at least one second.

Operation Level



9. To return to the operation level, press the Key for at least one second.

## 4-10 Alarm Delays

### 4-10-1 Alarm Delays

- Delays can be set for the alarm outputs. ON and OFF delays can be set separately for alarms 1, 2, and 3. The ON and OFF delays for alarm 1 function only for the alarm function. If the alarm 1 function is set to be output as an OR with other alarms (i.e., the heater burnout alarm, HS alarm, heater overcurrent alarm, or input error output alarm), delays cannot be set for the other alarms. The ON and OFF delays for alarms 1, 2, and 3 also apply to the individual SUB1, SUB2, and SUB3 indicators and to communications status. The alarm ON delays will also function when power is turned ON or when moving from the initial setting level to operation level (e.g., to software resets). All outputs will turn OFF and the OFF delays will not function when moving to the initial setting level or when an alarm is output for a A/D converter error.

#### Operation of Alarm ON and OFF Delays (for an Upper-limit Alarm)

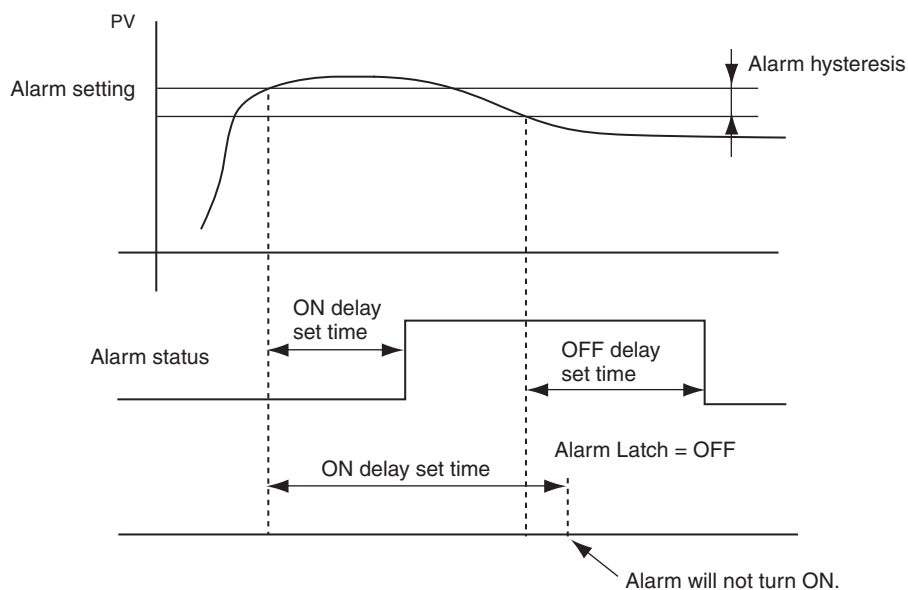

- The alarm will not turn ON if the time that the alarm is ON is equal to or less than the ON delay set time. Also, the alarm will not turn OFF if the time that the alarm is OFF is equal to or less than the OFF delay set time.
- If an alarm turns OFF and then back ON during the ON delay time, the time will be remeasured from the last time the alarm turns ON. Also, if an alarm turns ON and then back OFF during the OFF delay time, the time will be remeasured from the last time the alarm turns OFF.

#### Parameters Related to Alarm Delays

Parameter name	Symbol	Set (monitor) values
Alarm 1 ON Delay	$R1\bar{o}N$	0 to 999 (s)
Alarm 2 ON Delay	$R2\bar{o}N$	0 to 999 (s)
Alarm 3 ON Delay	$R3\bar{o}N$	0 to 999 (s)
Alarm 1 OFF Delay	$R1\bar{o}F$	0 to 999 (s)
Alarm 2 OFF Delay	$R2\bar{o}F$	0 to 999 (s)
Alarm 3 OFF Delay	$R3\bar{o}F$	0 to 999 (s)

- Note**
- (1) The defaults are 0, i.e., the ON and OFF delays are disabled.
  - (2) The parameters are displayed when alarm functions are assigned and when the alarm type is set to any type but 0 (none), 12: LBA, or 13: PV change rate alarm.

**Operating Procedure**

Use the following procedure to set ON and OFF delays for the alarm 1.  
An ON delay of 5 seconds and an OFF delay of 10 s will be set.

Operation Level



Initial Setting Level

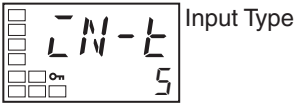

1. Press the Key for at least three seconds to move from the operation level to the initial setting level.

Initial Setting Level



2. Select the Move to Advanced Function Setting Level parameter by pressing the Key. (For details on moving between levels, refer to 4-7 Moving to the Advanced Function Setting Level.)

Advanced Function Setting Level

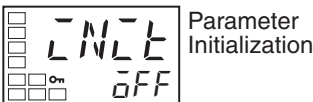

3. Press the Key to enter the password (-169) and move from the initial setting level to the advanced function setting level.

Advanced Function Setting Level



4. Press the Key to select the Alarm 1 ON Delay parameter.

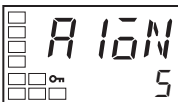

5. Press the Key to set the parameter to 5.

Advanced Function Setting Level



6. Press the Key to select the Alarm 1 OFF Delay parameter.

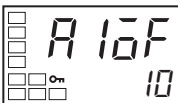

7. Press the Key to set the parameter to 10.

Initial Setting Level

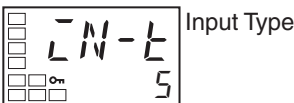

8. Press the Key for at least one second to move from the advanced function setting level to the initial setting level.

Operation Level



9. Press the  Key for at least one second to move from the initial setting level to the operation level.

## 4-11 Loop Burnout Alarm

### 4-11-1 Loop Burnout Alarm (LBA)

- The loop burnout alarm can be used only with standard models.
- With a loop burnout alarm, there is assumed to be an error in the control loop if the control deviation ( $SP - PV$ ) is greater than the threshold set in the LBA Level parameter and if the control deviation is not reduced by at least the value set in the LBA Detection Band parameter within the LBA detection time.
- Loop burnout alarms are detected at the following times.

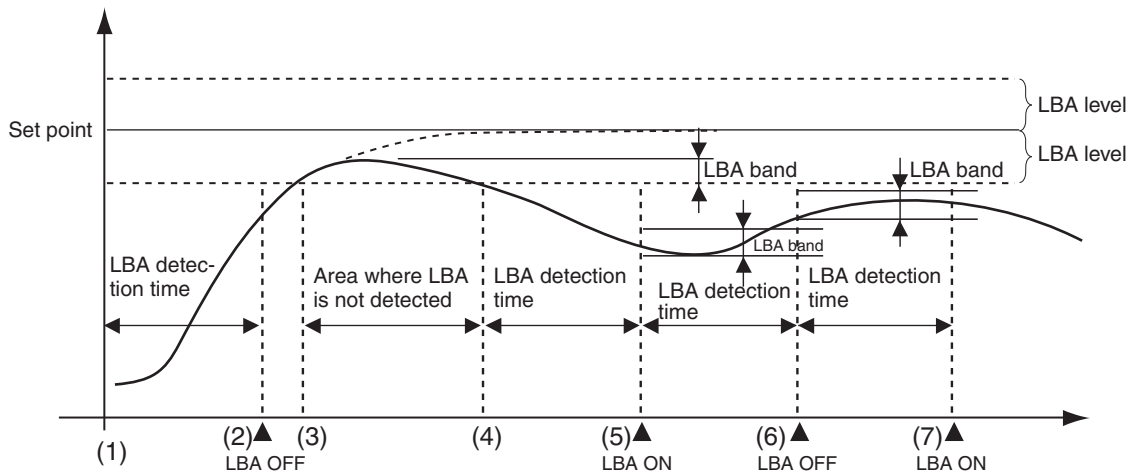

If the control deviation is reduced in the area between 1 and 2 (i.e., the set point is approached) and the amount the control deviation is reduced is at least equal to the LBA band, the loop burnout alarm will remain OFF.

The process value is within the LBA level between 3 and 4, and thus loop burnout alarms will not be detected. (The loop burnout alarm will remain OFF.)

If the process value is outside the LBA level between 4 and 5 and the control deviation is not reduced by at least the LBA band within the LBA detection time, the loop burnout alarm will turn ON.

If the control deviation is reduced in the area between 5 and 6 (i.e., the set point is approached) and the amount the control deviation is reduced is at least equal to the LBA band, the loop burnout alarm will turn OFF.

If the control deviation is reduced in the area between 6 and 7 (i.e., the set point is approached) and the amount the control deviation is reduced is less than the LBA band, the loop burnout alarm will turn ON.

- If the LBA detection time, LBA level, LBA detection band, and PID settings are not appropriate, alarms may be detected inappropriately or alarms may not be output when necessary.
- Loop burnout alarms may be detected if unexpectedly large disturbances occur continuously and a large deviation does not decrease.



- If a loop burnout occurs when the set point is near the ambient temperature, the temperature deviation in a steady state may be less than the LBA level, preventing detection of the loop burnout.
- If the set point is so high or low that it cannot be reached even with a saturated manipulated variable, a temperature deviation may remain even in a steady state and a loop burnout may be detected.
- Detection is not possible if a fault occurs that causes an increase in temperature while control is being applied to increase the temperature (e.g., an SSR short-circuit fault).
- Detection is not possible if a fault occurs that causes a decrease in temperature while control is being applied to decrease the temperature (e.g., a heater burnout fault).

**Parameters Related to Loop Burnout Alarms**

Parameter name	Symbol	Setting range		Remarks
PID* LBA Detection Time (*: 1 to 8)	<i>*LbR</i>	0 to 9999 (s)		Setting 0 disables the LBA function.
LBA Detection Time	<i>LbR</i>			
LBA Level	<i>LbRL</i>	Controllers with temperature inputs	0.1 to 3,240.0 (°C/°F) (See note.)	Default: 8.0 (°C/°F)
		Controllers with analog inputs	0.01 to 99.99 (%FS)	Default: 10.00% FS
LBA Band	<i>LbRb</i>	Controllers with temperature inputs	0.0 to 3,240.0 (°C/°F) (See note.)	Default: 3.0 (°C/°F)
		Controllers with analog inputs	0.00 to 99.99 (%FS)	Default: 0.20% FS

**Note** Set “None” as the unit for analog inputs.

- A loop burnout alarm can be output by setting the alarm 1 type to 12 (LBA).
- A setting of 12 (LBA) can be set for alarm 2 or alarm 3, but the setting will be disabled.
- Loop burnout alarms are not detected for ramp program segments.
- Loop burnouts are not detected during auto-tuning or manual operation.
- If the Reset Operation parameter is set to stop control, loop burnout alarms are not detected during reset or standby status.
- If the alarm 1 latch is set to ON, the latch will be effective for the loop burnout alarm.
- Loop burnout alarms are not detected when using a remote SP.

**Automatically Setting the LBA Detection Time**

- Automatic setting is not possible for ON/OFF control. Set the LBA Detection Time parameter in the advanced function setting level.
- When PID control is being used, the LBA detection time can be set individually for each PID set. First select the PID set number in the Display PID Selection parameter (PID setting level), and then set the time in the LBA Detection Time parameter.
- The LBA detection time is automatically set by auto-tuning, and the execution results are saved in the PID set when auto-tuning is started. (The results are not set automatically, however, for heating/cooling control.)
- If the optimum LBA detection time is not obtained by auto-tuning, set the LBA Detection Time parameter (PID setting level).

**Determining the LBA Detection Time**

1,2,3...

- To manually set the LBA detection time, set the LBA Detection Time parameter to twice the LBA reference time given below.

- Set the output to the maximum value.
- Measure the time required for the width of change in the input to reach the LBA band.

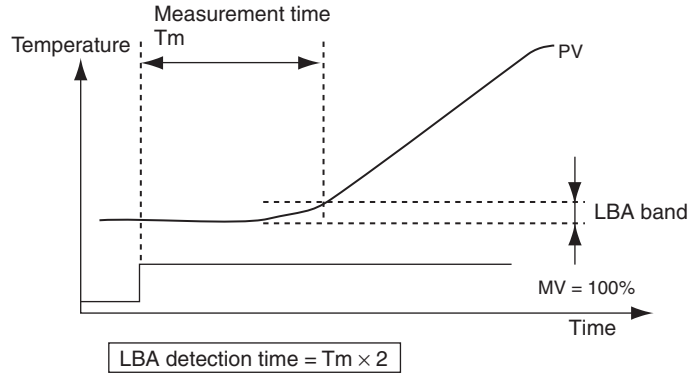

- Set the LBA Detection Time parameter to two times the measured time.

**LBA Level**

- Set the control deviation when the control loop is working properly.
- The default is 8.0 (°C/°F) for a temperature input and 10.00% FS for an analog input.

**LBA Band**

- There is assumed to be an error in the control loop if the control deviation is greater than the threshold set in the LBA Level parameter and if the control deviation does not change by at least the value set in the LBA Band parameter.
- The default is 3.0 (°C/°F) for a temperature input and 0.20% FS for an analog input.

**Operating Procedure**

Perform the following procedure to use the loop burnout alarm. In this example, the LBA detection time is set to 10, the LBA level is set to 8.0, and the LBA band is set to 3.0.

Operation Level



Initial Setting Level

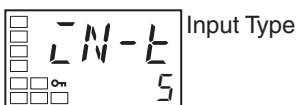

Initial Setting Level

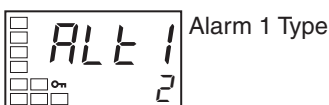

- Press the Key for at least three seconds to move from the operation level to the initial setting level.
- Select the Alarm 1 Type parameter by pressing the Key.

Initial Setting Level



3. Press the Key to set the parameter to 12.  
To return to the operation level, press the Key for at least one second.

Operation Level



4. Press the Key to move from the operation level to the PID setting level.

PID Setting Level

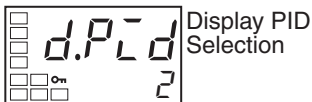

5. The current PID set number will be displayed. Press the or Key to select PID set 2.

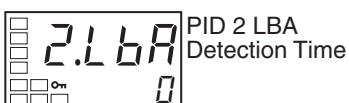

6. Press the Key to select the PID 2 LBA Detection Time parameter.

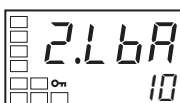

7. Press the Key to set the parameter to 10.

Initial Setting Level

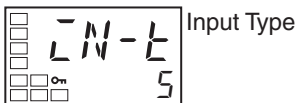

8. Press the Key for at least three seconds to move to the initial setting level.



9. Select the Move to Advanced Function Setting Level parameter by pressing the Key. (For details on moving between levels, refer to 4-7 Moving to the Advanced Function Setting Level.)

Advanced Function Setting Level

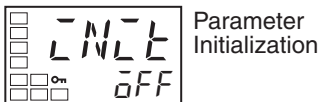

10. Press the Key to enter the password (-169), and move from the initial setting level to the advanced function setting level.

Advanced Function Setting Level

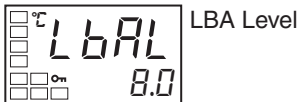

11. Select the LBA Level parameter by pressing the Key.

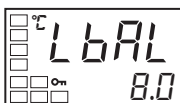

12. Press the Key to set the parameter to 8.0. (The default is 8.0.)

Advanced Function Setting Level

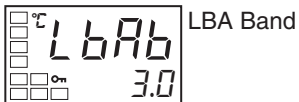

13. Select the LBA Band parameter by pressing the Key.

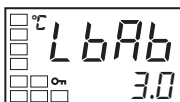

14. Press the or Key to set the parameter to 3.0. (The default is 3.0.)

Initial Setting Level

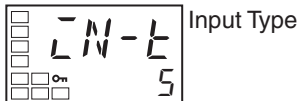

15. Press the Key for at least one second to move from the advanced function setting level to the initial setting level.

Operation Level



16. Press the Key for at least one second to move from the initial setting level to the operation level.

## 4-12 Performing Manual Control

### 4-12-1 Manual Operation

- With standard models, the MV is manipulated directly. With position-proportional models, the MV is manipulated through the amount of valve opening or by parameter settings.
- The manipulated variable can be set in manual mode if the PV/MV parameter is displayed in the manual control level. The final MV used in automatic mode will be used as the initial manual MV when moving from automatic mode to manual mode. In manual mode, the change value will be saved immediately and reflected in the actual MV.
- Manual operation can be used only for PID control.
- The automatic display return function will not operate in manual mode.
- Balanceless-bumpless operation will be performed for the MV when switching from manual operation to automatic operation. (See note.)
- If a power interruption occurs during manual operation, manual operation will be restarted when power is restored using the same MV as when power was interrupted.
- Switching between automatic and manual operation is possible for a maximum of one million times.

#### Standard Models

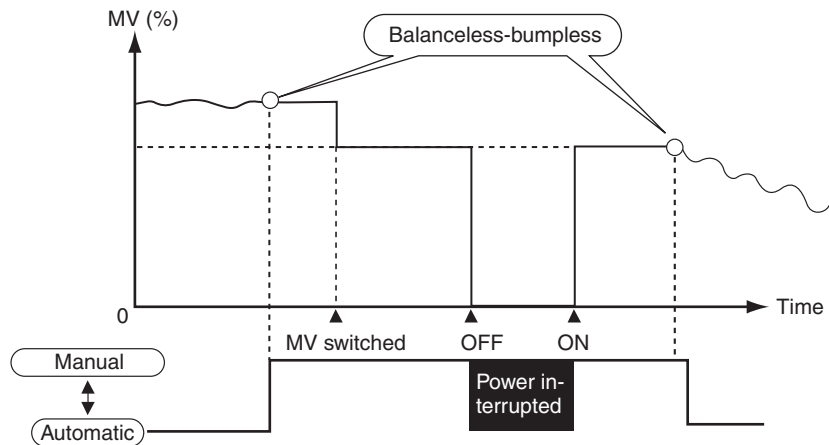

The overall manual operation is illustrated in the following figure.



#### Position-proportional Models

When floating control is used or when the Direct Setting of Position Proportional MV parameter is set to OFF:

- The Valve Opening Monitor will be displayed

- Pressing the  Key turns ON the open output, and pressing the  Key turns ON the close output.
- The automatic display return function will not operate in manual mode.
- Balanceless-bumpless operation will be performed for the MV when switching between manual and automatic operation. (See note.)
- Switching between manual and automatic operation is possible for a maximum of one million times.

When close control is used or when the Direct Setting of Position Proportional MV parameter is set to ON:

- Just as with standard models, the MV is set numerically.
- The automatic display return function will not operate in manual mode.
- Balanceless-bumpless operation will be performed for the MV when switching between manual and automatic operation. (See note.)

**Note** In balanceless-bumpless operation, the MV before switching is used initially after the switch and then gradually changed to achieve the proper value after switch to prevent radical changes in the MV after switching operation.

- If a power interruption occurs during manual operation, manual operation will be restarted when power is restored using the same MV as when power was interrupted.
- Switching between manual and automatic operation is possible for a maximum of one million times.
- Operation will be as described below if a potentiometer input error occurs.

When the Manual MV Limit Enable Parameter Is Set to OFF:

Manual MV ≥ 100                      Open output: ON  
 Manual MV ≤ 0                        Close output: ON

If the manual MV is other than the above, the open and close outputs will both be OFF.

When the Manual MV Limit Enable Parameter Is Set to ON:

Manual MV = MV upper limit        Open output: ON  
 Manual MV = MV lower limit        Close output: ON

If the manual MV is other than the above, the open and close outputs will both be OFF.

### Related Displays and Parameters

Parameter name	Symbol	Level	Remarks
PV/MV (Manual MV)	---	Manual Control Level	Changes the manual MV. Standard: -5.0 to 105.0 (See note 2.) Heating/cooling: -105.0 to 105.0 (See note 2.) Position-proportional: -5.0 to 105.0 (See notes 2 and 3.)
Direct Setting of Position Proportional MV	$PMV_d$	Advanced Function Setting Level	Selects the method for specifying each MV for manual operation, when stopping, or when an error occurs. OFF: All open, hold, all closed ON: -5.0 to 105%
Auto/Manual Switch	$R-M$	Operation Level	Switches between automatic and manual modes.
Auto/Manual Select Addition	$RMA_d$	Advanced Function Setting Level	Enables switching between automatic and manual modes.



- Note**
- (1) Refer to 4-16 Output Adjustment Functions for information on the priority for the MV.
  - (2) For Manual MV Limit Enable, this value will be between the MV lower limit and the MV upper limit.
  - (3) This setting is enabled only when the Direct Setting of Position Proportional MV parameter is set to ON.

**Manual MV Limit Enable (MANL)**

When the Manual MV Limit Enable parameter is set to ON (enabled), the MV limits will function and the setting range for the Manual MV parameter will be between the MV upper limit and the MV lower limit. When the parameter is set to OFF (disabled), MV limits will not function.

Parameter name	Setting range	Default
Manual MV Limit Enable	OFF: Disabled, ON: Enabled	OFF

**Moving from the Operation Level to the Manual Control Level**

- When the  Key is pressed for at least 3 seconds in the operation level's auto/manual switching display, the manual mode will be entered and the manual control level will be displayed. It is not possible to move to any displays except for the PV/MV parameter during manual operation. Press the  Key for at least one second from the PV/MV parameter display in manual control level to return to automatic mode and display the top parameter in the operation level.

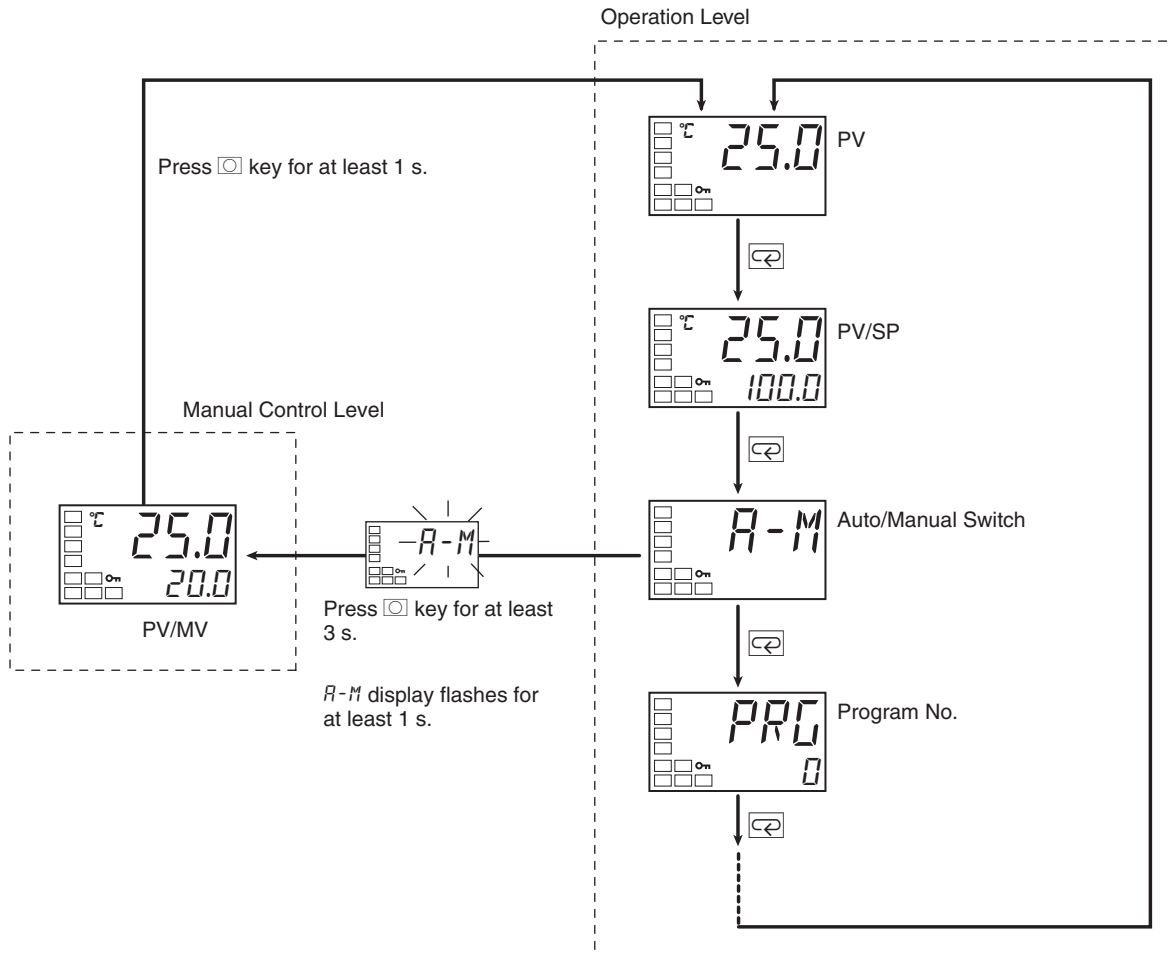

**Using the PF Key to Move to the Manual Control Level**

- If an event input is set to MANU (auto/manual), the Auto/Manual Switch parameter will not be displayed. Use the event input to switch between automatic and manual modes.

**Auto/Manual Select Addition (AMAd)**

- If the PF Setting parameter is set to A-M (auto/manual), you can change to manual operation (manual control level) by pressing the PF Key for at least one second from the adjustment level, operation level, program setting level, or PID setting level. During manual operation it is not possible to move to any displays other than PV/MV (Manual MV). Press the PF Key for at least one second from the PV/MV display in the manual control mode to change the mode to automatic mode, move to the operation level, and display the top parameter in the operation level.
- When MANU (Auto/Manual) is selected for an event input, the Auto/Manual Switch parameter is not displayed. In that case, switching between auto and manual mode is executed by using an event input.
- The Auto/Manual Select Addition parameter must be set to ON in the advanced function setting level before it is possible to move to manual mode. The default is  $\bar{O}N$ .

**Note**

- (1) Priority of Manual MV and Other Functions  
Even when the program is in reset status, the manual MV is given priority. Auto-tuning will stop if you change to manual operation.
- (2) Manual Operation and Program Operation  
Timing will continue when you switch to manual operation during program operation.

**Operating Procedure**

Use the following procedure to set the manipulated variable in manual mode.

Operation Level



Initial Setting Level

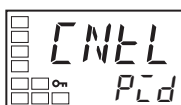
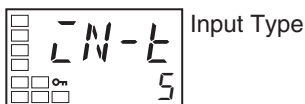

Initial Setting Level



Advanced Function Setting Level

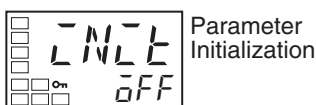

1. Press the Key for at least three seconds to move from the operation level to the initial setting level.
2. Select the PID ON/OFF parameter by pressing the Key. (The default is PID.)
3. Select the Move to Advanced Function Setting Level parameter by pressing the Key. (For details on moving between levels, refer to 4-7 Moving to the Advanced Function Setting Level.)
4. Press the Key to enter the password (-169), and move from the initial setting level to the advanced function setting level.

Advanced Function Setting Level

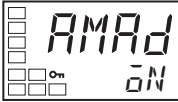

Auto/Manual  
Select Addition

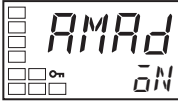

Initial Setting Level

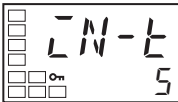

Input Type

Operation Level

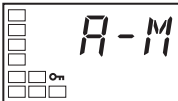

Auto/Manual  
Switch

Manual Control Level

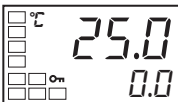

PV/MV

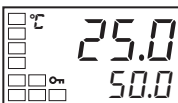

Operation Level

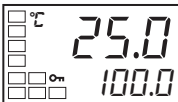

ALM

### Operating Procedure

5. Select the Auto/Manual Select Addition parameter by pressing the Key.
6. Use the Key to set the parameter to ON. (The default is ON.)
7. Press the Key for at least one second to move from the advanced function setting level to the initial setting level.
8. Press the Key for at least one second to move from the initial setting level to the operation level.
9. Select the Auto/Manual Switch parameter by pressing the Key.
10. Press the Key for at least three seconds to move from the operation level to the manual control level.
11. Press the or Key to set the manual MV. (In this example, the MV is set to 500%.)
- Note** The manual MV setting must be saved (see page 15), but values changed with Key operations are reflected in the control output immediately.
12. Press the Key for at least one second to move from the manual control level to the operation level.

In this example, A-M (Auto/Manual) is set for the PF Setting parameter (E5AN/EN-HT only).

Operation Level

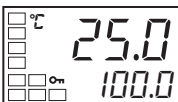

ALM

Initial Setting Level

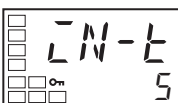

Input Type

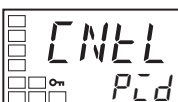

1. Press the Key for at least three seconds to move from the operation level to the initial setting level.
2. Select the PID ON/OFF parameter by pressing the Key. (The default is PID.)



Initial Setting Level



Move to Advanced Function Setting Level

3. Select the Move to Advanced Function Setting Level parameter by pressing the Key. (For details on moving between levels, refer to 4-7 Moving to the Advanced Function Setting Level.)

Advanced Function Setting Level

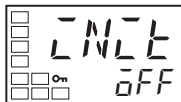

Parameter Initialization

4. Press the Key to enter the password (-169), and move from the initial setting level to the advanced function setting level.

Advanced Function Setting Level



Auto/Manual Select Addition

5. Select the Auto/Manual Select Addition parameter by pressing the Key.



6. Use the Key to set the parameter to ON. (The default is ON.)

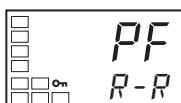

7. Press the Key to select the PF Setting parameter.

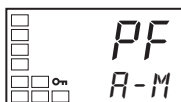

8. Press the Key to change the setting to A-M.

Initial Setting Level

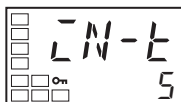

Input Type

9. Press the Key for at least one second to move from the advanced function setting level to the initial setting level.

10. Press the Key for at least one second to move from the initial setting level to the operation level.

Manual Control Level



PV/MV

11. Press the PF Key for at least one second to move from the operation level to the manual control level.

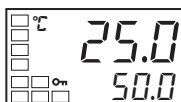

12. Press the or Key to set the manual MV. (In this example, the MV is set to 50.0%.)

**Note** The manual MV setting must be saved (see page 15), but values changed with key operations are reflected in the control output immediately.

Operation Level

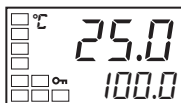

ALM

13. Press the PF Key to move from the manual control level to the operation level.

## 4-13 Using the Transfer Output

### 4-13-1 Transfer Output Function

- The transfer output function can be used by Controllers that support a transfer output (E5□N-HT□F). For Controllers that do not have a transfer output, a control output can be used as a simple transfer output if the control output is a current output or a linear voltage output.
- To use a transfer output, change the setting for the Transfer Type parameter to anything other than OFF. (This will enable the Transfer Output Upper Limit and Transfer Output Lower Limit parameters.)
- The operation differs for models with a transfer output and models without a transfer output for which control output 1 or control output 2 is used as a simple transfer output, as shown in the following table.

#### Transfer Output Destination

Transfer output	Control output 1	Control output 2	Transfer output destination
Yes	---	---	Transfer output
No	Current output or linear voltage output	None, relay output, voltage output (for driving SSR)	Control output 1
No	Current output or linear voltage output	Current output or linear voltage output	Control output 1
No	Relay output, voltage output (for driving SSR)	Current output or linear voltage output	Control output 2
No	Relay output, voltage output (for driving SSR)	None, relay output, voltage output (for driving SSR)	None

#### ■ Precision and User Calibration

	Precision	User calibration
Transfer output	±0.3% FS	Supported. (See note 1.)
Simple transfer output	±0.3% FS (See note 2.)	Not supported.

- Note**
- (1) For details on the calibration method, refer to *SECTION 6 CALIBRATION*.
  - (2) E5CN-HT only.

#### Transfer Output Type (LR-L)

Transfer output type	Symbol	Setting range
OFF (See note 1.)	OFF	---
Present SP	SP-M	SP lower limit to SP upper limit
PV	PV	Temperature input: Input setting range lower limit to input setting range upper limit Analog input: Scaling lower limit to scaling upper limit
MV monitor (heating) (See note 4.)	MV	-5.0 to 105.0 (heating/cooling control: 0.0 to 105.0) (See note 2.)
MV monitor (cooling) (See note 5.)	L-MV	0.0 to 105.0 (See note 2.)
Valve opening (See note 6.)	V-M	-10.0 to 110.0

- Note**
- (1) The default is OFF. For a Controller that does not support a transfer output, the item specified for the Control Output 1 Assignment or Control Output 2 Assignment parameter will be output.

- (2) The output value will be different between when the Transfer Output Type parameter is set to a heating control output or cooling control output, and when the Control Output 1 Assignment or Control Output 2 Assignment parameter is set to a heating control output or cooling control output.

Example: When a Current Output Is Set to 4 to 20 mA and MV Monitor (Heating) Is Selected

When used as a transfer output, 4.0 mA will be output for 0% and 20.0 mA will be output for 100%.

When used as a control output, 3.7 mA will be output for 0% and 20.3 mA will be output for 100% so that the actuator is controlled at 0% or 100%.

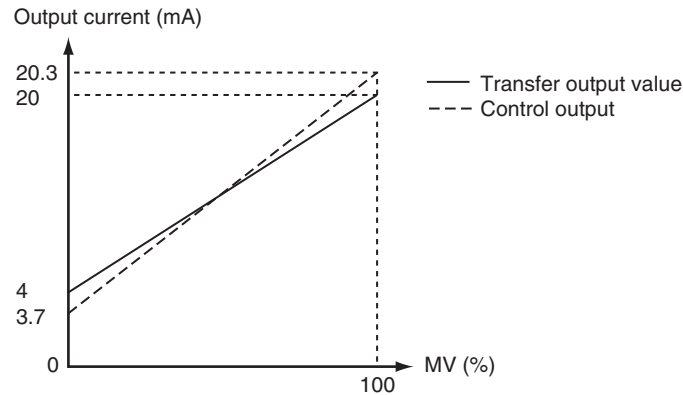

(The above graph is for when the linear current output is set to 4 to 20 mA.)

- (3) When the present SP is selected, the remote SP will be output while the Remote SP Mode is set in the SP Mode parameter. If the Fixed SP Mode is set, the fixed SP will be output. If the Program SP Mode is set, the program SP will be output.
- (4) This setting will be ignored for position-proportional models.
- (5) This setting will be ignored for standard control or for position-proportional models.
- (6) Displayed for position-proportional models only when there is a potentiometer input.

## Transfer Scaling

- Reverse scaling is possible by setting the Transfer Output Lower Limit parameter ( $\text{LR-L}$ ) larger than the Transfer Output Upper Limit parameter ( $\text{LR-H}$ ). If the Transfer Output Lower Limit and Transfer Output Upper Limit parameters are set to the same value when 4 to 20 mA is set, the transfer output will be output continuously at 0% (4 mA).
- If the present SP, or PV is selected, the Transfer Output Lower Limit and Transfer Output Upper Limit parameters will be forcibly initialized to the respective upper and lower setting limits for changes in the upper and lower limits of the SP limiter and the temperature unit.  
If the MV for heating or MV for cooling is selected, the Transfer Output Lower Limit and Transfer Output Upper Limit parameters will be initialized to 100.0 and 0.0, respectively, when a switch is made between standard control and heating/cooling control using the Standard or Heating/Cooling parameter.
- The output current when the linear current type is set to 4 to 20 mA, the transfer output upper limit is set to 90.0, and the transfer output lower limit is set to 10.0 is shown in the following graph.

- For scaling from 0.0% to 100.0%, the output for -5.0 to 0.0 will be the same value as for 0.0%, and the output for 100.0 to 105.0 will be the same value as for 100.0%

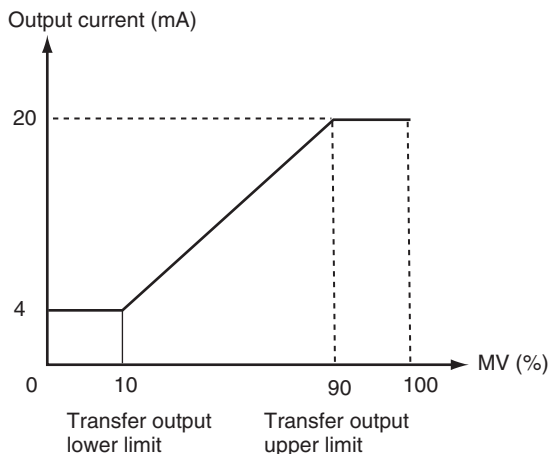

(The above graph is for when the linear current output is set to 4 to 20 mA.)

**Operating Procedure**

The following procedure sets the transfer output for a present SP range of -50 to 200.

Operation Level



Initial Setting Level

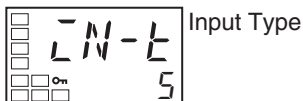

Initial Setting Level

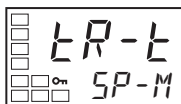
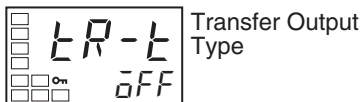

Initial Setting Level

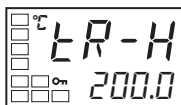



1. Press the Key for at least three seconds to move from the operation level to the initial setting level.
2. Select the Transfer Output Type parameter by pressing the Key.
3. Press the Key to select SP-M (set point).
4. Select the Transfer Output Upper Limit parameter by pressing the Key.
5. Use the Key to set the parameter to 200.0. The default is 1300.0.

Initial Setting Level

Transfer Output  
Lower Limit

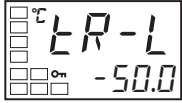
6. Select the Transfer Output Lower Limit parameter by pressing the  Key.



7. Use the  Key to set the parameter to -50.0. The default is -200.0.

Operation Level



PV/SP

8. To return to the operation level, press the  Key for at least one second.

## 4-14 Using PID Sets

### PID Sets



- The PID set to be executed is selected by using the PID Set No. parameter in the program setting level. If 0 (Automatic selection) is set, then the PID set will be selected automatically according to preset conditions.
- Up to eight of the following parameters can be registered for each PID set.

Parameter	Setting range	Default	Unit
Proportional Band ( $P$ )	Temperature: 0.1 to 3,240.0	8.0	°C or °F
	Analog: 0.1 to 999.9	10.0	%FS
Integral Time ( $I$ )	Standard, heating/cooling, position proportional (closed): 0.0 to 3,240.0 Position proportional (float- ing): 0.1 to 3,240.0	233.0	s
Derivative Time ( $D$ )	0.0 to 3240.0	40.0	s
MV Upper Limit ( $\bar{u}L - H$ )	Standard: MV lower limit + 0.1 to 105.0 Heating/cooling: 0.0 to 105.0	105.0	%
	Position proportional (closed): MV lower limit + 0.1 to 105.0		
MV Lower Limit ( $\bar{u}L - L$ )	Standard: -5.0 to MV upper limit -0.1	-5.0	%
	Heating/cooling: -105.0 to 0.0	-105.0	
	Position proportional (closed): -5.0 to MV upper limit -0.1	-5.0	
Automatic Selection Range Upper Limit (* $RLU$ )	Temperature: -19,999 to 32,400	1320.0	EU
	Analog: -5.0 to 105.0	105.0	% (See note.)
Cooling Coefficient ( $E - 5E$ )	0.01 to 99.99	1.00	None
LBA Detection Time ( $LbR$ )	0 to 9,999 (0: LBA function disabled)	0	s

**Note** When the PID Automatic Selection Data parameter is set to DV, the unit will be %FS.

The settings for the PID sets are made in the PID setting level. In the PID setting level, select the PID set numbers to be edited with the Display PID Selection parameter, and make the settings for each PID set.

Parameter	Setting range	Unit	Default
Display PID Selection ( $d.P.L.d$ )	1 to 8	---	See note.

**Note** The current PID set is displayed. If you use the  and  Keys to change the PID set, the monitor function will be canceled

When the following parameters are changed, the changes will be reflected in the current PID set:

- Proportional Band, Integral Time, Derivative Time, MV Upper Limit, MV Lower Limit, Cooling Coefficient (adjustment level)
- LBA Detection Time (advanced function setting level)

Automatic PID Set Selection

- If the PID Set No. parameter for a program is set to 0, the PID set will be selected automatically according to preset conditions.

PID set	Automatic selection range
1	200.0
2	400.0
3	500.0
4	600.0
5	700.0
6	800.0
7	1000.0
8	1300.0

PV: 240.0 (upper limit)

In the setting example on the left (with the PID Set Automatic Selection Data parameter set to PV), the following PID parameters are used:

PV ≤ 200°C: PID Set No. 1

200°C < PV ≤ 400°C: PID Set No. 2

Set the PID Set Automatic Selection Range Upper Limit so that the set value becomes larger as the PID set number increases. For PID Set No. 8, however, the automatic selection range upper limit always equals the upper limit of the specified range.

The PID Set Automatic Selection Hysteresis parameter can be used to set the hysteresis to prevent chattering when changing the PID set.

The PID Set Automatic Selection Data parameter can be used to select PV, DV (Derivative), or SP.

Parameter	Setting range	Unit	Default
PID Set No. ( $P_{Ld}$ )	0: Automatic selection 1 to 7: PID Set No. 1 to 7	---	1
PID *Automatic Selection Range Upper Limit *: 1 to 8 ( $*RUL$ )	Temperature: -19,999 to 32,400	1320.0	EU
	Analog: -5.0 to 105.0	105.0	% (See note.)
PID Set Automatic Setting Data ( $P_{LdL}$ )	PV: Process value DV: Derivative value SP: Set point	PV	None
PID Set Automatic Hysteresis ( $P_{LdH}$ )	0.10 to 99.99	0.50	%FS

**Note** When the PID Set Automatic Hysteresis parameter is set to DV, the default setting becomes %FS.

## 4-15 Program-related Functions

### 4-15-1 Ramp Rate Programming

- The following program parameters must be set if the Step Time/Ramp Rate Programming parameter is set to Ramp Rate Programming: Segment Type, Segment Set Point, Segment Ramp Rate, and Segment Time. To use Ramp Rate programming, set the Step Time/Ramp Rate Programming parameter to Ramp Rate Programming.

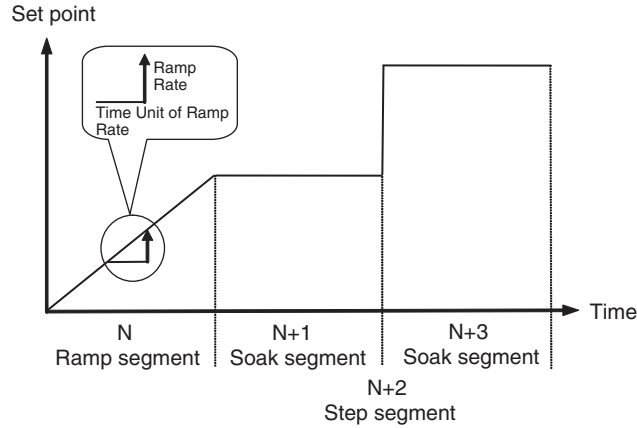

- You can select Ramp, Soak, or Step for the Segment Type parameter. The parameters that must be set according to the setting of the Segment Type parameter are listed in the following table.

Parameter	Segment Type			Setting range	Unit	Default
	Ramp	Soak	Step			
Segment Set Point (SP)	Yes	---	Yes	Set Point Lower Limit to Set Point Upper Limit	EU	0.0
Segment Ramp Rate (PR)	Yes	---	---	0 (see note.) to 32,400	Time Unit of Ramp Rate	0.0
Segment Time (ELME)	---	Yes	---	0.00 to 99.59	Program time unit	0.00

**Note** If the Segment Ramp Rate parameter is set to 0, the segment will be a step segment.

#### Reset Operation = Stop Control

Program operation is started from the PV. To start operation from a specific SP, set the Segment Type parameter to Step.

A setting example is shown below. The Time Unit of Ramp Rate parameter is set to minutes.

Segment No.	0	1	2
Segment Type	Ramp	Soak	Ramp
Segment Set Point	100.0	---	50.0
Segment Rate of Rise	4.0	---	2.5
Segment Time (h.min)	---	0.40	---



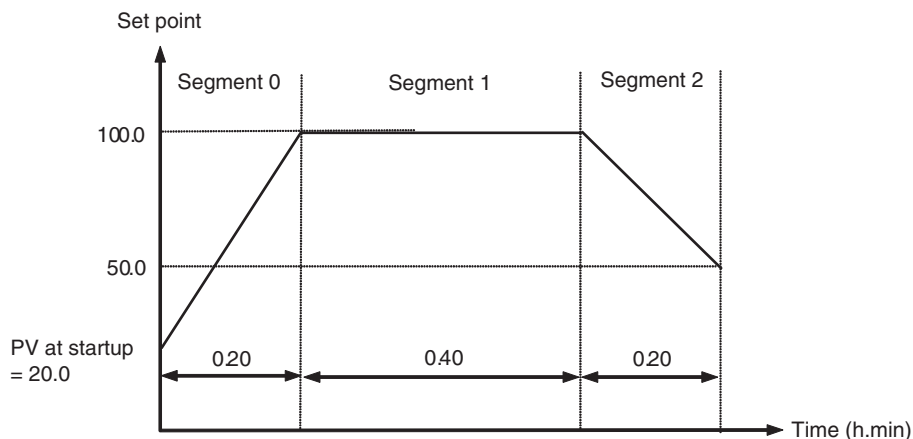

- If there is an input error when operation starts and the segment type of segment 0 is set to ramp or step, the program will start from the SP of segment 0. If the segment type of segment 0 is soak, reset status will be entered.

**Reset Operation = Fixed SP Operation**

Program operation will start from the fixed SP (FSP) or remote SP (RSP). A setting example is shown below. The Time Unit of Ramp Rate parameter is set to minutes.

Segment No.	0	1	2
Segment Type (SP)	Ramp	Soak	Ramp
Segment Set Point (SP)	100.0	---	50.0
Segment Rate of Rise (PR)	4.0	---	2.5
Segment Time (h.min) (LME)	---	0.40	---

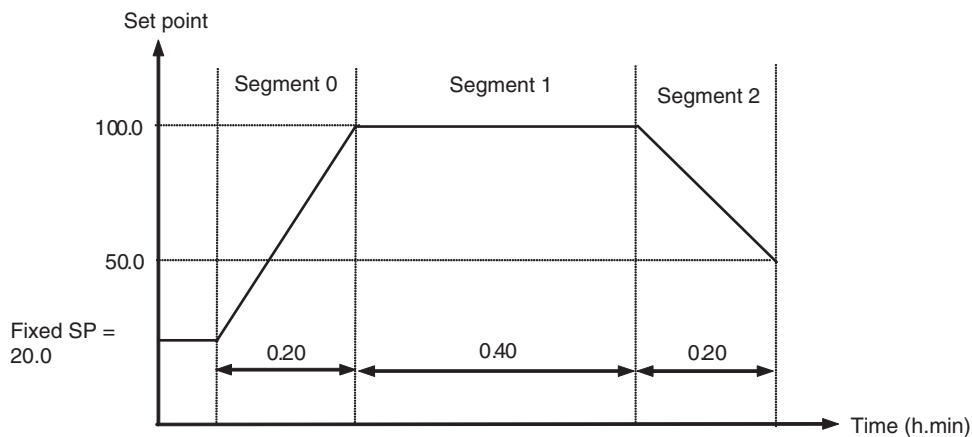

- If the SP Mode parameter is set to Remote SP Mode, there is an RSP input error when operation starts, and the segment type of segment 0 is set to ramp or step, the program will start from the SP of segment 0. If the segment type of segment 0 is soak, reset status will be entered.

**Changing Parameters**

- If the rate of rise is changed during a segment, both the slope of the present SP and the segment time for the ramp period will change.

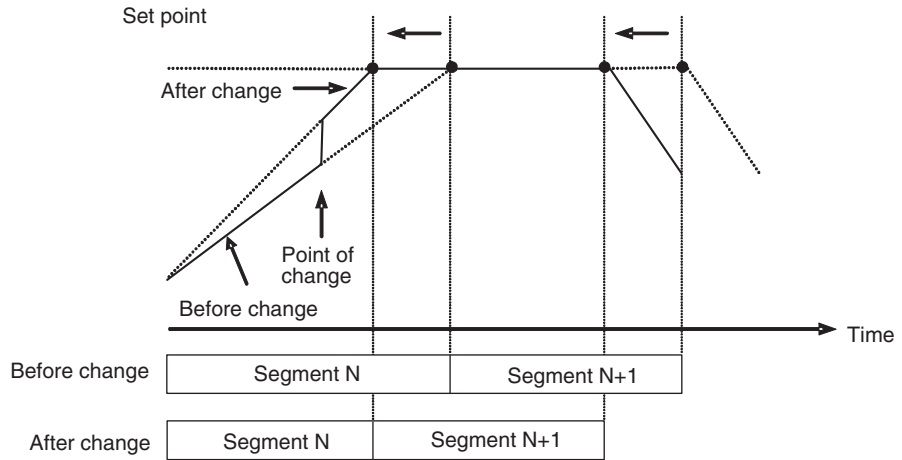

- If the SP is changed during a segment, the segment time for the ramp period will change.
- If the time is changed during a segment, the segment time for the soak period will change.

**Note** If using program link or program repeat, do not change the target value while in the final segment. If changed, exercise caution as the program will start from the segment target value before the change.

**4-15-2 Controlling the Program**

**Advance (*Adv*)**

- An advance operation moves the program to the start of the next segment.
- An advance operation moves the program forward to the end of the present segment each time the Advance parameter is set to ON. The Advance parameter turns OFF after the next segment has been reached.
- The advance operation cannot be used during reset status, during standby status, during auto-tuning, and when the Operation End Operation parameter is set to Continue.

**Hold (*Hold*)**

- A hold operation stops the program that is being executed.
- The timer is stopped when the Hold parameter is set to ON and restarts when the Hold parameter is set to OFF.
- The hold status is cleared under the following conditions: The Hold parameter is set to OFF (hold cleared), the Run/Reset parameter is changed (to Run or to Reset), or the program operation is completed as a result of an advance operation.
- If an advance operation is executed during a hold, the hold is continued from the beginning of the next segment.
- The hold operation cannot be used during reset status, during standby status, during auto-tuning, and when the Operation End Operation parameter is set to Continue.
- During hold status, *Hold* will alternate with the normal value on the No. 2 display if the PV is displayed on the No. 1 display. The alternating display will stop when the hold status is cleared.

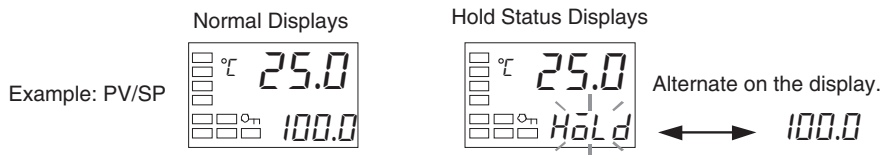

**Note** Priority of Flashing and Alternating Displays on No. 2 Display  
The priority for flashing and alternating displays is as follows:

1. Alternating display with SV status display
2. Alternating display during program end output/hold display
3. Auto-tuning flashing display
4. Alternating display for number of ON operations alarm for control outputs
5. Flashing display for out-of-range setting

**Program Repetitions (RPL)**

- Setting program repetitions automatically restarts execution of the same program from segment 0 after the final segment is executed. The Program Repetitions parameter can be set to up to 9,999.
- The number of executions will be the value set for the Program Repetitions parameter + 1.
- If the Program Repetitions parameter is changed to a smaller number during program operation, the currently executing program will be executed to the end and then the program will stop.

**Program Links (LINK)**

- A program link moves execution to segment 0 of the program number set for the Program Link Destination parameter. Operation will be ended if the Program Link Destination parameter is set to END.
- If a program repetition operation is also set, the program link will start after the program repetition operation has been completed.
- If the Program Link Destination parameter is set to the current program number, the program will be repeated endlessly.
- After all programs have been executed, operation will be according to the setting for the Operation End Operation parameter.

**4-15-3 SP Mode (SPMd)**

- With the E5□N-HT, there are three types of SPs that can be used: the program SP (PSP), fixed SP (FSP), and remote SP (RSP). (The remote SP is supported only by the E5AN-HT and E5EN-HT.)

**Changing the SP Mode**

- The following figure shows an example of changing between Program SP Mode and Fixed SP Mode during program operation.

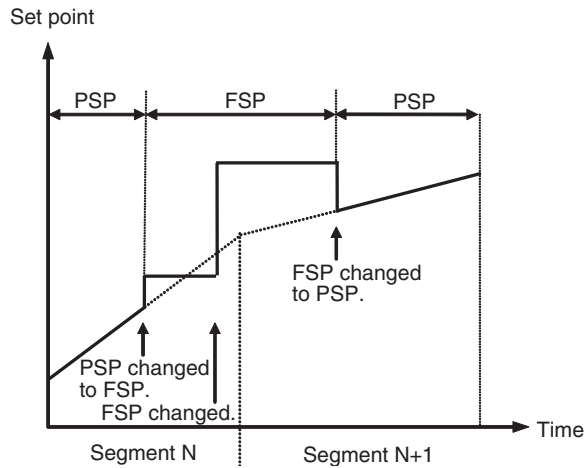

- A description of the operation is given below.
  - Segment N is changed from Program SP Mode to Fixed SP Mode.
  - The fixed SP is changed.
  - Operation is changed from Fixed SP Mode to Program SP Mode in segment N+1.
- The program will not start if the Reset Operation parameter is set to stop control and the setting of the Run/Reset parameter is changed to Run in Fixed SP or Remote SP Mode.

**SP Tracking (SPTR)**

- If the SP Tracking parameter is set to Enabled, the fixed SP is changed to the value of the current program SP or the current remote SP when the mode is changed from Program SP Mode or Remote SP Mode to Fixed SP Mode. Tracking is not performed when changing to the Program SP Mode or Remote SP Mode.
- The following figure shows SP tracking when the mode is changed from Program SP Mode to Fixed SP Mode.

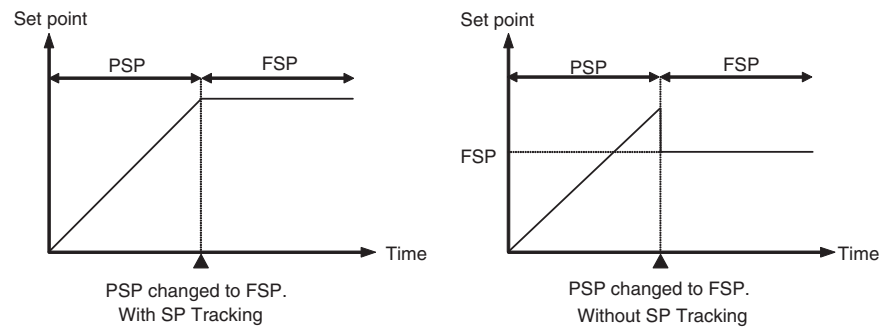

**4-15-4 Wait (Wt - b)**

- If, at the end of a program segment, the deviation between the PV and the present SP (program SP) is not within a preset range, the program can be set to not continue. This is called the wait operation. The preset range is called the wait band.

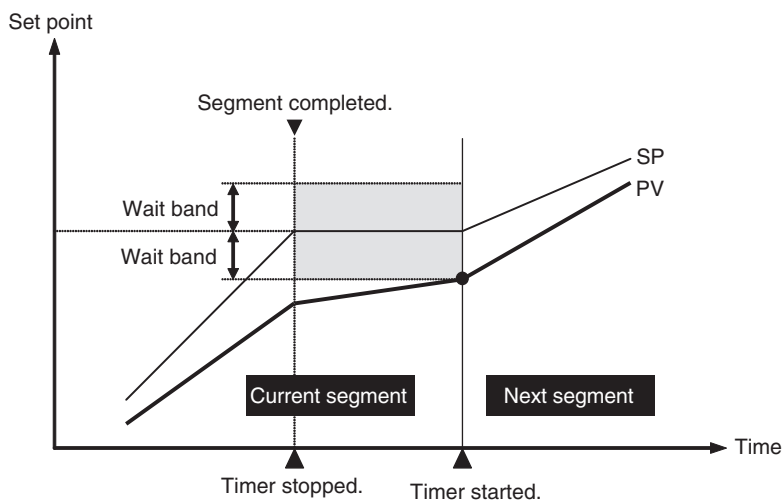

- As soon as the deviation enters the wait band, the program moves to the next segment.
- The wait operation is not performed if it is disabled by an event input.
- The wait operation is not performed if the wait band is set to OFF.

### 4-15-5 Time signals

- A time signal is assigned to an auxiliary output or control output.
- Up to two time signals can be set for each program.
- There are two timers for a time signal: an ON timer and an OFF timer. The timers start from the beginning of the segment.
- The output turns ON once the ON time has elapsed and turns OFF after the OFF time has elapsed.

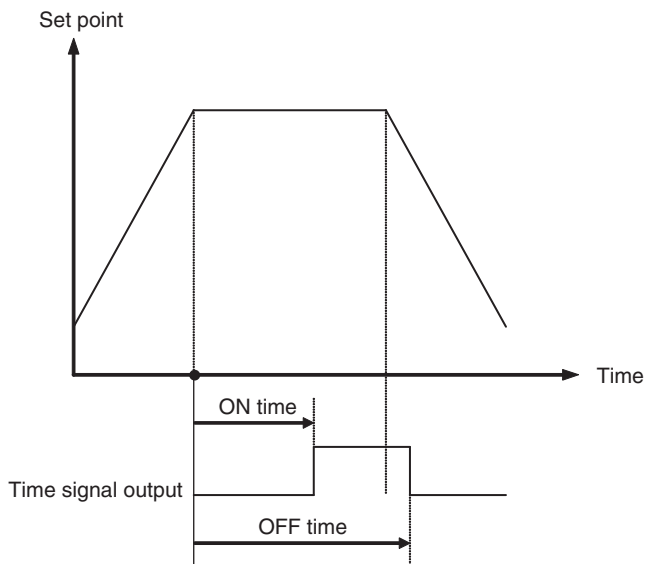

- The Time Signal 1/2 Set Segment parameters ( $tS15$ ) ( $tS25$ ) set the segments in which the time signals will start. The default is 0 (disabled).
- The ON/OFF timing is set using the Time Signal 1/2 ON Time parameters ( $\bar{a}N1$ ) ( $\bar{a}N2$ ) and Time Signal 1/2 OFF Time parameters ( $\bar{a}F1$ ) ( $\bar{a}F2$ ). The defaults are 0.00.
- ON Conditions

- If the OFF time is shorter than the ON time, the output remains ON from when the ON time has elapsed until the next OFF condition.
- If an advance operation is executed, a time equivalent to the set program time will be considered to have elapsed. For example, if an advance operation is executed before the ON time elapses in the above figure, the output remains ON from the start of the next segment until the OFF time has elapsed.
- The time signal is turned OFF under the following conditions:
  - In reset status
  - If one program execution has been completed when program repetitions or a program link has been set
  - If the Operation End Operation is set to fixed SP control and the program ends
  - If the ON and OFF times are the same
- The time signal timer stops during hold, wait, and auto-tuning operations.

## 4-15-6 Program Status Output

### Program End Output

- A program end output is assigned to an auxiliary output or control output. If the program end output is not assigned, *P.END* and the SP will be displayed alternately.
- The program end output occurs at the end of the last segment.

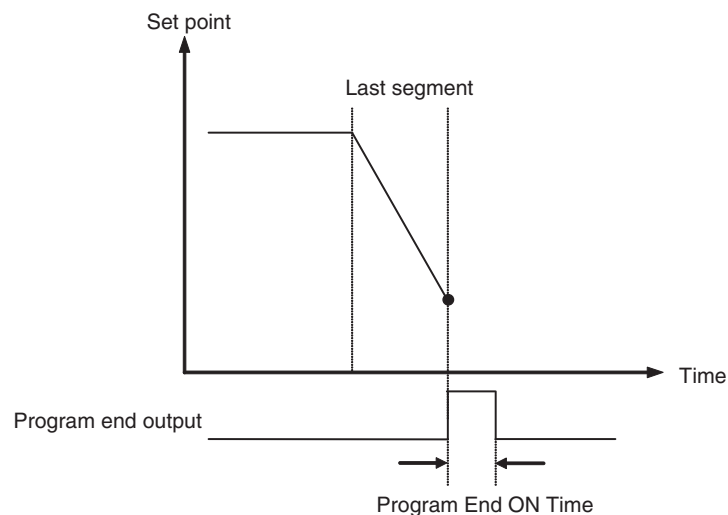

- The program end output occurs at the end of the last segment of the last program execution if program repetitions or a program link is set.
- The pulse width of the program end output is set using the Program End ON Time parameter. The setting range for the Program End ON Time parameter is 0.0 to 10.0 s. The default is 0.0.
- If the Program End ON Time parameter is set to ON, the output will remain ON until the Run/Reset parameter is changed to Run. If the Operation End Operation parameter is set to Reset and the power is reset or a software reset is executed while the program end output is ON, the program end output will turn OFF.

- The program end output is turned OFF if the Run/Reset parameter is changed to Run. If the Operation End Operation parameter is set to Fixed SP Control and the SP Mode is changed to Program SP Mode after the end of program operation, the program end output will turn OFF.
- If the power supply is turned OFF, a software reset is performed, or setup area 1 is entered while the program end output is ON, the program end output will turn OFF.
- Program End Displays  
At the end of the program, any time the PV is displayed on the No. 1 display\*1, the SP and P.END will be displayed alternately on the No. 2 display at a 1-s cycle.

**Note** This includes the PV/SP, PV only, and PV/MV displays.

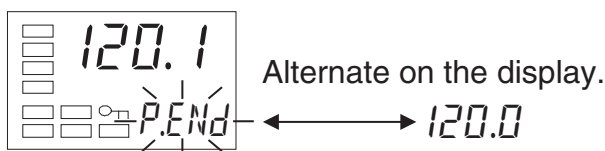

**Run Output**

- A program end output is assigned to an auxiliary output or control output.
- The run output is ON while the Run/Reset parameter is set to Run.

**Stage Output**

- A program end output is assigned to an auxiliary output or control output.
- A pulse is output for one second at the beginning of each segment.

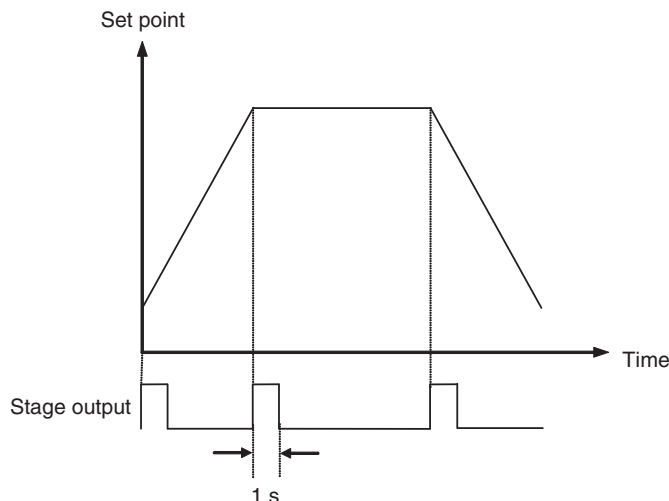

- If the power supply is turned OFF, a software reset is performed, or setup area 1 is entered while the stage output is ON, the stage output will turn OFF.

**4-15-7 Program Startup Operation**

**PV Start (PV St)**

- The method for starting program operation can be selected using the PV Start parameter: However, the starting method cannot be selected for rate of rise programming if the Reset Operation parameter is set to stop control.
- If program repetitions or a program link is set, the starting method set in the PV Start parameter operates only for the first program execution.

■ **SP Start**

Operation starts as programmed from the SP of segment 0. However, if the Reset Operation parameter is set to fixed SP operation, program operation will start with the fixed SP or remote SP.

■ **Slope-priority PV Start**

Program operation starts at the first SP that matches the PV from the start of operation. If the PV does not match any SP in the program, operation starts at the beginning of the program.

The following figure shows an example of the operation. The first position where the PV and the SP match is in segment 3. From there, the program is indicated by a bold line. The program prior to that position is ignored.

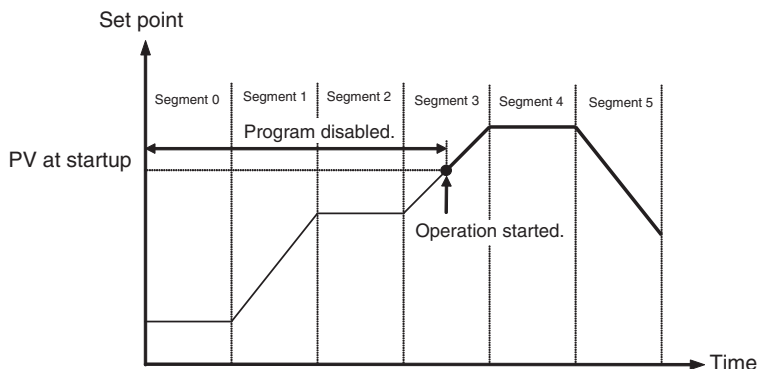

**Note** If segment 0 is a step segment in the gradient setting, the program pattern will be set from the SP at program startup to the step segment SP of segment 0. Therefore, if the PV at startup is between the SP (FSP or RSP) at program startup and the SP in the step segment, the program will start from the step segment SP of segment 0.

**Standby**

- When a standby operation is set, the program does not start operating until the standby time ( $S_{t_b}$ ) (set in h.min or days.h) has elapsed after the Run/Reset parameter is set to Run.
- The following conditions apply to operation during standby status:
  - The indicators and status displays will show run status.
  - If the Reset Operation parameter is set to stop control, the MV at reset will be output from the control output. If the Reset Operation parameter is set to fixed SP operation, the fixed SP or remote SP will be output.
  - Hold, advance, and auto-tuning operations cannot be used if the Reset Operation parameter is set to stop control. If auto-tuning is executed when the Reset Operation parameter is set to fixed SP operation, the remaining standby time during auto-tuning execution will be held.
  - If the power is interrupted during standby status, the remaining standby time is held (if the Startup Operation parameter is set to Continue or Manual and the program was running and with manual operation before the power was interrupted).



### 4-15-8 Operation End Operation (E5E4)

- The Operation End Operation parameter is used to select the operation after a program has been completed. The options are Reset, Continue, or Fixed SP Mode.

Setting of Operation End Operation	Description
Reset (R5E)	Ends operation.
Continue (E5NE)	Control is continued using the SP of the last segment. The final segment number is held and the elapsed program time is held. Hold and advance operations cannot be used. The time signals operate in the normal way. If the setting of the Number of Segments Used parameter is changed after operation is completed, there is no change to the operation end status but control will switch to using the SP of the last segment after the change.
Fixed SP Mode (F5P)	Operation is continued in Fixed SP Mode after the program is completed (run status). The segment number and elapsed program time return to the start and are held. Time signals are turned OFF before the end of program operation. If the SP Mode parameter is changed to Program SP Mode (PSP), the program will start again. If, however, the Reset Operation parameter is set to fixed SP control, Fixed SP Mode cannot be set.

### 4-15-9 Program SP Shift Value (P5P5)

The program SP will be compensated by the value set for the Program SP Shift Value.

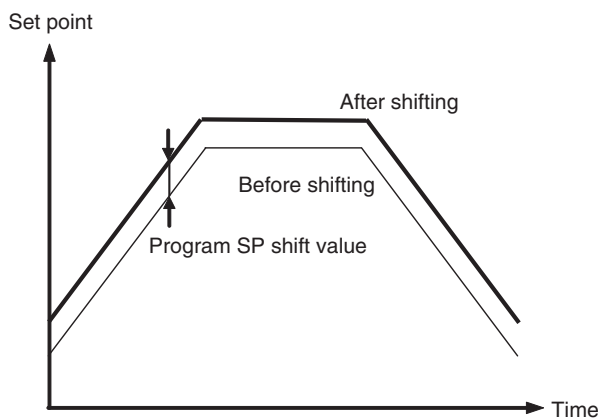

### Operations Related to Other Functions

- Manual Operation  
Timing will continue when you switch to manual operation during program operation.
- Input Errors  
Timing will continue if an input error occurs during program operation.
- RSP Input Errors  
Timing will continue if an RSP input error occurs during program operation.

- Potentiometer Input Errors  
Timing will continue if a potentiometer input error occurs during program operation.
- Setting Area 1  
If you move to setting area 1, program operation will stop, the control outputs will turn OFF, and the following outputs will turns OFF: time signal outputs, program end output, run output, and stage output.

## 4-16 Output Adjustment Functions

### 4-16-1 Output Limits ( $\bar{\alpha}L - H$ ) ( $\bar{\alpha}L - L$ )

- Output limits can be set to control the output using the upper and lower limits to the calculated MV.
- The following MV takes priority over the MV limits.  
Manual MV (See note.)  
MV at reset  
MV at PV error

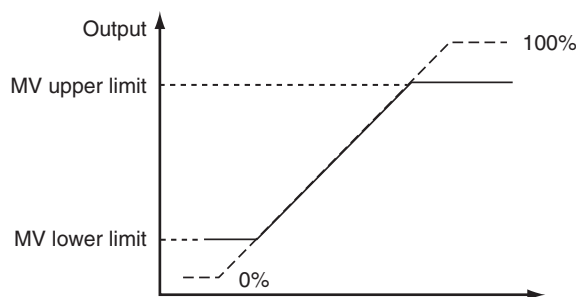

**Note** When the manual MV limit is enabled, the manual MV will be restricted by the MV limit.

- For heating/cooling control, upper and lower limits are set of overall heating/cooling control. (They cannot be set separately for heating/cooling.)

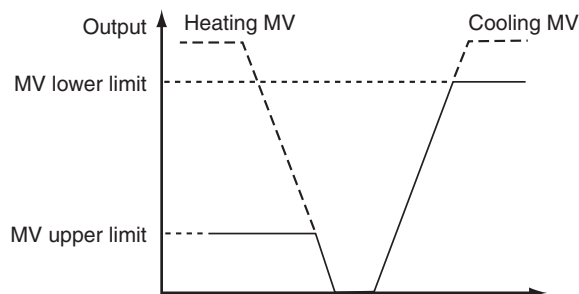

### 4-16-2 MV at Reset

The MV when control is stopped can be set. To set the MV at reset, set the MV at Reset and Error Addition parameter (advanced function setting level) to ON.

#### ■ Standard Models

For heating/cooling control, the MV at stop will apply to the cooling side if the MV is negative and to the heating side if the MV is positive. The default is 0.0, so an MV will not be output for either standard or heating/cooling control.

■ Position-proportional Models

Open, close, or hold status can be selected for floating control or when the Direct Setting of Position Proportional MV parameter is set to OFF. With open status, only the open output will turn ON. With close status, only the close output will turn ON. With hold status, the open and close outputs will both turn OFF. The default is for hold status, i.e., no outputs. With close status, only the close output will turn ON. With hold status, the open and close outputs will both turn OFF. The default setting is for hold status, with no outputs.

If the Direct Setting of Position Proportional MV parameter is set to ON during close control, the valve opening can be specified. The default setting is 0.0 (i.e., the open and close outputs are adjusted so that valve opening will be 0).

Parameter name	Setting range	Unit	Default
MV at Reset ( $MV - R$ )	-5.0 to 105.0 for standard control -105.0 to 105.0 (heating/cooling control)	% or none	0.0 or HOLD
	Position-proportional Control Close control and Direct Setting of Position Proportional MV parameter ON: -5.0 to 105.0 Floating control or Direct Setting of Position Proportional MV parameter OFF: CLOS (Control output 2 ON) HOLD (Control outputs 1 and 2 both OFF) OPEN (Control output 1 ON)		

**Note** The order of priority is as follows: Manual MV > MV at reset > MV at error.

- The following table shows the operation when a potentiometer error occurs when the Direct Setting of Position Proportional MV parameter is set to ON.

MV at reset ≥ 100	Open output ON
MV at reset ≤ 0	Close output ON

When the MV at reset is not one of the above values, the open and close outputs will both be OFF.

4-16-3 MV at PV Error

- A fixed MV is output for an input error, RSP input error, or potentiometer error (close control only). To set the MV at error, set the MV at Reset and Error Addition parameter (advanced function setting level) to ON. In reset status, the setting of the MV at Reset parameter takes priority. With manual operation, the manual MV takes priority.

■ Standard Models

With heating/cooling control, the MV on the cooling side is taken to be a negative value, so the output is made to the heating side for a positive value and to the cooling side for a negative value. The default setting is 0.0 (i.e., there are not outputs for either standard control or heating/cooling control).

■ Position-proportional Models

Open, close, or hold status can be selected for floating control or when the Direct Setting of Position Proportional MV parameter is set to OFF. With open status, only the open output will turn ON. With close status, only the close output will turn ON. With hold status, the open and close outputs will both turn OFF. The default is for hold status, i.e., no outputs. With close status, only the close output will turn ON. With hold status, the open and close outputs will both turn OFF. The default setting is for hold status, with no outputs.

If the Direct Setting of Position Proportional MV parameter is set to ON during close control, valve opening can be specified. The default setting is 0.0, so open and close outputs are adjusted so that valve opening will be 0.

Parameter name	Setting range	Unit	Default
MV at PV ERROR ( $MV - E$ )	-5.0 to 105.0 for standard control -105.0 to 105.0 (heating/cooling control)	% or none	0.0 or HOLD
	Position-proportional Control Close control and Direct Setting of Position Proportional MV parameter ON: -5.0 to 105.0 Floating control or Direct Setting of Position Proportional MV parameter OFF: CLOS (Control output 2 ON) HOLD (Control outputs 1 and 2 both OFF) OPEN (Control output 1 ON)		

**Note** The order of priority is as follows: Manual MV > MV at reset > MV at error.

- The following table shows the operation when a potentiometer error occurs when the Direct Setting of Position Proportional MV parameter is set to ON.

MV at stop $\geq 100$	Open output ON
MV at stop $\leq 0$	Close output ON

When the MV at stop is other than the above, the open and close outputs will both be OFF.

- The order of priority of the MVs is illustrated in the following diagram.

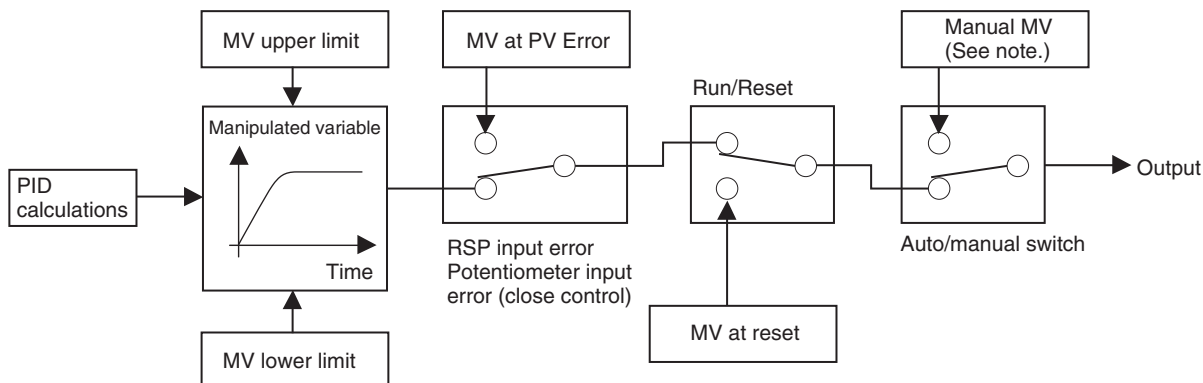

**Note** When the Manual MV Limit Enable parameter is set to ON, the setting range will be the MV lower limit to the MV upper limit.

# 4-17 Using the Extraction of Square Root Parameter

## Extraction of Square Roots

Extraction of Square Root Enable



Extraction of Square Root Low-cut Point

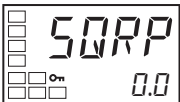

- For analog inputs, the Extraction of Square Root parameter is provided for inputs so that differential pressure-type flow meter signals can be directly input.
- The default setting for the Extraction of Square Root parameter is OFF. The Extraction of Square Root Enable parameter must be set to ON in order to use this function.
- If the PV input (i.e., the input before extracting the square root) is higher than 0.0% and lower than the low cut point set in the Extraction of Square Root Low-Cut Point parameter, the results of extracting the square root will be 0.0%. If the PV input is lower than 0.0% or higher than 100.0%, extraction of the square root will not be executed, so the result will be equal to the PV input. The low-cut point is set as normalized data for each input, with 0.0 as the lower limit and 100.0 as the upper limit for the input setting range.

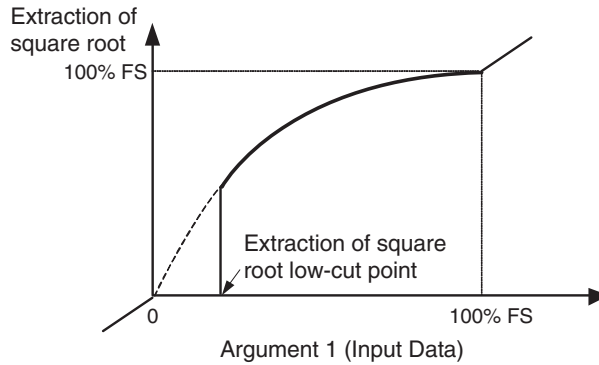

Parameter name	Setting rage	Unit	Default
Extraction of Square Root Enable	OFF: Disabled, ON: Enabled	---	OFF
Extraction of Square Root Low-cut Point	0.0 to 100.0	%	0.0

### Operating Procedure

Input type = 25 (4 to 20 mA)

This procedure sets the Extraction of Square Root Low-cut Point parameter to 10.0%.

Operation Level



Initial Setting Level

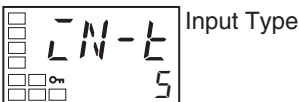

1. Press the Key for at least three seconds to move from the operation level to the initial setting level.

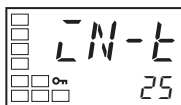

2. Use the and Keys to set the parameter to 25 (4 to 20 mA).

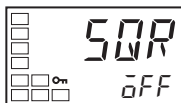

Extraction of Square Root Enable

3. Press the Key to select the Extraction of Square Root Enable parameter.

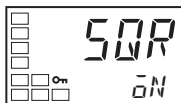

Extraction of Square Root Enable

4. Use the Key to select ON.

Operation Level



PV/SP

5. Press the Key for at least one second to move from the initial setting level to the operation level.

Adjustment Level

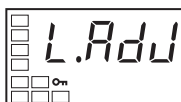

6. Press the Key twice to move from the operation level to the adjustment level.

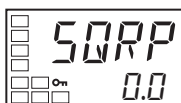

Extraction of Square Root Low-cut Point

7. Select the Extraction of Square Root Low-cut Point parameter by pressing the Key.



Extraction of Square Root Low-cut Point

8. Use the Key to set the parameter to -10.0.

Operation Level



PV/SP

9. Press the Key to return to the operation level.

## 4-18 Setting the Width of MV Variation

### MV Change Rate Limit

MV Change Rate Limit (Heating)



- The MV change rate limit sets the maximum allowable width of change in the MV per second. If the change in the MV exceeds this setting, the MV will be changed by the MV change rate limit until the calculated value is reached. This function is disabled when the setting is 0.0.

- The MV change rate limit does not function in the following situations:
  - In manual mode
  - During AT execution
  - During ON/OFF control
  - While resetting (during MV output in reset status)
  - During MV at PV Error output

Parameter name	Setting range	Unit	Default
MV Change Rate Limit	0.0 to 100.0	%/s	0.0

**Operating Procedure**

This procedure sets the MV change rate limit to 5.0%/s. The related parameters are as follows:

PID·ON/OFF = PID

Operation Level



Initial Setting Level

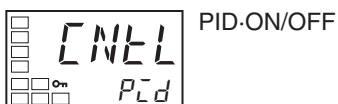
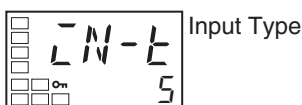

Operation Level



Adjustment Level

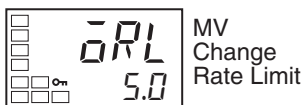
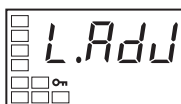

Operation Level





1. Press the Key for at least three seconds to move from the operation level to the initial setting level.
2. Select the PID ON/OFF parameter by pressing the Key.
3. Use the Key to select 2-PID control. (The default is PID.)
4. Press the Key for at least one second to move from the initial setting level to the operation level.
5. Press the Key twice to move from the operation level to the adjustment level.
6. Press the Key to select the MV Change Rate Limit parameter.
7. Use the Key to set the parameter to 5.0.
8. Press the Key to return to the operation level.

## 4-19 Setting the PF Key

### 4-19-1 PF Setting (Function Key)

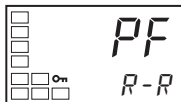
PF Setting



- Pressing the PF Key for at least one second executes the operation set in the PF Setting parameter. (For the E5CN-HT, use the + Keys to implement the PF Key function.)

Set value	Symbol	Setting	Function
OFF	$\bar{o}FF$	Disabled	Does not operate as a function key.
RUN	$RUN$	RUN	Specifies RUN status.
RST	$RSt$	Reset	Specifies Reset status. (See note 1.)
R-R	$R-R$	Reverse Run/Reset	Specifies reversing operation status between Run and Reset.
HOLD	$H\bar{o}Ld$	Reverse Hold/Clear Hold	Specifies reversing operation status between Hold and Hold Clear.
ADV	$Adv$	Advance	Specifies performing advance operation.
AT-2	$At-2$	100% AT Execute/Cancel	Specifies reversing the 100% AT Execute/Cancel status. (See note 2.)
AT-1	$At-1$	40% AT Execute/Cancel	Specifies reversing the 40% AT Execute/Cancel status. (See notes 2 and 3.)
LAT	$LAt$	Alarm Latch Cancel	Specifies canceling all alarm latches. (See note 4.)
A-M	$A-M$	Auto/Manual	Specifies reversing the Auto/Manual status. (See note 5.)
PFDP	$PFdP$	Monitor/Setting Item	Specifies the monitor/setting item display. Select the monitor setting item according to the Monitor/Setting Item 1 to 5 parameters (advanced function setting level).

- Note**
- The reset operation for a Reset or Reverse Run/Reset setting is implemented by pressing the PF Key for at least two seconds. The Run operation is implemented by pressing the PF Key for at least one second.
  - When AT cancel is specified, it means that AT is cancelled regardless of whether the AT currently being executed is 100% AT or 40% AT.
  - The setting of AT-1 will be ignored for heating/cooling control or for position-proportional floating control.
  - Alarms 1 to 3, heater burnout, HS alarms, and heater overcurrent latches are cancelled.
  - For details on auto/manual operations using the PF Key, refer to 4-12 *Performing Manual Control*.
  - Operation will be performed according to the setting of this parameter when the PF Key is pressed for at least one second. (This does not apply when Reverse Run/Reset is set.) If Monitor/Setting Items is selected, the display will switch between monitor/setting items 1 to 5 each time the key is pressed.
  - This function is enabled when PF Key Protect is OFF.



**Monitor/Setting Item**

Monitor/Setting Item 1

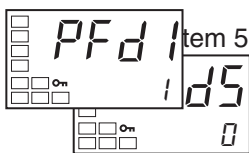

Setting the PF Setting parameter to the Monitor/Setting Item makes it possible to display monitor/setting items using the PF key. The following table shows the details of the settings. For setting (monitor) ranges, refer to the applicable parameter.

Set value	Setting	Remarks	
		Monitor/Setting	Symbol
0	Disabled		---
1	PV/SP/Program No./Segment No.	Can be set. (SP)	---
2	PV/SP/MV (See notes 1.)	Can be set. (SP)	---
3	PV/SP/Remaining segment time (See note 1.)	Can be set. (SP)	---
4	Proportional band (P) (See note 2.)	Can be set.	<i>P</i>
5	Integral time (I) (See note 2.)	Can be set.	<i>I</i>
6	Derivative time (D) (See note 2.)	Can be set.	<i>d</i>
7	Alarm value 1 (See note 3.)	Can be set.	<i>AL-1</i>
8	Alarm value upper limit 1 (See note 3.)	Can be set.	<i>AL1H</i>
9	Alarm value lower limit 1 (See note 3.)	Can be set.	<i>AL1L</i>
10	Alarm value 2 (See note 3.)	Can be set.	<i>AL-2</i>
11	Alarm value upper limit 2 (See note 3.)	Can be set.	<i>AL2H</i>
12	Alarm value lower limit 2 (See note 3.)	Can be set.	<i>AL2L</i>
13	Alarm value 3 (See note 3.)	Can be set.	<i>AL-3</i>
14	Alarm value upper limit 3 (See note 3.)	Can be set.	<i>AL3H</i>
15	Alarm value lower limit 3 (See note 3.)	Can be set.	<i>AL3L</i>
16	Program No.	Can be set.	<i>PRG</i>
17	Segment No.	Cannot be set.	<i>SEG</i>
18	Elapsed program time	Cannot be set.	<i>PRGt</i>
19	Remaining program time	Cannot be set.	<i>PRGR</i>
20	Elapsed segment time	Cannot be set.	<i>SEGt</i>
21	Remaining segment time	Cannot be set.	<i>SEGR</i>

- Note**
- (1) For details on MV settings for heating and cooling control, refer to *MV Display for Heating and Cooling Control* on page 87.
  - (2) The set value for the current PID set will be displayed.
  - (3) The currently selected program number is displayed.

**Setting Monitor/Setting Items**

Press the PF Key in the operation, adjustment, program setting, or PID setting level to display the applicable monitor/setting items. Press the PF Key to display in order Monitor/Setting Items 1 to 5. After Monitor/Setting Item 5 has been displayed, the display will switch to the top parameter in the operation level.

- Note**
- (1) Items set as disabled in the Monitor/Setting Items 1 to 5 parameters will not be displayed, and the display will skip to the next enabled setting.
  - (2) While a monitor/setting item is being displayed, the display will be switched to the top parameter in the operation level if the Key or the Key is pressed.

**Operating Procedure**

This procedure sets the PF Setting parameter to PFDP, and the Monitor/Setting Item 1 parameter to 7 (Alarm Value 1).

Operation Level



Initial Setting Level

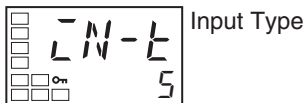

Initial Setting Level



Advanced Function Setting Level

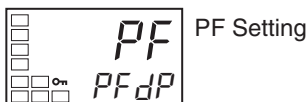
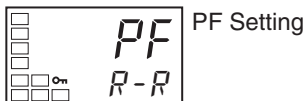
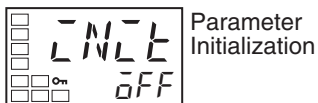

Initial Setting Level

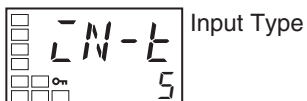

Operation Level



Monitor/Setting Item Level



1. Press the Key for at least three seconds to move from the operation level to the initial setting level.
2. Select the Move to Advanced Function Setting Level parameter by pressing the Key.
3. Press the Key to enter the password (-169). It is possible to move to the advanced function setting level by either pressing the Key or waiting two seconds without pressing any key.
4. Press the Key to select the PF Setting parameter.
5. Press the Key to select PFDP (Monitor/Setting Item).
6. Press the Key to select the Monitor/Setting Item 1 parameter.
7. Press the Key to select 7 (Alarm Value 1).
8. Press the Key for at least one second to move from the advanced function setting level to the initial setting level.
9. Press the Key for at least one second to move from the initial setting level to the operation level.
10. Press the PF Key to display alarm value 1 for the current program.

## 4-20 Counting Control Output ON/OFF Operations

### 4-20-1 Control Output ON/OFF Count Function

If Control Output 1 and 2 are ON/OFF outputs (relay outputs, voltage outputs for driving SSR), the number of times that a control output turns ON and OFF can be counted. Based on the control output ON/OFF count alarm set value, an alarm can be output and an error can be displayed if the set count value is exceeded.

The default setting of the Control Output ON/OFF Alarm Set Value parameter is 0. ON/OFF operations are not counted when this parameter is set to 0. To enable counting ON/OFF operations, change the setting to a value other than 0.

#### Control Output ON/OFF Counter Monitor Function

This function is not displayed when the Control Output 1 ON/OFF Alarm Set Value and the Control Output 2 ON/OFF Alarm Set Value parameter are set to 0, or when the control outputs are set for linear outputs.

Parameter name	Setting range	Unit	Default
Control Output 1 ON/OFF Count Monitor	0 to 9999	100 times	0
Control Output 2 ON/OFF Count Monitor	0 to 9999	100 times	0

#### Display When ON/OFF Count Alarm Occurs

When an ON/OFF count alarm occurs, the PV display in the No. 1 display shown below alternates with the *RRLM* display on the No. 2 display.

- PV
- PV/SP (Including the items displayed by setting the “PV/SP” Display Screen Selection parameter.)
- PV/Manual MV (Valve Opening), PV/SP/Manual MV (Valve Opening)
- PV/SP displayed for the monitor/setting items

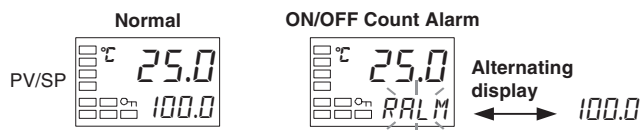

#### Control Output ON/OFF Count Alarm Function

If the ON/OFF counter exceeds the control output ON/OFF count alarm set value, an ON/OFF count alarm will occur. The alarm status can be assigned to a control output or an auxiliary output, or it can be displayed at the Controller. The ON/OFF count alarm set value function is disabled by setting the ON/OFF count alarm set value to 0.

Parameter name	Setting range	Unit	Default
Control Output 1 ON/OFF Alarm Set Value ( <i>RR1</i> )	0 to 9999	100 times	0
Control Output 2 ON/OFF Alarm Set Value ( <i>RR2</i> )	0 to 9999	100 times	0

### ON/OFF Counter Reset Function

The ON/OFF counter can be reset for a specific control output.

Parameter name	Setting range	Unit	Default
ON/OFF Counter Reset (RAL)	0: Disable the counter reset function. 1: Reset the control output 1 ON/OFF counter. 2: Reset the control output 2 ON/OFF counter.	---	0

**Note** After the counter has been reset, the control output ON/OFF count monitor value will be automatically returned to 0.

If an error occurs in the control output ON/OFF counter data, the ON/OFF count monitor value will be set to 9999 and an ON/OFF count alarm will occur. The alarm can be cleared by resetting the ON/OFF counter.

#### Operating Procedure

This procedure sets the Control Output 1 ON/OFF Alarm Set Value parameter to 10 (1,000 times).

Initial Setting Level

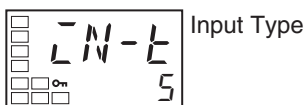

1. Press the Key for at least three seconds to move from the operation level to the initial setting level.

Initial Setting Level



2. Select the Move to Advanced Function Setting Level parameter by pressing the Key.

Advanced Function Setting Level

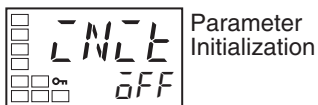

3. Use the Key to enter the password (“-169”). It is possible to move to the advanced function setting level by either pressing the Key or waiting two seconds without pressing any key.



4. Press the Key to select the Control Output 1 ON/OFF Count Alarm Set Value parameter.



5. Use the Key to set the parameter to 10.

Initial Setting Level

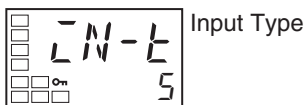

6. Press the Key for at least one second to move to the initial setting level.

Operation Level



7. Press the Key for at least one second to move to the operation level.

## 4-21 Displaying PV/SV Status

### 4-21-1 PV and SV Status Display Functions

#### PV Status Display Function (PV St)

The PV function in the PV/SP, PV, or PV/Manual MV (Valve Opening) Display and the control and alarm status specified for the PV and PV status display are alternately displayed in 0.5-s

Set value	Symbol	Function
OFF	OFF	No PV status display
Manual	MANU	MANU is alternately displayed during manual control.
Reset	RST	RST is alternately displayed while operation is in reset status.
Alarm 1	ALM1	ALM1 is alternately displayed during Alarm 1 status.
Alarm 2	ALM2	ALM2 is alternately displayed during Alarm 2 status.
Alarm 3	ALM3	ALM3 is alternately displayed during Alarm 3 status.
Alarm 1 to 3 OR status	ALM	ALM is alternately displayed when Alarm 1, 2, or 3 is set to ON.
Heater Alarm (See note.)	HA	HA is alternately displayed when a heater burnout alarm, HS alarm, or heater over-current alarm is ON.
Standby	STB	STB is alternately displayed while operation is on standby.

- The default is OFF.

**Note** “HA” can be selected for models that do not support heater burnout detection, but the function will be disabled.

Example: When RST Is Selected for the PV Status Display Function

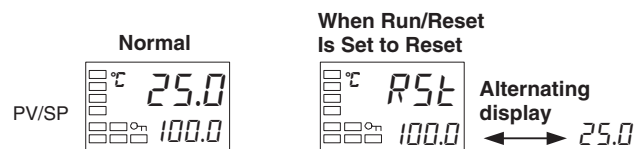

#### SV Status Display Function (SV St)

The SP, Blank, or Manual MV in the PV/SP, PV, or PV/Manual MV Display (Valve Opening) and the control and alarm status specified for the SV status display function are alternately displayed in 0.5-s cycles.

Set value	Symbol	Function
OFF	OFF	No SV status display
Manual	MANU	MANU is alternately displayed during manual control.
Reset	RST	RST is alternately displayed while operation is in reset status.
Alarm 1	ALM1	ALM1 is alternately displayed during Alarm 1 status.
Alarm 2	ALM2	ALM2 is alternately displayed during Alarm 2 status.
Alarm 3	ALM3	ALM3 is alternately displayed during Alarm 3 status.

Set value	Symbol	Function
Alarm 1 to 3 OR status	ALM	ALM is alternately displayed when Alarm 1, 2, or 3 is set to ON.
Heater Alarm (See note.)	HA	HA is alternately displayed when a heater burnout alarm, HS alarm, or heater over-current alarm is ON.
Standby	STB	STB is alternately displayed while operation is on standby.

- The default is OFF.

**Note** “HA” can be selected for models that do not support heater burnout detection, but the function will be disabled.

Example: When ALM1 Is Selected for the SV Status Display Function

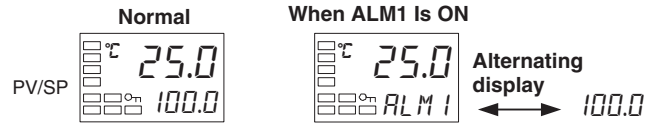

**Note** The order of priority for flashing and alternating displays on the No. 2 display are as follows:

- (1) Alternating display in SV status display
- (2) Alternating display during program end output/hold display
- (3) Flashing display during auto-tuning
- (4) Alternating display when a control output ON/OFF count alarm occurs
- (5) Flashing display when out of the setting range

**Operating Procedure**

This procedure sets the PV Status Display Function parameter to ALM1.

Initial Setting Level

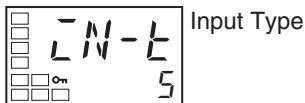

1. Press the Key for at least three seconds to move from the operation level to the initial setting level.

Initial Setting Level



2. Select the Move to Advanced Function Setting Level parameter by pressing the Key.

Advanced Function Setting Level

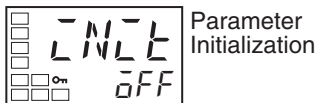

3. Use the Key to enter the password (-169). It is possible to move to the advanced function setting level by either pressing the Key or waiting two seconds without pressing any key.

PV Status Display Function

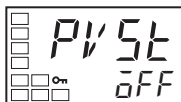

4. Press the Key to select the PV Status Display Function parameter.

PV Status Display Function

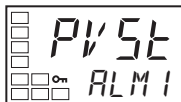

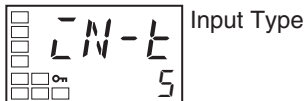

5. Press the Key to select ALM1.

Initial Setting Level

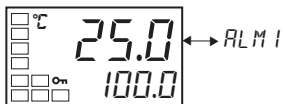

Operation Level



- 6. Press the  Key for at least one second to move to the initial setting level.
  
- 7. Press the  Key for at least one second to move to the operation level. If the Alarm 1 status is ON, PV and ALM1 will be alternately displayed.

## 4-22 Using a Remote SP

The remote SP function scales a remote SP input (4 to 20 mA) to the remote SP upper and lower limits, and takes it as the set point. (This function is supported by the E5AN-HT and E5EN-HT only.)

Set the Remote SP Enable parameter (advanced function setting level) to ON, and use an event input or an operation command to select the remote SP.

Parameter	Setting range	Unit	Default
Remote SP Enable ( <i>RSPU</i> )	OFF: Disable, ON: Enable	None	OFF
Remote SP Upper Limit ( <i>RSPH</i> )	SP lower limit to SP upper limit	EU	1300.0
Remote SP Lower Limit ( <i>R SPL</i> )	SP lower limit to SP upper limit	EU	-200.0
SP Tracking ( <i>SPTR</i> )	OFF: Disable, ON: Enable	None	OFF
Remote SP Input Error Output ( <i>RSEā</i> )	OFF: Disable, ON: Enable	None	OFF
SP Mode ( <i>SPMd</i> )	PSP: Program SP Mode, FSP: Fixed SP Mode, RSP: Remote SP Mode	None	PSP
Remote SP Monitor ( <i>RSP</i> )	Remote SP lower limit to remote SP upper limit	EU	---
RSP0 to RSP10 before Compensation ( <i>RSD</i> to <i>RSD</i> )	Remote SP lower limit to remote SP upper limit	EU	---
Broken Curve Compensation 0 to 10 ( <i>bC</i> to <i>bC</i> )	-19999 to 32400	EU	---

### Precautions

- The remote SP input is not accepted during autotuning. Autotuning is executed for the remote SP at the beginning of autotuning.
- Changes in the remote SP value are not used as conditions for resetting the standby sequence.

### Remote SP Scaling

- The remote SP input (4 to 20 mA) can be scaled to match the PV input range, based on the Remote SP Upper Limit and Remote SP Lower Limit parameter settings.
- The remote SP input can be input in a range of -10% to 110% of 4 to 20 mA. Input values outside of this range are treated as out-of-range input values (RSP input errors). In Remote SP Mode, the RSP indicator will flash, and in Program SP Mode or Fixed SP Mode, the Remote SP Monitor will flash on the No. 2 display.  
Values beyond the following lower limit or upper limit are clamped to the lower limit or upper limit.  
Lower limit: The larger of -10% and the SP lower limit  
Upper limit: The smaller of 110% and the SP upper limit



- An alarm can be output if an RSP input error occurs by setting the Remote SP Input Error Output parameter to ON.

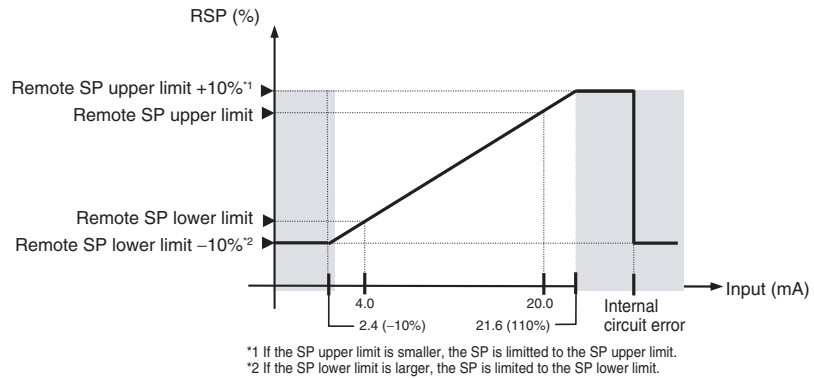

- When the SP Upper Limit or SP Lower Limit parameter setting is changed, the remote SP upper or lower limit will be forcibly changed to the SP upper or lower limit. For example, if the upper limit for the SP limiter is changed from A to B, the remote SP upper and lower limits will be changed as shown in the following diagram.

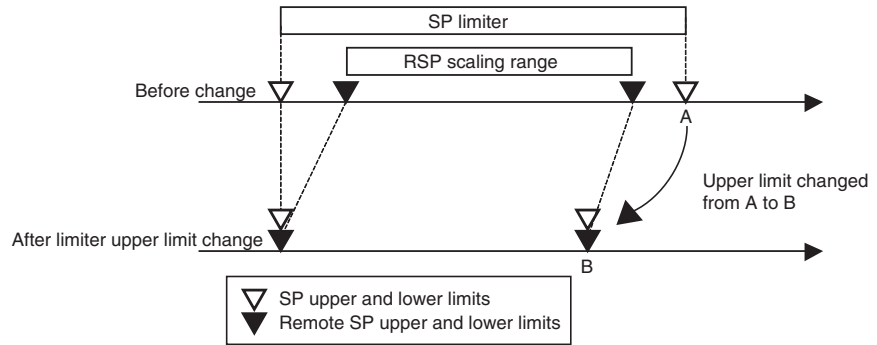

**SP Mode**

The SP Mode parameter is used to switch between Program SP Mode, Fixed SP Mode, and Remote SP Mode.

When Remote SP Mode is selected in the SP Mode parameter, the RSP indicator will light.

When Fixed SP Mode is selected in the SP Mode parameter, the FSP indicator will light.

**Remote SP Monitor**

In Remote SP Mode, the remote SP can be checked on the No. 2 display if the PV and SP are displayed. In Fixed SP or Program SP Mode, it can be checked with the Remote SP Monitor parameter if the remote SP is enabled.

**SP Tracking**

- If SP tracking is enabled, the fixed SP will be set to the value of the program SP or remote SP after changing from Program SP Mode or Remote SP Mode to Fixed SP Mode. Tracking is not performed when changing to the Program SP Mode or Remote SP Mode. To enable SP tracking, set the SP Tracking parameter to ON.

- The following figure shows SP tracking when the mode is changed from Program SP Mode to Fixed SP Mode.

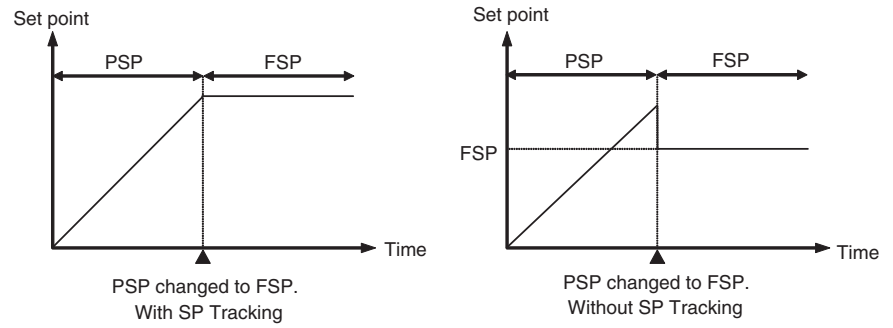

### Remote SP Broken-line Correction Value

Broken-line correction value can be set for 10 points for remote SPs.

For details, refer to the description of the *RSP 0 to RSP 10 before Correction* and *Broken-line Correction Value 0 to 10* on page 224 in *SECTION 5 Parameters*.

## 4-23 Position-proportional Control

The control method used to adjust the opening and closing of a valve with a control motor is called "position-proportional control" or "ON/OFF servo control." Either closed control or floating control can be selected for position-proportional control. Only models that support position-proportional control (E5AN/EN-HTPRR□) can be used for position-proportional control. In addition, the following functions are disabled when using position-proportional control.

- LBA
- Heater burnout, heater short, and heater overcurrent alarms
- ON/OFF control
- P and PD control (for floating control only)
- 40% AT (for floating control only)

### Closed Control (CLFL)

Closed control provides control using feedback on the valve opening by connecting a potentiometer.

### Floating Control (FLFL)

Floating control provides control without using feedback on the valve opening, so control is still possible even if a potentiometer is not connected. With floating control, the expected valve opening is calculated from the travel time, and that value is treated as the valve opening for executing control outputs.

If there is no FB input, then even if the Closed/Floating parameter is set to *Closed* the parameter will be disabled and floating control will be executed.

Parameter	Setting range	Unit	Default
Travel Time	1 to 999	s	30

### Motor Calibration and Travel Time (RLb) (Mōt)

Calibrate the motor when a potentiometer is connected, such as in closed control or in floating control for monitoring valve opening. The fully closed and fully open valve positions will be calibrated and the travel time, i.e., the time from the fully open to the fully closed position, will be automatically measured and set. Set the Motor Calibration parameter to ON to execute the motor calibration. The setting will be automatically changed OFF when the calibration has been completed.

Parameter	Setting range	Unit	Default
Motor Calibration	OFF, ON	---	OFF

For floating control (i.e., without a potentiometer connection), it is necessary to manually set the travel time. Set the Travel Time parameter to the time from the fully open to the fully closed valve position.

**Position-proportional Dead Band and Open/Close Hysteresis**

The interval during which the valve output is held (for the ON and OFF switching points for the open output and closed output) is set in the Position Proportional Dead Band parameter, and the hysteresis is set in the Open/Close Hysteresis parameter.

Parameter	Setting range	Unit	Default
Position Proportional Dead Band ( <i>db</i> )	Position proportional (closed): 0.1 to 10.0	%	4.0
	Position proportional (floating): 0.1 to 10.0		2.0
Open/Close Hysteresis	0.1 to 20.0	%	0.8

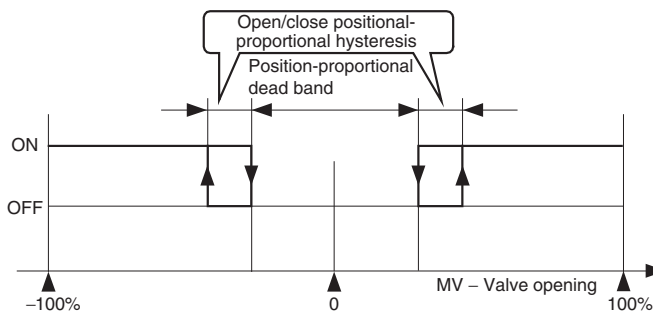

**PV Dead Band**

When the PV is within the PV dead band, control is executed as if the PV is equal to the SP to prevent unnecessary output when the PV is in the vicinity of the SP.

Parameter	Setting range	Unit	Default
PV Dead Band ( <i>P-db</i> )	0 to 32400	EU	0.0

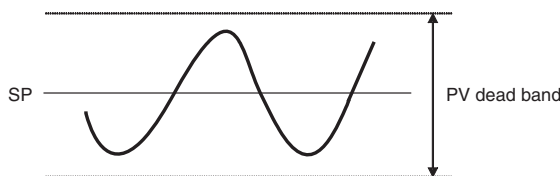

**Valve Opening Monitor**

Valve opening can be monitored by connecting a potentiometer. The motor must be calibrated after the potentiometer is connected.

Parameter	Setting range	Unit	Default
Valve Opening Monitor ( <i>V-M</i> )	-10.0 to 110.0	%	---

**Note** If no potentiometer is connected or if a potentiometer input error occurs, "----" will be displayed.

With the E5AN/EN-HT, valve opening can also be monitored on the PV/SP/MV (Valve Opening) Screen.

Manual Operation

With models that support position-proportional control, manual operation is possible by moving to the manual control level and pressing the Up and Down Keys. The output on the open side is ON while the Up Key is pressed, and the output on the closed side is ON while the Down Key is pressed. If the Direct Setting of Position Proportional MV parameter is set to ON and closed control is used, however, the Manual MV parameter can be set with the same display and operations as for standard models.

MV at Reset/MV at Error

With floating control or when the Direct Setting of Position Proportional MV parameter ( $P\%Md$ ) is set to OFF, select to open, close, or hold the status of the output when resetting (when the operation at reset is set to stop control) or when an error occurs. Set the MV for when the Direct Setting of Position Proportional MV parameter ( $P\%Md$ ) is set to ON for closed control.

## 4-24 Logic Operations

### 4-24-1 The Logic Operation Function (CX-Thermo)

- The logic operation calculates the Controller status (alarms, run/reset, auto/manual, etc.) and the external event input status as 1 or 0, and outputs the result to a work bit. The work bit status can be output to auxiliary or control output, and operating status can be changed according to the work bit status.
- Work bit logic operation can be set from 1 to 8. Set them to *No operation (Always OFF)* (the default) when the work bits are not to be used. When logic operations are being used, a dot will be displayed on the No. 2 display of the adjustment level display

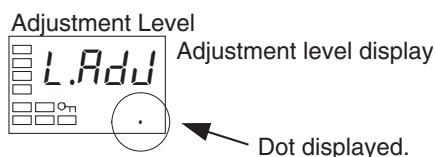

### 4-24-2 Using Logic Operations

Logic operations are set using the CX-Thermo.

#### Starting Logic Operations

There are two ways to start logic operations.

- Select *Logic Operation Editor* from the CX-Thermo tree, and click the **Start Button**.

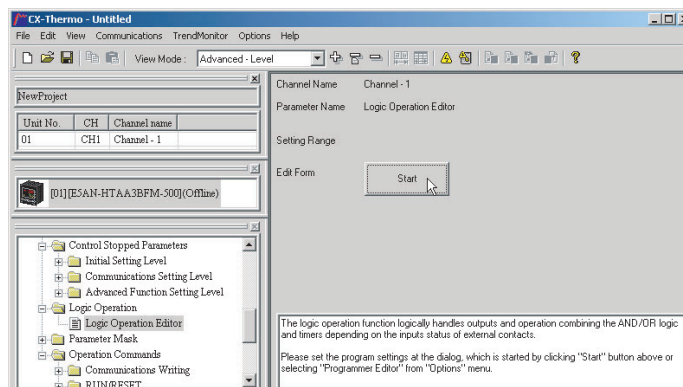

- Select **Logic Operation Editor** from the CX-Thermo Options Menu.

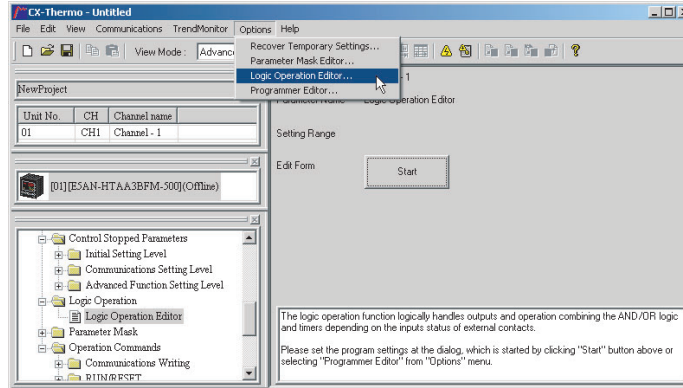

### Making the Settings

The following display will appear on the Logic Operation Editor Setting Window. Set each of the parameters.

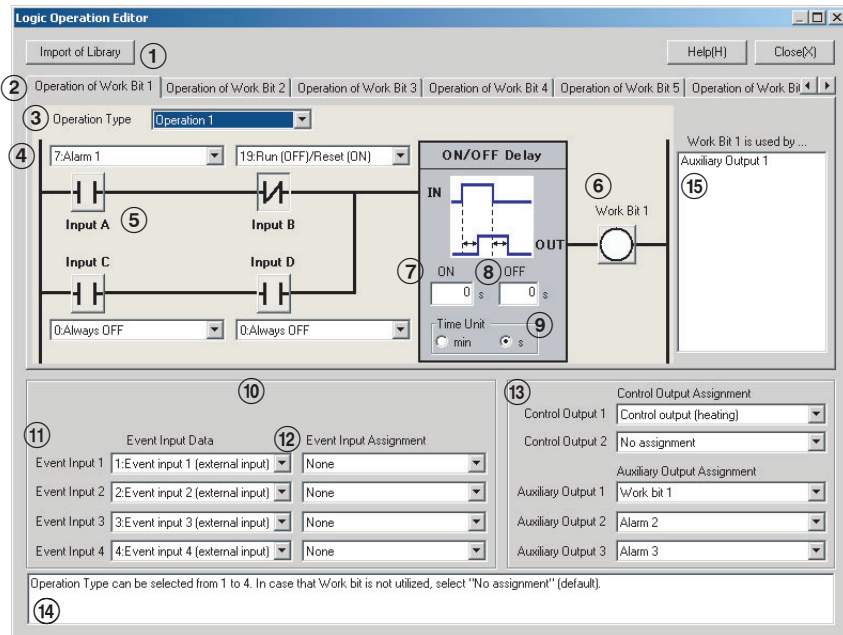

**1,2,3...**

1. Displaying the Library Import Dialog Box

Logic operation samples for specific cases are set in the library in advance. Examples of settings for specific cases are loaded by selecting them from the library list and clicking the **OK** Button.

Example: Selecting Library 1

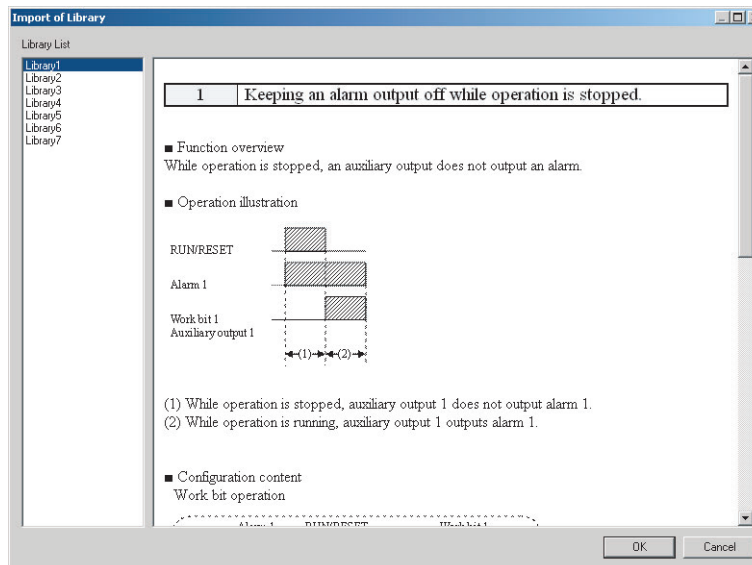

2. Switching Work Bit Operations

Select the work bit logic operations from the Operation of Work Bit 1 to Operation of Work Bit 8 Tab Pages.

3. Selecting the Operation Type

From one to four operations are supported. If work bits are not to be used, set them to *No operation (Always OFF)* (the default).

- No Operation (Always OFF)

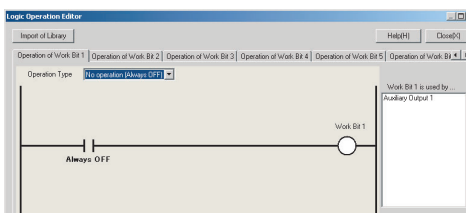

- Operation 1

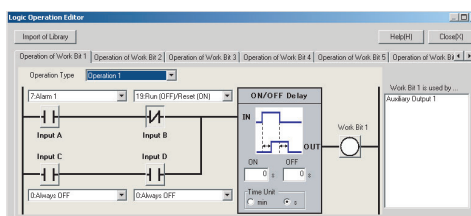

(A and B) or (C and D)  
When conditions A and B or conditions C and D are satisfied

- Operation 2

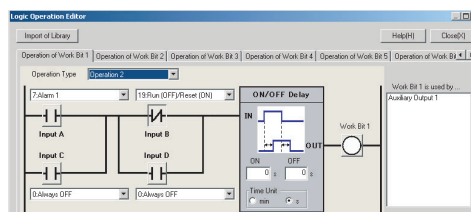

(A or C) and (B or D)  
When condition A or C and condition B or D are satisfied

• Operation 3

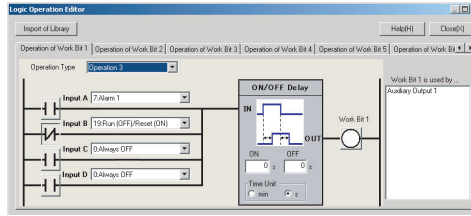

A or B or C or D  
When condition A, B, C or D is satisfied

• Operation 4

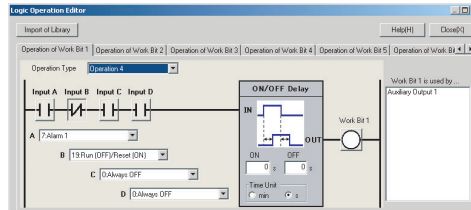

A and B and C and D  
When conditions A, B, C and D are all satisfied





4. Selecting Input Assignments

Select the input assignment for the work bit logic operation from the following settings.



Parameter name	Setting range
Work Bit 1 Input Assignment A	0: Always OFF 1: Always ON 2: ON for one cycle when power is turned ON 3: Event Input 1 (external input) (See note 1.) 4: Event Input 2 (external input) (See note 1.) 5: Event Input 3 (external input) (See note 1.) 6: Event Input 4 (external input) (See note 1.) 7: Alarm 1 8: Alarm 2 9: Alarm 3 10: Control output ON/OFF count alarm (See note 2.) 11: Control output (heating) (See note 3.) 12: Control output (cooling) (See note 4.) 13: Input error 14: RSP input error 15: HB (heater burnout) alarm 16: HS alarm 17: OC (heater overcurrent) alarm 18: Auto (OFF)/Manual (ON) 19: Run (OFF)/Reset (ON) 20: Hold 21: Program SP Mode 22: Remote SP Mode 23: Fixed SP Mode 24: AT Execute/Cancel 25: Run 26: Standby 27: Wait 28: Time signal 1 29: Time signal 2 30: Program end output 31: Stage 32: Program number, bit 0 33: Program number, bit 1 34: Program number, bit 2 35: Reserved 36: Segment number, bit 0 37: Segment number, bit 1 38: Segment number, bit 2 39: Segment number, bit 3 40: Segment number, bit 4 41: Work bit 1 42: Work bit 2 43: Work bit 3 44: Work bit 4 45: Work bit 5 46: Work bit 6 47: Work bit 7 48: Work bit 8
Work Bit 1 Input Assignment B	Same as for work bit 1 input assignment A
Work Bit 1 Input Assignment C	Same as for work bit 1 input assignment A
Work Bit 1 Input Assignment D	Same as for work bit 1 input assignment A
to	to
Work Bit 8 Input Assignment D	Same as for work bit 1 input assignment A

- Note**
- (1) The event inputs that can be used depend on the Controller model.
  - (2) Turns ON when either the control output 1 or 2 ON/OFF count alarm is ON.

- (3) Setting 11 (control output (heating)) gives the status of control output 1. However, if control output 1 is a current output or a linear voltage output, setting 11 (control output (heating)) will always produce OFF.
- (4) Setting 12 (control output (cooling)) gives the status of control output 2. However, if there is no control output 2 or if control output 2 is a current output or linear voltage output, setting 12 (control output (cooling)) will always produce OFF.
- 5. Switching between Normally Open and Normally Closed for Inputs A to D  
Click the condition to switch between normally open and normally closed inputs A to D.

Normally open	Normally closed
	

- 6. Switching between Normally Open and Normally Closed for Work Bits  
Click the condition to switch between normally open and normally closed work bits.

Normally open	Normally closed
	

- 7. Setting ON Delay Times  
When an input with an ON delay turns ON, the output will turn ON after the set delay time has elapsed. The setting range is 0 to 9,999. The default is 0 (disabled).
- 8. Setting OFF Delay Times  
When an input with an OFF delay turns OFF, the output will turn OFF after the set delay time has elapsed. The setting range is 0 to 9,999. The default is 0 (disabled).
- 9. Switching ON/OFF Delay Time Unit  
Select either seconds or minutes for the ON/OFF delay time unit. The default is seconds.
- 10. Changing Event Input Data  
Select the event input conditions from the following setting ranges.

Parameter name	Setting range
Event Input Data 1	0: Not assigned. 1: Event input 1 (external input) 2: Event input 2 (external input) 3: Event input 3 (external input) 4: Event input 4 (external input) 5: Work bit 1 6: Work bit 2 7: Work bit 3 8: Work bit 4 9: Work bit 5 10: Work bit 6 11: Work bit 7 12: Work bit 8
Event Input Data 2	Same as for event input data 1

Parameter name	Setting range
Event Input Data 3	Same as for event input data 1
Event Input Data 4	Same as for event input data 1

**Note** The event input data can be changed from the default setting even if there is no event input terminal (external input). By changing the default setting, the event input assignment parameters will be displayed at the Controller display and can be set from the Controller.

11. Changing the Event Input Assignment Function

Select the setting for the event input assignment.  
When a work bit is selected as event input data, Communications Write Enable/Disable cannot be assigned to an event input.

12. Changing Control Output and Auxiliary Output Settings

Control output and auxiliary output assignments can be changed. The items that can be changed depend on the Controller model. For details, refer to 3-5-3 Assigned Output Functions.

In this manual, assigning a work bit to either a control output or an auxiliary output is considered also assigns the alarms and time signals. For example, if work bit 1 is set for the Auxiliary Output 1 Assignment parameter, then alarms 1 to 3 and time signals are assigned.

13. Displaying Parameter Guides

A description of the parameters can be displayed.

14. Displaying the Work Bit Use Destinations

Display a list of destinations where the work bits are used.

**Operating Procedure**

This procedure uses event input 2 to change Auto/Manual status.

Event input 2 ON: Auto

Event input 2 OFF: Manual

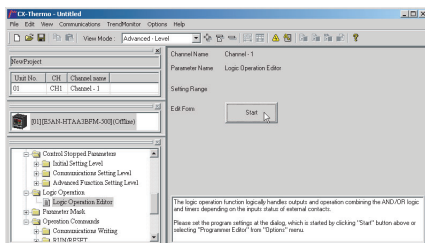
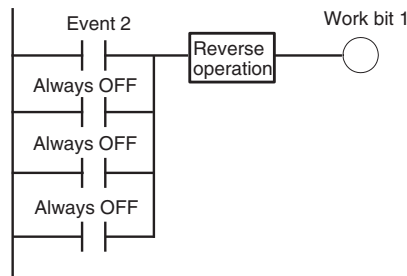

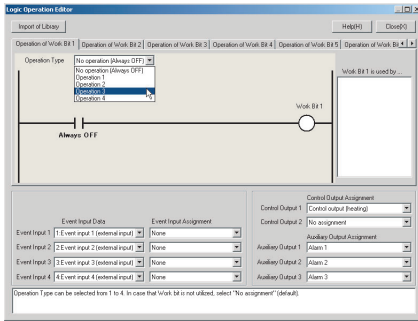

1. Select *Logic Operation Editor* from the CX-Thermo tree, and click the **Start** Button.

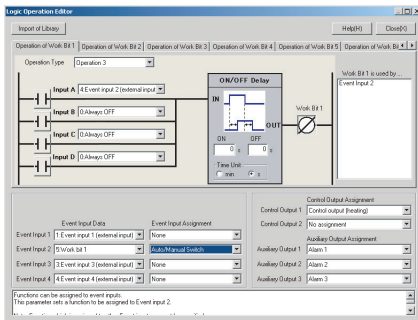

- The Logic Operation Editor will be displayed. Confirm that the screen for work bit 1 is displayed, and select **Operation 3** from the **Operation Type** Field.



- Set the operation by selecting one of the following:  
 Work bit 1 input assignment A = 4: Event input 2 (external input)  
 Work bit 1 input assignment B = 0: Always OFF  
 Work bit 1 input assignment C = 0: Always OFF  
 Work bit 1 input assignment D = 0: Always OFF
- Invert work bit 1. Click  (Normally open) to change it to  (Normally closed).
- Auto/Manual is assigned to event input 2. Set the event input data for event input 2 to 5 (work bit 1), and set Event Input 2 Assignment parameter to Auto/Manual.
- Closing the Logic Operation Editor Dialog Box  
 Click the **Close** Button.

This completes the procedure for setting parameters using the CX-Thermo. Transfer the settings to the Controller to set the Controller. Refer to CX-Thermo help for the procedure to transfer the settings.

**Operating Procedure**

This procedure outputs alarm 1 status to auxiliary output 1 during operation (RUN). A library object is used to make the setting.

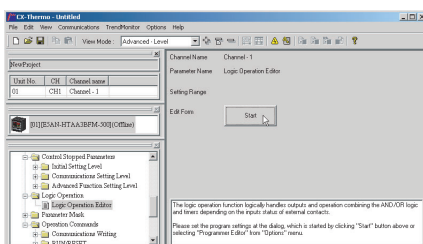
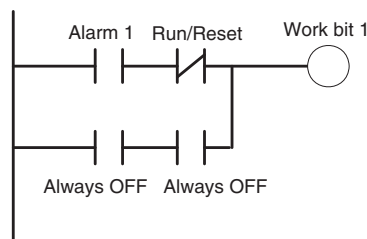

- Select **Logic Operation Editor** from the CX-Thermo tree, and click the **Start** Button.

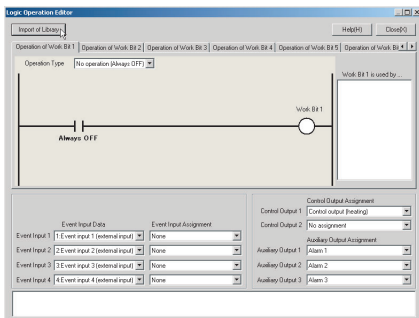

2. Click the **Import of Library** Button.

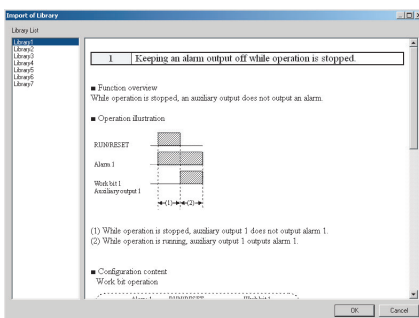

3. Select *Library 1* from the library list, and then click the **OK** Button.

Confirm the following settings, and then click the **OK** Button.

Work bit 1 operation type: Operation 1

Work bit 1 input assignment A = 7: Alarm 1

Work bit 1 input assignment B = 19: Invert for Run (OFF)/Reset (ON)

Work bit 1 input assignment C = 0: Always OFF

Work bit 1 input assignment D = 0: Always OFF

Auxiliary output 1 = Work bit 1

4. Closing the Logic Operation Editor Dialog Box

Click the **Close** Button.

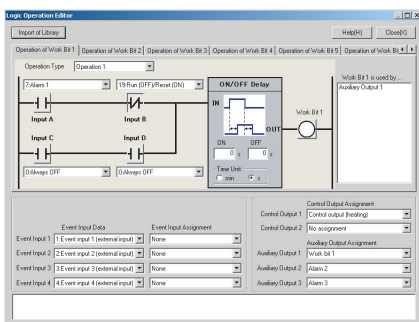

This completes the procedure for setting parameters using the CX-Thermo. Transfer the settings to the Controller to set the Controller. Refer to CX-Thermo help for the procedure to transfer the settings.



# SECTION 5

## Parameters

This section describes the individual parameters used to setup, control, and monitor operation.

5-1	Conventions Used in this Section . . . . .	178
5-1-1	Meanings of Icons Used in this Section . . . . .	178
5-1-2	About Related Parameter Displays . . . . .	178
5-1-3	The Order of Parameters in This Section . . . . .	178
5-1-4	Alarms. . . . .	178
5-2	Protect Level . . . . .	179
5-3	Operation Level. . . . .	183
5-4	Program Setting Level. . . . .	196
5-5	Adjustment Level . . . . .	206
5-6	PID Setting Level . . . . .	226
5-7	Monitor/Setting Item Level. . . . .	230
5-8	Manual Control Level . . . . .	232
5-9	Initial Setting Level . . . . .	234
5-10	Advanced Function Setting Level. . . . .	256
5-11	Communications Setting Level. . . . .	296

## 5-1 Conventions Used in this Section

### 5-1-1 Meanings of Icons Used in this Section



Function

Describes the functions of the parameter.



Setting

Describes the setting range and default of the parameter.



Monitor

Used to indicate parameters used only for monitoring.



Operation

Describes the parameter settings, such as those for Operation Commands, and procedures.



Used to indicate information on descriptions in which the parameter is used or the names of related parameters.

### 5-1-2 About Related Parameter Displays

Parameters are displayed only when the conditions for use given on the right of the parameter heading are satisfied. Protected parameters are not displayed regardless of the conditions for use, but the settings of these parameters are still valid.

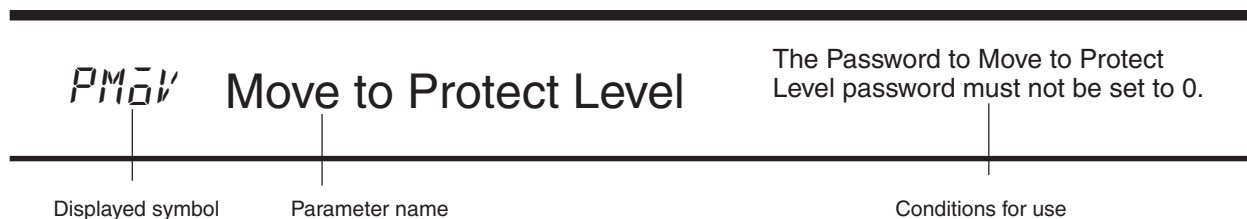

### 5-1-3 The Order of Parameters in This Section

Parameters are described level by level.

The first page of each level describes the parameters in the level and the procedure to switch between parameters.

### 5-1-4 Alarms

It will be specified in this section when alarms are set for the Control Output 1 or 2 Assignment parameters, or for the Auxiliary Output 1 or 3 Assignment parameters. For example, when alarm 1 is set for the Control Output 1 Assignment parameter, it will be specified that alarm 1 is assigned.

Assigning a work bit to either control output 1 or 2 or to auxiliary output 1 to 3 is also considered to be the same as assigning an alarm. For example, if work bit 1 is set for the Auxiliary Output 1 Assignment parameter, then alarms 1 to 3 have been assigned.



## 5-2 Protect Level

Four levels of protection are provided: Operation/Adjustment Protect, Initial Setting/Communications Protect, Setting Change Protect, and PF Key Protect. Each level is used to protect the corresponding settings and prevent accidental changes to the settings.

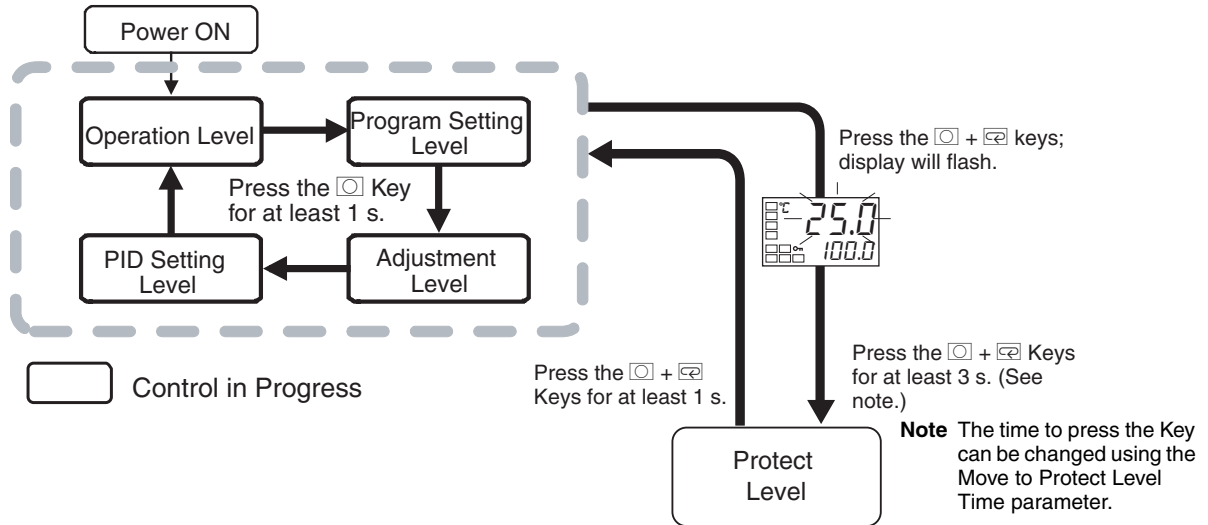

To move from the operation level to the protect level, press [ ] and [ ] Keys for three seconds (see note) or more.

**Note** The time taken to move to the protect level can be adjusted by changing the Move to Protect Level Time parameter setting.

Protect Level		Page
	Move to Protect Level Displayed only when a password is set.	180
	Operation/Adjustment Protect	180
	Initial Setting/Communications Protect	180
	Setting Change Protect	181
	PF Key Protect	181
	Parameter Mask Enable	182
	Password to Move to Protect Level	182

Parameters that are protected will not be displayed and their settings cannot be changed.

PMoV

### Move to Protect Level

The Password to Move to Protect Level password must not be set to 0.



Function

The password to move to the protect level is entered for this parameter.

- The password to move to the protect level (i.e., the password set for the Password to Move to Protect Level parameter) is entered for this parameter.
- The Operation/Adjustment Protect parameter will be displayed if the correct password is entered.



■ **Related Parameters**

Password to move to protect level (protect level): Page 182

oAPt

### Operation/Adjustment Protect

oCPt

### Initial Setting/Communications Protect

These parameters specify the range of parameters to be protected. Shaded settings are the defaults.



Function

■ **Operation/Adjustment Protect**

The following table shows the relationship between set values and the range of protection.



Setting

Level		Set value					
		0	1	2	3	4	5
Operation Level	PV	Can be displayed	Can be displayed	Can be displayed	Can be displayed	Can be displayed	Can be displayed
	PV/SP	Can be displayed and changed	Can be displayed and changed	Can be displayed and changed	Can be displayed and changed	Can be displayed and changed	Can be displayed
	Others	Can be displayed and changed	Can be displayed and changed	Can be displayed and changed	Can be displayed and changed	Cannot be displayed and moving to other levels is not possible	Cannot be displayed and moving to other levels is not possible
Program Setting Level		Can be displayed and changed	Can be displayed and changed	Can be displayed and changed	Cannot be displayed and moving to other levels is not possible	Cannot be displayed and moving to other levels is not possible	Cannot be displayed and moving to other levels is not possible

Level	Set value					
	0	1	2	3	4	5
Adjustment Level	Can be displayed and changed	Can be displayed and changed	Cannot be displayed and moving to other levels is not possible	Cannot be displayed and moving to other levels is not possible	Cannot be displayed and moving to other levels is not possible	Cannot be displayed and moving to other levels is not possible
PID Setting Level	Can be displayed and changed	Cannot be displayed and moving to other levels is not possible	Cannot be displayed and moving to other levels is not possible	Cannot be displayed and moving to other levels is not possible	Cannot be displayed and moving to other levels is not possible	Cannot be displayed and moving to other levels is not possible

- Parameters are not protected when the set value is set to 0.

**Initial Setting/Communications Protect**

This protect level restricts movement to the initial setting level, communications setting level, and advanced function setting level.

Set value	Initial setting level	Communications setting level	Advanced function setting level
0	Possible to reach	Possible to reach	Possible to reach
1	Possible to reach	Possible to reach	Not possible to reach
2	Not possible to reach	Not possible to reach	Not possible to reach

WEPE

**Setting Change Protect**

The Event Input Assignment 1 to 4 parameters must not be set to "setting change enable/disable."



Function

**Change Setting Protect**

Changes to settings using key operations are restricted.

When enabling and disabling of setting changes by event inputs assignment 1 to 4 is selected, this parameter is not displayed.



Setting

Set value	Description
OFF	Settings can be changed using key operations.
ON	Settings cannot be changed using key operations. (The protect level settings, however, can be changed.)

- The shaded cell indicates the default.
- The all protect indication (ON) will light when setting is ON.

PFPE

**PF Key Protect**



Function

**PF Key Protect**

This parameter enables and disables PF Key operation. (For the E5CN-HT, press the + Keys simultaneously to implement the PF Key.)



Set value	Description
OFF	PF Key enabled
ON	PF Key disabled (Operation as a function key is prohibited.)

- The shaded cell indicates the default.

**PMSk**

**Parameter Mask Enable**

This parameter is displayed only when a parameter mask has been set from the Setup Tool.



- This parameter turns the parameter mask function ON and OFF.



Setting range	Default
$\bar{a}N$ : Enabled, $\bar{a}FF$ : Disabled	$\bar{a}N$

**Note** A parameter mask can be used to hide the displays of parameters that are not needed. The parameter mask function is provided by the Setup Tool.  
Setup Tool: CX-Thermo (EST2-2C-MV4)

**PRLP**

**Password to Move to Protect Level**



This parameter is used to set the password to move to the protect level.

- To prevent setting the password incorrectly, the and Keys or and Keys must be pressed simultaneously to set the password.



Setting range	Default
-1999 to 9999	0

- Set this parameter to 0 when no password is to be set.



■ **Related Parameters**

Move to protect level (protect level): Page 180

**Note** Protection cannot be cleared or changed without the password. Be careful not to forget it. If you forget the password, contact your OMRON sales representative.

### 5-3 Operation Level

Display this level to perform operation. This level is used to run or reset a program and also to monitor the PV, SP or other values.

In the advanced function setting level, you can set a parameter to hide or show the set points.

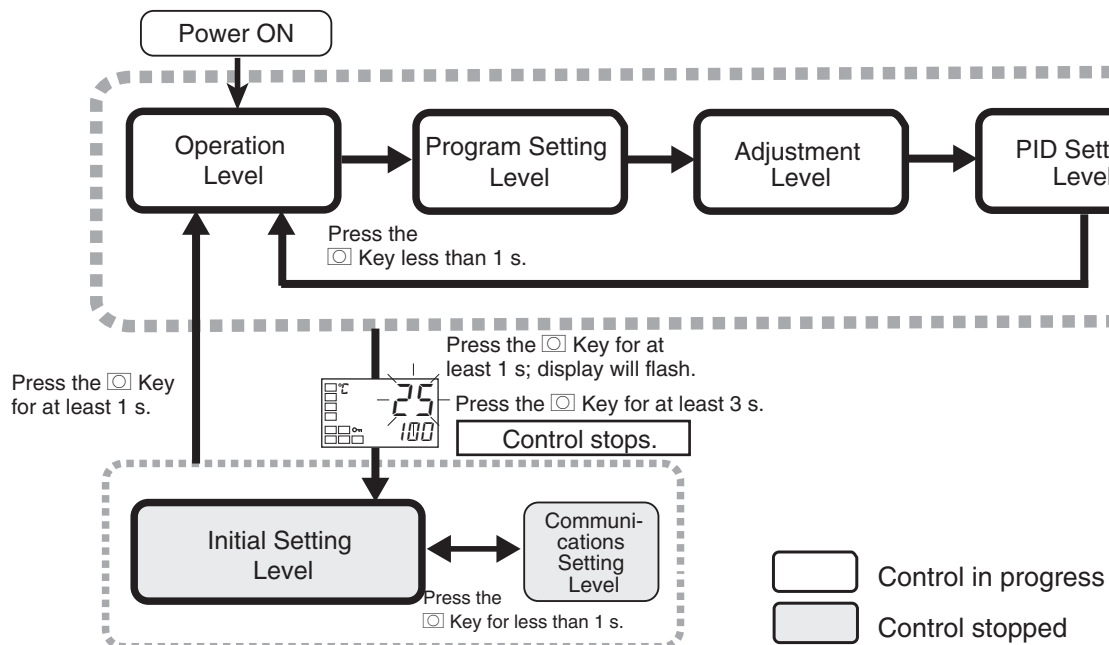

This level is displayed immediately after the power is turned ON.

To move to other levels, press the Key or the and Keys.

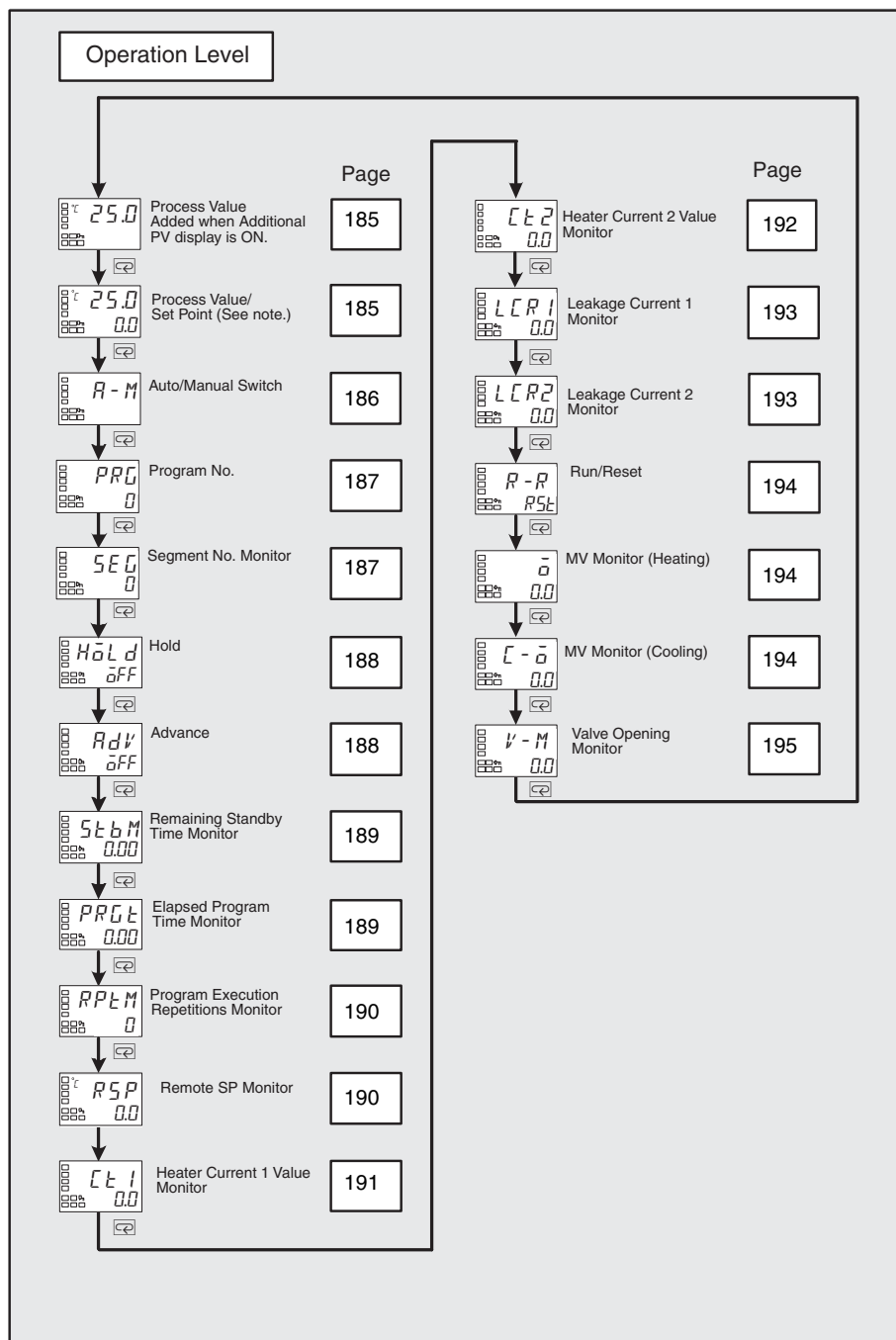

**Note** For details on the displays of Controllers with a No. 3 display (E5AN/EN-HT), refer to *Process Value/Set Point* on page 185.

**Process Value**

The Additional PV Display parameter must be set to ON.



Function

The process value is displayed on the No. 1 display, and nothing is displayed on the No. 2 and No. 3 (E5AN/EN-HT only) displays.



Monitor

	Monitor range	Unit
Process value	Temperature: According to indication range for each sensor. Analog: Scaling lower limit -5% FS to Scaling upper limit +5% FS (Refer to page 351.)	EU

During temperature input, the decimal point position depends on the currently selected sensor, and during analog input it depends on the Decimal Point parameter setting.

The default is 5 (type K thermocouple).

*S.ERR* will be displayed if the input type is not set correctly.

To clear the *S.ERR* display, correct the input type setting, check the wiring, and cycle the power supply.



■ **Related Parameters**

Input type: Page 236, Set point upper limit, Set point lower limit: Page 238 (initial setting level)

**Process Value/Set Point (Display 1)  
Process Value/Set Point (Display 2)**

(The Process Value/Set Point (Display 2) parameter is supported for the E5AN-HT and E5EN-HT only.)



Function

The process value is displayed on the No. 1 display, and the set point is displayed on the No. 2 display.



Monitor

	Monitor range	Unit
Process value	Temperature: According to indication range for each sensor. Analog: Scaling lower limit -5% FS to Scaling upper limit +5% FS (Refer to page 351.)	EU



Setting

	Setting range	Unit
Set point	SP lower limit to SP upper limit (See note.)	EU

The SP can be set in Fixed SP Mode (FSP). In Remote SP Mode (RSP) and Program SP Mode (PSP), the SP is displayed for reference only.

During temperature input, the decimal point position depends on the currently selected sensor, and during analog input it depends on the Decimal Point parameter setting.

**No. 3 Display (E5AN/EN-HT)**

The following table shows the contents of the No. 3 display, according to the setting of the PV/SP Display Screen Selection parameter.

Set value	Display contents
0	Only the PV and SP are displayed. (The No. 3 display is not shown.)
1	The PV, SP, Program No., and Segment No., and the PV, SP, and MV are displayed in order.
2	The PV, SP, and MV, and the PV, SP, Program No., and Segment No. are displayed in order.
3	Only the PV, SP, Program No., and Segment No. are displayed.
4	PV/SP/MV are displayed
5	The PV, SP, Program No., and Segment No., and the PV, SP, and Remaining Segment Time are displayed in order.
6	The PV, SP, and MV, and the PV, SP, Remaining Segment Time are displayed in order.
7	Only the PV, SP, Remaining Segment Time are displayed.

When 1, 2, 5, or 6 is selected, press the  Key to display PV/SP (Display 2).  
 Example: When the PV/SP Display Screen Selection Parameter Is Set to 2

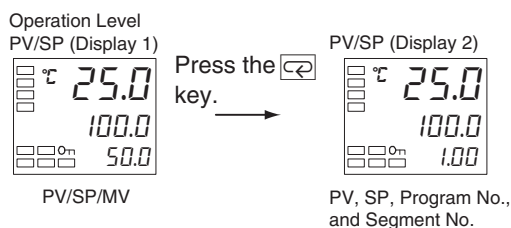

**■ Related Parameters**

- SP mode (adjustment level): Page 209, Input type: Page 236, Set point upper limit, Set point lower limit: Page 238 (initial setting level)
- PV/SP display screen selection (advanced function setting level): Page 288

R-M

**Auto/Manual Switch**

The Event Input Assignment 1 to 4 parameters must not be set to Auto/Manual and the Auto/Manual Select Addition parameter must be set to ON.  
 The control must be set to 2-PID control.



- This parameter switches the Controller between automatic and manual modes.
- If the  Key is pressed for at least 3 seconds when the Auto/Manual Switch parameter is displayed, the manual mode will be entered and the manual control level will be displayed.
- This parameter will not be displayed if an event input is set to “MANU” (auto/manual).





■ **Related Parameters**

PID ON/OFF (initial setting level): Page 238

Auto/manual select addition (advanced function setting level): Page 269

**PRG**

**Program No.**



Function

- This parameter specifies the program number to use for operation.
- This parameter can be used only when resetting and only when the Event Input Assignment 1 to 4 parameters are not set to switch the program number.



Setting

Setting range	Unit	Default
0 to 7	---	0



■ **Related Parameters**

Run/reset (operation level): Page 194

**SEG**

**Segment No. Monitor**



Function

- This parameter monitors the segment number that is currently being executed in the program.



Monitor

Monitor range	Unit
0 to Number of segments used - 1	---



■ **Related Parameters**

Number of segments used (program setting level): Page 198

***HōLd***

**Hold**

The Event Input Assignment 1 to 4 parameters must not be set to Hold or Hold Clear, the Run/Reset parameter must be set to Run, operation must not be on standby, and operation must be completed (Fixed SP Mode).



Function

- This parameter temporarily stops (holds) the timer operation for program execution.
- Use the run operation, reset operation, or hold clear command to clear hold status.



Operation

The timing operation is held when the parameter is set to  $\bar{0}N$ .  
The default is  $\bar{0}FF$  (clear hold clear).



- Related Information  
*4-15 Program-related Functions: Page 138*

***RdV***

**Advance**

The Run/Reset parameter must be set to Run, operation must not be on standby, and operation must be completed (Fixed SP Mode).



Function

- This parameter is used to advance the program to the beginning of the next segment. If you advance during hold status, the hold status will be continued at the beginning of the next segment.



Operation

When you change to this parameter, the set value will be  $\bar{0}FF$ .  
The segment will advance when you set the parameter to  $\bar{0}N$ .  
After execution, the setting will automatically return to  $\bar{0}FF$ .



- Related Information  
*4-15 Program-related Functions: Page 138*

5LbM

**Remaining Standby Time Monitor**

Operation must be on standby.



Function

- This parameter monitors the remaining standby time.



Monitor

Monitor range	Unit
Standby time in hours and minutes: 0.00 to 99.59	Hours and minutes, or days and hours (See note.)
Standby time in days and hours: 0.00 to 99.24	

**Note** The unit is set in the Standby Time Unit parameter. (The default is H-M (hours and minutes).)



- **Related Information**  
4-15 Program-related Functions: Page 138
- **Related Parameters**  
Standby time (adjustment level): Page 223

PRGt

**Elapsed Program Time Monitor**

The Run/Reset parameter must be set to Run.



Function

- This parameter monitors the time that has elapsed from the beginning of the program that is being executed.



Monitor

Monitor range	Unit
0.00 to 99.59	Hours and minutes, or minutes and seconds (See note.)

**Note** The unit is set in the Program Time Unit parameter. (The default is H-M (hours and minutes).)



- **Related Information**  
4-15 Program-related Functions: Page 138

**RPEM**

**Program Execution Repetitions Monitor**

The Run/Reset parameter must be set to Run.



Function

- This parameter monitors the number of times the program has been repeated.



Monitor

Monitor range	Unit
0 to 9,999	Repetitions



- **Related Information**  
4-15 Program-related Functions: Page 138

- **Related Parameters**  
Program repetitions (program setting level): Page 203

**RSP**

**Remote SP Monitor**

The Remote SP Enable parameter must be set to ON.

The SP Mode parameter must not be set to RSP.



Function

- This parameter is used to monitor the remote SP while in Program SP or Fixed SP Mode.
- While in Remote SP Mode, the remote SP can be monitored on the No. 2 display of the PV/SP Screen.



Monitor

Monitor range	Unit
Remote SP lower limit -10% to Remote SP upper limit +10% There are restrictions on the SP limits.	EU



- **Related Parameters**  
Process value/Set point (operation level): Page 185  
SP mode (adjustment level): Page 209  
Remote SP upper limit, Remote SP lower limit (advanced function setting level): Page 279  
Remote SP enable (advanced function setting level): Page 278

Ⓔ 1

### Heater Current 1 Value Monitor

Heater burnout, HS alarm, and heater overcurrent detection must be supported.  
Alarm 1 must be assigned.  
The Heater Burnout Detection or Heater Overcurrent Use parameter must be set to ON.



Function

This parameter measures the heater current from the CT input used for detecting heater burnout.

This parameter measures and displays the heater current value.

- Heater burnouts and heater overcurrent are not detected if the control output (heating) ON time is 100 ms or less.



Monitor

Monitor range	Unit
0.0 to 55.0	A

- FFFF is displayed when 55.0 A is exceeded.
- If a heater burnout detection 1 or heater overcurrent detection 1 alarm is output, the HA indicator will light and the No. 1 display for the heater current 1 value monitor will flash.



#### ■ Related Parameters

Heater burnout detection 1, Heater burnout detection 2 (adjustment level): Page 210, 212

HB ON/OFF (advanced function setting level): Page 259

Heater overcurrent detection 1, Heater overcurrent detection 2 (adjustment level): Page 211

Heater overcurrent use (advanced function setting level): Page 283

Error displays Ⓔ 1: Page 320

⌈⌋

### Heater Current 2 Value Monitor

Heater burnout, HS alarm, and heater overcurrent detection must be supported (two CTs). Alarm 1 must be assigned. The Heater Burnout Detection or Heater Overcurrent Use parameter must be set to ON.



Function

This parameter measures the heater current from the CT input used for detecting heater burnout.

This parameter measures and displays the heater current value.

- Heater burnouts and heater overcurrent are not detected if the control output (heating) ON time is 100 ms or less.



Monitor

Monitor range	Unit
0.0 to 55.0	A

- *FFFF* is displayed when 55.0 A is exceeded.
- If a heater burnout detection 2 or heater overcurrent detection 2 alarm is output, the HA indicator will light and the No. 1 display for the heater current 2 value monitor will flash.



■ **Related Parameters**

Heater burnout detection 1, Heater burnout detection 2 (adjustment level): Page 211, 212

HB ON/OFF (advanced function setting level): Page 259

Heater overcurrent detection 1, Heater overcurrent detection 2 (adjustment level): Page 211, 213

Heater overcurrent use (advanced function setting level): Page 283

Error displays ⌈⌋: Page 320

LCR1

### Leakage Current 1 Monitor

Heater burnout, HS alarms, and heater overcurrent detection must be supported.  
The HS Alarm Use parameter must be set to ON.



Function

This parameter measures the heater current from the CT input used for detecting SSR short-circuits.

The heater current is measured and the leakage current 1 monitor is displayed.

- HS alarms are not detected if the control output (heating) OFF time is 100 ms or less.

Monitor range	Unit
0.0 to 55.0	A

- FFFF is displayed when 55.0 A is exceeded.
- If an HS alarm 1 alarm is output, the HA indicator will light and the No. 1 display for the leakage current 1 monitor will flash.



Monitor

■ **Related Parameters**

HS alarm 1, HS alarm 2 (adjustment level): Page 214

Failure detection (advanced function setting level): Page 270

Error displays LCR1: Page 320



LCR2

### Leakage Current 2 Monitor

Heater burnout, HS alarms, and heater overcurrent detection must be supported (two CTs).  
Alarm 1 must be assigned.  
The HS Alarm Use parameter must be set to ON.



Function

This parameter measures the heater current from the CT input used for detecting SSR short-circuits.

This parameter measures and displays the heater current value.

- HS alarms are not detected if the control output (heating) OFF time is 100 ms or less.

Monitor range	Unit
0.0 to 55.0	A

- FFFF is displayed when 55.0 A is exceeded.
- If an HS alarm 2 alarm is output, the HA indicator will light and the No. 1 display for the leakage current 2 monitor will flash.



Monitor

■ **Related Parameters**

HS alarm 1, HS alarm 2 (adjustment level): Page 214

HS alarm use (advanced function setting level): Page 270

Error displays LCR2: Page 320



R-R

**Run/Reset**



Operation

This parameter is used to start and stop operation.  
 Operation will start when *RUN* (run) is selected and it will stop when *RST* (reset) is selected. The RST indicator will light while operation is stopped.  
 The default is *RST*.

ō

**MV Monitor (Heating)**

The MV Display parameter must be set to ON.



Function

This parameter is used to check the manipulated variable for the heating control output during operation.

- This parameter cannot be set.
- During standard control, the manipulated variable is monitored. During heating/cooling control, the manipulated variables on the control output (heating) is monitored.
- The default is OFF and the manipulated variable is not displayed.



Monitor

Control	Monitor range	Unit
Standard	-5.0 to 105.0	%
Heating/cooling	0.0 to 105.0	%

■ **Related Parameters**

MV display (advanced function setting level): Page 262



[-ō

**MV Monitor (Cooling)**

The control system must be set to heating/cooling control.  
 The MV Display parameter must be set to ON.



Function

This parameter is used to check the manipulated variable for the cooling control output during operation.

- This parameter cannot be set.
- During heating/cooling control, the manipulated variable on the control output (cooling) is monitored.
- The default is OFF and the manipulated variable is not displayed.



Monitor

Control	Monitor range	Unit
Heating/cooling	0.0 to 105.0	%





■ **Related Parameters**

- Standard or heating/cooling (initial setting level): Page 239
- MV display (advanced function setting level): Page 262

V - M

**Valve Opening Monitor**

Position-proportional control must be supported. The No. 3 display must be supported.

The PV/SP Display Screen Selection parameter must be set to 1, 2, 4, or 6.



This parameter monitors the valve opening during operation.

- This parameter monitors the valve opening when position-proportional control is used.
- The valve opening can be monitored if a potentiometer is connected and motor calibration is executed.



Control	Monitor range	Unit
Position-proportional	-10.0 to 110.0	%



■ **Related Parameters**

- Motor calibration (initial setting level): Page 251
- PV/SP display screen selection (advanced function setting level): Page 288

## 5-4 Program Setting Level

The Program Setting Level is used to set the set points, times, rates of rise, and other parameters for each program. The program to which to move is selected in the first parameter in the Program Setting Level (Display Program Selection).

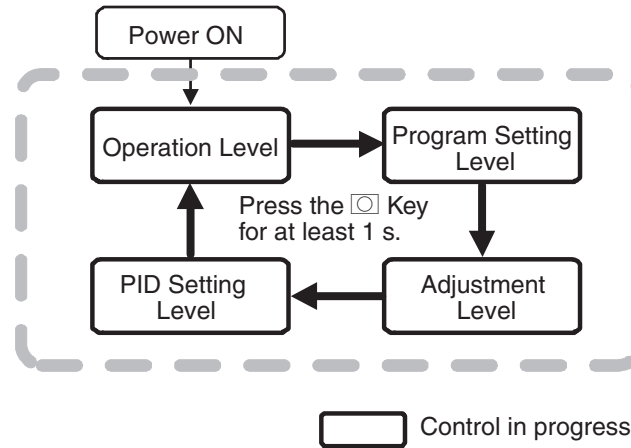

To move from Operation Level to Program Setting Level, press the □ Key once.

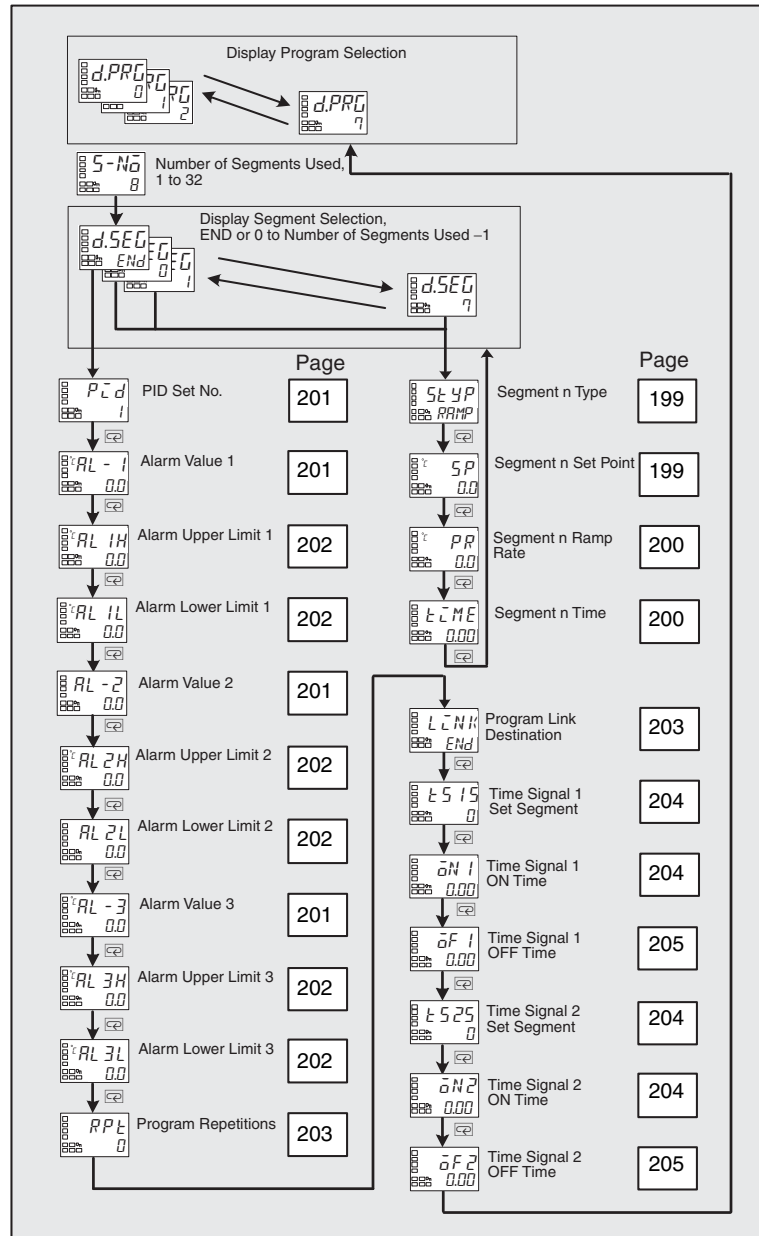

**d.PRG**

**Display Program Selection**



Function

- This parameter specifies the number of the program to be set.



Setting

Setting range	Unit	Default
0 to 7	---	See note.

**Note** Number of program currently used for control.



- Related Information  
3-6 Setting Programs: Page 60

**5-N $\bar{a}$**

**Number of Segments Used**



Function

- This parameter specifies the number of segments in the program.



Setting

Setting range	Unit	Default
1 to 32	---	8



- Related Information  
3-6 Setting Programs: Page 60

**d.SEG**

**Display Segment Selection**



Function

- This parameter specifies the number of the segment to set in the program.



Setting

Setting range	Unit	Default
END or 0 to Number of segments used - 1	---	END



■ **Related Information**  
 3-6 Setting Programs: Page 60

STEP

**Segment n Type (n = 0 to 7)**

The Display Segment Selection parameter must not be set to END. The Step Time/Rate of Rise Programming parameter must be set to Rate of Rise.



Function

- This parameter sets the segment type for the specified segment number to ramp, soak, or step.



Setting

Setting range	Unit	Default
RAMP (ramp), SOAK (soak), or STEP (step)	---	RAMP



■ **Related Information**  
 3-6 Setting Programs: Page 60

■ **Related Parameters**  
 Step time/rate of rise programming (initial setting level): Page 252

SP

**Segment n Set Point (n = 0 to 7)**

The Display Segment Selection parameter must not be set to END. The Step Time/Rate of Rise Programming parameter must be set to Step Time, or the Step Time/Rate of Rise Programming parameter must be set to Rate of Rise and the Segment Type parameter must be set to Ramp or Step.



Function

This parameter sets the SP for the specified segment number. For rate of rise programming, the target SP is set.



Setting

Setting range	Unit	Default
SP lower limit to SP upper limit	EU	0.0



■ **Related Information**

3-6 Setting Programs: Page 60

■ **Related Parameters**

Step time/rate of rise programming (initial setting level): Page 252

PR

**Segment n Ramp Rate (n = 0 to 7)**

The Displayed Segment Selection parameter must not be set to END. The Step Time/Rate of Rise Programming parameter must be set to Rate of Rise. The Segment Type parameter must be set to Ramp.



This parameter sets the amount of change per the time unit of the ramp rate for the specified segment number.

If this parameter is set to 0, the segment will be a step segment.



Setting range	Unit	Default
0 to 32,400	EU	0.0



■ **Related Information**

4-15 Program-related Functions: Page 138

■ **Related Parameters**

Step time/rate of rise programming (initial setting level): Page 252

Segment n type (program setting level): Page 199

ŁME

**Segment n Time (n = 0 to 7)**

The Display Segment Selection parameter must not be set to END. The Step Time/Rate of Rise Programming must be set to Step Time, or the Step Time/Rate of Rise Programming must be set to Rate of Rise and the Segment Type parameter must be set to Soak.



This parameter sets the segment time for the specified segment number. This parameter sets the soak segment time for rate of rise programming.



Setting range	Unit	Default
0.00 to 99.59	Hours and minutes, or minutes and seconds	0.00

**Note** The unit is set in the Program Time Unit parameter. (The default is H-M (hours and minutes).)



■ **Related Information**

4-15 Program-related Functions: Page 138

■ **Related Parameters**

Step time/rate of rise programming (initial setting level): Page 252

Segment n type (program setting level): Page 199

$P_{\bar{L}d}$

**PID Set No.**

Control must be set to 2-PID control.



This parameter sets the PID set number for the specified program number. If this parameter is set to 0, the automatic PID set selection function will automatically select the PID set number to be used in control according to the PV, DV, and SP.



Setting range	Default
0 to 8	1



■ **Related Information**

4-14 Using PID Sets: Page 136

$RL-1$

**Alarm Value 1**

Alarms 1 to 3 must be assigned.

$RL-2$

**Alarm Value 2**

The alarm 1 to 3 type must not be set to 0, 1, 4, 5, or 12.

$RL-3$

**Alarm Value 3**

These parameters are set to one of the input values (X) in the alarm type list.



These parameters set the alarm value for alarms 1 to 3 of the specified program number.

For a temperature input, the decimal point is automatically set according to the selected sensor. For an analog input, the decimal point is set according to Decimal Point parameter setting.



Setting range	Unit	Default
-19,999 to 32,400	EU	0



■ **Related Parameters**

- Input type (initial setting level): Page 232
- Scaling upper limit, Scaling lower limit, Decimal point (initial setting level): Page 237
- Alarm 1 type (initial setting level): Page 240
- Alarm 2 type (initial setting level): Page 244
- Alarm 3 type (initial setting level): Page 245
- Standby sequence reset (advanced function setting level): Page 258
- Auxiliary output 1 open in alarm (advanced function setting level): Page 259
- Auxiliary output 2 open in alarm (advanced function setting level): Page 259
- Alarm 1 latch (advanced function setting level): Page 263
- Alarm 2 latch (advanced function setting level): Page 263
- Alarm 3 latch (advanced function setting level): Page 263

- AL 1H*
- AL 2H*
- AL 3H*
- AL 1L*
- AL 2L*
- AL 3L*

- Alarm Upper Limit 1**
- Alarm Upper Limit 2**
- Alarm Upper Limit 3**
- Alarm Lower Limit 1**
- Alarm Lower Limit 2**
- Alarm Lower Limit 3**

Alarms 1 to 3 must be assigned.  
The alarm 1 to 3 type must be set to 1, 4, or 5.

These parameters are used to set the alarm upper limits and alarm lower limits for alarms for which upper/lower limits have been selected in Alarm 1 Type to Alarm 3 Type (initial setting level).



These parameters set the upper limits and lower limits for alarms 1 to 3 of the specified program number.  
For a temperature input, the decimal point is automatically set according to the selected sensor. For an analog input, the decimal point is set according to Decimal Point parameter setting.



Setting range	Unit	Default
-19,999 to 32,400	EU	0.0



■ **Related Parameters**

- Input type (initial setting level): Page 232



- Scaling upper limit, Scaling lower limit, Decimal point (initial setting level): Page 237
- Alarm 1 to 3 type (initial setting level): Page 240
- Alarm 1 hysteresis (initial setting level): Page 244
- Alarm 2 hysteresis (initial setting level): Page 244
- Alarm 3 hysteresis (initial setting level): Page 244
- Standby sequence reset (advanced function setting level): Page 258
- Auxiliary output 1 open in alarm (advanced function setting level): Page 259
- Auxiliary output 2 open in alarm (advanced function setting level): Page 259
- Alarm 1 latch (advanced function setting level): Page 263
- Alarm 2 latch (advanced function setting level): Page 263
- Alarm 3 latch (advanced function setting level): Page 263

RPL  
L2NK

**Program Repetitions**  
**Program Link Destination**



- The Program Repetitions parameter is used to repeatedly execute the same program for the specified number of repetitions. The actual number of executions will be the set value of this parameter plus one.
- The Program Link Destination Number parameter sets the link destination for the program. Operation will continue to the program with the number that is specified in this parameter after execution of the current program is completed.



Parameter	Setting range	Unit	Default
Program Repetitions	0 to 9,999	Repetitions	0
Program Link Destination	END or 0 to 7	---	END



■ **Related Information**

4-15 Program-related Functions: Page 138

Ƨ5 15  
Ƨ525

**Time Signal 1 Set Segment**  
**Time Signal 2 Set Segment**

Outputs must be assigned to time signals 1 and 2.



- These parameters set the segment numbers that will use time signals.
- Up to two outputs can be set for each program. There is one timing setting for each output.



Setting range	Unit	Default
0 to 31	---	0



■ **Related Information**

4-15 Program-related Functions: Page 138

■ **Related Parameters**

Time signal 1 ON time, Time signal 2 ON time, Time signal 1 OFF time, Time signal 2 OFF time (program setting level): Page 204

Control output 1 assignment (advanced function setting level): Page 273

Control output 2 assignment (advanced function setting level): Page 274

Auxiliary output 1 assignment (advanced function setting level): Page 275

Auxiliary output 2 assignment (advanced function setting level): Page 276

ōN 1  
ōN2

**Time Signal 1 ON Time**  
**Time Signal 2 ON Time**

Outputs must be assigned to time signals 1 and 2.



- These parameters set the ON times for the time signals.



Setting range	Unit	Default
0.00 to 99.59	Hours and minutes, or minutes and seconds	0.00

**Note** The unit is set in the Program Time Unit parameter. (The default is H-M (hours and minutes).)



■ **Related Information**

4-15 Program-related Functions: Page 138

■ **Related Parameters**

Time signal 1 set segment, Time signal 2 set segment (program setting level): Page 204

Program time unit (advanced function setting level): Page 252

̄F 1  
̄F 2

**Time Signal 1 OFF Time**  
**Time Signal 2 OFF Time**

Outputs must be assigned to time signals 1 and 2.



Function



Setting

- These parameters set the OFF times for the time signals.

Setting range	Unit	Default
0.00 to 99.59	Hours and minutes, or minutes and seconds	0.00

**Note** The unit is set in the Program Time Unit parameter. (The default is H-M (hours and minutes).)



See

■ **Related Information**

4-15 Program-related Functions: Page 138

■ **Related Parameters**

Time signal 1 set segment, Time signal 2 set segment (program setting level): Page 204

Program time unit (advanced function setting level): Page 252

## 5-5 Adjustment Level

This level is for executing AT (auto-tuning) and other operations, and for setting control parameters.

This includes the basic Controller parameters for PID control (proportional band, integral time, derivative time) and heating/cooling control.

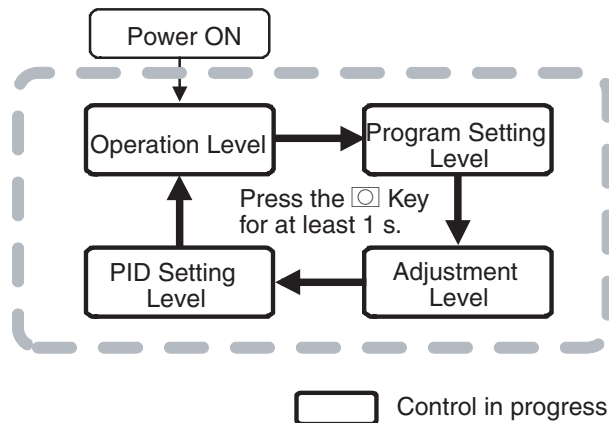

To move to the adjustment level from the operation level, press the  Key once.

- The following parameters are displayed for Controllers with CT Inputs: Heater current monitors, Leakage current monitors, heater burnout detections, HS alarms, and heater overcurrent detections.
- Adjustment level parameters can be changed after setting the Operation/Adjustment Protect parameter to 0 or 1. Displays and changing levels are not possible if the Operation/Adjustment Protect parameter is set to 2 to 5. Protection is set in the protect level.

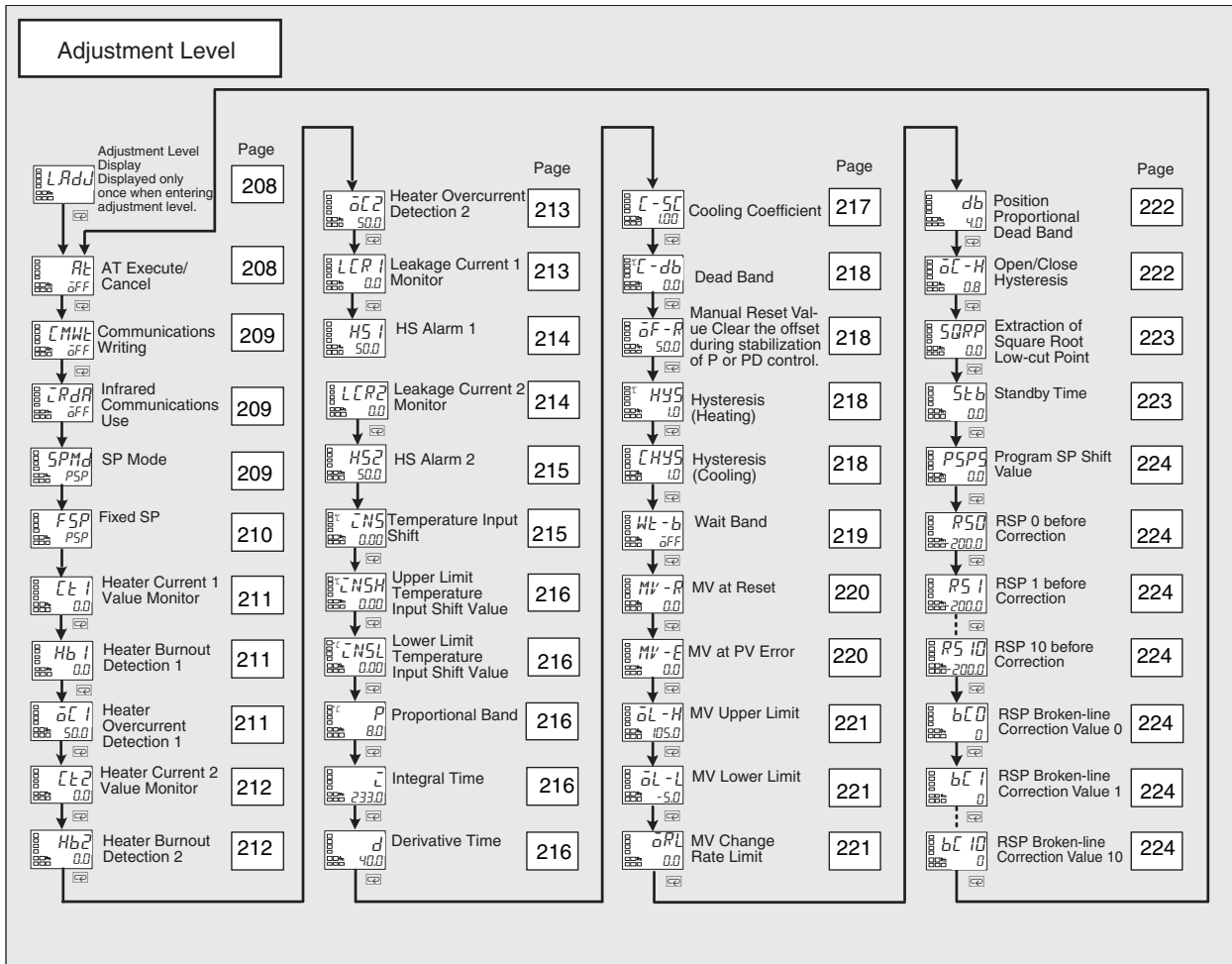

L.RdJ

### Adjustment Level Display

This parameter is displayed after moving to the adjustment level. When a logic operation is set, a period "." will be displayed on the No. 2. display.



Function

- This parameter indicates that the adjustment level has been entered. (The Adjustment Level parameter will not be displayed again even if the  Key is pressed in the adjustment level to scroll through the parameters.)

Rt

### AT Execute/Cancel

Conditions for Displaying AT Execute/Cancel Parameter

Operation must be in Auto Mode and the PID ON/OFF parameter must be set to PID.

The Reset Operation parameter must be set to Fixed SP Operation, or the Reset Operation parameter must be set to Stopping Control and operation must not be on standby or being reset.

The Event Input Assignment 1 to 4 parameters must not be set to 100% AT Execute/Cancel or 40% AT Execute/Cancel.

This parameter executes auto-tuning (AT).



Function

- The MV is forcibly increased and decreased around the set point to find the characteristics of the control object. From the results, the PID constants are automatically set in the Proportional Band (P), Integral Time (I), and Derivative Time (D) parameters.
- Both 100% AT and 40% AT are supported for AT.
- Only 100% AT can be executed for heating/cooling control and position-proportional floating control.
- This parameter will not be displayed when either 100% or 40% AT execute/cancel is set to be executed using an event input.



Operation

Setting rage	Default
OFF: AT Cancel	OFF
AT-2: 100%AT Execute	
AT-1: 40%AT Execute	

- This parameter is normally OFF. Press the  Key and select Rt-2 or Rt-1 to execute AT. Auto-tuning is not executed during resets or during ON/OFF control.
- When AT execution ends, the parameter setting automatically returns to OFF.



### ■ Related Parameters

PID \* proportional band, PID \* Integral time, PID \* Derivative time (PID setting level): Page 227

PID ON/OFF (initial setting level): Page 238

**CMWE**

## Communications Writing

Communications must be supported.  
The Event Input Assignments 1 to 4 parameters must not be set to enable communications writing.



Function

- This parameter enables/disables writing of parameters to the Digital Controllers from the host (personal computer) using communications.
- This parameter is not displayed if communications write enable/disable is set for execution using an event input assignment 1 to 4.



Setting

ON: Writing enabled

OFF: Writing disabled

- Default: OFF



### ■ Related Parameters

Communications unit No., Communications baud rate, Communications data length, Communications parity, Communications stop bits (communications setting level): Page 296

**IRdR**

## Infrared Communications Use

E5AN/EN-HT only.



Function

This parameter enables or disables infrared communications between the host (personal computer) and the Digital Controller.

- Set this parameter to ON only when connecting to a Setup Tool, and leave it set to OFF during normal operation.



Setting

ON: Infrared communications enabled.

OFF: Infrared communications disabled.

- Default: OFF

**SPMd**

## SP Mode



Function

- Use this parameter to select the SP mode.
- In Program SP Mode, the SP from the set program will be used for control.
- The Program SP Mode cannot be selected if the reset operation is set to fixed SP operation.
- In Fixed SP Mode, the fixed SP is used as the SP in control. Also, the FSP indicator will light.



Setting

- In Remote SP Mode, the remote SP specified with an external signal (e.g., 4 to 20 mA) is used as the SP. Also, the RSP indicator will light.

Setting range	Default
<i>PSP</i> : Program SP Mode	<i>PSP</i>
<i>FSP</i> : Fixed SP Mode	
<i>RSP</i> : Remote SP Mode	



#### ■ Related Information

4-15 Program-related Functions: Page 138

#### ■ Related Parameters

Fixed SP (adjustment level): Page 210

***FPS*****Fixed SP**

Function

- This parameter is used to set the SP used in Fixed SP Mode.



Setting

Setting range	Unit	Default
SP lower limit to SP upper limit	EU	0.0



#### ■ Related Parameters

SP mode (adjustment level): Page 209

**[E 1]****Heater Current 1 Value Monitor**

Heater burnout, HS alarms, and heater overcurrent detection must be supported.

Alarm 1 must be assigned.

The HB ON/OFF parameter or Heater Overcurrent Use parameter must be set to ON.



Function

This parameter measures the heater current from the CT input used for detecting heater burnout.

This parameter measures and displays the heater current value.

- Heater burnouts or heater overcurrent are not detected if the control output (heating) ON time is 100 ms or less.

Monitor range	Unit
0.0 to 55.0	A



Monitor

- *FFFF* is displayed when 55.0 A is exceeded.
- If a heater burnout detection 1 or heater overcurrent detection 1 alarm is output, the HA indicator will light and the No. 1 display for the heater current 1 value monitor will flash.





■ **Related Parameters**

- Heater burnout detection 1, Heater burnout detection 2 (adjustment level): Page 211, 212
- HB ON/OFF (advanced function setting level): Page 259
- Heater overcurrent detection 1, Heater overcurrent detection 2 (adjustment level): Page 211, 213
- Heater overcurrent use (advanced function setting level): Page 283
- Error displays  $\bar{L} \bar{L} I$ : Page 320

Hb I

**Heater Burnout Detection 1**

Heater burnout, HS alarms, and heater overcurrent detection must be supported.  
Alarm 1 must be assigned.  
The Heater Burnout Detection parameter must be set to ON.



Function

This parameter sets the current for the heater burnout alarm to be output.

- The heater burnout alarm is output when the heater current value falls below the setting of this parameter.
- When the set value is 0.0, the heater burnout alarm output is turned OFF. When the set value is 50.0, the heater burnout alarm output is turned ON.



Setting

Setting range	Unit	Default
0.0 to 50.0	A	0.0



■ **Related Parameters**

- Heater current 1 value monitor (adjustment level): Page 191
- HB ON/OFF, Heater burnout latch, Heater burnout hysteresis (advanced function setting level): Page 260, 260

$\bar{a} \bar{L} I$

**Heater Overcurrent Detection 1**

Heater burnout, HS alarms, and heater overcurrent detection must be supported.  
Alarm 1 must be assigned.  
The Heater Overcurrent Use ON/OFF parameter must be set to ON.



Function

This parameter sets the current value for heater overcurrent alarm outputs.

- A heater overcurrent alarm is output when the heater current exceeds the value set for this parameter.
- When the set value is 50.0, the heater overcurrent alarm is turned OFF. When the set value is 0.0, the heater overcurrent alarm is turned ON.



Setting

Setting range	Unit	Default
0.0 to 50.0	A	50.0



■ **Related Parameters**

Heater current 1 value monitor (adjustment level): Page 191  
 Heater overcurrent use, Heater overcurrent latch, Heater overcurrent hysteresis (advanced function setting level): Page 283, 284

**Hb2**

**Heater Current 2 Value Monitor**

Heater burnout, HS alarms, and heater overcurrent detection must be supported (two CTs).  
 Alarm 1 must be assigned.  
 The HB ON/OFF or Heater Overcurrent Use parameter must be set to ON.



Function

This parameter measures the heater current from the CT input used for detecting heater burnout.

This parameter measures and displays the heater current value.

- Heater burnouts and heater overcurrent are not detected if the control output (heating) ON time is 100 ms or less.



Monitor

Monitor range	Unit
0.0 to 55.0	A

- FFFF is displayed when 55.0 A is exceeded.
- If a heater burnout detection 2 or heater overcurrent detection 2 alarm is output, the HA indicator will light and the No. 1 display for the heater current 2 value monitor will flash.



■ **Related Parameters**

Heater burnout detection 1, Heater burnout detection 2 (adjustment level): Page 211, 212  
 HB ON/OFF (advanced function setting level): Page 259  
 Heater overcurrent detection 1, Heater overcurrent detection 2 (adjustment level): Page 211, 213  
 Heater overcurrent use (advanced function setting level): Page 283  
 Error displays **Hb2**: Page 320

**Hb2**

**Heater Burnout Detection 2**

Heater burnout, HS alarms, and heater overcurrent detection must be supported (two CTs).  
 Alarm 1 must be assigned.  
 The HB ON/OFF parameter must be set to ON.



Function

This parameter sets the current for the heater burnout alarm to be output.

- The heater burnout alarm is output when the heater current value falls below the setting of this parameter.

- When the set value is 0.0, the heater burnout alarm output is turned OFF. When the set value is 50.0, the heater burnout alarm output is turned ON.



Setting range	Unit	Default
0.0 to 50.0	A	0.0



■ **Related Parameters**

Heater current 2 value monitor (adjustment level): Page 192  
 HB ON/OFF, Heater burnout latch, Heater burnout hysteresis (advanced function setting level): Page 259

ā[2

**Heater Overcurrent Detection 2**

Heater burnout, HS alarms, and heater overcurrent detection must be supported (two CTs).  
 Alarm 1 must be assigned.  
 The Heater Overcurrent Use parameter must be set to ON.



This parameter sets the current value for heater overcurrent alarm outputs.

- A heater overcurrent alarm is output when the heater current exceeds the value set for this parameter.
- When the set value is 50.0, the heater overcurrent alarm is turned OFF. When the set value is 0.0, the heater overcurrent alarm is turned turn ON.



Setting range	Unit	Default
0.0 to 50.0	A	50.0



■ **Related Parameters**

Heater current 2 value monitor (adjustment level): Page 192  
 Heater overcurrent use, Heater overcurrent latch, Heater overcurrent hysteresis (advanced function setting level): Page 283, 284

L[R 1

**Leakage Current 1 Monitor**

Heater burnout, HS alarms, and heater overcurrent detection must be supported.  
 Alarm 1 must be assigned.  
 The HS Alarm parameter must be set to ON.



This parameter measures the heater current from the CT input used for detecting SSR short-circuits.  
 This parameter measures and displays the heater current when the heater is OFF.

- HS alarms are not detected if the control output (heating) OFF time is 100 ms or less.



Monitor

Monitor range	Unit
0.0 to 55.0	A

- *FFFF* is displayed when 55.0 A is exceeded.
- If an HS alarm 1 alarm is output, the HA indicator will light and the No. 1 display for the leakage current 1 monitor will flash.



#### ■ Related Parameters

HS alarm 1, HS alarm 2 (adjustment level): Page 214

HS alarm use (advanced function setting level): Page 270

Error displays *LER 1*: Page 320

## HS 1

### HS Alarm 1

Heater burnout, HS alarms, and heater overcurrent detection must be supported.  
Alarm 1 must be assigned.  
The HS Alarm parameter must be set to ON.



Function

This parameter sets the current for the HS alarm to be output.

- An HS alarm is output when the leakage current value exceeds the setting of this parameter.
- When the set value is 50.0, the HS alarm output is turned OFF. When the set value is 0.0, the HS alarm output is turned ON.



Setting

Setting range	Unit	Default
0.0 to 50.0	A	50.0



#### ■ Related Parameters

Leakage current 1 monitor (adjustment level): Page 213

HS alarm, HS alarm latch, HS alarm hysteresis (advanced function setting level): Page 270

## LCR2

### Leakage Current 2 Monitor

Heater burnout, HS alarms, and heater overcurrent detection must be supported (two CTs).  
Alarm 1 must be assigned.  
The HS Alarm parameter must be set to ON.



Function

This parameter measures the heater current from the CT input used for detecting SSR short-circuits.

This parameter measures and displays the heater current value.

- HS alarms are not detected if the control output (heating) OFF time is 100 ms or less.



Monitor

Monitor range	Unit
0.0 to 55.0	A

- FFFF is displayed when 55.0 A is exceeded.
- If an HS alarm 2 alarm is output, the HA indicator will light and the No. 1 display for the leakage current 2 monitor will flash.



■ **Related Parameters**

- HS alarm 1, HS alarm 2 (adjustment level): Page 214
- HS alarm use (advanced function setting level): Page 270
- Error displays LERR2: Page 320

H52

**HS Alarm 2**

Heater burnout, HS alarms, and heater overcurrent detection must be supported (two CTs). Alarm 1 must be assigned. The HS Alarm parameter must be set to ON.

This parameter sets the current for the HS alarm to be output.

- An HS alarm is output when the leakage current value exceeds the setting of this parameter.
- When the set value is 50.0, the HS alarm output is turned OFF. When the set value is 0.0, the HS alarm output will turn ON.



Function



Setting

Setting range	Unit	Default
0.0 to 50.0	A	50.0



■ **Related Parameters**

- Leakage current 2 monitor (adjustment level): Page 214
- HS alarm use, HS alarm latch, HS alarm hysteresis (advanced function setting level): Page 270

LNS

**Temperature Input Shift**

The Input Type parameter must be set for a thermocouple or resistance thermometer, and the Input Shift Type parameter must be set to a one-point shift.

Sometimes an error occurs between the set point and the actual temperature. To offset this, a compensated value can be obtained by adding an input shift value to the input. The compensated value is displayed as the measurement value and used for control.



Function

The entire input range is shifted by a fixed rate (1-point shift). If the input shift value is set to -1°C, control will be performed for a value 1°C lower than the measured temperature.



Setting range	Unit	Default
-199.99 to 324.00	°C or °F	0.00



■ **Related Parameters**

Input type (initial setting level): Page 236

Input shift type (advanced function setting level): Page 268

**NSH**

**Upper-limit Temperature Input Shift Value**

The Input Type parameter must be set for a thermocouple or resistance thermometer and the Input Shift Type parameter must be set to a 2-point shift.

**NSL**

**Lower-limit Temperature Input Shift Value**



These parameters are used to shift the input temperature at two points: an upper-limit temperature and a lower-limit temperature (as opposed to the Temperature Input Shift parameter, which shifts the input temperature by setting the shift for only one point). A 2-point shift enables more accurate offset of the input range compared with a 1-point shift if the input shift values at the upper and lower limits differ.



This parameter sets input shift values for the upper and lower limits (2-point shift) of the input range.

Setting range	Unit	Default
-199.99 to 324.00	°C or °F	0.00



■ **Related Parameters**

Input type (initial setting level): Page 236

Input shift type (advanced function setting level): Page 268

**P**

**Proportional Band**

The control must be set to 2-PID control.

**I**

**Integral Time**

**d**

**Derivative Time**



These parameters set PID control constants. If auto-tuning is executed, these parameters are set automatically.

**P action:** Refers to control in which the MV is proportional to the deviation (control error).

**I action:** Refers to a control action that is proportional to the time integral of the deviation. With proportional control, there is normally an offset (control error). Proportional action is thus used in combination with integral action. As time passes, this control error disappears, and the control temperature (process value) comes to agree with the set point.

D action: Refers to a control action that is proportional to the time derivative of the control error. The proportional control and integral control correct for errors in the control result, and thus the control system is late in responding to sudden changes in temperature. The derivative action increases the MV in proportion to the slope of the change in the temperature as a corrective action.

- The set values are saved in the Proportional Band, Integral Time, and Derivative Time parameters for the selected PID set.



Parameter name	Models	Unit	Default
Proportional Band	Controllers with Temperature Inputs: 0.1 to 3,240.0	°C or °F	8.0
	Analog input: 0.1 to 999.9	%FS	10.0
Integral Time	Standard, heating/cooling, or position-proportional (close) control: 0.0 to 3,240.0	Second	233.0
	Position-proportional (floating) control: 0.1 to 3,240.0		
Derivative Time	0.0 to 3240.0	Second	40.0



■ **Related Parameters**

AT execute/cancel (adjustment level): Page 208

PID \* proportional band, PID \* Integral time, PID \* Derivative time (PID setting level): Page 227

[-5]

**Cooling Coefficient**

The control must be heating/cooling control and 2-PID control.

If the heating characteristics and cooling characteristics of the control object are very different and good control characteristics cannot be achieved with the same PID constants, the cooling coefficient can be used to adjust the proportional band (P) for the control output assigned to the cooling side.



- In heating/cooling control, the proportional band P for the cooling control output is calculated using the following formula to set the cooling coefficient:  
Cooling control output side P = Cooling coefficient × P (proportional band)
- When the Automatic Cooling Coefficient Adjustment parameter is set to ON, the cooling coefficient is set automatically when AT is executed. If there is strong non-linear gain for the cooling characteristics, however, it may not be possible to obtain the optimum cooling coefficient at the Controller.
- The set value is saved in the Cooling Coefficient parameter for the current PID set.



Setting range	Unit	Default
0.01 to 99.99	None	1.00



■ **Related Parameters**

Proportional band (adjustment level): Page 216

Automatic cooling coefficient adjustment (advanced function setting level):  
 Page 283  
 PID \* cooling coefficient (PID setting level): Page 229

**[ - db**

**Dead Band**

The control system must be set to heating/cooling control.



Function

This parameter sets the output dead band width for heating/cooling control. A negative setting sets an overlapping band.

- This parameter sets an area in which the control output is 0 centering around the set point for a heating/cooling control.



Setting

Model	Setting range	Unit	Default
Temperature input	-19999.9 to 3240.00	°C or °F	0.0
Analog input	-19.99 to 99.99	%FS	0.00

**̄F - R**

**Manual Reset Value**

The control must be standard control and 2-PID control.  
 The Integral Time parameter for PID sets 1 to 8 must be set to 0.



Function

- This parameter sets the required manipulated variable to remove offset during stabilization of P or PD control.



Setting

Setting range	Unit	Default
0.0 to 100.0	%	50.0



See

■ **Related Parameters**

- PID \* integral time (PID setting level): Page 227
- PID ON/OFF (initial setting level): Page 238

**HYS**

**Hysteresis (Heating)**

The control must be ON/OFF control.  
 For the Hysteresis (Cooling) parameter, the control must be heating/cooling control.

**[HYS**

**Hysteresis (Cooling)**



Function

This parameter sets the hysteresis for ensuring stable operation at the ON/OFF switching point.

- For standard control, use the Hysteresis (Heating) parameter. The Hysteresis (Cooling) parameter cannot be used.



- For heating/cooling control, the hysteresis can be set independently for heating/cooling. The Hysteresis (Heating) parameter is used for the heating side, and the Hysteresis (Cooling) parameter is used for the cooling side.



Parameter name	Model	Setting range	Unit	Default
Hysteresis (Heating)	Temperature input	0.1 to 3240.00	°C or °F	1.0
	Analog Input	0.01 to 99.99	%FS	0.10
Hysteresis (Cooling)	Temperature input	0.1 to 3240.00	°C or °F	1.0
	Analog Input	0.01 to 99.99	%FS	0.10



■ **Related Parameters**

PID ON/OFF, Standard or heating/cooling (initial setting level): Page 238

*Wt - b*

**Wait Band**

The Program Pattern parameter must not be set to OFF.



- This parameter sets the band for the wait operation as a deviation from the SP.
- The wait operation is not performed if the wait band is set to 0.



Model	Setting range	Unit	Default
Temperature input	OFF or 0.1 to 3240.0	°C or °F	OFF
Analog Input	OFF or 0.01 to 99.99	%FS	



■ **Related Information**

4-15 Program-related Functions: Page 138

**MV -R****MV at Reset**

Control must be set to 2-PID control.  
The MV at Reset and Error Addition parameter must be set to ON and the Reset Operation parameter must be set to Stopping Control.



Function

- This parameter sets the MV when switching between run status and reset status during Run/Reset control. However, if the reset operation is set to a fixed SP operation, the MV at reset is not used.



Setting

Setting range	Unit	Default
Standard control: -5.0 to 105.0 Heating/cooling control: -105.0 to 105.0 Position-proportional control (close, with the Direct Setting of Position Proportional MV parameter ON): -5.0 to 105.0	%	0.0
Position-proportional control (floating or with the Direct Setting of Positional Proportional MV parameter OFF): CLOS, HOLD, OPEN	None	HOLD



■ **Related Parameters**

Run/reset (operation level): Page 194

MV at reset and error addition (advanced function setting level): Page 269

**MV -E****MV at PV Error**

The control must be set to 2-PID control.  
The MV at Reset and Error Addition parameter must be set to ON.



Function

- This parameter sets the MV to use when an input error occurs.



Setting

Setting range	Unit	Default
Standard control: -5.0 to 105.0 Heating/cooling control: -105.0 to 105.0 Position-proportional control (close, with the Direct Setting of Position Proportional MV parameter ON): -5.0 to 105.0	%	0.0
Position-proportional control (floating or with the Direct Setting of Positional Proportional MV parameter OFF): CLOS, HOLD, OPEN	None	HOLD



■ **Related Parameters**

MV at reset and error addition (advanced function setting level): Page 269

$\bar{o}L-H$

**MV Upper Limit**

The control must be set to 2-PID control.

$\bar{o}L-L$

**MV Lower Limit**

Position-proportional (close) control must be supported.



Function

- The MV Upper Limit and MV Lower Limit parameters set the upper and lower limits of the manipulated variable. When the calculated manipulated variable exceeds the upper or lower limit value, the upper or lower limit value will be the output level.
- The set value is saved in the MV Upper Limit and MV Lower Limit parameters for the current PID set.
- MV Upper Limit  
The setting ranges during standard control, heating/cooling control, and position-proportional (close) control are different.



Setting

Control method	Setting range	Unit	Default
Standard	MV lower limit + 0.1 to 105.0	%	105.0
Heating/cooling	0.0 to 105.0		
Position proportional (close)	MV lower limit + 0.1 to 105.0		

- MV Lower Limit  
The setting ranges during standard control, heating/cooling control, and position-proportional (close) control are different. The manipulated variable for the cooling control output side during heating/cooling control is expressed as a negative value.

Control method	Setting range	Unit	Default
Standard	-5.0 to MV upper limit -0.1	%	-5.0
Heating/cooling	-105.0 to 0.0		-105.0
Position proportional (close)	5.0 to MV upper limit -0.1		-5.0

■ **Related Parameters**

PID ON/OFF (initial setting level): Page 238

PID \* MV upper limit, PID \* MV lower limit (PID setting level): Page 227



$\bar{o}RL$

**MV Change Rate Limit**

2-PID control must be used.



Function

- The MV Change Rate Limit parameter sets the maximum allowable variation in the MV (valve opening for position-proportional models) per second. If the change in the MV exceeds this setting, the MV will be changed by the MV change rate limit until the calculated value is reached. If the limit is set to 0.0, this function will be disabled.
- The MV Change Rate Limit parameter will not operate in the following situations.
  - In manual mode
  - During AT execution

- During ON/OFF control
- While resetting (during MV output when resetting)
- During MV output when error occurs



Setting range	Unit	Default
0.0 to 100.0	%/s	0.0



■ **Related Parameters**

Proportional band (adjustment level): Page 216

**db**

**Position Proportional Dead Band**

Position-proportional control must be supported.



- This parameter sets the output hold interval (the ON/OFF switching interval between the open and close outputs) for position-proportional control.



Setting range	Unit	Default
Position proportional (close): 0.1 to 10.0	%	4.0
Position proportional (floating): 0.1 to 10.0	%	2.0



■ **Related Parameters**

Open/close hysteresis (adjustment level): Page 222

**āC-H**

**Open/Close Hysteresis**

Position-proportional control must be supported.



- This parameter provides hysteresis in position-proportional control when the open and close outputs are switched ON or OFF.



Setting range	Unit	Default
0.1 to 20.0	%	0.8



■ **Related Parameters**

Position proportional dead band (adjustment level): Page 222

**SQRP**

**Extraction of Square Root Low-cut Point**

The input type must be an analog input, and the Extraction of Square Root Enable parameter must be set to ON.



- This parameter sets the extraction of square root low-cut point used for the inputs. The data after extracting the square root is shown below.
- The low-cut point is used for extracting the square root for flowrate sensors.

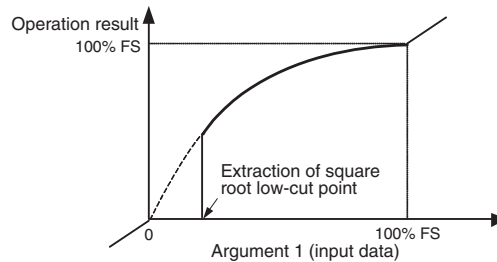

Setting range	Unit	Default
0.0 to 100.0	%	0.0



■ **Related Parameters**

Extraction of square root enable (initial setting level): Page 223

**5tb**

**Standby Time**



- This parameter is used to set the time from when the run command is executed until the program starts operation.



Setting range	Unit	Default
0.00 to 99.59 (hours and minutes)	Hours and minutes, or	0.00
0.00 to 99.23 (days and hours)	days and hours	

**Note** The unit is set in the Standby Time Unit parameter. (The default is H-M (hours and minutes).)



■ **Related Information**

4-15 Program-related Functions: Page 138

■ **Related Parameters**

Standby time unit (advanced function setting level): Page 294

P5P5

## Program SP Shift Value

The Program SP Shift Value Addition parameter must be set to ON.



- This parameter performs a fixed-rate compensation (1-point compensation) for the program SP (PSP).
- During temperature input, the decimal point position depends on the currently selected sensor, and during analog input it depends on the Decimal Point parameter setting.



Setting range	Unit	Default
-19,999 to 32,400	EU	0.0



■ **Related Information**

4-15 Program-related Functions: Page 138

■ **Related Parameters**

Program SP Shift Addition (advanced function Setting Level): Page 294

R50 to R5 10  
bC0 to bC 10

RSP 0 to RSP 10 before Correction  
Broken-line Correction Value 0 to 10

The RSP Broken-line Correction Display Addition parameter must be set to ON.



- Broken-line correction value can be set for 10 points for remote SPs.
- The value of the RSP correction is calculated using the following formula.

$$\text{RSP correction value} = \frac{\text{Broken-line correction value } n - \text{Broken-line correction value } n-1}{\text{RSP } n \text{ before correction} - \text{RSP } n-1 \text{ before correction}} \times (\text{RSP} - \text{RSP } n-1 \text{ before correction}) + \text{Broken-line correction value}$$

If RSP is lower than RSP 0 before correction, then the RSP correction value equals broken-line correction value 0.

If RSP n before correction is less than or equal to RSP k before correction (when K = 0 to h-1), then RSP n before correction and broken-line correction value n are disabled.

If RSP is greater than RSP 10 before correction, then the RSP correction value equals broken-line correction value 10.

Example) RSP 0 before correction (RS0) = 100°C  
 RSP 1 before correction (RS1) = 200°C  
 Broken-line Correction Value 0 (BC0) = 5°C  
 Broken-line Correction Value 1 (BC1) = 10°C  
 Here, the RSP input value is 150°C.

$$\frac{10^\circ\text{C} - 5^\circ\text{C}}{200^\circ\text{C} - 100^\circ\text{C}} \times (150^\circ\text{C} - 100^\circ\text{C}) + 5^\circ\text{C} = 7.5^\circ\text{C}$$

The result after calculating the correction is 150°C + 7.5°C = 157.5°C.

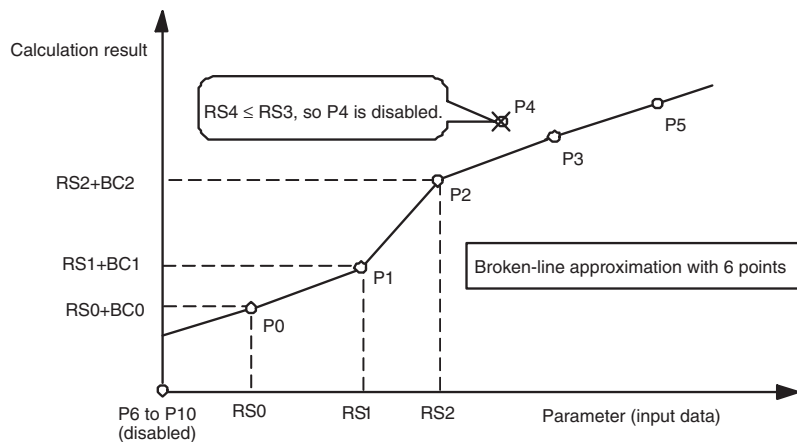

Parameter	Setting range	Default
RSP 0 to RSP 10 before Correction	Remote SP lower limit to remote SP upper limit	-200.0
Broken-line Correction Value 0 to 10	-19,999 to 32,400	0



■ **Related Information**

4-15 Program-related Functions: Page 138

## 5-6 PID Setting Level

The PID setting level is used to make settings such as PID values for each PID set and MV limit values. Move to a particular PID set from the Display PID Set Selection parameter, which is displayed first in the PID setting level.

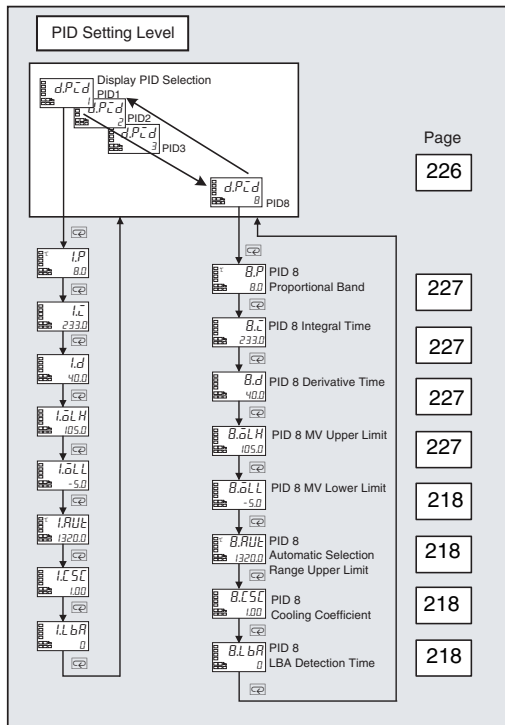
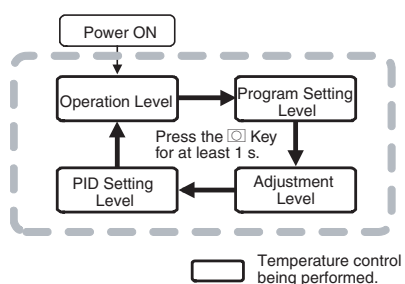

d.P.L.d

### Display PID Selection



Function



Setting

This parameter is used to select the PID set for making the display settings.

- This parameter selects the PID set for which the display settings are to be made.
- Up to eight sets (1 to 8) can be used. The following items registered in each set: PID value, MV upper and lower limits, automatic selection range upper limit, cooling coefficient, and LBA detection time.

Setting range	Default
1 to 8	See note.

**Note** The current PID set will be displayed. If you use the U and D Keys to change the PID set, the monitor function will be canceled.

#### ■ Related Parameters

PID set number (program setting level): Page 201



See







- **MV Upper Limit**  
The setting range depends on whether standard, position-proportional (closed) control, or heating/cooling control is used. In addition, the cooling MV during heating/cooling control is expressed as a negative value.

Control method	Setting range	Unit	Default
Standard	MV lower limit + 0.1 to 105.0	%	105.0
Heating/cooling	0.0 to 105.0		
Position-proportional (closed)	MV lower limit + 0.1 to 105.0		

- **MV Lower Limit**  
The setting range depends on whether standard, position-proportional (closed) control, or heating/cooling control is used. In addition, the cooling MV during heating/cooling control is expressed as a negative value.

Control method	Setting range	Unit	Default
Standard	-5.0 to MV upper limit - 0.1	%	-5.0
Heating/cooling	-105.0 to 0.0		-105.0
Position-proportional (closed)	-5.0 to MV upper limit - 0.1		-5.0



- **Related Parameters**  
PID ON/OFF: Page 238

\*.RUL

**PID \* Automatic Selection Range Upper Limit (\*: 1 to 8)**

2-PID control must be used.



These parameters set the upper limit for each PID set when PID sets are selected automatically.

- These parameters are used to set the automatic selection range upper limits for PID sets 1 to 8.
- The sensor setting range for PID set 8 is the upper limit of the specified range for a temperature input and 105.0% for an analog input. This parameter cannot be set.
- These values apply to the PV (process value), DV (deviation), or SP (set point) set in the PID Set Automatic Selection Data parameter. The default setting is PV.



Setting range	Unit	Default
Temperature: -19,999 to 32,400	EU	1320.0
Analog: -5.0 to 105.0	%	105.0



- **Related Parameters**  
PID set automatic selection data (advanced function setting level): Page 280

\*.L5C

**PID \* Cooling Coefficient**  
(\*: 1 to 8)

Heating and cooling control and 2-PID control must be used.



Function

If the heating and cooling characteristics of the control object are very different and good control characteristics cannot be achieved with the same PID constants, the cooling coefficient can be used to adjust the proportional band (P) for the control output assigned to the cooling side. One parameter is set for each PID set.

- In heating/cooling control, the proportional band P for the cooling control output is calculated using the following formula to set the cooling coefficient:  
Cooling control output side P = Cooling coefficient × P (proportional band)
- The cooling coefficient will be set automatically if autotuning is executed when the Automatic Cooling Coefficient Adjustment parameter is set to ON. The execution results will be saved in the PID set where autotuning was started. If non-linearity is strong in the cooling characteristics, however, this function may not find the optimum cooling coefficient.



Setting

Setting range	Unit	Default
0.01 to 99.99	None	1.00

■ **Related Parameters**

PID (\*) proportional band (PID setting level): Page 227



See

\*.LbR

**PID \* LBA Detection Time**  
(\*: 1 to 8)

2-PID control must be used.  
Alarm 1 must be assigned.  
The alarm 1 type must be 12 (LBA).



Function

These parameters set whether the LBA function is to be enabled or disabled and sets the time interval for detection, for each PID set.

- These parameters set the time interval for detecting the LBA.
- Setting 0 disables the LBA function.
- For ON/OFF control, make the setting in the LBA Detection Time parameter in the advanced function setting level.



Setting

Setting range	Unit	Default
0 to 9999	s	0

■ **Related Parameters**

Alarm 1 type (initial setting level): Page 240  
LBA level (advanced function setting level): Page 272  
LBA band (advanced function setting level): Page 272



See

## 5-7 Monitor/Setting Item Level

Monitor/setting items can be displayed by means of the PF key when the PF Setting parameter (advanced function setting level) is set to PFDP: Monitor/Setting Item (for the E5AN/EN-HT only).

For the E5CN-HT, press the + Keys simultaneously for at least one second to implement the PF Key.

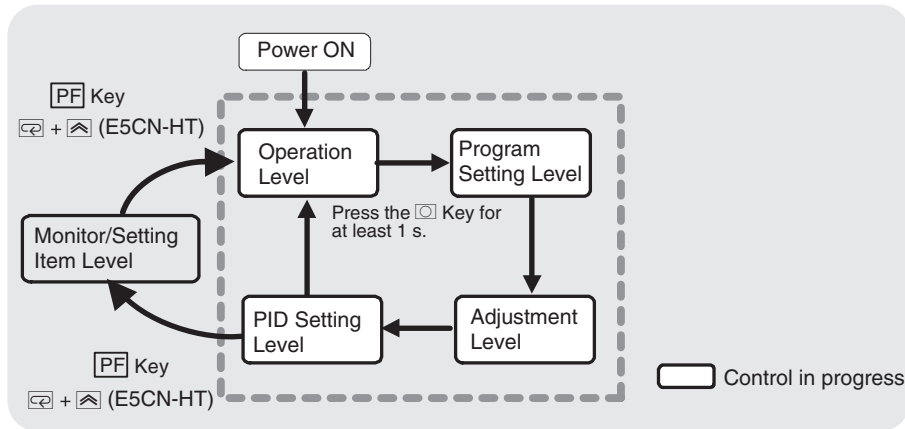

### Monitor/Setting Item Display 1 to 5

The PF Setting parameter must be set to PFDP, and the Monitor/Setting Item 1 to 5 parameters must not be set to OFF.



Function

- When the PF Key is set to display monitor/setting items, pressing the PF Key will display in order the contents of the Monitor/Setting Item 1 to 5 parameters. The contents of these parameters are shown in the following table. For the setting (monitor) ranges, refer to the applicable parameters.

Set value	Setting	Monitor/Setting	Characters
0	Disabled		
1	PV, SP, Program No., and Segment No.	Can be set. (SP) (See note 1.)	Numeric display No. 1 display: PV
2	PV/SP/MV	Can be set. (SP) (See notes 1 and 2.)	No. 2 display: SP No. 3 display: Specified data (A and E types only)
3	PV/SP/Remaining segment time	Can be set. (SP) (See note 1.)	

Set value	Setting	Monitor/Setting	Characters	
4	Proportional band (See note 3.)	Can be set.	No. 1 display: $P$	No. 2 display: Parameter No. 3 display: Nothing displayed.
5	Integral time (See note 3.)	Can be set.	No. 1 display: $I$	
6	Derivative time (See note 3.)	Can be set.	No. 1 display: $D$	
7	Alarm value 1 (See note 4.)	Can be set.	No. 1 display: $AL - 1$	
8	Alarm value upper limit 1 (See note 4.)	Can be set.	No. 1 display: $AL 1H$	
9	Alarm value lower limit 1 (See note 4.)	Can be set.	No. 1 display: $AL 1L$	
10	Alarm value 2 (See note 4.)	Can be set.	No. 1 display: $AL - 2$	
11	Alarm value upper limit 2 (See note 4.)	Can be set.	No. 1 display: $AL 2H$	
12	Alarm value lower limit 2 (See note 4.)	Can be set.	No. 1 display: $AL 2L$	
13	Alarm value 3 (See note 4.)	Can be set.	No. 1 display: $AL - 3$	
14	Alarm value upper limit 3 (See note 4.)	Can be set.	No. 1 display: $AL 3H$	
15	Alarm value lower limit 3 (See note 4.)	Can be set.	No. 1 display: $AL 3L$	
16	Program number	Can be set.	No. 1 display: $PRG$	
17	Segment number	Cannot be set.	No. 1 display: $SEG$	
18	Elapsed program time	Cannot be set.	No. 1 display: $PRGE$	
19	Remaining program time	Cannot be set.	No. 1 display: $PRGR$	
20	Elapsed segment time	Cannot be set.	No. 1 display: $SEGE$	
21	Remaining segment time	Cannot be set.	No. 1 display: $SEGR$	

- Note**
- (1) If there is no No. 3 display, only the PV and SP are displayed.
  - (2) For standard models, the MV is displayed. For position-proportional models, the valve opening is displayed. For heating/cooling, select MV (heating) or MV (cooling) with the MV Display Selection parameter. Refer to *PV/SP Display Screen Selection* for information on the MV display selection.  
The SP can be selected only in Fixed SP Mode.
  - (3) The currently selected PID set number is displayed.
  - (4) The currently selected program number is displayed.

■ **Related Parameters**

PF setting (advanced function setting level): Page 285

Monitor/setting items 1 to 5 (advanced function setting level): Page 286



## 5-8 Manual Control Level

The manipulated variable can be set in manual mode while the PV/MV parameter is displayed.

The final MV used in automatic mode will be used as the initial manual MV when moving from automatic mode to manual mode. In manual mode, the change value will be saved immediately and reflected in the actual MV.

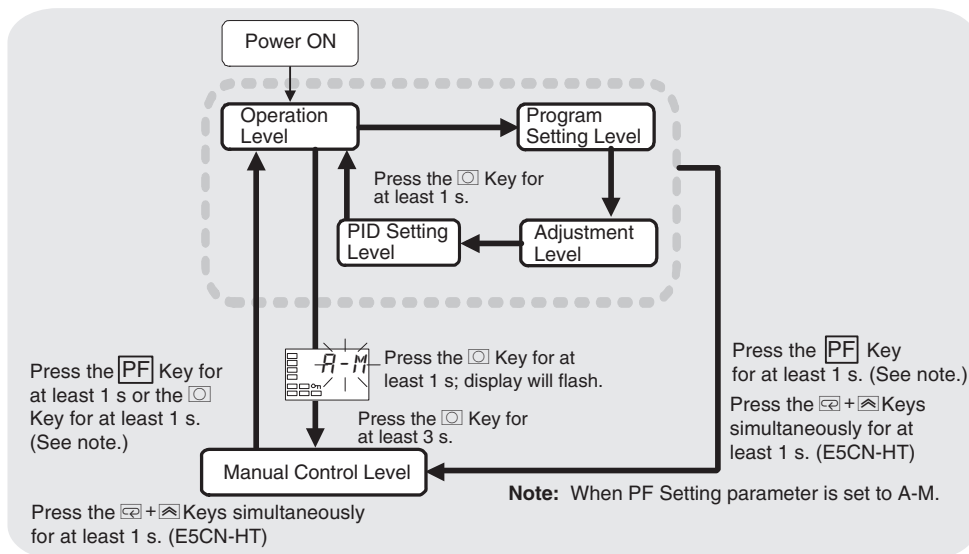

To move from the operation level to the manual control level, press the [ ] (circle) Key for at least three seconds with the Auto/Manual Switch parameter displayed. In addition, this operation can be performed using the PF Key by setting the PF Key parameter (advanced function setting level) to A-M (Auto/Manual). For details on the setting method, refer to 4-12 *Performing Manual Control*.

This setting cannot be made during ON/OFF operation.

- The MANU indicator will light during manual control.
- It is not possible to move to any displays except for the PV/MV parameter during manual operation.
- To return to the operation level, press the [ ] (circle) Key or the PF Key in the manual control level for at least one second.

### PV/MV (Manual MV)



The manual control level display appears as shown below.

With No. 3 Display

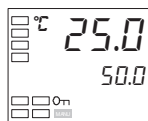

Without No. 3 Display

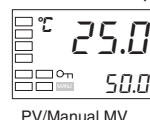

Note: When the PV/SP Display Screen Selection parameter is 0.

	Monitor range	Unit
Process value	Temperature: According to indication range for each sensor. Analog: Scaling lower limit -5% FS to Scaling upper limit +5% FS (Refer to page 351.)	EU

	Setting range	Unit	
MV (manual MV)	Standard control	-5.0 to 105.0 (See note 1.)	%
	Heating/cooling control	-105.0 to 105.0 (See note 1.)	
	Close position-proportional control with the Direct Setting of Position-proportional MV parameter set to ON	-105.0 to 105.0 (See note 1.)	
	Position-proportional control (floating position-proportional control or the Direct Setting of Position-proportional MV parameter set to OFF)	(See note 2.)	---

- Note**
- (1) When the Manual MV Limit Enable parameter is set to ON, the setting range will be the MV lowerlimit to the MV upper limit.
  - (2) If you display the Valve Opening Monitor parameter, the open output is turned ON if you press the Up Key and the close output is turned ON if you press the Down Key.



■ **Related Parameters**

4-12 Performing Manual Control: Page 126

Standard or Heating/Cooling (Initial Setting Level): Page 239

## 5-9 Initial Setting Level

This level is used to set up the basic Digital Controller specifications. In this level, you can set the Input Type parameter to set the sensor input to be connected, limit the setting range of set points, set the alarm modes, and perform other operations.

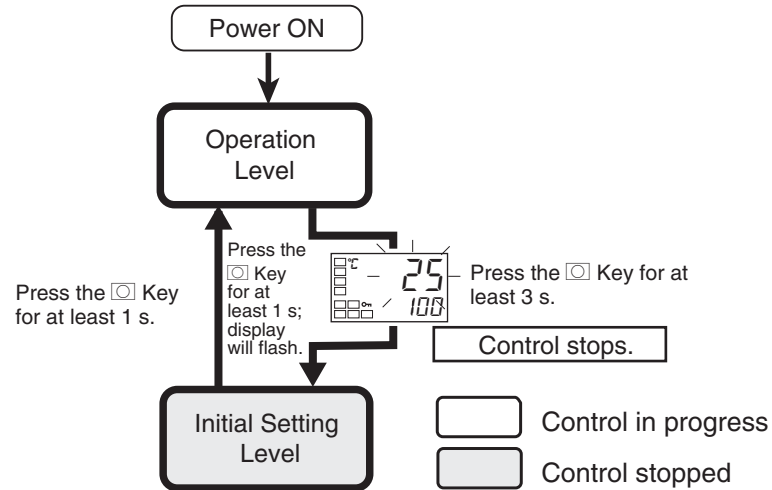

To move from the operation level to the initial setting level, press the  Key for at least three seconds with any parameter displayed except for the Auto/Manual Switch parameter.

- The initial setting level is not displayed when the Initial/Communications Protect parameter is set to 2. It can be used when the Initial/Communications Protect parameter is set to 0 or 1.
- If the Input Type parameter is set for an analog input, the following parameters will be set: Scaling upper limit, Scaling lower limit, and Decimal point.



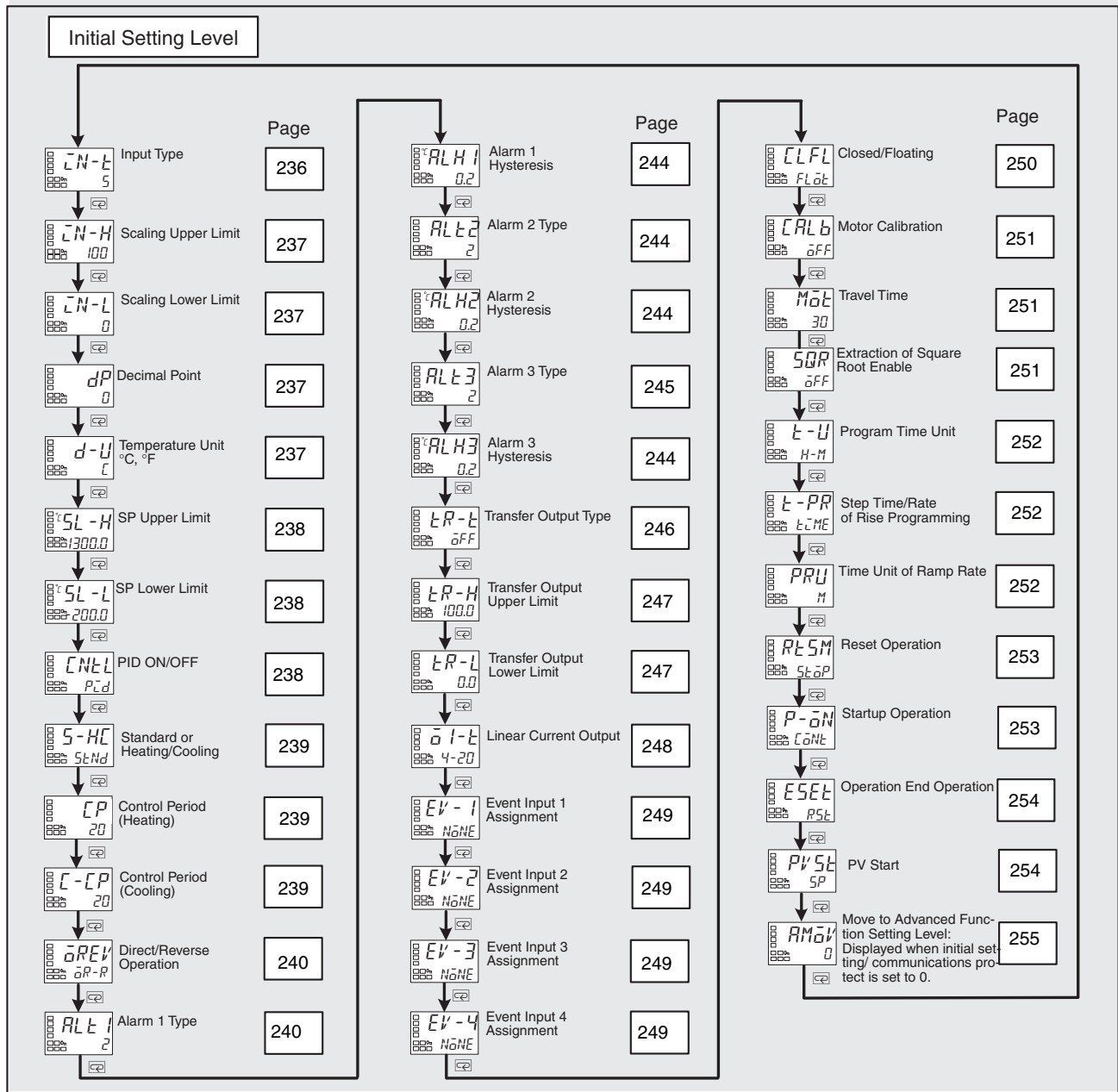

IN-E

## Input Type



Function



Setting

- This parameter sets the type of sensor.
- When this parameter is changed, the set point limiter is changed to the defaults. If the limiter must be specified, set the SP Upper Limit and SP Lower Limit parameters (initial setting level) again.
- Set one of the set values from the following table. The default is 5.
- If a platinum resistance thermometer is mistakenly connected while a setting for other than a platinum resistance thermometer is in effect, S.ERR will be displayed. To clear the S.ERR display, check the wiring and then cycle the power.

Input type	Specifications	Set value	Input temperature range
Platinum resistance thermometer	Pt100	0	-200.0 to 850.0 (°C)/-300.0 to 1,500.0 (°F)
		1	-199.9 to 500.0 (°C)/-199.9 to 900.0 (°F)
		2	0.0 to 100.0 (°C)/0.0 to 210.0 (°F)
	JPt100	3	-199.9 to 500.0 (°C)/-199.9 to 900.0 (°F)
		4	0.0 to 100.0 (°C)/0.0 to 210.0 (°F)
Thermocouple	K	5	-200.0 to 1,300.0 (°C)/-300.0 to 2,300.0 (°F)
		6	-20.0 to 500.0 (°C)/0.0 to 900.0 (°F)
	J	7	-100.0 to 850.0 (°C)/-100.0 to 1,500.0 (°F)
		8	-20.0 to 400.0 (°C)/0.0 to 750.0 (°F)
	T	9	-200.0 to 400.0 (°C)/-300.0 to 700.0 (°F)
		10	-199.9 to 400.0 (°C)/-199.9 to 700.0 (°F)
	E	11	-200.0 to 600.0 (°C)/-300.0 to 1,100.0 (°F)
	L	12	-100.0 to 850.0 (°C)/-100.0 to 1,500.0 (°F)
	U	13	-200.0 to 400.0 (°C)/-300.0 to 700.0 (°F)
		14	-199.9 to 400.0 (°C)/-199.9 to 700.0 (°F)
	N	15	-200.0 to 1,300.0 (°C)/-300.0 to 2,300.0 (°F)
	R	16	0.0 to 1,700.0 (°C)/0.0 to 3,000.0 (°F)
	S	17	0.0 to 1,700.0 (°C)/0.0 to 3,000.0 (°F)
	B	18	100.0 to 1,800.0 (°C)/300.0 to 3,200.0 (°F)
	W	19	0.0 to 2,300.0 (°C)/0.0 to 3,200.0 (°F)
	PLII	20	0.0 to 1,300.0 (°C)/0.0 to 2,300.0 (°F)
	K	21	-50.0 to 200.0 (°C)/-50.0 to 200.0 (°F)
	J	22	-50.0 to 200.0 (°C)/-50.0 to 200.0 (°F)
	T	23	-50.0 to 200.0 (°C)/-50.0 to 200.0 (°F)
Platinum resistance thermometer	Pt100	24	-50.0 to 200.0 (°C)/-50.0 to 200.0 (°F)
Current input	4 to 20 mA	25	One of the following ranges depending on the scaling. -19999 to 32400 -1999.9 to 3240.0 -199.99 to 324.00 -19.999 to 32.400
	0 to 20 mA	26	
Voltage input	1 to 5 V	27	-19999 to 32400 -1999.9 to 3240.0 -199.99 to 324.00 -19.999 to 32.400
	0 to 5 V	28	
	0 to 10 V	29	

■ **Related Parameters**

Temperature unit, Set point upper limit, Set point lower limit (initial setting level): Page 237



See

┌N-H  
┌N-L  
dP

**Scaling Upper Limit**  
**Scaling Lower limit**  
**Decimal Point**

The input type must be set for an analog input.



- These parameters can be used when the input type is set for an analog input.
- When an analog input is used, scaling is performed. Set the upper limit in the Scaling Upper Limit parameter and the lower limit in the Scaling Lower Limit parameter.
- The Decimal Point parameter specifies the decimal point position of parameters (set point, etc.) whose unit is EU.
- Scaling Upper Limit, Scaling Lower Limit



Parameter name	Setting range	Unit	Default
Scaling Upper Limit	Scaling lower limit + 1 to 32400	None	100
Scaling Lower Limit	-19999 to scaling upper limit - 1	None	0

- Decimal Point

Parameter name	Setting range	Default
Decimal Point	0 to 3	0

Set value	Settings	Example
0	0 digits past decimal point	12345
1	1 digits past decimal point	1234.5
2	2 digits past decimal point	123.45
3	3 digits past decimal point	12.345



■ **Related Parameters**

Input type (initial setting level): Page 236

d-U

**Temperature Unit**

The input type must be set for a temperature input.



- Set the temperature input unit to either °C or °F.



Setting range	Default
┌: °C, F: °F	┌



■ **Related Parameters**

Input type (initial setting level): Page 236

5L -H            SP Upper Limit  
5L -L            SP Lower Limit



- These parameters set the upper and lower limits of the set points. A set point can be set within the range defined by the upper and lower limit set values in the SP Upper Limit and SP Lower Limit parameters. If these parameters are reset, any set point that is outside of the new range will be forcibly changed to either the upper limit or the lower limit.
- When the temperature input type and temperature unit have been changed, the set point upper limit and set point lower limit are forcibly changed to the upper and lower limits of the sensor.
- During temperature input, the decimal point position depends on the currently selected sensor, and during analog input it depends on the Decimal Point parameter setting.



Controllers with Universal Thermocouple/Resistance Thermometer/Analog Inputs

Parameter name		Setting range	Unit	Default
Set Point Upper Limit	Temperature	SP lower limit + 1 to Input setting range upper limit	EU	1300.0
	Analog	SP lower limit + 1 to scaling upper limit	EU	
Set Point Lower Limit	Temperature	Input setting range lower limit to SP upper limit - 1	EU	-200.0
	Analog	Scaling lower limit to SP upper limit - 1	EU	

■ **Related Parameters**

Input type: Page 236, Temperature unit: Page 237 (initial setting level)



ENL            PID ON/OFF



- This parameter selects 2-PID control or ON/OFF control.
- Auto-tuning can be used for 2-PID control.



Setting range	Default
P <sub>cd</sub> : 2-PID, aNāF: ON/OFF	P <sub>cd</sub>

■ **Related Parameters**

AT execute/cancel: Page 208, Manual reset, Hysteresis (heating), and Hysteresis (cooling): Page 218 (adjustment level)



**5-HC Standard or Heating/Cooling**



- This parameter selects standard control or heating/cooling control.
- When heating/cooling control is selected for the E5CN-HT (for a model which does not support control output 2), the auxiliary output 2 terminal (SUB2) is assigned as the control output (cooling).

**Note** If you select standard control, set the Control Output 1 Assignment parameter to  $\bar{a}$  (heating control output) for either a direct (cooling) or reverse (heating) application.



Setting range	Default
5tNd: Standard, H-C: Heating/cooling	5tNd



■ **Related Parameters**

MV monitor (heating): Page 194, MV monitor (cooling): Page 194 (operation level)

Cooling coefficient, Dead band: Page 217, Hysteresis (heating), Hysteresis (cooling): Page 218 (adjustment level)

Control period (heat), Control period (cool) (initial setting level): Page 239

Control output 1 assignment: Page 273, Control output 2 assignment, Auxiliary output 1 assignment: Page 275, Auxiliary output 2 assignment: Page 276, Auxiliary output 3 assignment: Page 277 (advanced function setting level)

**CP Control Period (Heating)**

The cooling control output and heating control outputs must be assigned to relay outputs, voltage outputs (for driving SSR).

The control must be set to 2-PID control.

**C-CP Control Period (Cooling)**

For the Control Period (Cooling) parameter, the control must be set to heating/cooling control.



- These parameters set the output periods. Set the control periods taking the control characteristics and the electrical durability of the relay into consideration.
- For standard control, use the Control Period (Heating) parameter. The Control Period (Cooling) parameter cannot be used.
- When the heating control output is a current output or linear voltage output, the Control Period (Heating) parameter cannot be used.

- For heating/cooling control, the control period can be set independently for heating and cooling. The Control Period (Heating) parameter is used for the heating control output, and the Control Period (Cooling) parameter is used for the cooling control output



Parameter name	Setting range	Unit	Default
Control Period (Heating)	0.5 or 1 to 99	Second	20
Control Period (Cooling)	0.5 or 1 to 99	Second	20



■ **Related Parameters**

PID ON/OFF (initial setting level): Page 238

**REV**

**Direct/Reverse Operation**



- “Direct operation” refers to control where the manipulated variable is increased when the process value increases. Alternatively, “reverse operation” refers to control where the manipulated variable is increased when the process value decreases.



Setting range	Default
$\bar{a}R-R$ : Reverse operation, $\bar{a}R-d$ : Direct operation	$\bar{a}R-R$

**AL1**

**Alarm 1 Type**

Alarm 1 must be assigned.









- Select one of the following six alarm 1 types: Deviation, deviation range, absolute value, LBA, PV change rate alarm, or RSP alarm.

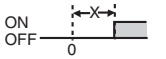
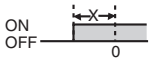
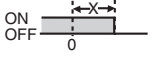
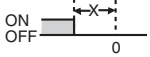
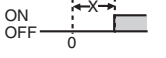

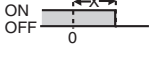
Set values	Alarm type	Alarm output operation		Function
		When alarm value X is positive	When alarm value X is negative	
0	Alarm function OFF	Output OFF		No alarm function.
1	Upper- and lower-limit (See note 1.)		(See note 2.)	The positive deviation in the SP is set using the alarm upper limit (H) and the negative deviation is set using the alarm lower limit (L).  The alarm is ON when the PV is outside this deviation range.

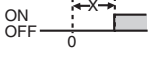
Set values	Alarm type	Alarm output operation		Function
		When alarm value X is positive	When alarm value X is negative	
2	Upper-limit			<p>The alarm value (X) is set as a positive deviation in the SP.</p> <p>The alarm is ON when the PV is higher than the SP by the deviation or more.</p>
3	Lower-limit			<p>The alarm value (X) is set as a negative deviation in the SP.</p> <p>The alarm is ON when the PV is lower than the SP by the deviation or more.</p>
4	Upper- and lower-limit range (See note 1.)		(See note 3.)	<p>The positive deviation in the SP is set using the alarm upper limit (H) and the negative deviation is set using the alarm lower limit (L).</p> <p>The alarm is ON when the PV is inside this deviation range.</p>
5	Upper- and lower-limit with standby sequence (See note 1.)	<p>(See note 5.)</p>	(See note 4.)	<p>This alarm type adds a standby sequence to alarm type 1 (upper- and lower-limit alarm). (See note 7.)</p>
6	Upper-limit with standby sequence			<p>This alarm type adds a standby sequence to alarm type 2 (upper-limit alarm). (See note 7.)</p>
7	Lower-limit with standby sequence			<p>This alarm type adds a standby sequence to alarm type 3 (lower-limit alarm). (See note 7.)</p>

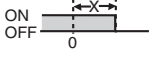
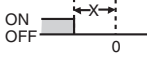
Set values	Alarm type	Alarm output operation		Function
		When alarm value X is positive	When alarm value X is negative	
8	Absolute-value upper-limit			This alarm type turns ON the alarm when the PV is higher than the alarm value (X), regardless of the value of the SP.
9	Absolute-value lower-limit			This alarm type turns ON the alarm when the PV is lower than the alarm value (X), regardless of the value of the SP.
10	Absolute-value upper-limit with standby sequence			This alarm type adds a standby sequence to alarm type 8 (absolute-value upper-limit alarm). (See note 7.)
11	Absolute-value lower-limit with standby sequence			This alarm type adds a standby sequence to alarm type 9 (absolute-value lower-limit alarm). (See note 7.)
12	LBA (alarm 1 type only)	---		(See note 8.)
13	PV change rate alarm	---		(See note 9.)
14	Remote SP absolute value upper limit (See note 6.)			This alarm type turns ON the alarm when the remote SP (RSP) is higher than the alarm value (X). It also functions in Program SP Mode, Fixed SP Mode, and Remote SP Mode.
15	Remote SP absolute value lower limit (See note 6.)			This alarm type turns ON the alarm when the remote SP (RSP) is lower than the alarm value (X). It also functions in Program SP Mode, Fixed SP Mode, and Remote SP Mode.



**Note** (1) With set values 1, 4 and 5, the upper- and lower- limit values can be set independently for each alarm type, and are expressed as “L” and “H.”

(2) Set value: 1 (Upper- and lower-limit alarm)

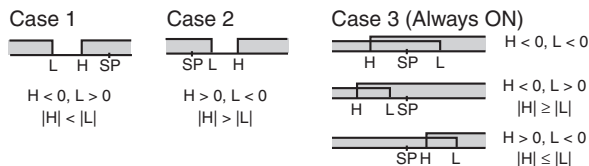

(3) Set value: 4 (Lower limit range)

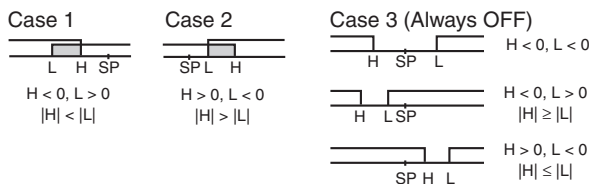

(4) Set value: 5 (Upper- and lower-limit with standby sequence)

- For the lower-limit alarms in cases 1 and 2 above, the alarm is normally OFF if upper- and lower-limit hysteresis overlaps.
- In case 3, the alarm is always OFF.

(5) Set value: 5 (The alarm is always OFF if upper- and lower-limit alarm hysteresis with standby sequence overlaps.)

(6) Displayed when remote SP input is supported.

- Set the alarm type independently for each alarm in the Alarm 1 to 3 Type parameters in the initial setting level. The default is 2 (Upper-limit alarm).

■ **Related Parameters**

Alarm value 1: Page 201, Alarm upper limit 1, Alarm lower limit 1: Page 202 (program setting level)

Standby sequence reset: Page 258, Auxiliary output 1 open in alarm: Page 259, Alarm 1 hysteresis: Page 244, Alarm 1 latch: Page 263 (advanced function setting level)



<b>ALH1</b>	<b>Alarm 1 Hysteresis</b>	Alarm 1 must be assigned. The alarm 1 type must not be 0, 12, or 13.
<b>ALH2</b>	<b>Alarm 2 Hysteresis</b>	Alarm 2 must be assigned. The alarm 2 type must not be 0, 12, or 13.
<b>ALH3</b>	<b>Alarm 3 Hysteresis</b>	Alarm 3 must be assigned. The alarm 3 type must not be 0, 12, or 13.



- These parameters set the hysteresis for alarms 1, 2, and 3.



Models	Unit	Default
Temperature input: 0.1 to 3,240.0	°C or °F	0.2
Analog input: 0.01 to 99.9	%FS	0.02



■ **Related Parameters**

Alarm values 1 to 3: Page 201, Alarm upper limits 1 to 3, Alarm lower limits 1 to 3: Page 202 (program setting level)  
 Alarm 1 to 3 type (initial setting level): Page 240, 244, 245  
 Standby sequence reset: Page 258, Alarm 1 to 3 open in alarm: Page 263, Alarm 1 to 3 latch: Page 263 (advanced function setting level)

<b>ALL2</b>	<b>Alarm 2 Type</b>	Alarm 2 must be assigned.
-------------	---------------------	---------------------------



- Select one of the following five alarm 2 types: Deviation, deviation range, absolute value, PV change rate alarm, or RSP alarm.



Refer to the alarm 1 type list. The 12: LBA (Loop Burnout Alarm) setting cannot be used.



■ **Related Parameters**

Alarm value 2, Alarm upper limit 2, Alarm lower limit 2: Page 201 (program setting level)  
 Standby sequence reset: Page 258, Auxiliary output 2 open in alarm: Page 259, Alarm 2 hysteresis: Page 244  
 Alarm 2 latch (advanced function setting level): Page 263

RL E3

**Alarm 3 Type**

Alarm 3 must be assigned.

- Select one of the following five alarm 3 types:  
Deviation, deviation range, absolute value, PV change rate alarm, or RSP alarm.



Setting

Refer to the alarm 1 type list. The 12: LBA (Loop Burnout Alarm) setting cannot be used.



■ **Related Parameters**

Alarm value 3: Page 201, Alarm upper limit 3, Alarm lower limit 3: Page 202 (program setting level)

Standby sequence reset: Page 258, Auxiliary output \* open in alarm: Page 259, Alarm 3 hysteresis: Page 244, Alarm 3 latch: Page 263 (advanced function setting level)

LR-L

## Transfer Output Type

There must be a transfer output, current output, or linear voltage output.

- This parameter sets the transfer output type.
- The following table shows the differences between models with a transfer output and models without a transfer output that use control output 1 or control output 2 as a simple transfer output.

#### ■ Transfer Output Destination

Transfer output	Control output 1	Control output 2	Transfer output destination
Yes	---	---	Transfer output
No	Current output or linear voltage output	No Relay output, voltage output (for driving SSR)	Control output 1
No	Current output or linear voltage output	Current output or linear voltage output	Control output 1
No	Relay output, voltage output (for driving SSR)	Current output or linear voltage output	Control output 2
No	Relay output, voltage output (for driving SSR)	No Relay output, voltage output (for driving SSR)	No

#### ■ Precision and User Calibration

	Precision	User calibration
Transfer output	±0.3% FS	Supported. (See note.)
Simple transfer output	Not specified.	Not supported.

**Note** For details on the calibration method, refer to *SECTION 6 CALIBRATION*.



Setting

Transfer output type		Default
OFF	OFF	OFF
Present SP	SP-M	
PV	PV	
MV monitor (heating)	MV	
MV monitor (cooling)	L-MV	
Valve opening	V-M	

#### ■ Related Parameter

Transfer output upper limit, Transfer output lower limit (initial setting level):  
Page 247



LR-H **Transfer Output Upper Limit**

A transfer output or linear voltage output must be supported.

LR-L **Transfer Output Lower Limit**

The Transfer Output Type parameter must not be set to OFF.



Function

- This parameter sets the upper and lower limit values of transfer outputs.



Setting

Transfer output type	Setting range		Default		Unit
			Transfer output lower limit	Transfer output upper limit	
Set point (See note 1.)	SP lower limit to SP upper limit		SP lower limit	SP upper limit	EU
PV	Temperature	Input setting range lower limit to input setting range upper limit	Input setting range lower limit	Input setting range upper limit	
	Analog	Analog scaling lower limit to analog scaling upper limit	Scaling lower limit	Scaling upper limit	
MV monitor (heating) (See note 2.)	Standard	-5.0 to 105.0	0.0	100.0	%
	Heating/cooling	0.0 to 105.0			
MV monitor (cooling) (See note 3.)	0.0 to 105.0				
Valve opening (See note 4.)	Position-proportional	-10.0 to 110.0			

- Note**
- (1) If the set point is selected, the remote SP will be output as long as the Remote SP Mode is selected in the SP Mode parameter.
  - (2) This setting will be ignored for position-proportional model.
  - (3) This setting will be ignored for standard control or position-proportional control.
  - (4) This parameter will be displayed only when there is a potentiometer input for a position-proportional model.

■ **Related Parameter**

Transfer output type (initial setting level): Page 246



$\bar{a} \text{ I-t}$ **Linear Current Output**

The E5CN-HT must be used, and the control output must be a current output.

This parameter selects the output type for linear current outputs.

- When control output 1 or control output 2 is a current output, select either 4 to 20 mA or 0 to 20 mA as the output type.



Setting

Linear current output	Default
4-20: 4 to 20 mA	4-20
0-20: 0 to 20 mA	

**Note** Even when control output 1 or control output 2 is used as a control output or a simple transfer output, 0 to 20 mA can be used.



■ **Related Parameter**

Transfer output type (initial setting level): Page 246

EV-\*

**Event Input Assignment \* (\*: 1 to 4)**

An event input must be assigned.



Function

- The following functions can be assigned to event inputs 1 to 4.
  - Run (OFF)/Reset (ON)
  - Run (ON)/Reset (OFF)
  - Auto/Manual Switch
  - Reset
  - Run
  - Hold/Clear Hold
  - Hold
  - Advance
  - Program Number Switch 0 to 2
  - Invert Direct/Reverse Operation
  - Program SP Mode/Remote SP Mode (E5AN/EN-HT only)
  - Remote SP Mode/Fixed SP Mode (E5AN/EN-HT only)
  - Program SP Mode/Fixed SP Mode
  - 100% AT Execute/Cancel
  - 40% AT Execute/Cancel
  - Setting Change Enable/Disable
  - Communications Write Enable/Disable
  - Alarm Latch Cancel
  - Wait Enable (ON)/Disable (OFF)
- Default: Models with Event Inputs 3 and 4
  - Event input assignment 1: *NONE*
  - Event input assignment 2: *NONE*
  - Event input assignment 3: *NONE*
  - Event input assignment 4: *NONE*

Models without Event Inputs 3 and 4  
 Event input assignment 1: *PR-1*  
 Event input assignment 2: *Adv*



Setting

Setting	Function
<i>NONE</i>	None
<i>PR-1</i>	Run (OFF)/Reset (ON)
<i>PR-2</i>	Run (ON)/Reset (OFF)
<i>MANU</i>	Auto/Manual Switch
<i>RSE</i>	Reset
<i>RUN</i>	Run
<i>HLd1</i>	Hold/Clear Hold
<i>HLd2</i>	Hold
<i>Adv</i>	Advance
<i>PRG0</i>	Program Number Switch 0
<i>PRG1</i>	Program Number Switch 1
<i>PRG2</i>	Program Number Switch 2
<i>dRS</i>	Invert Direct/Reverse Operation

Setting	Function
<i>SPM1</i>	Program SP Mode/Remote SP Mode (See note 1.)
<i>SPM2</i>	Remote SP Mode/Fixed SP Mode (See note 1.)
<i>SPM3</i>	Program SP Mode/Fixed SP Mode
<i>RE-2</i>	100% AT Execute/Cancel
<i>RE-1</i>	40% AT Execute/Cancel (See note 2.)
<i>WEPE</i>	Setting Change Enable/Disable (See note 3.)
<i>CMWE</i>	Communications Write Enable/Disable
<i>LRE</i>	Alarm Latch Cancel
<i>WRCE</i>	Wait Enable (ON)/Disable (OFF)

- Note**
- (1) E5AN/EN-HT only.
  - (2) These settings are possible for heating/cooling control, and floating control for position-proportional models, but the function is disabled.
  - (3) These settings can be used only for models with communications. If work bits are selected for the event input data, Communications Write Enable/Disable cannot be used.

---

**[LFL**
**Closed/Floating**

Position-proportional control must be supported and there must be a potentiometer input.



Function



Setting

- This parameter is used to select the control method for position-proportional control.

Setting range	Default
<i>FLot</i> : Floating	flot
<i>CLoS</i> : Closed	



[RLb

**Motor Calibration**

Position-proportional control must be supported and there must be a potentiometer input.



Function

- This parameter is used to calibrate a motor. It must be executed when monitoring valve opening. (The display cannot be changed during motor calibration.)
- The travel time is reset when motor calibration is executed.
- The setting becomes off after switching to this parameter.
- Motor calibration is executed when  $\bar{a}N$  is selected.
- The setting returns to  $\bar{a}FF$  after the motor calibration has been completed.

■ **Related Parameter**

Travel Time (initial setting level): Page 251

Möt

**Travel Time**

Position-proportional control must be supported.



Function

- This parameter sets the time from when the valve is completely open until it is completely closed.
- The travel time is set automatically when motor calibration is executed.



Setting

Setting range	Unit	Default
1 to 999	s	30

■ **Related Parameter**

Motor Calibration (initial setting level): Page 251

SQR

**Extraction of Square Root Enable**

An analog input must be supported.



Function

This parameter enables and disables square root extraction.



Setting

Setting range	Default
$\bar{a}N$ : Enabled, $\bar{a}FF$ : Disabled	None

■ **Related Parameter**

Extraction of square root low-cut point (adjustment level): Page 223

**ε-U Program Time Unit**



- This parameter sets the time unit for the program.
- This parameter sets the time unit for the following parameters. Always set this time unit before setting the following parameters.
  - Segment Times
  - Time Signal ON Times and Time Signal OFF Times



Setting range	Unit	Default
H-M: hours and minutes	---	H-M: hours and minutes
M-S: minutes and seconds		M: minutes

**ε-PR Step Time/Rate of Rise Programming**



- This parameter sets the programming method.



Setting range	Unit	Default
ε-ME: Step time	---	ε-ME: Step time
PR: Rate of rise programming		



■ **Related Information**

4-15 Program-related Functions: Page 138

**PRU Time Unit of Ramp Rate**

The Step Time/Rate of Rise Programming parameter must be set to Rate of Rise Programming.



- This parameter sets the time unit for rate of rise programming.



Setting range	Unit	Default
H: Hours	---	M: Minutes
M: Minutes		



■ **Related Information**

4-15 Program-related Functions: Page 138

■ **Related Parameters**

Step time/rate of rise programming (initial setting level): Page 252

**R<sub>L</sub>SM**

**Reset Operation**



Function

- This parameter sets the operation to perform when resetting.



Setting

Setting range	Unit	Default
S <sub>T</sub> OP: Stopping control	---	S <sub>T</sub> OP: Stopping control
F <sub>S</sub> P: Fixed SP operation		

**Note** If fixed SP operation is set, control while resetting will be performed with the set value of the Fixed SP parameter. Control will not stop.



■ **Related Information**

4-15 Program-related Functions: Page 138

**P-ON**

**Startup Operation**



Function

- The operation after power goes ON can be set to Continue, Reset, Run, or Manual Mode.
- The specified operation is also used for software resets and when moving from initial setting level to operation level.



Setting

Setting range	Unit	Default
C <sub>ON</sub> T: Continue	---	C <sub>ON</sub> T: Continue
R <sub>S</sub> E: Reset		
R <sub>UN</sub> : Run		
M <sub>ANU</sub> : Manual Mode		

**Note** If the PID ON/OFF parameter is set to ON/OFF, Manual Mode cannot be selected.



■ **Related Information**

3-12 Starting and Stopping Operation (rtsm): Page 89

E5E

Operation End Operation



Function

This parameter sets the operation to perform when the program has been completed.

- Reset: Operation ends
- Continue: Operation is continued using the SP of the last segment. The final segment number is held and the elapsed program time is held. The Hold and Advance parameters cannot be used. The time signals hold the status at the end of operation.
- Fixed SP Mode: Operation continues in Fixed SP Mode when the program has been completed. The segment number and elapsed program time return to the start and are held. Time signals are turned OFF before the end of program operation. The program is restarted when the SP Mode parameter is changed to Program SP (PSP).



Setting

Setting range	Unit	Default
R5E: Reset	---	R5E: Reset
C5NE: Continue		
F5P: Fixed SP Mode (See note.)		

**Note** The Fixed SP Mode cannot be selected if the reset operation is set to fixed SP operation.



■ **Related Information**

4-15 Program-related Functions: Page 138

PV5E

PV Start

The Step Time/Rate of Rise Programming parameter must be set to Step Time, or the Step Time/Rate of Rise Programming parameter must be set to Rate of Rise and the Reset Operation parameter must be set to Fixed SP Operation.



Function

- This parameter sets the starting method for program operation.
- If program repetitions or program links are set, the PV Start operates only for the first program execution.
- The following table outlines the starting SP and the starting point for each method.

Starting method	SP at start of operation	Operation starting point
SP Start	Segment 0 SP	Program operates in order from SP of segment 0.
Slope-priority PV Start	Present value at start of operation	Operation starts at the first SP that matches the PV at the start of operation.



Setting range	Unit	Default
5P: SP-priority SP start PV: Slope-priority PV start	---	5P: SP start



■ **Related Information**

4-15 Program-related Functions: Page 138

■ **Related Parameters**

Step time/rate of rise programming (initial setting level): Page 252



Reset operation (initial setting level): Page 253

RMōV

**Move to Advanced Function Setting Level**

The Initial Setting/Communications Protect parameter must be set to 0.



- Set the Move to Advanced Function Setting Level parameter set value to “-169.”
- Move to the advanced function setting level either by pressing  Key or  Key or by waiting or two seconds to elapse.



■ **Related Parameter**

Initial setting/communication protect (adjustment level): Page 180

### 5-10 Advanced Function Setting Level

The advanced function setting level is used for optimizing Controller performance. To move to this level, input the password (“-169”) from the Move to Advanced Function Setting Level.

To be able to enter the password, the Initial Setting/Communications Protect parameter in the protect level must be set to 0. (The default is 0.)

- The parameters in this level can be used when the Initial Setting/Communications Protect parameter is set to 0.
- To switch between setting levels, press the Key.
- To change set values, press the and Keys.

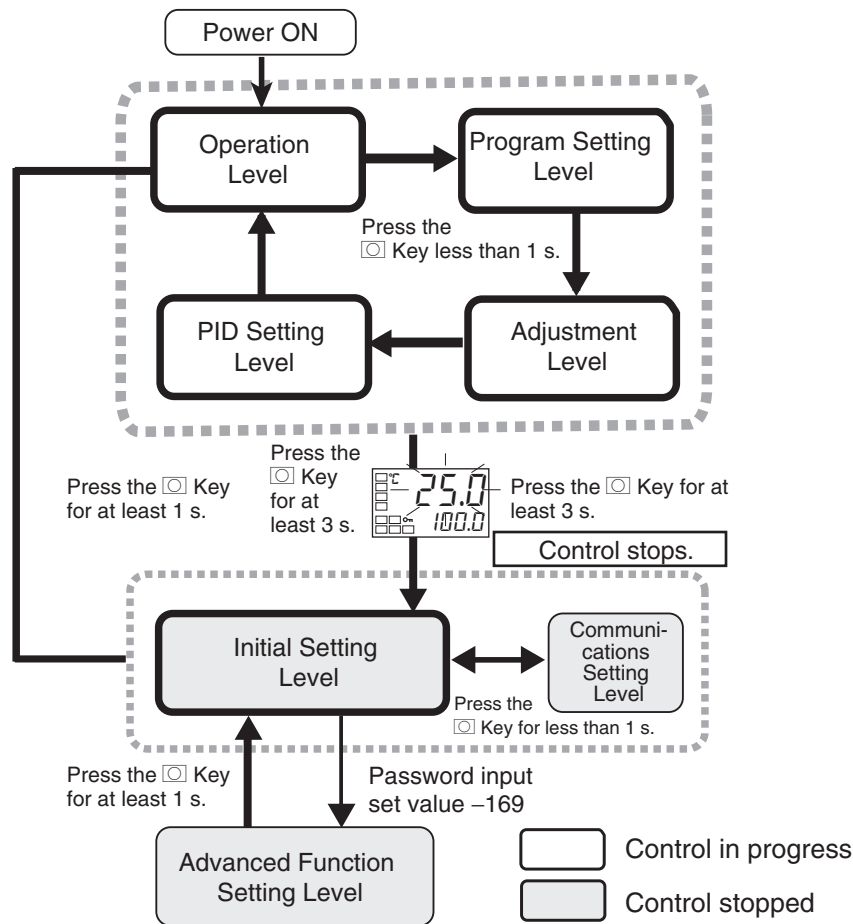

Advanced Function Setting Level			
	Parameter Initialization	Page 258	
	Standby Sequence Reset	258	
	Auxiliary Output 1 Open in Alarm	259	
	Auxiliary Output 2 Open in Alarm	259	
	Auxiliary Output 3 Open in Alarm	259	
	HB ON/OFF	259	
	Heater Burnout Latch	260	
	Heater Burnout Hysteresis	260	
	$\alpha$	261	
	AT Calculated Gain	261	
	AT Hysteresis	261	
	Limit Cycle MV Amplitude	261	
	Input Digital Filter	262	
	Additional PV Display	262	
	MV Display	262	
	Automatic Display Return Time	263	
	Alarm 1 Latch	263	
	Alarm 2 Latch	263	
	Alarm 3 Latch	263	
	Move to Protect Level Time	264	
	Input Error Output	264	
	Cold Junction Compensation Method	Page 264	
	PV Change Color	265	
	PV Stable Band	266	
	Alarm 1 ON Delay	267	
	Alarm 2 ON Delay	267	
	Alarm 3 ON Delay	267	
	Alarm 1 OFF Delay	268	
	Alarm 2 OFF Delay	268	
	Alarm 3 OFF Delay	268	
	Input Shift Type	268	
	MV at Reset and Error Addition	269	
	Auto/Manual Select Addition	269	
	RT	269	
	HS Alarm Use	270	
	HS Alarm Latch	270	
	HS Alarm Hysteresis	271	
	LBA Detection Time	271	
	LBA Level	272	
	LBA Band	272	
	Control Output 1 Assignment	273	
	Control Output 2 Assignment	274	
	Auxiliary Output 1 Assignment	Page 276	
	Auxiliary Output 2 Assignment	277	
	Auxiliary Output 3 Assignment	277	
	Character Select	277	
	Alarm SP Selection	278	
	Remote SP Enable	278	
	Remote SP Upper Limit	279	
	Remote SP Lower Limit	279	
	SP Tracking	279	
	Remote SP Input Error Output	280	
	PID Set Automatic Selection Data	280	
	PID Set Automatic Selection Hysteresis	280	
	PV Dead Band	281	
	Manual MV Limit Enable	281	
	Direct Setting of Position Proportional MV	282	
	PV Rate of Change Calculation Period	282	
	Automatic Cooling Coefficient Adjustment	283	
	Heater Overcurrent Use	283	
	Heater Overcurrent Latch	284	
	Heater Overcurrent Hysteresis	284	
	PF Setting	285	
	Monitor/Setting Item 1	Page 286	
	Monitor/Setting Item 2	286	
	Monitor/Setting Item 3	286	
	Monitor/Setting Item 4	286	
	Monitor/Setting Item 5	286	
	*PV/SP Display Screen Selection	288	
	MV Display Selection	288	
	PV Decimal Point Display	289	
	PV Status Display Function	289	
	SV Status Display Function	290	
	Display Refresh Period	290	
	Control Output 1 ON/OFF Count Monitor	291	
	Control Output 2 ON/OFF Count Monitor	291	
	Control Output 1 ON/OFF Count Alarm Set Value	292	
	Control Output 2 ON/OFF Count Alarm Set Value	292	
	ON/OFF Counter Reset	293	
	Program End ON Time	293	
	Standby Time Unit	294	
	Program SP Shift Value Addition	294	
	RSP Broken-line Correction Display Addition	294	
	Move to Calibration Level	295	

INLE

Parameter Initialization



Function

- This parameter returns all parameter settings to their defaults.
- After the initialization, the set value automatically turns OFF.



Setting

Setting range	Default
OFF: Initialization is not executed.	OFF
RESET: Initializes to the default settings given in the manual.	

RESL

Standby Sequence Reset

Alarm 1 type to Alarm 3 type must be 5, 6, 7, 10, or 11.



Function

- This parameter selects the conditions for enabling reset after the standby sequence of the alarm has been canceled.
  - Output is turned OFF when switching to the initial setting level, communications setting level, advanced function setting level, or calibration level.
  - Condition A
    - At start of operation (including after turning ON power).
    - When the Run/Reset parameter is changed to Run.
    - When program is started (including when the program is started for program repetition or link).
    - When the segment is changed (including when an advance is executed).
    - When the program number is changed.
    - When the SP of the current segment is changed (including changing the fixed SP in Fixed SP Mode).
    - When the alarm value (alarm upper or lower limit) is changed in the current program.
    - When the temperature input shift (upper/lower limit temperature input shift) is changed.
    - When the program SP shift value is changed.
  - Condition B
    - Power ON
- The following example shows the reset action when the alarm type is lower-limit alarm with standby sequence.

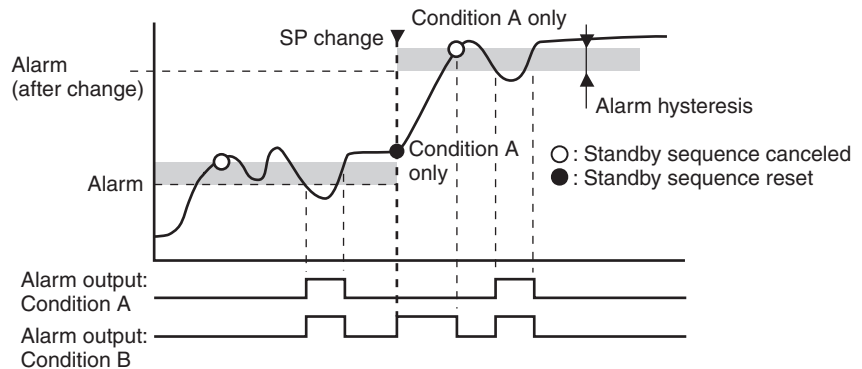





Setting range	Default
$R$ : Condition A, $b$ : Condition B	$R$



■ **Related Parameters**

Alarm 1 to 3 type (initial setting level): Page 240 to 244

Alarm 1 to 3 latch (advanced function setting level): Page 263

$5b^*N$

**Auxiliary Output \* Open in Alarm (\*: 1 to 3)**

Auxiliary output 1, 2, or 3 must be assigned.



- This parameter sets the output status of auxiliary outputs 1 to 3.
- When Close in Alarm is set, the status of the auxiliary output function is output unchanged. When Open in Alarm is set, the status of the auxiliary output function is reversed before being output. The following table shows the relationship between the auxiliary output function, auxiliary output, and operation displays (SUB1 to SUB3).



	Auxiliary output function	Auxiliary output	Operation display (SUB1 to SUB3)
Close in Alarm	ON	ON	Lit
	OFF	OFF	Not lit
Open in Alarm	ON	OFF	Lit
	OFF	ON	Not lit

Setting range	Default
$N-\bar{a}$ : Close in alarm, $N-\bar{L}$ : Open in alarm	$N-\bar{a}$



■ **Related Parameters**

Auxiliary output 1 to 3 assignment (advanced function setting level): Page 275 to 277

$HbU$

**HB ON/OFF**

Heater burnout, HS alarms, and heater overcurrent detection must be supported.

Alarm 1 must be assigned.

When the heating control output or cooling control output has been assigned, a relay output or voltage output (for driving SSR) must be used.



- Set to use the heater burnout alarm.

Setting range	Default
$\bar{a}N$ : Enabled, $\bar{a}FF$ : Disabled	$\bar{a}N$

HbL

### Heater Burnout Latch

Heater burnout, HS alarms, and heater overcurrent detection must be supported.  
Alarm 1 must be assigned.  
The Heater Burnout Detection parameter must be set to ON.



Function

- When this parameter is set to ON, the heater burnout alarm is held until either of the following conditions is satisfied.
  - a Heater burnout detection is set to 0.0 A.
  - b The power is cycled.
  - c The latch is cancelled by the PF Key.  
(PF Setting = LAT: Alarm Latch Cancel)
  - d The latch is cancelled by an event input.  
(Event Input Assignment 1 to 4 = LAT: Alarm Latch Cancel)
- Output is turned OFF when switching to the initial setting level, communications setting level, advanced function setting level, or calibration level.



Setting

Setting range	Default
$\bar{a}N$ : Enabled, $\bar{a}FF$ : Disabled	$\bar{a}FF$



See

■ **Related Parameters**

Event input assignment 1 to 4 (initial setting level): Page 249  
HB ON/OFF: Page 259, PF setting: Page 285 (advanced function setting level)

HbH

### Heater Burnout Hysteresis

The Heater Burnout parameter must be set to ON.  
The Heater Burnout Latch parameter must be set to OFF.  
Heater burnout, HS alarms, and heater overcurrent detection must be supported.  
Alarm 1 must be assigned.



Function

- This parameter sets hysteresis for heater burnout detection.



Setting

Setting range	Unit	Default
0.1 to 50.0	A	0.1



See

■ **Related Parameters**

HB ON/OFF (advanced function setting level): Page 259

RLFA

$\alpha$

2-PID control must be set.



Function

- Normally, use the default for this parameter.
- This parameter sets the 2-PID control  $\alpha$  constant.



Setting

Setting range	Unit	Default
0.00 to 1.00	None	0.65

■ **Related Parameters**

PID ON/OFF: Page 238



See

RE-G

**AT Calculated Gain**

Control must be set to 2-PID control.

RE-H

**AT Hysteresis**

LCMA

**Limit Cycle MV Amplitude**



Function

- Normally use the default values for these parameters.
- The AT Calculated Gain parameter sets the gain for when PID values are calculated using AT. When emphasizing response, decrease the set value. When emphasizing stability, increase the set value.
- The AT Hysteresis parameter sets the hysteresis for limit cycle operation during autotuning when switching ON and OFF.
- The Limit Cycle MV Amplitude parameter sets the MV amplitude for limit cycle operation during autotuning.



Setting

Parameter name	Setting range	Unit	Default
AT Calculated Gain	0.1 to 10.0	---	1.0
AT Hysteresis	Temperature input: 0.1 to 3,240.0	°C or °F	0.8 (See note 1.)
	Analog input: 0.01 to 9.99	%FS	0.20
Limit Cycle MV Amplitude (See note 2.)	5.0 to 50.0	%	20.0

**Note**

- (1) When the temperature unit is °F, the default is 1.4.
- (2) With standard models, this is displayed during standard control. With position-proportional models, this is displayed during close control (when there is a potentiometer input).



See

■ **Related Parameters**

AT execute/cancel (adjustment level): Page 208

**̄NF**

**Input Digital Filter**



Function

- This parameter sets the time constant for the input digital filter. The following diagram shows the effect on data after passing through the digital filter:

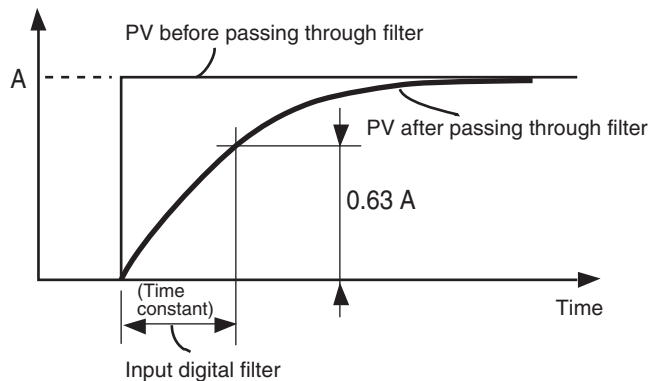

Setting

Setting range	Unit	Default
0.0 to 999.9	Second	0.0

**PvRd**

**Additional PV Display**



Function

This parameter adds a display at the beginning of the operation level for the process value (PV). If there is no need to display the set point, use this to display only the present temperature.

Set to ON to display, and OFF to not display.



Setting

Setting range	Default
$\bar{a}N$ : Displayed, $\bar{a}FF$ : Not displayed	$\bar{a}FF$

**$\bar{a}$ -dP**

**MV Display**



Function

This parameter is used to display the manipulated variable (MV).

The manipulated variable is displayed when the MV Monitor (Heating) and MV Monitor (Cooling) parameters are set to ON, and not displayed when these parameters are set to OFF.



Setting

Setting range	Default
$\bar{a}N$ : Displayed, $\bar{a}FF$ : Not displayed	$\bar{a}FF$



■ **Related Parameters**

MV monitor (heating): Page 194, MV monitor (cooling): Page 194 (operation level)

REL

**Automatic Display Return Time**



- This parameter is used to set the amount of time without key operation that must elapse for the display to return to the PV/SP display from operation level, program setting level, adjustment level, PID setting level, or monitor/setting item level.
- The automatic display return time is disabled when the parameter is set to OFF. (In that case, the display will not be automatically switched.)



Setting range	Unit	Default
OFF, 1 to 99	Second	OFF

R1LE

**Alarm 1 Latch**

Alarm 1 must be assigned, and the alarm 1 type must not be 0.

R2LE

**Alarm 2 Latch**

Alarm 2 must be assigned, and the alarm 2 type must not be 0 or 12.

R3LE

**Alarm 3 Latch**

Alarm 3 must be assigned, and the alarm 3 type must not be 0 or 12.



- When this parameter is set to ON, the alarm function is held until one of the following conditions is satisfied.
  - The power is cycled.
  - The latch is cancelled by the PF Key.  
(PF Setting = LAT: Alarm Latch Cancel)
  - The latch is cancelled by an event input.  
(Event Input Assignment 1 to 4 = LAT: Alarm Latch Cancel)
- The output is turned OFF when switching to the initial setting level, communications setting level, advanced function setting level, or calibration level.
- If an auxiliary output is set to close in alarm, the output is kept closed. If it is set to open in alarm, it is kept open.



Setting range	Default
ON: Enabled, OFF: Disabled	OFF



■ **Related Parameters**

Alarm values 1 to 3, Alarm upper limits 1 to 3, Alarm lower limits 1 to 3: Pages 201 to 202 (program setting level)

Alarm 1 to 3 type (initial setting level): Page 240 to 245

Standby sequence reset: Page 258, Auxiliary output \* open in alarm: Page 259, HB ON/OFF: Page 259, Alarm 1 to 3 hysteresis: Page 244 (advanced function setting level)

Event input assignment 1 to 4 (initial setting level): Page 249

HB ON/OFF: Page 259, PF setting: Page 285 (advanced function setting level)

PRLt

Move to Protect Level Time



Function

- This parameter sets the key pressing time required to move to the protect level from the operation level, program setting level, adjustment level, PID setting level, or monitor/setting item level.



Setting

Setting range	Unit	Default
1 to 30	Second	3



■ **Related Parameters**

Operation/adjustment protect, Initial setting/communications protect, Setting change protect (protect level): Page 180

SErā

Input Error Output

Alarm 1 must be assigned, but not to a work bit output.



Function

- When this parameter is set to ON, the output assigned for alarm 1 turns ON for input errors.  
**Note** For details on input errors, refer to *Error Displays* on page 318.
- The alarm 1 output is an OR output between alarm 1, HB alarm/HS alarm, heater overcurrent alarm, and input error.
- Output is turned OFF when switching to the initial setting level, communications setting level, advanced function setting level, or calibration level.



Setting

Setting range	Default
āN: Enabled, āFF: Disabled	āFF

EJc

Cold Junction Compensation Method

Input type must be thermocouple.



Function

- This parameter specifies whether cold junction compensation is to be performed internally by the Controller or to be performed externally when the input type setting is 5 to 23.

- The cold junction compensation external setting is enabled when the temperature difference is measured using two thermocouples.



Setting range	Default
$\bar{\alpha}N$ : Internally, $\bar{\alpha}FF$ : Externally	$\bar{\alpha}N$



■ **Related Parameters**

Input type (initial setting level): Page 236

**$\bar{\alpha}LR$**

**PV Change Color**



Use the PV color change function to change the color of the PV display (No. 1 display).

There are three display colors, orange, red, and green, and you can select from the following four modes and nine types.

- Constant: This mode displays orange, red, or green all the time.
- Linked to Alarm 1: This mode switches the PV display color from red to green when alarm 1 turns ON or from green to red when alarm 1 turns ON.
- This mode links the color of the PV display to program operation. The color is red while the present SP is rising, orange while the present SP is constant, and green while the present SP is falling. The PV display color is orange when program operation is not being used.
- Linked to PV stable band: This mode switches the PV display color between red outside the PV stable band and green within PV stable band, or between green outside the PV stable band and red within PV stable band. Set the PV stable band in the PV Stable Band parameter in the advanced function setting level.
- The default is *REd* (red).

The following table shows the display functions that can be set using the PV color change function.



Mode	Setting	Function	PV change color	Application example
Constant	$\bar{\alpha}RG$	Orange	Constant: Orange	To match the display color with other Controller models
	<i>REd</i>	Red	Constant: Red	To match the display color with other Controller models
	$\bar{\alpha}RN$	Green	Constant: Green	To match the display color with other Controller models

Mode	Setting	Function	PV change color			Application example
Linked to alarm 1						
			ALM1 ON	ALM1 OFF	Application example	
	$R-\bar{L}$	Red to Green	Red	Green	To display the PV reached signal	
	$\bar{L}-R$	Green to Red	Green	Red	To display error signals	
Linked to PV stable band						
			Low	PV stable band	High	Application example
	$R-\bar{L},R$	Red to Green to Red	Red	Green	Red	To display stable status
	$\bar{L}-\bar{o},R$	Green to Orange to Red	Green	Orange	Red	To display stable status
	$\bar{o}-\bar{L},R$	Orange to Green to Red	Orange	Green	Red	To display stable status
Linked to program	$R-\bar{o},\bar{L}$	Red to Orange to Green	Rising	Constant	Falling	Application example
			Red	Orange	Green	Displaying program operation status

■ **Related Parameters**



PV stable band (advanced function setting level): Page 266

**PV -b**

**PV Stable Band**



Function

This parameter sets the PV stable band width within which the PV display color is changed.

- When the mode to link to the PV stable band is selected with the PV Change Color parameter, the PV display color will change according to whether the present value (PV) is lower than, within, or higher than the PV stable band, as shown in the following figure.
- There is a hysteresis of 0.2 (°C or °F).



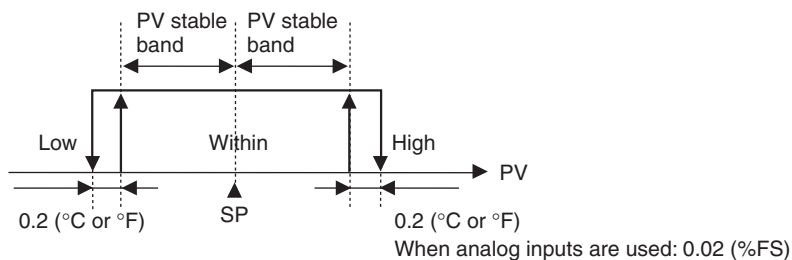

Setting

Models	Setting range	Unit	Default
Controllers with Thermocouple/Resistance Thermometer Universal Inputs	0.1 to 999.9	°C or °F (See note.)	5.0
Controllers with Analog Inputs	0.01 to 99.99	%FS	5.00

**Note** Set “None” as the unit for Controllers with Analog Inputs.

■ **Related Parameters**

PV change color (advanced function setting level): Page 265



See

**R1ōN**

**Alarm 1 ON Delay**

Alarm 1 must be assigned, and the alarm 1 type must not be 0, 12, or 13.

**R2ōN**

**Alarm 2 ON Delay**

Alarm 2 must be assigned, and the alarm 2 type must not be 0, 12, or 13.

**R3ōN**

**Alarm 3 ON Delay**

Alarm 3 must be assigned, and the alarm 3 type must not be 0, 12, or 13.



Function

Alarm 1, 2, or 3 outputs are prevented from turning ON until after the delay times set in these parameters have elapsed.

- Set the time for which the ON delay is to be enabled.
- To disable the ON delay, set 0.



Setting

Setting range	Unit	Default
0 to 999	Second	0



See

■ **Related Parameters**

Alarm 1 to 3 type (initial setting level): Pages 240 to 245

R1ōF

**Alarm 1 OFF Delay**

Alarm 1 must be assigned, and the alarm 1 type must not be 0, 12, or 13.

R2ōF

**Alarm 2 OFF Delay**

Alarm 2 must be assigned, and the alarm 2 type must not be 0, 12, or 13.

R3ōF

**Alarm 3 OFF Delay**

Alarm 3 must be assigned, and the alarm 3 type must not be 0, 12, or 13.



Alarm 1, 2, or 3 outputs are prevented from turning OFF until after the delay times set in these parameters have elapsed.

- Set the time for which the OFF delay is to be enabled.
- To disable the OFF delay, set 0.



Setting range	Unit	Default
0 to 999	Second	0



■ **Related Parameters**

Alarm 1 to 3 type (initial setting level): Pages 240 to 245

Ī5ŁP

**Input Shift Type**

The input type must be for a temperature input.



This parameter sets the shift method for a temperature input.

- When the input type is for a temperature input, set either a 1-point shift or a 2-point shift.



Setting range	Default
ĪNS1: 1-point shift, ĪNS2: 2-point shift	ĪNS1



■ **Related Parameters**

Temperature input shift, Upper-limit temperature input shift value, Lower-limit temperature input shift value (adjustment level): Page 215

Input type (initial setting level): Page 236

**MVRE**

**MV at Reset and Error Addition**

The control must be set to 2-PID control.



- This parameter displays and hides the MV at Reset and MV at Error parameters.



Setting range	Default
$\bar{a}N$ : Displayed, $\bar{a}FF$ : Not displayed	$\bar{a}FF$

■ **Related Parameters**

MV at reset, MV at error (adjustment level): Page 220



**AMAd**

**Auto/Manual Select Addition**

The control must be set to 2-PID control.



- Set whether the Auto/Manual Switch parameter is to be displayed.



Setting range	Default
$\bar{a}N$ : Displayed, $\bar{a}FF$ : Not displayed	$\bar{a}N$

**Note** For Controllers with a PF Key (E5AN/EN-H), the default is ON.

■ **Related Parameters**

Auto/manual switch (operation level): Page 186



**RT**

**RT**

The control must be set to 2-PID control.  
The input type must be set to temperature input.



This parameter executes robust tuning (RT).

- When AT is executed with RT selected, PID constants are automatically set which make it hard for control performance to degenerate even when control object characteristics are changed.
- Even when hunting occurs for PID constants when AT is executed in normal mode, it is less likely to occur when AT is executed in RT mode.



Setting range	Default
$\bar{a}N$ : RT function OFF, $\bar{a}FF$ : RT function ON	$\bar{a}FF$



■ **Related Parameters**

- AT execute/cancel (PID setting level): Page 208
- PID \* proportional band (PID setting level): Page 227
- PID \* integral time (PID setting level): Page 227
- PID \* derivative time (PID setting level): Page 227
- PID ON/OFF (initial setting level): Page 238

**H5U**

**HS Alarm Use**

Heater burnout, HS alarms, and heater overcurrent detection must be supported.

Alarm 1 must be assigned.

When the heating control output or cooling control output has been assigned, a relay output or voltage output (for driving SSR) must be used.



Function

- Set this parameter to use HS alarms.



Setting

Setting range	Default
$\bar{0}N$ : Enabled, $\bar{0}FF$ : Disabled	$\bar{0}N$

**H5L**

**HS Alarm Latch**

Heater burnout, HS alarms, and heater overcurrent detection must be supported.

Alarm 1 must be assigned.

The HS Alarm parameter must be set to ON.



Function

- When this parameter is set to ON, the HS alarm is held until any of the following conditions is satisfied.
  - a The HS alarm current is set to 50.0 A.
  - b The power is cycled.
  - c The latch is cancelled by the PF Key.  
(PF Setting = LAT: Alarm Latch Cancel)
  - d The latch is cancelled by an event input.  
(Event Input Assignment 1 to 4 = LAT: Alarm Latch Cancel)
- Output is turned OFF when switching to the initial setting level, communications setting level, advanced function setting level, or calibration level.



Setting

Setting range	Default
$\bar{0}N$ : Enabled, $\bar{0}FF$ : Disabled	OFF



■ **Related Parameters**

- HS alarm use (advanced function setting level): Page 270

Event input assignment 1 to 4 (initial setting level): Page 249  
 HB ON/OFF: Page 259, PF setting: Page 285 (advanced function setting level)

**HS**

**HS Alarm Hysteresis**

Heater burnout and HS alarms must be supported.  
 Alarm 1 must be assigned.  
 The HS Alarm parameter must be set to ON.  
 The HS Alarm Latch parameter must be set to OFF.



Function

- This parameter sets the hysteresis for HS alarms.



Setting

Setting range	Unit	Default
0.1 to 50.0	A	0.1

■ **Related Parameters**

HS alarm use (advanced function setting level): Page 270



See

**LbA**

**LBA Detection Time**

Alarm 1 must be assigned.  
 The alarm type must be set to 12 (LBA).  
 ON/OFF control must be used.



Function

This parameter enables or disables the LBA function and sets the detection time interval.

- Set the time interval for detecting loop burnouts.
- To disable the LBA function, set 0.



Setting

Setting range	Unit	Default
0 to 9999	Second	0

■ **Related Parameters**

Alarm 1 type (initial setting level): Page 240

PID\* LBA detection time (PID setting level): Page 229

LBA level: Page 272, LBA band: Page 272 (advanced function setting level)



See

LbAL

**LBA Level**

Alarm 1 must be assigned.  
The alarm type must be set to 12 (LBA).  
The LBA detection time must not be 0.  
(See note.)



Function

- This parameter sets the LBA level.
- If the deviation between the SP and PV exceeds the LBA level, a loop burnout is detected.

**Note** For ON/OFF control, the LBA Detection Time parameter (advanced function setting level) must not be set to 0. For 2-PID control, the LBA Detection Time parameter must not be set to 0 for any of PID sets 1 to 8.



Setting

Models	Setting range	Unit	Default
Temperature input	0.1 to 3240.0	°C or °F	8.0
Analog Input	0.01 to 99.99	%FS	10.00

**Note** Set “None” as the unit for Controllers with Analog Inputs.



See

■ **Related Parameters**

- Process value/Set point (operation level): Page 185
- Alarm 1 type (initial setting level): Page 240
- PID \* LBA detection time (PID setting level): Page 229
- LBA detection time, LBA band: Page 219 (advanced function setting level)

LbAb

**LBA Band**

Alarm 1 must be assigned.  
The alarm type must be set to 12 (LBA).  
The LBA detection time must not be 0. (See note.)



Function

- This parameter sets the LBA band.
- If a control deviation greater than the LBA band is not reduced when the LBA level is exceeded, an loop burnout is detected.

**Note** For ON/OFF control, the LBA Detection Time parameter (advanced function setting level) must not be set to 0. For 2-PID control, the LBA Detection Time parameter must not be set to 0 for any of PID sets 1 to 8.



Setting

Models	Setting range	Unit	Default
Temperature input	0.0 to 3240.0	°C or °F	3.0
Analog input	0.00 to 99.99	%FS	0.20

■ **Related Parameters**

- Process value/Set point (operation level): Page 185
- Alarm 1 type (initial setting level): Page 240
- LBA detection time, LBA level (advanced function setting level): Page 271



See

OUT 1

### Control Output 1 Assignment

There must a transfer output, or if there is no transfer output, control output 1 must not be a linear output or if it is a linear output, the transfer output type must be set to OFF.



Function



Setting

- This parameter sets the function to be assigned to control output 1.

Setting range	Default
<i>nāNE</i> : No function is assigned to control output 1.	$\bar{0}$
$\bar{0}$ : Heating control output is output.	
$\bar{1}$ : Cooling control output is output. (See note 1.)	
<i>RLM1</i> : Alarm 1 is output. (See note 2.)	
<i>RLM2</i> : Alarm 2 is output. (See note 2.)	
<i>RLM3</i> : Alarm 3 is output. (See note 2.)	
<i>P.ENd</i> : Program end is output. (See note 2.)	
<i>RRLM</i> : Control output ON/OFF count alarm (See note 2.)	
<i>StG</i> : Stage output (See note 2.)	
<i>RUN</i> : Run output (See note 2.)	
<i>tS1</i> : Time signal 1 output (See note 2.)	
<i>tS2</i> : Time signal 2 output (See note 2.)	
<i>WR1</i> : Work bit 1 (See notes 2 and 3.)	
<i>WR2</i> : Work bit 2 (See notes 2 and 3.)	
<i>WR3</i> : Work bit 3 (See notes 2 and 3.)	
<i>WR4</i> : Work bit 4 (See notes 2 and 3.)	
<i>WR5</i> : Work bit 5 (See notes 2 and 3.)	
<i>WR6</i> : Work bit 6 (See notes 2 and 3.)	
<i>WR7</i> : Work bit 7 (See notes 2 and 3.)	
<i>WR8</i> : Work bit 8 (See notes 2 and 3.)	

- Note**
- (1) If  $\bar{1}$  is assigned for standard control, a value equivalent to 0% is output.
  - (2) Can be selected for a relay output, voltage output (for driving SSR) only.
  - (3) WR1 to WR8 are not displayed when the logic operation function is not used.

■ **Related Parameters**

Standard or heating/cooling: Page 239, Transfer output type: Page 246 (initial setting level)



0002

### Control Output 2 Assignment

There must a transfer output, or if there is no transfer output, control output 1 must be a linear output or control output 2 must not be a linear output. If control output 1 is not a linear output and control output 2 is a linear output, the transfer output type must be set to OFF.



Function



Setting

- This parameter sets the function to be assigned to control output 2.

Setting range	Default
<i>NONE</i> : No function is assigned to control output 2.	<i>NONE</i> (See note 5.)
<i>0</i> : Heating control output is output.	
<i>1-0</i> : Cooling control output is output. (See note 1.)	
<i>RLM1</i> : Alarm 1 is output. (See note 2.)	
<i>RLM2</i> : Alarm 2 is output. (See note 2.)	
<i>RLM3</i> : Alarm 3 is output. (See note 2.)	
<i>P.ENd</i> : Program end is output. (See note 2.)	
<i>RRLM</i> : Control output ON/OFF count alarm (See note 2.)	
<i>StG</i> : Stage output (See note 2.)	
<i>RUN</i> : Run output (See note 2.)	
<i>tS1</i> : Time signal 1 output (See note 2.)	
<i>tS2</i> : Time signal 2 output (See note 2.)	
<i>WR1</i> : Work bit 1 (See notes 2 and 3.)	
<i>WR2</i> : Work bit 2 (See notes 2 and 3.)	
<i>WR3</i> : Work bit 3 (See notes 2 and 3.)	
<i>WR4</i> : Work bit 4 (See notes 2 and 3.)	
<i>WR5</i> : Work bit 5 (See notes 2 and 3.)	
<i>WR6</i> : Work bit 6 (See notes 2 and 3.)	
<i>WR7</i> : Work bit 7 (See notes 2 and 3.)	
<i>WR8</i> : Work bit 8 (See notes 2 and 3.)	

- Note**
- (1) If *1-0* is assigned for standard control, a value equivalent to 0% will be output.
  - (2) Can be selected for a relay output, voltage output (for driving SSR) only.
  - (3) WR1 to WR8 are not displayed when the logic operation function is not used.
  - (4) If the Standard or Heating/Cooling parameter is set to heating/cooling control, control automatically switches to *1-0*.

■ **Related Parameters**

Standard or heating/cooling: Page 239 (initial setting level)





Sub 1

Auxiliary Output 1 Assignment

Auxiliary output 1 must be assigned.



Function



Setting

- This parameter sets the function to be assigned to auxiliary output 1.

Setting range	Default
<i>NONE</i> : No function is assigned to auxiliary output 1.	<i>RLM 1</i> (See note 3.)
<i>ā</i> : Heating control output is output.	
<i>Ē - ā</i> : Cooling control output is output. (See note 1.)	
<i>RLM 1</i> : Alarm 1 is output.	
<i>RLM 2</i> : Alarm 2 is output.	
<i>RLM 3</i> : Alarm 3 is output.	
<i>P. ENd</i> : Program end is output.	
<i>RRLM</i> : Control output ON/OFF count alarm	
<i>SEĒ</i> : Stage output	
<i>RUN</i> : Run output	
<i>tS 1</i> : Time signal 1 output	
<i>tS 2</i> : Time signal 2 output	
<i>WR 1</i> : Work bit 1 (See note 2.)	
<i>WR 2</i> : Work bit 2 (See note 2.)	
<i>WR 3</i> : Work bit 3 (See note 2.)	
<i>WR 4</i> : Work bit 4 (See note 2.)	
<i>WR 5</i> : Work bit 5 (See note 2.)	
<i>WR 6</i> : Work bit 6 (See note 2.)	
<i>WR 7</i> : Work bit 7 (See note 2.)	
<i>WR 8</i> : Work bit 8 (See note 2.)	

- Note**
- (1) If *Ē - ā* is assigned for standard control, a value equivalent to 0% will be output.
  - (2) WR1 to WR8 are not displayed when the logic operation function is not used.

■ **Related Parameters**

Standard or heating/cooling: Page 239 (initial setting level)



See

## Sub2

## Auxiliary Output 2 Assignment

Auxiliary output 2 must be assigned.



Function

- This parameter sets the function to be assigned to auxiliary output 2.

Setting range	Default
<i>NONE</i> : No function is assigned to auxiliary output 2.	<i>RLM2</i>
<i>ā</i> : Heating control output is output.	
<i>Ē - ā</i> : Cooling control output is output. (See note 1.)	
<i>RLM1</i> : Alarm 1 is output.	
<i>RLM2</i> : Alarm 2 is output.	
<i>RLM3</i> : Alarm 3 is output.	
<i>P.END</i> : Program end is output.	
<i>RRLM</i> : Control output ON/OFF count alarm	
<i>SEU</i> : Stage output	
<i>RUN</i> : Run output	
<i>TS1</i> : Time signal 1 output	
<i>TS2</i> : Time signal 2 output	
<i>WR1</i> : Work bit 1 (See note 2.)	
<i>WR2</i> : Work bit 2 (See note 2.)	
<i>WR3</i> : Work bit 3 (See note 2.)	
<i>WR4</i> : Work bit 4 (See note 2.)	
<i>WR5</i> : Work bit 5 (See note 2.)	
<i>WR6</i> : Work bit 6 (See note 2.)	
<i>WR7</i> : Work bit 7 (See note 2.)	
<i>WR8</i> : Work bit 8 (See note 2.)	

- Note**
- (1) If *Ē - ā* is assigned for standard control, a value equivalent to 0% will be output.
  - (2) WR1 to WR8 are not displayed when the logic operation function is not used.

■ **Related Parameters**

Standard or heating/cooling: Page 239 (initial setting level)



Sub3

Auxiliary Output 3 Assignment

Auxiliary output 3 must be assigned (E5AN-H and E5EN-H only).



- This parameter sets the function to be assigned to Auxiliary output 3.

Setting range	Default
<i>NONE</i> : No function is assigned to auxiliary output 3.	<i>RLM3</i>
<i>α</i> : Heating control output is output.	
<i>ε - α</i> : Cooling control output is output. (See note 1.)	
<i>RLM1</i> : Alarm 1 is output.	
<i>RLM2</i> : Alarm 2 is output.	
<i>RLM3</i> : Alarm 3 is output.	
<i>P.ENd</i> : Program end is output. (See note 2.)	
<i>PRLM</i> : Control output ON/Off count alarm	
<i>WR1</i> : Work bit 1 (See note 3.)	
<i>WR2</i> : Work bit 2 (See note 3.)	
<i>WR3</i> : Work bit 3 (See note 3.)	
<i>WR4</i> : Work bit 4 (See note 3.)	
<i>WR5</i> : Work bit 5 (See note 3.)	
<i>WR6</i> : Work bit 6 (See note 3.)	
<i>WR7</i> : Work bit 7 (See note 3.)	
<i>WR8</i> : Work bit 8 (See note 3.)	

- Note**
- (1) If *ε - α* is assigned for standard control, a value equivalent to 0% will be output.
  - (2) Can be selected when the Program Pattern parameter is set to OFF, but the function will be disabled.
  - (3) WR1 to WR8 are not displayed when the logic operation function is not used.



■ **Related Parameters**

Standard or heating/cooling: Page 239 (initial setting level)

E5EL

Character Select



- This parameter switches the characters to be displayed. The following two types of characters can be displayed.  
11-segment display  
7-segment display

Setting range	Default
<i>αN</i> : 11-segment display, <i>αFF</i> : 7-segment display	<i>αN</i>

When set to *αN*, an 11-segment display is used.

**RLSP**

**Alarm SP Selection**

Alarm 1, 2, and 3 functions must be assigned.  
The alarm type must be set to 1, 2, 3, 4, 5, 6, or 7.



Function

This parameter sets whether to use the present SP or the segment SP as the SP that triggers a deviation alarm during ramp segment operation.

- Set the present SP or the segment SP as the SP that triggers a deviation error.



Setting

Setting range	Default
SP-M: Present SP, LSP: Segment SP	SP-M



■ **Related Information**

3-12 Starting and Stopping Operation (RLSM): Page 89

**RSPU**

**Remote SP Enable**

E5AN/EN-HT Only.



Function

- When this parameter is set to ON, you can switch between a remote SP (RSP) and program SP (PSP), or between a remote SP and fixed SP (FSP) (PSP or FSP is set in the SP Mode parameter).
- When this parameter is set to OFF, the program SP or fixed SP is used (PSP or FSP is set in the SP Mode parameter).



Setting

Setting range	Default
ON: Enabled, OFF: Disabled	OFF



■ **Related Parameters**

SP mode (adjustment level): Page 209

RSPH  
RSPL

**Remote SP Upper Limit**  
**Remote SP Lower Limit**

The Remote SP Enable parameter must be set to ON.



- This parameter sets the upper and lower limits for a remote SP. An upper limit of 20 mA and a lower limit of 4 mA are supported. Set the upper limit in the Remote SP Upper Limit parameter, and set the lower limit in the Remote SP Lower limit parameter.

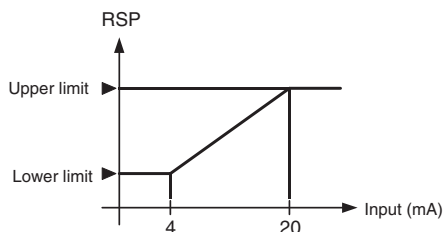

- When the SP Upper Limit or SP Lower Limit parameter setting is changed, the remote SP upper or lower limit is forcibly changed to that setting.



Setting	Setting range	Unit	Default
Remote SP Upper Limit	SP lower limit to SP upper limit	EU	1300.0
Remote SP Lower Limit	SP lower limit to SP upper limit	EU	-200.0



■ **Related Parameters**

- Decimal point (initial setting level): Page 237
- SP upper limit, SP lower limit (initial setting level): Page 238
- Remote SP enable (advanced function setting level): Page 278

SPLR

**SP Tracking**



- This parameter specifies the operation for when the mode is changed from Remote SP Mode to Local SP Mode.
- When this parameter is turned ON, operation continues using the remote SP or program SP as the fixed SP.
- When this parameter is OFF, the fixed SP is not affected by the remote SP or program SP.
- Tracking is not performed when switching from Remote SP Mode to Program SP Mode or from Program SP Mode to Remote SP Mode.



Setting range	Default
ON: Enabled, OFF: Disabled	OFF



■ **Related Parameters**

SP mode (adjustment level): Page 209

$RSE\bar{o}$

**Remote SP Input Error Output**

The Remote SP Enable parameter must be set to ON.

Alarm 1 must be assigned, but not to a work bit output.



Function

- When this parameter is set to ON, the output to which alarm 1 is assigned turns ON when a remote SP input error occurs.

**Note** For details on input errors, refer to 4-22 *Using a Remote SP Function*.

- The output is an OR output between alarm 1, the heater burnout/HS/heater overcurrent alarm, the input error, and the RSP input error status.
- The output turns OFF when switching to the initial setting level, advanced function setting level, communications setting level, or calibration level.



Setting

Setting range	Default
ON: Enabled, OFF: Disabled	$\bar{o}FF$



■ **Related Parameters**

Remote SP upper limit, Remote SP lower limit (advanced function setting level): Page 279

SP mode (adjustment level): Page 209

$P\bar{L}d\bar{L}$   
 $P\bar{L}dH$

**PID Set Automatic Selection Data**  
**PID Set Automatic Selection Hysteresis**

The control must be set to 2-PID control.



Function

- This parameter provides the data for automatic selection of the PID set.
- The PID set number to be used is automatically selected according to the data set in the PID Set Automatic Selection Data parameter. The selection range is specified in the PID Set Automatic Selection Range Upper Limit parameter.
- The PID Set Automatic Selection Hysteresis parameter is used to set the hysteresis to prevent chattering when the PID set is changed.



Setting

Parameter	Setting range	Unit	Default
PID Set Automatic Selection Data	$PV$ : Process value $dV$ : Deviation $SP$ : Set point	---	PV
PID Set Automatic Selection Hysteresis	0.10 to 99.99	%FS	0.50



■ **Related Parameters**

- PID set automatic selection range upper limit (PID setting level): Page 280
- PID set number (program setting level): Page 201

**P-db**

**PV Dead Band**

Position-proportional control must be supported.



Function

- For position-proportional models, control is executed with the process value equal to the set point when the process value is within the PV dead band.
- This function prevents unnecessary outputs when the process value approaches the set point.



Setting

Setting range	Unit	Default
0.0 to 32400	EU	0.0



■ **Related Parameters**

- Closed/floating (initial setting level): Page 250
- Motor calibration (initial setting level): Page 251
- Travel time (initial setting level): Page 251
- Position proportional dead band (adjustment level): Page 222
- Open/close hysteresis (adjustment level): Page 222

**MANL**

**Manual MV Limit Enable**

The control must be set to 2-PID control.  
Close control (position-proportional models) must be used.



Function

This parameter sets whether the MV Upper Limit and MV Lower Limit parameters are to be enabled for manual MV in manual mode.



Setting

Setting range	Default
$\bar{a}N$ : Enabled, $\bar{a}FF$ : Disabled	OFF



■ **Related Parameters**

- PID \* MV upper limit, PID \* MV lower limit (PID setting level): Page 227

PMV<sub>d</sub>

### Direct Setting of Position Proportional MV

Close control (position-proportional models) must be used.



Function

- When this parameter is set to ON, valve opening can be specified in the MV at Reset, MV at PV Error, and Manual MV Limit Enable parameters.



Setting

Setting range	Default
$\bar{a}N$ : Enabled, $\bar{a}FF$ : Disabled	OFF



■ **Related Parameters**

MV at reset, MV at error (adjustment level): Page 220

MV at PV error (adjustment level): Page 220

Manual MV (manual control level): Page 232

PV<sub>RP</sub>

### PV Rate of Change Calculation Period

Alarms 1, 2, and 3 must be assigned. The alarm type must be set to 13.



Function

- The change width can be found for PV input values in any set period. Differences with previous values in each set period are calculated, and an alarm is output if the results exceed the alarm value.
- The PV rate of change calculation period can be set in units of 60 ms (sampling period).



Setting

Setting range	Unit	Default
1 to 999	Sampling period	17 (= 17 × 60 ms = 1020 ms)



■ **Related Parameters**

Process value, Process value/set point (operation level): Page 185

Alarm 1 to 3 type, (Initial setting level): Pages 240, 244, 245.



$\bar{C}S\bar{C}A$

### Automatic Cooling Coefficient Adjustment

The control must be set to heating/cooling control and 2-PID control.



Function

- By setting the Automatic Cooling Coefficient Adjustment parameter to ON, autotuning can be executed during heating/cooling control to automatically calculate the cooling coefficient at the same time as the PID parameters. If there is strong non-linear gain for the cooling characteristics, such as when cooling water boils for cooling control, it may not be possible to obtain the optimum cooling coefficient with this function, and control may take the form of oscillating waves. If that occurs, increase the proportional band or the cooling coefficient to improve control.



Setting

Setting range	Default
$\bar{a}N$ : Enabled, $\bar{a}FF$ : Disabled	OFF



■ **Related Parameters**

PID \* cooling coefficient (PID setting level): Page 229

$\bar{a}CU$

### Heater Overcurrent Use

Heater burnout, HS alarms, and heater overcurrent detection must be supported.

Alarm 1 must be assigned.

When the heating control output or cooling control output has been assigned, a relay output or voltage output (for driving SSR) must be used.



Function

- Set this parameter to use the heater overcurrent alarm.



Setting

Setting range	Default
$\bar{a}N$ : Enabled, $\bar{a}FF$ : Disabled	ON

$\bar{a}L$

### Heater Overcurrent Latch

Heater burnout, HS alarms, and heater overcurrent detection must be supported (two CTs).  
Alarm 1 must be assigned.



- When this parameter is set to ON, the HS alarm is held until any of the following conditions is satisfied.
  - a Heater overcurrent detection is set to 50.0 A.
  - b The power is cycled.
  - c The latch is cancelled by the PF Key.  
(PF Setting = LAT: Alarm Latch Cancel)
  - d The latch is cancelled by an event input.  
(Event Input Assignment 1 to 4 = LAT: Alarm Latch Cancel)
- Output is turned OFF when switching to the initial setting level, communications setting level, advanced function setting level, or calibration level.



Setting range	Default
$\bar{a}N$ : Enabled, $\bar{a}FF$ : Disabled	OFF



■ **Related Parameters**

Heater overcurrent detection 1, Heater overcurrent detection 2 (adjustment level): Pages 211, 213  
 Heater overcurrent use (advanced function setting level): Page 283  
 Heater overcurrent hysteresis (advanced function setting level): Page 284  
 Event input assignment 1 to 4 (initial setting level): Page 249  
 HB ON/OFF: Page 259, PF setting: Page 285 (advanced function setting level)

$\bar{a}H$

### Heater Overcurrent Hysteresis

Heater burnout, HS alarms, and heater overcurrent detection must be supported, and alarm 1 must be assigned. The Heater Overcurrent Use parameter must be set to ON, and the Heater Overcurrent Latch parameter must be set to OFF.



- This parameter sets the hysteresis for heater overcurrent detection.



Setting range	Unit	Default
0.1 to 50.0	A	0.1



■ **Related Parameters**

Heater overcurrent use (advanced function setting level): Page 283

PF

PF Setting

The PF Key must be supported (E5AN/EN-H).



- This parameter sets the function of the PF Key.
- For the E5CN-HT the + Keys are pressed simultaneously to perform the same function as the PF Key.



The default is R-R (Reverse Run/Reset).

Setting	Display	Meaning	Function
OFF	OFF	Disabled	Does not operate as a function key.
RUN	RUN	Run	Specifies Run status.
RST	RSt	Reset	Specifies Reset status. (See note 1.)
R-R	R-R	Reverse Run/Reset	Specifies reversing operation status between Run and Reset. (See note 1.)
HOLD	HOLD	Reverse Hold/Clear Hold	Specifies reversing operation status between Hold and Hold Clear.
ADV	Adv	Advance	Specifies advancing.
AT-2	At - 2	100% AT Execute/Cancel	Specifies reversing 100% AT execute/cancel status. (See note 2.)
AT-1	At - 1	40% AT Execute/Cancel	Specifies reversing 40% AT execute/cancel status. (See notes 2 and 3.)
LAT	Lat	Alarm Latch Cancel	Specifies canceling all alarm latches. (See note 4.)
A-M	A-M	Auto/Manual Switch	Specifies reversing auto/manual status. (See note 5.)
PFDP	PFdP	Monitor/Setting Items	Specifies displaying monitor/setting items. Monitor/setting items are selected using the Monitor/Setting Item 1 to Monitor/Setting Item 5 parameters (advanced function setting level).

**Note**

- (1) The reset operation for a Reset or Reverse Run/Reset setting is implemented by pressing the PF Key for at least two seconds. The Run operation is implemented by pressing the PF Key for at least one second.
- (2) When canceling auto-tuning, either 100% AT Execute/Cancel or 40% AT Execute/Cancel can be used regardless of whether 100% or 40% AT is being executed.
- (3) AT-1 can be set for heating/cooling control or position-proportional (floating) control, but the function is disabled.
- (4) Alarms 1 to 3, heater burnout, HS alarms, and heater overcurrent latches are canceled.
- (5) For details on auto/manual operation using the PF Key, refer to 4-12 *Performing Manual Control*.
- (6) Operation will be performed according to the setting of this parameter when the PF Key is pressed for at least one second. (This does not apply to the reset operation when Reverse Run/Reset is set.) If Monitor/Setting Items is selected, the display will switch between monitor/setting items 1 to 5 each time the key is pressed.
- (7) The PF Key is enabled only when the PF Key Protect parameter is set to OFF.



■ **Related Parameters**

Monitor/setting item 1 to 5 (advanced function setting level): Page 286

**PFd\***

**Monitor/Setting Item \* (\*: 1 to 5)**

The PF Setting parameter must be set to PFDP.



Function

- Set the PF Key parameter to Monitor/Setting Item to enable using the PF key to display monitor/setting items. The items that will be displayed are set using the Monitor/Setting Item 1 to 5 parameters. The settings are listed in the following table.
- The default is 1 (PV, SP, program number, and segment number).



Setting

Setting	Meaning	Monitor/setting item	Characters
0	Disabled		
1	PV, SP, Program No., and Segment No.	Can be set. (SP) (See note 1.)	Numeric display No. 1 display: PV No. 2 display: SP No. 3 display: Specified data (A and E types only)
2	PV/SP/MV	Can be set. (SP) (See notes 1 and 2.)	
3	PV, SP, and Remaining Segment Time	Can be set. (SP) (See note 1.)	

Setting	Meaning	Monitor/setting item	Characters	
4	Proportional band (See note 3.)	Can be set.	No. 1 display: $P$	No. 2 display: Parameter No. 3 display: Nothing displayed.
5	Integral time (See note 3.)	Can be set.	No. 1 display: $I$	
6	Derivative time (See note 3.)	Can be set.	No. 1 display: $D$	
7	Alarm value 1 (See note 4.)	Can be set.	No. 1 display: $RL - 1$	
8	Alarm value upper limit 1 (See note 4.)	Can be set.	No. 1 display: $RL 1H$	
9	Alarm value lower limit 1 (See note 4.)	Can be set.	No. 1 display: $RL 1L$	
10	Alarm value 2 (See note 4.)	Can be set.	No. 1 display: $RL - 2$	
11	Alarm value upper limit 2 (See note 4.)	Can be set.	No. 1 display: $RL 2H$	
12	Alarm value lower limit 2 (See note 4.)	Can be set.	No. 1 display: $RL 2L$	
13	Alarm value 3 (See note 4.)	Can be set.	No. 1 display: $RL - 3$	
14	Alarm value upper limit 3 (See note 4.)	Can be set.	No. 1 display: $RL 3H$	
15	Alarm value lower limit 3 (See note 4.)	Can be set.	No. 1 display: $RL 3L$	
16	Program number	Can be set.	No. 1 display: $PRG$	
17	Segment number	Can be set.	No. 1 display: $SEG$	
18	Elapsed program time	Cannot be set.	No. 1 display: $PRGT$	
19	Remaining program time	Cannot be set.	No. 1 display: $PRGR$	
20	Elapsed segment time	Cannot be set.	No. 1 display: $SEGT$	
21	Remaining segment time	Cannot be set.	No. 1 display: $SEGR$	

- Note**
- (1) If there is no No. 3 display, only the PV and SP are displayed.
  - (2) For standard models, the MV is displayed. For position-proportional models, the valve opening is displayed.  
For heating/cooling, select MV (heating) or MV (cooling) with the MV Display Selection parameter. Refer to *PV/SP Display Screen Selection* for information on the MV display selection.  
The SP can be selected only in Fixed SP Mode.
  - (3) The currently selected PID set number is displayed.
  - (4) The currently selected program number is displayed.

■ **Related Parameters**

PF setting: Page 285, MV display selection: Page 288 (advanced function setting level)



SPdP

**PV/SP Display Screen Selection**

The No. 3 display must be supported (E5AN/EN-HT).



- This parameter sets the PV/SP Screen No. 3 display and order of display.
- The default is 3.

Set value	Display contents
0	Only PV/SP is displayed (with no No. 3 display).
1	The PV, SP, Program No., and Segment No., and the PV, SP, and MV (see note.) are displayed in order.
2	The PV, SP, and MV (see note.) and the PV, SP, Program No., and Segment No. are displayed in order.
3	Only the PV, SP, Program No., and Segment No. are displayed.
4	Only PV/SP/MV is displayed (See note.)
5	The PV, SP, Program No., and Segment No., and the PV, SP, and Remaining Segment Time are displayed in order.
6	The PV, SP, and MV (see note.) and the PV, SP, and Remaining Segment Time are displayed in order.
7	Only the PV, SP, Remaining Segment Time are displayed.

**Note** The MV for heating and cooling control is set in the MV Display Selection parameter.



■ **Related Parameters**

- Process value/set point (operation level): Page 185
- MV display selection (advanced function setting level): Page 288

ād5L

**MV Display Selection**

The No. 3 display must be supported (E5AN/EN-HT).

Heating and cooling control must be used.

The PV/SP Display Screen Selection parameter must be set to 1, 2, 4, or 6, or the Monitor/Setting Item 1 to 5 parameter must be set to 2.



- This parameter selects the MV display for PV/SP/MV during heating and cooling control. Either heating MV or cooling MV can be selected.

Setting range	Default
ā: MV (heating)	ā
[ - ā: MV (cooling)	

**PV dP**

**PV Decimal Point Display**

The input type must be set to temperature input.



Function

The display below the decimal point in the PV can be hidden for temperature inputs.

- The PV decimals below the decimal point can be hidden by setting the PV Decimal Point Display parameter to OFF. When this parameter is set to ON, the display below the decimal point will appear according to the input type setting.



Setting

Setting range	Default
$\bar{a}N$ : ON, $\bar{a}FF$ : OFF	ON



■ **Related Parameters**

Input type (initial setting level): Page 236

**PV St**

**PV Status Display Function**

- The PV in the No. 1 display for the PV/SP, PV, or PV/Manual MV (Valve Opening) Screen is alternately displayed in 0.5-s cycles with the control and alarm status specified for the PV status display function.



Monitor

Monitor range	Default
$\bar{a}FF$ : No PV status display	$\bar{a}FF$
$M\bar{R}N\bar{U}$ : MANU is alternately displayed during manual control.	
$R\bar{S}E$ : RST is alternately displayed while resetting.	
$R\bar{L}M\bar{1}$ : ALM1 is alternately displayed during Alarm 1 status.	
$R\bar{L}M\bar{2}$ : ALM2 is alternately displayed during Alarm 2 status.	
$R\bar{L}M\bar{3}$ : ALM3 is alternately displayed during Alarm 3 status.	
$R\bar{L}M$ : ALM is alternately displayed when Alarm 1, 2, or 3 is set to ON.	
$H\bar{R}$ : HA is alternately displayed when a heater burnout alarm, HS alarm, or heater overcurrent alarm is ON.	
$S\bar{t}b$ : STB is alternately displayed during standby status.	



■ **Related Parameters**

Process value/set point, PV (operation level): Page 185

PV/MV (manual MV) (manual control level): Page 232

## SV St SV Status Display Function



- The SP, Blank, or Manual MV in the No. 2 display for the PV/SP, PV, or PV/Manual MV (Valve Opening) Screen is alternately displayed in 0.5-s cycles with the control and alarm status specified for the SV status display function.



Monitor range	Default
<i>OFF</i> : No SV status display	<i>OFF</i>
<i>MANU</i> : MANU is alternately displayed during manual control.	
<i>RSt</i> : RST is alternately displayed while resetting.	
<i>ALM 1</i> : ALM1 is alternately displayed during Alarm 1 status.	
<i>ALM 2</i> : ALM2 is alternately displayed during Alarm 2 status.	
<i>ALM 3</i> : ALM3 is alternately displayed during Alarm 3 status.	
<i>ALM</i> : ALM is alternately displayed when Alarm 1, 2, or 3 is set to ON.	
<i>HA</i> : HA is alternately displayed when a heater burnout alarm, HS alarm, or heater overcurrent alarm is ON.	
<i>STB</i> : STB is alternately displayed during standby status.	



■ **Related Parameters**

- Process value/set point, PV (operation level): Page 185
- PV/MV (manual MV) (manual control level): Page 232

## d.REF Display Refresh Period



- This parameter delays the display refresh period for monitor values. Only display refreshing is delayed, and the refresh period for process values used in control is not changed.
- This function is disabled by setting the parameter to OFF.



Setting range	Unit	Default
OFF, 0.25, 0.5, 1.0	Second	0.25



RA1M

**Control Output 1 ON/OFF Count Monitor**

Control output 1 must be supported. A relay output or voltage output (for driving SSR) must be used. The Control Output 1 ON/OFF Count Alarm Set Value parameter must not be set to 0.



Function

- This parameter monitors the number of times that control output 1 is turned ON and OFF.
- This function is not displayed when the set value is 0, or when the control output is a linear output.



Monitor

Monitor range	Unit
0 to 9999	100 times

RA2M

**Control Output 2 ON/OFF Count Monitor**

Control output 2 must be supported. A relay output or voltage output (for driving SSR) must be used. The Control Output 2 ON/OFF Count Alarm Set Value parameter must not be set to 0.



Function

- This parameter monitors the number of times that control output 2 is turned ON and OFF.
- This function is not displayed when the set value is 0, or when the control output is a linear output.



Monitor

Monitor range	Unit
0 to 9999	100 times

RR1

**Control Output 1 ON/OFF Count Alarm Set Value**

Control output 1 must be supported. A relay output or voltage output (for driving SSR) must be used.



Function

- An ON/OFF count alarm occurs when the ON/OFF counter exceeds the value set for this parameter.
- It is possible to assign ON/OFF count alarms to auxiliary outputs and to have them displayed on the screen.
- This function is disabled when the set value is 0.



Monitor

Setting range	Unit	Default
0 to 9999	100 times	0



■ **Related Parameters**

Control output 1 ON/OFF count monitor (advanced function setting level):  
Page 291

RR2

**Control Output 2 ON/OFF Count Alarm Set Value**

Control output 2 must be supported. A relay output or voltage output (for driving SSR) must be used.



Function

- An ON/OFF count alarm occurs when the ON/OFF counter exceeds the value set for this parameter.
- It is possible to assign ON/OFF count alarms to auxiliary outputs and to have them displayed on the screen.
- This function is disabled when the set value is 0.



Monitor

Setting range	Unit	Default
0 to 9999	100 times	0



■ **Related Parameters**

Control output 2 ON/OFF count monitor (advanced function setting level):  
Page 291

**RAC**

**ON/OFF Counter Reset**

Control outputs 1 and 2 must be supported.  
A relay output or voltage output must be used.



Function

- This parameter resets the ON/OFF counter for specified control outputs.



Setting

Setting range	Default
0: Disable the counter reset function.	0
1: Reset the control output 1 ON/OFF counter.	
2: Reset the control output 2 ON/OFF counter.	

**Note** After the counter has been reset, the set value will be automatically returned to 0.

■ **Related Parameters**

Control output 1 ON/OFF count monitor, Control output 2 ON/OFF count monitor (advanced function setting level): Page 291



See

**PENd**

**Program End ON Time**

- This parameter sets the pulse width of the program end output. The setting range is ON or 0.0 to 10.0 s. The default is 0.0 s.
- If ON is set, the output will remain ON until the Run/Reset parameter is changed to Run during reset status.



Function



Setting

Setting range	Unit	Default
$\bar{a}N$ : Output continuously.	Seconds	0.0
0.0: No output.		
0.1 to 10.0		

■ **Related Information**

4-15 Program-related Functions: Page 138

■ **Related Parameters**

Control output 1 assignment (advanced function setting level): Page 273  
Control output 2 assignment (advanced function setting level): Page 274  
Auxiliary output 1 assignment (advanced function setting level): Page 275  
Auxiliary output 2 assignment (advanced function setting level): Page 276



See

## 5-U Standby Time Unit



Function

- This parameter sets the unit for the standby time.  
Always set this parameter before setting the standby time.



Setting

Setting range	Unit	Default
H-M: hours and minutes	---	H-M: Hours and minutes
d-H: Days and hours		



### ■ Related Parameters

Standby time (adjustment level): Page 223

## PSRd Program SP Shift Value Addition



Function

This parameter displays and hides the Program SP Shift Value parameter.



Setting

Setting range	Default
$\bar{a}N$ : Display, $\bar{a}FF$ : Hide	$\bar{a}FF$



### ■ Related Information

4-15 Program-related Functions: Page 138

### ■ Related Parameters

Program SP shift value (adjustment level): Page 224

## RCRd RSP Broken-line Correction Display Addition

The Remote SP Enable parameter must be set to ON.



Function

This parameter displays and hides the RSP 0 to RSP 10 before Correction and Broken-line Correction Value 0 to 10 parameters.



Setting

Setting range	Default
$\bar{a}N$ : Display, $\bar{a}FF$ : Hide	$\bar{a}FF$



■ **Related Information**

4-22 Using a Remote SP: Page 162

■ **Related Parameters**

RSP 0 to RSP 10 before correction, Broken-line correction value 0 to 10 (adjustment level): Page 224

---

CMoV

**Move to Calibration Level**

Initial setting/communications protect must be 0.



Function

- Set the password to move to the calibration level. The password is 1201.
- Move to the calibration level either by pressing the Key or Key or by waiting for two seconds to elapse.



■ **Related Parameter**

Initial setting/communications protect (protect level): Page 180

## 5-11 Communications Setting Level

<i>PSEL</i>	<b>Protocol Setting</b>	Communications must be supported.
<i>U-N<math>\bar{o}</math></i>	<b>Communications Unit No.</b>	
<i>bPS</i>	<b>Communications Baud Rate</b>	
<i>LEN</i>	<b>Communications Data Length</b>	CompoWay/F must be selected as the protocol.
<i>Sb<math>\bar{c}t</math></i>	<b>Communications Stop Bits</b>	CompoWay/F must be selected as the protocol.
<i>PR<math>\bar{t}y</math></i>	<b>Communications Parity</b>	
<i>Sd<math>\bar{w}t</math></i>	<b>Send Data Wait Time</b>	

- Each parameter is enabled when the power is reset.
- Match the communications specifications of the E5□N-H and the host computer. If multiple devices are connected, ensure that the communications specifications for all devices in the system (except the Communications unit number) are the same.

Item	Symbol	Set values	Settings	Default
Protocol setting	<i>PSEL</i>	<i>ENF, M<math>\bar{o}d</math></i>	CompoWay/F (SYSWAY), Modbus	<i>ENF</i>
Communications Unit No.	<i>U-N<math>\bar{o}</math></i>	0 to 99	0 to 99	<i>1</i>
Communications baud rate	<i>bPS</i>	1.2, 2.4, 4.8, 9.6, 19.2, 38.4, or 57.6 (kbps)	1.2, 2.4, 4.8, 9.6, 19.2, 38.4, or 57.6 (kbps)	<i>9.6</i>
Communications data length	<i>LEN</i>	7 or 8 bits	7 or 8 bits	<i>7</i>
Stop bits	<i>Sb<math>\bar{c}t</math></i>	1 or 2 bits	1 or 2 bits	<i>2</i>
Communications parity	<i>PR<math>\bar{t}y</math></i>	<i>N<math>\bar{o}NE</math>, EV<math>\bar{E}N</math>, <math>\bar{o}dd</math></i>	None, Even, Odd	<i>EV<math>\bar{E}N</math></i>
Send data wait time	<i>Sd<math>\bar{w}t</math></i>	0 to 99	0 to 99 (ms)	<i>20</i>

■ **Related Parameter**

Communications writing (adjustment level): Page 209



# SECTION 6 CALIBRATION

This section describes how the user can calibrate the E5CN-H Digital Controllers.

6-1	Parameter Structure . . . . .	298
6-2	User Calibration . . . . .	299
6-2-1	Calibrating Inputs . . . . .	299
6-2-2	Registering Calibration Data . . . . .	299
6-3	Thermocouple Calibration (Thermocouple/Resistance Thermometer Input) . . . . .	299
6-3-1	Preparations . . . . .	300
6-4	Platinum Resistance Thermometer Calibration (Thermocouple/Resistance Thermometer Input) . . . . .	303
6-5	Calibrating Analog Input (Analog Input) . . . . .	304
6-5-1	Calibrating a Current Input . . . . .	304
6-5-2	Calibrating a Voltage Input . . . . .	305
6-6	Calibrating the Transfer Output . . . . .	306
6-7	Checking Indication Accuracy . . . . .	308
6-7-1	Thermocouple . . . . .	308
6-7-2	Platinum Resistance Thermometer . . . . .	308
6-7-3	Analog Input . . . . .	309

# 6-1 Parameter Structure

- To execute user calibration, enter the password “1201” at the Move to Calibration Level parameter in the advanced function setting level. The mode will be changed to the calibration mode, and *Adj* will be displayed.
- The Move to Calibration Level parameter may not be displayed. If this happens, set the Initial/Communications Protect parameter in the protect level to 0 before moving to the advanced function setting level. (The default setting is 0.)
- The calibration mode is ended by turning the power OFF.
- The parameter calibrations in the calibration mode are structured as shown below.

## Controllers with Thermocouple/Resistance Thermometer Universal Inputs

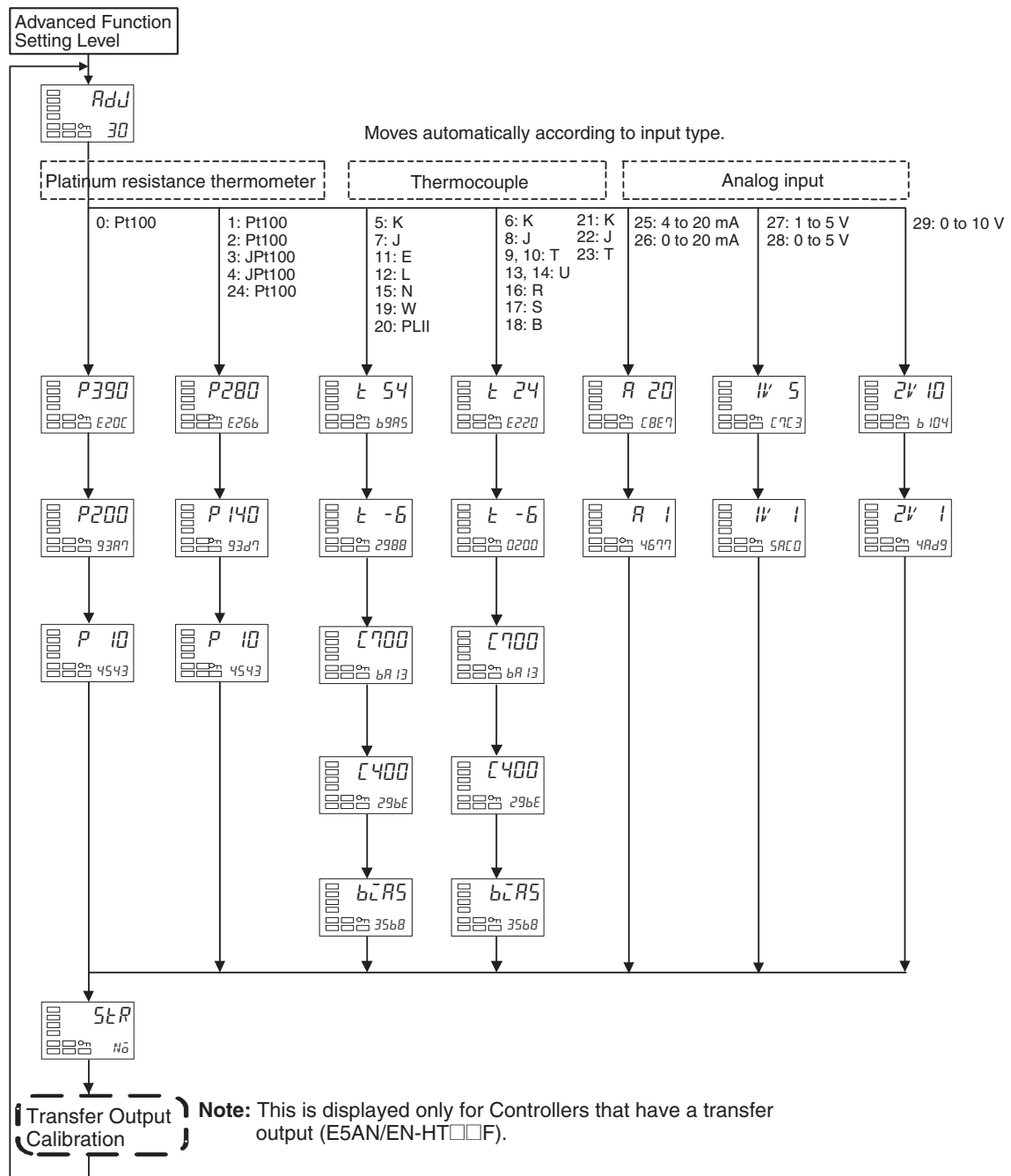



When calibration has been performed after purchase, the user calibration information shown in the following illustration will be displayed when moving to the calibration level.

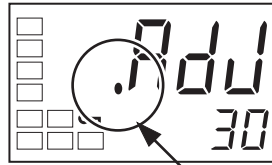

A dot is displayed.

## 6-2 User Calibration

The E5□N-HT is correctly calibrated before it is shipped from the factory, and normally need not be calibrated by the user.

If, however, it must be calibrated by the user, use the parameters for calibrating temperature input and analog input. OMRON, however, cannot ensure the results of calibration by the user. Also, calibration data is overwritten with the latest calibration results. The default calibration settings cannot be restored after user calibration. Perform user calibration with care.

### 6-2-1 Calibrating Inputs

The input type selected in the parameter is used for calibration. The input types are as follows:

Controllers with Thermocouple, Resistance Thermometer, Analog Universal Inputs

- Thermocouple: 19 types
- Analog input: 5 types
- Platinum resistance thermometer: 6 types

### 6-2-2 Registering Calibration Data

The new calibration data for each item is temporarily registered. It can be officially registered as calibration data only when all items have been calibrated to new values. Therefore, be sure to temporarily register all items when you perform the calibration. When the data is registered, it is also recorded that user calibration has been performed.

Prepare separate measuring devices and equipment for calibration. For details on how to handle measuring devices and equipment, refer to the respective instruction manuals.

## 6-3 Thermocouple Calibration (Thermocouple/Resistance Thermometer Input)

- Calibrate according to the type of thermocouple: thermocouple 1 group (input types 5, 7, 11, 12, 15, 19, 20) and thermocouple 2 group (input types 6, 8, 9, 10, 13, 14, 16, 17, 18, 21, 22, 23).
- When calibrating, do not cover the bottom of the Controller. Also, do not touch input terminals/pins (terminals 4 and 5 on the E5CN-HT, and pins 19 and 20 on the E5AN/EN-HT) or compensating conductors.

### 6-3-1 Preparations

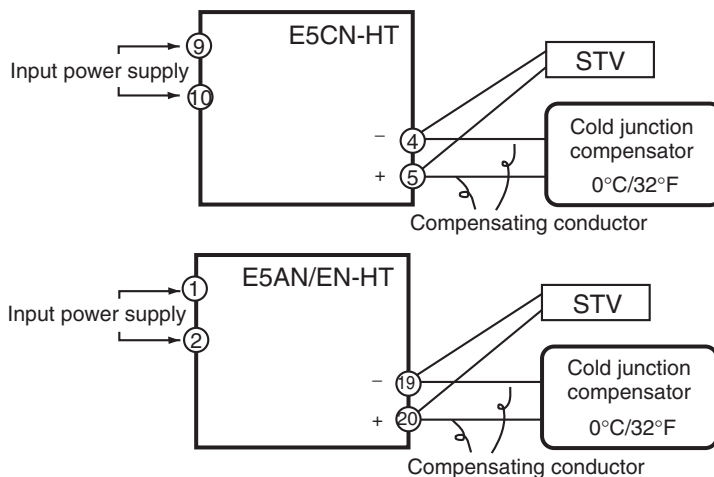

- Set the cold junction compensator designed for compensation of internal thermocouples to 0°C. Make sure that internal thermocouples are disabled (i.e., that tips are open).
- In the above figure, STV indicates a standard DC current/voltage source.
- Use the compensating conductor designed for the selected thermocouple. When thermocouples R, S, E, B, W, or PLII is used, the cold junction compensator and the compensating conductor can be substituted with the cold junction compensator and the compensating conductor for thermocouple K.

#### ■ Connecting the Cold Junction Compensator

Correct process values cannot be obtained if you touch the contact ends of the compensating conductor during calibration of a thermocouple. Accordingly, short-circuit (enable) or open (disable) the tip of the thermocouple inside the cold junction compensator as shown in the figure below to create a contact or non-contact state for the cold junction compensator.

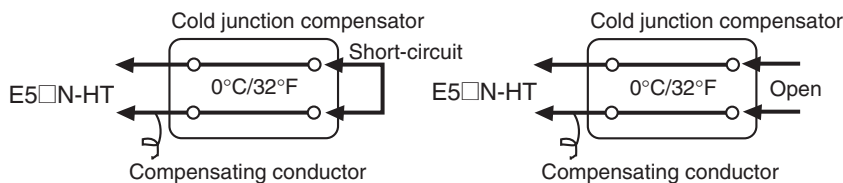

In this example, calibration is shown for a Controller with a thermocouple set as the input type.

- 1,2,3...**
1. Connect the power supply.
  2. Connect a standard DC current/voltage source (STV), precision digital multimeter (DMM), and contact junction compensator (e.g., a zero controller as in the figure) to the thermocouple input terminals, as shown in the figure below.

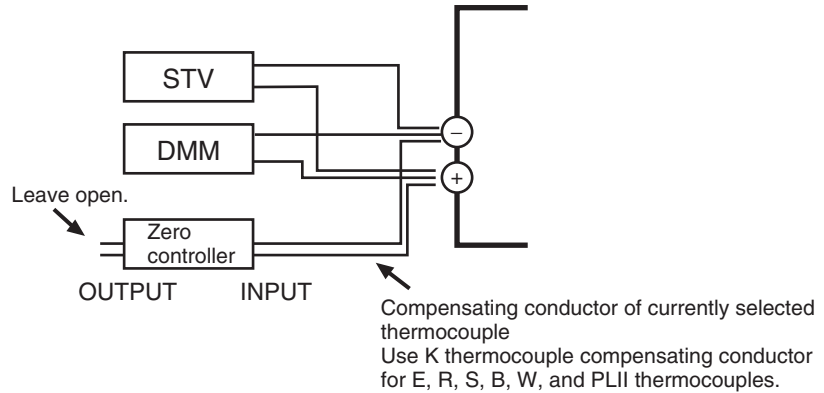

3. Turn the power ON.
4. Move to the calibration level.  
This starts the 30-minute aging timer. This timer provides an approximate timer for aging. After 30 minutes have elapsed, the No. 2 display changes to 0. You can advance to the next step in this procedure even if 0 is not displayed.

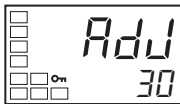

Input types 5, 7, 11, 12, 15, 19, 20:

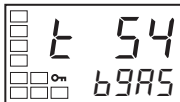

Input types 6, 8, 9, 10, 13, 14, 16, 17, 18, 21, 22, 23:

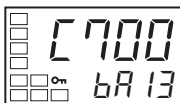
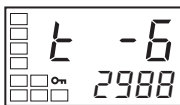
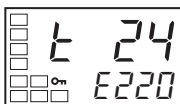

5. When the Key is pressed, the status changes as shown to the left. The No. 2 display at this time shows the currently entered count value in hexadecimal. Set the STV as follows:
  - Input types 5, 7, 11, 12, 15, 19, 20: Set to 54 mV.
  - Input types 6, 8, 9, 10, 13, 14, 16, 17, 18, 21, 22, 23: Set to 24 mV.
 Allow the count value on the No. 2 display to fully stabilize, then press the Key to temporarily register the calibration settings. If this count value is outside of the specified range, the No. 2 display will flash and the count value will not be temporarily registered.
6. When the Key is pressed, the status changes as shown to the left. Set the STV to -6 mV. Allow the count value on the No. 2 display to fully stabilize, then press the Key to temporarily register the calibration settings. If this count value is outside of the specified range, the No. 2 display will flash and the count value will not be temporarily registered.
7. Press the Key. The display changes as shown on the left. Set the STV to 700 mV. Allow the count value on the No. 2 display to fully stabilize, then press the Key to temporarily register the calibration settings. If this count value is outside of the specified range, the No. 2 display will flash and the count value will not be temporarily registered.

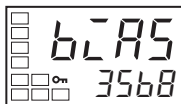
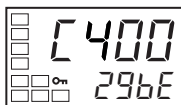

8. Press the Key. The display changes as shown on the left. Set the STV to 400 mV. Allow the count value on the No. 2 display to fully stabilize, then press the Key to temporarily register the calibration settings. If this count value is outside of the specified range, the No. 2 display will flash and the count value will not be temporarily registered.

9. When the Key is pressed, the status changes as shown to the left.

10. Change the wiring as follows:

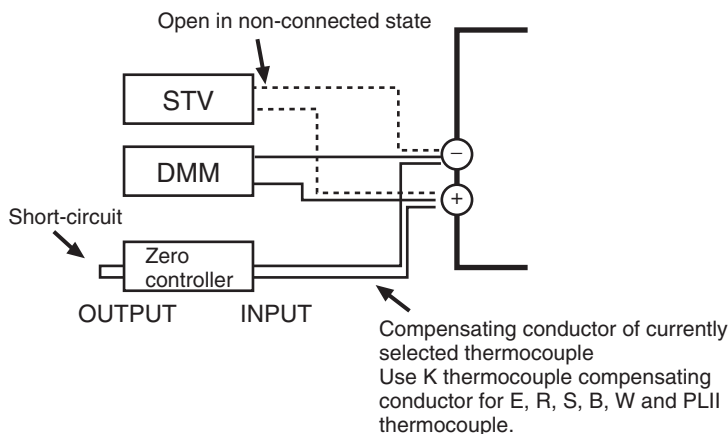

Disconnect the STV to enable the thermocouple of the cold junction compensator. When doing this, be sure to disconnect the wiring on the STV side.

11. Allow the count value on the No. 2 display to fully stabilize, then press the Key to temporarily register the calibration settings.

12. When the Key is pressed, the status changes as shown to the left. The data to be temporarily registered is not displayed if it is not complete. Press the Key. The No. 2 display changes to  $\overline{4E5}$ . Release the key and wait two seconds or press the Key. This stores the temporarily registered calibration data to EEPROM. To cancel the saving of temporarily registered calibration data to EEPROM, press the Key (while  $\overline{N\bar{a}}$  is displayed in the No. 2 display) without pressing the Key.

13. The calibration mode is ended by turning the power OFF.

For Controllers that have a transfer output (E5□N-HT□□F), transfer output calibration continues to be performed. For details on the settings, refer to 6-6 *Calibrating the Transfer Output* on page 306.

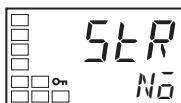

## 6-4 Platinum Resistance Thermometer Calibration (Thermocouple/Resistance Thermometer Input)

In this example, calibration is shown for Controller with a resistance thermometer set as the input type.

Use connecting wires of the same thickness.

- 1,2,3... 1. Connect the power supply.
2. Connect a precision resistance box (called a “6-dial” in this manual) to the platinum resistance thermometer input terminals, as shown in the following diagram.

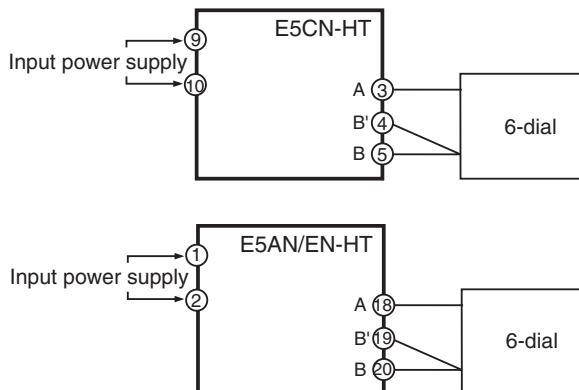

3. Turn the power ON.
4. Move to the calibration level.  
This starts the 30-minute aging timer. This timer provides an approximate timer for aging. After 30 minutes have elapsed, the No. 2 display changes to 0. You can advance to the next step in this procedure even if 0 is not displayed.

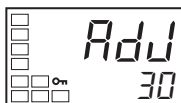

Input type 0:

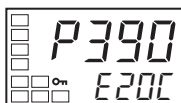

Input types 1, 2, 3, 4, 24:

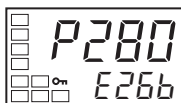

Input type 0:

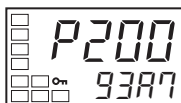

Input types 1, 2, 3, 4, 24:

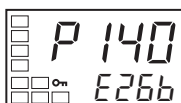

5. Execute calibration for the main input.  
Press the Key to display the count value for each input type. The No. 2 display at this time shows the currently entered count value in hexadecimal. Set the 6-dial as follows:

- Input type 0: 390 Ω
- Input type 1, 2, 3, 4 or 24: 280 Ω

Allow the count value on the No. 2 display to fully stabilize, then press the Key to temporarily register the calibration settings.

If this count value is outside of the specified range, the No. 2 display will flash and the count value will not be temporarily registered.

Press the Key to display the count value for each input type.

The No. 2 display at this time shows the currently entered count value in hexadecimal. Set the 6-dial as follows:

- Input type 0: 200 Ω
- Input type 1, 2, 3, 4 or 24: 140 Ω

Allow the count value on the No. 2 display to fully stabilize, then press the Key to temporarily register the calibration settings.

If this count value is outside of the specified range, the No. 2 display will flash and the count value will not be temporarily registered.

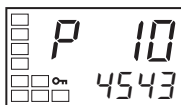

- When the Key is pressed, the status changes as shown to the left. Set the 6-dial to 10 Ω.

Allow the count value on the No. 2 display to fully stabilize, then press the Key to temporarily register the calibration settings.

If this count value is outside of the specified range, the No. 2 display will flash and the count value will not be temporarily registered.

Here, the calibration is temporarily registered. If this count value is outside of the specified range, the No. 2 display will flash and the count value will not be temporarily registered.

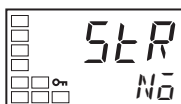

- When the Key is pressed, the status changes as shown to the left. The data to be temporarily registered is not displayed if it is not complete. Press the Key. The No. 2 display changes to *YES*. Release the key and wait two seconds or press the Key. This stores the temporarily registered calibration data to EEPROM.

To cancel the saving of temporarily registered calibration data to EEPROM, press the Key (while *No* is displayed in the No. 2 display) without pressing the Key.

- The calibration mode is quit by turning the power OFF.

For Controllers that have a transfer output (E5□N-HT□□F), transfer output calibration continues to be performed. For details on the settings, refer to 6-6 *Calibrating the Transfer Output* on page 306.

## 6-5 Calibrating Analog Input (Analog Input)

### 6-5-1 Calibrating a Current Input

In this example, calibration is shown for a Controller with a current input set as the input type.

- 1,2,3... 1. Connect the power supply.  
2. Connect an STV and DMM to the current input terminals, as shown in the following diagram.

E5CN-HT

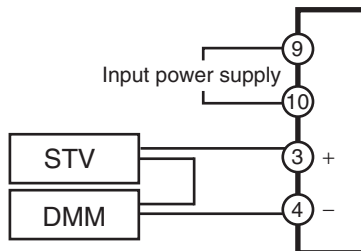

E5AN/EN-HT

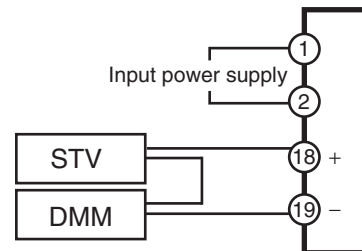

- Turn the power ON.
- Move to the calibration level. This starts the 30-minute aging timer. This timer provides an approximate timer for aging. After 30 minutes have elapsed, the No. 2 display changes to 0. You can advance to the next step in this procedure even if 0 is not displayed.

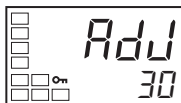

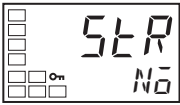
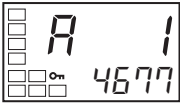

- When the Key is pressed, the status changes as shown to the left. The No. 2 display at this time shows the currently entered count value in hexadecimal. Set the STV to 20 mA.

Allow the count value on the No. 2 display to fully stabilize, then press the Key to temporarily register the calibration settings.

If this count value is outside of the specified range, the No. 2 display will flash and the count value will not be temporarily registered.

- When the Key is pressed, the status changes as shown to the left. Set the STV to 1 mA.

Allow the count value on the No. 2 display to fully stabilize, then press the Key to temporarily register the calibration settings.

If this count value is outside of the specified range, the No. 2 display will flash and the count value will not be temporarily registered.

- When the Key is pressed, the status changes as shown to the left. The data to be temporarily registered is not displayed if it is not complete. Press the Key. The No. 2 display changes to *4E5*. Release the key and wait two seconds or press the Key. This stores the temporarily registered calibration data to EEPROM.

To cancel the saving of temporarily registered calibration data to EEPROM, press the Key (while *N0* is displayed in the No. 2 display) without pressing the Key.

- The calibration mode is ended by turning the power OFF.

For Controllers that have a transfer output (E5□N-HT□□F), transfer output calibration continues to be performed. For details on the settings, refer to 6-6 *Calibrating the Transfer Output* on page 306.

## 6-5-2 Calibrating a Voltage Input

In this example, calibration is shown for a Controller with a voltage input set as the input type.

- 1,2,3...**
- Connect the power supply.
  - Connect an STV and DMM to the voltage input terminals, as shown in the following diagram.

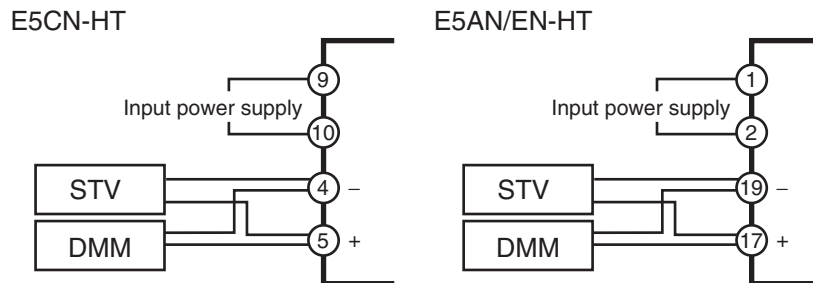

- Turn the power ON.
- Move to the calibration level. This starts the 30-minute aging timer. This timer provides an approximate timer for aging. After 30 minutes have elapsed, the No. 2 display changes to 0. You can advance to the next step in this procedure even if 0 is not displayed.

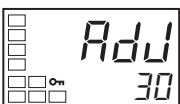

Input type 27 or 28:

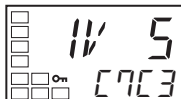

Input type 29:

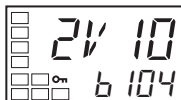

Input type 27 or 28:



Input type 29:

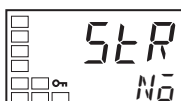
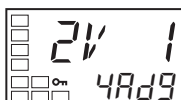

5. When the Key is pressed, the status changes as shown to the left. The No. 2 display at this time shows the currently entered count value in hexadecimal. Set the STV as follows:
  - Input type 27 or 28: 5 V
  - Input type 29: 10 V
 Allow the count value on the No. 2 display to fully stabilize, then press the Key to temporarily register the calibration settings. If this count value is outside of the specified range, the No. 2 display will flash and the count value will not be temporarily registered.
6. When the Key is pressed, the status changes as shown to the left. Set the STV to 1 V.
 Allow the count value on the No. 2 display to fully stabilize, then press the Key to temporarily register the calibration settings. If this count value is outside of the specified range, the No. 2 display will flash and the count value will not be temporarily registered.
7. When the Key is pressed, the status changes as shown to the left. The data to be temporarily registered is not displayed if it is not complete. Press the Key. The No. 2 display changes to 4E5. Release the key and wait two seconds or press the Key. This stores the temporarily registered calibration data to EEPROM. To cancel the saving of temporarily registered calibration data to EEPROM, press the Key (while No is displayed in the No. 2 display) without pressing the Key.
8. The calibration mode is ended by turning the power OFF. For Controllers that have a transfer output (E5□N-HT□□F), transfer output calibration continues to be performed. For details on the settings, refer to 6-6 Calibrating the Transfer Output on page 306.

## 6-6 Calibrating the Transfer Output

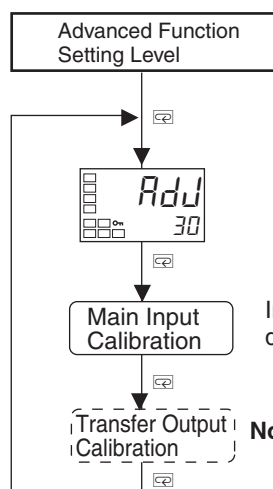

**Note:** This is displayed only for Controllers that have a transfer output (E5AN/EN-HT□□F).

For Controllers that have a transfer output (E5□N-HT□□F), the Transfer Output Calibration Screen will be displayed after input calibration has been completed.



Use the following procedure for calibration.

1. Connect the DMM to the transfer output terminal.

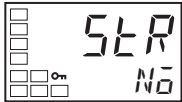

2. Press the Key to switch to the Transfer Output Screen.

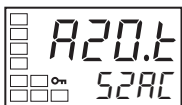

3. The 20 mA Calibration Screen will be displayed. Use the and Keys to adjust the DMM monitor value to 20 mA, and then press the Key. The contents of the calibration will be temporarily registered.



4. The 4 mA Calibration Screen will be displayed. Use the and Keys to adjust the DMM monitor value to 4 mA, and then press the Key. The contents of the calibration will be temporarily registered.

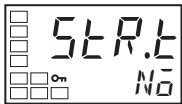

5. Press the Key. The No. 2 display changes to *4E5*. Release the key and wait two seconds or press the Key. This stores the temporarily registered calibration data to EEPROM.

To cancel the saving of temporarily registered calibration data to EEPROM, press the Key (while *No* is displayed in the No. 2 display) without pressing the Key.

6. The calibration mode is quit by turning the power OFF.

## 6-7 Checking Indication Accuracy

- After calibrating the input, be sure to check the indication accuracy to make sure that the calibration has been executed correctly.
- Operate the E5□N-HT in the process value/set point monitor mode.
- Check the indication accuracy at the following three values: upper limit, lower limit, and mid-point.

### 6-7-1 Thermocouple

- Preparations

The diagram below shows the required device connections. Make sure that the E5□N-HT and cold junction compensator are connected by a compensating conductor for the thermocouple that is to be used during actual operation.

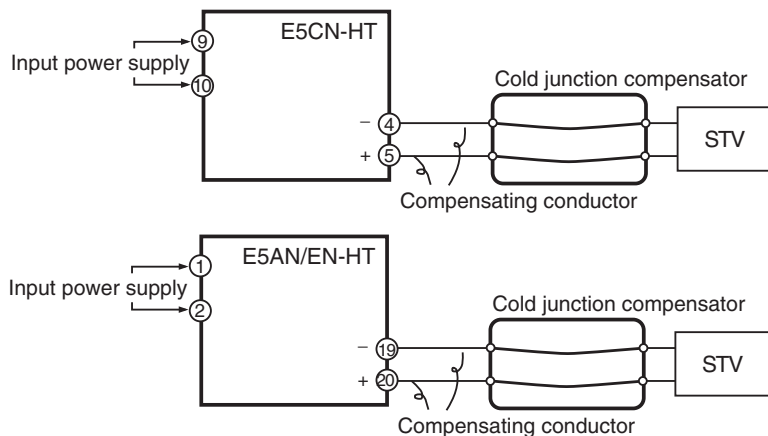

- Operation

Make sure that the cold junction compensator is at 0°C, and set the STV output to the voltage equivalent of the starting power of the check value. The cold junction compensator and compensation conductor are not required when an external cold junction compensation method is used.

### 6-7-2 Platinum Resistance Thermometer

- Preparations

The diagram below shows the required device connections.

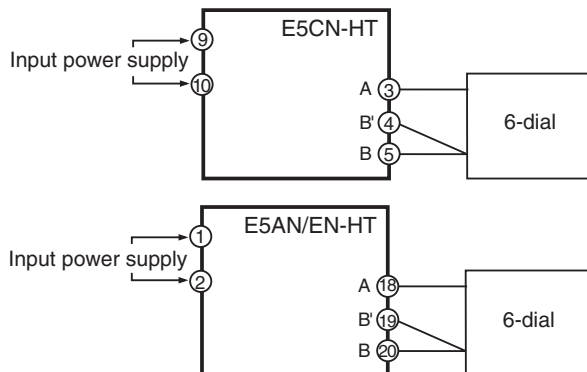

- Operation

Set the 6-dial to the resistance equivalent to the check value.

### 6-7-3 Analog Input

- Preparations

The diagram below shows the required device connections.  
 (The connection terminals depend on the model and input type.)

#### **Current Input for a Controller with an Analog Input**

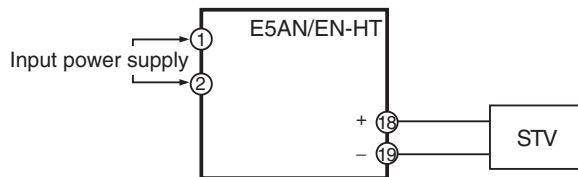
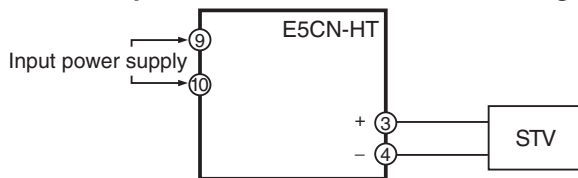

#### **Voltage Input for a Controller with an Analog Input**

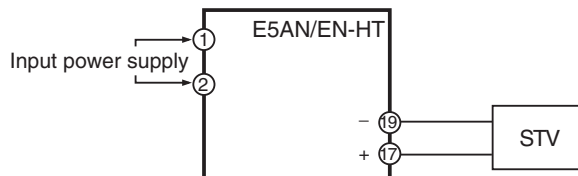
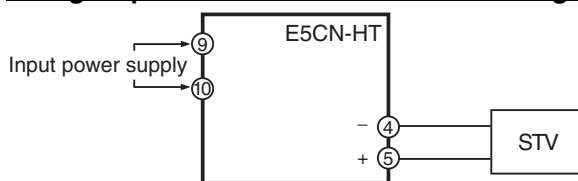

- Operation

Set the STV output to the voltage or current equivalent to the check value.



# Appendix

## Specifications

### Ratings

Supply voltage	100 to 240 VAC, 50/60 Hz	24 VAC, 50/60 Hz/24 VDC	
Operating voltage range	85% to 110% of rated supply voltage		
Power consumption	E5CN-HT	8.5 VA	5.5 VA/3.5 W
	E5AN-HT	12 VA	8.5 VA/5.5 W
	E5EN-HT	12 VA	8.5 VA/5.5 W
Sensor input (See note 1.)	Temperature input Thermocouple: K, J, T, E, L, U, N, R, S, B, W, PLII Platinum resistance thermometer: Pt100, JPt100		
	Controllers with Analog (See note 2.) Current input: 4 to 20 mA, 0 to 20 mA (Input impedance: 150 Ω max.) Voltage input: 1 to 5 V, 0 to 5 V, 0 to 10 V (Input impedance: 1 MΩ max.)		
Control output	Relay output	E5CN-HT	SPST-NO, 250 VAC, 3 A (resistive load), electrical durability: 100,000 operations Min. applicable load: 5 V, 10 mA
		E5AN-HT E5EN-HT	SPST-NO, 250 VAC, 1 A (including inrush current), electrical durability: 100,000 operations Min. applicable load: 5 V, 10 mA
	Voltage output	E5CN-HT	Output voltage 12 VDC ±15% (PNP), max. load current 21 mA, with short-circuit protection circuit
	Current output	E5CN-HT	4 to 20 mA DC, 0 to 20 mA DC, Load: 600 Ω max., Resolution: approx. 10,000
	Linear voltage output	E5CN-HT	0 to 10 VDC, Load: 1 kΩ min., Resolution: approx. 10,000
Auxiliary output	E5CN-HT	SPST-NO, 250 VAC, 3 A (resistive load), electrical durability: 100,000 operations Min. applicable load: 5 V, 10 mA	
	E5AN-HT E5EN-HT	SPST-NO, 250 VAC, 3 A (resistive load), electrical durability: 100,000 operations Min. applicable load: 5 V, 10 mA	
Control method	2-PID or ON/OFF control		
Setting method	Digital setting using front panel keys		
Indication method	11-segment/7-segment digital display and single-lighting indicator		
Other functions	Depend on the model		
Ambient temperature	-10 to 55°C (with no condensation or icing); with 3-year guarantee: -10 to 50°C		
Ambient humidity	25% to 85%		
Storage temperature	-25 to 65°C (with no condensation or icing)		
Altitude	2,000 m or less		
Recommended fuse	T2A, 250 VAC, time lag, low shut-off capacity		
Installation environment	Installation Category II, Pollution Class 2 (IEC 61010-1 compliant)		

- Note** (1) For the setting ranges for each sensor input, see page 351.  
(2) When connecting the ES2-THB, connect it 1:1.

**E5AN-HT/EN-HT Output Unit Ratings**

Model	Output type	Output form	Specifications
E53-RN	Relay	ON/OFF	250 VAC, 5 A (resistive load), electrical durability: 100,000 operations
E53-QN	Voltage (PNP)	ON/OFF	PNP type, 12 VDC, 40 mA (with short-circuit protection)
E53-Q3	Voltage (NPN)	ON/OFF	NPN type, 24 VDC, 20 mA (with short-circuit protection)
E53-Q4	Voltage (PNP)	ON/OFF	PNP type, 24 VDC, 40 mA (with short-circuit protection)
E53-C3N	4 to 20 mA	Linear	4 to 20 mA DC, Load: 600 $\Omega$ max., Resolution: approx. 10,000
E53-C3DN	0 to 20 mA	Linear	0 to 20 mA DC, Load: 600 $\Omega$ max., Resolution: approx. 10,000
E53-V34N	0 to 5 V	Linear	0 to 10 VDC, Load: 1 k $\Omega$ min., Resolution: approx. 10,000
E53-V35N	0 to 10 V	Linear	0 to 5 VDC, Load: 1 k $\Omega$ min., Resolution: approx. 10,000

**HB, HS, and Heater Overcurrent Alarms (for E5CN/AN/EN-HT Controllers with Heater Burnout, HS, and Heater Overcurrent Alarms)**

Max. heater current	50 A AC
Input current readout accuracy	$\pm 5\%$ FS $\pm 1$ digit max.
Heater burnout alarm setting range	0.1 to 49.9 A (0.1 A units) 0.0 A: Heater burnout alarm output turns OFF. 50.0 A: Heater burnout alarm output turns ON. Min. detection ON time: 100 ms (See note 1.)
HS alarm setting range	0.1 to 49.9 A (0.1 A units) 0.0 A: HS alarm output turns ON. 50.0 A: HS alarm output turns OFF. Min. detection OFF time: 100 ms (See note 2.)
Heater overcurrent alarm setting range	0.1 to 49.9 A (0.1 A units) 0.0 A: Heater overcurrent alarm output turns ON. 50.0 A: Heater overcurrent alarm output turns OFF. Min. detection OFF time: 100 ms

**Note** (1) When the control output 1 ON time is less than 100 ms, heater burnout detection, heater overcurrent detection, and heater current measurement are not performed.

(2) When the control output 1 OFF time is less than 100 ms, HS alarm, and leakage current measurement are not performed.

**Characteristics**

Indication accuracy (ambient temperature of 23°C)	Thermocouple (See note 1.): ( $\pm 0.1\%$ of indication value or $\pm 1^\circ\text{C}$ , whichever is greater) $\pm 1$ digit max. Platinum resistance thermometer: ( $\pm 0.1\%$ of indication value or $\pm 0.5^\circ\text{C}$ , whichever is greater) $\pm 1$ digit max. Analog input: $\pm 0.1\%$ FS $\pm 1$ digit max. CT input: $\pm 5\%$ FS $\pm 1$ digit max.	
Temperature variation influence (See note 2.)	Thermocouple (R, S, B, W, PLII) ( $\pm 1\%$ of PV or $\pm 10^\circ\text{C}$ , whichever is greater) $\pm 1$ digit max. Other thermocouples: ( $\pm 1\%$ of PV or $\pm 4^\circ\text{C}$ , whichever is greater) $\pm 1$ digit max. *K thermocouple at $-100^\circ\text{C}$ max: $\pm 10^\circ\text{C}$ max.	
Voltage variation influence (See note 2.)	Platinum resistance thermometer: ( $\pm 1\%$ of PV or $\pm 2^\circ\text{C}$ , whichever is greater) $\pm 1$ digit max. Analog input: $\pm 1\%$ FS $\pm 1$ digit max.	
Hysteresis	Temperature Input	0.1 to 3240.0°C or °F (in units of 0.1°C or °F)
	Analog Input	0.01% to 99.99% FS (in units of 0.01% FS)

Proportional band (P)	Temperature Input	0.1 to 3240.0°C or °F (in units of 0.1°C or °F)		
	Analog Input	0.1% to 999.9% FS (in units of 0.1% FS)		
Integral time (I)	Standard, heating/cooling, position proportional (closed): 0.0 to 3240.0 Position proportional (floating): 0.1 to 3240.0 (in units of 0.1 s)			
Derivative time (D)	0.0 to 3240.0 (in units of 0.1 s)			
Control Period	0.5, 1 to 99 s (in units of 1 s)			
Manual reset value	0.0% to 100.0% (in units of 0.1%)			
Alarm setting range	-19,999 to 32,400 (decimal point position depends on input type)			
Sampling period	60 ms			
Insulation resistance	20 MΩ min. (at 500 VDC)			
Dielectric strength	2,300 VAC, 50/60 Hz for 1 min between terminals of different charge			
Malfunction vibration	10 to 55 Hz, 20 m/s <sup>2</sup> for 10 min each in X, Y and Z directions			
Vibration resistance	10 to 55 Hz, 20 m/s <sup>2</sup> for 2 hr each in X, Y, and Z directions			
Malfunction shock	100 m/s <sup>2</sup> , 3 times each in X, Y, and Z directions			
Shock resistance	300 m/s <sup>2</sup> , 3 times each in X, Y, and Z directions			
Weight	E5CN-HT	Approx. 150 g	Adapter: approx. 10 g	Terminal cover: approx. 10 g
	E5AN-HT	Approx. 310 g	Adapter: approx. 100 g	Terminal cover: approx. 1.6 g per cover
	E5EN-HT	Approx. 260 g		
Degree of protection	E5CN-HT E5AN-HT E5EN-HT	Front panel: IP66 Rear case: IP20 Terminals: IP00		
Memory protection	Non-volatile memory (Number of write operations: 1,000,000 at an ambient temperature of 25°C)			

- Note** (1) The indication accuracy of K thermocouples in the -200 to 1,300°C range, T and N thermocouples at a temperature of -100°C or less, and U and L thermocouples at any temperature is ±2°C ±1 digit maximum. The indication accuracy of B thermocouples at a temperature of 400°C to 800±3°C or less is not specified. The indication accuracy of R and S thermocouples at a temperature of 200°C or less is ±3°C ±1 digit maximum. The indication accuracy of W thermocouples is (the larger of ±0.3% or ±3°C) ±1 digit maximum and the indication accuracy of PLII thermocouples is (the larger of ±0.3% or ±2°C) ±1 digit maximum.
- (2) Ambient temperature: -10°C to 23°C to 55°C  
Voltage range: -15 to +10% of rated voltage

## Program Control

Number of programs (patterns)	8	
Number of segments (steps)	32	
Segment setting method	Time setting (Segment set with set point and time.)	
	Gradient setting (Segment type with set point, gradient, and time.)	
Segment times	0 h 0 min to 99 h 59 min	
	0 min 0 s to 99 min 59 s	
Alarm setting	Set separately for each program.	
Reset operation	Select either stopping control or fixed SP operation.	
Startup operation	Select continuing, resetting, manual operation, or run mode.	
PID sets	Number of sets	8
	Setting method	Set separately for each program (automatic PID group selection also supported).
Alarm SP function	Select from ramp SP and target SP.	
Program status control	Segment operation	Advance, hold
	Program operation	Program repetitions and program links
Wait operation	Wait method	Waiting at segment ends
	Wait width setting	Same wait width setting for all programs
Time signals	Number of outputs	2
	Number of ON/OFF Operations	1 each per output
	Setting method	Set separately for each program.
Program status output	Program end output (pulse width can be set), run output, stage output	
Program startup operation	PV start	Select from segment 1 set point, slope-priority PV start
	Standby	0 h 0 min to 99 h 59 min
		0 day 0 h to 99 day 23h
Operation end operation	Select from resetting, continuing control at final set point, and fixed SP control.	
Program SP shift	Same program SP shift for all programs	

## Rating and Characteristics of Options

Event inputs	Contact Input ON: 1 k $\Omega$ max., OFF: 100 k $\Omega$ min.
	Non-contact Input ON: Residual voltage 1.5 V max.; OFF: Leakage current 0.1 mA max.
Communications	Transmission path: RS-485/232C/RS-422 Communications method: RS-485 (2-wire, half duplex), RS-232C or RS-422 (4-wire, half duplex) Synchronization: Start-stop Baud rate: 1.2, 2.4, 4.8, 9.6, 19.2, 38.4, or 57.6 kbps
Transfer output	4 to 20 mA DC, Load: 600 $\Omega$ max., Resolution: Approx. 10,000, Accuracy: $\pm 0.3\%$

## Current Transformer (CT)

### Specifications

Item	Specifications	
Model number	E54-CT1	E54-CT3
Max. continuous current	50 A	120 A (See note.)
Dielectric strength	1,000 VAC (for 1 min)	
Vibration resistance	50 Hz, 98 m/s <sup>2</sup>	
Weight	Approx. 11.5 g	Approx. 50 g
Accessories	None	Armature (2), Plug (2)



**Note** The maximum continuous current of the E5□N-HT is 50 A.

**External Dimensions**

**E54-CT1**

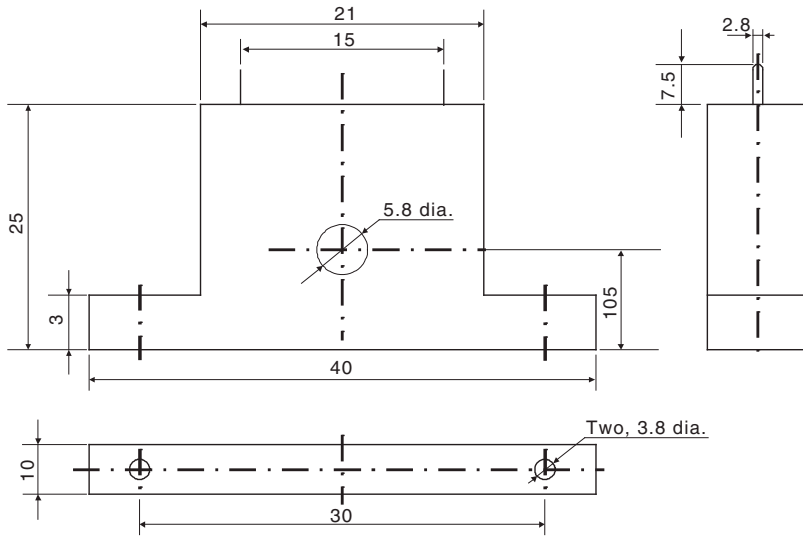

**E54-CT3**

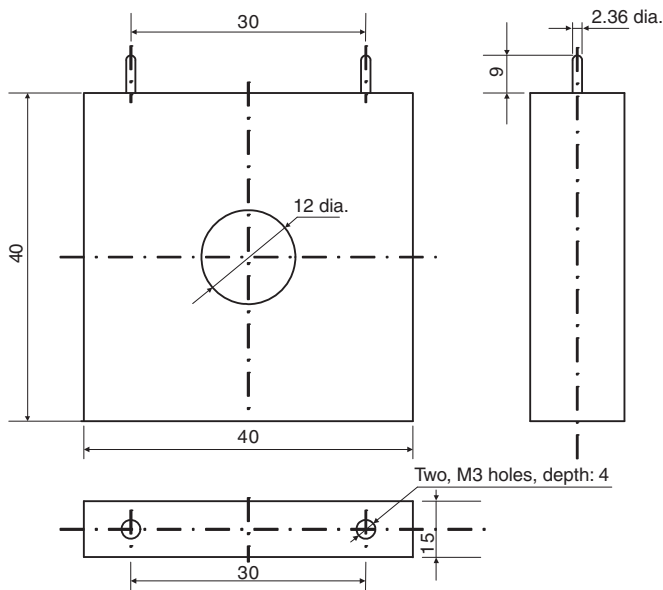

## E58-CIFQ1 USB-Serial Conversion Cable

### Specifications

Item	Specifications
Applicable OS	Windows 2000, XP, Vista, or 7
Applicable software	CX-Thermo version 4.30 or higher
Applicable models	OMRON E5AN/EN/CN-HT Digital Controllers
USB interface rating	Conforms to USB Specification 1.1
DTE speed	38,400 bps
Connector specifications	Computer end: USB (type A plug) Digital Controller end: Serial
Power supply	Bus power (5 VDC supplied from USB host controller)
Current consumption	70 mA
Ambient operating temperature	0 to 55°C (with no condensation or icing)
Ambient operating humidity	10% to 80%
Storage temperature	-20 to 60°C (with no condensation or icing)
Storage humidity	10% to 80%
Altitude	2,000 m max.
Weight	Approx. 100 g

### Compatible Operating Environment

A personal computer that includes the following specifications is required.

- USB port
- CD-ROM drive
- Windows 2000, XP, Vista, or 7

### Appearance and Nomenclature

#### Appearance (Unit: mm)

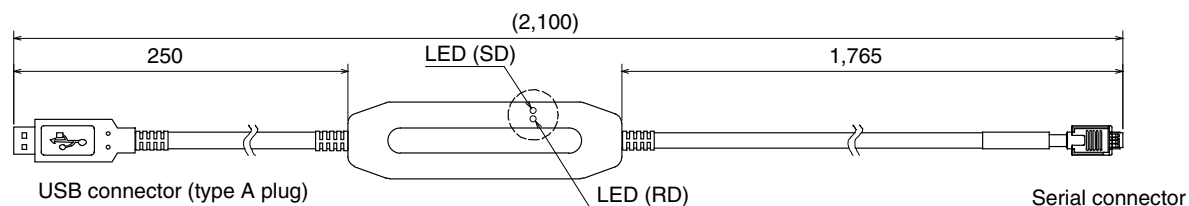

#### LED Indicator Display

Indicator	Color	Status	Meaning
SD	Yellow	Lit	Sending data from USB-Serial Conversion Cable
		Not lit	Not sending data from USB-Serial Conversion Cable
RD	Yellow	Lit	Receiving data from the USB-Serial Conversion Cable
		Not lit	Not receiving data from the USB-Serial Conversion Cable

# E58-CIFIR USB-Infrared Conversion Cable

## Specifications

Item	Specifications
Applicable OS	Windows 2000, XP, Vista, or 7
Applicable software	CX-Thermo version 4.30 or higher
Applicable models	OMRON E5AN/EN-HT Digital Controllers
USB interface rating	Conforms to USB Specification 1.1
DTE speed	38,400 bps
Connector specifications	Computer end: USB (type A plug)
Power supply	Bus power (5 VDC supplied from USB host controller)
Current consumption	80 mA max.
Ambient operating temperature	0 to 55°C (with no condensation or icing)
Ambient operating humidity	10% to 80%
Storage temperature	-20 to 60°C (with no condensation or icing)
Storage humidity	10% to 80%
Altitude	2,000 m max.
Weight	Approx. 130 g (including mounting adapter)
Accessories	Instruction Sheet, Setup Manual, driver CD-ROM, mounting adapter

## Compatible Operating Environment

A personal computer that includes the following specifications is required.

- USB port
- CD-ROM drive
- Windows 2000, XP, Vista, or 7

## Appearance and Nomenclature

### Appearance (Unit: mm)

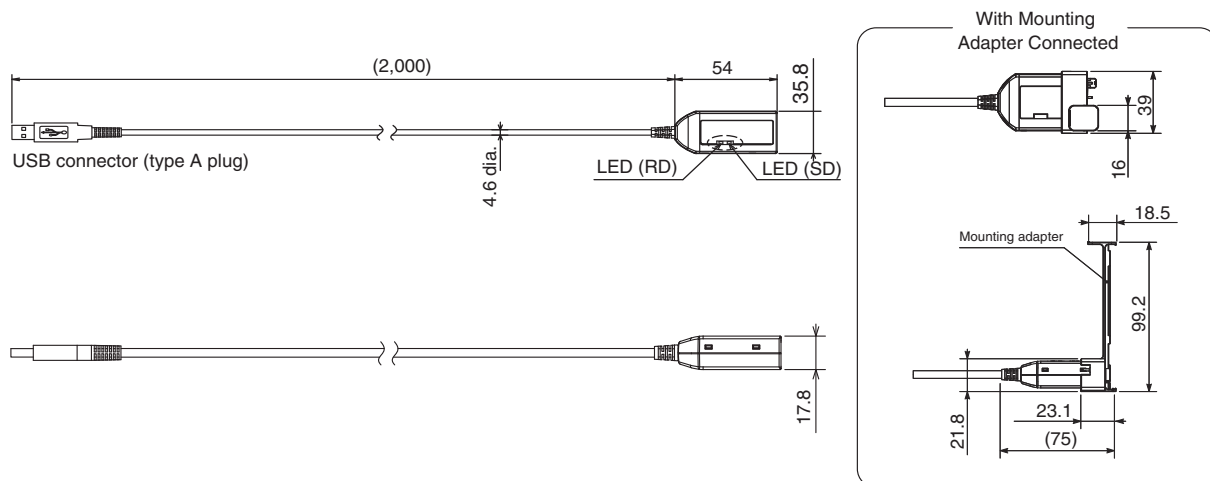

### LED Indicators

Indicator	Color	Status	Meaning
SD	Yellow	Lit	Sending data from personal computer to Digital Controller.
		Not lit	Not sending data from personal computer to Digital Controller.
RD	Yellow	Lit	Personal computer receiving data from Digital Controller.
		Not lit	Personal computer not receiving data from Digital Controller.

## Error Displays

When an error occurs, the error contents are shown on the No. 1 or the No. 2 display.

This section describes how to check error codes on the display, and the actions to be taken to remedy the problems.

### Input Error

#### Meaning

The input value has exceeded the control range. (See note.)

The input type is not set correctly.

The sensor is disconnected or short-circuited.

The sensor is not wired correctly.

The sensor is not connected.

#### Note Control Range

Resistance thermometer, thermocouple input: Temperature setting lower limit  $-20^{\circ}\text{C}$  to temperature setting upper limit  $+20^{\circ}\text{C}$   
(Temperature setting lower limit  $-40^{\circ}\text{F}$  to temperature setting upper limit  $+40^{\circ}\text{F}$ )

Analog input  $-5\%$  to  $+105\%$  of scaling range

#### Action

Check the wiring of inputs for miswiring, disconnections, and short-circuits and check the input type.

If no abnormality is found in the wiring and input type, turn the power OFF then back ON again.

If the display remains the same, the Controller must be replaced. If the display is restored, then the probable cause is electrical noise affecting the control system. Check for electrical noise.

**Note** With resistance thermometer input, a break in the A, B, or B' line is regarded as a disconnection.

#### Operation at Error

After an error occurs, the error is displayed and the alarm outputs function as if the upper limit has been exceeded.

It will also operate as if transfer output exceeded the upper limit.

When the Input Error Output parameter in the advanced function setting level is set to ON, the output assigned to the alarm 1 function turns ON whenever an input error occurs.

An error message is displayed when the PV, PV/SP, or PV/MV is displayed.

**Note** The control output turns OFF. However, when the manual MV, MV at reset, or MV at error is set, the control output corresponds to the set value.

### Display Range Exceeded

#### Meaning

Though this is not an error, it is displayed if the process value exceeds the display range when the control range is larger than the display range.

The display ranges are shown below (with decimal points omitted).

- When less than  $-19,999$     CCCC

- When more than 32,400      3233

**Action**

Control continues and operation is normal. The message is displayed when the PV, PV/SP, PV/MV, or remote SP monitor is displayed.

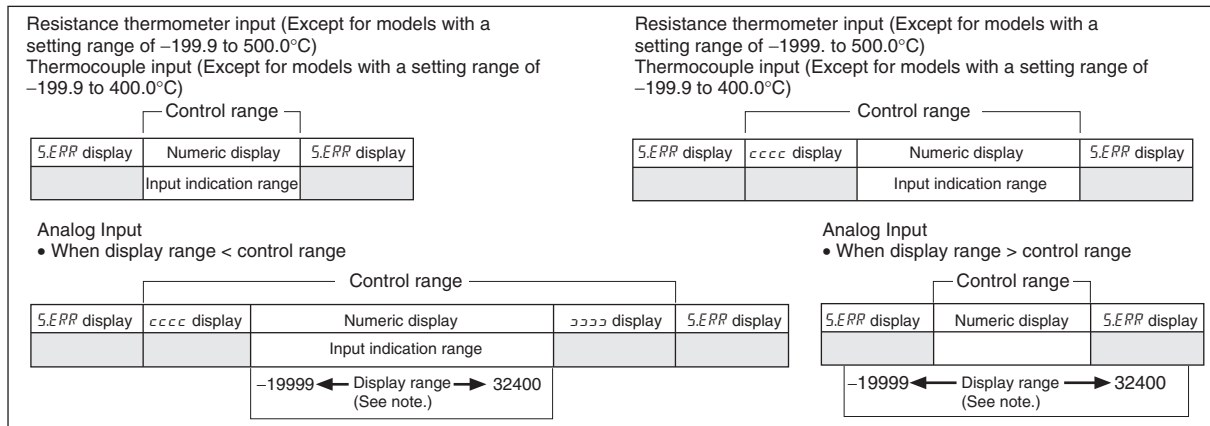

**Note:** The display range is shown in numbers with decimal points omitted.

E333

AD Converter Error

**Meaning**

There is an error in internal circuits.

**Action**

First, turn the power OFF then back ON again. If the display remains the same, the Controller must be repaired. If the display is restored, then the probable cause is electrical noise affecting the control system. Check for electrical noise.

**Operation**

Control output and alarm output turn OFF.

E111

Memory Error

**Meaning**

Internal memory operation is in error.

**Action**

First, turn the power OFF then back ON again. If the display remains the same, the Controller must be repaired. If the display is restored, then the probable cause is electrical noise affecting the control system. Check for electrical noise.

**Operation at Error**

Control output and alarm output turn OFF. (Current output is approx. 0 mA).

FFFF

Current Value Exceeds

**Meaning**

This error is displayed when the heater current value exceeds 55.0 A.

**Action**

Control continues, allowing normal operation. An error message is displayed when the following items are displayed.

- Heater current 1 value monitor
- Heater current 2 value monitor
- Leakage current 1 monitor
- Leakage current 2 monitor

CE1	<p><b>Heater Burnout</b>  <b>HS Alarm</b>  <b>Heater Overcurrent</b></p>
CE2	
LCR1	
LCR2	

**Meaning**

When heater burnout, HS alarm, or heater overcurrent occurs, the No. 1 display in the applicable setting level flashes.

**Action**

When a heater burnout, HS error, or heater overcurrent is detected, the HA indicator lights and the No. 1 display flashes for the applicable Heater Current 1 Value Monitor, Heater Current 2 Value Monitor, Leakage Current 1 Monitor, or Leakage current 1 Monitor parameters in the operation level and adjustment level. Control continues, allowing normal operation.

- - - -	<p><b>Potentiometer Input Error</b></p>
---------	---

**Meaning**

When an input count value error occurs or the converted valve opening is not between -10% and 110%, the valve opening monitor value will be displayed as “- - - -.”

**Action**

Check the wiring of the potentiometer.

**Operation**

The control outputs will turn OFF or will output the MV value set for errors. Operation will be normal if floating control is being used. The valve opening monitor value will be displayed as “- - - -.”

## Troubleshooting

### Checking Problems

If the Digital Controller is not operating normally, check the following points before requesting repairs. If the problem persists, contact your OMRON representative for details on returning the product.

Timing	Status	Meaning	Countermeasures	Page
Turning ON the power for the first time	Temperature error is large. Input error (S.Err display)	Input type mismatch	Check the sensor type and reset the input type correctly.	52
		Thermometer is not installed properly.	Check the thermometer installation location and polarity and install correctly.	30
	Communications are not possible.	Non-recommended adapter is being used.	Make sure that the connected device is not faulty.	Section 1 of <i>Communications Manual</i>
During operation	Overshooting Undershooting Hunting	ON/OFF control is enabled	Select PID control and perform auto-tuning.	65
		Control cycle is longer compared with the speed of rise and fall in temperature	Shorten the control cycle. A shorter control cycle improves control performance, but a cycle of 20 ms minimum is recommended in consideration of the service life of the relays.	55
		Unsuitable PID constant	Set appropriate PID constants using either of the following methods. <ul style="list-style-type: none"> <li>Execute AT (autotuning).</li> <li>Set PID constants individually using manual settings.</li> </ul>	65
		HS alarm operation fault	Use breeder resistance if the problem is due to leakage current. Also investigate the errors detected by the HS alarm function.	76
	Temperature is not rising	Specified operation is unsuitable for required control (default: Reverse operation)	Select either forward or reverse operation depending on the required control. Reverse operation is used for heating operations.	55
		Heater is burnt out or deteriorated.	Check whether heater burnout or deterioration have occurred. Also investigate the errors detected by the heater burnout alarm.	76
		Insufficient heater capacity	Check whether the heater's heating capacity is sufficient.	---
		Cooling system in operation.	Check whether a cooling system is operating.	---
		Peripheral devices have heat prevention device operating.	Set the heating prevention temperature setting to a value higher than the set temperature of the Digital Controller.	---

Timing	Status	Meaning	Countermeasures	Page
During operation (continued)	Output will not turn ON	The Digital Controller is set to reset status. (default: RUN)	Set the Run/Reset parameter to Run. If the RST indicator is lit, control is stopped.	194
		Specified operation is unsuitable for required control (default: Reverse operation)	Select either forward or reverse operation depending on the required control. Reverse operation is used for heating operations.	55
		A high hysteresis is set for ON/OFF operation (default: 1.0°C)	Set a suitable value for the hysteresis.	63
	Digital Controller will not operate	The Digital Controller is set to reset status. (default: RUN)	Set the Run/Reset parameter to Run. If the RST indicator is lit, control is stopped.	194
	Temperature error is large Input error (S.err display)	Thermometer has burnt out or short-circuited.	Check whether the thermometer has burnt out or short-circuited	---
		Thermometer lead wires and power lines are in the same conduit, causing noise from the power lines (generally, display values will be unstable).	Wire the lead wires and power lines in separate conduits, or wiring using a more direct path.	---
		Connection between the Digital Controller and thermocouple is using copper wires.	Connect the thermocouple's lead wires directly, or connect a compensating conductor suitable for the thermocouple.	---
		Installation location of thermometer is unsuitable.	Check whether the location of the thermometer is suitable.	---
		Input shift is not set correctly (default: 0°C)	Set a suitable input shift. If input shift is not required, set the input shift value to 0.0.	95
		Keys will not operate	Setting change protect is ON.	Turn OFF setting change protect.
	Cannot shift levels	Operations limited due to protection.	Set the operation/adjustment protect, initial setting/communications protect, and setting change protect values as required.	113
	SP Does Not Change as Programmed	Remote SP Mode or Fixed SP Mode is set.	Set Program SP Mode.	
	The Segment Does Not Advance	The wait operation is functioning.	Set the wait band correctly.	
		The SP is being held.	Check the HOLD indicator. If it is lit, change the Hold parameter to OFF.	



Timing	Status	Meaning	Countermeasures	Page
After long service life	Control is unstable	Terminal screws may be loose.	Retighten terminal screws to a torque of 0.74 to 0.90 N·m.	33
		The internal components have reached the end of their service life.	The Digital Controller's internal electrolytic capacitor depends on the ambient temperature, and load rate. The structural life depends on the ambient environment (shock, vibration). The life expectancy of the output relays varies greatly with the switching capacity and other switching conditions. Always use the output relays within their rated load and electrical life expectancy. If an output relay is used beyond its life expectancy, its contacts may become welded or burned. Replace the Digital Controller and all other Digital Controllers purchased in the same time period.	---

**Note** For details, refer to *E5CN-HT/E5AN-HT/E5EN-HT Digital Controllers Communications Manual Programmable Type* (Cat. No. H170).

## Symptom: Cannot Communicate or a Communications Error Occurs

Meaning	Countermeasures
The communications wiring is not correct.	Correct the wiring.
The communications line has become disconnected.	Connect the communications line securely and tighten the screws.
The communications cable is broken.	Replace the cable.
The communications cable is too long.	The total cable length is 500 m maximum for RS-485 and 15 m maximum for RS-232C communications. To extend the communications distance for RS-232C communications, use an Optical Interface.
The wrong communications cable has been used.	Use a shielded, twisted-pair AWG24 to AWG14 (cross-sectional area of 0.205 to 2.081 mm <sup>2</sup> ) cable for the communications cable.
More than the specified number of communications devices are connected to the same communications path for RS-485/RS-422 communications.	When 1:N RS-485/RS-422 communications are used, a maximum of 32 nodes (including the host node) can be connected.
An end node has not been set at each end of the communications line for RS-485/RS-422 communications.	Set or connect terminating resistance at each end of the line. RS-485 connections: If the E5CN-HT, E5AN-HT, or E5EN-HT is the end node, use 120-Ω (1/2-W) terminating resistance. The combined terminating resistance with the host device must be at least 54 Ω. RS-422 connections: If the E5AN-HT or E5EN-HT is the end node, use 240-Ω (1/2-W) terminating resistance. The combined terminating resistance with the host device must be at least 100 Ω.
The specified power supply voltage is not being supplied to the Controller.	Supply the specified power supply voltage.
The specified power supply voltage is not being supplied to an Interface Converter (such as the K3SC).	Supply the specified power supply voltage.
The same baud rate and communications method are not being used by all of the Controllers, host devices, and other devices on the same communications line.	Set the same values for the baud rate, protocol, data length, stop bits, and parity on all nodes.
The unit number specified in the command frame is different from the unit number set by the Controller.	Use the same unit number.
The same unit number as the Controller is being used for another node on the same communications line for RS-485 communications.	Set each unit number for only one node.
There is a mistake in programming the host device.	Use a line monitor to check the commands. Check operation using a sample program.
The host device is detecting the absence of a response as an error before it receives the response from the Controller.	Shorten the send data wait time in the Controller or increase the response wait time in the host device.
The host device is detecting the absence of a response as an error after broadcasting a command.	The Controller does not return responses for broadcast commands.
The host device sent another command before receiving a response from the Controller.	The response must always be read after sending a command (except for broadcast commands).
The host device sent the next command too soon after receiving a response from the Controller.	After receiving a response, wait at least 2 ms before sending the next command.

Meaning	Countermeasures
The communications line became unstable when Controller power was turned ON or interrupted, and the host device read the unstable status as data.	Initialize the reception buffer in the host device before sending the first command and after turning OFF the power to the Controller.
The communications data was corrupted from noise from the environment.	<p>Try using a slower baud rate.</p> <p>Separate the communications cable from the source of noise.</p> <p>Use a shielded, twisted-pair cable for the communications cable.</p> <p>Use as short a communications cable as possible, and do not lay or loop extra cable.</p> <p>To prevent inductive noise, do not run the communications cable parallel to a power line.</p> <p>If noise countermeasures are difficult to implement, use an Optical Interface.</p>

**Note** For details on errors, refer to *E5CN-HT/E5AN-HT/E5EN-HT Digital Controllers Communications Manual Programmable Type* (Cat. No. H170).

## Parameter Operation Lists

### Operation Level

Parameters	Characters	Setting (monitor) value	Display	Default	Unit	Set value
Process Value		Temperature: According to indication range for each sensor. Analog: Scaling lower limit -5% FS to Scaling upper limit +5% FS			EU	
Set Point		SP lower limit to SP upper limit		0	EU	
Auto/Manual Switch	<i>R-M</i>					
Program No.	<i>PRG</i>	0 to 7		0	None	
Segment No. Monitor	<i>SEG</i>	0 to Number of segments used -1			None	
Hold	<i>HOLD</i>	OFF, ON	<i>OFF, ON</i>	OFF	None	
Advance	<i>ADV</i>	OFF, ON	<i>OFF, ON</i>	OFF	None	
Remaining Standby Time Monitor	<i>STBM</i>	0.00 to 99.59 (hours, minutes) 0.00 to 99.23 (days, hours)			Standby Time Unit	
Elapsed Program Time Monitor	<i>PRGT</i>	0.00 to 99.59			Program Time Unit	
Program Execution Repetitions Monitor	<i>RPEM</i>	0 to 9999			Repetitions	
Remote SP Monitor	<i>RSP</i>	SP lower limit to upper limit			EU	
Heater Current 1 Value Monitor	<i>CT1</i>	0.0 to 55.0			A	
Heater Current 2 Value Monitor	<i>CT2</i>	0.0 to 55.0			A	
Leakage Current 1 Monitor	<i>LER1</i>	0.0 to 55.0			A	
Leakage Current 2 Monitor	<i>LER2</i>	0.0 to 55.0			A	
Run/Reset	<i>R-R</i>	Run/Reset	<i>RUN, RST</i>	Reset	None	
MV Monitor (Heating)	<i>Δ</i>	-5.0 to 105.5 (standard) 0.0 to 105.0 (heating/cooling)			%	
MV Monitor (Cooling)	<i>[-Δ]</i>	0.0 to 105.0			%	
Valve Opening Monitor	<i>V-M</i>	-10.0 to 110.0			%	

### Program Setting Level

Parameter	Characters	Setting (monitor) values	Display	Default	Unit	Set value
Display Program Selection	<i>d.PRG</i>	0 to 7		0 <sup>*1</sup>	None	
The following parameters (from Number of Segments Used to Time Signal 2 OFF Time) are provided for each program.						
Number of Segments Used	<i>S-NO</i>	1 to 32		8	None	
Display Segment Selection	<i>d.SEG</i>	END, 0 to Number of segments used -1	<i>END</i>	END	None	
Segment 0 Type	<i>STYP</i>	0: Ramp 1: Soak 2: Step	<i>RAMP</i> <i>SOAK</i> <i>STEP</i>	Ramp	None	

\*1: Set to 0 or the currently controlled program number.

Parameter	Characters	Setting (monitor) values	Display	Default	Unit	Set value
Segment 0 Set Point	<i>SP</i>	Set Point Lower Limit to Set Point Upper Limit		0.0	EU	
Segment 0 Rate of Rise	<i>PR</i>	0 to 32,400		0.0	EU/Time Unit of Ramp Rate	
Segment 0 Time	<i>TIME</i>	0.00 to 99.59		0.00	Program Time Unit	
Segment 1 Type to Segment 1 Time						
Segment 2 Type to Segment 2 Time						
to						
Segment 31 Type to Segment 31 Time						
PID Set No.	<i>PId</i>	0 to 8 (0: Auto selection)		1	None	
Alarm Value 1	<i>AL - 1</i>	-19,999 to 32,400		0	EU	
Alarm Upper Limit 1	<i>AL - 1H</i>	-19,999 to 32,400		0	EU	
Alarm Lower Limit 1	<i>AL - 1L</i>	-19,999 to 32,400		0	EU	
Alarm Value 2	<i>AL - 2</i>	-19,999 to 32,400		0	EU	
Alarm Upper Limit 2	<i>AL - 2H</i>	-19,999 to 32,400		0	EU	
Alarm Lower Limit 2	<i>AL - 2L</i>	-19,999 to 32,400		0	EU	
Alarm Value 3	<i>AL - 3</i>	-19,999 to 32,400		0	EU	
Alarm Upper Limit 3	<i>AL - 3H</i>	-19,999 to 32,400		0	EU	
Alarm Lower Limit 3	<i>AL - 3L</i>	-19,999 to 32,400		0	EU	
Program Repetitions	<i>RPL</i>	0 to 9,999		0	Repetitions	
Program Link Destination	<i>LINK</i>	END (-1) or 0 to 7	<i>END</i>	END	None	
Time Signal 1 Set Segment	<i>TS 1S</i>	0 to 31		0	None	
Time Signal 1 ON Time	<i>ON 1</i>	0.00 to 99.59		0.00	Program Time Unit	
Time Signal 1 OFF Time	<i>OF 1</i>	0.00 to 99.59		0.00	Program Time Unit	
Time Signal 2 Set Segment	<i>TS 2S</i>	0 to 31		0	None	
Time Signal 2 ON Time	<i>ON 2</i>	0.00 to 99.59		0.00	Program Time Unit	
Time Signal 2 OFF Time	<i>OF 2</i>	0.00 to 99.59		0.00	Program Time Unit	

### Adjustment Level

Parameters	Characters	Setting (monitor) value	Display	Default	Unit	Set value
Adjustment Level Display	<i>LRdJ</i>					
AT Execute/Cancel	<i>At</i>	OFF: AT Cancel AT-2: 100%AT Execute AT-1: 40%AT Execute (See note 2.)	<i>OFF,</i> <i>At - 2,</i> <i>At - 1</i>	OFF	None	
Communications Writing	<i>CMWL</i>	OFF, ON	<i>OFF, ON</i>	OFF	None	
Infrared Communications Use	<i>IRdR</i>	OFF, ON	<i>OFF, ON</i>	OFF	None	
SP Mode	<i>SPMd</i>	PSP, FSP, RSP	<i>PSP, FSP,</i> <i>RSP</i>	PSP	None	

Parameters	Characters	Setting (monitor) value	Display	Default	Unit	Set value
Fixed SP	<i>FSP</i>	Set Point Lower Limit to Set Point Upper Limit		0.0	EU	
Heater Current 1 Value Monitor	<i>EL1</i>	0.0 to 55.0			A	
Heater Burnout Detection 1	<i>Hb1</i>	0.0 to 50.0		0.0	A	
Heater Overcurrent Detection 1	<i>OL1</i>	0.0 to 50.0		50.0	A	
Heater Current 2 Value Monitor	<i>EL2</i>	0.0 to 55.0			A	
Heater Burnout Detection 2	<i>Hb2</i>	0.0 to 50.0		0.0	A	
Heater Overcurrent Detection 2	<i>OL2</i>	0.0 to 50.0		50.0	A	
Leakage Current 1 Monitor	<i>LER1</i>	0.0 to 55.0			A	
HS Alarm 1	<i>HS1</i>	0.0 to 50.0		50.0	A	
Leakage Current 2 Monitor	<i>LER2</i>	0.0 to 55.0			A	
HS Alarm 2	<i>HS2</i>	0.0 to 50.0		50.0	A	
Heater Burnout Detection 1	<i>Hb1</i>	0.0 to 50.0		0.0	A	
Heater Burnout Detection 2	<i>Hb2</i>	0.0 to 50.0		0.0	A	
Temperature Input Shift	<i>INS</i>	-199.99 to 32400		0.00	°C or °F	
Upper Limit Temperature Input Shift Value	<i>INSH</i>	-199.99 to 32400		0.00	°C or °F	
Lower Limit Temperature Input Shift Value	<i>INSL</i>	-199.99 to 32400		0.00	°C or °F	
Proportional Band (See note 1.)	<i>P</i>	Universal input: 0.1 to 3240.0		8.0	°C or °F (See note 1.)	
		Analog input: 0.1 to 999.9		10.0	%FS	
Integral Time (See note 1.)	<i>I</i>	Standard, heating/cooling, position proportional (closed): 0.0 to 3240.0		233.0	Second	
		Position proportional (floating): 0.1 to 3240.0				
Derivative Time (See note 1.)	<i>d</i>	0.0 to 3240.0		40.0	Second	
		0.0 to 3240.0		40.0	Second	
Cooling Coefficient (See note 1.)	<i>E-SE</i>	0.01 to 99.99		1.00	None	
Dead Band	<i>E-db</i>	Temperature input: -1999.9 to 3240.0		0.0	°C or °F	
		Analog input: -19.99 to 99.99		0.00	%FS	
Manual Reset Value	<i>FR-R</i>	0.0 to 100.0		50.0	%	
Hysteresis (Heating)	<i>HYS</i>	Temperature input: 0.1 to 3240.0		1.0	°C or °F	
		Analog input: 0.01 to 99.99		0.10	%FS	
Hysteresis (Cooling)	<i>EHYS</i>	Temperature input: 0.1 to 3240.0		1.0	°C or °F	
		Analog input: 0.01 to 99.99		0.10	%FS	

Parameters	Characters	Setting (monitor) value	Display	Default	Unit	Set value
Wait Band	<i>WT-b</i>	Temperature input: OFF, 0.1 to 3240.0	<i>OFF, 0.1 to 3240.0</i>	OFF	°C or °F	
		Analog input: OFF, 0.01 to 99.99	<i>OFF, 0.01 to 99.99</i>	OFF	%FS	
MV at Reset	<i>MV-R</i>	Standard: -5.0 to 105.0 Heating/cooling: -105.0 to 105.0		0.0	%	
		Position proportional (Float- ing or Direct Setting of Posi- tion Proportional MV parameter set to OFF): CLOS, HOLD, OPEN	<i>CLS, HOld, oPEN</i>	HOLD	None	
		Position proportional (Close and Direct Setting of Position Proportional MV parameter set to ON): -5.0 to 105.0		0.0	%	
MV at PV Error	<i>MV-E</i>	Position proportional (Float- ing or Direct Setting of Posi- tion Proportional MV parameter set to OFF): CLOS, HOLD, OPEN	<i>CLS, HOld, oPEN</i>	HOLD	None	
		Position proportional (Close and Direct Setting of Position Proportional MV parameter set to ON): -5.0 to 105.0		0.0	%	
		Standard: -5.0 to 105.0 Heating/cooling: -105.0 to 105.0		0.0	%	
MV Upper Limit (See note 1.)	<i>UL-H</i>	Standard: MV lower limit (0.1 to 105.0 Heating/cooling: 0.0 to 105.0		105.0	%	
		Position proportional (closed): MV upper limit (0.1 to 105.0)				
MV Lower Limit (See note 1.)	<i>UL-L</i>	Standard: -5.0 to MV upper limit -0.1		-5.0	%	
		Heating/cooling: -105.0 to 0.0		-105.0		
		Position proportional (closed): -5.0 to MV upper limit -0.1		-5.0		
MV Change Rate Limit	<i>ARL</i>	0.0 to 100.0 (0.0: MV Change Rate Limit Disabled)		0.0	%/s	
Position Propor- tional Dead Band	<i>db</i>	Position proportional (closed): 0.1 to 10.0		4.0	%	
		Position proportional (floating): 0.1 to 10.0		2.0		
Open/Close Hystere- sis	<i>oC-H</i>	0.1 to 20.0		0.8	%	
Extraction of Square Root Low-cut Point	<i>SRP</i>	0.0 to 100.0		0.0	%	
Standby Time	<i>Stb</i>	0.00 to 99.59 (h.min) 0.00 to 99.59 (days.h)		0.00		
Program SP Shift Value	<i>PSPS</i>	-19,999 to 32,400		0.0		
RSP 0 before Cor- rection	<i>RSD</i>	Remote SP Lower Limit to Remote SP Upper Limit		-200.0		

Parameters	Characters	Setting (monitor) value	Display	Default	Unit	Set value
to						
RSP 10 before Correction	<i>R5 10</i>	Remote SP Lower Limit to Remote SP Upper Limit		-200.0		
Broken-line Correction Value 0	<i>b00</i>	-19,999 to 32,400		0		
to						
Broken-line Correction Value 10	<i>b10</i>	-19,999 to 32,400		0		

- Note**
- (1) The parameters in the current PID set will be accessed.
  - (2) Not displayed for heating/cooling control or floating control (for models with position-proportional control).



## PID Setting Level

Parameters	Characters	Setting (monitor) value	Display	Default	Unit	Set value
Display PID Selection	<i>d.PCd</i>	1 to 8		(See note 1.)		
PID 1 Proportional Band	<i>1.P</i>	Temperature input: 0.1 to 3240.0		8.0	°C or °F	
		Analog input: 0.1 to 999.9		10.0	%FS	
PID 1 Integral Time	<i>1.I</i>	Standard/heating/cooling, position proportional (closed): 0.0 to 3240.0		233.0	s	
		Position proportional (floating): 0.1 to 3240.0				
PID 1 Derivative Time	<i>1.d</i>	0.0 to 3240.0		40.0	s	
PID 1 MV Upper Limit	<i>1.oLH</i>	Standard: MV lower limit (0.1 to 105.0)		105.0	%	
		Heating/cooling: 0.0 to 105.0				
		Position proportional (closed): MV lower limit (0.1 to 105.0)				
PID 1 MV Lower Limit	<i>1.oLL</i>	Standard: -5.0 to MV upper limit -0.1		-5.0	%	
		Heating/cooling: -105.0 to 0.0		-105.0		
		Position proportional (closed): -5.0 to MV upper limit -0.1		-5.0		
PID 1 Automatic Selection Range Upper Limit	<i>1.RUt</i>	Temperature input: -19999 to 32400		1320.0	EU	
		Analog input: -5.0 to 105.0		105.0	% (See note 2.)	
PID 1 Cooling Coefficient	<i>1.C5C</i>	0.01 to 99.99		1.0	None	
PID 1 LBA Detection Time	<i>1.LbR</i>	0 to 9999 (0: LBA function disabled)		0	s	
PID 2 Proportional Band	<i>2.P</i>	Temperature input: 0.1 to 3240.0		8.0	°C or °F	
		Analog input: 0.1 to 999.9		10.0	%FS	
to						
PID 2 LBA Detection Time	<i>2.LbR</i>	0 to 9999 (0: LBA function disabled)		0	s	
PID 3 Proportional Band	<i>3.P</i>	Temperature input: 0.1 to 3240.0		8.0	°C or °F	
		Analog input: 0.1 to 999.9		10.0	%FS	
to						
PID 3 LBA Detection Time	<i>3.LbR</i>	0 to 9999 (0: LBA function disabled)		0	s	
PID 4 Proportional Band	<i>4.P</i>	Temperature input: 0.1 to 3240.0		8.0	°C or °F	
		Analog input: 0.1 to 999.9		10.0	%FS	
to						
PID 4 LBA Detection Time	<i>4.LbR</i>	0 to 9999 (0: LBA function disabled)		0	s	
PID 5 Proportional Band	<i>5.P</i>	Temperature input: 0.1 to 3240.0		8.0	°C or °F	
		Analog input: 0.1 to 999.9		10.0	%FS	
to						

Parameters	Characters	Setting (monitor) value	Display	Default	Unit	Set value
PID 5 LBA Detection Time	5.LbP	0 to 9999 (0: LBA function disabled)		0	s	
PID 6 Proportional Band	6.P	Temperature input: 0.1 to 3240.0		8.0	°C or °F	
		Analog input: 0.1 to 999.9		10.0	%FS	
to						
PID 6 LBA Detection Time	6.LbP	0 to 9999 (0: LBA function disabled)		0	s	
PID 7 Proportional Band	7.P	Temperature input: 0.1 to 3240.0		8.0	°C or °F	
		Analog input: 0.1 to 999.9		10.0	%FS	
to						
PID 7 LBA Detection Time	7.LbP	0 to 9999 (0: LBA function disabled)		0	s	
PID 8 Proportional Band	8.P	Temperature input: 0.1 to 3240.0		8.0	°C or °F	
		Analog input: 0.1 to 999.9		10.0	%FS	
to						
PID 8 LBA Detection Time	8.LbP	0 to 9999 (0: LBA function disabled)		0	s	

**Note** (1) The current PID is displayed. If the PID set is changed with the Up or Down Key, monitor functions will be lost.

(2) The unit will be %FS if the PID Set Automatic Selection Data parameter is set to DV.

### Initial Setting Level

Parameters	Characters	Setting (monitor) value	Display	Default	Unit	Set value	
Input Type	IN-E	Temperature input	0: Pt100 1: Pt100 2: Pt100 3: JPt100 4: JPt100 5: K 6: K 7: J 8: J 9: T 10: T 11: E 12: L 13: U 14: U 15: N 16: R 17: S 18: B 19: W 20: PLII 21: K 22: J 23: T 24: Pt100		5	None	
		Analog input	25: 4 to 20 mA 26: 0 to 20 mA 27: 1 to 5 V 28: 0 to 5 V 29: 0 to 10 V		0	None	

Parameters	Characters	Setting (monitor) value	Display	Default	Unit	Set value
Scaling Upper Limit	$\bar{L}N-H$	Scaling lower limit + 1 to 32400		100	None	
Scaling Lower Limit	$\bar{L}N-L$	-19,999 to scaling upper limit -1		0	None	
Decimal Point	$dP$	0 to 3		0	None	
Temperature Unit	$d-U$	°C, °F	$\bar{C}, F$	°C	None	
SP Upper Limit	$SL-H$	Temperature input: SP lower limit + 1 to input range upper limit Analog input: SP lower limit + 1 to Scaling upper limit		1300.0	EU	
SP Lower Limit	$SL-L$	Temperature input: Input range lower limit to SP upper limit -1 Analog: Scaling lower limit to SP upper limit -1		-200.0	EU	
PID ON/OFF	$\bar{C}N\bar{O}F$	ON/OFF 2-PID	$\bar{O}N\bar{O}F, P\bar{L}d$	PID	None	
Standard or Heating/Cooling	$S-H\bar{C}$	Standard or heating/cooling	$S\bar{E}N\bar{d}, H-\bar{C}$	Standard	None	
Control Period (Heating)	$\bar{C}P$	0.5 or 1 to 99	$\bar{O}.5, 1 \text{ to } 99$	20	Second	
Control Period (Cooling)	$\bar{C}-\bar{C}P$	0.5 or 1 to 99	$\bar{O}.5, 1 \text{ to } 99$	20	Second	
Direct/Reverse Operation	$\bar{O}R\bar{E}V$	Reverse operation, direct operation	$\bar{O}R-R, \bar{O}R-d$	Reverse operation	None	
Alarm 1Type	$RL\bar{E}1$	0: Alarm function OFF 1: Upper and lower-limit alarm 2: Upper-limit alarm 3: Lower-limit alarm 4: Upper and lower-limit range alarm 5: Upper and lower-limit alarm with standby sequence 6: Upper-limit alarm with standby sequence 7: Lower-limit alarm with standby sequence 8: Absolute-value upper-limit alarm 9: Absolute-value lower-limit alarm 10: Absolute-value upper-limit alarm with standby sequence 11: Absolute-value lower-limit alarm with standby sequence 12: LBA (Loop Burnout Alarm) 13: PV change rate alarm 14: Remote SP absolute value upper limit alarm (See note 1.) 15: Remote SP absolute value lower limit alarm (See note 1.)		2	None	
Alarm 1 Hysteresis	$RLH1$	Temperature input: 0.1 to 3240.0 Analog input: 0.01 to 99.99		0.2 0.02	°C or °F %FS	

Parameters	Characters	Setting (monitor) value	Display	Default	Unit	Set value
Alarm 2 Type	<i>RLt2</i>	Same settings as the alarm 1 type. <b>Note</b> The 12: LBA (Loop Burnout Alarm) setting cannot be used.		2	None	
Alarm 2 Hysteresis	<i>RLH2</i>	Temperature input: 0.1 to 3240.0		0.2	°C or °F	
		Analog input: 0.01 to 99.99		0.02	%FS	
Alarm 3 Type	<i>RLt3</i>	Same settings as the alarm 2 type		2	None	
Alarm 3 Hysteresis	<i>RLH3</i>	Temperature input: 0.1 to 3240.0		0.2	°C or °F	
		Analog input: 0.01 to 99.99		0.02	%FS	
Transfer Output Type	<i>LR-t</i>	OFF: OFF SP-M: Present SP PV: Process value MV: Manipulated variable (heating) (See note 2.) C-MV: Manipulated variable (cooling) (See note 3.) V-M: Valve Opening (See note 4.)	<i>OFF</i> <i>SP</i> <i>SP-M</i> <i>PV</i> <i>MV</i>  <i>C-MV</i>  <i>V-M</i>	OFF	None	
Transfer Output Upper Limit	<i>LR-H</i>	See note 5.		See note 5.	See note 5.	
Transfer Output Lower Limit	<i>LR-L</i>	See note 5.		See note 5.	See note 5.	
Linear Current Output	<i>ā l-t</i>	4-20: 4 to 20 mA 0-20: 0 to 20 mA	<i>4-20, 0-20</i>	4-20	None	

- Note**
- (1) Displayed when there is a remote SP input.
  - (2) This setting is ignored for position-proportional control models.
  - (3) This setting is ignored for models with standard or position-proportional control.
  - (4) Displayed only when there is a potentiometer input for a model with position-proportional control.
  - (5) Refer to the following table.

Transfer output type	Setting (monitor) range	Default (transfer output upper/lower limits) (See note 5.1.)	Unit
Present SP	SP lower limit to SP upper limit	SP upper limit/lower limit	EU
PV	Temperature input: Input setting range lower limit to input setting range upper limit	Input setting range upper/lower limit	EU
	Analog input: Scaling lower limit to scaling upper limit	Scaling upper/lower limit	EU
MV Monitor (Heating)	Standard: -5.0 to 105.0 Heating/cooling: 0.0 to 105.0	100.0/0.0	%
MV Monitor (Cooling)	0.0 to 105.0	100.0/0.0	%
Valve Opening	-10.0 to 110.0	100.0/0.0	%

- (5.1) Initialized when the transfer output type is changed.  
 Initialized if the input type, temperature unit, scaling upper/lower limit, or SP upper/lower limit is changed when the transfer output type is present SP.

Parameters	Characters	Setting (monitor) value	Display	Default	Unit	Set value
Event Input Assignment 1	<i>EV - 1</i>	None: None RR-1: Run (OFF)/Reset (ON) RR-2: Run (ON)/Reset (OFF) MANU: Auto/Manual RST: Reset RUN: Run HLD1: Hold/Clear Hold HLD2: Hold ADV: Advance PRG0: Program Number Switch 0 PRG1: Program Number Switch 1 PRG2: Program Number Switch 2 DRS: Invert Direct/Reverse Operation SPM1: Program SP Mode/Remote SP Mode SPM2: Remote SP Mode/Fixed SP Mode SPM3: Program SP Mode/Fixed SP Mode AT-2: 100% AT Execute/Cancel AT-1: 40% AT Execute/Cancel (See note 1.) WTPT: Setting Change Enable/Disable CMWT: Communications Write Enable/Disable (See note 2.) LAT: Alarm Latch Cancel WAIT: Wait Enable (ON)/Disable (OFF)	<i>NONE</i> <i>RR - 1</i> <i>RR - 2</i> <i>MANU</i> <i>RSt</i> <i>RUN</i> <i>HLD 1</i> <i>HLD2</i> <i>Adv</i> <i>PRG0</i>  <i>PRG 1</i>  <i>PRG2</i>  <i>dRS</i>  <i>SPM 1</i>  <i>SPM2</i>  <i>SPM3</i>  <i>At - 2</i>  <i>At - 1</i>  <i>WTPT</i>  <i>CMWT</i>  <i>LAt</i> <i>WAIt</i>	RR-1 or NONE (See note 3.)	None	

Parameters	Characters	Setting (monitor) value	Display	Default	Unit	Set value
Event Input Assignment 2	<i>EV-2</i>	None: None RR-1: Run (OFF)/Reset (ON) RR-2: Run (OFF)/Reset (ON) MANU: Auto/Manual RST: Reset RUN: Run HLD1: Hold/Clear Hold HLD2: Hold ADV: Advance PRG0: Program Number Switch 0 PRG1: Program Number Switch 1 PRG2: Program Number Switch 2 DRS: Invert Direct/Reverse Operation SPM1: Program SP Mode/ Remote SP Mode SPM2: Remote SP Mode/ Fixed SP Mode SPM3: Program SP Mode/ Fixed SP Mode AT-2: 100% AT Execute/Cancel AT-1: 40% AT Execute/Cancel (See note 1.) WTPT: Setting Change Enable/Disable CMWT: Communications Write Enable/Disable (See note 2.) LAT: Alarm Latch Cancel WAIT: Wait Enable (ON)/Dis- able (OFF)	<i>NONE</i> <i>RR-1</i> <i>RR-2</i> <i>MANU</i> <i>RSt</i> <i>RUN</i> <i>HLd1</i> <i>HLd2</i> <i>Adv</i> <i>PRG0</i>  <i>PRG1</i>  <i>PRG2</i>  <i>dRS</i>  <i>SPM1</i>  <i>SPM2</i>  <i>SPM3</i>  <i>At-2</i>  <i>At-1</i>  <i>WTPT</i>  <i>CMWT</i>  <i>LAt</i>  <i>WAIt</i>	ADV or NONE (See note 3.)	None	
Event Input Assignment 3	<i>EV-3</i>	Same as for Event Input Assignment 1.	<i>NONE</i>	NONE or RR-1	None	
Event Input Assignment 4	<i>EV-4</i>	Same as for Event Input Assignment 1.	<i>NONE</i>	NONE or ADV	None	
Closed/Floating	<i>ELFL</i>	FLOT: Floating CLOS: Closed	<i>FLot</i> , <i>ELoS</i>	FLOT	None	
Motor Calibration	<i>ELb</i>	OFF, ON	<i>oFF</i> , <i>oN</i>	OFF	None	
Travel Time	<i>MoT</i>	1 to 999		30	s	
Extraction of Square Root Enable	<i>SQR</i>	OFF, ON	<i>oFF</i> , <i>oN</i>	OFF	None	

- Note**
- (1) This setting will be ignored for heating/cooling control or for floating control (for models with position-proportional control).
  - (2) Displayed only for models with communications.
  - (3) If there are terminals for event inputs 1 and 2, the default for the Event Input Assignment 1 parameter is RR-1 and the default for the Event Input Assignment 2 parameter is ADV.  
If there are no terminals for event inputs 1 and 2, but there are terminals for event inputs 3 and 4, the default for the Event Input Assignment 3 parameter is RR-1 and the default for the Event Input Assignment 4 parameter is ADV.

Parameters	Characters	Setting (monitor) value	Display	Default	Unit	Set value
Program Time Unit	<i>E-U</i>	H-M: Hours and minutes M-S: Minutes and seconds	<i>H-M</i> <i>M-S</i>	Hours and minutes	None	
Step Time/Rate of Rise Programming	<i>E-PR</i>	TIME: Step time PR: Rate of Rise Programming	<i>E-TIME</i> <i>PR</i>	TIME	None	
Time Unit of Ramp Rate	<i>PRU</i>	H: Hours M: Minutes	<i>H</i> <i>M</i>	M	None	
Reset Operation	<i>RISM</i>	STOP: Stop control FSP: Fixed SP operation	<i>STOP</i> <i>FSP</i>	STOP	None	
Startup Operation	<i>P-ON</i>	CONT: Continue RST: Reset RUN: Run MANU: Manual operation (See note 1.)	<i>CONT</i> <i>RST</i> <i>RUN</i> <i>MANU</i>	CONT	None	
Operation End Operation	<i>ESET</i>	RST: Reset CONT: Continue FSP: Fixed SP Mode (See note 2.)	<i>RST</i> <i>CONT</i> <i>FSP</i>	RST	None	
PV Start	<i>PVST</i>	SP Start: SP priority PV Start: Slope priority	<i>SP</i> <i>PV</i>	SP	None	
Move to Advanced Function Setting Level	<i>RMov</i>	-1,999 to 9,999		0	None	

- Note** (1) Not displayed for ON/OFF control.  
(2) Not displayed when the Reset Operation parameter is set to fixed SP operation.

### Manual Control Level

Parameters	Characters	Setting (monitor) value	Display	Default	Unit	Set value
Manual MV		-5.0 to 105.0 (standard) (See note 1.) -105.0 to 105.0 (heating/cooling) (See note 1.) -0.5 to 105.0 (position proportional) (See notes 1 and 2.)		0.0	%	

- Note** (1) When the Manual MV Limit Enable parameter is set to ON, the setting range will be the MV lower limit to the MV upper limit.  
(2) The valve opening will be monitored for floating control or close control when the Direct Setting of Position Proportional MV parameter is set to OFF.

### Monitor/Setting Item Level

The contents displayed vary depending on the Monitor/Setting 1 to 5 (advanced function setting level) setting.

### Advanced Function Setting Level

Parameters	Characters	Setting (monitor) value	Display	Default	Unit	Set value
Parameter Initialization	<i>INLT</i>	OFF, FACT	<i>OFF, FACT</i>	OFF	None	
Standby Sequence Reset	<i>RESET</i>	Condition A, condition B	<i>R, b</i>	Condition A	None	
HB ON/OFF	<i>HBV</i>	OFF, ON	<i>OFF, ON</i>	ON	None	
Auxiliary Output 1 Open in Alarm	<i>SbIN</i>	N-O: Close in alarm N-C: Open in alarm	<i>N-a, N-C</i>	N-O	None	
Auxiliary Output 2 Open in Alarm	<i>Sb2N</i>	N-O: Close in alarm N-C: Open in alarm	<i>N-a, N-C</i>	N-O	None	

Parameters	Characters	Setting (monitor) value	Display	Default	Unit	Set value
Auxiliary Output 3 Open in Alarm	$Sb3N$	N-O: Close in alarm N-C: Open in alarm	$N-\bar{a}, N-\bar{c}$	N-O	None	
Heater Burnout Latch	$HbL$	OFF, ON	$\bar{a}FF, \bar{a}N$	OFF	None	
Heater Burnout Hys- teresis	$HbH$	0.1 to 50.0		0.1	A	
$\alpha$	$RLFR$	0.00 to 1.00		0.65	None	
AT Calculated Gain	$RE-G$	0.1 to 10.0		0.8	None	
AT Hysteresis	$RE-H$	Universal input: 0.1 to 3240.0		0.8	°C or °F	
		Analog input: 0.01 to 9.99		0.20	%FS	
Limit Cycle MV Amplitude	$LCMA$	5.0 to 50.0		20.0	%	
Input Digital Filter	$\bar{c}NF$	0.0 to 999.9		0.0	Second	
Additional PV Dis- play	$PVAd$	OFF, ON	$\bar{a}FF, \bar{a}N$	OFF	None	
MV Display	$\bar{a}-dP$	OFF, ON	$\bar{a}FF, \bar{a}N$	OFF	None	
Automatic Display Return Time	$REt$	OFF or 1 to 99	$\bar{a}FF, 1$ to $99$	OFF	Second	
Alarm 1 Latch	$R1Lt$	OFF, ON	$\bar{a}FF, \bar{a}N$	OFF	None	
Alarm 2 Latch	$R2Lt$	OFF, ON	$\bar{a}FF, \bar{a}N$	OFF	None	
Alarm 3 Latch	$R3Lt$	OFF, ON	$\bar{a}FF, \bar{a}N$	OFF	None	
Move to Protect Level Time	$PRLt$	1 to 30		3	Second	
Input Error Output	$SEr\bar{a}$	OFF, ON	$\bar{a}FF, \bar{a}N$	OFF	None	
Cold junction Com- pensation Method	$\bar{c}Jc$	OFF, ON	$\bar{a}FF, \bar{a}N$	ON	None	
PV Change Color	$\bar{c}\bar{a}LR$	Orange, Red, Green	$\bar{a}R\bar{c}, REd,$ $\bar{c}RN$	RED	None	
		Red to Green: When ALM1 is ON, Green to Red: When ALM1 is ON	$R-\bar{c}$			
PV Stable Band	$PV-b$	Red to Green to Red Within PV stable band: Green Outside stable band: Red	$R-\bar{c},R$	5.0	°C or °F (See note 1.)	
		Green to Orange to Red Within PV stable band: Green Outside stable band: Green, Red	$\bar{c}-\bar{a},R$			
Alarm 1 ON Delay	$R1\bar{a}N$	0 to 999 (0: ON delay dis- abled)	$\bar{a}-\bar{c},R$	0	Second	
		0 to 999 (0: ON delay dis- abled)				
Alarm 2 ON Delay	$R2\bar{a}N$	0 to 999 (0: ON delay dis- abled)		0	Second	
Alarm 3 ON Delay	$R3\bar{a}N$	0 to 999 (0: ON delay dis- abled)		0	Second	



Parameters	Characters	Setting (monitor) value	Display	Default	Unit	Set value
Alarm 1 OFF Delay	<i>R1dF</i>	0 to 999 (0: OFF delay disabled)		0	Second	
Alarm 2 OFF Delay	<i>R2dF</i>	0 to 999 (0: OFF delay disabled)		0	Second	
Alarm 3 OFF Delay	<i>R3dF</i>	0 to 999 (0: OFF delay disabled)		0	Second	
Input Shift Type	<i>INS1P</i>	INS1: Temperature input 1-point shift INS2: Temperature input 2-point shift	<i>INS1, INS2</i>	INS1	None	
MV at Reset/MV at Error Addition	<i>MVRE</i>	OFF, ON	<i>OFF, ON</i>	OFF	None	
Auto/Manual Select Addition	<i>RMRd</i>	OFF, ON	<i>OFF, ON</i>	OFF	None	
RT	<i>Rt</i>	OFF, ON	<i>OFF, ON</i>	OFF	None	
HS Alarm Use	<i>HSU</i>	OFF, ON	<i>OFF, ON</i>	ON	None	
HS Alarm Latch	<i>HSL</i>	OFF, ON	<i>OFF, ON</i>	OFF	None	
HS Alarm Hysteresis	<i>HSH</i>	0.1 to 50.0		0.1	A	
LBA Detection Time (See note 2.)	<i>LbR</i>	0 to 9999 (0: LBA function disabled)		0	Second	
LBA Level	<i>LbRL</i>	Temperature input: 0.1 to 3240.0		8.0	°C or °F	
		Analog input: 0.01 to 99.99		10.00	%FS	
LBA Band	<i>LbRb</i>	Temperature input: 0.0 to 3240.0		3.0	°C or °F	
		Analog input: 0.00 to 99.99		0.20	%FS	
Control Output 1 Assignment	<i>OUT 1</i>	When control output 1 is a ON/OFF output (See note 3.): NONE: No assignment O: Control output (heating) C-O: Control output (cooling) ALM1: Alarm 1 ALM2: Alarm 2 ALM3: Alarm 3 P.END: Program end output RALM: Control output ON/OFF count alarm STG: Stage output RUN: Run output TS1: Time signal 1 output TS2: Time signal 2 output WR1: Work bit 1 (See note 4.) WR2: Work bit 2 (See note 4.) WR3: Work bit 3 (See note 4.) WR4: Work bit 4 (See note 4.) WR5: Work bit 5 (See note 4.) WR6: Work bit 6 (See note 4.) WR7: Work bit 7 (See note 4.) WR8: Work bit 8 (See note 4.) When control output 1 is a linear output (See note 3.): NONE: No assignment O: Control output (heating) C-O: Control output (cooling)	<i>NONE</i> <i>o</i> <i>[ - o</i> <i>ALM1</i> <i>ALM2</i> <i>ALM3</i> <i>P.END</i> <i>RALM</i> <i>STG</i> <i>RUN</i> <i>TS1</i> <i>TS2</i> <i>WR1</i> <i>WR2</i> <i>WR3</i> <i>WR4</i> <i>WR5</i> <i>WR6</i> <i>WR7</i> <i>WR8</i> <i>NONE</i> <i>o</i> <i>[ - o</i>	0	None	

Parameters	Characters	Setting (monitor) value	Display	Default	Unit	Set value
Control Output 2 Assignment	$\bar{a}LLE2$	When control output 2 is a ON/OFF output (See note 4.): NONE: No assignment O: Control output (heating) C-O: Control output (cooling) ALM1: Alarm 1 ALM2: Alarm 2 ALM3: Alarm 3 P.END: Program end output RALM: Control output ON/OFF count alarm STG: Stage output RUN: Run output TS1: Time signal 1 output TS2: Time signal 2 output WR1: Work bit 1 (See note 4.) WR2: Work bit 2 (See note 4.) WR3: Work bit 3 (See note 4.) WR4: Work bit 4 (See note 4.) WR5: Work bit 5 (See note 4.) WR6: Work bit 6 (See note 4.) WR7: Work bit 7 (See note 4.) WR8: Work bit 8 (See note 4.) When control output 2 is a linear output (See note 4.) NONE: No assignment O: Control output (heating) C-O: Control output (cooling)	<i>NONE</i> $\bar{a}$ $E-\bar{a}$ <i>ALM1</i> <i>ALM2</i> <i>ALM3</i> <i>P.END</i> <i>RALM</i> <i>STG</i> <i>RUN</i> <i>TS1</i> <i>TS2</i> <i>WR1</i> <i>WR2</i> <i>WR3</i> <i>WR4</i> <i>WR5</i> <i>WR6</i> <i>WR7</i> <i>WR8</i> <i>NONE</i> $\bar{a}$ $E-\bar{a}$	NONE	None	

- Note**
- (1) Displayed for ON/OFF control.
  - (2) The setting range depends on whether control output 1 is a linear output (current output or linear voltage output) or an ON/OFF output (relay output or voltage output (for driving SSR)).
  - (3) The setting range depends on whether control output 2 is a linear output (current output or linear voltage output) or an ON/OFF output (relay output or voltage output (for driving SSR)).
  - (4) WR1 to WR8 are not displayed if logic operations are not used.

Parameters	Characters	Setting (monitor) value	Display	Default	Unit	Set value
Auxiliary Output 1 Assignment	<i>SUb 1</i>	NONE: No assignment O: Control output (heating) C-O: Control output (cooling) ALM1: Alarm 1 ALM2: Alarm 2 ALM3: Alarm 3 P.END: Program end output RALM: Control output ON/OFF count alarm STG: Stage output RUN: Run output TS1: Time signal 1 output TS2: Time signal 2 output WR1: Work bit 1 (See note 1.) WR2: Work bit 2 (See note 1.) WR3: Work bit 3 (See note 1.) WR4: Work bit 4 (See note 1.) WR5: Work bit 5 (See note 1.) WR6: Work bit 6 (See note 1.) WR7: Work bit 7 (See note 1.) WR8: Work bit 8 (See note 1.)	<i>NONE</i> <i>ō</i> <i>[-ō</i>  <i>ALM 1</i> <i>ALM 2</i> <i>ALM 3</i> <i>P.END</i> <i>RALM</i>  <i>STG</i> <i>RUN</i> <i>TS 1</i> <i>TS 2</i> <i>WR 1</i> <i>WR 2</i> <i>WR 3</i> <i>WR 4</i> <i>WR 5</i> <i>WR 6</i> <i>WR 7</i> <i>WR 8</i>	ALM1	None	
Auxiliary Output 2 Assignment	<i>SUb 2</i>	NONE: No assignment O: Control output (heating) C-O: Control output (cooling) ALM1: Alarm 1 ALM2: Alarm 2 ALM3: Alarm 3 P.END: Program end output RALM: Control output ON/OFF count alarm STG: Stage output RUN: Run output TS1: Time signal 1 output TS2: Time signal 2 output WR1: Work bit 1 (See note 1.) WR2: Work bit 2 (See note 1.) WR3: Work bit 3 (See note 1.) WR4: Work bit 4 (See note 1.) WR5: Work bit 5 (See note 1.) WR6: Work bit 6 (See note 1.) WR7: Work bit 7 (See note 1.) WR8: Work bit 8 (See note 1.)	<i>NONE</i> <i>ō</i> <i>[-ō</i>  <i>ALM 1</i> <i>ALM 2</i> <i>ALM 3</i> <i>P.END</i>  <i>RALM</i> <i>STG</i> <i>RUN</i> <i>TS 1</i> <i>TS 2</i> <i>WR 1</i> <i>WR 2</i> <i>WR 3</i> <i>WR 4</i> <i>WR 5</i> <i>WR 6</i> <i>WR 7</i> <i>WR 8</i>	ALM2	None	

Parameters	Characters	Setting (monitor) value	Display	Default	Unit	Set value
Auxiliary Output 3 Assignment	<i>SUB3</i>	NONE: No assignment O: Control output (heating) C-O: Control output (cooling) ALM1: Alarm 1 ALM2: Alarm 2 ALM3: Alarm 3 P.END: Program end output RALM: Control output ON/OFF count alarm WR1: Work bit 1 (See note 1.) WR2: Work bit 2 (See note 1.) WR3: Work bit 3 (See note 1.) WR4: Work bit 4 (See note 1.) WR5: Work bit 5 (See note 1.) WR6: Work bit 6 (See note 1.) WR7: Work bit 7 (See note 1.) WR8: Work bit 8 (See note 1.)	<i>NONE</i> <i>o</i> <i>C-o</i> <i>ALM1</i> <i>ALM2</i> <i>ALM3</i> <i>P.END</i> <i>RALM</i> <i>WR1</i> <i>WR2</i> <i>WR3</i> <i>WR4</i> <i>WR5</i> <i>WR6</i> <i>WR7</i> <i>WR8</i>	ALM3	None	
Character Select	<i>SEL</i>	OFF, ON	<i>OFF, ON</i>	ON	None	
Alarm SP Selection	<i>ALSP</i>	SP-M: Ramp set point SP: Set point	<i>SP-M, SP</i>	SP-M	None	
Remote SP Enable	<i>RSPU</i>	OFF, ON	<i>OFF, ON</i>	OFF	None	
Remote SP Upper Limit	<i>RSPH</i>	SP lower limit to SP upper limit		1300.0	EU	
Remote SP Lower Limit	<i>R SPL</i>	SP lower limit to SP upper limit		-200.0	EU	
SP Tracking	<i>SPTR</i>	OFF, ON	<i>OFF, ON</i>	OFF	None	
Remote SP Input Error Output	<i>RSEo</i>	OFF, ON	<i>OFF, ON</i>	OFF	None	
PID Set Automatic Selection Data	<i>PdL</i>	PV: Process Value DV: Deviation SP: Set point	<i>PV</i> <i>dV</i> <i>SP</i>	PV	None	
PID Set Automatic Selection Hysteresis	<i>PdH</i>	0.10 to 99.99		0.50	%FS	
PV Dead Band	<i>P-db</i>	0.0 to 32400		0.0	EU	
Manual MV Limit Enable	<i>MANL</i>	OFF, ON	<i>OFF, ON</i>	OFF	None	
Direct Setting of Position Proportional MV	<i>PMVd</i>	OFF, ON	<i>OFF, ON</i>	OFF	None	
PV Rate of Change Calculation Period	<i>PV RP</i>	1 to 999		17	Sampling period	
Automatic Cooling Coefficient Adjustment	<i>SECR</i>	OFF, ON	<i>OFF, ON</i>	OFF	None	
Heater Overcurrent Use	<i>oLU</i>	OFF, ON	<i>OFF, ON</i>	ON	None	
Heater Overcurrent Latch	<i>oLL</i>	OFF, ON	<i>OFF, ON</i>	OFF	None	
Heater Overcurrent Hysteresis	<i>oLH</i>	0.1 to 50.0		0.1	A	

Parameters	Characters	Setting (monitor) value	Display	Default	Unit	Set value
PF Setting	<i>PF</i>	OFF: Not assigned RUN: Run RST: Reset R-R: Reverse Run/Reset HOLD: Hold ADV: Advance AT-2: 100% AT Execute AT-1: 40% AT Execute LAT: Alarm Latch Cancel A-M: Auto/manual PFDP: Monitor/setting item	<i>OFF</i> <i>RUN</i> <i>RSt</i> <i>R-R</i> <i>HOLD</i> <i>Adv</i> <i>At-2</i> <i>At-1</i> <i>LAt</i> <i>A-M</i> <i>PFdP</i>	R-R	None	
Monitor/Setting Item 1	<i>PFd1</i>	0: Disabled 1: PV/SP/Program No./Segment No. 2: PV/SP/MV 3: PV/SP/Remaining segment time 4: Proportional band (P) 5: Integral time (I) 6: Derivative time (D) 7: Alarm value 1 8: Alarm value upper limit 1 9: Alarm value lower limit 1 10: Alarm value 2 11: Alarm value upper limit 2 12: Alarm value lower limit 2 13: Alarm value 3 14: Alarm value upper limit 3 15: Alarm value lower limit 3 16: Program No. 17: Segment No. 18: Elapsed program time 19: Remaining program time 20: Elapsed segment time 21: Remaining segment time		1	None	
Monitor/Setting Item 2	<i>PFd2</i>	Same as for Monitor/Setting Item 1.		0	None	
Monitor/Setting Item 3	<i>PFd3</i>	Same as for Monitor/Setting Item 1.		0	None	
Monitor/Setting Item 4	<i>PFd4</i>	Same as for Monitor/Setting Item 1.		0	None	
Monitor/Setting Item 5	<i>PFd5</i>	Same as for Monitor/Setting Item 1.		0	None	

Parameters	Characters	Setting (monitor) value	Display	Default	Unit	Set value
PV/SP Display Screen Selection	<i>SPdP</i>	0: Only PV/SP displayed (no No. 3 display). 1: The PV, SP, Program No., and Segment No., and the PV, SP, and MV are displayed in order. 2: The PV, SP, MV and the PV, SP, Program No., and Segment No. are displayed in order. 3: Only the PV, SP, Program No., and Segment No. are displayed. 4: Only the PV, SP, and MV are displayed. 5: The PV, SP, Program No., and Segment No., and the PV, SP, and Remaining Segment Time are displayed in order. 6: The PV, SP, MV and the PV, SP, and Remaining Segment Time are displayed in order. 7: Only the PV, SP, and Remaining Segment Time are displayed.		3	None	
MV Display Selection	<i>ādSL</i>	O: MV (Heating) C-O: MV (Cooling)	<i>ā</i> <i>Ā - ā</i>	0	None	
PV Decimal Point Display	<i>PVdP</i>	OFF, ON	<i>āFF, āN</i>	ON	None	
PV Status Display Function	<i>PVSt</i>	OFF: OFF MANU: Manual RST: Reset ALM1: Alarm 1 ALM2: Alarm 2 ALM3: Alarm 3 ALM: Alarm 1 to 3 OR status HA: Heater alarm STB: Standby	<i>āFF</i> <i>MANU</i> <i>RSt</i> <i>ALM1</i> <i>ALM2</i> <i>ALM3</i> <i>ALM</i> <i>HA</i> <i>Stb</i>	OFF	None	
SV Status Display Function	<i>SVSt</i>	OFF: OFF MANU: Manual RST: Reset ALM1: Alarm 1 ALM2: Alarm 2 ALM3: Alarm 3 ALM: Alarm 1 to 3 OR status HA: Heater alarm STB: Standby	<i>āFF</i> <i>MANU</i> <i>RSt</i> <i>ALM1</i> <i>ALM2</i> <i>ALM3</i> <i>ALM</i> <i>HA</i> <i>Stb</i>	OFF	None	
Display Refresh Period	<i>dREF</i>	OFF, 0.25, 0.5, 1.0	<i>āFF</i> <i>0.25</i> <i>0.5</i> <i>1.0</i>	0.25	Second	
Control Output 1 ON/OFF Count Monitor	<i>RR1M</i>	0 to 9999			100 times	
Control Output 2 ON/OFF Count Monitor	<i>RR2M</i>	0 to 9999			100 times	
Control Output 1 ON/OFF Count Alarm Set Value	<i>RR1</i>	0 to 9999		0	100 times	

Parameters	Characters	Setting (monitor) value	Display	Default	Unit	Set value
Control Output 2 ON/OFF Count Alarm Set Value	<i>RRZ</i>	0 to 9999		0	100 times	
ON/OFF Counter Reset	<i>RRL</i>	0 to 2		0	None	
Program End ON Time	<i>PENd</i>	ON: Output continuously. 0.0: No output. 0.1 to 10.0	$\bar{a}N$ <i>0.0</i> <i>0.1 to 10.0</i>	0.0	Seconds	
Standby Time Unit	<i>S-U</i>	H-M: hours and minutes D-H: Days and hours	<i>H-M</i> <i>d-H</i>	H-M		
Program SP Shift Value Addition	<i>PSRd</i>	OFF, ON	$\bar{a}FF, \bar{a}N$	OFF		
RSP Broken-line Correction Display Addition	<i>RERd</i>	OFF, ON	$\bar{a}FF, \bar{a}N$	OFF		
Move to Calibration Level	<i>CMdV</i>	-1999 to 9,999		0	None	

**Note** (1) WR1 to WR8 are not displayed if logic operations are not used.

### Protect Level

Parameters	Characters	Setting (monitor) value	Display	Default	Unit	Set value
Move to Protect level	<i>PMdV</i>	-1999 to 9,999		0	None	
Operation/Adjustment Protect	$\bar{a}APt$	0 to 5		0	None	
Initial Setting/Communications Protect	$\bar{a}CPt$	0 to 2		0	None	
Setting Change Protect	<i>WLPt</i>	OFF, ON	$\bar{a}FF, \bar{a}N$	OFF	None	
PF Key Protect	<i>PPPt</i>	OFF, ON	$\bar{a}FF, \bar{a}N$	OFF	None	
Parameter Mask Enable	<i>PMSk</i>	OFF, ON	$\bar{a}FF, \bar{a}N$	ON	None	
Password to Move to Protect Level	<i>PRLP</i>	-1999 to 9,999		0	None	

### Communications Setting Level

Parameters	Characters	Setting (monitor) value	Display	Default	Unit	Set value
Protocol Setting	<i>PSEL</i>	CompoWay/F, Modbus (See note 1.)	<i>CMW, Mod</i>	CompoWay/F	None	
Communications Unit No.	<i>U-Nd</i>	0 to 99		1	None	
Communications Baud Rate	<i>bPS</i>	1.2, 2.4, 4.8, 9.6, 19.2, 38.4, or 57.6	<i>1.2, 2.4, 4.8, 9.6, 19.2, 38.4, 57.6</i>	9.6	kbps	
Communications Data Length	<i>LEN</i>	7, 8		7	Bit	
Communications Stop Bits	<i>Sbt</i>	1, 2		2	Bit	
Communications Parity	<i>PRLY</i>	None, Even, Odd	<i>NONE, EVEN, odd</i>	Even	None	
Send Data Wait Time	<i>SDWT</i>	0 to 99		20	ms	

**Note** (1) If CMW is selected, CompoWay/F will be used as the communications protocol.

## Initialization According to Parameter Changes

The parameters that are initialized when parameters are changed are shown under *Related initialized parameters*.

Changed parameter	Input type	Temperature unit	Scaling Lower Limit Scaling Upper Limit	SP Lower Limit SP Upper Limit	Remote SP Lower Limit Remote SP Upper Limit	PID/ON OFF	Standard or Heating/Cooling
<b>Related initialized parameters</b>							
<b>Related parameter initialization execution condition</b>	---	Temperature input	Analog input	---	---	Standard models	Standard models
SP Upper Limit, SP Lower Limit	● (See note 1.)	● (See note 1.)	● (See note 1.)	---	---	---	---
Segment Set Point	● (See note 3.)	● (See note 3.)	● (See note 3.)	● (See note 3.)	---	---	---
RT	● (See note 4.)	---	---	---	---	---	---
Proportional Band	● (See note 13.)	---	---	---	---	---	---
Integral Time	● (See note 13.)	---	---	---	---	---	---
Derivative Time	● (See note 13.)	---	---	---	---	---	---
MV Upper Limit, MV Lower Limit	---	---	---	---	---	---	● (See note 6.)
MV at Reset	---	---	---	---	---	---	●
MV at PV Error	---	---	---	---	---	---	●
Manual MV	---	---	---	---	---	---	---
Transfer Output Upper Limit, Transfer Output Lower Limit (See note 5.)	● (See note 5.1.)	● (See note 5.1.)	● (See note 5.1.)	● (See note 5.1.)	---	---	● (See note 5.2.)
SP Mode	---	---	---	---	---	---	---
Fixed SP	● (See note 3.)	● (See note 3.)	● (See note 3.)	● (See note 3.)	---	---	---
Standby Time	---	---	---	---	---	---	---
RSP 0 to 10 before Correction	● (See note 16.)	● (See note 16.)	● (See note 16.)	● (See note 16.)	● (See note 16.)	---	---
Broken-line Correction Value 0 to 10	●	●	●	●	●	---	---
Remote SP Upper Limit, Remote SP Lower Limit	● (See note 2.)	● (See note 2.)	● (See note 2.)	● (See note 2.)	---	---	---
Control Output 1 Assignment	---	---	---	---	---	---	●
Control Output 2 Assignment	---	---	---	---	---	---	● (See note 7.)
Auxiliary Output 1 Assignment	---	---	---	---	---	---	● (See note 8.)
Auxiliary Output 2 Assignment	---	---	---	---	---	---	● (See note 7.)
Auxiliary Output 3 Assignment	---	---	---	---	---	---	● (See note 7.)
Move to Protect Level	---	---	---	---	---	---	---
MV Display Selection	---	---	---	---	---	---	●
Position Proportional Dead Band	---	---	---	---	---	---	---
Temperature Input Shift	● (See note 13.)	---	---	---	---	---	---
Upper Limit Temperature Input Shift Value, Lower Limit Temperature Input Shift Value	● (See note 13.)	---	---	---	---	---	---
Dead Band	● (See note 13.)	---	---	---	---	---	---
Hysteresis (Heating)	● (See note 13.)	---	---	---	---	---	---
Hysteresis (Cooling)	● (See note 13.)	---	---	---	---	---	---
Wait Band	● (See note 13.)	---	---	---	---	---	---
Alarm 1 to 3 Hysteresis	● (See note 13.)	---	---	---	---	---	---
AT Hysteresis	● (See notes 13 and 15.)	● (See note 15.)	---	---	---	---	---



Changed parameter	Input type	Temperature unit	Scaling Lower Limit Scaling Upper Limit	SP Lower Limit SP Upper Limit	Remote SP Lower Limit Remote SP Upper Limit	PID/ON OFF	Standard or Heating/Cooling
<b>Related initialized parameters</b>							
<b>Related parameter initialization execution condition</b>	---	Temperature input	Analog input	---	---	Standard models	Standard models
PV Stable Band	● (See note 13.)	---	---	---	---	---	---
LBA Level	● (See note 13.)	---	---	---	---	---	---
LBA Band	● (See note 13.)	---	---	---	---	---	---
Startup Operation	---					● (See note 17.)	
Operation End Operation	---						
PID 1 to 8 Proportional Band	● (See note 13.)	---	---	---	---	---	---
PID 1 to 8 Integral Time	● (See note 13.)	---	---	---	---	---	---
PID 1 to 8 Derivative Time	● (See note 13.)	---	---	---	---	---	---
PID 1 to 8 MV Upper Limit, PID 1 to 8 MV Lower Limit	---	---	---	---	---	---	● (See note 6.)
PID 1 to 8 Automatic Selection Range Upper Limit	● (See note 12.)	● (See note 12.)	---	---	---	---	---

Changed parameter	Remote SP Enabled	Transfer Output Type	Floating/Closed	PID Set Automatic Selection Data	Direct Setting of Position Proportional MV	Reset Operation	Standby Time Unit	Password to Move to Protect Level
<b>Related initialized parameters</b>								
<b>Related parameter initialization execution condition</b>	---	---	Models with position-proportional control and FB input	---	Models with position-proportional control and FB input, close control	---	---	---
SP Upper Limit, SP Lower Limit	---	---	---	---	---	---	---	---
Segment Set Point	---	---	---	---	---	---	---	---
RT	---	---	---	---	---	---	---	---
Proportional Band	---	---	---	---	---	---	---	---
Integral Time	---	---	● (See note 14.)	---	---	---	---	---
Derivative Time	---	---	---	---	---	---	---	---
MV Upper Limit, MV Lower Limit	---	---	---	---	---	---	---	---
MV at Reset	---	---	●	---	●	---	---	---
MV at PV Error	---	---	●	---	●	---	---	---
Manual MV	---	---	●	---	●	---	---	---
Transfer Output Upper Limit, Transfer Output Lower Limit (See note 5.)	---	● (See note 5.3.)	---	---	---	---	---	---
SP Mode	● (See note 11.)	---	---	---	---	● (See note 11.)	---	---
Fixed SP	---	---	---	---	---	---	---	---
Standby Time	---	---	---	---	---	---	● (See note 19.)	---
RSP 0 to 10 before Correction	---	---	---	---	---	---	---	---
Broken-line Correction Value 0 to 10	---	---	---	---	---	---	---	---
Remote SP Upper Limit, Remote SP Lower Limit	---	---	---	---	---	---	---	---
Control Output 1 Assignment	---	---	---	---	---	---	---	---
Control Output 2 Assignment	---	---	---	---	---	---	---	---
Auxiliary Output 1 Assignment	---	---	---	---	---	---	---	---
Auxiliary Output 2 Assignment	---	---	---	---	---	---	---	---
Auxiliary Output 3 Assignment	---	---	---	---	---	---	---	---
Move to Protect Level	---	---	---	---	---	---	---	● (See note 9.)
MV Display Selection	---	---	---	---	---	---	---	---
Position Proportional Dead Band	---	---	● (See note 10.)	---	---	---	---	---
Temperature Input Shift	---	---	---	---	---	---	---	---
Upper Limit Temperature Input Shift Value, Lower Limit Temperature Input Shift Value	---	---	---	---	---	---	---	---
Dead Band	---	---	---	---	---	---	---	---
Hysteresis (Heating)	---	---	---	---	---	---	---	---
Hysteresis (Cooling)	---	---	---	---	---	---	---	---
Wait Band	---	---	---	---	---	---	---	---
Alarm 1 to 3 Hysteresis	---	---	---	---	---	---	---	---
AT Hysteresis	---	---	---	---	---	---	---	---
PV Stable Band	---	---	---	---	---	---	---	---
LBA Level	---	---	---	---	---	---	---	---
LBA Band	---	---	---	---	---	---	---	---
Startup Operation	---	---	---	---	---	---	---	---

Changed parameter	Remote SP Enabled	Transfer Output Type	Floating/Closed	PID Set Automatic Selection Data	Direct Setting of Position Proportional MV	Reset Operation	Standby Time Unit	Password to Move to Protect Level
<b>Related initialized parameters</b>								
<b>Related parameter initialization execution condition</b>	---	---	Models with position-proportional control and FB input	---	Models with position-proportional control and FB input, close control	---	---	---
Operation End Operation	---	---	---	---	---	● (See note 18.)	---	---
PID 1 to 8 Proportional Band	---	---	---	---	---	---	---	---
PID 1 to 8 Integral Time	---	---	● (See note 14.)	---	---	---	---	---
PID 1 to 8 Derivative Time	---	---	---	---	---	---	---	---
PID 1 to 8 MV Upper Limit, PID 1 to 8 MV Lower Limit	---	---	---	---	---	---	---	---
PID 1 to 8 Automatic Selection Range Upper Limit	---	---	---	● (See note 12.)	---	---	---	---

- Note**
- (1) Initialized to input setting range upper and lower limits, or scaling upper and lower limits.
  - (2) Initialized to SP upper and lower limits.
  - (3) Clamped by SP upper and lower limits.
  - (4) Initialized only when the input type is changed to analog input when RT turns ON. The defaults are as follows: RT: OFF
  - (5) Initialization is performed as shown below according to the transfer output type setting. The initialization differs depending on the changed parameter and the output type setting.  
 Present SP: SP Upper Limit  
 PV: Input setting range upper and lower limits or scaling upper and lower limits  
 MV (Heating): 100.0/0.0  
 MV (Cooling): 100.0/0.0  
 Valve Opening: 100.0/0.0
    - (5.1) Initialized only when the transfer output type is set to present SP or PV.
    - (5.2) Initialized only when the transfer output type is set to MV (Heating) or MV (Cooling).
    - (5.3) Initialized to the above default values regardless of the settings for changing the transfer output type.
  - (6) Initialized as follows according to the Standard or Heating/Cooling parameter setting.  
 MV Upper Limit: 105.0  
 MV Lower Limit: Standard -5.0, heating/cooling -105.0
  - (7) For standard models, initialized to control output (cooling) for heating/cooling control, according to the following. (The defaults given in the parameter table are used for standard control with a standard model or with a position-proportional model.)  
 With control output 2: The Control Output 2 Assignment parameter is initialized to control output (cooling).  
 For the E5AN-HT or E5EN-HT with no control output 2, the Auxiliary Output 3 Assignment is initialized to Control Output (Cooling).  
 Without control output 2 and E5CN-HT: The Auxiliary Output 2 Assignment parameter is initialized to Control Output (Cooling).
  - (8) The Auxiliary Output 1 Assignment parameter is initialized to alarm 1.
  - (9) If the password is changed, it will be initialized to the new password.
  - (10) Initialized to 4.0 for close control and to 2.0 for floating control.
  - (11) If the Reset Operation parameter is set to fixed SP operation and the remote SP is disabled, the SP mode is initialized to FSP. If the Reset Operation parameter is set to stop control and the remote SP

is disabled, the SP mode is initialized to RSP. If the Reset Operation parameter is changed from stopping control to fixed SP operation and the SP mode is PSP, it will be initialized to FSP.

(12) The default values are as follows:

Temperature Input

Depends on the setting of the PID Set Automatic Selection Data parameter and the upper and lower limits for the input setting range (which depends on the temperature unit).

- PID Set Automatic Selection Data = PV: Upper limit + 20°C (40°F)
- PID Set Automatic Selection Data = DV: Upper limit – Lower Limit + 20°C (40°F)
- PID Set Automatic Selection Data = SP: Upper limit

Analog Input

The default is 105.0 (regardless of the setting of the PID Set Automatic Selection Data parameter.

- (13) Initialized when the input type is changed from a temperature input to an analog input or from an analog input to a temperature input.
- (14) Initialized to 233 if the integral time is 0 and the Close/Floating parameter is set for floating control.
- (15) Initialized to 0.8 when the temperature unit is °C, and to 1.4 when the temperature unit is °F.
- (16) Initialized to the remote SP lower limit.
- (17) Initialized only when the PID ON/OFF parameter is set to ON/OFF control.
- (18) The Operation End Operation parameter is initialized when the Reset Operation parameter is set to fixed SP operation.
- (19) Initialized only when the standby time unit is set to days and hours.

## Sensor Input Setting Range, Indication Range, Control Range

Input type	Specific ations	Set value	Input setting range	Input indication range
Resistance thermometer	Pt100	0	-200.0 to 850.0 (°C)/-300.0 to 1,500.0 (°F)	-220.0 to 870.0 (°C)/-340.0 to 1,540.0 (°F)
		1	-199.9 to 500.0 (°C)/-199.9 to 900.0 (°F)	-199.9 to 520.0 (°C)/-199.9 to 940.0 (°F)
		2	0.0 to 100.0 (°C)/0.0 to 210.0 (°F)	-20.0 to 120.0 (°C)/-40.0 to 250.0 (°F)
	JPt100	3	-199.9 to 500.0 (°C)/-199.9 to 900.0 (°F)	-199.9 to 520.0 (°C)/-199.9 to 940.0 (°F)
		4	0.0 to 100.0 (°C)/0.0 to 210.0 (°F)	-20.0 to 120.0 (°C)/-40.0 to 250.0 (°F)
Thermocouple	K	5	-200.0 to 1,300.0 (°C)/-300.0 to 2,300.0 (°F)	-220.0 to 1,320.0 (°C)/-340.0 to 2,340.0 (°F)
		6	-20.0 to 500.0 (°C)/0.0 to 900.0 (°F)	-40.0 to 520.0 (°C)/-40.0 to 940.0 (°F)
	J	7	-100.0 to 850.0 (°C)/-100.0 to 1,500.0 (°F)	-120.0 to 870.0 (°C)/-140.0 to 1,540.0 (°F)
		8	-20.0 to 400.0 (°C)/0.0 to 750.0 (°F)	-40.0 to 420.0 (°C)/-40.0 to 790.0 (°F)
	T	9	-200.0 to 400.0 (°C)/-300.0 to 700.0 (°F)	-220.0 to 420.0 (°C)/-340.0 to 740.0 (°F)
		10	-199.9 to 400.0 (°C)/-199.9 to 700.0 (°F)	-199.9 to 420.0 (°C)/-199.9 to 740.0 (°F)
	E	11	-200.0 to 600.0 (°C)/-300.0 to 1,100.0 (°F)	-20.0 to 620.0 (°C)/-40.0 to 1,140.0 (°F)
	L	12	-100.0 to 850.0 (°C)/-100.0 to 1,500.0 (°F)	-120.0 to 870.0 (°C)/-140.0 to 1,540.0 (°F)
	U	13	-200.0 to 850.0 (°C)/-300.0 to 700.0 (°F)	-220.0 to 420.0 (°C)/-340.0 to 740.0 (°F)
		14	-199.9 to 400.0 (°C)/-199.9 to 700.0 (°F)	-199.9 to 420.0 (°C)/-199.9 to 740.0 (°F)
	N	15	-200.0 to 1,300.0 (°C)/-300.0 to 2,300.0 (°F)	-220.0 to 1,320.0 (°C)/-340.0 to 2,340.0 (°F)
	R	16	0.0 to 1,700.0 (°C)/0.0 to 3,000.0 (°F)	-20.0 to 1,720.0 (°C)/-40.0 to 3,040.0 (°F)
	S	17	0.0 to 1,700.0 (°C)/0.0 to 3,000.0 (°F)	-20.0 to 1,720.0 (°C)/-40.0 to 3,040.0 (°F)
	B	18	100.0 to 1,800.0 (°C)/300.0 to 3,200.0 (°F)	0.0 to 1,820.0 (°C)/0.0 to 3,240.0 (°F)
	W	19	0.0 to 2,300.0 (°C)/0.0 to 3,200.0 (°F)	-20.0 to 2,320.0 (°C)/-40.0 to 270.0 (°F)
	PLII	20	0.0 to 1,300.0 (°C)/0.0 to 2,300.0 (°F)	-20.0 to 1,320.0 (°C)/-40.0 to 2,340.0 (°F)
	K	21	-50.0 to 200.0 (°C)/-50.0 to 200.0 (°F)	-90.0 to 220.0 (°C)/-90.0 to 240.0 (°F)
J	22	-50.0 to 200.0 (°C)/-50.0 to 200.0 (°F)	-90.0 to 220.0 (°C)/-90.0 to 240.0 (°F)	
T	23	-50.0 to 200.0 (°C)/-50.0 to 200.0 (°F)	-90.0 to 220.0 (°C)/-90.0 to 240.0 (°F)	
Resistance thermometer	Pt100	24	-50.0 to 200.0 (°C)/-50.0 to 200.0 (°F)	-90.0 to 220.0 (°C)/-90.0 to 240.0 (°F)
Current input	4 to 20 mA	25	Any of the following ranges, by scaling: -19,999 to 32,400 -1,999.9 to 3,240.0 -199.99 to 324.00 -19.999 to 32.400	-5% to 105% of setting range. The display shows -19,999 to 32,400 (numeric range with decimal point omitted).
	0 to 20 mA	26		
Voltage input	1 to 5 V	27		
	0 to 5 V	28		
	0 to 10 V	29		

- The default is 5.
- The applicable standards for each of the above input ranges are as follows:
  - K, J, T, E, N, R, S, B: JIS C1602-1995, IEC 60584-1
  - L: Fe-CuNi, DIN 43710-1985
  - U: Cu-CuNi, DIN 43710-1985
  - W: W5Re/W26Re, ASTM E988-1990
  - JPt100: JIS C 1604-1989, JIS C 1606-1989
  - Pt100: JIS C 1604-1997, IEC 60751
  - PLII: According to Platinel II Electromotive Force Table by Engelhard Corp.

**Control Range**

- Resistance thermometer and thermocouple input  
Temperature lower limit  $-20^{\circ}\text{C}$  to temperature upper limit  $+20^{\circ}\text{C}$ , or temperature lower limit  $-40^{\circ}\text{C}$  to temperature upper limit  $+40^{\circ}\text{C}$
- Analog input  
 $-5\%$  to  $+105\%$  of scaling range

## Setting Levels Diagram

This diagram shows all of the setting levels. To move to the advanced function setting level and calibration level, you must enter passwords. Some parameters are not displayed depending on the protect level setting and the conditions of use.

Control stops when you move from the operation level to the initial setting level.

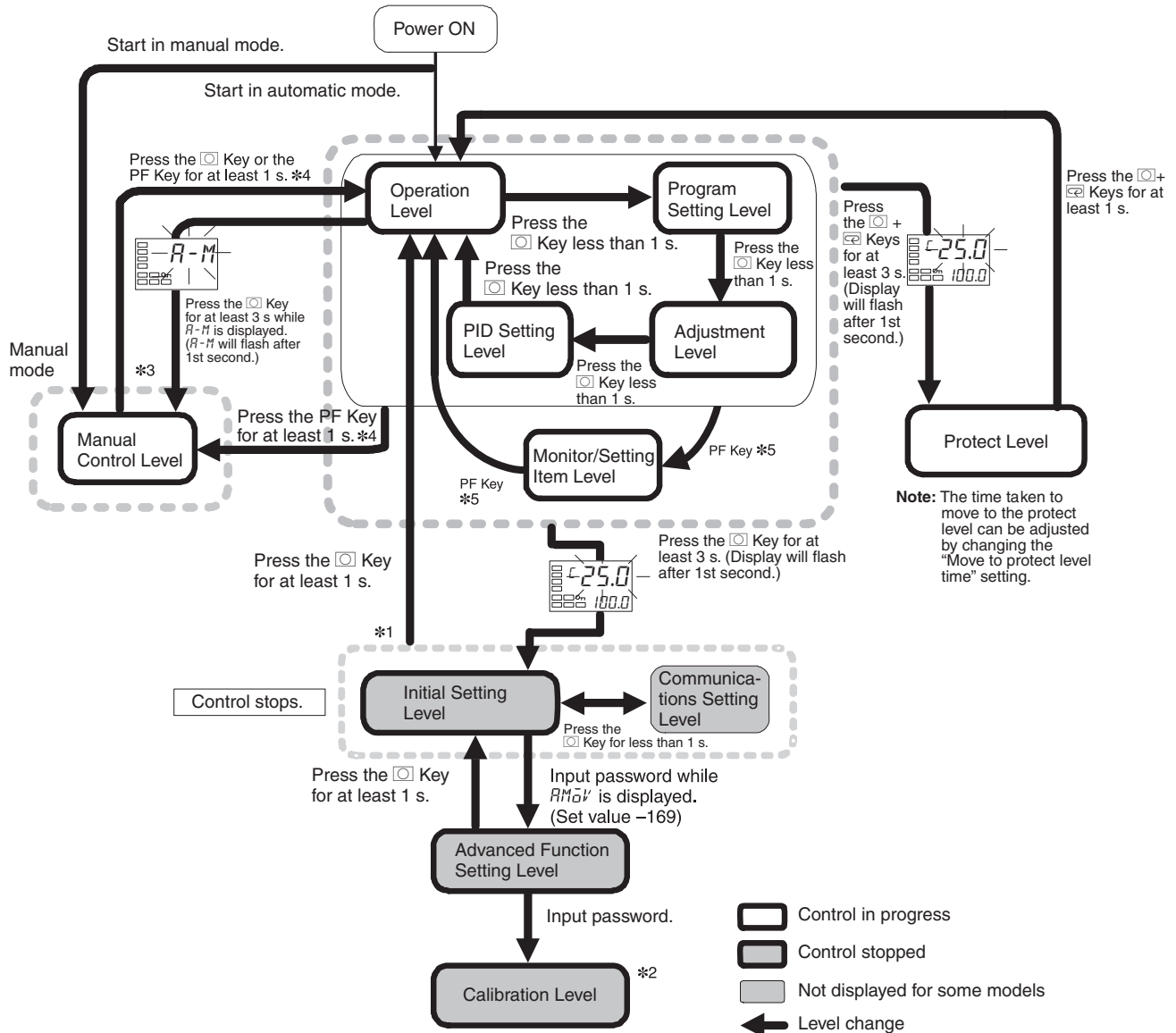

- Note**
- (1) You can return to the operation level by executing a software reset.
  - (2) It is not possible to move to other levels from the calibration level by operating the keys on the front panel. It can be done only by first turning OFF the power.
  - (3) From the manual control level, key operations can be used to move to the operation level only.
  - (4) When the PF Setting parameter is set to A-M. For the E5CN-HT, press the + Keys at the same time to implement the PF Key.
  - (5) When the PF Setting parameter is set to PFDP. For the E5CN-HT, press the + Keys at the same time to implement the PF Key.

# Parameter Flow

This section describes the parameters set in each level. Pressing the  Key at the last parameter in each level returns to the top parameter in that level.

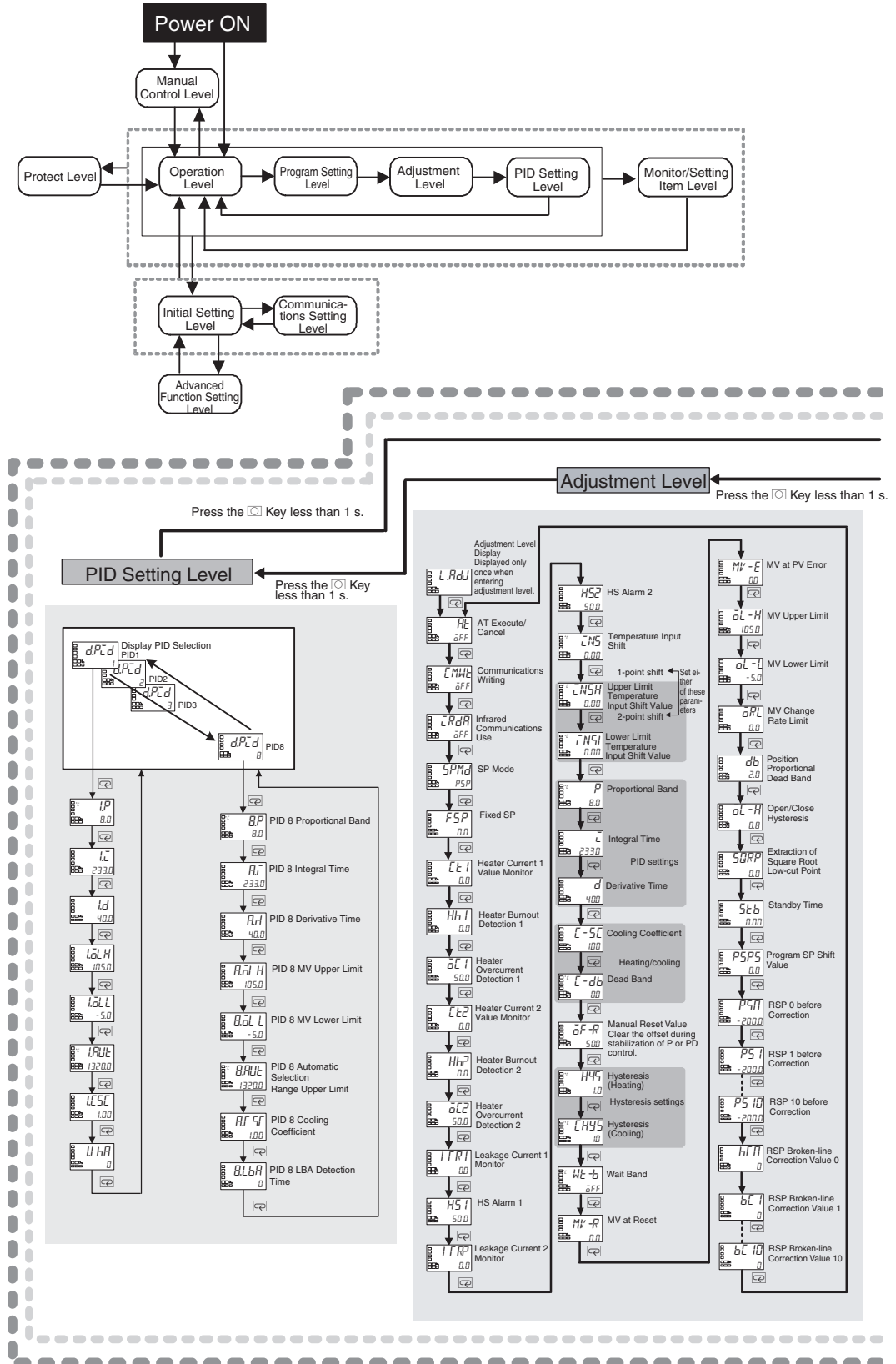



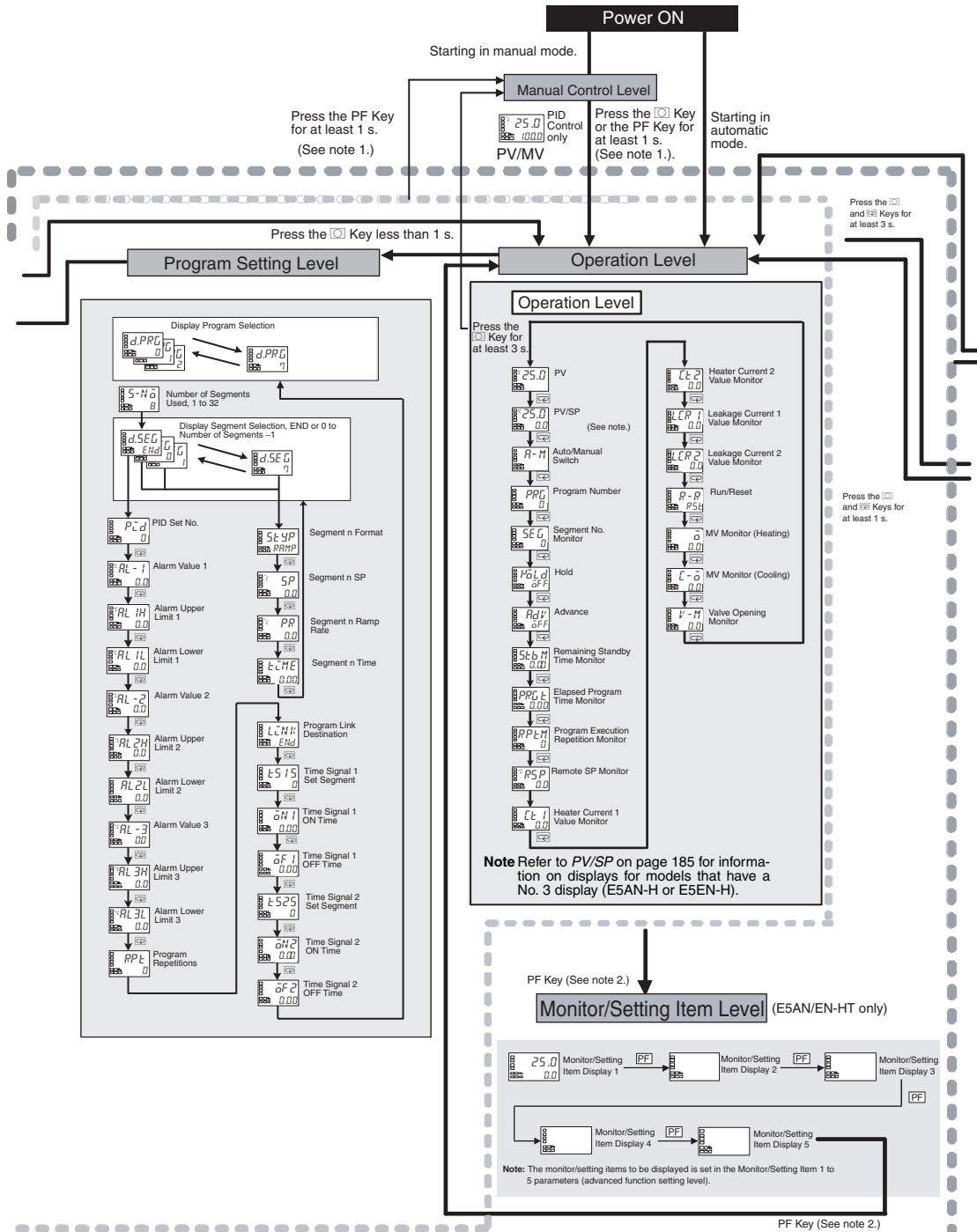

**Note:**

1. When the PF Setting parameter is set to A-M for a Controller with a PF Key (E5AN/EN-HT).
2. When the PF Setting parameter is set to PFDP for a Controller with a PF Key (E5AN/EN-HT).

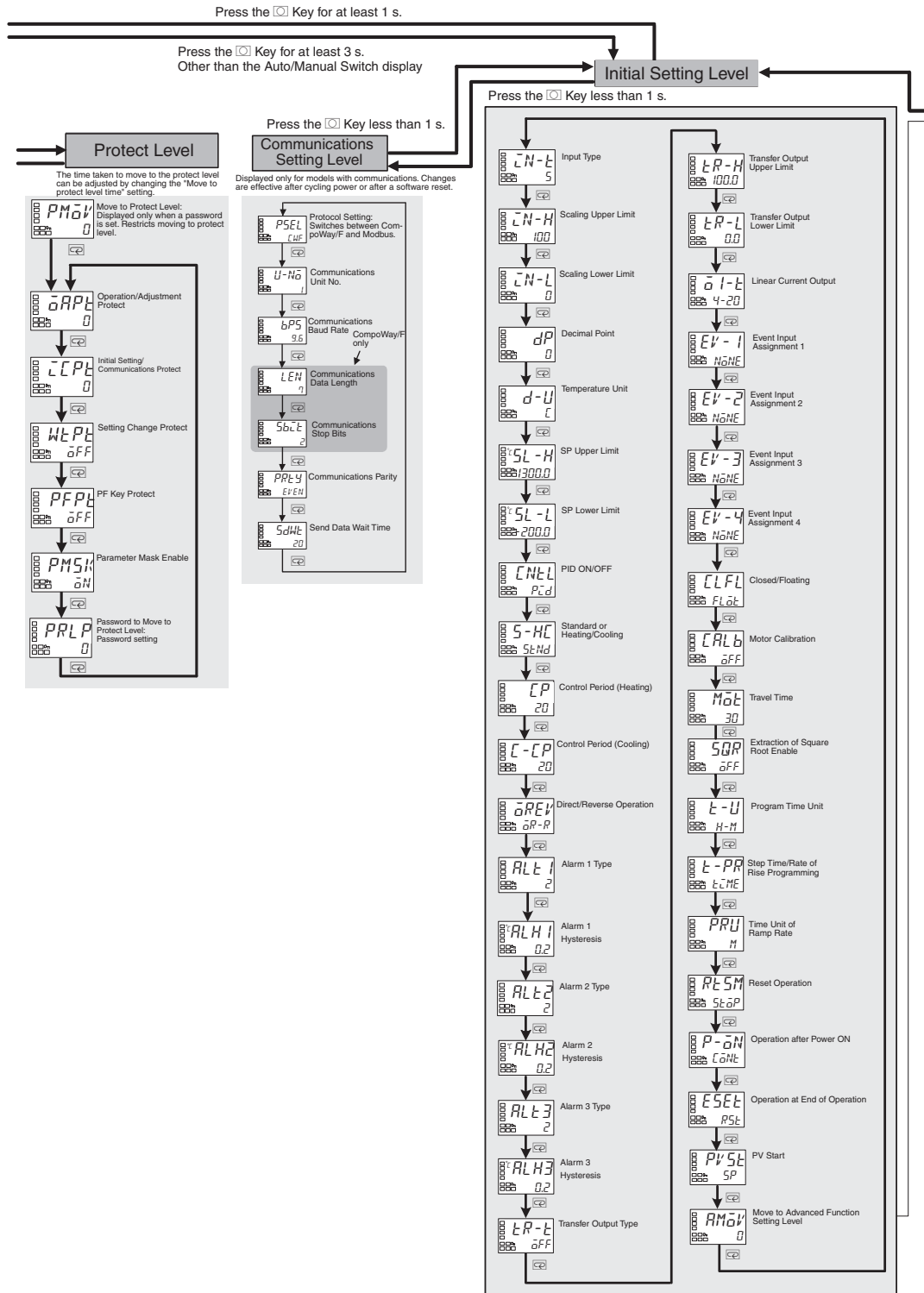

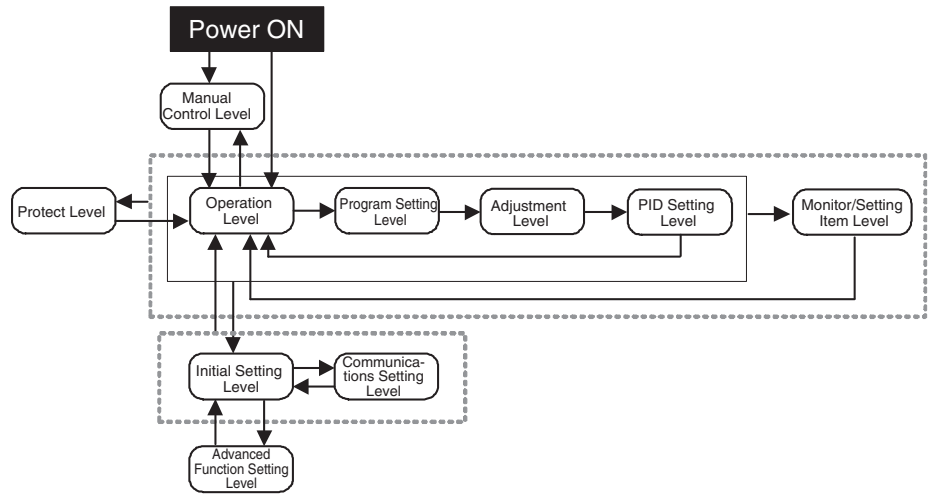

Press the Key for at least 1 s.

**Advanced Function Setting Level**

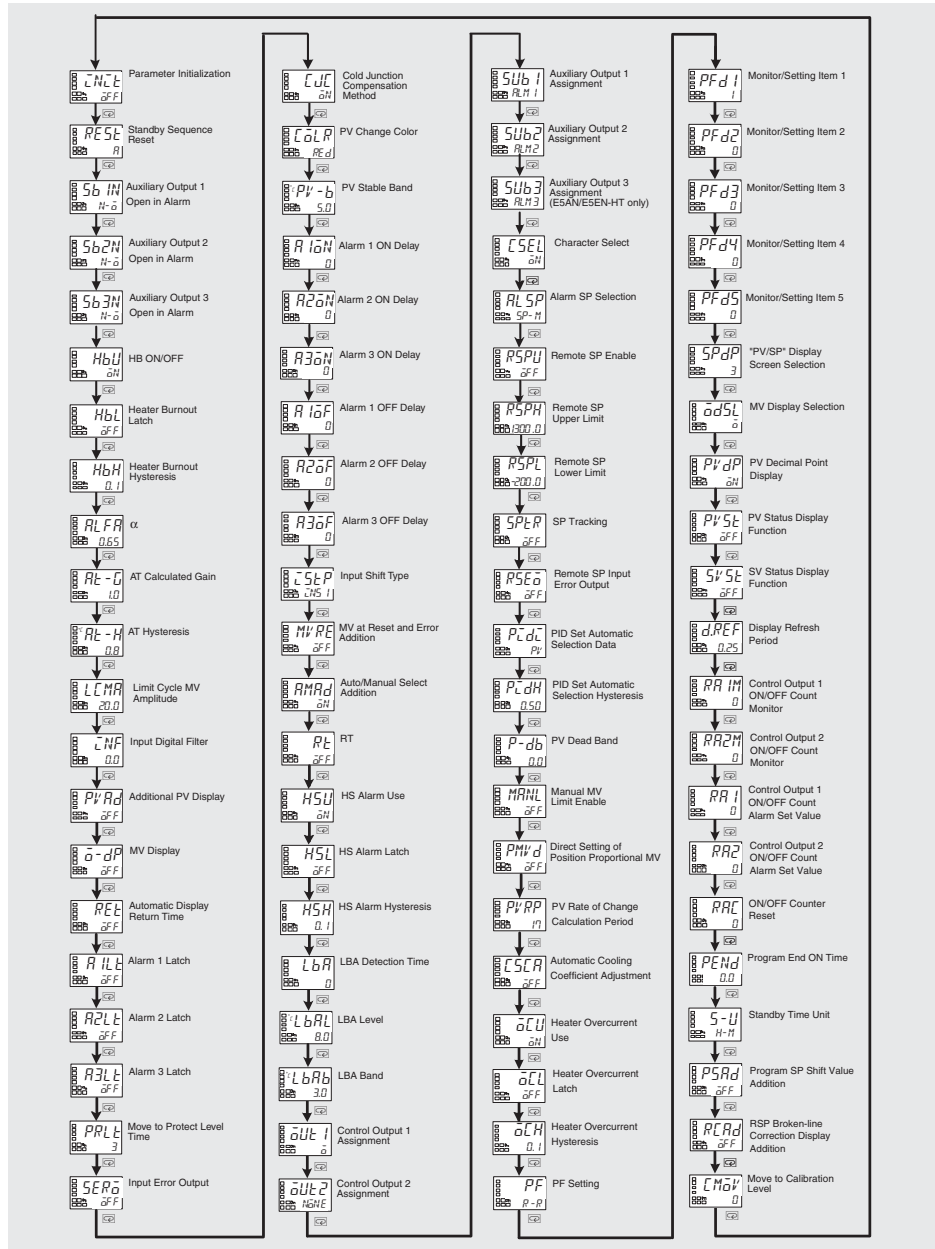



# Index

## Numerics

2-PID control, 54, 238

## A

adjustment level, 13, 206  
    parameter operation list, 327  
advanced function setting level, 14, 256  
    moving to, 111  
    parameter operation list, 337  
alarm delays, 120  
alarms, 10  
    alarm delays, 120  
    alarm hysteresis, 98  
    alarm latch, 99  
    alarm outputs, 71  
    alarm types, 72  
    alarm values, 74  
    operation, 100  
analog input, 100, 309  
    calibration, 304  
AT (auto-tuning), 65  
auto control, 106  
auto/manual select addition, 129, 269  
auto/manual switch, 186  
auxiliary output 1 assignment, 275  
auxiliary output 2 assignment, 276  
auxiliary output 3 assignment, 277  
auxiliary outputs 2 and 3, 36  
    wiring, 37

## B

basic model  
    E5AN-H, 8  
    E5CN-H, 6  
    E5EN-H, 8

## C

calibration  
    analog input, 304  
    current input, 304  
    indication accuracy, 308  
    input types, 299  
    platinum resistance thermometer, 303  
    registering calibration data, 299

    thermocouple, 299  
    user calibration, 299  
    voltage input, 305

characteristics, 312

cold junction compensator  
    connecting, 300

communications  
    operation commands, 115  
    wiring  
        RS-485, 39

communications function, 10

communications setting level, 14, 296  
    parameter operation list, 345

control outputs, 10  
    control outputs 1 and 2  
        wiring, 34, 35

control periods, 55, 239

Controllers with Analog Input, 304

Controllers with Analog Inputs, 298, 305

cooling coefficient  
    setting, 103

current input  
    calibration, 304

current transformer  
    calculating detection current, 78

Current Transformers (CT), 77, 314

    CT inputs  
        wiring, 38  
    external dimensions, 315  
        E54-CT1, 315  
        E54-CT3, 315  
    specifications, 314

Current Value Exceeds (error display), 320

## D

dead band, 102  
    setting, 104

detection current, 78

dimensions, 20  
    E5AN-H, 20  
    E5CN-H, 20  
    E5EN-H, 20

direct operation, 55, 240

Display Range Exceeded (error display), 318

down key, 5

## **E**

error displays, 318  
    Current Value Exceeds, 320  
    Display Range Exceeded, 318  
    Heater Burnout, 320  
    Heater Overcurrent, 320  
    HS Alarm, 320  
    Input Error, 318  
    Memory Error, 319

event inputs, 10, 37, 105  
    wiring, 37

external dimensions  
    Current Transformer (CT), 315

## **F**

fixed SP mode, 209

front panel  
    E5AN-H, 2  
    E5CN-H, 2  
    E5EN-H, 3

## **H**

HB alarm (heater burnout alarm), 76  
    settings, 83

Heater Burnout (error display), 320

heater burnout alarm, 10, 312

heater burnout hysteresis, 260

heater burnout latch, 260

heater overcurrent  
    hysteresis, 284  
    latch, 284

heating/cooling control, 101, 217, 239  
    cooling coefficient, 102, 217  
    dead band, 102, 218  
    setting, 103

HS alarm, 10, 76, 312  
    settings, 85

HS Alarm (error display), 320

hysteresis, 63, 65

## **I**

I/O configuration, 6  
    basic model  
        E5AN-H, 8

    E5CN-H, 6  
    E5EN-H, 8  
    main functions, 9

indication accuracy, 308

indicators  
    explanation, 3  
    operation, 3

initial setting level, 14, 234  
    parameter operation list, 332

initial setting/communications protect, 114

initial settings, 48  
    examples, 49, 50, 51

initialization, 258

Input Error (error display), 318

input sensor types, 9, 236

input shift, 95  
    one-point shift, 95  
    two-point shift, 96

input types, 52  
    list, 52  
    setting, 52

inputs  
    wiring, 33

installation, 20, 23  
    E5AN/E5EN-H  
        mounting the terminal cover, 24, 25  
        mounting to the panel, 25  
    E5CN-H  
        mounting the terminal cover, 24  
        mounting to the panel, 23  
    panel cutout  
        E5AN-H, 21  
        E5CN-H, 21  
        E5EN-H, 22  
    removing from case  
        E5AN-H, 27  
        E5CN-H, 26  
        E5EN-H, 27

## **K**

keys  
    down key, 5  
    key operations, 12  
    level key, 5  
    mode key, 5  
    operations, 5  
    up key, 5

**L**

LBA (loop burnout alarm), 122  
  band, 123  
  detection time, 124  
  level, 123, 124  
level key, 5  
logic operations, 167  
loop burnout alarm (LBA), 122

**M**

main functions, 9  
manual control, 106, 126  
manual control level, 14  
  moving to, 128  
  parameter operation list, 337  
manual setup, 70  
Memory Error (error display), 319  
mode key, 5  
monitor/setting item level, 230  
mounting, 23  
  terminal cover  
    E5AN/E5EN-H, 25  
    E5CN-H, 24  
  to panel  
    E5AN/E5EN-H, 25  
    E5CN-H, 23  
MV, 220  
MV at PV error, 149

**N**

No. 1 display, 3  
No. 2 display, 3

**O**

ON/OFF control, 54, 238  
  setting, 64  
one-point shift, 96  
operation level, 13, 183  
  parameter operation list, 326  
operation/adjustment protect, 113  
output functions  
  assignments, 56  
output limits, 148

output periods, 239  
output specifications  
  setting, 55

**P**

panel cutout  
  E5AN-H, 21  
  E5CN-H, 21  
  E5EN-H, 22  
parameter flow, 353  
parameter operation list, 326  
  adjustment level, 327  
  manual control level, 337  
  operation level, 326  
parameter operation lists  
  advanced function setting level, 340  
  communications setting level, 345  
  initial setting level, 332  
  protect level, 345  
parameter structure, 298  
parameters  
  additional PV display, 262  
  adjustment level display, 208  
  advance, 107, 140, 188  
  alarm 1 hysteresis, 244  
  alarm 1 latch, 263  
  alarm 1 OFF delay, 268  
  alarm 1 ON delay, 267  
  alarm 1 type, 240  
  alarm 2 hysteresis, 244  
  alarm 2 latch, 263  
  alarm 2 OFF delay, 268  
  alarm 2 ON delay, 267  
  alarm 2 type, 244  
  alarm 3 hysteresis, 244  
  alarm 3 latch, 263  
  alarm 3 OFF delay, 268  
  alarm 3 ON delay, 267  
  alarm 3 type, 245  
  alarm lower limit, 74  
  alarm lower limit 1, 202  
  alarm lower limit 2, 202  
  alarm lower limit 3, 202  
  alarm SP selection, 278  
  alarm upper limit, 74  
  alarm upper limit 1, 202  
  alarm upper limit 2, 202  
  alarm upper limit 3, 202  
  alarm value, 74

- alarm value 1, 201
- alarm value 2, 201
- alarm value 3, 201
- alpha, 261
- AT calculated gain, 261
- AT execute/cancel, 208
- AT hysteresis, 261
- auto/manual select addition, 269
- auto/manual switch, 186
- automatic cooling coefficient adjustment, 283
- automatic display return time, 263
- auxiliary output \* open in alarm, 259
- auxiliary output 1 assignment, 275
- auxiliary output 2 assignment, 276
- auxiliary output 3 assignment, 277
- broken-line correction value 0 to 10, 224
- character select, 277
- closed/floating, 250
- cold junction compensation method, 264
- communications baud rate, 296
- communications data length, 296
- communications parity, 296
- communications stop bits, 296
- communications Unit No., 296
- communications writing, 209
- control output 1 assignment, 273
- control output 1 ON/OFF count alarm set value, 292
- control output 1 ON/OFF count monitor, 291
- control output 2 assignment, 274
- control output 2 ON/OFF count alarm set value, 292
- control output 2 ON/OFF count monitor, 291
- control period (cooling), 239
- control period (heating), 239
- cooling coefficient, 217
- dead band, 218
- decimal point, 237
- derivative time, 216
- direct setting of position proportional MV, 282
- direct/reverse operation, 240
- display PID selection, 226
- display program selection, 60, 198
- display refresh period, 290
- display segment selection, 198
- elapsed program time monitor, 189
- event input assignment \*, 249
- extraction of square root enable, 251
- extraction of square root low-cut point, 223
- fixed SP, 210
- HB ON/OFF, 259
- heater burnout detection 1, 211
- heater burnout detection 2, 212
- heater burnout hysteresis, 260
- heater burnout latch, 260
- heater current 1 value monitor, 191, 210
- heater current 2 value monitor, 192, 212
- heater overcurrent detection 1, 211
- heater overcurrent detection 2, 213
- heater overcurrent hysteresis, 284
- heater overcurrent latch, 284
- heater overcurrent use, 283
- hold, 107, 140, 188
- HS alarm 1, 214
- HS alarm 2, 215
- HS alarm hysteresis, 271
- HS alarm latch, 270
- HS alarm use, 270
- hysteresis (cooling), 218
- hysteresis (heating), 218
- infrared communications use, 209
- initial setting/communications protect, 180
- input digital filter, 262
- input error output, 264
- input shift type, 268
- input type, 236
- integral time, 216
- LBA band, 272
- LBA detection time, 271
- LBA level, 272
- leakage current 1 monitor, 193, 213
- leakage current 2 monitor, 193, 214
- limit cycle MV amplitude, 261
- linear current output, 248
- lower-limit temperature input shift value, 216
- manual MV limit enable, 281
- manual reset value, 218
- monitor/setting item, 286
- monitor/setting item display 1 to 5, 230
- motor calibration, 251
- move to advanced function setting level, 255
- move to calibration level, 295
- move to protect level, 180
- move to protect level time, 264
- MV at PV error, 220
- MV at reset, 148, 220
- MV at reset and error addition, 269
- MV change rate limit, 221
- MV display, 262
- MV display selection, 288
- MV lower limit, 221
- MV monitor (cooling), 194
- MV monitor (heating), 194
- MV upper limit, 221
- number of segments used, 60, 198
- ON/OFF counter reset, 293



- open/close hysteresis, 222
- operation end operation, 147, 254
- operation/adjustment protect, 180
- parameter initialization, 258
- parameter mask enable, 182
- password to move to protect level, 182
- PF key protect, 181
- PF setting, 285
- PID \* cooling coefficient, 229
- PID \* integral time, 227
- PID \* LBA detection time, 229
- PID \* MV lower limit, 227
- PID \* proportional band, 227
- PID automatic selection range upper limit, 228
- PID derivative time, 227
- PID MV upper limit, 227
- PID ON/OFF, 238
- PID set automatic selection data, 280
- PID set automatic selection hysteresis, 280
- PID set no., 201
- position proportional dead band, 222
- process value, 185
- process value/set point, 185
- program end ON time, 144, 293
- program execution repetitions monitor, 190
- program link destination, 141, 203
- program no., 60, 187
- program repetitions, 141, 203
- program SP shift value, 147, 224
- program SP shift value addition, 294
- program time unit, 252
- proportional band, 216
- protocol setting, 296
- PV change color, 265
- PV dead band, 281
- PV decimal point display, 289
- PV rate of change calculation period, 282
- PV stable band, 266
- PV start, 145, 254
- PV status display function, 289
- PV/MV (manual MV), 232
- PV/SP display screen selection, 288
- remaining standby time monitor, 189
- remote SP enable, 278
- remote SP input, 280
- remote SP lower limit, 279
- remote SP monitor, 190
- remote SP upper limit, 279
- reset operation, 89, 253
- RSP 0 to RSP 10 before correction, 224
- RSP broken-line correction display addition, 294
- RT, 269
- run/reset, 89, 106, 194
- scaling lower limit, 237
- scaling upper limit, 237
- segment n ramp rate, 200
- segment n set point, 199
- segment n time, 200
- segment n type, 199
- segment no. monitor, 187
- selecting, 15
- send data wait time, 296
- setting change protect, 181
- SP lower limit, 238
- SP mode, 209
- SP tracking, 279
- SP upper limit, 238
- standard or heating/cooling, 239
- standby sequence reset, 258
- standby time, 223
- standby time unit, 294
- startup operation, 90, 253
- step time/rate of rise programming, 252
- SV status display function, 290
- temperature input shift, 215
- temperature unit, 237
- time signal 1 ON time, 204
- time signal 1 set segment, 204
- time signal 2 ON time, 204
- time signal 2 set segment, 204
- time unit of ramp rate, 252
- transfer output lower limit, 247
- transfer output type, 246
- transfer output upper limit, 247
- travel time, 251
- upper-limit temperature input shift value, 216
- wait, 142
- wait band, 219
- part names, 2
- password, 114, 115
- PID constants
  - setting manually, 70
- PID control
  - setting, 64
- PID sets, 136
- PID setting level, 226
- platinum resistance thermometer, 308
  - calibration, 303
- power supply
  - wiring, 33
- precautions
  - wiring, 33

process value (PV), 185  
program number, 107  
program SP mode, 209  
proportional action, 71  
protect level, 13, 113, 179  
    moving to, 115, 180, 264  
    communications operation command, 115  
    password, 114, 182  
    parameter operation list, 345  
protection, 113  
    initial setting/communications, 114, 180  
    operation/adjustment, 113, 180  
    setting change, 114  
PV display  
    color change, 117  
    stable band, 118  
PV/MV, 232

## R

ramp, 138  
ratings, 311  
remote SP broken-line correction value, 164  
remote SP mode, 210  
removing from case  
    E5AN/E5EN-H, 27  
    E5CN-H, 26  
reverse operation, 55, 240  
RT (robust tuning), 68, 269  
Run, 194

## S

scaling  
    upper and lower limits for analog inputs, 100  
segment ramp rate, 138  
segment set point, 138  
segment time, 138  
segment type, 138  
sensor input  
    control range, 351  
    indication range, 351  
    setting range, 351  
sensor types, 236  
set point (SP)  
    limiter, 110  
    lower limit, 111

    setting upper and lower limits, 110  
    upper limit, 111  
setting change protect, 114  
setting level configuration, 12  
setting levels  
    diagram, 353  
settings  
    cooling coefficient, 103  
    dead band, 104  
    event input, 105  
    HB alarm (heater burnout alarm), 83  
        moving to advanced function setting level, 83  
    heating/cooling control, 103  
    HS alarm, 85  
        moving to advanced function setting level, 84, 85  
    hysteresis, 65  
    LBA detection time, 123  
    password, 115  
    PID ON/OFF, 64  
    saving, 15  
    SP lower limit, 111  
    SP upper limit, 111  
shifting input values, 95  
soak, 138  
specifications, 311  
    Current Transformer (CT), 314  
    output, 55  
    USB-Serial Conversion Cable, 316  
standard control, 239  
standby, 146  
standby sequence, 99  
step, 138  
support software port, 42

## T

temperature input, 9  
    shift values, 98  
temperature unit, 4, 54  
terminals  
    arrangement  
        E5AN/E5EN-H, 32  
        E5CN-H, 30  
    wiring, 30  
thermocouple, 308  
    calibration, 299  
Thermocouple/Resistance Thermometer  
    input type, 303  
three-position control, 63

time signal, 143  
transfer output, 132  
  type, 132  
troubleshooting, 321  
two-point shift, 96, 97, 98

## **U**

universal inputs, 298  
up key, 5  
USB-Serial Conversion Cable  
  specifications, 316  
user calibration, 299

## **V**

voltage input  
  calibration, 305

## **W**

wiring, 33  
  auxiliary outputs 2, and 3, 36  
  communications  
    RS-485, 39  
  control output 1, 34  
  control output 2, 35  
  CT inputs, 38  
  event inputs, 37  
  inputs, 33  
  power supply, 33  
  precautions, 33  
  terminal arrangement, 30  
  terminals, 30



## Revision History

A manual revision code appears as a suffix to the catalog number on the front cover of the manual.

Cat. No. H169-E1-05

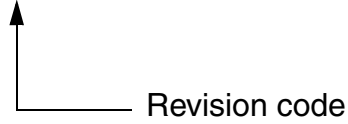

The following table outlines the changes made to the manual during each revision. Page numbers refer to the previous version.

Revision code	Date	Revised content
01	December 2010	Original production
02	September 2013	<b>Page 171:</b> Added two notes and references to <i>Setting range for Control output (heating)</i> and <i>Control output (cooling)</i> . <b>Page 224:</b> Removed part of sentence at start of second section.
03	June 2015	<b>Page vii:</b> Deleted section entitled <i>Read and Understand this Manual</i> . <b>Page 318:</b> Added information on transfer output under <i>Operation at Error</i> .
04	February 2017	Corrected mistakes and added explanations.
05	June 2020	<b>Page 2:</b> Made changes in <i>Terms and Conditions Agreement</i> . <b>Page 140:</b> Added a note to Changing Parameters (Added usage caution for <i>Changing Parameters</i> ). Corrected mistakes.





**OMRON Corporation Industrial Automation Company**

Kyoto, JAPAN

Contact: [www.ia.omron.com](http://www.ia.omron.com)

**Regional Headquarters**

**OMRON EUROPE B.V.**

Wegalaan 67-69, 2132 JD Hoofddorp  
The Netherlands

Tel: (31)2356-81-300/Fax: (31)2356-81-388

**OMRON ELECTRONICS LLC**

2895 Greenspoint Parkway, Suite 200  
Hoffman Estates, IL 60169 U.S.A.

Tel: (1) 847-843-7900/Fax: (1) 847-843-7787

**OMRON ASIA PACIFIC PTE. LTD.**

No. 438A Alexandra Road # 05-05/08 (Lobby 2),  
Alexandra Technopark,  
Singapore 119967

Tel: (65) 6835-3011/Fax: (65) 6835-2711

**OMRON (CHINA) CO., LTD.**

Room 2211, Bank of China Tower,  
200 Yin Cheng Zhong Road,  
PuDong New Area, Shanghai, 200120, China  
Tel: (86) 21-5037-2222/Fax: (86) 21-5037-2200

**Authorized Distributor:**

© OMRON Corporation 2010-2020 All Rights Reserved.  
In the interest of product improvement,  
specifications are subject to change without notice.

**Cat. No. H169-E1-05**

0620