

## Temperature Controller

## E5AX-P

### A 96 x 96 mm (DIN) Controller for Control Valves

- Controls motor valves without a potentiometer.
- Optimum PID control with feed-forward control circuitry.
- High precision regardless of the set temperature.
- Compatible with various inputs (input selected via internal switch).
- Models with communications capabilities also available.

## Ordering Information

### ■ Electronic Temperature Controller

Communications	None	RS-232C	RS-422*	RS-485*	BCD	Transmission output**/*** (4 to 20 mA)	Communications Board Add-on Type
Model	E5AX-PRR	E5AX-PRR01	E5AX-PRR02	E5AX-PRR03	E5AX-PRR20	E5AX-PRRF	E5AX-PRRM

\*The Controller can also be equipped with a terminal block to connect communications. Specify a terminal block by adding "-X" to the model number. Example: E5AX-PRR02-X

\*\*Capable of transmitting the process value or output value, but remote setting by external input is not possible.

### ■ Temperature Ranges

Input (switch selectable)	Thermocouple							Temperature resistance thermometer
	K Chromel vs. alumel	J/L Iron vs. constantan	T/U Copper vs. constantan	E Chromel vs. constantan	R Platinum vs. platinum 13% rhodium	S Platinum vs. platinum 10% rhodium	PT platinum resistance thermometer (Pt100/JPt100)	
Range	%C	-200 to 1,300	-100 to 850	-200 to 400	0 to 600	0 to 1,700	0 to 1,700	-99.9 to 450.0
	%F	-300 to 2,300	-100 to 1,500	-300 to 700	0 to 1,100	0 to 3,000	0 to 3,000	-99.9 to 800.0
Resolution (%C/%F) (main settings and alarm)	1							0.1

### ■ Communications Boards

Communications	RS-232C	RS-422	RS-485	BCD	Transmission output (4 to 20 mA)
Model	E53-X01	E53-X02	E53-X03	E53-X20	E53-XF

# Specifications

## ■ Ratings

<b>Supply voltage</b>	100 to 240 VAC, 50/60 Hz (either frequency applicable with same unit)
<b>Operating voltage range</b>	85% to 110% of rated supply voltage
<b>Power consumption</b>	Approx. 10 VA (at 100 VAC) to 15 VA (at 240 VAC) Approx. 12 VA (at 100 VAC) to 15 VA (at 240 VAC) with communication function
<b>Input</b>	Thermocouple (K/J/T/E/R/S/L/U) or platinum resistance thermometer (Pt100/JPt100) selectable
<b>Potentiometer input</b>	100 W to 2.5 kW
<b>Control output</b>	Relay output: open, close; SPST-NO contacts; 3 A, 250 VAC (resistive load); inrush current: 1 A max.
<b>Control mode</b>	PID control with auto-tuning
<b>Alarm output</b>	Relay output, SPST-NO contacts; 3 A, 250 VAC (resistive load)
<b>Setting method</b>	Digital setting via Up and Down Keys
<b>Indication method</b>	Digital indications (character heights PV: 15 mm and SV: 11 mm) (Color PV: red, SV: green)
<b>Other functions</b>	Upper and lower limits for set value Key protection Input shift Display unit selection (%C/%F) Normal and reverse output selection Valve position display Motor calibration function Watchdog timer function (Detects failures in the CPU and restores the CPU.) Manual output (balanceless-bumpless operation switchable)

## ■ Communications

Protocol		RS-232C, RS-422, RS-485	BCD	Transmission output
<b>Transmission method</b>		Half-duplex	Data select code	4 to 20 mA DC Load: 600 W max. Resolution: Approx. 3,200
<b>Synchronization method</b>		Start-stop synchronization	---	---
<b>Baud rate</b>		150/300/600/1,200/2,400/4,800/9,600 bps	---	---
<b>Transmission code</b>		ASCII (7-bit)	---	---
<b>Communications</b>	<b>Write to Temperature Controller</b>	Main setting, set alarm value, proportional band, integral time, derivative time, AT start/stop etc.	Main setting, set alarm value	Write disabled
	<b>Read from Temperature Controller</b>	Main setting, set alarm value, proportional band, integral time, derivative time, set limit value, process value, valve position, error codes, etc.	Main setting, set alarm value, process value, error codes, etc.	Process value (see note 3), valve position

- Note:**
1. The maximum total cable length must not exceed the following limits.  
RS-422: 500 m; RS-232C: 15 m; RS-485: 500 m
  2. A maximum of 32 Temperature Controllers can be connected to one host computer using serial communications (RS-422, RS-485).
  3. Outputs the temperature data within the set limits.

## ■ Characteristics

<b>Setting accuracy</b>	(+0.3% of set value or +1%C, whichever greater), +1 digit max.
<b>Indication accuracy</b>	(+0.3% of set value or +1%C, whichever greater), +1 digit max. (Set value coincides with the indicated value, because no relative error exists between both values.)
<b>Disable band</b>	0.1% to 10.0% (in units of 0.1%)
<b>Proportional band</b>	0.1% to 999.9 %C/%F (in units of 0.1%C/%F)
<b>Integral time</b>	1 to 3,999 s (in units of 1 s)
<b>Derivative time</b>	0 to 3,999 s (in units of 1 s)
<b>Alarm output setting range</b>	Thermocouple: -999% to 9,999%C/%F (in units of 1%C/%F) Platinum resistance thermometer: -99.9% to 999.9%C/%F (in units of 0.1%C/%F)
<b>Alarm output hysteresis</b>	0.0% to 999.9 %C/%F (in units of 0.1%C/%F)
<b>Sampling period</b>	500 ms (temperature sensor input)
<b>Output refresh period</b>	500 ms
<b>Display refresh period</b>	500 ms (temperature sensor input)
<b>Valve travel indication</b>	-99% to 999% (in units of 1%)
<b>Full Open/close time</b>	1 to 999 s (in units of 1 s)
<b>Input shift</b>	Thermocouple: -999% to 9,999%C/%F (in units of 1%C/%F) Platinum resistance thermometer: -99.9% to 999.9%C/%F (in units of 0.1%C/%F)
<b>Insulation resistance</b>	20 MW min. (at 500 VDC)
<b>Dielectric strength</b>	2,000 VAC 50/60 Hz for 1 min between terminals of different polarities
<b>Vibration resistance</b>	Malfunction: 2 to 55 Hz, 2G 10 min each in X, Y, and Z directions Destruction: 10 to 55 Hz, 0.75-mm double amplitude 2 hrs each in X, Y, and Z directions
<b>Shock resistance</b>	Malfunction: 200 m/s <sup>2</sup> 3 times each in 6 directions Destruction: 300 m/s <sup>2</sup> 3 times each in 6 directions
<b>Life expectancy</b>	Mechanical: 10,000,000 operations min. Electrical: 100,000 operations min.
<b>Ambient temperature</b>	Operating: -10% to 55°C (with no icing) Storage: -25% to 65°C (with no icing)
<b>Ambient humidity</b>	Operating: 35% to 85%
<b>Memory protection</b>	Non-volatile memory
<b>Enclosure ratings</b>	Front panel: IEC standard IP50 Rear case: IEC standard IP20 Terminals: IEC standard IP00
<b>Weight</b>	Standard: Approx. 350 g; Communications: Approx. 480 g; Mounting bracket: Approx. 50 g

\*The accuracy of U thermocouples under temperatures from -150% to 400°C (-240% to 700°F) is +2°C (+3.6°F) +1 digit. Accuracy is reduced below -150°C (-240°F). The accuracy of R and S thermocouples under 0% to 200°C (0% to 400°F) is +3°C (+5.4°F) +1 digit.

# Nomenclature

**Auto-tuning Indicator**  
Flashes on and off every second when auto-tuning is taking place.

**Manual Output Mode Indicator**  
Lights when in manual output mode.

**Open Output Indicator**  
Lights when the open output is ON.

**Close Output Indicator**  
Lights when the close output is ON.

**Level Key**  
Press for 2 seconds minimum to change levels to set different groups of parameters.

**Display Key**  
Press to shift the display to the next parameter.

**Process Value (PV) Display**

Displays the process value, the character for parameter being displayed on the SV display and error messages.

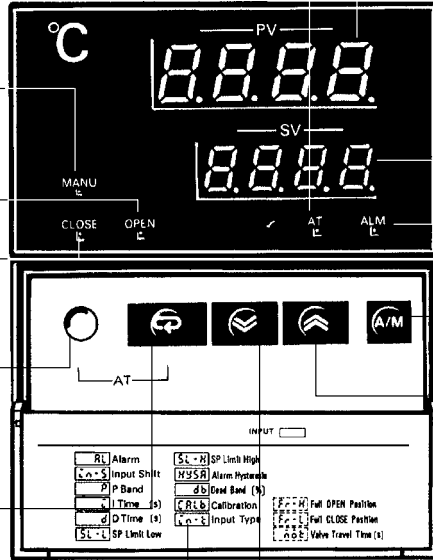

**Set Value (SV) Display**  
Displays main setting and other parameters.

**Alarm Indicator**  
Lights when the alarm output is ON.

**A/M Key (Automatic/Manual)**  
Press for 1 second minimum to switch between auto output mode and manual output mode.

**Up Key**  
Press to increase the main setting or other parameters. Successively increases the value when held down.

**Down Key**

Press to decrease the main setting or other parameters. Successively decreases the value when held down.

# Operation

**NOTICE:** Always turn off the power supply to the Electronic Temperature Controller before changing any switch settings.

## Settings

1. Remove the internal mechanism from the housing. Lift the internal mechanism while pressing the hook at the bottom of the front panel.

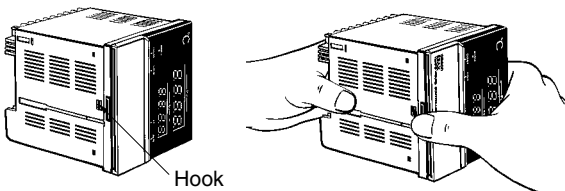

Pull out the internal mechanism while holding down the hook with your finger.

2. Four internal switches must be set on the E5AX: the temperature sensor selector, the operating mode selector, and the alarm mode selectors 1 and 2.

The figures show the locations of these switches and the protection switches on the internal mechanisms. The protection switch can be used to disable key operation.

Protection switch (SW101, PROTECT)

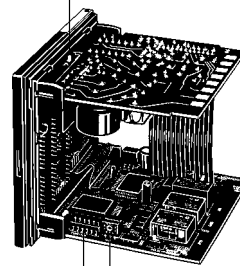

Alarm mode selector (SW205, ALM)

Operating mode selector (SW 201, FUNCTION)

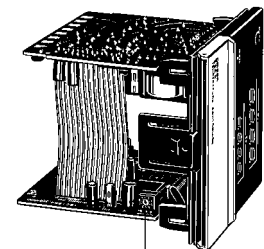

Temperature sensor selector (SW206, INPUT)

## Temperature Sensor Selector (SW206, INPUT)

This selector selects the temperature sensor to be used. It is factory-set to position 2 to designate a K-type (chromel-alumel thermocouple) temperature sensor. The following table lists the other pos-

sible settings for temperature sensors. Refer to temperature range charts under *Ordering Information* for further information.

The scale displayed (%C or %F) is selected by the operating mode selector (SW201).

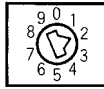

Switch setting	Temperature sensor code	Temperature range	
		%C	%F
0	R	0 to 1,700	0 to 3,000
1	S	0 to 1,700	0 to 3,000
2	K	-200 to 1,300	-300 to 2,300
3	J	-100 to 850	-100 to 1,500
4	T	-200 to 400	-300 to 700
5	E	0 to 600	0 to 1,100
6	JPt100	-99.9 to 450.0	-99.9 to 800.0
7	Pt100	-99.9 to 450.0	-99.9 to 800.0
8	L	-100 to 850	-100 to 1,500
9	U	-200 to 400	-300 to 700

## ■ Operating Mode Selector (SW201, FUNCTION)

This DIP switch selects the operation modes listed in the following table.

Function	Pin number	Pin setting	Control setting
Not used.*	1	Leave turned OFF.	
Control output	2	ON	Normal (cooling)
		OFF	Reverse (heating)
Input shift	3	ON	Enabled
		OFF	Disabled
SP (set point)** protection cancel	4	ON	Enabled
		OFF	Disabled
Display unit	5	ON	%F
		OFF	%C
PID display	6	ON	Enabled
		OFF	Disabled

\*Always operate with pin 1 OFF. Operating with pin 1 ON could result in malfunction.

\*\*SP protection cancel is effective only when SW101 (key protection) is on. If the SP protection cancel is ON, key protection (SW101 ON) will not apply to the set point, i.e., you will be able to change the set point regardless of the setting of SW101.

## ■ Alarm Mode Selector (SW205: ALM)

Alarm mode selector is provided on all E5AX Temperature Controllers. Alarm modes, listed in the following table, can be selected using this switch. The switch is factory-set to position 2, i.e., the upper-limit alarm mode.

Switch setting	Mode (SW205)		Alarm output		Setting range
	Alarm operation	Display	When X is positive	When X is negative	
0	No alarm	No display	OFF		---
1	Upper- and lower-limit alarm	)—(		---	Thermocouple: 0% to 9,999% C/%F Platinum resistance thermometer: 0% to 999.9% C/%F
2	Upper-limit alarm	—(			Thermocouple: -999% to 9,999% C/%F
3	Lower-limit alarm	)—			Platinum resistance thermometer: -99.9% to 999.9% C/%F
4	Upper- and lower-limit range alarm	-( )-			Thermocouple: 0% to 9,999% C/%F
5	Upper- and lower-limit alarm with standby sequence	3—e			Platinum resistance thermometer: 0% to 999.9% C/%F
6	Upper-limit alarm with standby sequence	—e			Thermocouple: -999% to 9,999% C/%F
7	Lower-limit alarm with standby sequence	3—			Platinum resistance thermometer: -99.9% to 999.9% C/%F
8	Absolute-value alarm	1—(			0% C

### ■ Key Protection Switch (SW101, PROTECT)

When the key protection switch is set to the ON position, the Level Key, Up and Down Keys, and Auto-tuning Key cannot be operated. In effect, the Temperature Controller is write-protected and the set values (such as the alarm value) can be read out only. The set point, however, will not be protected if the SP protection disable is turned ON (pin 4 of SW201).

## Motor Calibration: calb

The following settings are used to set the opening/closing time for controlling valves. Always set the following parameters when installing the controller. If a display is required for valve position, set the open and close positions at the same time.

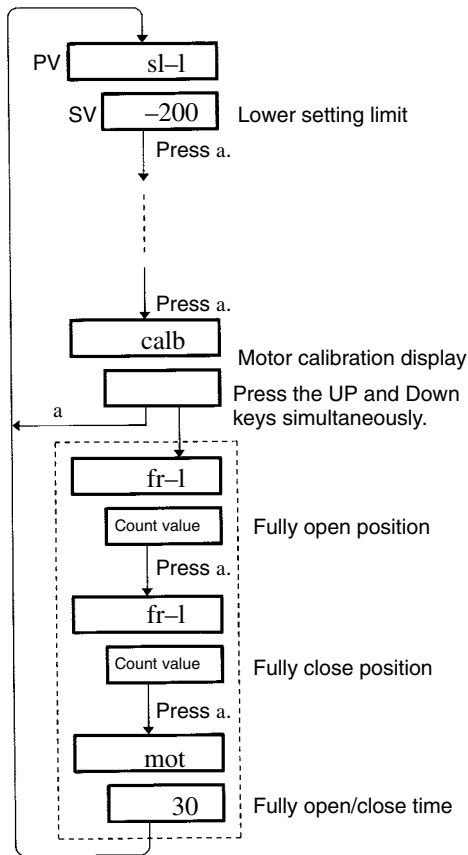

### Settings when Not Using a Potentiometer (No Valve Position Display)

1. Turn on power and press the Level Key for at least two seconds. sl-1 will be displayed. Then press the Display Key until calb is displayed. This is the initial mode when power is turned on for the first time.
2. Simultaneously press the Up and Down Keys for at least one second. fr-h will be displayed and the OPEN output will turn ON.
3. Press the Display Key. fr-l will be displayed, the OPEN output will turn OFF, and the CLOSE output will turn ON.
4. Press the Display Key. mot will be displayed and the CLOSE output will turn OFF. While mot is displayed, use the Up and

Down Keys to set the fully open/close time to a value between 1 and 999 s in the units of 1 s.

5. Press the Display Key. sl-1 will be displayed and motor calibration will be complete. Press the Level Key for at least two seconds, confirm that in-t is displayed, and then press the Level Key again for at least two seconds to display the process value and return to the initial display mode.

### Settings with a Potentiometer (with Valve Position Display)

1. Turn on power and press the Level Key for at least two seconds. sl-1 will be displayed. Then press the Display Key until calb is displayed. This is the initial mode when power is turned on for the first time.
2. Simultaneously press the Up and Down Keys for at least one second. fr-h will be displayed, the OPEN output will turn ON, and the valve will start to open. Press the Display Key as soon as the valve stops by the limit switch built into the motor. The count value for the fully open position will be set.
3. Press the Display Key. fr-l will be displayed, the OPEN output will turn OFF, the CLOSE output will turn ON, and the valve will start to close. Press the Display Key as soon as the valve stops by the limit switch built into the motor. The count value for the fully close position will be set.
4. Press the Display Key. mot will be displayed and the CLOSE output will turn OFF. The automatically set fully open/close time will be displayed. Use the Up and Down Keys to adjust the setting if required (value must be between 1 and 999 s in the units of 1 s).
5. Press the Display Key. sl-1 will be displayed and motor calibration will be complete. Press the Level Key for at least two seconds, confirm that in-t is displayed, and then press the Level Key again for at least two seconds to display the process value and return to the initial display mode.

### WARNING

Never calibrate the motor during control operation. Make sure that control operations have been stopped before calibrating.

- Note:**
1. The output mode cannot be changed in motor calibration mode.
  2. If the fully open position is less than the fully closed position, the value position will not be displayed and the display will show "a—" for automatic and "m—" for manual operation. If a potentiometer is not being used for feedback, press the Display Key at steps 2 and 3 without regarding the position of the valve and then set the fully open/close time. Here too, the display for value position will show "a—" for automatic and "m—" for manual operation.

### Inputting Parameters

The Temperature Controller has three display levels, 0, 1, and 2, in which only specific parameters can be set. Level 0 is the initial and is automatically entered at power application. To change the mode to set or change a different group of parameters, hold down the Level Key for 2 seconds minimum. The display level mode changes as shown below. Actual displays vary with models and switch settings. If a display does not appear as expected, check your switch settings.

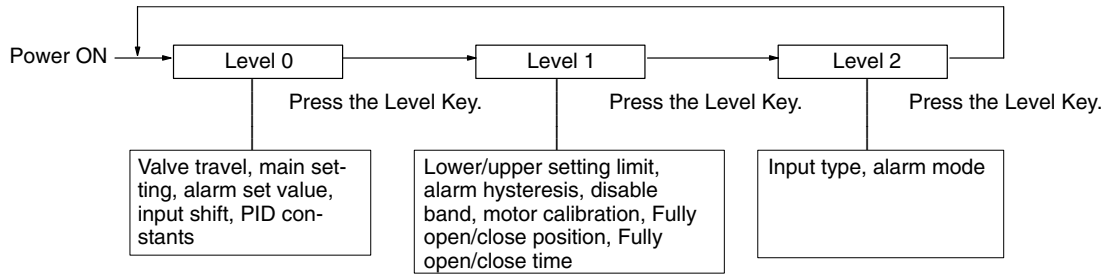

#### Level 0

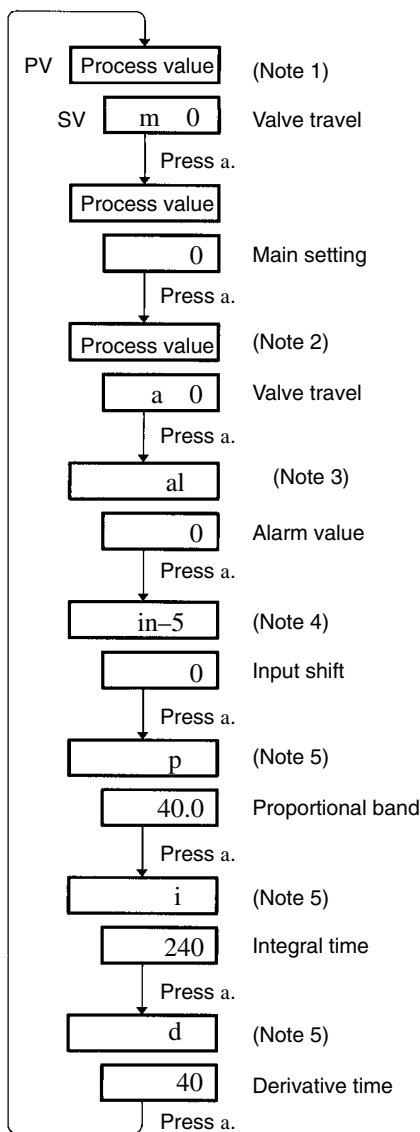

- Note:**
1. Not displayed in automatic output mode. "m—" will be displayed if a potentiometer is not connected.
  2. Not displayed in manual output mode. "a—" will be displayed if a potentiometer is not connected.
  3. Not displayed when the alarm is disabled (SW203 set to 0 or 9).
  4. Not displayed when the input shift display is disabled (SW201, pin 3 OFF).
  5. Not displayed when PID display is disabled (SW201, pin 6 OFF).

#### Main Setting

The set point can be changed with the Up and Down Keys.

#### Valve Travel

The value travel can be monitored. If a potentiometer is not connected, the display will show "a—" for automatic and "m—" for manual operation. While "m" is displayed in manual output mode, the Up Key will turn ON the OPEN output and the Down Key will turn ON the CLOSE output.

#### Selecting the Output Mode

The A/M Key can be pressed for one second or longer to change between the automatic and manual output modes. The balance-less-bumpless function will operate to prevent the output from changing abruptly.

#### Automatic Output Mode

In automatic output mode, the control will function automatically. When the A/M Key is pressed and the automatic output mode is first entered, displays like the following will appear (display level 0).

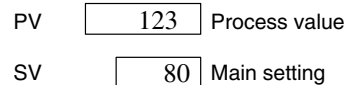

#### Manual Output Mode

In manual output mode, the controller can be operated with the Up and Down Keys. The Up Key will turn the OPEN output ON and light the OPEN indicator. The Down Key will turn ON the CLOSE output and light the CLOSE indicator.

When the A/M Key is pressed and the manual output mode is first entered, displays like the following will appear (display level 0).

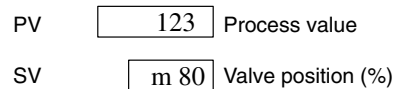

The MANU indicator will light and remain lit until the automatic output mode is returned to.



**Alarm: al**

When **al** is displayed on the PV display, the alarm value for alarm output can be set on the SV display. When the temperature exceeds or falls below the set alarm value, the corresponding alarm output is produced and the ALM indicator on the front panel lights. Usually, the alarm value is set as a deviation from the main setting, but it can also be set as an absolute value when the event alarm mode is selected. Set the alarm value by using the Up and Down Keys while **al** is displayed. The message is not displayed if the alarm mode selector is set to position 0. Factory-set to upper-limit, alarm value 0%**C**/**%F**

**Input Shift: in-5**

When pin 3 of the operating mode selector switch (SW201) is set to the ON position, the input shift function can be used. This function is used to shift the temperature display from the measured value by a desired value, as shown by the examples in the following table:

Input shift value	Temperature measured by sensor	Displayed temperature
0 (without shift)	100% <b>C</b>	100% <b>C</b>
10 (shifted by 10% <b>C</b> )	100% <b>C</b>	110% <b>C</b>
-10 (shifted by -10% <b>C</b> )	100% <b>C</b>	90% <b>C</b>

This function can be used mainly for fine tuning compensation, while leaving the set temperature unaffected. Select this function by pressing the Display Key three times in display level 0.

**Proportional Band: p**

When the character **p** is displayed on the PV display, the proportional band (P constant) can be changed using the Up and Down Keys. The new value will be displayed on the SV display. It can be set in a range from 0.1% to 999.9%**C**/**%F** in units of 0.1%**C**/**%F**. The factory setting is 40.0%**C**/**%F**.

**NOTICE:** The output value will change according to the difference between the set value and the present value when the proportional band is changed during control operation. If this difference is too great, a drastic change will result. Always switch to the manual output mode before changing the proportional band.

**Integral Time (Reset Time): i**

When the character **i** is displayed on the PV display, the integral time (I constant) can be changed using the Up and Down Keys. It can be set in a range from 0 to 3,999 seconds in units of 1 second. The factory setting is 240 seconds.

**Derivative Time (Rate Time): d**

The derivative time (D constant) can be changed when the character **d** is displayed on the PV display using the Up and Down Keys. It can be set in a range from 0 to 3,999 seconds in units of 1 second. The factory setting is 40 seconds.

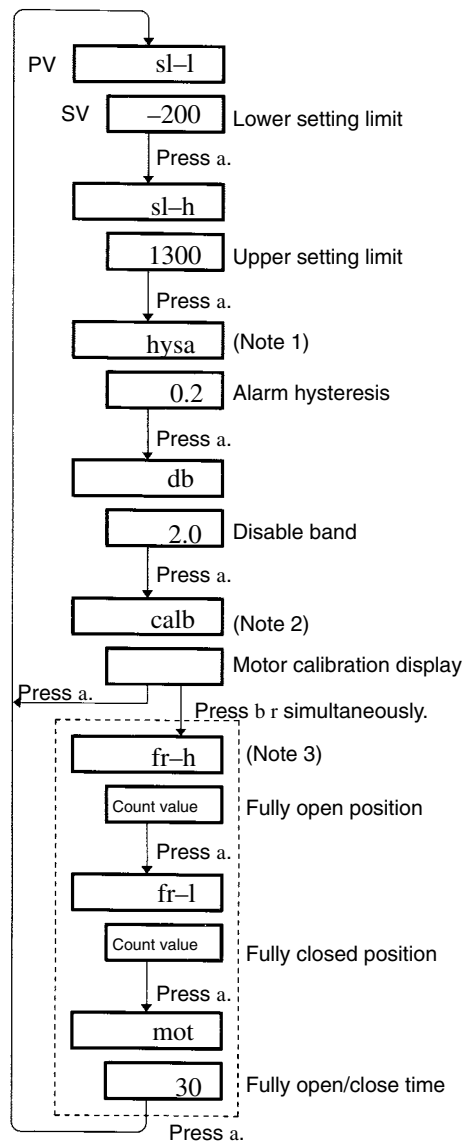
**Level 1**

- Note:**
1. Not displayed when the alarm is disabled (SW205 set to 0 or 9).
  2. Motor calibration will be displayed when power is turned on for the first time.
  3. Displayed only when the motor calibration mode is entered.

**Lower/Upper Limits of Setting Range:** sl-l, sl-h

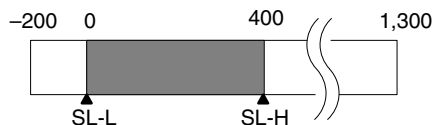

Basically, the temperature range that can be measured is determined by the temperature sensor to be used. For example, when a K-type (chromel-alumel thermocouple) temperature sensor is selected, the measurable range is from  $-200^{\circ}\text{C}$  to  $1,300^{\circ}\text{C}$ . However, this temperature range can be narrowed, for example, to  $0^{\circ}\text{C}$  to  $400^{\circ}\text{C}$ . To do this, set the lower-limit value of the temperature setting range, in this case to  $0^{\circ}\text{C}$ , on the SV display by using the Up and Down Keys while sl-l is displayed on the PV display. Similarly, set the upper-limit value,  $400^{\circ}\text{C}$ , while sl-h is displayed. If the process temperature falls below the set lower-limit value or exceeds the set upper-limit value, it is displayed on the PV display within the temperature range of the temperature sensor.

**Hysteresis Alarm:** hysa

The hysteresis alarm value for the alarm can be set in a range from 0.0% to 999.9% while hysa is displayed on the PV display using the Up and Down Keys. The factory setting is 0.2% C/F.

**Disable band:** db

The disable band can be set in a range from 0.1% to 10.0% while db is displayed on the PV display using Up and Down Keys. The factory setting is 2.0%.

**Motor Calibration:** calb

Designate whether or not to perform motor calibration. To enter the mode, simultaneously press the Up and Down Keys for at least one second. Press the Display Key to return to sl-l.

### WARNING

Never calibrate the motor during control operation. Make sure that control operations have been stopped before calibrating.

fr-h	Fully open position
fr-l	Fully closed position
mot	Opening/closing time

The motor is calibrated. Refer to page 9.

## Level 2

In level 2, selected input sensor, and modes for alarm output can be monitored. Note that level 2 is a monitoring level only and thus no parameters can be changed. When the Level Key is pressed for 2 seconds minimum after power application, sl-l is displayed on the PV display. Hold down the Level Key again for 2 seconds minimum to display o on the PV display. Then, selected input sensor, and alarm modes can be monitored each time the Display Key is pressed.

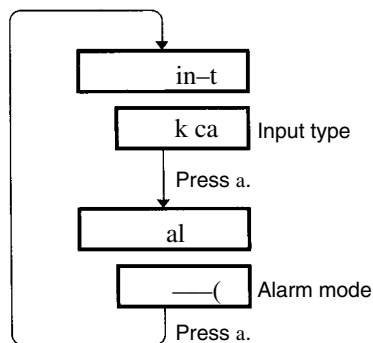

**Input Type:** in-t

When in-t is displayed on the PV display, the present setting of the input type selector (SW206), is displayed on the SV display. The following table shows the messages that may be displayed:

Display	Sensor
r pr	R
5 pr	S
k ca	K
j ic	J
t cc	T
e cr	E
jpt	JPt100*
pt	Pt100**
l ic	L
u cc	U

\*Meets JIS 1981.

\*\*Meets JIS 1989, DIN.

**AL (Alarm Mode):** al

When al is displayed on the PV display in level 2, alarm output mode or the present setting of the corresponding alarm mode selector (SW205) is displayed on the SV display. The following table shows the messages that may be displayed.

Display	Alarm mode
No display	No alarm
)—(	Upper- and lower-limit alarm
—(	Upper-limit alarm
)—	Lower-limit alarm
—()	Upper- and lower-limit range alarm
3—e	Upper- and lower-limit alarms with standby sequence
—e	Upper-limit alarm with standby sequence
3—	Lower-limit alarm with standby sequence
1—c	Absolute-value alarm

## ■ Starting Control Operation

The E5AX will start control operations as soon as power is turned on until power is turned off. If you don't want control operations to be performed while setting parameters, turn off the power and then turn it back on after setting the desired parameters.

### Auto-tuning

When the Level Key and Mode Key are pressed at the same time for 1 second minimum, the Temperature Controller automatically starts tuning the PID constants. While auto-tuning is in operation, the auto-tuning indicator on the front panel will flash. The Temperature Controller executes control based on the set PID constants (factory set to P = 40%C, I = 240 seconds, and D = 40 seconds) until the temperature of the controlled system reaches the set temperature. After that, the Temperature Controller automatically adjusts the PID constants using the limit cycle method. When the auto-tuning indicator turns off, the auto-tuning is terminated and PID constants are renewed.

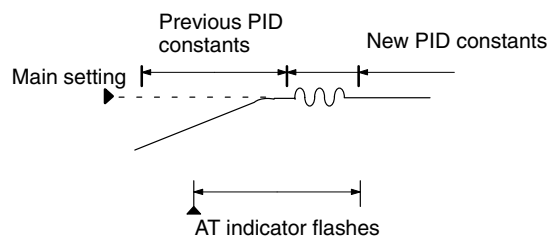

Limit Cycle Method: the optimum PID constants are calculated by this method by varying the control output variable and generating external oscillation.

Auto-tuning can be carried out regardless of whether the Temperature Controller is performing reverse (heating) or normal (cooling) operation. To stop auto-tuning, hold down the Level Key and Mode Key again simultaneously for 1 second minimum. All settings will return to those prior to the beginning of auto-tuning. Automatic tuning can be executed at any time: at power application, while the temperature is rising, or after the control action has stabilized.

## ■ Error Messages

The Temperature Controller is provided with self-diagnostic functions, and will display an error message on the PV display when an error is detected.

Message	Cause	Control output		Alarm output
		Normal	Reverse	
ffff	Input temperature has exceeded the upper limit of the temperature range by more than 20%C.	Open: OFF Close: ON	Open: ON Close: OFF	Sends alarm signal in accordance with the set alarm mode.
_____	Input temperature has fallen below the lower limit of the temperature range by more than 20%C.*	Open: ON Close: OFF	Open: OFF Close: ON	Sends alarm signal in accordance with the set alarm mode.
5.err (flashes)	The thermocouple has burned out or short-circuit bar has been removed. The platinum resistance thermometer has burned out or A and B terminals have been short-circuited.	Open: OFF Close: ON	Open: ON Close: OFF	Sends alarm signal in accordance with the set alarm mode. Proportional alarm output is OFF, however.
e111 (flashes) e333 (flashes)	Memory failure (e111) or A/D converter failure (e333) has occurred. Temperature Controller must be repaired if recovery is not made by turning power off once and on again.	Open: OFF Close: OFF	Open: OFF Close: OFF	OFF

\*When the temperature resistance thermometer is used, this message is displayed when the temperature has fallen below -99.9%C.

# Dimensions

**Note:** All units are in millimeters unless otherwise indicated.

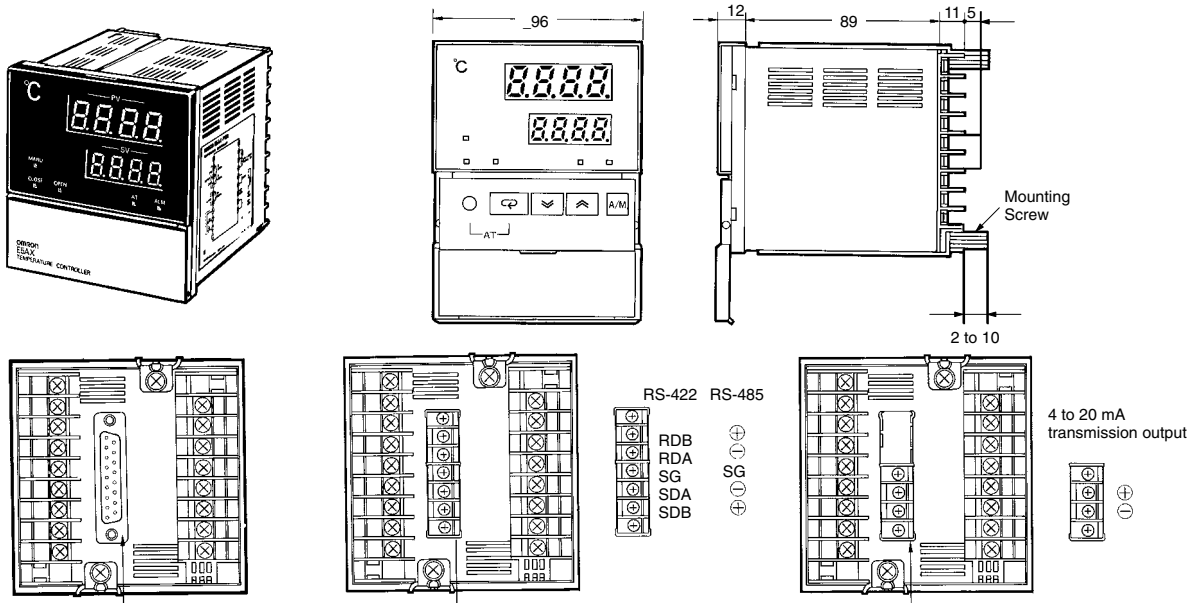

Communications connector (RS-232C and BCD connector is shown.)

Communications board (RS-422 and 485 terminals are shown.)

Communications board (4 to 20 mA transmission output is shown.)

### Panel Cutout

### Side-by-side Mounting of N Controllers

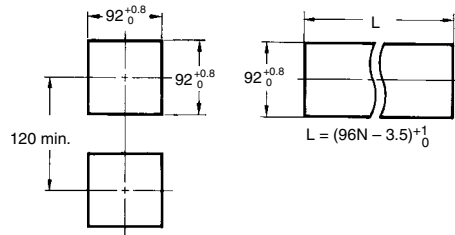

# Installation

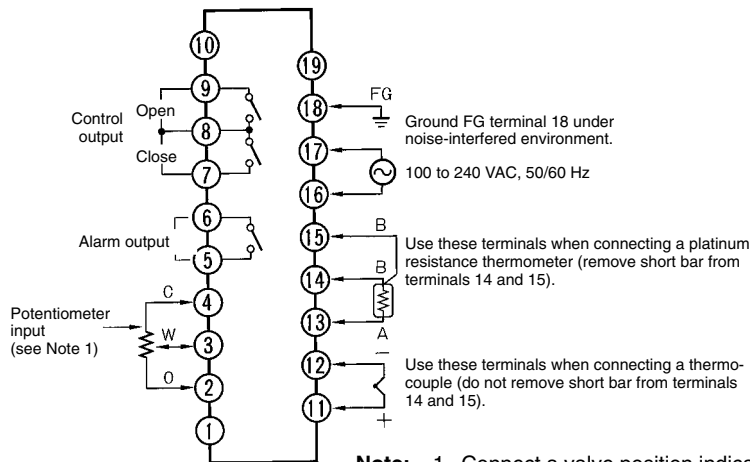

- Note:**
1. Connect a valve position indicator if required.
  2. Do not connect unused terminals.

# Precautions

## Mounting

The dimensions of the Temperature Controller conform to DIN 43700. Recommended panel thickness is 1 to 8 mm.

Do not install the Temperature Controller in a location exposed to excessive dust or corrosive gases. Moreover, avoid locations subject to heavy vibration or shock, water or oil spray, or high temperatures. Any of these condition will affect product life.

Isolate the Temperature Controller from equipment that generates strong, high-frequency noises such as high-frequency welders, because such equipment may prevent proper operation.

Attach the two mounting brackets supplied with E5AX on the top and bottom of the Temperature Controller. Tighten the screws of the mounting brackets with your fingers.

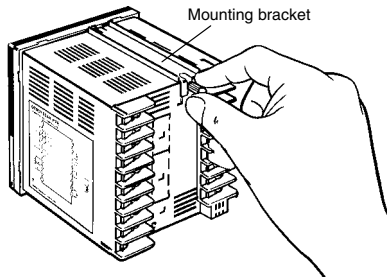

## Stickers Inside Frontcover

Stickers indicating the temperature sensor type (R, S, K, J, T, E, L, and U) are supplied with the Temperature Controller. Attach the proper stickers to the front panel as shown below.

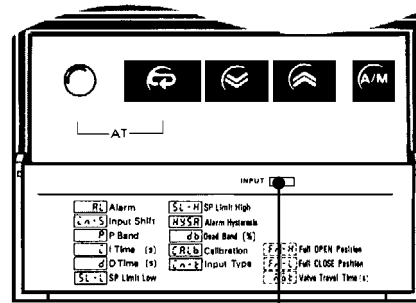

Sticker identifying input type

## Connection Examples

### With Solderless Terminal

Use M3.5 solderless terminals with the Temperature Controller's M3.5 self-rising pressure plate screws.

### Solder-dipped Leads

Strip 6 to 12 mm of the lead wires and carefully arrange the wire tips. Do not tighten the terminal screw with excessive force, because doing so may damage them. The terminal block of the Temperature Controller is constructed so that the lead wires can be connected to all the terminals from the same direction.

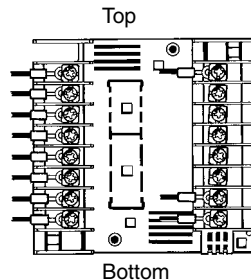

## Input Connection

To reduce inductive noise influence, the lead wires connecting the input to the Temperature Controller must be separated from the power lines and load lines.

Use the specified compensating conductors for thermocouples. When using a thermocouple as the temperature sensor, attach the short-circuit bar shown in the terminal block diagram on the housing. Use lead wires having a small resistance for temperature resistance thermometers.

Be sure to remove the short-circuit bar from the terminals when a temperature resistance thermometer is used.

### Sequenced Circuits

Several seconds are required until the relay is turned ON after power has been supplied to the Temperature Controller. Therefore, take this time delay into consideration when designing sequenced circuits which incorporate a Temperature Controller.

**ALL DIMENSIONS SHOWN ARE IN MILLIMETERS.**

To convert millimeters into inches, multiply by 0.03937. To convert grams into ounces, multiply by 0.03527.

Cat. No. H54-E1-1A **In the interest of product improvement, specifications are subject to change without notice.**

## **OMRON Corporation**

Temperature Control Devices Division  
29th Fl., Crystal Tower Bldg.  
1-2-27, Shiromi, Chuo-ku,  
Osaka 540 Japan  
Phone: 06-949-6070 Fax: 06-949-6084

Printed in Japan  
0791-1M