

Digital Controller

E5AX-LA/-MA

A 96 x 96-mm (DIN) Digital Process Controller

- Optimum PID control with feed-forward control circuitry.
- High accuracy (+0.3% FS +1 digit max.).
- Replaceable Output Units.
- Models with communications capabilities also available.

Ordering Information

■ Digital Controller

Communications	None	RS-232C	RS-422*	RS-485*	BCD	Transmission output**/** (4 to 20 mA)	Communications Board Add-on type
Model	E5AX-L(M)A	E5AX-L(M)A01	E5AX-L(M)A02	E5AX-L(M)A03	E5AX-L(M)A20	E5AX-L(M)AF	E5AX-L(M)AM

*The Controller can also be equipped with a terminal block to connect communications. Specify a terminal block by adding "-X" to the model number. Example: E5AX-LA02-X

**Capable of transmitting the process value or output value, but remote setting by external input is not possible.

■ Control Output Units

Output	Relay output	SSR output	Voltage output (for driving SSR)	Current output
Model	E53-R	E53-S	E53-Q	E53-C

■ Control Input

Model	E5AX-LA					E5AX-MA		
Input (switch selectable)	Current		Voltage			Voltage		
Input range	4 to 20 mA	0 to 20 mA	1 to 5 V	0 to 5 V	0 to 1 V	0 to 100 mV	0 to 10 mV	-10 to 10 mV
Setting	0	1	2	3	4	0	1	2

■ Communications Boards

Communications	RS-232C	RS-422	RS-485	BCD	Transmission output (4 to 20 mA)
Model	E53-X01	E53-X02	E53-X03	E53-X20	E53-XF

Specifications

■ Digital Controller Ratings

Supply voltage	100 to 240 VAC, 50/60 Hz (either frequency applicable with same unit)
Operating voltage range	85% to 110% of rated supply voltage
Power consumption	Approx. 10 VA (at 100 VAC) to 15 VA (at 240 VAC) Approx. 12 VA (at 100 VAC) to 15 VA (at 240 VAC) with communication function
Input	E5AX-LA: 4 to 20 mA, 0 to 20 mA, 1 to 5 V, 0 to 5 V, 0 to 1 V E5AX-MA: 0 to 100 mV, 0 to 10 mV, -10 to 10 mV
Input impedance	Current input: 150 W Voltage input: 1 MW min.
Control output	See <i>Control Output Unit Ratings</i> .
Control mode	ON/OFF or PID control with auto-tuning
Alarm output	Relay output, 2 independent SPST-NO contacts; 3 A, 250 VAC
Setting method	Digital setting via Up and Down Keys
Indication method	Digital indications (character heights PV: 15 mm and SV: 11 mm) (Color PV: red, SV: green)
Shift set input	No voltage, contact signal input (set value shifted when ON); Contact impedance: 100 W max.
Other functions	Upper and lower limits for set value Key protection Input shift Manual output (balanceless-bumpless operation switchable) Normal and reverse output selection Shift set Scaling Watchdog timer function (Detects failures in the CPU and restores the CPU.)

Note: The control output is optically insulated from the internal circuits.

■ Control Output Unit Ratings

Relay Output Unit	E53-R	SPDT; 5 A, 250 VAC (resistive load)
SSR Output Unit	E53-S	SPST-NO; 1 A, 75 to 250 VAC (resistive load) (Leakage current is 1.5 mA max. at 200 VAC)
Voltage Output Unit (for driving SSR)	E53-Q	40 mA, 12 VDC; NPN (with short-circuit protection)
	E53-Q3	20 mA, 24 VDC; NPN (with short-circuit protection)
	E53-Q4	20 mA, 24 VDC; PNP (with short-circuit protection)
Current Output Unit	E53-C	4 to 20 mA, DC; Load: 600 W max. resolution: 212

■ Characteristics

Setting accuracy	+0.3% FS +1 digit max.
Indication accuracy	+0.3% FS +1 digit max. (Set value coincides with the indicated value, because no relative error exists between both values.)
Indication range	-10% to 110% FS
Hysteresis	0.0% to 100.0% FS (in units of 0.1% FS)
Proportional band	0.0% to 999.9% FS (in units of 0.1% FS)
Integral time	0 to 3,999 s (in units of 1 s)
Derivative time	0 to 3,999 s (in units of 1 s)
Alarm output setting range	-999 to 9999 (Decimal point is displayed at set position)
Alarm output hysteresis	0.0% to 100.0% FS (in units of 0.1% FS)
Scaling setting range	-999 to 9999 (Decimal point is displayed at set position)
Manual output setting range	0% to 100% (in units of 1%)
Control period	Pulse output: 1 to 99 s (in units of 1 s)
Sampling period	500 ms
Output refresh period	Pulse output: 500 ms Current output: 500 ms
Display refresh period	500 ms
Shift set	-999 to 9999 (Decimal point is displayed at set position)
Input shift	-999 to 9999 (Decimal point is displayed at set position)
Insulation resistance*	20 MW min. (at 500 VDC)
Dielectric strength*	2,000 VAC 50/60 Hz for 1 min between terminals of different polarity
Vibration resistance	Malfunction: 2 to 55 Hz, 2G 10 min each in X, Y, and Z directions Destruction: 10 to 55 Hz, 0.75-mm double amplitude 2 hrs each in X, Y, and Z directions
Shock resistance	Malfunction: 200 m/s ² 3 times each in 6 directions Destruction: 300 m/s ² 3 times each in 6 directions
Ambient temperature	Operating: -10% to 55°C (with no icing) Storage: -25% to 65°C (with no icing)
Ambient humidity	Operating: 35% to 85%
Memory protection	Non-volatile memory
Enclosure ratings	Front panel: IEC standard IP50 Rear case: IEC standard IP20 Terminals: IEC standard IP00
Weight	Standard: Approx. 350 g; Communications: Approx. 480 g; Mounting bracket: Approx. 50 g

*Tested with an Output Unit mounted.

■ Output Unit Characteristics

Relay unit life expectancy	Mechanical: 10,000,000 operations min. Electrical: 100,000 operations min.
-----------------------------------	---

■ Communications

Protocol		RS-232C, RS-422	RS-485	BCD	Transmission output
Transmission method		Half-duplex		Data select code	4 to 20 mA DC Load: 600 W max. Resolution: Approx. 3,200
Synchronization method		Start-stop synchronization		---	---
Baud rate		150/300/600/1,200/2,400/4,800/9,600 bps			
Transmission code		ASCII (7-bit)			
Communications	Write to Digital Controller	Main setting, set alarm value, proportional band, integral time, derivative time, AT start/stop etc.		Main setting, set alarm value	Write disabled
	Read from Digital Controller	Main setting, set alarm value, proportional band, integral time, derivative time, output value, scaling value, process value, error codes, etc.		Main setting, set alarm value, process value, error codes, etc.	Process value (see note 3), output value

- Note:**
- The maximum total cable length must not exceed the following limits.
 RS-422: 500 m; RS-232C: 15 m; RS-485: 500 m
 \$ Recommended connectors for E5AX.
 RS-485, -422, Transmission output XM4 D-sub connector (9 pin) (OMRON)
 RS-232C, BCD XM4, D-sub connector (25 pin) (OMRON)
 - A maximum of 32 Digital Controllers can be connected to one host computer using serial communications (RS-422, RS-485).
 - Outputs process value within the set limits.

Nomenclature

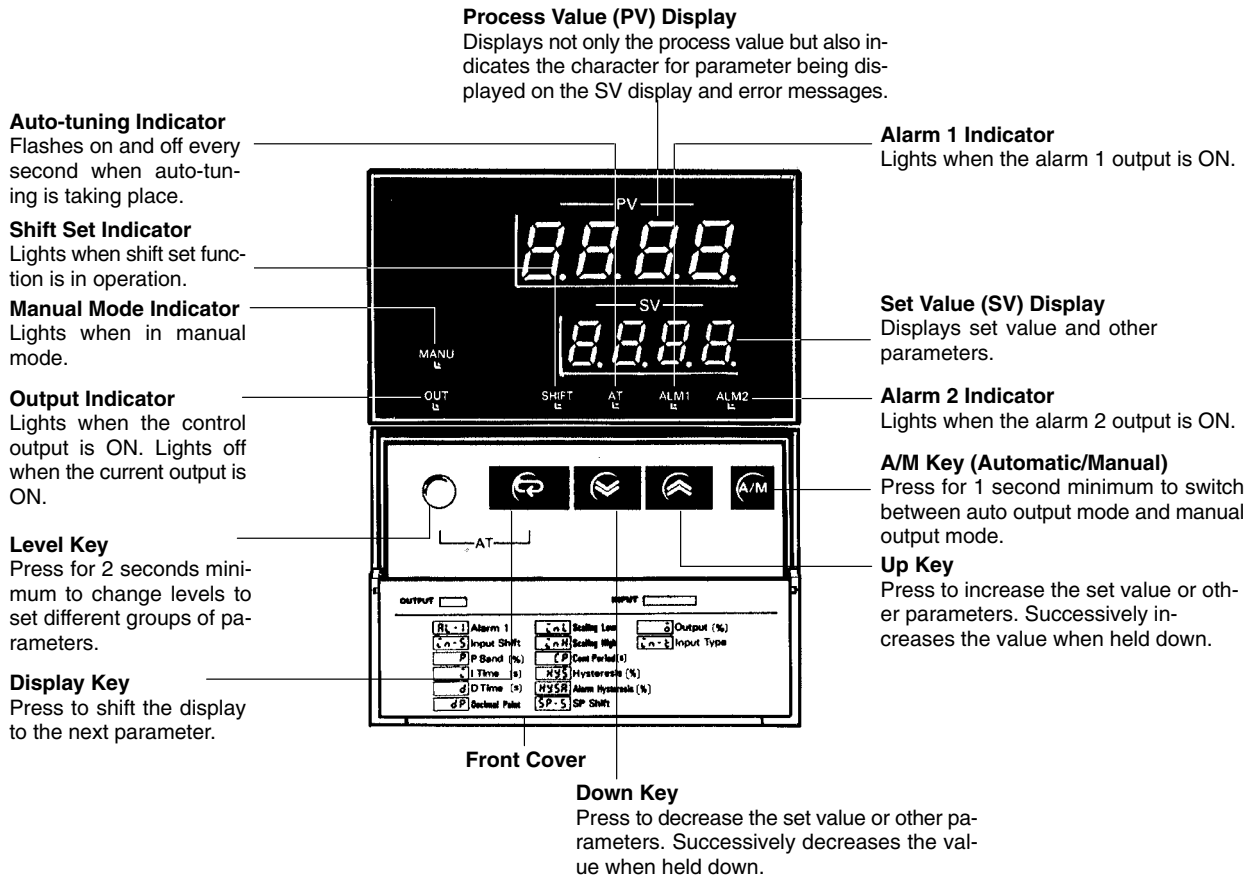

Operation

NOTICE: Always turn off power to the Digital Controller before changing any switch settings.

■ Settings

1. Remove the internal mechanism from the housing. Lift the internal mechanism while pressing the hook at the bottom of the front panel.

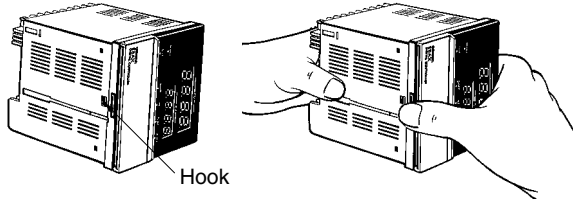

Pull out the internal mechanism while holding down the hook with your finger.

To remove a Control Output Unit, push it up with the tip of a flat-blade screwdriver as shown below.

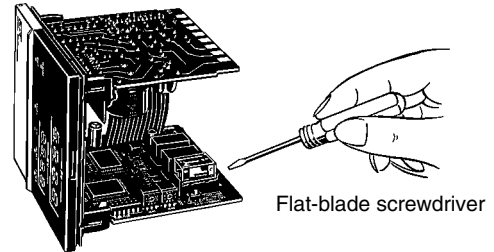

2. Connect a Control Output Unit to the vacant socket on the printed circuit board as shown below.

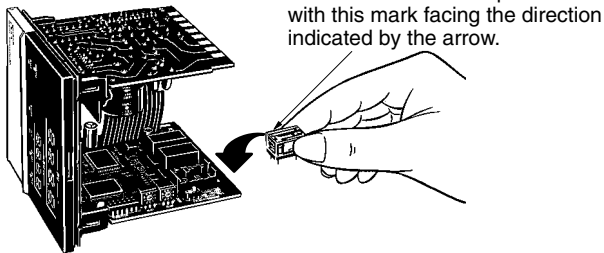

Mount the Control Output Unit with this mark facing the direction indicated by the arrow.

■ Output Selector (SW202)



Output	Setting (factory-set to OFF)
Current	ON
Pulse	OFF

Set the output selector to PUL (Pulse) when a Relay (SW202, OUT), SSR, or Voltage Output Unit is mounted. Set the output selector to CUR (current) when a Current Output Unit is mounted.

3. Four internal switches must be set on the E5AX: the input type selector, the operating mode selector, and the alarm mode selectors 1 and 2.

The figures show the locations of these switches and the protection switches on the internal mechanisms. The protection switch can be used to disable key operation.

Protection switch (SW101, PROTECT)

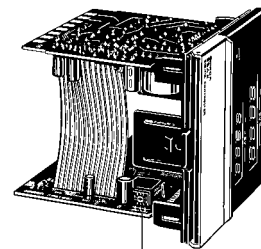
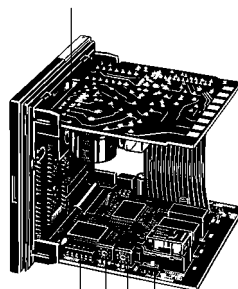

Output selector

AI (SW202, OUT) or 2 (SW203, ALM2)

Alarm mode selector 1 (SW205, ALM1)

Operating mode selector (SW 201, FUNCTION)

Input type selector (SW206, INPUT)

■ Input Selector (SW206, INPUT)

This selector selects the input to be used. It is factory-set to position 0. The following table lists the other possible settings for input.

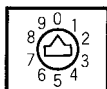

Switch setting	E5AX-LA	E5AX-MA
0	4 to 20 mA	0 to 100 mV
1	0 to 20 mA	0 to 10 mV
2	1 to 5 V	-10 to 10 mV
3	0 to 5 V	---
4	0 to 1 V	---
5	---	---
6	---	---
7	---	---
8	---	---
9	---	---

Note: Settings of 5 through 8 for LA models and settings of 3 through 8 for MA models are regarded the same as a setting of 0, i.e., 4 to 20 mA or 0 to 100 mV. A setting of 9 is regarded the same as a setting of 1 for all models, i.e., 0 to 20 mA or 0 to 10 mV.

■ Alarm Mode Selectors (SW205: ALM1; SW203: ALM2)

Alarm mode selectors are provided for all E5AX Digital Controllers. Ten alarm modes, listed in the following table, can be selected using this switch. The switch is factory-set to position 2, i.e., the upper-limit alarm mode.

■ Operating Mode Selector (SW201, FUNCTION)

This DIP switch selects the operational aspects listed in the following table.

Function	Pin number	Pin setting	Control setting
Control mode	1	ON	ON/OFF operation
		OFF	PID operation*
Control output	2	ON	Normal
		OFF	Reverse
Input shift	3	ON	Enabled
		OFF	Disabled
SP (set point)** protection cancel	4	ON	Enabled
		OFF	Disabled
Not used.***	5	Leave turned OFF.	
PID display	6	ON	Enabled
		OFF	Disabled

*PID with feed-forward circuitry.

**SP protection cancel is effective only when SW101 is ON. If the SP protection cancel is ON, key protection (SW101 ON) will not apply to the set point, i.e., you will be able to change the set point regardless of the setting of SW101.

***Always operate with pin 5 OFF. Operating with pin 5 ON could result in malfunction.

Switch setting	Mode (SW203, 205)		Alarm output		Setting range
	Alarm operation	Display	When X is positive	When X is negative	
0	No alarm	No display	OFF		---
1	Upper- and lower-limit alarm)—(---	0 to 9999
2	Upper-limit alarm	—(-999 to 9999
3	Lower-limit alarm)—			
4	Upper- and lower-limit range alarm	-()-			0 to 9999
5	Upper- and lower-limit alarm with standby sequence	3—e			
6	Upper-limit alarm with standby sequence	—e			-999 to 9999
7	Lower-limit alarm with standby sequence	3—			
8	Absolute-value alarm	1—(
9	SW205: Proportional alarm*	pro			
	SW203: No alarm	No display	OFF		

*The proportional alarm is detected when the temperature reaches the set alarm point (A in the figure on the right), which is the lower limit of a proportional band. When the temperature rises to the upper limit of the proportional band (point B in the figure), the alarm output is turned ON. This alarm function is convenient when the main setting is used for heating control, while the proportional alarm function is used for cooling control, so that heating and cooling control can be easily performed.

Note:

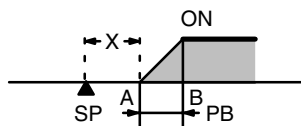

PB: proportional band (fixed to 10.0% FS)
 Proportional period is 20 seconds.
 The operation of the alarm is not affected by pin 2 of the operating mode selector (SW201).

■ Key Protection Switch (SW101, PROTECT)

When the key protection switch is set to the ON position, the Level Key, Up and Down Keys, and Auto-tuning Key cannot be operated. In effect, the Digital Controller is write-protected and the set values (such as the alarm value) can be read out only. The set point, however, will not be protected if the SP protection disable is turned ON (pin 4 of SW201).

Inputting Parameters

The Digital Controller has three display levels, 0, 1, and 2, in which only specific parameters can be set. Level 0 is the initial and is automatically entered at power application. To change the mode to set or change a different group of parameters, hold down the Level Key for 2 seconds minimum. The display level mode changes as shown below. Actual displays vary with models and switch settings. If a display does not appear as expected, check your switch settings.

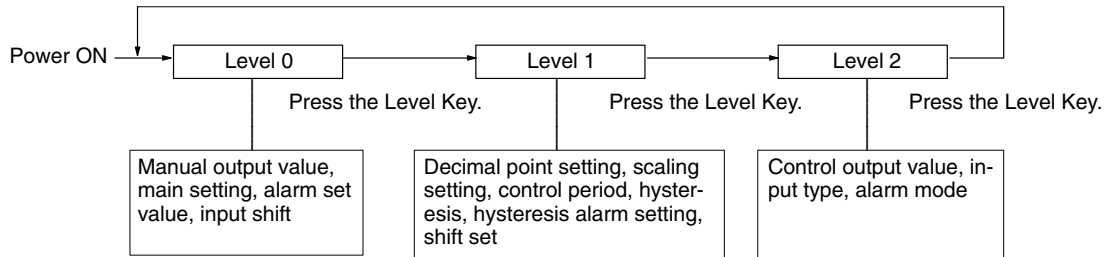

Level 0

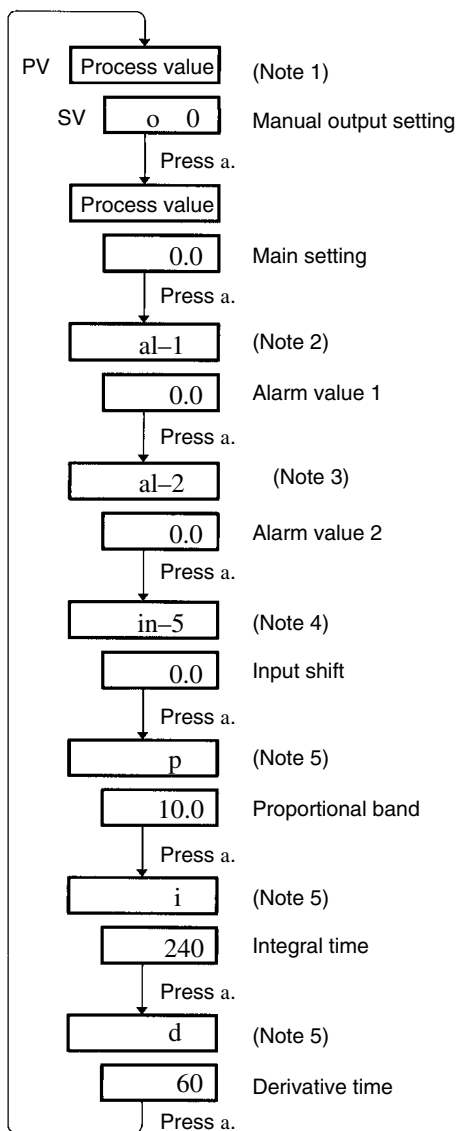

- Note:**
1. Not displayed in auto output mode.
 2. Not displayed when alarm 1 is disabled (SW205 set to 0).
 3. Not displayed when alarm 2 is disabled (SW203 set to 0 or 9).
 4. Not displayed when the input shift display is disabled (SW201, pin 3 ON).
 5. Not displayed when PID display is disabled (SW201, pin 6 ON).

Proportional Band: p

When the character *p* is displayed on the PV display, the proportional band (P constant) can be changed using the Up and Down Keys. The new value will be displayed on the SV display. It can be set in a range from 0.0 to 999.9% FS in units of 0.1% FS. The factory setting is 10.0% FS.

Integral Time (Reset Time): i

When the character *i* is displayed on the PV display, the integral time (I constant) can be changed using the Up and Down Keys. It can be set in a range from 0 to 3,999 seconds in units of 1 second. The factory setting is 240 seconds.

Derivative Time (Rate Time): d

The derivative time (D constant) can be changed when the character *d* is displayed on the PV display using the Up and Down Keys. It can be set in a range from 0 to 3,999 seconds in units of 1 second. The factory setting is 60 seconds.

Process Value

Manual output value (only in manual output mode) and main setting can be changed when process value is displayed by using the Up and Down keys.

Selecting the Output Mode

The A/M Key can be pressed for one second or longer to change between the auto and manual output modes.

Auto Output Mode

In auto output mode, the control will function automatically. When the A/M Key is pressed and the auto output mode is first entered, displays like the following will appear (display level 0).

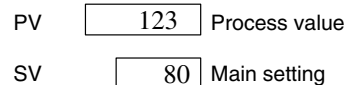

Manual Output Mode

This mode is used to turn on outputs manually. Use the Up and Down Keys to set the desired output value (as a percentage) in the SV display. About 2 seconds after the desired value is set, outputs will turn on accordingly.

If the A/M Key is pressed to switch to the manual output mode, a display like the following will appear and the MANU indicator will light.

PV Process value
 SV Set manual output value (%)

Balanceless-bumpless function prevents sudden changes in output values when the mode is changed.

Note: 1. Balanceless-bumpless function will not operate in the ON/OFF operating mode or when I is set to zero.

Alarm 1, 2 : al-1 , al-2

When al-1 or al-2 (or al) is displayed on the PV display, the alarm value for alarm output can be set on the SV display. When the value exceeds or falls below the set alarm value, the corresponding alarm output is produced and the ALM indicator on the front panel lights. Usually, the alarm value is set as a deviation from the set value, but it can also be set as an absolute value when the event alarm mode is selected. Set the alarm value by using the Up and Down Keys while al is displayed. The message is not displayed if the alarm mode selector is set to position 0. Factory-set to upper-limit, alarm value 0.0.

Input Shift: in-5

Set the input value by using Up and Down Keys while in-5 is displayed.

Input shift value	Input value	Display
0.0 (without shift)	10.0	10.0
1.0 (shifted by 1.0)	10.0	11.0
-1.0 (shifted by -1.0)	10.0	9.0

This function can be used mainly for fine tuning compensation, while leaving the set value unaffected. Select this function by pressing the Display Key three times in display level 0, as shown below.

Level 1

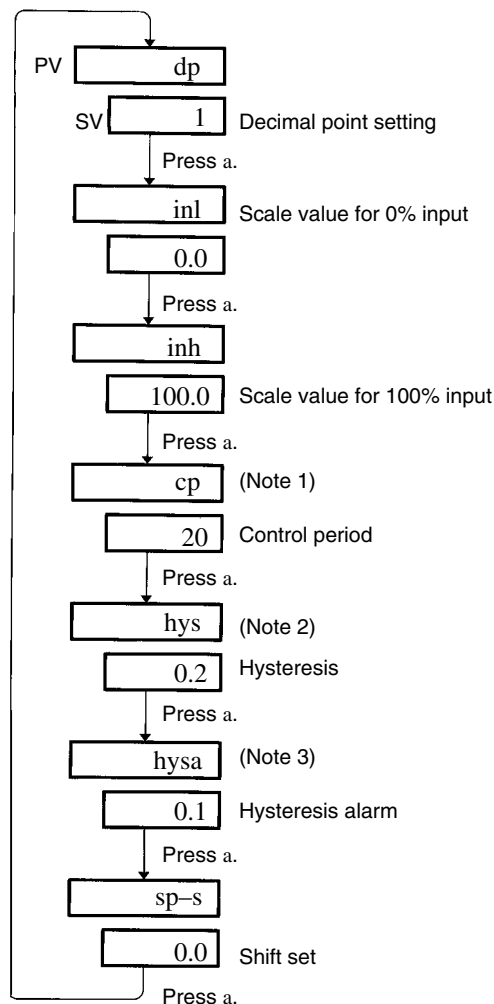

- Note:**
1. Not displayed in ON/OFF control (SW201 pin 1 ON) or current output (SW202 ON).
 2. Not displayed in PID with feed-forward control circuit (SW201 pin 1 OFF). (However, if P is 0, the display will appear.)
 3. Not displayed when the alarm 1 and 2 are disabled (SW205 set to 0, and SW203 set to 0 or 9)

If the input range is changed so that the main setting no longer lies within it, the set point will automatically be changed to in1. If main setting stays within the range, the set point will remain as it is.

If in1 is set to a value greater than or equal to inh, in1 will automatically be set to inh + 1.

If dp is set to 3, the leading zero will not be displayed for negative values, e.g., -0.023 will be displayed as -.023.

Set in1 and inh so that the difference between them (i.e., the resolution) is 5,000 or less. Otherwise, the display may not function properly.

Decimal Point: dp

Set the position of the decimal point by pressing the Up and Down Keys. A value between 0 and 3 will be displayed to indicate the position of the decimal point as shown in the following table. The decimal point is factory-set to 1.

Value of dp	Decimal point
0	1 0000
1	0.1 000.0
2	0.01 00.00
3	0.001 0.000

Scale Value for 0% Input: inl

Set the scale value for 0% input by pressing the Up and Down Keys. The value can be set between -999 and 9998 in increments of 1 and is factory-set to 0.0.

Scale Value for 100% Input: inh

Set the scale value for 100% input by pressing the Up and Down Keys. The value can be set between -inl +1 and 9999 in increments of 1 and is factory-set to 100.0.

Example:

When measuring liquid flow between 100.0 and 510.5 m³/h using a 4 to 20 mA input.

1. The decimal point is set to "1."

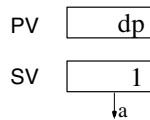

2. The 0% scale value is set to the value to be displayed for 4 mA, i.e., 100.0.

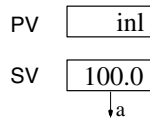

3. The 100% scale value is set to the value to be displayed for 20 mA, i.e., 510.5.

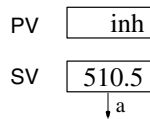

Control Period: cp

Control period for PID control with feed-forward can be set. To set the control period, pin 1 on the operating mode selector (SW201) must be set to the OFF position. When cp is displayed on the PV display, the control period can be set or changed in a range from 1 to 99 seconds in units of 1 second. The factory setting is 20 seconds. When a Voltage Output Unit is used, it is recommended that the control period be set to 20 seconds or less (ideally, about 2 seconds), so that the control operation can be performed more accurately.

Control output When control period is set to 20 seconds

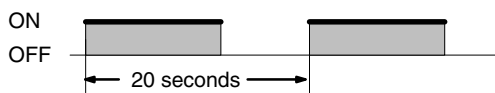

Hysteresis: hys

The hysteresis value for the ON/OFF control can be set between 0.0% and 100.0% FS while hy5 is displayed on the PV display using the Up and Down Keys. The factory setting is 0.2% FS.

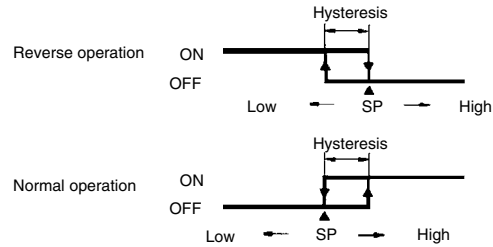

Hysteresis Alarm: hysa

The hysteresis alarm value for the alarm 1 and 2 can be set between 0.0% and 100.0% FS while hy5 is displayed on the PV display using the Up and Down Keys. The factory setting is 0.1% FS.

Shift Set: sp-s

By short-circuiting the shift set input terminal, the control value is shifted from the set value by the value input for the shift set. When sp-s is displayed, the Up and Down Keys can be pressed to set the shift set between -999 and 9999.

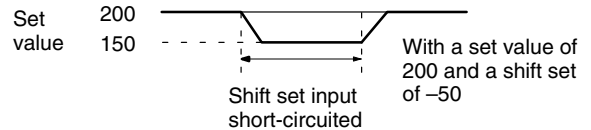

LED (SHIFT) is lit when a shift set input is short-circuited. sp-s is factory-set to 0.

Level 2

In level 2 the control output value, selected input type, and modes for alarm output can be monitored. Note that level 2 is a monitoring level only and thus no parameters can be changed. When the Level Key is pressed for 2 seconds minimum after power application, 5l-1 is displayed on the PV display. Hold down the Level Key again for 2 seconds minimum to display o on the PV display. Then the control output value, selected input sensor, and alarm modes can be monitored each time the Display Key is pressed.

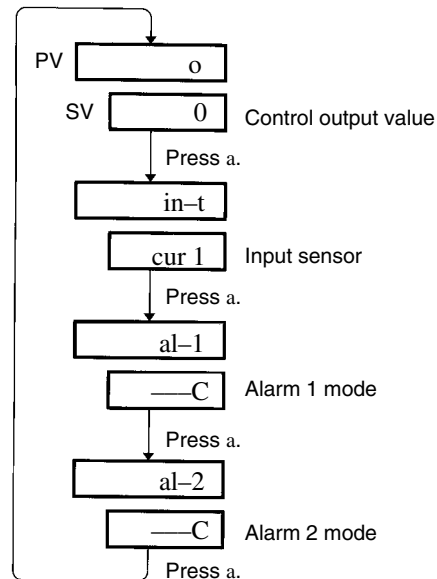

Control Output Value: o

When the Digital Controller enters level 2, the control output value is displayed on the SV display in a range of 0.0% to 100.0%.

Input Type: in-t

When in-t is displayed on the PV display, the present setting of the input type selector (SW206), is displayed on the SV display. The following table shows the messages that may be displayed:

Model	Display	Sensor
E5AX-LA	cur 1	4 to 20 mA
	cur 2	0 to 20 mA
	uol 1	1 to 5 V
	uol 2	0 to 5 V
	uol 3	0 to 1 V
E5AX-MA	uol 1	0 to 100 mV
	uol 2	0 to 10 mV
	uol 3	-10 to 10 mV

Alarm Mode: al-1, al-2

When al is displayed on the PV display in level 2, alarm output mode or the present setting of the corresponding alarm mode selector is displayed on the SV display. The following table shows the messages that may be displayed.

Display	Alarm mode
No display	No alarm
)—(Upper- and lower-limit alarm
—(Upper-limit alarm
)—	Lower-limit alarm
—(—	Upper- and lower-limit range alarm
3—e	Upper- and lower-limit alarms with standby sequence
—e	Upper-limit alarm with standby sequence
3—	Lower-limit alarm with standby sequence
1—c	Absolute-value alarm
pro	Proportional alarm

■ Starting Control Operation

The E5AX will start control operations as soon as power is turned on until power is turned off. If you don't want control operations to be performed while setting parameters, turn off the power and then turn it back on after setting the desired parameters.

Auto-tuning

When the Level Key and Mode Key are pressed simultaneously for 1 second minimum, the Digital Controller automatically starts tuning the PID constants. While auto-tuning is in operation, the auto-tuning indicator on the front panel will flash. The Digital Controller executes control based on the set PID constants (factory set to P = 10.0% FS, I = 240 seconds, and D = 60 seconds) until process value of the controlled system reaches main setting. After that, the Digital Controller automatically adjusts the PID constants using the limit cycle method. When the auto-tuning indicator turns off, the auto-tuning is terminated and PID constants are renewed.

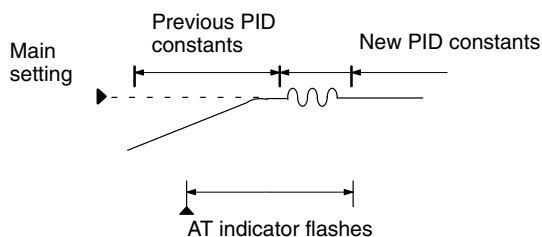

Limit cycle method: The optimum PID constants are calculated by this method by varying the control output variable and generating external oscillation.

Auto-tuning can be carried out regardless of whether the Digital Controller is performing reverse or normal operation. To stop auto-tuning, hold down the Level Key and Mode Key again simultaneously for 1 second minimum. All settings will return to those prior to the beginning of auto-tuning. Automatic tuning can be executed at any time: at power application, while the temperature is rising, or after the control action has stabilized.

■ Error Messages

The Digital Controller is provided with self-diagnostic functions, and will display an error message on the PV display when an error is detected.

Message	Cause	Control output		Alarm output
		Pulse output	Current output*	
ffff	Input value has exceeded the upper-limit of input range by 10% FS.	OFF during reverse operation ON during normal operation	4 mA during reverse operation 20 mA during normal operation	The output will turn ON according to the alarm mode for an input value that is greater than the upper limit of the input range by 10% of full scale.
——	Input value has fallen below the lower-limit of input range by 10% FS.	OFF during reverse operation ON during normal operation	20 mA during reverse operation 4 mA during normal operation	The output will turn ON according to the alarm mode for an input value that is less than the lower limit of the input range by 10% of full scale.
5.err (flashes)	The input is disconnected or shorted or the input value has greatly exceeded the input range.	OFF	Approx. 1 mA	The output will turn ON according to the alarm mode when the input goes to maximum except in the proportional alarm mode, in which it will remain OFF.
e111 (flashes) e333 (flashes)	Memory failure (e111) or A/D converter failure (e333) has occurred. Digital Controller must be repaired if recovery is not made by turning power off once and on again.	OFF	Approx. 1 mA	OFF

Note: If the display range (–999 to 9999) is exceeded, “FFFF” or “——” will be displayed.

Input Error Displays

The following displays will appear when the input is not within specifications for the various types of input.

Input		Burnout	Short	Outside input range	Exceeding input
E5AX-LA	0 4 to 20 mA	——	——	ffff (overflow) or —— (underflow)	5.err
	1 0 to 20 mA	Value of cnl	cnl		
	2 1 to 5 V	——	——		
	3 0 to 5 V	Value of cnl	cnl		
	4 0 to 1 V	Value of cnl	cnl		
E5AX-MA	0 0 to 100 mV	Value of 5.err	cnl		
	1 0 to 10 mV	Value of 5.err	cnl		
	2 –10 to 10 mV	Value of 5.err	(cni + cni)/2		

Example: If dp is 1, inl is 0.0, and inh is 100.0, the following displays will appear for burnouts or shorts.

Input		Burnout	Short
E5AX-LA	0 4 to 20 mA	——	——
	1 0 to 20 mA	0.0	0.0
	2 1 to 5 V	——	——
	3 0 to 5 V	0.0	0.0
	4 0 to 1 V	0.0	0.0
E5AX-MA	0 0 to 100 mV	5.err	0.0
	1 0 to 10 mV	5.err	0.0
	2 –10 to 10 mV	5.err	50.0

Dimensions

Note: All units are in millimeters unless otherwise indicated.

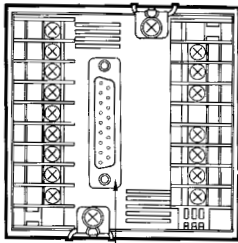
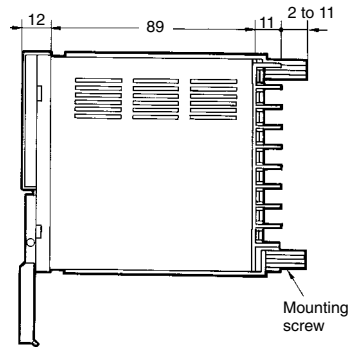
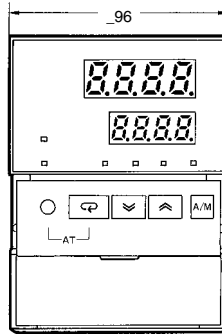
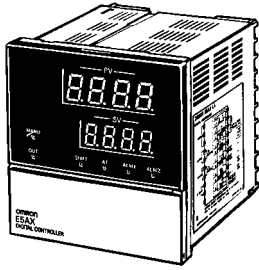

Communications connector
(RS-232C and BCD connector is shown.)

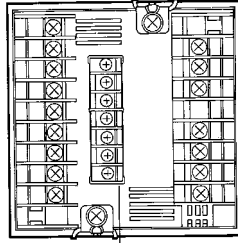

Communications board
(RS-422 and 485 terminals are shown.)

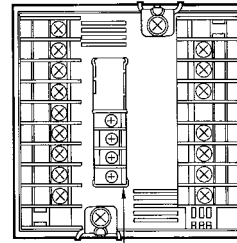
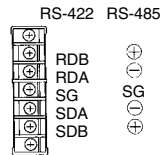

Communications board
(4 to 20 mA transmission output is shown.)

Panel Cutout

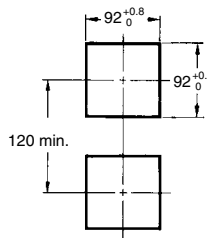

Side-by-side Mounting of N Controllers

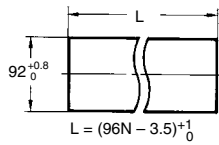

Installation

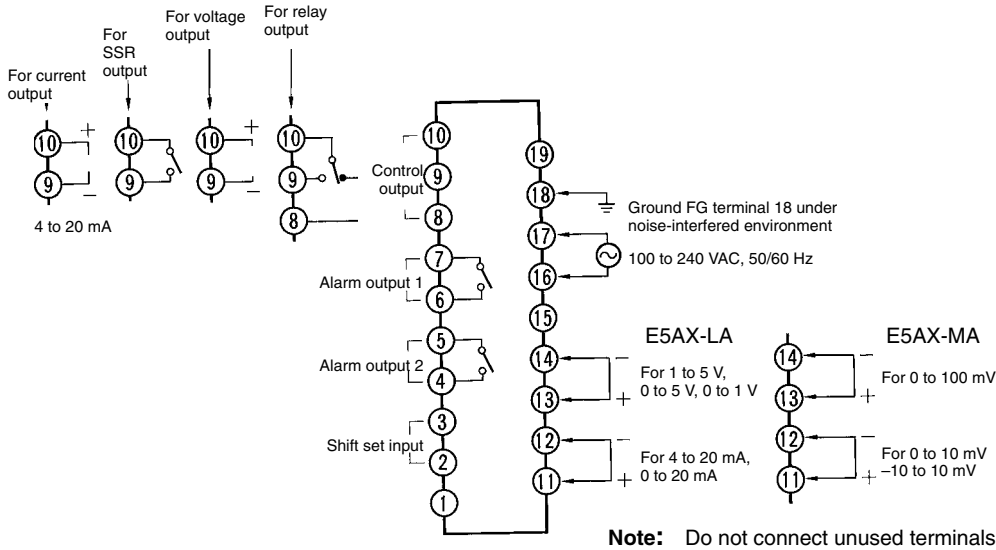

Precautions

Mounting

The dimensions of the Digital Controller conform to DIN 43700. Recommended panel thickness is 1 to 8 mm.

Do not install the Digital Controller in a location exposed to excessive dust or corrosive gases. Moreover, avoid locations subject to heavy vibration or shock, water or oil spray, or high temperatures. Any of these condition will affect product life.

Isolate the Digital Controller from equipment that generates strong, high-frequency noises such as high-frequency welders, because such equipment may prevent proper operation.

Attach the two mounting brackets supplied with E5AX on the top and bottom of the Digital Controller. Tighten the screws of the mounting brackets with your fingers.

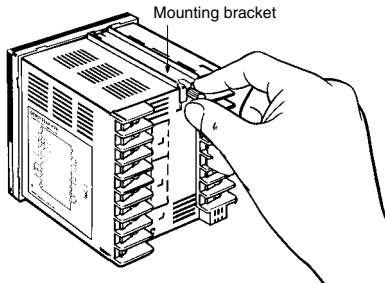

Solder-dipped Leads

Strip 6 to 12 mm of the lead wires and carefully arrange the wire tips. Do not tighten the terminal screw with excessive force, because doing so may damage them. The terminal block of the Digital Controller is constructed so that the lead wires can be connected to all the terminals from the same direction.

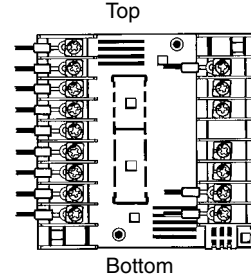

Connection Examples

With Solderless Terminal

Use M3.5 solderless terminals with the Digital Controller's M3.5 self-rising pressure plate screws.

Input Connection

To reduce inductive noise influence, the lead wires connecting the input to the Digital Controller must be separated from the power lines and load lines.

Sequenced Circuits

Several seconds are required until the relay is turned ON after power has been supplied to the Digital Controller. Therefore, take this time delay into consideration when designing sequenced circuits which incorporate a Digital Controller.

Terminal Arrangement Diagram on the Housing

The Digital Controller allows the input and output devices to be freely selected. Use the terminal arrangement diagram shown on the housing of the Digital Controller to identify the output device mounted on the Digital Controller, by marking the diagram as follows:

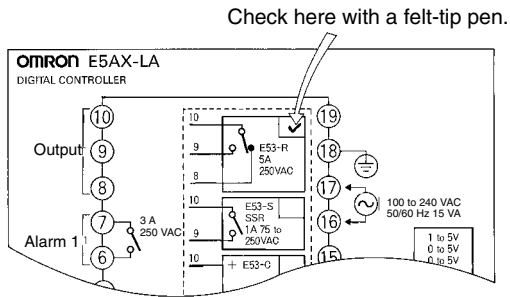

Stickers Inside Frontcover

Stickers indicating the input type and Control Output Unit (R, S, Q, and C) are supplied with the Digital Controller. Attach the proper stickers to the front panel as shown below, allowing the input type and Control Output Unit mounted in the Digital Controller to be easily identified.

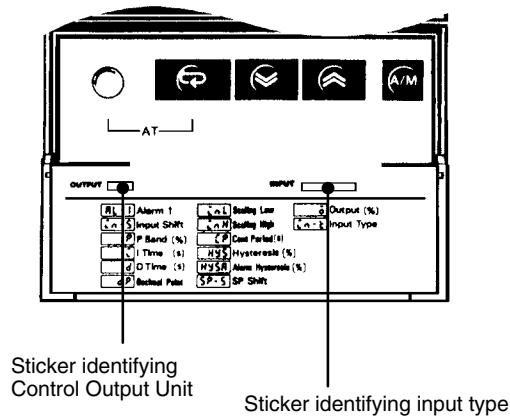

ALL DIMENSIONS SHOWN ARE IN MILLIMETERS.
 To convert millimeters into inches, multiply by 0.03937. To convert grams into ounces, multiply by 0.03527.

Cat. No. H52-E1-1A In the interest of product improvement, specifications are subject to change without notice.

OMRON Corporation
 Temperature Control Devices Division
 29th Fl., Crystal Tower Bldg.
 1-2-27, Shiromi, Chuo-ku,
 Osaka 540 Japan
 Phone: 06-949-6070 Fax: 06-949-6084

Printed in Japan
 0091-1M (0691)