

FINS Commands

Reference Manual

Produced June 1993

Notice:

OMRON products are manufactured for use according to proper procedures by a qualified operator and only for the purposes described in this manual.

The following conventions are used to indicate and classify precautions in this manual. Always heed the information provided with them. Failure to heed precautions can result in injury to people or damage to the product.

DANGER! Indicates information that, if not heeded, is likely to result in loss of life or serious injury.

WARNING Indicates information that, if not heeded, could possibly result in loss of life or serious injury.

Caution Indicates information that, if not heeded, could result in relative serious or minor injury, damage to the product, or faulty operation.

OMRON Product References

All OMRON products are capitalized in this manual. The word "Unit" is also capitalized when it refers to an OMRON product, regardless of whether or not it appears in the proper name of the product.

The abbreviation "Ch," which appears in some displays and on some OMRON products, often means "word" and is abbreviated "Wd" in documentation in this sense.

The abbreviation "PC" means Programmable Controller and is not used as an abbreviation for anything else.

Visual Aids

The following headings appear in the left column of the manual to help you locate different types of information.

Note Indicates information of particular interest for efficient and convenient operation of the product.

1, 2, 3... 1. Indicates lists of one sort or another, such as procedures, checklists, etc.

© OMRON, 1993

All rights reserved. No part of this publication may be reproduced, stored in a retrieval system, or transmitted, in any form, or by any means, mechanical, electronic, photocopying, recording, or otherwise, without the prior written permission of OMRON.

No patent liability is assumed with respect to the use of the information contained herein. Moreover, because OMRON is constantly striving to improve its high-quality products, the information contained in this manual is subject to change without notice. Every precaution has been taken in the preparation of this manual. Nevertheless, OMRON assumes no responsibility for errors or omissions. Neither is any liability assumed for damages resulting from the use of the information contained in this publication.

TABLE OF CONTENTS

SECTION 1

Introduction	1
1-1 FINS Commands	2
1-2 Network Differences	5
1-3 Command/Response Transmission Data	6
1-4 Host Link Communications	7
1-5 SYSMAC NET and SYSMAC LINK Communications	11

SECTION 2

Commands for CV-series PCs	13
2-1 Command List	14
2-2 Memory Area Designations	15
2-3 Volume Labels and File Names	18
2-4 MEMORY AREA READ	19
2-5 MEMORY AREA WRITE	20
2-6 MEMORY AREA FILL	21
2-7 MULTIPLE MEMORY AREA READ	21
2-8 MEMORY AREA TRANSFER	23
2-9 PARAMETER AREA READ	23
2-10 PARAMETER AREA WRITE	25
2-11 PARAMETER AREA CLEAR	26
2-12 PROGRAM AREA PROTECT	27
2-13 PROGRAM AREA PROTECT CLEAR	28
2-14 PROGRAM AREA READ	28
2-15 PROGRAM AREA WRITE	29
2-16 PROGRAM AREA CLEAR	30
2-17 RUN	30
2-18 STOP	31
2-19 CONTROLLER DATA READ	31
2-20 CONNECTION DATA READ	33
2-21 CONTROLLER STATUS READ	33
2-22 CYCLE TIME READ	35
2-23 CLOCK READ	36
2-24 CLOCK WRITE	36
2-25 MESSAGE READ	37
2-26 MESSAGE CLEAR	38
2-27 FAL/FALS READ	39
2-28 ACCESS RIGHT ACQUIRE	40
2-29 ACCESS RIGHT FORCED ACQUIRE	40
2-30 ACCESS RIGHT RELEASE	41
2-31 ERROR CLEAR	42
2-32 ERROR LOG READ	43
2-33 ERROR LOG CLEAR	44
2-34 FILE NAME READ	44
2-35 SINGLE FILE READ	46
2-36 SINGLE FILE WRITE	46
2-37 MEMORY CARD FORMAT	47
2-38 FILE DELETE	47
2-39 VOLUME LABEL CREATE/DELETE	48
2-40 FILE COPY	49
2-41 FILE NAME CHANGE	49
2-42 FILE DATA CHECK	50

TABLE OF CONTENTS

2-43	MEMORY AREA FILE TRANSFER	50
2-44	PARAMETER AREA FILE TRANSFER	52
2-45	PROGRAM AREA FILE TRANSFER	53
2-46	FORCED SET/RESET	54
2-47	FORCED SET/RESET CANCEL	55
2-48	Aborting Commands	55
SECTION 3		
Commands for C-series PCs		57
3-1	Command List	58
3-2	Memory Area Designations	58
3-3	MEMORY AREA READ	60
3-4	MEMORY AREA WRITE	61
3-5	MULTIPLE MEMORY AREA READ	61
3-6	PROGRAM AREA READ	62
3-7	PROGRAM AREA WRITE	63
3-8	RUN	63
3-9	STOP	64
3-10	CONTROLLER DATA READ	64
3-11	CONTROLLER STATUS READ	65
3-12	CLOCK READ	66
3-13	CLOCK WRITE	67
3-14	ERROR CLEAR	67
3-15	FILE MEMORY INDEX READ	68
3-16	FILE MEMORY READ	68
3-17	FILE MEMORY WRITE	69
3-18	FORCED SET/RESET	70
3-19	FORCED SET/RESET CANCEL	71
3-20	MULTIPLE FORCED STATUS READ	71
SECTION 4		
Commands for SYSMAC NET Link Units		73
4-1	Command List	74
4-2	DATA LINK TABLE READ	74
4-3	DATA LINK TABLE WRITE	75
4-4	RUN	77
4-5	STOP	77
4-6	RESET	78
4-7	CONTROLLER DATA READ	78
4-8	CONTROLLER STATUS READ	78
4-9	DATA LINK STATUS READ	79
4-10	LOOP-BACK TEST	80
4-11	ERROR LOG READ	81
4-12	ERROR LOG CLEAR	82
4-13	NAME SET	82
4-14	NAME DELETE	82
4-15	NAME READ	83

TABLE OF CONTENTS

SECTION 5

Commands for SYSMAC LINK Units	85
5-1 Command List	86
5-2 RUN	86
5-3 STOP	86
5-4 CONTROLLER DATA READ	87
5-5 CONTROLLER STATUS READ	88
5-6 NETWORK STATUS READ	90
5-7 DATA LINK STATUS READ	91
5-8 INTERNODE ECHO TEST	92
5-9 BROADCAST TEST RESULTS READ	93
5-10 BROADCAST TEST DATA SEND	93
5-11 ERROR LOG READ	94
5-12 ERROR LOG CLEAR	95

SECTION 6

Commands for Personal Computer Units	97
6-1 Command List	98
6-2 CONTROLLER DATA READ	98
6-3 CLOCK READ	98
6-4 CLOCK WRITE	99
6-5 INTERNODE ECHO TEST	99
6-6 ERROR LOG READ	100
6-7 ERROR LOG CLEAR	101

SECTION 7

Commands for BASIC Units	103
7-1 Command List	104
7-2 CONTROLLER DATA READ	104
7-3 CONTROLLER STATUS READ	105
7-4 ERROR LOG READ	105
7-5 ERROR LOG CLEAR	106

SECTION 8

Response Codes	107
8-1 Configuration	108
8-2 Network Relay Errors	108
8-3 Response Codes and Troubleshooting	108

Appendices

A FINS Command List	115
Index	117
Revision History	121

About this Manual:

This manual describes the FINS commands used for communications in OMRON networks and includes the sections described below. These FINS commands can be addressed to CV-Series PCs, C-series PCs, SYSMAC NET Link Units, SYSMAC LINK Units, SYSMAC LINK Support Boards, and CPU Bus Units, such as Personal Computer Units and BASIC Units. They can also be sent to host computers, provided the proper programming is provided at the host computer.

Please read this manual carefully and be sure you understand the information provided before attempting to program communications in OMRON networks.

WARNING Failure to read and understand the information provided in this manual may result in personal injury or death, damage to the product, or product failure. Please read each section in its entirety and be sure you understand the information provided in the section and related sections before attempting any of the procedures or operations given.

Section 1 describes the structure and use of FINS commands.

Section 2 describes commands that can be addressed to CV-series PCs.

Section 3 describes commands that can be addressed to C-series PCs.

Section 4 describes commands that can be addressed to SYSMAC NET Link Units.

Section 5 describes commands that can be addressed to SYSMAC LINK Units and Support Boards.

Section 6 describes commands that can be addressed to Personal Computer Units.

Section 7 describes commands that can be addressed to BASIC Units.

Section 8 describes response codes, which are returned with responses to FINS commands to indicate the result of FINS command execution.

Appendix A provides a list of FINS commands and shows the destinations that support each command.

SECTION 1

Introduction

This section explains the structure of the FINS command systems used to communicate in SYSMAC NET Link, SYSMAC LINK, and Host Link Systems.

1-1	FINS Commands	2
1-1-1	Communications Range	2
1-1-2	Destinations	3
1-1-3	Destinations and Commands	4
1-1-4	Data Formats	4
1-2	Network Differences	5
1-3	Command/Response Transmission Data	6
1-4	Host Link Communications	7
1-4-1	Command Format	8
1-4-2	Response Block Format	9
1-4-3	Frame Checksum Calculation	10
1-5	SYSMAC NET and SYSMAC LINK Communications	11
1-5-1	Parameters	11
1-5-2	Data Formats	11

1-1 FINS Commands

There are two command systems that can be used for communications with CV-series PCs. The first system is the C-series command system, which can be used within any one local network. The other system is the CV-series command system, which uses FINS commands.

The structure of C-series commands, also called C-mode commands, differs depending on the type of network in which they are used, and thus do not allow communications to remote networks. FINS commands, also called CV-mode commands, do allow internetwork communications between network PCs or computer nodes. This manual describes the FINS command system.

Functional Names

The SYSMAC NET Link System and SYSMAC LINK System use different names to describe the command/response functionality used for FINS commands. SYSMAC NET Link Systems call this functionality the datagram service; SYSMAC LINK Systems call it the message service. Although different names are used, the command structure is identical for both Systems.

Gateway

A gateway is a node that allows communications to be transferred between two networks. There are basically two types of gateways: 1) a PC or computer node that is a member of two networks (i.e., that has two network Link Units or Support Boards) and 2) a Bridge, which is a Unit specifically designed to function as a gateway.

1-1-1 Communications Range

Using FINS commands, a network node can communicate with nodes on three network levels: nodes on a local network, nodes on networks connected directly via a gateway, and nodes on networks separated by one other network (i.e., connected via two gateways).

For example, in the following diagram PCs (a) and (b) can communicate with each other, but PCs (a) and (c) cannot. A directly link between a PC and a host computer via a Host Link System, however, is not counted as a network and thus PC (a) and host computer (d) can also communicate with each other.

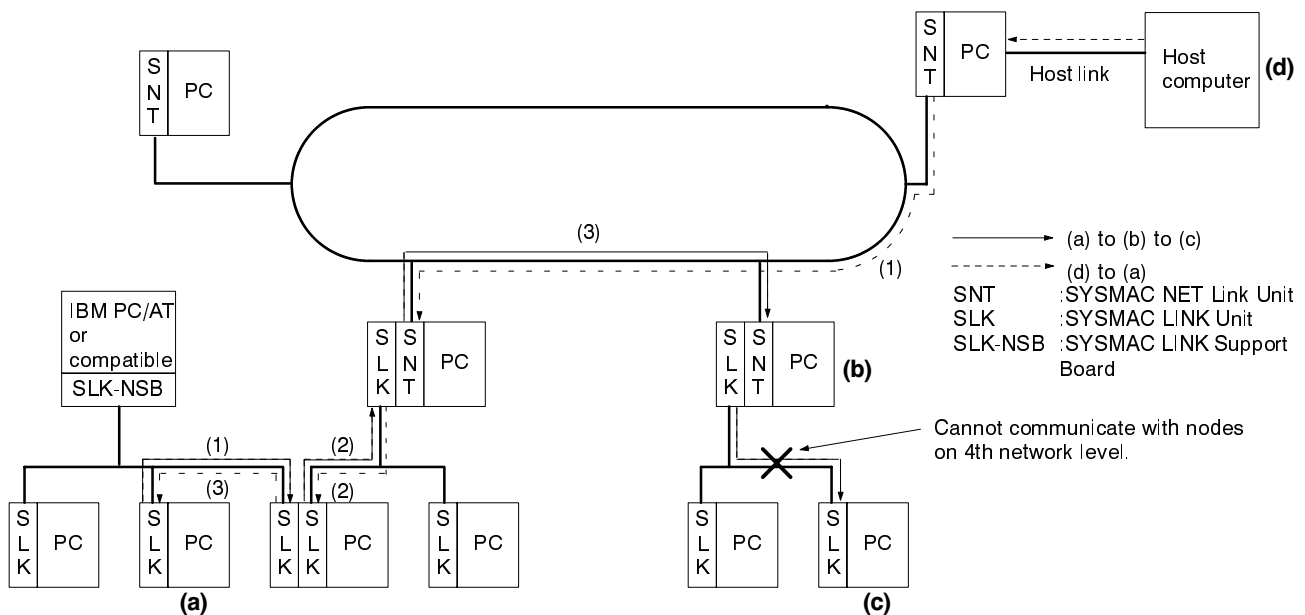

1-1-2 Destinations

FINS commands use a command/response system in which a command is sent along with parameters (including the destination node) and a response is returned by the destination node. It is also possible to specify command parameters so that a response is not returned if one is not needed. Commands can also be broadcast locally, i.e., sent to every node on a local network.

Internode Communications

Communications are possible with a PC, computer, or CPU Bus Unit at a specific node on a specific network by specifying the network address, node number, and unit address of the destination, as shown in the following illustration.

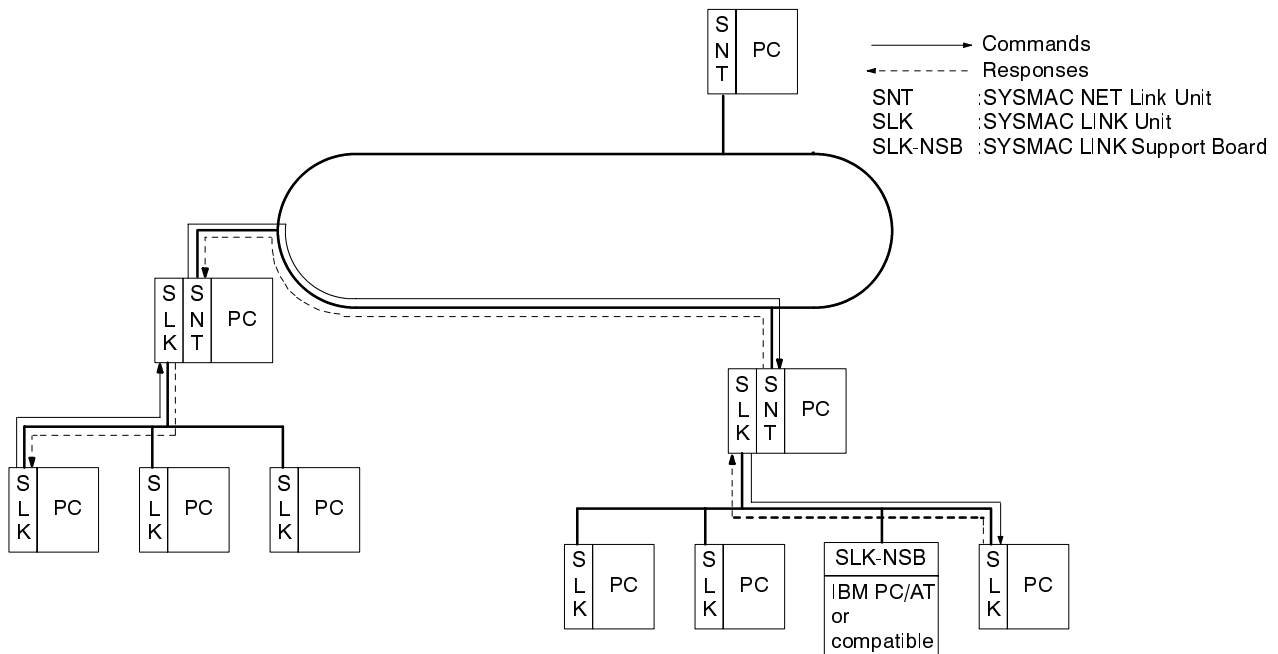

Broadcasting

If FF (decimal 255) is specified as the destination node number, a command will be broadcast to all nodes on the designated network. Responses are not returned for broadcast communications.

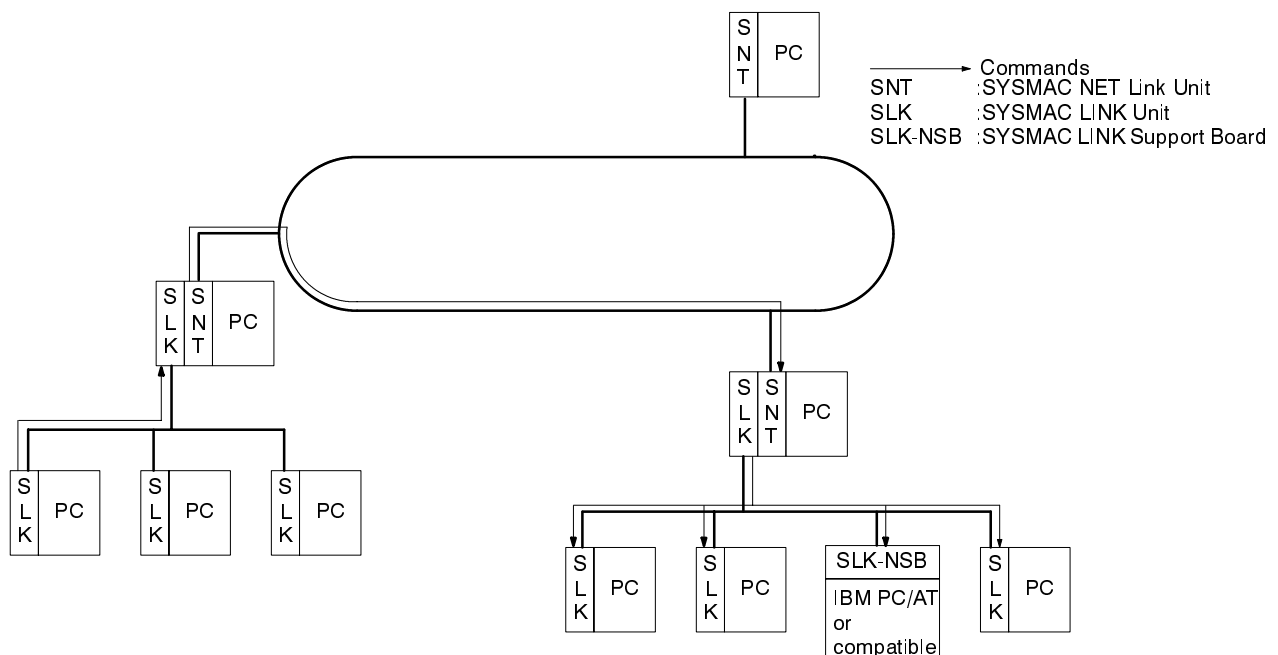

Unit Addresses

Unit addresses are used to designate the actual Units that are to participate in FINS communications. Unit addresses are required because communications are possible with more than one Unit at each node.

When a network node is occupied by a PC, communications are possible with the PC's CPU or with a CPU Bus Unit mounted to the PC. The unit addresses used to distinguish between these are given in the following table.

Destination	Unit address
PC's CPU	00
CPU Bus Units (see note 1)	10 + unit number or FE (see note 2)

- Note**
1. Communications are possible with the following CPU Bus Units: SYSMAC NET Link Units, SYSMAC LINK Units, SYSMAC BUS/2 Units, Personal Computer Units, and BASIC Units.
 2. FE is used for SYSMAC NET Link and SYSMAC LINK Units to specify the Unit actually connecting the destination node to the network and can be used to communicate with such Units without having to worry about unit numbers.

When a network node is occupied by an IBM PC/AT or compatible connected via a SYSMAC LINK Support Board, the unit addresses given in the following table are used.

Destination	Unit address
User application on the computer	01
SYSMAC LINK Support Board	10 or FE (see note 1)

- Note**
1. The unit number of the SYSMAC LINK Support Board is fixed at 0, i.e., "10" is 10 plus the unit number. FE is used to specify the Unit actually connecting the destination node to the network, i.e., the SYSMAC LINK Support Board, without regard to the unit number.
 2. User applications must be written to return responses if desired or commands must be set without requests for responses.

1-1-3 Destinations and Commands

The actual function of a command can vary with the destination to which the command is sent. For example, command code 04 02 when sent to a PC will change the operating mode from RUN to PROGRAM, but when sent to a SYSMAC LINK Unit will stop a data link. The parameters and data provided for a command and those returned in the response can also differ depending on the destination of the command. You must therefore always be aware of the specific destination to which the command is being sent to use commands correctly. A table of FINS commands and their destinations is provided in *Appendix A FINS Command List*.

- Note** Although commands can be sent to and from user applications in IBM PC/AT or compatibles, all programming for commands and responses must be written into user applications.

1-1-4 Data Formats

The type of data that each network can handle varies as shown in the following table. This manual shows mainly binary codes (expressed in hexadecimal).

SYSMAC NET Link System	SYSMAC LINK System	Host Link System
Binary or ASCII (see note)	Binary only	ASCII only

- Note** SYSMAC NET Link Systems can be set to handle either binary data or ASCII data, but not both. If high-speed or high-quantity communications are required, use binary communications. The setting is made in the PC from the CVSS. Refer to the *CVSS Operation Manuals* for details.

Binary-ASCII Conversions

Each byte of binary data is split into two bytes of ASCII, each of which represents only character as shown below.

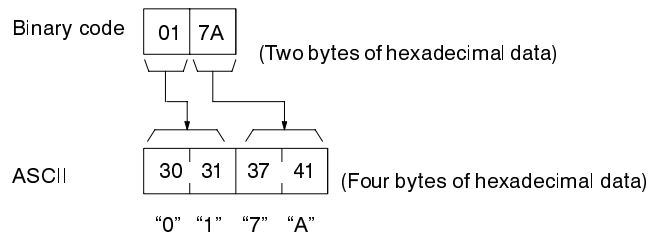

When ASCII is used for FINS communications, the hexadecimal code, and not the actual characters, are used. File names and other ASCII data are expressed in hexadecimal as shown in the following example.

Example: The file name "ASCII.DAT" is represented as shown below.

	A	S	C	I	I	.	D	A	T
Binary:	41	53	43	49	49	20	20	20	2E 44 41 54
ASCII									
In Computer:	415343494920202020E444154								
In PC;	34 31 35 33 34 33 34 39 34 39 32 30								
	32 30 32 30 32 45 34 34 34 31 35 34								

1-2 Network Differences

FINS commands can be used for communications in three different types of network: Host Link, SYSMAC NET, and SYSMAC LINK. These are shown in the following diagram.

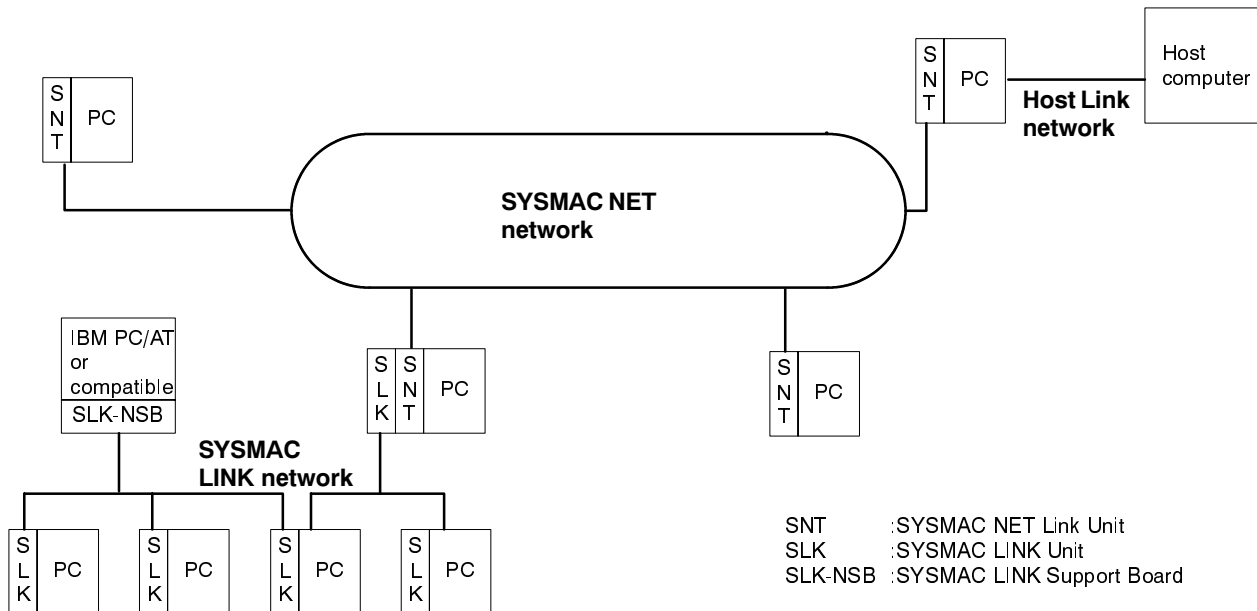

There are some differences in communications depending on the type of network the FINS commands are used in. These differences are listed in the following table.

Item	SYSMAC NET	SYSMAC LINK	Host Link
Code (see note 1)	Binary or ASCII	Binary only	ASCII only
Maximum data length (see note 2)	Binary: 1,990 bytes ASCII: 990 bytes	542 bytes	542 bytes
Baud rate	2 Mbps	2 Mbps	1200, 2400, 4800, 9600, or 19200 bps
Maximum number of nodes	126 (see note 3)	62 nodes	RS-232C: 1 node only RS-422: 32 nodes
Destination nodes	PCs, IBM PC/AT compatibles, or CPU Bus Units	PCs, IBM PC/AT compatibles, or CPU Bus Units	PCs only

- Note**
1. All nodes within any one network must be set to the same code. Networks connected via gateways may use different codes, i.e., code is automatically converted as necessary in internetwork communications.
 2. This is the maximum length from command code through text for internetwork communications. Slightly longer communications are possible in local communications. Refer to the operation manuals for individual systems for details.
 3. Not including a Line Server.

1-3 Command/Response Transmission Data

This section describes the structure of the header data used for FINS commands and responses.

Although parameters are used to designate the source, the destination, and other required information when using PC instructions (e.g., CMND(194)) for network communications (and thus automatically generate a header), other Units require that a header be manually added before the command code. Refer to the operation manual for individual systems to determine if a header is required. The header format described below is attached before the command code and the other parameters described for individual commands in the rest of this manual.

Command Data Structure

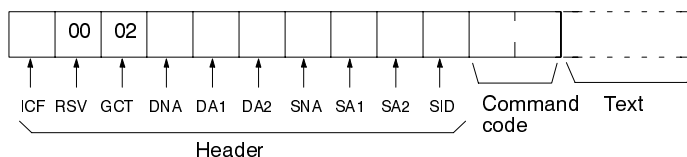

Response Data Structure

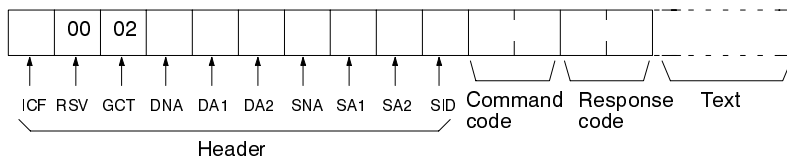

Details

ICF

Information control field. Individual bits of the ICF are used as follows:

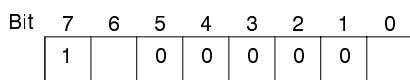

- Response setting (0: response required; 1: response not required)
- Data type (0: command; 1: response)
- Gateway usage (0: don't use; 1: use); set to 1.

RSV	Reserved. Set to 00.
GCT	Gateway count. Set to 02.
DNA	Destination network address. Specify within the following ranges. 00: Local network 01 to 7F: Remote network (1 to 127 decimal)
DA1	Destination node number. Specify within the following ranges. 01 to 7E: Node number in SYSMAC NET network (1 to 126 decimal) 01 to 3E: Node number in SYSMAC LINK network (1 to 62 decimal) FF: Broadcast transmission
DA2	Destination unit address. Specify within the following ranges. 00: PC (CPU) FE: SYSMAC NET Link Unit or SYSMAC LINK Unit connected to network 10 to 1F: CPU Bus Unit (10 + unit number in hexadecimal)
SNA	Source network address. Specify within the following ranges. 00: Local network 01 to 7F: Remote network (1 to 127 decimal)
SA1	Source node number. Specify within the following ranges. 01 to 7E: Node number in SYSMAC NET network (1 to 126 decimal) 01 to 3E: Node number in SYSMAC LINK network (1 to 62 decimal) FF: Broadcast transmission
SA2	Source unit address. Specify within the following ranges. 00: PC (CPU) FE: SYSMAC NET Link Unit or SYSMAC LINK Unit connected to network 10 to 1F: CPU Bus Unit (10 + unit number in hexadecimal)
SID	Service ID. Used to identify the processing generating the transmission. Set the SID to any number between 00 and FF

Note The unit address for a CPU Bus Unit is 10 (hexadecimal) plus the unit number set on the front panel of the CPU Bus Unit.

1-4 Host Link Communications

The following header must be attached to all FINS commands and responses sent from a host computer using a Host Link System.

All commands and responses in Host Link Systems are transmitting in ASCII. Two ASCII characters represents one byte of data.

1-4-1 Command Format

The command block format for CV-mode commands in Host Link Systems is shown below. The entire length of each block must be 1,114 characters or less. Commands blocks for longer commands must be split into frames.

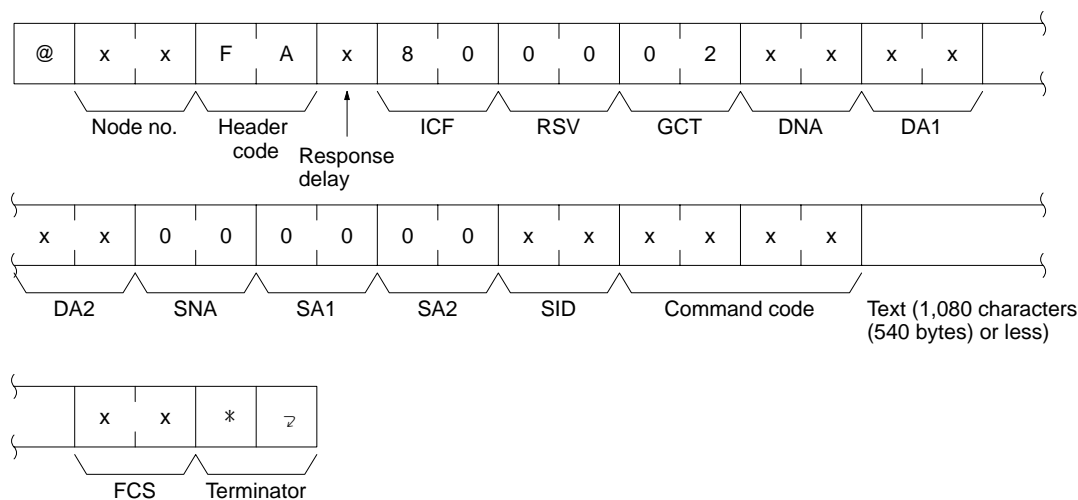

Node Number The node number of the destination is input in BCD. The node number is set in the PC Setup for CV-series PCs and is between 00 and 31.

Note The node number of the PC's host interface is called the "unit number" in the PC Setup and is functionally the same as the node number set on Host Link Units and other network nodes.

Header Code Always use FA (ASCII 46, 41) as the header code for FINS commands.

Response Delay It is possible to specify the response delay of a PC in 10-ms increments. Selecting 0 through F in hexadecimal sets the time required for a PC to respond to the host computer after the PC receives a command block from the host computer.

Example:

If F (15 in decimal) is set, there will be a delay of 150 ms before the response is sent.

ICF Set to 80 (ASCII 38, 30).

RSV Set to 00 (ASCII 30, 30).

GCT Set to 02 (ASCII 30, 32).

DNA, DA1, DA2 DNA, DA1, and DA2 specify the destination to which the data is sent.
DNA: Set to 00 through 7F hexadecimal (0 to 127 decimal) to specify the network address.

DA1: Set to 01 through 3E hexadecimal to specify the node number. The node number is between 01 and 7F (1 to 126 decimal) for SYSMAC NET Link Units, between 01 and 3E (1 to 62 decimal) for SYSMAC LINK Units, and between 00 and 1F (0 to 31 decimal) for Host Link Units.

DA2: Set the unit address. Set to 00 (ASCII 30, 30) to indicate the CPU. (The host interface assumes it is communicating with the CPU.) The unit address is not the same as the unit number (i.e., node number) set in the PC Setup.

SNA, SA1 Always set to 00 (ASCII 30, 30) to specify the local network and node number as the source of the transmission.

SA2 Set to FC (ASCII 46, 43) to specify the unit address of the host interface. (Even if 00 (ASCII 30, 30) is set to indicate the CPU, it will be internally converted to FC.) The unit address is not the same as the unit number (i.e., node number) set in the PC Setup.

SID	Used as a counter when data is resent. Usually set to 00 (ASCII 30, 30).
Command Code and Text	Provide the proper command code and text for the desired command.
FCS	The frame check sequence used to detect errors caused by noise. Refer to page 10 for details.
Terminator	A code designating the end of the command or response. Use “*r” (ASCII 2A, 0D).

1-4-2 Response Block Format

The response block format for CV-mode commands in Host Link Systems is shown below. The entire length of each block must be 1,115 characters or less.

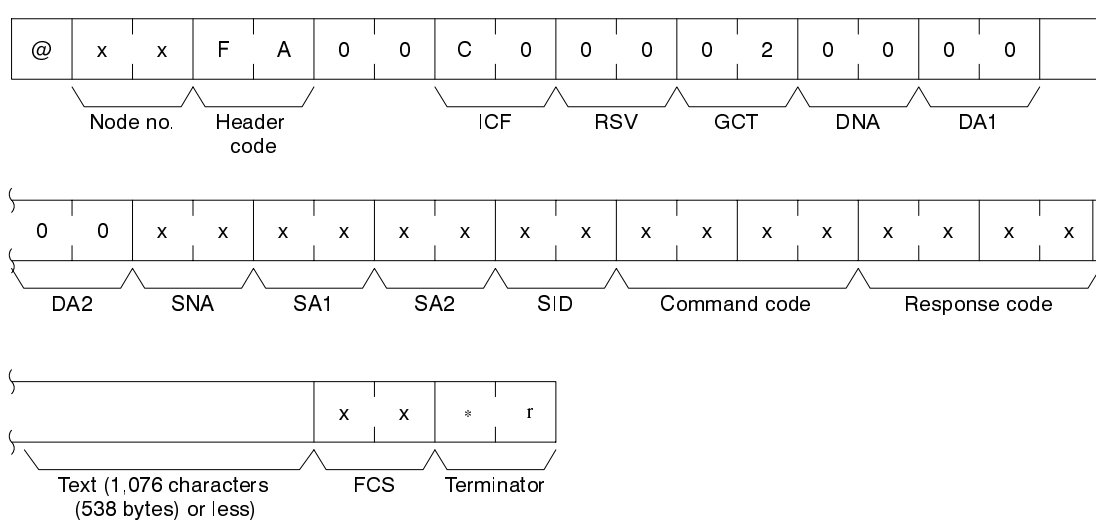

Node Number	The contents set in the command block format will be returned.
Header Code	The contents set in the command block format will be returned.
ICF	Set to C0 (ASCII 43, 30) .
RSV, GCT	The contents set in the command block format will be returned.
DNA, DA2	The contents of SNA and SA2 set in the command block format will be returned.
DA1	The node number that has relayed the data will be returned.
SNA, SA1, SA2	The contents of DNA, DA1, and DA2 set in the command block format will be returned.
SID	The contents set in the command block format will be returned.
Command Code, Response Code, and Text	The command code, response code, and text for the command that has been executed.
FCS	The frame check sequence used to detect errors caused by noise. Refer to page 10 for details.
Terminator	A code designating the end of the command or response. Use “*r” (ASCII 2A, 0D).

Note A response can consist of 1,115 characters maximum and the number of characters used for text must be 1,076 character (538 bytes) maximum.

1-4-3 Frame Checksum Calculation

The frame checksum (FCS) is an 8-bit value converted into two ASCII characters. The 8-bit value is the result of an EXCLUSIVE OR sequentially performed between each character in a transmission, from the first character in the frame to the last character of the text in that frame. The FCS can be used in program transmission to confirm that a command or response has been properly received.

Example	@ 10	RR	00310001	42	* r
	Node No.	Header code	Text	FCS	Terminator
	@	0100	0000		
			EOR		
	1	0011	0001		
			EOR		
	0	0011	0000		
			EOR		
	R	0101	0010		
			⋮		
	0	0011	0000		
	1	0011	0001		
	Result	0100	0010		
		4	2	Converted to hexadecimal and treated as ASCII	

FCS Calculation Program

The following program is an example of how frame checksum calculations can be performed on received data.

```

400 *FCSCHECK
405 L=LEN(RESPONSE$) ..... Transmit/receive data
410 Q=0:FCCK$=""
415 A$=RIGHT$(RESPONSE$, 1)
417 PRINT RESPONSE$, A$, L
420 IF A$="*" THEN LENG$=LEN(RESPONSE$)-3 ELSE LENG$=LEN(RESPONSE$)-2
430 FCSP$=MID$(RESPONSE$, LENG$+1, 2) .... Receive FCS data
440 FOR I=1 TO LENG$ ..... Number of characters in FCS calculation range.
450 Q=ASC(MID$(RESPONSE$, I, 1)) XOR Q
460 NEXT I
470 FCSD$=HEX$(Q) ..... FCS calculation result
480 IF LEN(FCSD$)=1 THEN FCSD$="0"+FCSD$
490 IF FCSD$<>FCSP$ THEN FCCK$="ERR"
495 PRINT "FCSD$=";FCSD$, "FCSP$=";FCSP$, "FCCK$=";FCCK$
500 RETURN

```

- Note**
1. Received data contains an FCS, delimiter/terminator, etc. If the data is not received normally, however, any of these parts may be missing or corrupted. Be sure to allow for the possibility of missing or corrupted data when receiving data at the host.
 2. In this example, the code for CR (CHR\$(13)) is not included in RESPONSE\$. Modify lines 415 and 420 to include the code for CR.

Example: Setting DNA, DA1, and DA2

The settings of DNA, DA1, and DA2 for relaying communications through the following networks are given below.

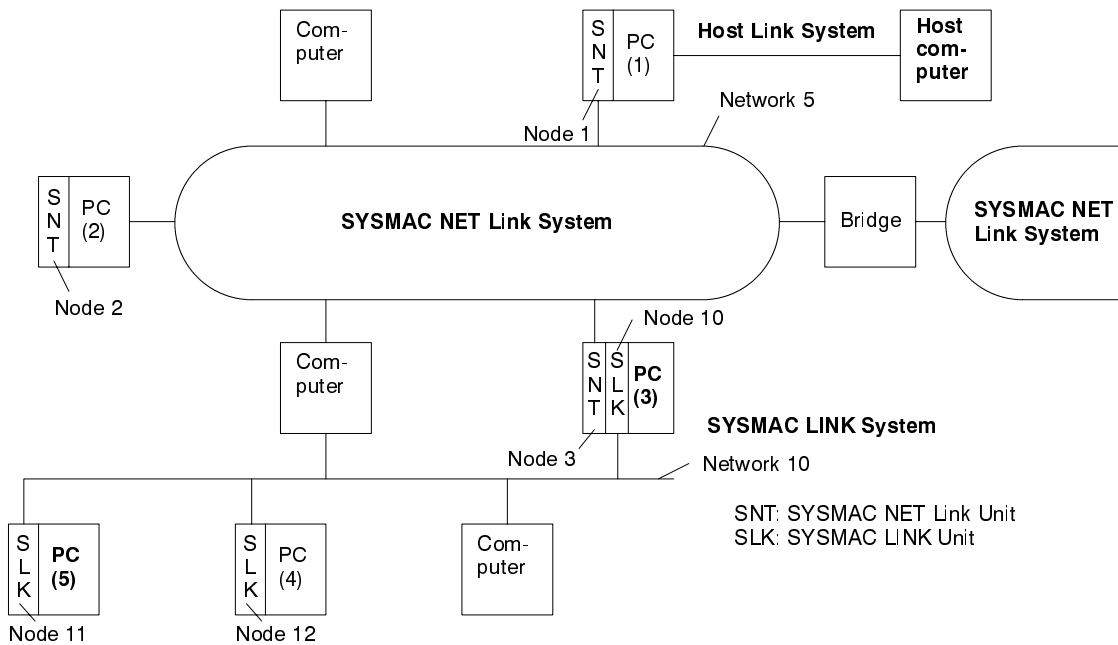

Sending Commands to PC (3) DNA: Set to 05 (30, 35) for the network address.
 DA1: Set to 03 (30, 33) for the node number of the SYSMAC NET Link Unit of PC (3).
 DA2: Set to 00 (30, 30) for the unit address of the PC.

Sending Commands to PC (4) DNA: Set to 0A (30, 41) (binary code) to specify network 10.
 DA1: Set to 0C (30, 43) (binary code) to specify node 12, i.e., the SYSMAC LINK Unit of PC (5).
 DA2: Set to 00 (30, 30) for the unit address of the PC.

1-5 SYSMAC NET and SYSMAC LINK Communications

Commands can be sent and received through SYSMAC NET and SYSMAC LINK Systems using PC instructions (e.g., CMND(194)) in the PC program. The designation network, node, unit address, and other parameters are specified as operands, making it possible to use FINS commands without direct concern with header information, which is automatically generated when the transmission is executed. This is also possible for Host Link Systems connected through Host Link Units (but not through the PC host interface).

1-5-1 Parameters

All parameters are specified in hexadecimal unless otherwise specified.

1-5-2 Data Formats

Commands

The command code and text for the command are stored in memory as operands and the transmission is executed using the required parameters. The specific method depends on the programming method being used.

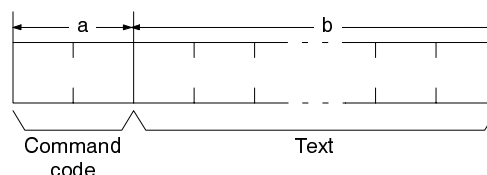

System	Binary	ASCII
SYSMAC NET	a: 2 bytes b: 0 to 1,988 bytes	a: 2 bytes b: 0 to 988 bytes
SYSMAC LINK	a: 2 bytes b: 0 to 540 bytes	Not applicable
Host Link	Not applicable	a: 2 bytes b: 0 to 540 bytes

Note Each two ASCII characters requires one byte of data.

Responses

The command code, response code, and text for the response are stored in memory as operands and the transmission is executed using the required parameters. The specific method depends on the programming method being used.

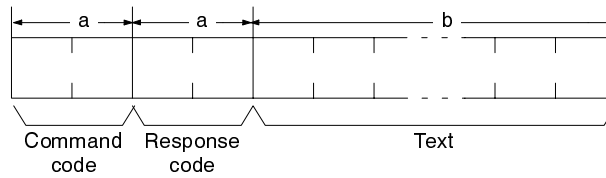

System	Binary	ASCII
SYSMAC NET	a: 2 bytes b: 0 to 1,986 bytes	a: 2 bytes b: 0 to 986 bytes
SYSMAC LINK	a: 2 bytes b: 0 to 538 bytes	Not applicable
Host Link	Not applicable	a: 2 bytes b: 0 to 538 bytes

Note Each two ASCII characters requires one byte of data.

Caution The maximum size of a command or response transmission can be no larger than the smallest limit for all networks through which the transmission is relayed. For example, a transmission from or to a SYSMAC NET Link Unit must be no more than 540 bytes for commands and 538 bytes for responses if the transmission is relayed through a Host Link System.

SECTION 2

Commands for CV-series PCs

This section provides details on commands that can be sent to CV-series PCs. The CV-series that support these commands are listed in the following table.

PC	Model number	PC	Model number
CV500	CV500-CPU01-E	CV2000	CV2000-CPU01-EV1
CV1000	CV1000-CPU01-E	CVM1	CVM1-CPU01-EV2 or CVM1-CPU11-EV2

2-1	Command List	14
2-2	Memory Area Designations	15
2-2-1	Word/Bit Addresses	17
2-2-2	Data Configuration	17
2-3	Volume Labels and File Names	18
2-4	MEMORY AREA READ	19
2-5	MEMORY AREA WRITE	20
2-6	MEMORY AREA FILL	21
2-7	MULTIPLE MEMORY AREA READ	21
2-8	MEMORY AREA TRANSFER	23
2-9	PARAMETER AREA READ	23
2-10	PARAMETER AREA WRITE	25
2-11	PARAMETER AREA CLEAR	26
2-12	PROGRAM AREA PROTECT	27
2-13	PROGRAM AREA PROTECT CLEAR	28
2-14	PROGRAM AREA READ	28
2-15	PROGRAM AREA WRITE	29
2-16	PROGRAM AREA CLEAR	30
2-17	RUN	30
2-18	STOP	31
2-19	CONTROLLER DATA READ	31
2-20	CONNECTION DATA READ	33
2-21	CONTROLLER STATUS READ	33
2-22	CYCLE TIME READ	35
2-23	CLOCK READ	36
2-24	CLOCK WRITE	36
2-25	MESSAGE READ	37
2-26	MESSAGE CLEAR	38
2-27	FAL/FALS READ	39
2-28	ACCESS RIGHT ACQUIRE	40
2-29	ACCESS RIGHT FORCED ACQUIRE	40
2-30	ACCESS RIGHT RELEASE	41
2-31	ERROR CLEAR	42
2-32	ERROR LOG READ	43
2-33	ERROR LOG CLEAR	44
2-34	FILE NAME READ	44
2-35	SINGLE FILE READ	46
2-36	SINGLE FILE WRITE	46
2-37	MEMORY CARD FORMAT	47
2-38	FILE DELETE	47
2-39	VOLUME LABEL CREATE/DELETE	48
2-40	FILE COPY	49
2-41	FILE NAME CHANGE	49
2-42	FILE DATA CHECK	50
2-43	MEMORY AREA FILE TRANSFER	50
2-44	PARAMETER AREA FILE TRANSFER	52
2-45	PROGRAM AREA FILE TRANSFER	53
2-46	FORCED SET/RESET	54
2-47	FORCED SET/RESET CANCEL	55
2-48	Aborting Commands	55

2-1 Command List

The beginning portions of the command and response block up to the command codes and the FCS and terminator have been omitted for simplicity, but must be added for actual transmission if not automatically generated for the transmission method being used. Refer to *1-3 Command/Response Transmission Data*.

In the illustrations of command and response blocks in this section, each box represents one byte (i.e., two hexadecimal or BCD digits). Be careful when adding the header, where each box represents one digit (i.e., four bits).

The following table lists the FINS commands supported by CV-series PCs and the PC operating modes during which they are enabled.

Command code		Name	PC mode				Page
			RUN	MONITOR	DEBUG	PROGRAM	
01	01	MEMORY AREA READ	Valid	Valid	Valid	Valid	19
	02	MEMORY AREA WRITE	Valid	Valid	Valid	Valid	20
	03	MEMORY AREA FILL	Valid	Valid	Valid	Valid	21
	04	MULTIPLE MEMORY AREA READ	Valid	Valid	Valid	Valid	21
	05	MEMORY AREA TRANSFER	Valid	Valid	Valid	Valid	23
02	01	PARAMETER AREA READ	Valid	Valid	Valid	Valid	23
	02	PARAMETER AREA WRITE	Valid	Valid	Valid	Valid	25
	03	PARAMETER AREA CLEAR	Valid	Valid	Valid	Valid	26
03	04	PROGRAM AREA PROTECT	Valid	Valid	Valid	Valid	27
	05	PROGRAM AREA PROTECT CLEAR	Valid	Valid	Valid	Valid	28
	06	PROGRAM AREA READ	Valid	Valid	Valid	Valid	28
	07	PROGRAM AREA WRITE	Not valid	Valid	Valid	Valid	29
	08	PROGRAM AREA CLEAR	Not valid	Not valid	Not valid	Valid	30
04	01	RUN	Valid	Valid	Valid	Valid	30
	02	STOP	Valid	Valid	Valid	Valid	31
05	01	CONTROLLER DATA READ	Valid	Valid	Valid	Valid	31
	02	CONNECTION DATA READ	Valid	Valid	Valid	Valid	33
06	01	CONTROLLER STATUS READ	Valid	Valid	Valid	Valid	33
	20	CYCLE TIME READ	Valid	Valid	Not valid	Not valid	35
07	01	CLOCK READ	Valid	Valid	Valid	Valid	36
	02	CLOCK WRITE	Valid	Valid	Valid	Valid	36
09	20	MESSAGE READ	Valid	Valid	Valid	Valid	37
		MESSAGE CLEAR	Valid	Valid	Valid	Valid	38
		FAL/FALS READ	Valid	Valid	Valid	Valid	39
0C	01	ACCESS RIGHT ACQUIRE	Valid	Valid	Valid	Valid	40
	02	ACCESS RIGHT FORCED ACQUIRE	Valid	Valid	Valid	Valid	40
	03	ACCESS RIGHT RELEASE	Valid	Valid	Valid	Valid	41
21	01	ERROR CLEAR	Valid	Valid	Valid	Valid	42
	02	ERROR LOG READ	Valid	Valid	Valid	Valid	43
	03	ERROR LOG CLEAR	Valid	Valid	Valid	Valid	44

Command code	Name	PC mode				Page	
		RUN	MONITOR	DEBUG	PROGRAM		
22	01	FILE NAME READ	Valid	Valid	Valid	Valid	44
	02	SINGLE FILE READ	Valid	Valid	Valid	Valid	46
	03	SINGLE FILE WRITE	Valid	Valid	Valid	Valid	46
	04	MEMORY CARD FORMAT	Valid	Valid	Valid	Valid	47
	05	FILE DELETE	Valid	Valid	Valid	Valid	47
	06	VOLUME LABEL CREATE/DELETE	Valid	Valid	Valid	Valid	48
	07	FILE COPY	Valid	Valid	Valid	Valid	49
	08	FILE NAME CHANGE	Valid	Valid	Valid	Valid	49
	09	FILE DATA CHECK	Valid	Valid	Valid	Valid	50
	0A	MEMORY AREA FILE TRANSFER	Valid	Valid	Valid	Valid	50
	0B	PARAMETER AREA FILE TRANSFER	Valid	Valid	Valid	Valid	52
0C	PROGRAM AREA FILE TRANSFER	(see note)	Valid	Valid	Valid	53	
23	01	FORCED SET/RESET	Not valid	Valid	Valid	Valid	54
	02	FORCED SET/RESET CANCEL	Not valid	Valid	Valid	Valid	55

Note When the PC is in RUN mode, data transfers from files to the program area are not possible, but transfers from the program area to files are possible.

2-2 Memory Area Designations

The following table gives the addresses to use when reading or writing PC data. The *Data area address* column gives the normal addresses used in the PC program. The *Address used in communications* column are the addresses used in CV-mode commands and responses. These addresses are combined with the memory area codes to specify PC memory locations. These addresses are not the same as the actual memory addresses of the data.

The *No. of bytes* column specifies the number of bytes to read or write data for that area. The number of bytes varies for the same area depending on the memory area code.

CV500 or CVM1-CPU01-E

Memory area	Data		Data area address	Address used in communications	Memory area code	No. of bytes
CIO, TR, CPU Bus Link, and Auxiliary Areas	Bit status	CIO TR G A	000000 to 25515 TR0 to TR7 G00000 to G25515 A00000 to A51115	000000 to 09FB0F 09FF00 to 09FF07 0A0000 to 0AFF0F 0B0000 to 0CFF0F	00	1
	Bit status (with forced status)	CIO G	000000 to 25515 G00000 to G25515	000000 to 09FB0F 0A0000 to 0AFF0F	40	1
	Word contents	CIO TR G A	0000 to 2555 G000 to G255 A000 to A511	000000 to 09FB00 09FF00 0A0000 to 0AFF00 0B0000 to 0CFF00	80	2
	Word contents (with forced status)	CIO G	0000 to 2555 G000 to G255	000000 to 097B00 0A0000 to 0AFF00	C0	4
Timer Area/ Counter Area	Completion Flag status	TIM CNT	T0000 to T1023 C0000 to C1023	000000 to 03DF00 080000 to 0BDF00	01	1
	Completion Flag status (with forced status)	TIM CNT	T0000 to T1023 C0000 to C1023	000000 to 03DF00 080000 to 0BDF00	41	1
	PV	TIM CNT	T0000 to T1023 C0000 to C1023	000000 to 01FF00 080000 to 09FF00	81	2

Memory area	Data		Data area address	Address used in communications	Memory area code	No. of bytes
DM Area	Word contents	DM	D00000 to D24575	000000 to 1FFF00	82	2
Transition Area (CV500 only)	Flag status	TN	TN0000 to TN1023	000000 to 03FF00	03	1
	Flag status (with forced status)	TN	TN0000 to TN1023	000000 to 03FF00	43	1
Step Area (CV500 only)	Flag status	ST	ST0000 to ST1023	000000 to 03FF00	04	1
	Status	ST	ST0000 to ST1023	000000 to 03FF00	44	1
	Step timer PV	ST	ST0000 to ST1023	000000 to 03FF00	84	2
Forced Status	Bit status	CIO G	000000 to 25515 G00000 to G25515	000000 to 09FB0F 0A0000 to 0AFF0F	05	1
	Word contents	CIO G	0000 to 2555 G000 to G255	000000 to 09FB00 0A0000 to 0AFF00	85	2
Action Area (CV500 only)	Flag status	AC	AC0000 to AC2047	000000 to 07FF00	1B	1
Register Area	Register contents	IR DR	IR0 to IR2 DR0 to DR2	000000 to 000200 000300 to 000500	9C	2
Interrupt area	Scheduled interrupt interval		Not applicable	000200	DD	4

CV1000, CV2000, or CVM1-CPU11-E

Memory area	Data		Data area address	Address used in communications	Memory area code	No. of bytes
CIO, TR, CPU Bus Link, and Auxiliary Areas	Bit status	CIO TR G A	000000 to 25515 TR0 to TR7 G00000 to G25515 A00000 to A51115	000000 to 09FB0F 09FF00 to 09FF07 0A0000 to 0AFF0F 0B0000 to 0CFF0F	00	1
	Bit status (with forced status)	CIO G	000000 to 25515 G00000 to G25515	000000 to 09FB0F 0A0000 to 0AFF0F	40	1
	Word contents	CIO TR G A	0000 to 2555 G000 to G255 A000 to A511	000000 to 09FB00 09FF00 0A0000 to 0AFF00 0B0000 to 0CFF00	80	2
	Word contents (with forced status)	CIO G	0000 to 2555 G000 to G255	000000 to 09FB00 0A0000 to 0AFF00	C0	4
Timer Area/Counter Area	Completion Flag status	TIM CNT	T0000 to T1023 C0000 to C1023	000000 to 03FF00 080000 to 0BFF00	01	1
	Completion Flag status (with forced status)	TIM CNT	T0000 to T1023 C0000 to C1023	000000 to 03FF00 080000 to 0BFF00	41	1
	PV	TIM CNT	T0000 to T1023 C0000 to C1023	000000 to 03FF00 080000 to 0BFF00	81	2
DM Area	Word contents	DM	D00000 to D24575	000000 to 5FFF00	82	2
Transition Area (CV1000 or CV2000 only)	Flag status	TN	TN0000 to TN1023	000000 to 03FF00	03	1
	Flag status (with forced status)	TN	TN0000 to TN0511	000000 to 03DF00	43	1
Step Area (CV1000 or CV2000 only)	Flag status	ST	ST0000 to ST1023	000000 to 03FF00	04	1
	Status	ST	ST0000 to ST1023	000000 to 03FF00	44	1
	Step timer PV	ST	ST0000 to ST1023	000000 to 03FF00	84	2
Forced Status	Bit status	CIO G	000000 to 25515 G00000 to G25515	000000 to 09FB0F 0A0000 to 0AFF0F	05	1
	Word contents	CIO G	0000 to 2555 G000 to G255	000000 to 09FB00 0A0000 to 0AFF00	85	2

Memory area	Data	Data area address	Address used in communications	Memory area code	No. of bytes	
Expansion DM Area (CV1000 or CV2000 only)	Word contents	Banks 0 to 7	E00000 to E32765 to E00000 to E32765	000000 to 7FFD00 to 000000 to 7FFD00	90 to 97	2
		Current bank	E00000 to E32765	000000 to 7FFD00	98	2
Action Area (CV1000 or CV2000 only)	Flag status	AC	AC0000 to AC2047	000000 to 1FFF00	1B	1
Register Area	Register contents	IR DR	IR0 to IR2 DR0 to DR2	000000 to 000200 000300 to 000500	9C	2
	Expansion DM current bank no. (CV1000 or CV2000 only)	Not applicable		000600		2
Interrupt area	Scheduled interrupt interval	Not applicable		000200	DD	4

2-2-1 Word/Bit Addresses

Each word/bit address specifies a specific bit or word. The rightmost two digits of the address specify bit 00 to 15 (or 00 if not required), and leftmost four digits specify the word address.

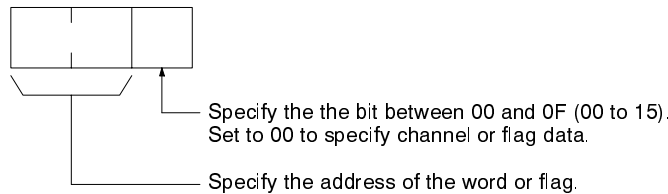

To obtain the corresponding address of the desired word or bit, add the data area word address (hexadecimal) to the first address of the range of addresses used for that data area in communications. For example, the address for word G134 is computed as follows:

$$\begin{aligned} \text{First address for CPU Bus Link Area;} & \quad 0A00 \\ 0A00 + 86 \text{ (134 in BCD);} & \quad 0A86 \end{aligned}$$

The word address for G134 would thus be 0A8600 (the memory area code would specify this as a word) and the address of bit 12 in C134 would be 0A860C.

2-2-2 Data Configuration

The configuration of the various types of data that can be read or written is shown below. The number of bytes required for each type of data is also given.

- Flag or Bit Status (One Byte)** 00: Bit is OFF (0)
01: Bit is ON (1)
- Flag or Bit Status with Forced Status (One Byte)** 00: Bit is OFF (0) but not forced.
01: Bit is ON (1) but not forced.
02: Bit has been forced OFF (0).
03: Bit has been forced ON (1).

Word Contents or PV (Two Bytes)

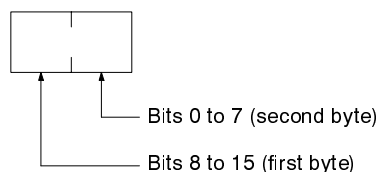

Word Contents or PV with Forced Status (Four Bytes)

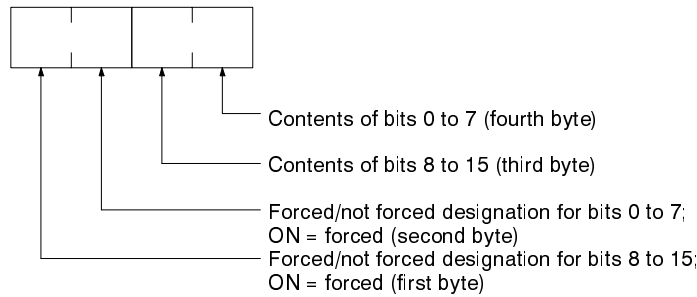

Step Status (One Byte)

- 00: INACTIVE
- 01: HALT
- 02: PAUSE
- 03: EXECUTE

Current Bank No. of Expansion DM (Two Bytes)

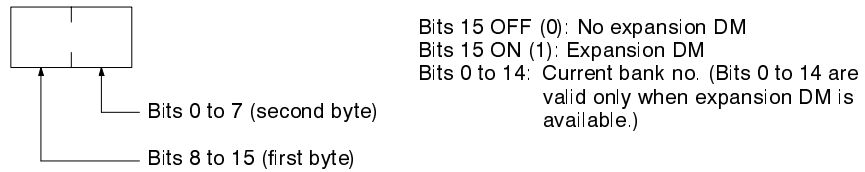

Scheduled Interrupt Interval

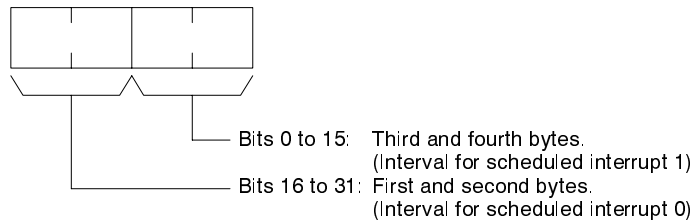

2-3 Volume Labels and File Names

Each volume label or file name consists of 12 bytes as follows:

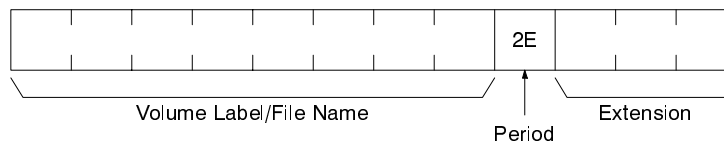

Volume Label/File Name

Each volume label or file name must have eight ASCII characters with or without spaces (ASCII 20). If less than eight letters are used, add spaces to the end of the label/name.

Extension

An extension can be added to each volume label/file name so that the files can be classified. Each extension must have three ASCII characters with or without spaces. If less than three letters are used, add spaces to the end of the extension.

Period

Add a period (ASCII 2E) between the volume label/file name and extension.

2-4 MEMORY AREA READ

Reads the contents of the specified number of consecutive memory area words starting from the specified word. All words must be in the same memory area (here, all memory areas with the same memory area code are considered as one area).

Command Block

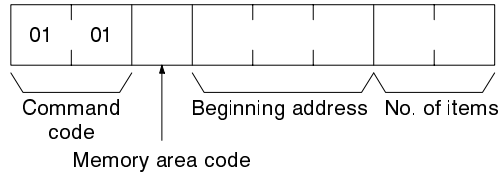

Response Block

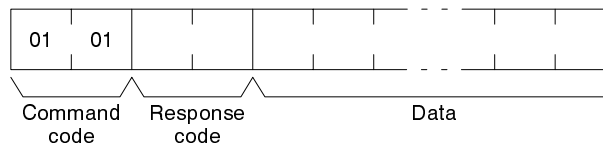

Parameters

Memory area code (command): The data area to read.

Beginning address (command): The address of the first word/bit/flag to read from memory.

No. of items (command): The number of items to be read.

Data (response): The data from the specified words is returned in sequence starting from the beginning address. The required number of bytes in total is calculated as follows:

$$\text{No. of bytes required by each item} \times \text{No. of items}$$

Memory Areas

The following data can be read (refer to 2-2 *Memory Area Designations* for PC word/bit address designations):

Memory area	Data	Memory area code	No. of bytes
CIO, TR, CPU Bus Link, and Auxiliary	Bit status	00	1
	Word contents	80	2
Timer/Counter	Completion Flag status	01	1
	PV	81	2
DM	Word contents	82	2
Transition	Flag status	03	1
Step	Flag status	04	1
Forced status	Bit status	05	1
	Word contents	85	2
Expansion DM	Word contents, specified bank	90 to 97 (banks 0 to 7)	2
	Word contents, current bank	98	2
Action	Flag status	1B	1

2-5 MEMORY AREA WRITE

Writes data to the specified number of consecutive words starting from the specified word. All words must be in the same memory area (here, all memory areas with the same memory area code are considered as one area).

- Note**
1. The MEMORY AREA WRITE command can be executed regardless of the PC's operating mode. It is the user's responsibility to program steps to prohibit this command from being executed when the PC is in RUN mode if such protection is necessary. Execute the CONTROLLER STATUS READ command (refer to 2-21 CONTROLLER STATUS READ) to read the PC's mode.
 2. When data is written to the Timer/Counter PV Area, the Completion Flags will be turned OFF (0).

Command Block

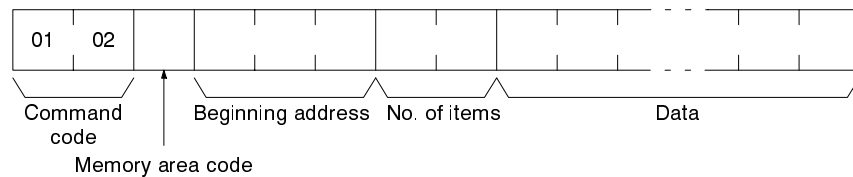

Response Block

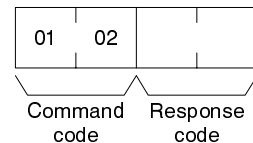

Parameters

Memory area code (command): The data area to write.

Beginning address (command): The first word/value to write.

No. of items (command): The number of items to be written. Set the number of items to 0001 when writing a step timer PV, register value, or interrupt status.

Data (command): The data to be written. The required number of bytes in total is calculated as follows:

$$\text{No. of bytes required by each item} \times \text{No. of items}$$

The following data can be written (refer to 2-2 Memory Area Designations for the word/bit address designations):

Memory area	Data	Memory area code	No. of bytes
CIO, TR, CPU Bus Link, and Auxiliary	Word contents	80	2
Timer/Counter	PV	81	2
DM	Word contents	82	2
Step	Step timer PV	84	2
Expansion DM	Word contents, specified bank	90 to 97 (banks 0 to 7)	2
	Word contents, current bank	98	2
Register	Register contents	9C	2
	Current bank no. of expansion DM		
Interrupt status	Scheduled interrupt interval	DD	4

2-6 MEMORY AREA FILL

Writes the same data to the specified number of consecutive memory area words. All words must be in the same memory area (here, all memory areas with the same memory area code are considered as one area).

- Note**
1. The MEMORY AREA FILL command can be executed regardless of the PC's mode. It is the user's responsibility to program steps to prohibit this command from being executed when the PC is in the RUN mode if such protection is necessary. Execute the CONTROLLER STATUS READ command (refer to 2-21 CONTROLLER STATUS READ) to read the PC's mode.
 2. When data is written in the Timer/Counter PV Area, the Completion Flag will be turned OFF (0).

Command Block

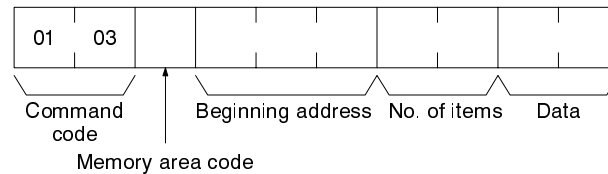

Response Block

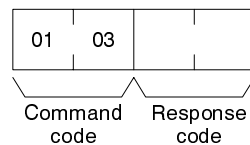

Parameters

Memory area code (command): The data area to write.

Beginning address (command): The first word/values to write.

No. of items (command): The number of items to write.

Data (command): The data to be written to the memory area starting from the Beginning address. The data to be written should consist of two bytes.

The following data can be written (refer to 2-2 Memory Area Designations for memory area designations):

Memory area	Data	Memory area code	No. of bytes
CIO, TR, CPU Bus Link, and Auxiliary	Word contents	80	2
Timer/Counter	PV	81	2
DM	Word contents	82	2
Expansion DM	Word contents, specified bank	90 to 97 (banks 0 to 7)	2
	Current bank	98	2

2-7 MULTIPLE MEMORY AREA READ

Reads the contents of the specified number of non-consecutive memory area words, starting from the specified word.

- Note** If there is an error in the command code or a beginning address, no data will be read.

Command Block

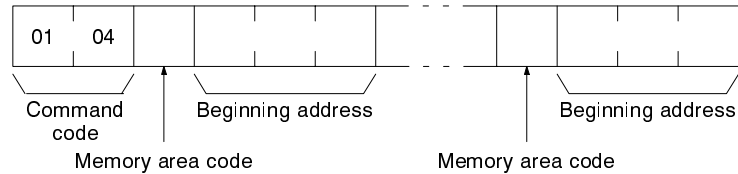

Response Block

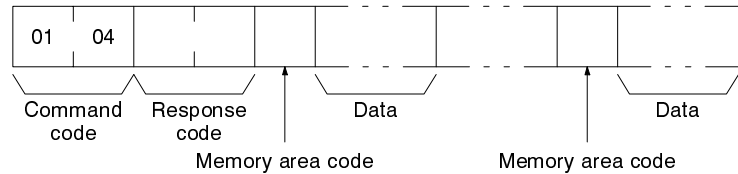

Parameters

Memory area code (command): The data area to read.

Beginning address (command): The first word/bit/flag to read.

Data (response): The data in the specified memory area(s) will be returned in sequence starting from the beginning address.

Memory Areas

The following data can be written (refer to 2-2 Memory Area Designations for memory area designations):

Memory area	Data	Memory area code	No. of bytes
CIO, TR, CPU Bus Link, and Auxiliary	Bit status	00	1
	Bit status (with forced status)	40	1
	Word contents	80	2
	Word contents (with forced status)	C0	4
Timer/Counter	Completion Flag status	01	1
	Completion Flag status (with forced status)	41	1
	PV	81	2
DM	Word contents	82	2
Transition	Flag status	03	1
	Flag status (with forced status)	43	1
Step	Flag status	04	1
	Status	44	1
	Step Timer PV	84	2
Forced Status	Bit status	05	1
	Word contents	85	2
Expansion DM	Word contents, specified bank	90 to 97 (banks 0 to 7)	2
	Word contents, current bank	98	2
Action	Flag status	1B	1
Register	Register contents	9C	2
	Expansion DM current bank no.		
Interrupt status	Scheduled interrupt interval	DD	4

2-8 MEMORY AREA TRANSFER

Copies and transfers the contents of the specified number of consecutive memory area words to the specified memory area. All source words must be in the same area and all designation words must be written to the same area (here, all memory areas with the same memory area code are considered as one area).

- Note**
1. The MEMORY AREA TRANSFER command can be executed regardless of the PC's mode. It is the user's responsibility to program steps to prohibit this command from being executed when the PC is in the RUN mode if such protection is necessary. Execute the CONTROLLER STATUS READ command (refer to 2-21 CONTROLLER STATUS READ) to read the PC's mode.
 2. When data is written to the Timer/Counter PV Area, the Completion Flags will be turned OFF (0).

Command Block

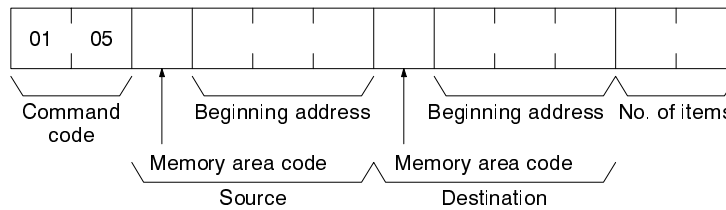

Response Block

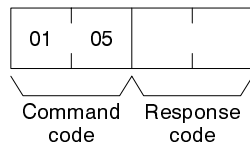

Parameters

Memory area code (command): The data area to transfer from and the data area to transfer to.

Beginning address (command): The first word/value to transfer from and the first word to transfer to.

No. of items (command): The number of items to transfer (each item consists of two bytes).

The following data can be transferred (refer to 2-2 Memory Area Designations for memory area designations):

Memory area	Data	Memory area code	No. of bytes
CIO, TR, CPU Bus Link, and Auxiliary	Word contents	80	2
Timer/Counter	PV	81	2
DM	Word contents	82	2
Expansion DM	Word contents, specified bank	90 to 97 (banks 0 to 7)	2
	Word contents, current bank	98	2

2-9 PARAMETER AREA READ

Reads the contents of the specified number of consecutive parameter area words starting from the specified word. All words in the specified parameter area must be read at the same time to ensure complete data. A maximum of 266 words can be read with each command. To read larger parameter areas, use

multiple commands and specify the beginning word and number of words for each.

Command Block

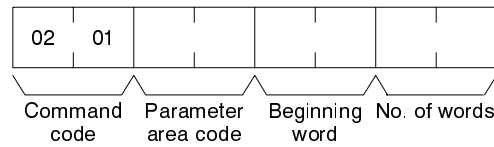

Response Block

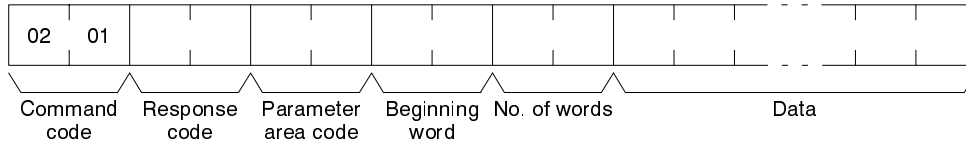

Parameters

Parameter area code (command and response): The parameter area to read.

Beginning word (command and response): The first word to read.

No. of words (command and response): Bits 0 to 14 are used to specify the number of words to be read (each word consists of two bytes). Bit 15 must be OFF (0) in the command block. When the contents in the response block contains the last word of data in the specified parameter area, bit 15 will be ON (1).

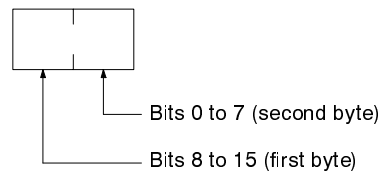

Bit 15 OFF (0): Without last word data
 Bit 15 ON (1): With last word data
 Bits 0 to 14: No. of words read

Data (response): The data in the specified parameter area will be returned in sequence starting from the beginning word. The leftmost bits (bits 8 to 15) of each word are read first, followed by the rightmost bits (bits 0 to 7). The required number of bytes in total for each read is calculated as follows:

$$\text{No. of words} \times 2 \text{ (each word consists of two bytes)}$$

Parameter Areas

There are five parameter areas, each of which has consecutive word addresses beginning from 0000. The following data can be read. The word ranges in parentheses show the possible values for the beginning word.

PC Setup		80 10 (0000 to 00FF)	80 01 (0000 to 06BF)	80 00 (0000 to 0FFF)
Peripheral Device settings		80 11 (0000 to 00BF)		
I/O table		80 12 (0000 to 03FF)		
Routing tables*		80 13 (0000 to 01FF)		
CPU Bus Unit settings	Unit No. 0 . . Unit No. 15	80 02 (0000 to 083F)		

Note *Although the routing tables have a 512-word area (0000 to 01FF), only a 48-word area (0000 to 002F) of it can be read.

2-10 PARAMETER AREA WRITE

Writes data to the specified number of consecutive parameter area words starting from the specified word. All words in the specified parameter area must be written at the same time to ensure complete data. A maximum of 266 words can be written with each command. To write larger parameter areas, use multiple commands and specify the beginning word for each.

Data can be written to the I/O table only when the PC is in PROGRAM mode.

- Note**
1. The PARAMETER AREA WRITE command can be executed regardless of the PC's mode. It is the user's responsibility to program steps to prohibit this command from being executed when the PC is in the RUN mode if such protection is necessary. Execute the CONTROLLER STATUS READ command (refer to 2-21 CONTROLLER STATUS READ) to read the PC's mode.
 2. If any other device has the access right, nothing will be written to the specified parameter area.
 3. If memory is write-protected via the key switch on the front panel of the PC, nothing will be written to the specified parameter area.

Command Block

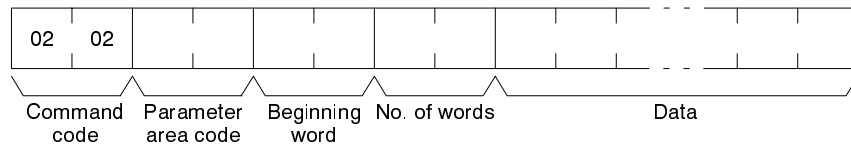

Response Block

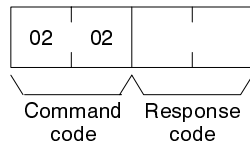

Parameters

Parameter area code (command): The parameter area to write.

Beginning word (command): The first word to write.

No. of words (command): Bits 0 to 14 are used to specify the number of words to be written (each word consists of two bytes). Bit 15 must be ON (1) when data is written to the last word in the specified parameter area or no data will be written. If the number of write words is set to 0000, no words will be written and a normal response code will be returned.

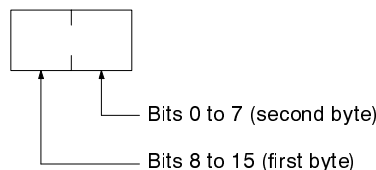

Bit 15 OFF (0): Without last word data to be written.
 Bit 15 ON (1): With last word data to be written.
 Bits 0 to 14: No. of words to be written

Data (command): The data to be written. The leftmost bits (bits 15 to 8) of each word must be specified first, followed by the rightmost bits (bits 7 to 0). The required number of bytes in total for each write can be calculated as follows:

$$\text{No. of words} \times 2 \text{ (each word consists of two bytes)}$$

Parameter Areas

There are five parameter areas, each of which has consecutive word addresses beginning from 0000. The following data can be read. The word ranges in parentheses show the possible values for the beginning word.

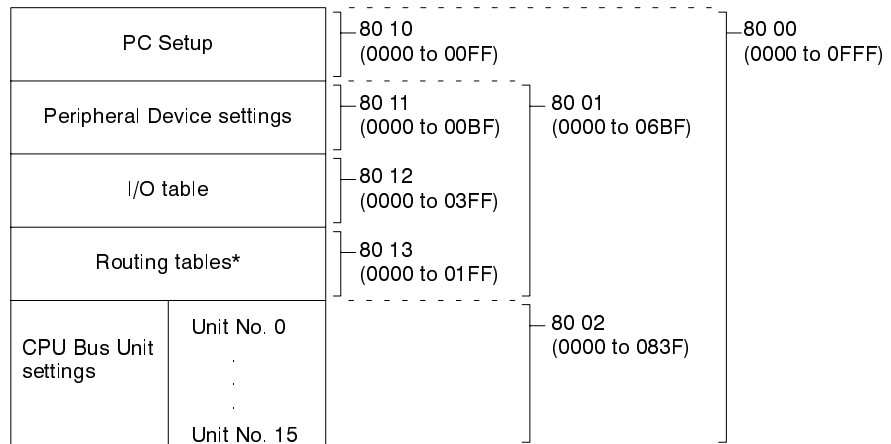

Note *Only a 48-word area (0000 to 002F) of the routing tables is available. The data must be written to the 48-word area in sequence beginning from 0000 or an error will result as the PC automatically does a format check in order to prevent routing errors.

2-11 PARAMETER AREA CLEAR

Writes all zeros to the specified number of consecutive parameter area words to clear the previous data. The I/O table can be cleared only when the PC is in PROGRAM mode.

Always clear the entire range of the specified parameter area.

- Note**
1. The PARAMETER AREA CLEAR command can be executed regardless of the PC's mode. It is the user's responsibility to program steps to prohibit this command from being executed when the PC is in the RUN mode if such protection is necessary. Execute the CONTROLLER STATUS READ command (refer to 2-21 CONTROLLER STATUS READ) to read the PC's mode.
 2. If any other device holds the access right, nothing can be written to the specified parameter area.
 3. If memory is write-protected via the key switch on the front panel of the PC, nothing can be written to the specified parameter area.

Command Block

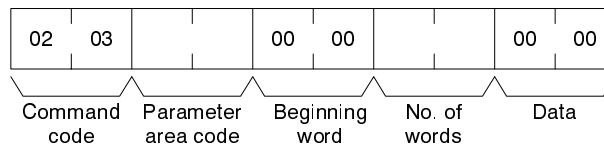

Response Block

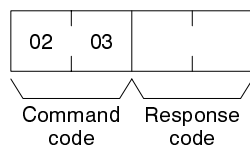

Parameters

Parameter area code (command): The parameter area to clear.
Beginning word (command): Fixed at 0000.

No. of words (command): The number of words to clear (see diagram below).

Data (command): Set to 0000. The number of word addresses where the data (0000) should be written is specified by the number of words in the command block.

Parameters Areas

The available parameter areas and the number of words in each are as shown below. The number of words in the parentheses is specified as the number of words to clear.

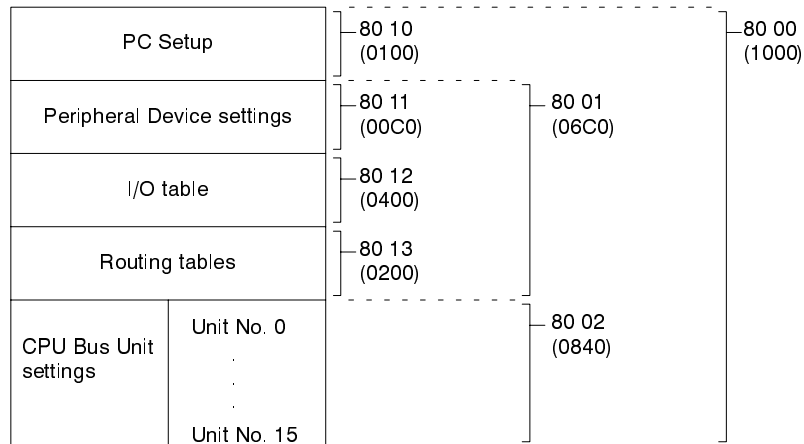

2-12 PROGRAM AREA PROTECT

Protects the program by removing all read/write access rights.

- Note**
1. The program cannot be protected if any other device holds the access right.
 2. If memory is write-protected via the key switch on the front panel of the PC, the PROGRAM AREA PROTECT command will not be effective.

Command Block

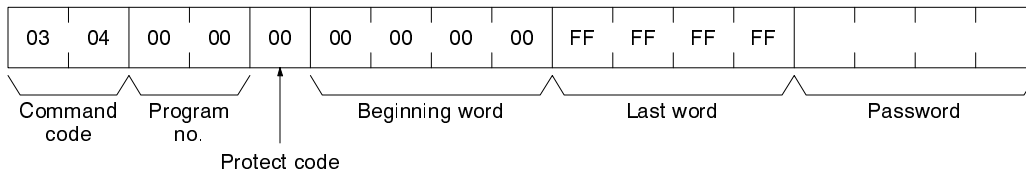

Response Block

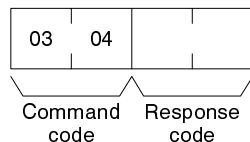

Parameters

The command will be executed normally even if the beginning word and last word are set to values other than those shown below.

Program no. (command): Set to 0000.

Protect code (command): Set to 00.

Beginning word (command): Set to 00000000

Last word (command): Set to FFFFFFFF

Password (command): Set any four ASCII characters. The password is used with the PROGRAM AREA PROTECT CLEAR command (refer to 2-13 PROGRAM AREA PROTECT CLEAR).

2-13 PROGRAM AREA PROTECT CLEAR

Restores write and read access rights so that data can be written to and read from the program area.

- Note**
1. Protection cannot be cleared if any other device holds the access right.
 2. If memory is write-protected via the key switch on the front panel of the PC, the PROGRAM AREA PROTECT CLEAR command is not effective.
 3. If you forget the password, you will not be able to clear program protection without using PROGRAM AREA CLEAR to delete the entire program area. Executing PROGRAM AREA CLEAR will release program protection.

Command Block

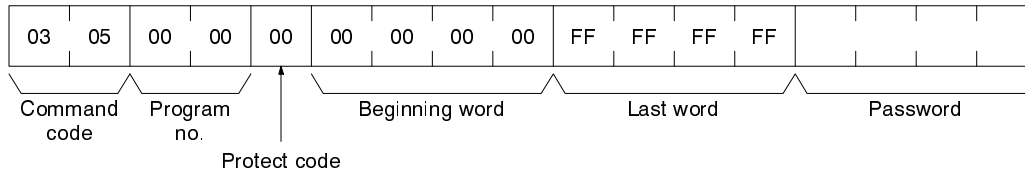

Response Block

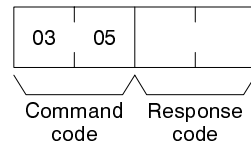

Parameters

The command will be executed normally even if the beginning word and last word are set to values other than those shown below.

Program no. (command): Set to 0000.

Protect code (command): Set to 00.

Beginning word (command): Set to 00000000

Last word (command): Set to FFFFFFFF

Password (command): The password that was set in the PROGRAM AREA PROTECT command.

2-14 PROGRAM AREA READ

Reads the contents of the specified number of consecutive program area words starting from the specified word. A maximum of 530 bytes can be read with each command. To read larger amounts of data, use multiple commands and specify the beginning word and number of words for each.

Command Block

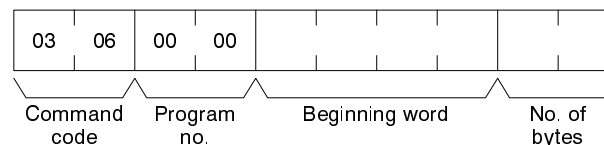

Response Block

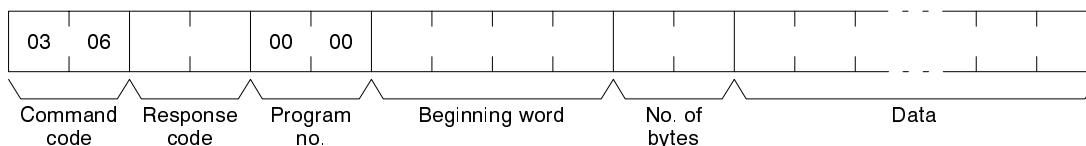

Parameters

Program no. (command and response): Set to 0000.

Beginning word (command and response): Set between 0000E00 and 0000FFFE for the CV500 or CVM1 and between 0000E00 and 0001FFFE for the CV1000 or CV2000. The beginning word must be an even number.

No. of bytes (command and response): The number of bytes in an even number (530 or smaller). Bit 15 must be OFF (0) in the command block. Bit 15 will be ON (1) in the response block when the last word data of the program area is returned.

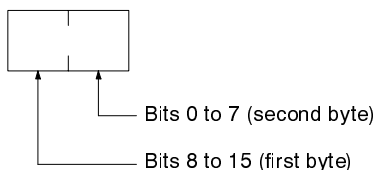

Bit 15 OFF (0): Without last word data
 Bit 15 ON (1): With last word data
 Bits 0 to 14: No. of bytes read

Data (response): The data in the specified program area will be returned in sequence starting from the beginning word.

2-15 PROGRAM AREA WRITE

Writes data to the specified number of consecutive program area words starting from the specified word. A maximum of 532 bytes can be written with each command. To write larger amounts of data, use multiple commands and specify the beginning word and number of words for each.

- Note**
1. If memory is write-protected via the key switch on the PC's front panel or by the PROGRAM AREA PROTECT command (refer to 2-12 PROGRAM AREA PROTECT), nothing will be written to the program area.
 2. The PROGRAM AREA WRITE command can be executed as long as the PC is not in RUN mode. It is the user's responsibility to program steps to prohibit this command from being executed when the PC is in MONITOR or DEBUG mode if such protection is necessary. Execute the CONTROLLER STATUS READ command (refer to 2-21 CONTROLLER STATUS READ) to read the PC's mode.

Command Block

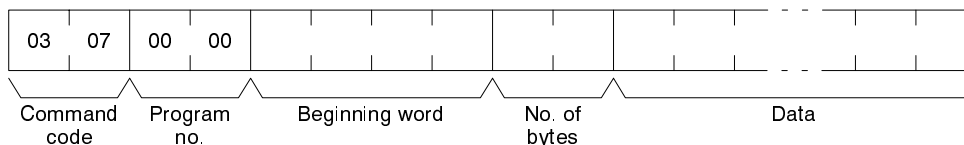

Response Block

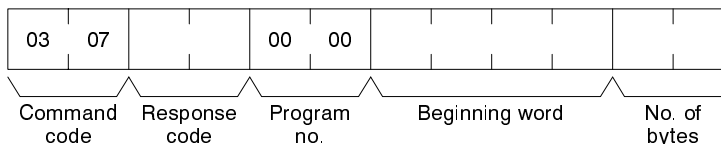

Parameters

Program no. (command and response): Set to 0000.

Beginning word (command and response): Set between 0000E00 and 0000FFFE for the CV500 or CVM1 and between 0000E00 and 0001FFFE for the CV1000 or CV2000. The beginning word must be an even number.

No. of bytes (command and response): The number of bytes in an even number (530 or smaller). Bit 15 must be ON (1) when data is written to the last word in the specified parameter area or no data will be written.

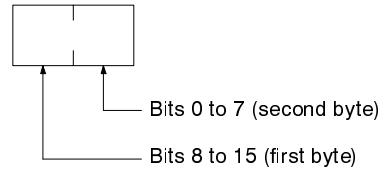

Bit 15 OFF (0): Without last word data
 Bit 15 ON (1): With last word data
 Bits 0 to 14: No. of bytes written

Data (command): The data to be written.

2-16 PROGRAM AREA CLEAR

Clears the contents of the program area.

- Note**
1. If memory is write-protected via the key switch on the front panel of the PC, the PROGRAM AREA CLEAR command is not effective.
 2. The PROGRAM AREA CLEAR command will clear the program area even if memory is write-protected by the PROGRAM AREA PROTECT command (refer to 2-12 PROGRAM AREA PROTECT). Executing PROGRAM AREA CLEAR will release program protection.
 3. If any other device holds the access right, the PROGRAM AREA CLEAR command is not effective.

Command Block

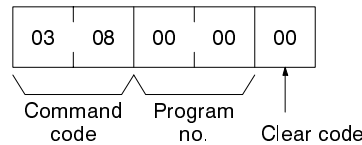

Response Block

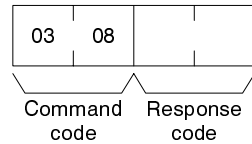

Parameters

Program no. (command): Set to 0000.

Clear code (command): Set to 00.

2-17 RUN

Changes the PC to DEBUG, MONITOR, or RUN mode, enabling the PC to execute its program.

- Note** If any other device holds the access right, the PC mode will not be changed.

Command Block

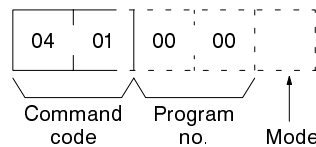

Response Block

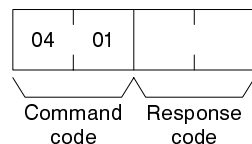

Parameters

Program no. (command): Set to 0000.

Mode (command): As follows:

- 0001: DEBUG mode
- 0002: MONITOR mode
- 0004: RUN mode

Note If the mode is not specified, the PC will go to MONITOR mode.

2-18 STOP

Changes the PC to PROGRAM mode, stopping program execution.

Note If any other device holds the access right, nothing will be executed.

Command Block

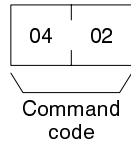

Response Block

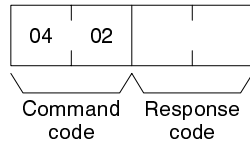

2-19 CONTROLLER DATA READ

Reads the following data:

- Controller model and version
- Area data
- CPU Bus Unit configuration
- Remote I/O data
- PC status

Command Block

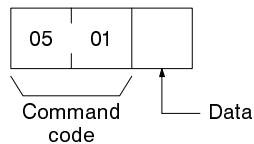

Response Block

The format is as follows if 00 is specified as the data to be read:

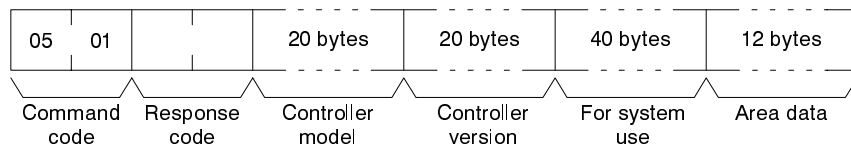

The format is as follows if 01 is specified as the data to be read:

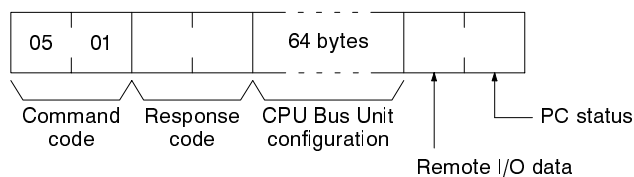

The format is as follows when the data to be read is omitted.

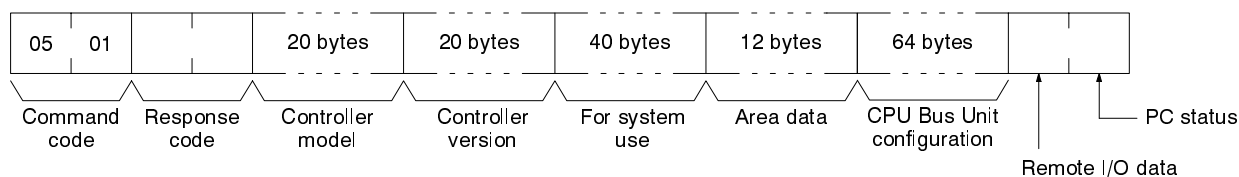

Parameters

Data (command): Specify as follows to read the desired data:

Value	00	01
Data to be read	Controller model Controller version Area data	CPU Bus Unit configuration Remote I/O data PC status

Note If no data is specified, all data will be read consecutively

Controller model and Controller version (response): Both are read in ASCII codes (20 bytes (i.e. 20 ASCII characters) max. each)

For system use (response): Reserved for system use.

Area data (response): As follows:

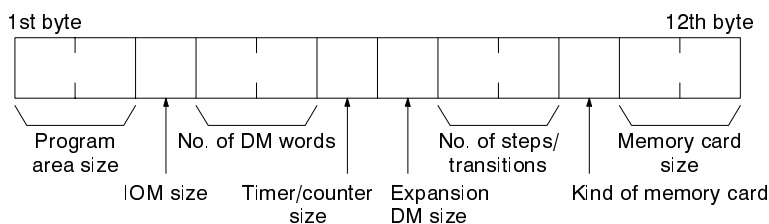

Item	Meaning	Unit
Program area size	The size of PC Setup and program area	K words (1K words = 1,024 words)
IOM size	The size of the area in which bit/word commands can be used.	K bytes (1K bytes = 1,024 bytes)
No. of DM words	Total words in the DM area	K words
Timer/counter size	Maximum no. of timers/counters available	Timers/Counters
Expansion DM size	Banks in the expansion DM area	Banks (1 bank = 32,766 words)
No. of steps/transitions	Maximum no. of steps/transitions available	Steps/transitions
Kind of memory card	00: No memory card 01: SPRAM 02: EPROM 03: EEPROM	---
Memory card size	Size of the memory card	K byte (1 word = 2 bytes)

CPU Bus Unit configuration (response): Each CPU Bus Unit has a code assigned to it consisting of two ASCII characters (two bytes). These codes are given in the numerical order according to the unit number of the CPU Bus Units (unit 0 to 15).

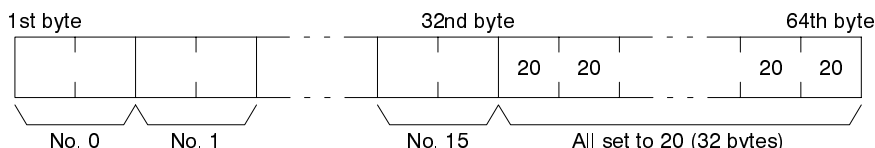

Remote I/O data (response): The number of remote I/O systems (SYSMAC BUS and SYSMAC BUS/2) is returned in two bytes as follows:

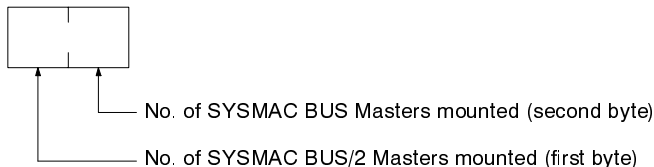

PC status (response): The following single byte (8 bits) is returned:

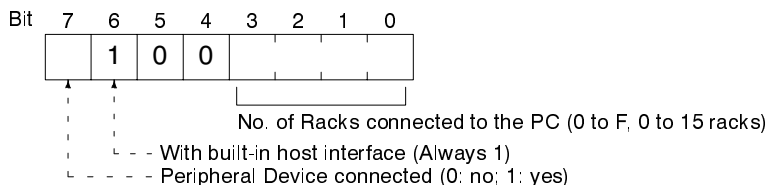

2-20 CONNECTION DATA READ

Reads the model number of the specified Units.

Command Block

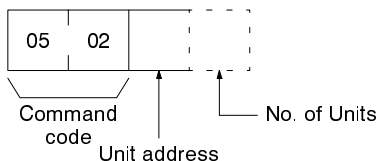

Response Block

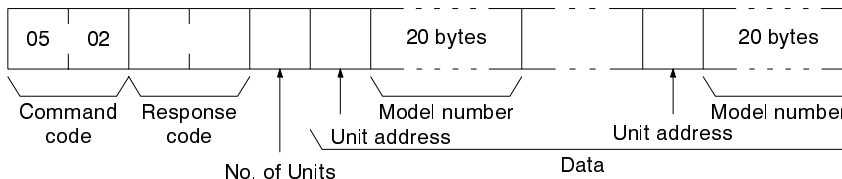

Parameters

Unit address (command and response): The unit address of the first Unit whose model number is to be read. If the specified Unit does not exist, the CONTROLLER DATA READ command is executed from the next Unit. Specify the following for the unit address.

CPU: 00

CPU Bus Unit: 10₁₆ + unit number in hexadecimal

No. of Data Units (command): The number of data units for which the model number is to be read. A number between 01 and 19 (hexadecimal) can be specified. If the number of data units is not specified, 19 (25 data units) will be used.

No. of Units (response): The number of Units for which a model number is being returned. If bit 7 is ON (1), the model number of the last Unit is being returned.

Unit address and model number (response): The unit address and model number. The model number is provided in up to 20 ASCII characters.

2-21 CONTROLLER STATUS READ

Reads the status of the Controller.

Note To read the error log, read the appropriate Auxiliary Area words or execute the ERROR LOG READ command (refer to 2-32 ERROR LOG READ).

Command Block

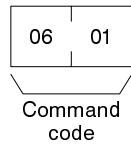

Response Block

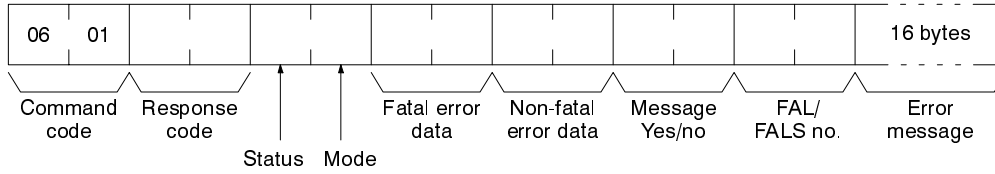

Parameters

Status (response): The operating status of the PC as follows:

- 00:** Stop (program not being executed)
- 01:** Run (program being executed)
- 80:** CPU on standby (the start switch is OFF or the CPU is waiting for a signal from a device such as a SYSMAC BUS/2 Remote I/O Slave Unit).

Mode (response): One of the following PC modes:

- 00:** PROGRAM
- 01:** DEBUG
- 02:** MONITOR
- 04:** RUN

Fatal error data (response): The contents of PC fatal error information (for details refer to the *CV-series PC Operation Manual: Ladder Diagrams*):

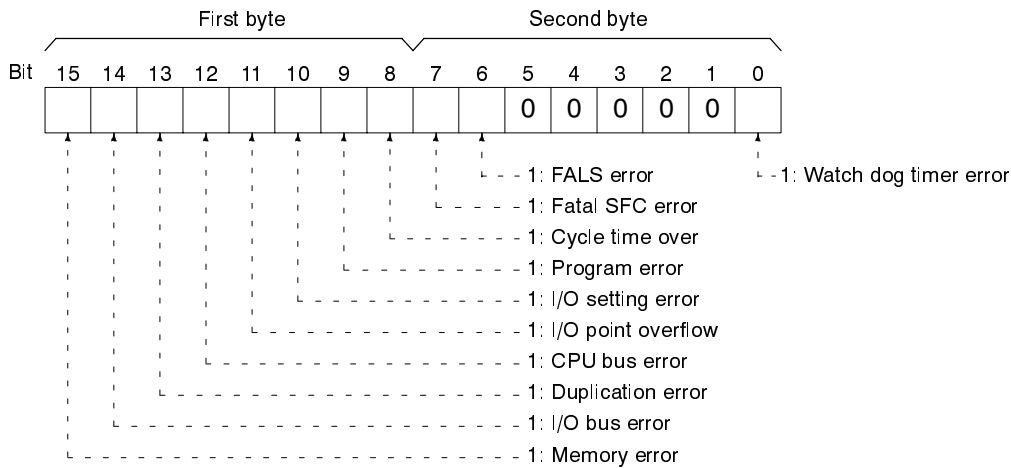

Non-fatal error data (response): The contents of PC non-fatal error information (for details refer to the *CV-series PC Operation Manual: Ladder Diagrams*):

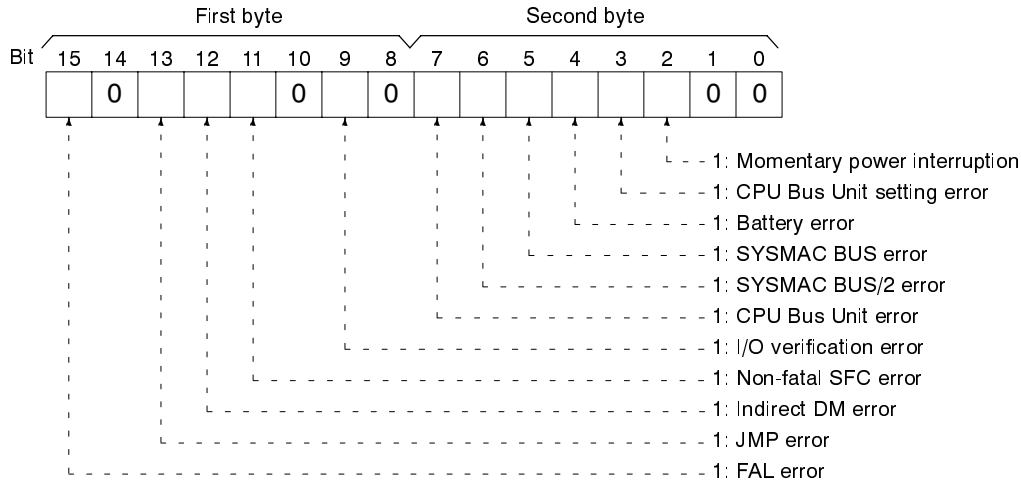

Message yes/no (response): If MSG(195) has been executed, the bit corresponding to the message number will be ON (1) as shown below. To read the messages generated by MSG(195), execute the MESSAGE READ command (refer to 2-25 MESSAGE READ).

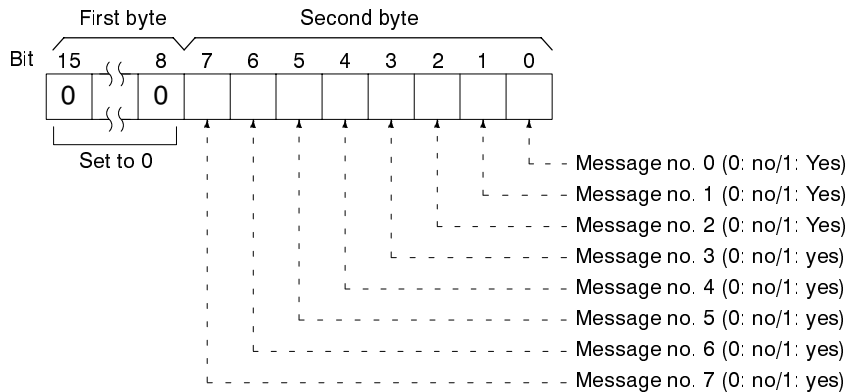

FAL/FALS no. (response): The highest priority FAL or FALS error. The actual value returned will be 4100 plus the FAL/FALS number; for details refer to the *CV-series PC Operation Manual: Ladder Diagrams*). If no FAL or FALS error has occurred, 0000 will be returned.

Error message (response): The error message of the present FAL/FALS number. If there is no error, 16 spaces (ASCII 20) will be returned.

2-22 CYCLE TIME READ

Initializes the PC's cycle time history or reads the average, max., and min. cycle time.

Command Block

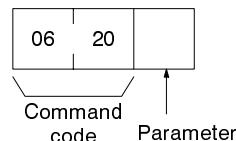

Response Block

The response format is as follows when the parameter is 00 (when initializing):

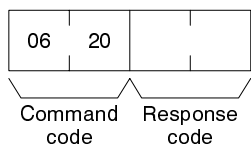

The response format is as follows when the parameter is 01 (when reading):

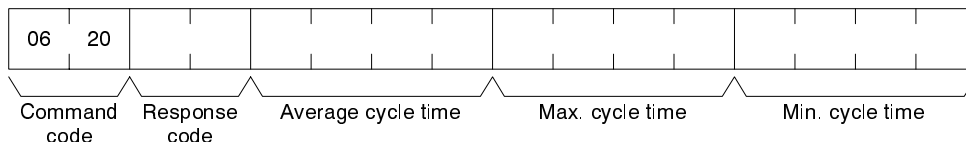

Parameters

Parameter code (command): As follows:

00: Initializes the cycle time.

01: Reads the average, maximum, and minimum cycle time.

Average cycle time, max. cycle time, min. cycle time (response): Each value is expressed in 8-digit BCD in 0.1-ms increments. For example, if 00 00 06 50 is returned, the cycle time is 65 ms.

The average cycle time is obtained as follows:

$$\text{Average cycle time} = (\text{max. cycle time} + \text{min. cycle time})/2$$

2-23 CLOCK READ

Reads the clock.

Command Block

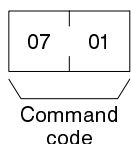

Response Block

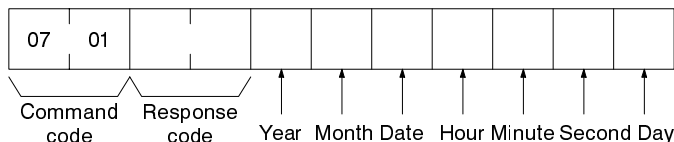

Parameters

Year, month, date, hour, minute, second, day (response): Each value is expressed in BCD.

Year: The rightmost two digits of the year.

Hour: 00 to 23.

Day: As follows:

Value	00	01	02	03	04	05	06
Day	Sun	Mon	Tues	Wed	Thur	Fri	Sat

2-24 CLOCK WRITE

Sets the clock.

- Note**
1. The PC automatically checks the range of the specified data. If any portion of the data is incorrect, the clock will not be set.
 2. If any other device holds the access right, the clock will not be set.

Command Block

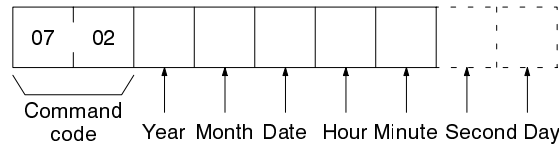

Response Block

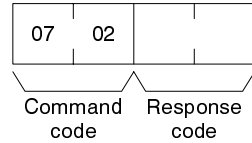

Parameters

Year, month, date, hour, minute, second, day (command): Each specified value is expressed in BCD.

Year: The rightmost two digits of the year.

Hour: Specify 00 to 23.

Day: As follows:

Value	00	01	02	03	04	05	06
Day	Sun	Mon	Tues	Wed	Thur	Fri	Sat

- Note**
1. If the second or day are not specified, 00 will be set as the second and the previous value will be kept for the day .
 2. The PC does not check the day from the date. This means that no error will occur even if the date and day do not agree.

2-25 MESSAGE READ

Reads messages generated by MSG(195).

Note The MESSAGE READ, MESSAGE CLEAR (refer to 2-26 MESSAGE CLEAR), and FAL/FALS READ commands (refer to 2-27 FAL/FALS READ) share the same command code. They are distinguished by bits 14 and 15 of the two-byte parameter following the command code. To read MSG(195) messages, bits 14 and 15 must be OFF (0).

Command Block

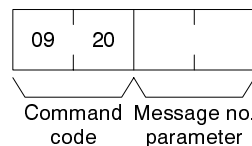

Response Block

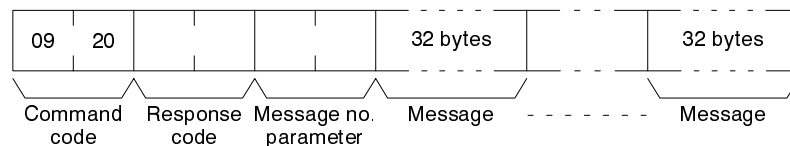

Parameters

Message no. parameter (command and response): In the command block, turn ON (1) the bits of the messages to be read. In the response block, the bits of the messages being returned will be ON (1). If no bits are turned ON in the com-

mand block, all bits will be OFF (0) in the response block and no further data will be returned.

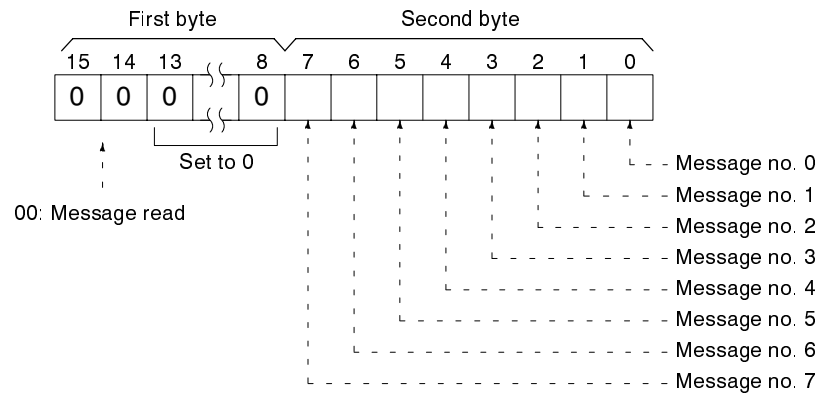

Message (response): Each message is read in the numerical order according to the message number. Each message consists of 32 ASCII characters (32 bytes). The total number of bytes of the messages is calculated as follows:

$$\text{The number of messages} * 32 \text{ bytes}$$

If no message has been registered for a message number that has been requested, 32 spaces (ASCII 20) will be returned.

2-26 MESSAGE CLEAR

Clears messages generated with MSG(195).

- Note**
1. The MESSAGE READ, MESSAGE CLEAR (refer to 2-25 MESSAGE CLEAR), and FAL/FALS READ commands (refer to 2-27 FAL/FALS READ) share the same command code. They are distinguished by bits 14 and 15 of the two-byte parameter following the command code. To clear messages, bit 14 must be ON (0) and bit 15 must be OFF (0).
 2. If any other device holds the access right, messages will not be cleared.

Command Block

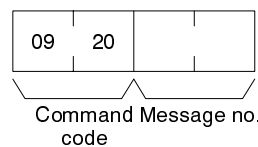

Response Block

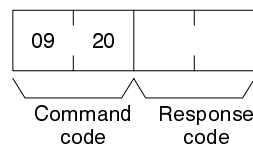

Parameters

Message no. (command): Turn ON the bits of the messages to be cleared.

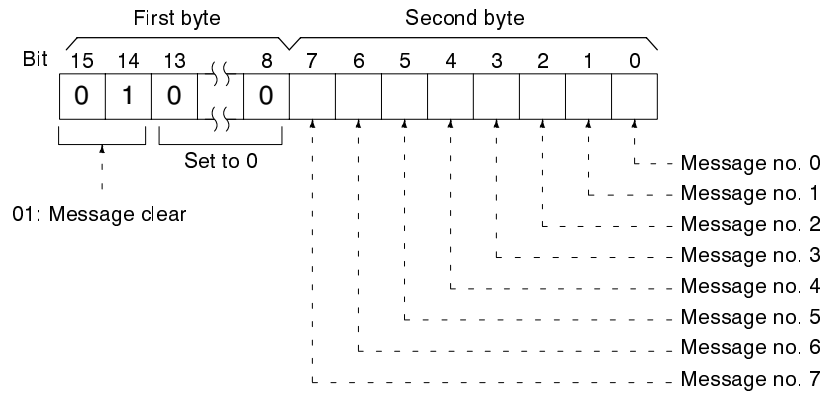

2-27 FAL/FALS READ

Reads FAL/FALS messages.

Note The MESSAGE READ (refer to 2-25 MESSAGE READ), MESSAGE CLEAR (refer to 2-26 MESSAGE CLEAR), and FAL/FALS READ commands (refer to 2-27 FAL/FALS READ) share the same command code. They are distinguished by bits 14 and 15 of the two-byte parameter after the command code. To read FAL/FALS messages, bit 14 must be OFF (0) and bit 15 must be ON (1).

Command Block

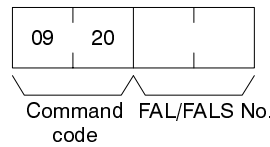

Response Block

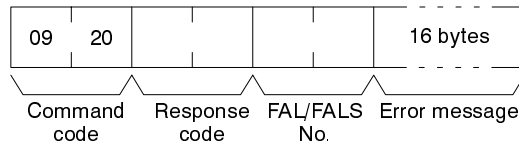

Parameters

FAL/FALS no. (command and response): In the command block, specify in hexadecimal in bits 0 to 13 the FAL or FALS number to be read as shown below. In the response block, the FAL or FALS number is returned.

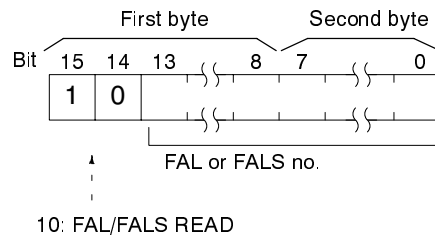

Error message (response): The error message specified in the FAL(006) or FALS(007) instruction. If there is no error, 16 spaces (ASCII 20) will be returned.

2-28 ACCESS RIGHT ACQUIRE

Acquires the access right as long as no other device holds it. Execute the ACCESS RIGHT ACQUIRE command when you need to execute commands continuously without being interrupted by other devices. As soon as the execution of the commands has been completed, execute the ACCESS RIGHT RELEASE command to release the access right (refer to 2-30 ACCESS RIGHT RELEASE). If another devices holds the access right, the device will be identified in the response.

- Note**
1. If any other device has the access right, the access right cannot be acquired with this command; use the ACCESS RIGHT FORCED ACQUIRE command (refer to 2-29 ACCESS RIGHT FORCED ACQUIRE).
 2. The following commands cannot be executed by other devices if the host computer holds the access right. Do not restrict the access right unless necessary.

PARAMETER AREA WRITE (02 02)
 PARAMETER AREA CLEAR (02 03)
 PROGRAM AREA PROTECT (03 04)
 PROGRAM AREA CLEAR (03 05)
 PROGRAM AREA WRITE (03 07)
 PROGRAM AREA PROTECT CLEAR (03 08)
 RUN (04 01)
 STOP (04 02)
 CLOCK WRITE (07 02)
 MESSAGE CLEAR (09 20)
 ACCESS RIGHT ACQUIRE (0C 01)
 ERROR CLEAR (21 01)
 ERROR LOG CLEAR (21 03)
 PARAMETER AREA FILE TRANSFER (22 0B)
 PROGRAM AREA FILE TRANSFER (22 0C)
 FORCED SET/RESET (23 01)
 FORCED SET/RESET CANCEL (23 02)

Command Block

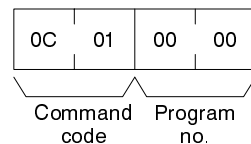

Response Block

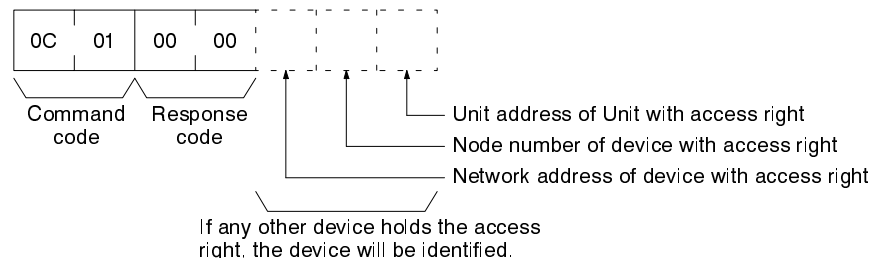

Parameters

Program no. (command): Set to 0000.

2-29 ACCESS RIGHT FORCED ACQUIRE

Acquires the access right even if another device already holds it.

- Note**
1. Even if any other device has the access right, the access right can be acquired with this command and a normal response code will be returned.

2. The following commands cannot be executed by other devices if the host computer holds the access right. Do not restrict the access right unless necessary.
 - PARAMETER AREA WRITE (02 02)
 - PARAMETER AREA CLEAR (02 03)
 - PROGRAM AREA PROTECT (03 04)
 - PROGRAM AREA CLEAR (03 05)
 - PROGRAM AREA WRITE (03 07)
 - PROGRAM AREA PROTECT CLEAR (03 08)
 - RUN (04 01)
 - STOP (04 02)
 - CLOCK WRITE (07 02)
 - MESSAGE CLEAR (09 20)
 - ACCESS RIGHT ACQUIRE (0C 01)
 - ERROR CLEAR (21 01)
 - ERROR LOG CLEAR (21 03)
 - PARAMETER AREA FILE TRANSFER (22 0B)
 - PROGRAM AREA FILE TRANSFER (22 0C)
 - FORCED SET/RESET (23 01)
 - FORCED SET/RESET CANCEL (23 02)
3. When the ACCESS RIGHT FORCED ACQUIRE command is executed while any other device has the access right, the access right of the other device will be canceled. If possible, wait until the other device completes the present operation, and then execute the ACCESS RIGHT ACQUIRE command (refer to 2-28 ACCESS RIGHT ACQUIRE).
4. The device that has lost the access right is not notified.

Command Block

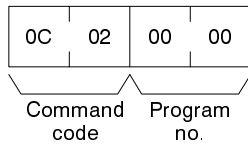

Response Block

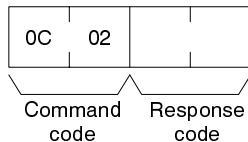

Parameters

Program no. (command): Set to 0000.

2-30 ACCESS RIGHT RELEASE

Releases the access right regardless of what device holds it. A normal response code will returned even when another device held the access right or when no device held the access right.

Command Block

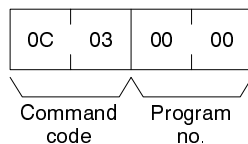

Response Block

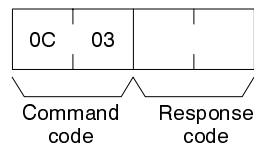

Parameters

Program no. (command): Set to 0000.

2-31 ERROR CLEAR

Clears errors or error messages from the PC. A normal response will be returned even if the error has not occurred.

Note The cause of the error must be removed before executing the ERROR CLEAR command or the same error will occur again after the ERROR CLEAR command is executed.

Command Block

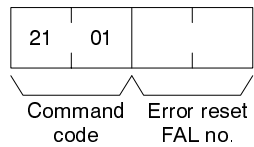

Response Block

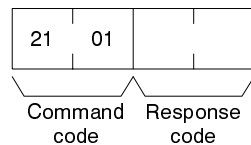

Parameters

Error reset FAL no. (command): The code of the error to be reset.

The following codes can be used regardless of the PC's mode:

Error code	Meaning
FFFE	Present error cleared. Resets the highest priority error.
0002	Power interruption error. This error occurs when the CPU power has been interrupted.
00A0 to 00A7	SYSMAC BUS error
00B0 to 00B3	SYSMAC BUS/2 error
00E7	I/O verification error. This error occurs if the I/O table differs from the actual I/O points in the System.
00F4	Non-fatal SFC error. This error occurs when there is an error while the PC is executing an SFC program.
00F7	Battery error
00F8	Indirect DM error. This error occurs when a mistake has occurred in indirectly addressing the DM Area.
00F9	JMP error. This error occurs when a jump has been specified without a destination.
0200 to 0215	CPU Bus Unit error (the rightmost two digits are the unit number in BCD of the Unit that has the error). This error occurs if there is a parity error at the time of data transfer between the CPU Bus Unit and CPU or if the CPU Bus Unit has a watchdog timer error.
0400 to 0415	CPU Bus Unit setting error (the rightmost two digits are the unit number in BCD of the Unit that has the error).
4101 to 42FF	FAL(006) executed in the user program.

The following codes can be used only when the PC is in PROGRAM mode:

Error code	Meaning
FFFF	All errors cleared.
809F	Cycle time too long
80C0 to 80C7	I/O bus error. This error occurs when there is an error in an I/O bus check or a Unit has been removed or added when power is turned on to the PC.
80E0	I/O setting error. This error occurs if the I/O table differs from actual I/O points in the System.
80E1	I/O points overflow
80E9	Duplication error. This error occurs if the same unit number is assigned more than one Unit or the same word is allocated more than once.
80F0	Program error. This error occurs if a program that exceeds memory capacity is executed.
80F1	Memory error. This error occurs if an error is found in the PC's memory, memory card, or PC Setup during an memory error check.
80F3	Fatal SFC error. This error occurs if an SFC syntax error has been discovered and the program will not execute.
80FF	System error. This error occurs if the CPU has a watchdog timer error.
8100 to 8115	CPU bus error. The rightmost two digits are the unit number in BCD of the CPU Bus Unit that has the error. This error occurs if an error is discovered during a CPU bus check.
C101 to C2FF	FALS(007) executed.

2-32 ERROR LOG READ

Reads the PC's error log.

- Note**
1. When the PC does not have the specified number of records, all the records that have been stored in the PC will be read and an address range overflow error will result.
 2. If the data is too large and exceeds the permissible length of the response block, the part in excess will not be read and a response length overflow error will result.

Command Block

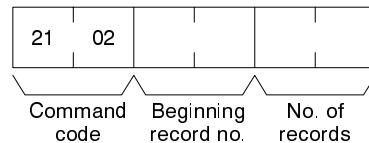

Response Block

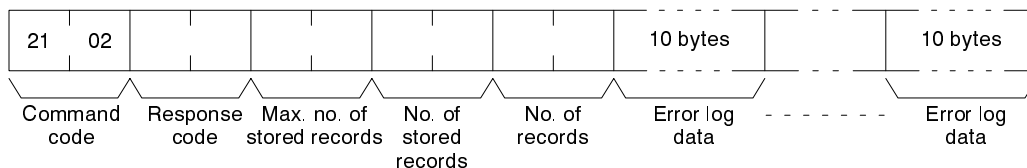

Parameters

Beginning record no. (command): The first record to be read (the first record number is 0000).

Max. no. of stored records (response): The maximum number of records that can be recorded.

No. of stored records (response): The number of records that have been recorded.

No. of records (command and response): The number of records read.

Error log data (response): The specified error log records will be returned in sequence starting from the beginning record number. The total number of bytes required is calculated as follows:

$$\text{No. of records} \times 10 \text{ bytes}$$

The configuration of each error record is as follows:

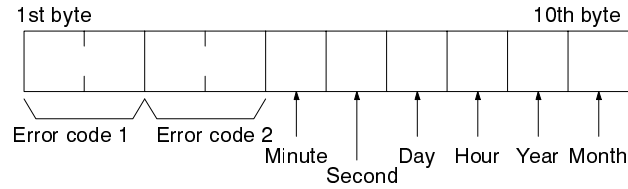

Error code 1, 2: Refer to page 42 for error code 1 and to the relevant operation manual or installation guide for error code 2.

Each data includes the second, minute, hour (0 to 23), date, month, and year (the rightmost two digits) in BCD specifying the time that the error occurred.

2-33 ERROR LOG CLEAR

Clears all error log records.

Note This command cannot be executed if any other device has the access right.

Command Block

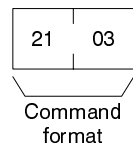

Response Block

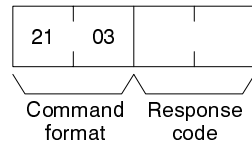

2-34 FILE NAME READ

Reads out data on the specified number of files stored in the file device connected to the PC.

Command Block

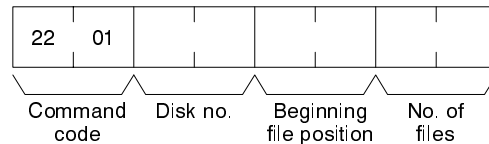

Response Block

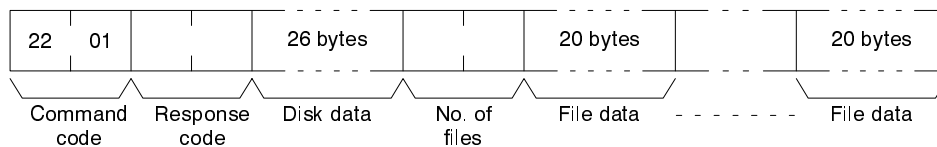

Parameters

Disk no. (command): Set to 0000 for the file device (memory card).

Beginning file position (command): The first file to be read (the first file number is 0000).

No. of files (command): The number of files to be read between 0001 and 0019.

Disk data (response): The data from the file device, the configuration of which is as follows:

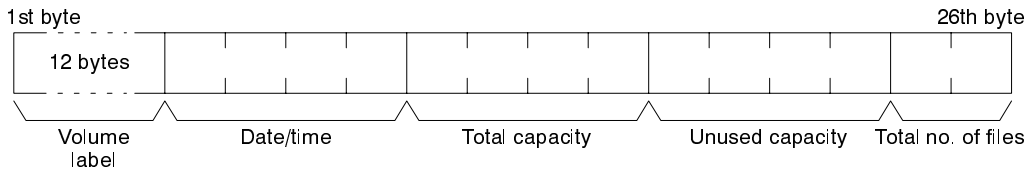

Volume Label

The volume label registered with the file device (refer to 2-3 *Volume Labels and File Names* for the configuration of the volume label). If no volume label has been registered, 20 spaces (ASCII 20) will be returned.

Date/Time

The date and time that the volume label was created (see next page).

Total Capacity and Open Capacity

The total capacity of the file device and the number of bytes still available (hexadecimal).

Total No. of Files

The number of files recorded in the file device.

No. of files (response): The number of files that have been read. Bit 15 is ON (1) if the last file is included.

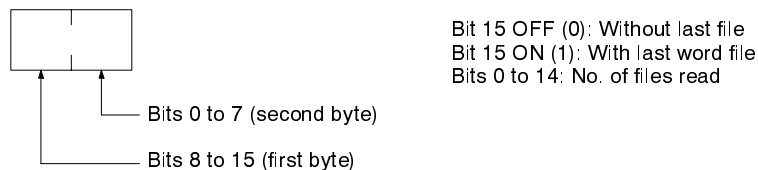

File data (response): Each file data consists of 20 bytes. The specified files will be transmitted in sequence starting from the first file. The total number of bytes required is calculated as follows:

$$\text{No. of read files} \times 20 \text{ bytes}$$

The configuration for each file data is as follows:

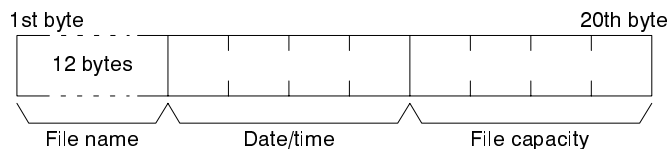

File Name

The name of the file (refer to 2-3 *Volume Labels and File Names* for the configuration of the file name).

Date/Time

The date and time that the file was created (see below).

File Capacity

The capacity (bytes) of the file.

Date/Time The configuration of the clock data (four bytes or 32 bits) is as follows:

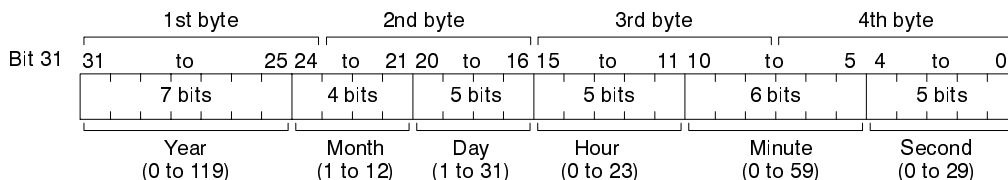

All data values are in BCD.

Year: Add 1980.

Second: Multiply by two.

2-35 SINGLE FILE READ

Reads the contents of a file stored in the file device connected to the PC.

Command Block

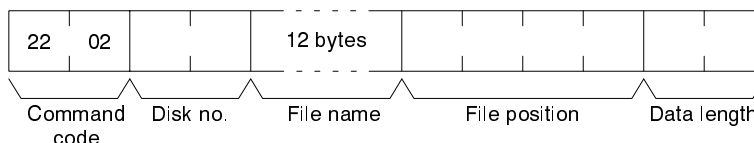

Response Block

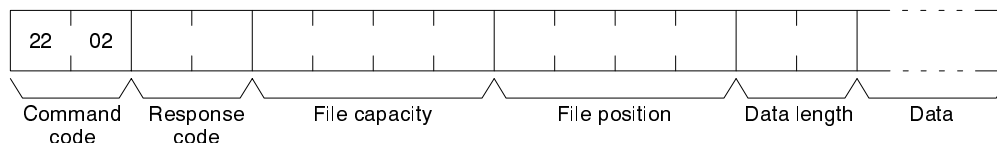

Parameters

Disk no. (command): Set to 0000 for the file device (memory card).

Beginning file name (command): The name of the file to be read (refer to 2-3 Volume Labels and File Names for the configuration of the file name).

File position (command and response): The number of bytes from the start of the file from which to start reading (files start at 00000000).

Data length (command and response): The number of bytes of data to read.

File capacity (response): The capacity (bytes) of the file that was read.

Note If the SINGLE FILE READ command is executed for a file with a file capacity of 0 bytes, the data length will be returned as 0000 and no data will be read.

Data (response): The specified data in sequence starting from the specified byte.

2-36 SINGLE FILE WRITE

Writes a new file to the file device connected to the PC or appends/overwrites an existing file stored in the file device. Designation can be made to protect existing files if an attempt is made to create a new file of the same name as an existing file. When a new file is written or an existing file is modified, the file will record the clock data of the PC as the date of the file.

Note Writing a new file or modifying an existing file must be done within the capacity of the file device or the SINGLE FILE WRITE command cannot be executed.

Command Block

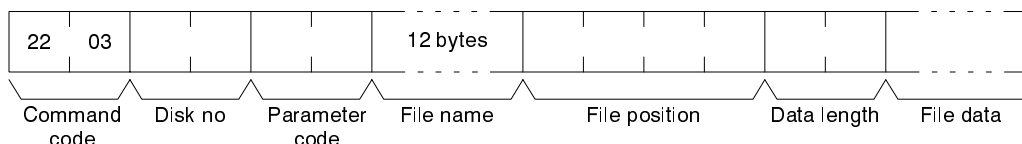

Response Block

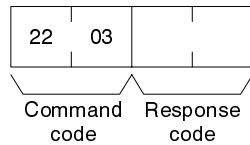

Parameters

Disk no. (command): Set to 0000 for the file device (memory card).

Parameter code (command): As follows:

0000: Writes a new file. If a file with the same name already exists, the new file will not be created.

0001: Writes a new file. If a file with the same name already exists, it will be overwritten

0002: Add data to an existing file.

0003: Overwrite an existing file.

File name (command): The name of the file to be written (refer to *2-3 Volume Labels and File Names* for the configuration of the file name).

File position (command): The number of bytes from the start of the file from which to start writing (files start at 00000000). To create a new file or add data to an existing file, specify 00000000 as the file position.

Data length (command and response): The number of bytes to be written.

Note A new file with a file capacity of 0 (no data) will be created if SINGLE FILE WRITE is executed with 0000 as the data length.

File data (response): The data to be written to the file.

2-37 MEMORY CARD FORMAT

Formats a memory card. Always execute the MEMORY CARD FORMAT before using a new memory card as a file device.

Note If the MEMORY CARD FORMAT command is executed, all data will be cleared from the memory card.

Command Block

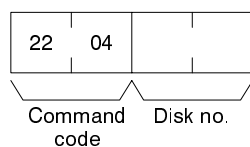

Response Block

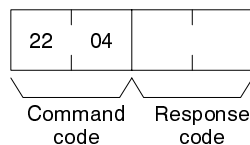

Parameters

Disk no. (command): Set to 0000 for the file device (memory card).

2-38 FILE DELETE

Deletes files stored by the file device connected to the PC.

Note 1. The specified files will be deleted in sequence. If non-existing file names have been specified, the PC will ignore them and the operation will continue.

- If the specified number of files and the number of file names do not coincide, no files will be deleted.

Command Block

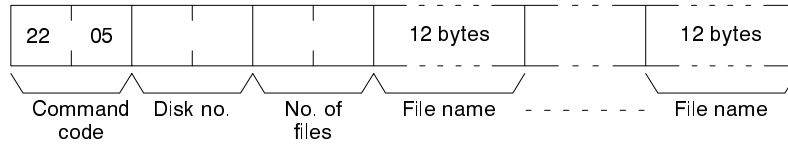

Response Block

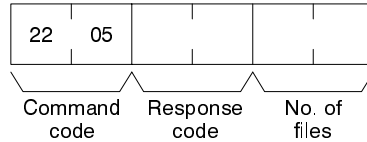

Parameters

- Disk no. (command):** Set to 0000 for the file device (memory card).
- No. of files (command):** The number of files to be deleted.
- File name (command):** The names of the files to be deleted (refer to 2-3 Volume Labels and File Names for the configuration of the file name).
- No. of files (response):** The number of files that have been deleted.

2-39 VOLUME LABEL CREATE/DELETE

Creates a volume label on the file device connected to the PC or deletes an existing volume label from the file device.

Only one volume label can be created for a single memory card.

When a volume label is generated, the clock data of the PC will be recorded as the date of the volume label.

Command Block

The command format for creating a volume label is as follows:

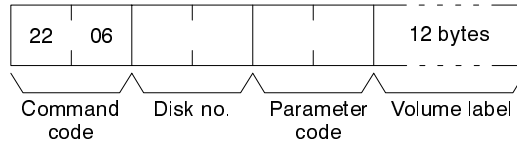

The command format for deleting a volume label is as follows:

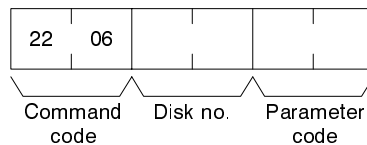

Response Block

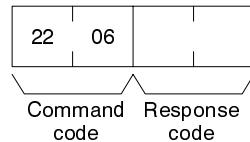

Parameters

- Disk no. (command):** Set to 0000 for the file device (memory card).
- Parameter code (command and response):** As follows:
 - 0000:** Creates a new volume label. If a label already exists, nothing will be executed.

0001: Creates a volume label. If a label already exists, it will be overwritten.

0002: Deletes an existing volume label.

Volume label (command): The volume label to be written (refer to *2-3 Volume Labels and File Names* for the configuration of the volume label).

2-40 FILE COPY

Copies a file from one file device to another file device connected to the same PC.

Command Block

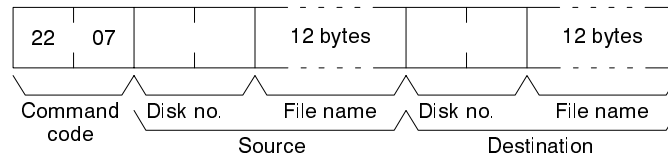

Response Block

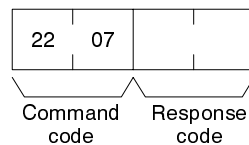

Parameters

Disk no. (command): Set to 0000 for the file devices (memory cards).

File name (command): The file to be copied and a new name for the copied file (refer to *2-3 Volume Labels and File Names* for the configuration of the file name).

- Note**
1. The file will not be copied if an existing file name is given.
 2. The copied file is given the same date as the original file.

2-41 FILE NAME CHANGE

Changes a file name.

Command Block

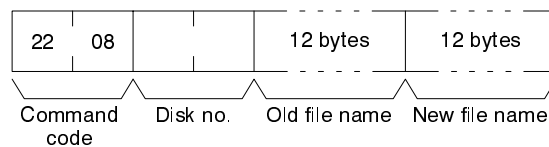

Response Block

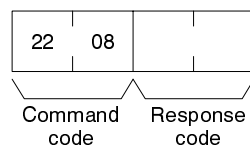

Parameters

Disk no. (command): Set to 0000 for the file device (memory cards).

Old and new file names (command): The original file name and a new name for the file (refer to *2-3 Volume Labels and File Names* for the configuration of the file name).

- Note**
1. The file name will not be changed if an existing file name is given for the new file.
 2. The new file is given the same date as the original file.

2-42 FILE DATA CHECK

Does a data check on a file stored in the extended memory (file device) connected to the PC by confirming the checksum at the beginning of the file.

Command Block

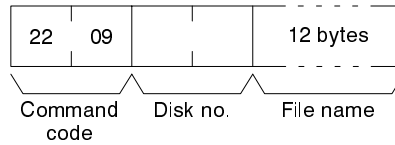

Response Block

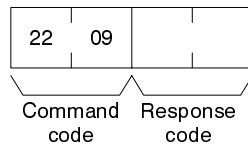

Parameters

Disk no. (command): Set to 0000 for the file device (memory cards).

File name (command): The file to be checked (refer to 2-3 Volume Labels and File Names for the configuration of the file name).

File Data Check

The configuration of a file stored in the file device is as follows:

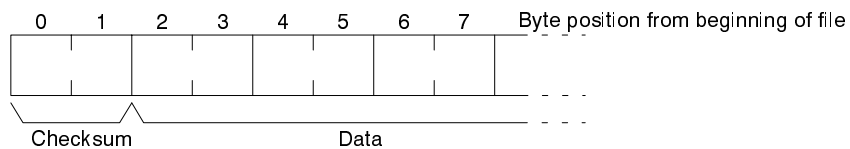

Checksum

The first two bytes of a file are called the checksum, which is the rightmost two bytes resulting from adding all data words (two bytes each). If the number of all bytes is odd, a byte of 00 is added to it so that the number of the number of bytes is even.

Example

- **Data:** 13 3A E4 F3 CC 0B 3C 5F A2
- **Words:** 133A E4F3 CC0B 3C5F A200
- **Total:** 133A + E4F3 + CC0B + 3C5F + A200 = 2A297
- **Checksum:** A2 97

Data

“File data” refers to the data in a file that a file device stores. A file data check is done with the checksum. To complete a file data check, the data words starting from the third byte are added and the result is compared with the checksum. If these values are the same, the file is assumed to contain no errors; if the values differ, a parity/sum check error will result. A file with a capacity of two bytes has a checksum of 0000.

2-43 MEMORY AREA FILE TRANSFER

Transfers or compares data between the PC memory areas and the file device connected to the PC. The clock data of the PC upon completion of the MEMORY AREA FILE TRANSFER command will be recorded as the date of the file that has been transferred.

- Note** 1. The checksum is stored at the front (bytes 0 and 1) of the file. Thus file transfer or comparison is effective from the next byte after the checksum.

2. The MEMORY AREA FILE TRANSFER command can be executed regardless of the PC's mode. It is the user's responsibility to program steps to prohibit this command from being executed when the PC is in RUN mode if such protection is necessary. Execute the CONTROLLER STATUS READ command (refer to 2-21 CONTROLLER STATUS READ) to read the PC's mode.
3. If data is written to the Timer/Counter PV Area, the Completion Flags will be turned OFF (0).

Command Block

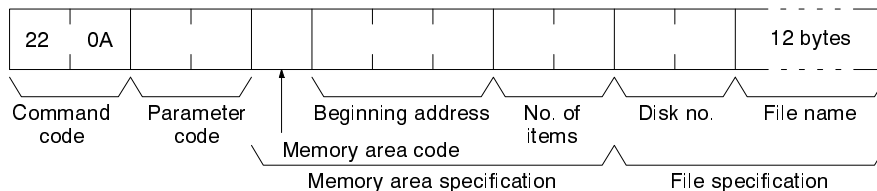

Response Block

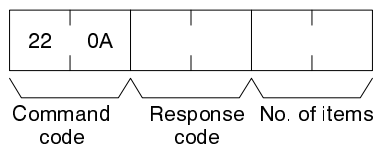

Parameters

Parameter code (command): As follows:

- 0000:** Data transfer from the PC memory area to the file device.
- 0001:** Data transfer from the file device to the PC memory area.
- 0002:** Data compared.

Memory area code (command): The memory area to be used for data transfer or comparison.

Beginning address (command): The first word/value in the memory area to be transferred or compared.

No. of items (command and response): In the command block, the number of items to be transferred or compared. In the response block, the number of items transferred or compared.

Disk no. (command): Set to 0000 for the file device (memory cards).

File name (command): The file to be transferred or compared (refer to 2-3 Volume Labels and File Names for the configuration of the file name).

Memory Areas

The following data can be used for transfer or comparison (refer to 2-2 Memory Area Designations for memory area designations):

Memory area	Data	Memory area code	No. of bytes
CIO, TR, CPU Bus Link, and Auxiliary	Word contents	80	2
Timer/Counter	PV	81	2
DM	Word contents	82	2
Expansion DM	Word contents, specified bank	90 to 97 (banks 0 to 7)	2
	Word contents, current bank	98	2

2-44 PARAMETER AREA FILE TRANSFER

Compares or transfers data between the PC's parameter area and the file device connected to the PC. The clock data of the PC upon completion of the PARAMETER AREA FILE TRANSFER command will be recorded as the date of the file that has been transferred.

A file can be transferred to the I/O table only when the PC is in PROGRAM mode.

- Note**
1. The checksum is stored at the front (bytes 0 and 1) of the file. Thus file transfer or comparison is effective from the next byte after the checksum.
 2. The PARAMETER AREA FILE TRANSFER command can be executed regardless of the PC's mode. It is the user's responsibility to program steps to prohibit this command from being executed when the PC is in RUN mode if such protection is necessary. Execute the CONTROLLER STATUS READ command (refer to 2-21 *CONTROLLER STATUS READ*) to read the PC's mode.
 3. This command cannot be executed if any other device holds the access right or when memory is write-protected via the key switch on the front panel of the PC.

Command Block

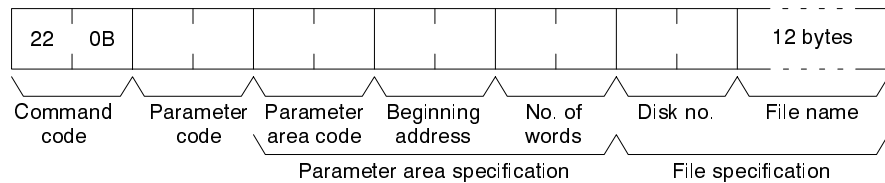

Response Block

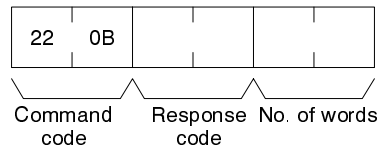

Parameters

Parameter code (command): As follows:

- 0000:** Data transfer from the PC's parameter area to the file device.
- 0001:** Data transfer from the file device to the PC's parameter area.
- 0002:** Data compared.

Parameter area code (command): The parameter area to be used for data transfer or comparison.

Beginning address (command): The first word in the parameter area to be transferred or compared. Each parameter area has consecutive word addresses beginning at 0000.

No. of words (command and response): In the command block, the number of data words to be transferred or compared. In the response block, the number of words transferred or compared

Note If 0000 is specified as the number of items, no data will be transferred or compared and a normal response code will be returned.

Disk no. (command): Set to 0000 for the file device (memory cards).

File name (command): The file to be transferred or compared (refer to 2-3 *Volume Labels and File Names* for the configuration of the file name).

Parameter Areas

The following shows the parameter areas and the words that can be specified.

The word ranges in parentheses show the possible values for the beginning word.

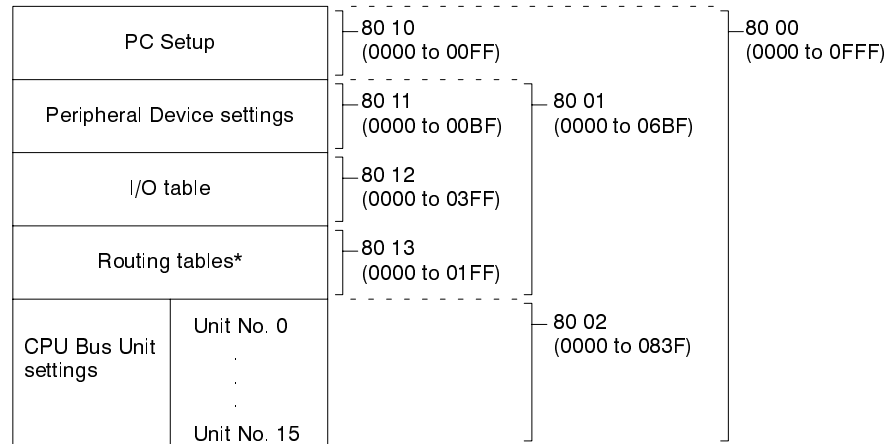

Note *Although the routing tables have a 512-word area (0000 to 01FF), only a 48-word area (0000 to 003F) of it can be read/written.

2-45 PROGRAM AREA FILE TRANSFER

Compares or transfers data between the PC's program area and the file device connected to the PC. The clock data of the PC upon completion of the PROGRAM AREA FILE TRANSFER command will be recorded as the date of the file that has been transferred.

- Note**
1. The checksum is stored at the front (bytes 0 and 1) of the file. Thus file transfer or comparison is effective from the next byte after the checksum.
 2. This command cannot be executed when the access right is held by any other device or when the PC is write-protected by the key switch on the front panel.
 3. The PROGRAM AREA FILE TRANSFER command cannot be executed when the PC is in the RUN mode.

Command Block

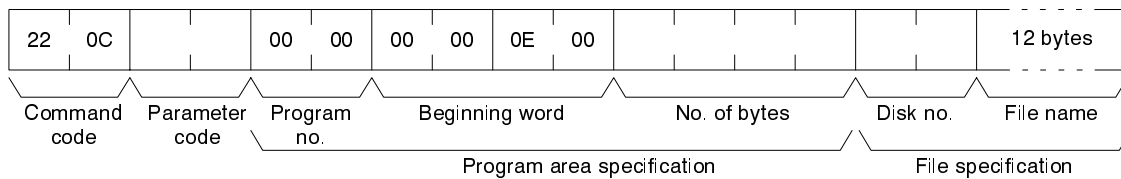

Response Block

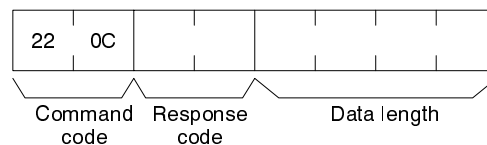

Parameters

Parameter code (command): As follows:

- 0000:** Data transferred from the program area to the file device.
- 0001:** Data transferred from the file device to the program area.
- 0002:** Data compared.

Program no. and beginning word (command): As follows:

- 0000:** Program no.
- 0000E00:** Beginning word

No. of bytes (command): The number of data bytes to be transferred or compared as follows:

0000F1FE: CV500 or CVM1

0001F1FE: CV1000 or CV2000

Note If 00000000 is specified as the number of transfer data bytes, no file transfer or comparison will be performed and a normal response code will be returned.

Disk no. (command): Set to 0000 for the file device (memory card).

File name (command): The file to be transferred or compared (refer to 2-3 *Volume Labels and File Names* for the configuration of the file name).

Data length (response): The number of bytes that have been transferred or compared.

2-46 FORCED SET/RESET

Force-sets (ON) or force-resets (OFF) bits/flags or releases force-set status. Bits/flags that are forced ON or OFF will remain ON or OFF and cannot be written to until the forced status is released.

Note This command cannot be used to release the status of Completion Flags for timers or counters. Use the FORCE SET/RESET CANCEL command (refer to 2-47 *FORCE SET/RESET CANCEL*).

Command Block

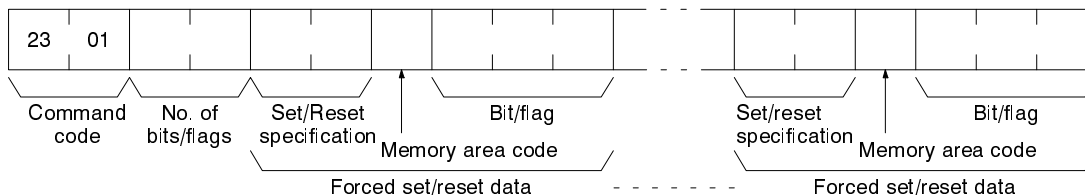

Response Block

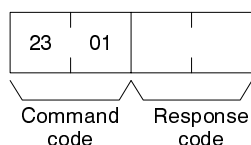

Parameters

No. of bits/flags (command): The number of bits/flags to be controlled.

Set/Reset specification (command): The action to be taken for each bit/flag

Value	Name
0000	Force-reset (OFF)
0001	Force-set (ON)
8000	Forced status released and bit turned OFF (0)
8001	Forced status released and bit turned ON (1)
FFFF	Forced status released

Memory area code (command): The memory area of the bit or flag to be controlled.

Bit/Flag (command): The bit or flag to be controlled.

Memory Areas

The bits (flags) in the following memory areas can be forced set/reset or released (refer to 2-2 *Memory Area Designations* for memory area designations):

Memory area	Data	Memory area code
CIO, TR, and CPU Bus Link (see note)	Bits status	00
Timer/Counter	Completion Flag status	01
Transition	Flag status	03

Note FORCED SET/RESET cannot be used for the Auxiliary Area.

2-47 FORCED SET/RESET CANCEL

Cancels all bits (flags) that have been forced ON or forced OFF.

Command Block

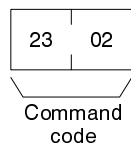

Response Block

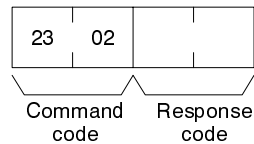

Note The bits (flags) in the following memory areas can be forced set or forced reset, and cancelled.

Memory area	Data	Memory code
CIO, TR, CPU Bus Link, and Auxiliary	Bits status	00
Timer/Counter	Completion Flag status	01
Transition	Flag status	03

2-48 Aborting Commands

The CV mode does not support an abort command. If an abort command is necessary, use the C-mode ABORT command (XZ).

SECTION 3

Commands for C-series PCs

This section provides details on commands that can be sent to C-series PCs. The C-series PCs that support these commands are listed in the following table.

PC	Model number	Remarks
C200H	C200H-CPU11-E	Use C200H-SLK11/SLK21-V1 SYSMAC LINK Unit
C1000H	C1000H-CPU01-EV1	Use C1000H-SLK11/SLK21-V1 SYSMAC LINK Unit
C2000H Simplex	C2000H-CPU01-EV1	

3-1	Command List	58
3-2	Memory Area Designations	58
3-2-1	Word/Bit Addresses	59
3-2-2	Data Configuration	59
3-3	MEMORY AREA READ	60
3-4	MEMORY AREA WRITE	61
3-5	MULTIPLE MEMORY AREA READ	61
3-6	PROGRAM AREA READ	62
3-7	PROGRAM AREA WRITE	63
3-8	RUN	63
3-9	STOP	64
3-10	CONTROLLER DATA READ	64
3-11	CONTROLLER STATUS READ	65
3-12	CLOCK READ	66
3-13	CLOCK WRITE	67
3-14	ERROR CLEAR	67
3-15	FILE MEMORY INDEX READ	68
3-16	FILE MEMORY READ	68
3-17	FILE MEMORY WRITE	69
3-18	FORCED SET/RESET	70
3-19	FORCED SET/RESET CANCEL	71
3-20	MULTIPLE FORCED STATUS READ	71

3-1 Command List

The beginning portions of the command and response block up to the command codes and the FCS and terminator have been omitted for simplicity, but must be added for actual transmission if not automatically generated for the transmission method being used. Refer to *1-3 Command/Response Transmission Data*.

In the illustrations of command and response blocks in this section, each box represents one byte (i.e., two hexadecimal or BCD digits). Be careful when adding the header, where each box represents one digit (i.e., four bits).

The following table lists the FINS commands supported by C-series PCs and the PC operating modes during which they are enabled.

Command code		Name	PC mode			Page
			RUN	MONITOR	PROGRAM	
01	01	MEMORY AREA READ	Valid	Valid	Valid	60
	02	MEMORY AREA WRITE	Valid	Valid	Valid	61
	04	MULTIPLE MEMORY AREA READ	Valid	Valid	Valid	61
03	06	PROGRAM AREA READ	Valid	Valid	Valid	62
	07	PROGRAM AREA WRITE	Not valid	Not valid	Valid	63
04	01	RUN	Valid	Valid	Valid	63
	02	STOP	Valid	Valid	Valid	64
05	01	CONTROLLER DATA READ	Valid	Valid	Valid	64
06	01	CONTROLLER STATUS READ	Valid	Valid	Valid	65
07	01	CLOCK READ (C200H only)	Valid	Valid	Valid	66
	02	CLOCK WRITE (C200H only)	Not valid	Valid	Valid	67
21	01	ERROR CLEAR	Valid	Valid	Valid	67
22	0F	FILE MEMORY INDEX READ (Not with C200H)	Valid	Valid	Valid	68
	10	FILE MEMORY READ (Not with C200H)	Valid	Valid	Valid	68
	11	FILE MEMORY WRITE (Not with C200H)	Not valid	Valid	Valid	69
23	01	FORCED SET/RESET	Not valid	Valid	Valid	70
	02	FORCED SET/RESET CANCEL	Not valid	Valid	Valid	71
	0A	MULTIPOINT FORCED STATUS READ (C200H only)	Valid	Valid	Valid	71

3-2 Memory Area Designations

The following table gives the addresses to use when reading or writing PC data. The *Data area address* column gives the normal addresses used in the PC program. The *Address used in communications* column are the addresses used in CV-mode commands and responses. These addresses are combined with the memory area codes to specify PC memory locations. These addresses are not the same as the actual memory addresses of the data.

The *No. of bytes* column specifies the number of bytes to read or write data for that area. The number of bytes varies for the same area depending on the memory area code. Actual data area sizes vary with the PC being used. Refer to your PC's operation manual for specific limits.

Memory area	Data	Data area address	Address used in communications		Memory area code	No. of bytes
			1st and 2nd bytes	3rd byte		
CIO area	Bit status	00000 to 25515	0000 to 00FF	00 to 0F	00	1
	Word contents	000 to 255		00 to 00	80	2
LR area	Bit status	LR 0000 to LR 6315	03E8 to 0427	00 to 0F	00	1
	Word contents	LR 00 to LR 63		00 to 00	80	2
HR area	Bit status	HR 0000 to HR 9915	0428 to 048B	00 to 0F	00	1
	Word contents	HR 00 to HR 99		00 to 00	80	2
AR area	Bit status	AR 0000 to AR 2715	048C to 04A7	00 to 0F	00	1
	Word contents	AR 000 to AR 27		00 to 00	80	2
Timer Area/ Counter Area	Completion Flag status	TIM 000 to TIM 511 CNT 000 to CNT 511	0000 to 01FF	00 to 00	01	1
	PV	TIM 000 to TIM 511 CNT 000 to CNT 511		00 to 00	81	2
DM Area	Word contents	DM 0000 to DM 9999	0000 to 270F	00 to 00	82	2

3-2-1 Word/Bit Addresses

Each word/bit address specifies a specific bit or word. The rightmost two digits of the address specify bit 00 to 15 (or 00 if not required), and leftmost four digits specify the word address.

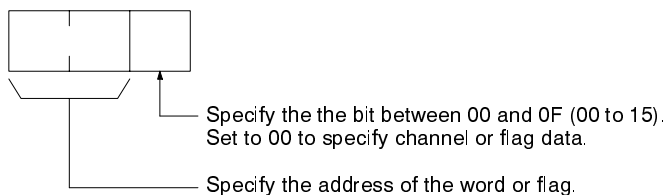

To obtain the corresponding address of the desired word or bit, add the data area word address (hexadecimal) to the first address of the range of addresses used for that data area in communications. For example, the address for word AR 13 is computed as follows:

$$\begin{aligned} \text{First address for AR Area;} & \quad 048C \\ 048C + 0D \text{ (13 in BCD);} & \quad 0499 \end{aligned}$$

The word address for AR 13 would be 049900 (the memory area code would specify this as a word) and the address of bit 12 in AR 13 would be 04990C.

The unit of access (bit or word) and the data code are specified as shown in the following illustration.

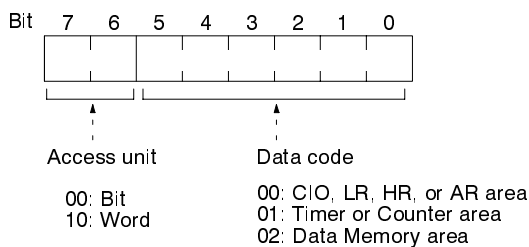

3-2-2 Data Configuration

The configuration of the various types of data that can be read or written is shown below. The number of bytes required for each type of data is also given.

Flag or Bit Status (One Byte) 00: Bit is OFF (0)
01: Bit is ON (1)

Word Contents or PV (Two Bytes)

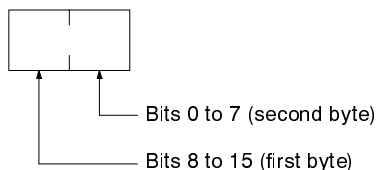

3-3 MEMORY AREA READ

Reads the contents of the specified number of consecutive memory area words starting from the specified word. All words must be in the same memory area (here, all memory areas with the same memory area code are considered as one area).

Command Block

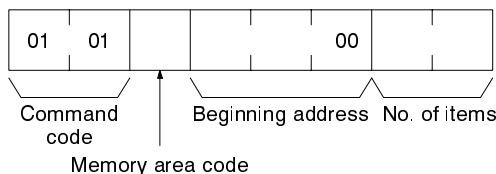

Response Block

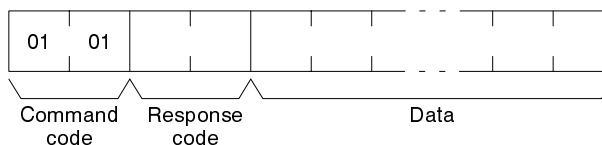

Parameters

Memory area code (command): The data area to read.

Beginning address (command): The address of the first word/bit/flag to read from memory. Specify 00 for the 3rd byte.

No. of items (command): The number of items to be read. Specify 0000 to 0100 (0 to 256 decimal). The command can complete normally even if zero items are specified.

Data (response): The data from the specified words is returned in sequence starting from the beginning address. PVs for timers and counters are returned as BCD. The required number of bytes in total is calculated as follows:

$$\text{No. of bytes required by each item} \times \text{No. of items}$$

Memory Areas

The following area can be read (refer to 3-2 Memory Area Designations for PC word/bit address designations):

Memory area	Data	Memory area code	No. of bytes
CIO, LR, HR, or AR area	Word contents	80	2
Timer/Counter	Completion Flag status	01	1
	PV	81	2
DM	Word contents	82	2

3-4 MEMORY AREA WRITE

Writes data to the specified number of consecutive words starting from the specified word. All words must be in the same memory area (here, all memory areas with the the same memory area code are considered as one area).

Note When data is written to the Timer/Counter PV Area, the Completion Flags will be turned OFF (0).

Command Block

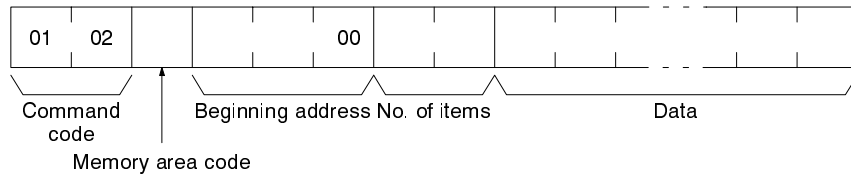

Response Block

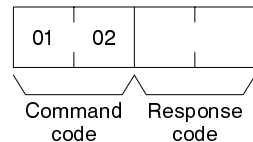

Parameters

Memory area code (command): The data area to write.

Beginning address (command): The first word/value to write. Specify 00 for the 3rd byte.

No. of items (command): The number of items to be written. Specify 0000 to 0100 (0 to 256 decimal). The command can complete normally even if zero items are specified.

Data (command): The data to be written. PVs for timers and counters are written as BCD. The required number of bytes in total is calculated as follows:

$$2 \text{ bytes} \times \text{No. of items}$$

The following data can be written (refer to 3-2 Memory Area Designations for the word/bit address designations):

Memory area	Data	Memory area code	No. of bytes
CIO, LR, HR, or AR area	Word contents	80	2
Timer/Counter	PV	81	2
DM	Word contents	82	2

3-5 MULTIPLE MEMORY AREA READ

Reads the contents of the specified number of non-consecutive memory area words, starting from the specified word.

Note If there is an error in the command code or an address, no data will be read.

Command Block

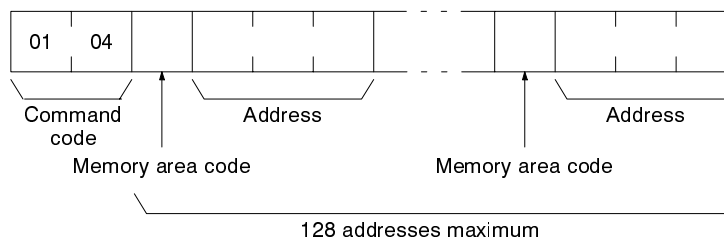

Response Block

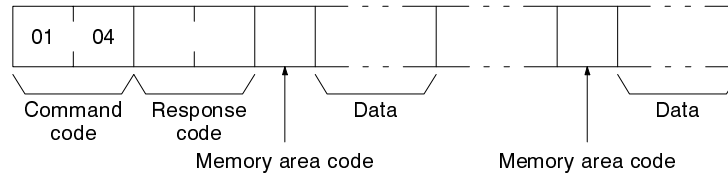

Parameters

Memory area code (command): The data area to read.

Address (command): The word/bit/flag to read. The content of up to 128 address can be read.

Data (response): The data in the specified memory area(s) will be returned in sequence starting from the beginning address.

Memory Areas

The following data can be written (refer to 3-2 Memory Area Designations for memory area designations):

Memory area	Data	Memory area code	No. of bytes
CIO, LR, HR, or AR area	Bit status	00	1
	Word contents	80	2
Timer/Counter	Completion Flag status	01	1
	PV	81	2
DM	Word contents	82	2

3-6 PROGRAM AREA READ

Reads the contents of the specified number of consecutive program area words starting from the specified word. The program is read a machine language (object code). A maximum of 512 bytes can be read with each command.

Command Block

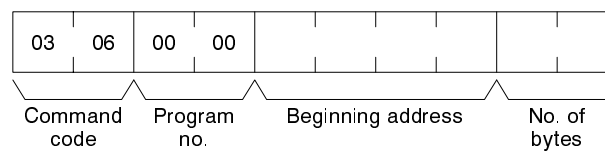

Response Block

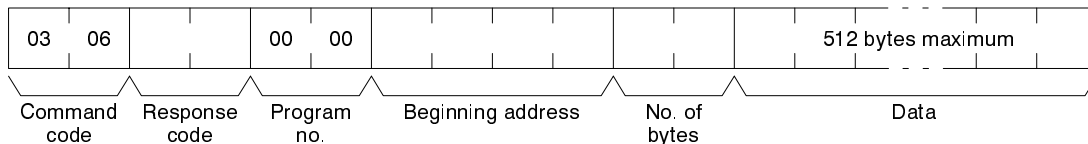

Parameters

Program no. (command and response): Set to 0000.

Beginning address (command and response): Set an relative byte address with 00000000 as the starting address. The beginning word must be an even number. The address set in the command will be returned in the response.

No. of bytes (command and response): The number of bytes in an even number 0200 (512 in decimal) or smaller. The number of bytes actually read will be

returned in the response. Bit 15 will be ON (1) in the response block when the last word data of the program area is returned.

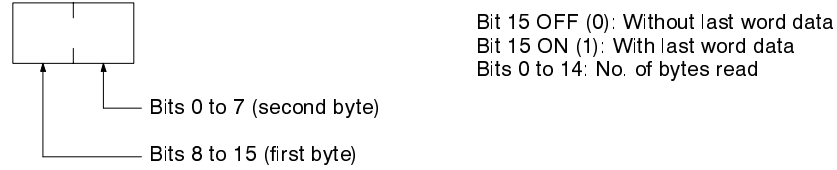

Note If the designated number of bytes is larger than the program area, the program will be read through the final address and a response code indicating an address range error or response length error will be returned.

Data (response): The data in the specified program area will be returned in sequence starting from the beginning word.

3-7 PROGRAM AREA WRITE

Writes data to the specified number of consecutive program area words starting from the specified word. A maximum of 512 bytes can be written with each command. To write larger amounts of data, use multiple commands and specify the beginning word and number of words for each.

Command Block

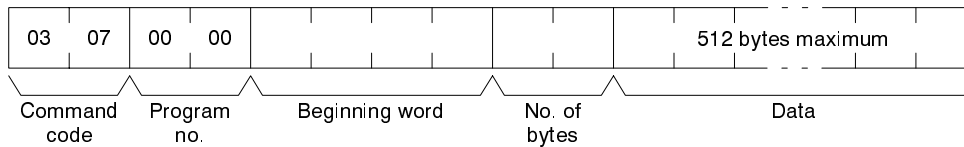

Response Block

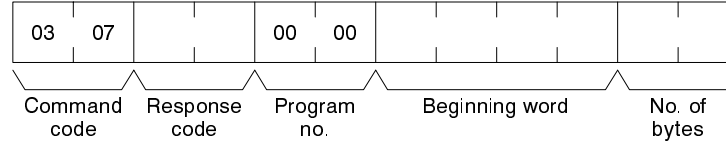

Parameters

Program no. (command and response): Set to 0000.

Beginning word (command and response): Set a relative byte address with 00000000 as the starting address. The beginning word must be an even number. The address set in the command will be returned in the response.

No. of bytes (command and response): The number of bytes in an even number (512 or smaller). The number of bytes actually written will be returned in the response. Bit 15 must be turned ON (1) when data for the last write to the program area so that the PC can generate an index. To write only an index marker, specify 8000 for the number of bytes.

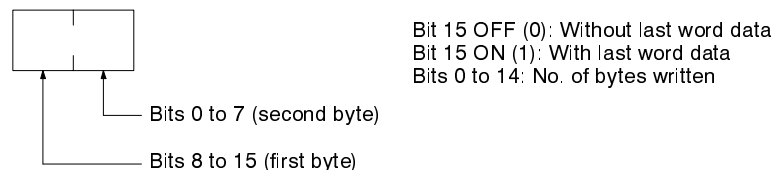

Data (command): The data to be written.

3-8 RUN

Changes the PC to MONITOR or RUN mode, enabling the PC to execute its program.

Command Block

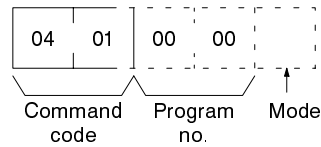

Response Block

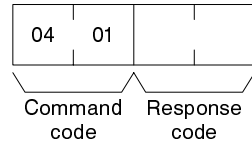

Parameters

Program no. (command): Set to 0000.

Mode (command): As follows:

- 02: MONITOR mode
- 04: RUN mode

Note If the mode is not specified, the PC will go to MONITOR mode.

3-9 STOP

Changes the PC to PROGRAM mode, stopping program execution.

Command Block

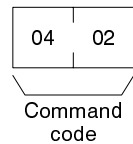

Response Block

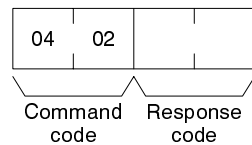

3-10 CONTROLLER DATA READ

Reads the following data:

- Controller model and version
- Area data
- PC status

Command Block

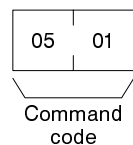

Response Block

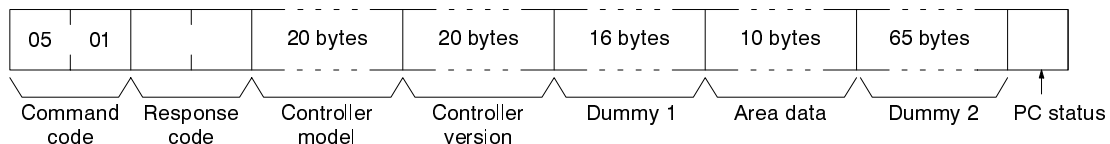

Parameters

Controller model and Controller version (response): Both are returned in ASCII (20 bytes (i.e., 20 ASCII characters) max. each). The version of MPU1 is returned first followed by the version of MPU2. If the model or version information does not require 20 bytes, the remainder of the 20 bytes will be filled with spaces (ASCII 20).

Dummy 1 and Dummy 2 (response): All zeros will be returned.

Area data (response): As follows:

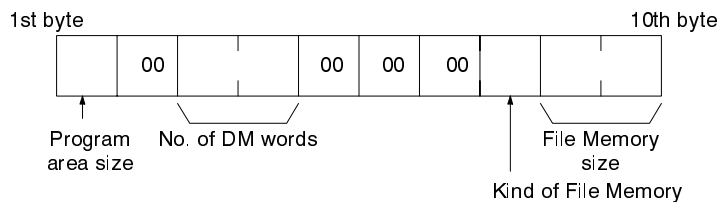

Item	Meaning	Unit
Program area size	The size of PC Setup and program area	K words (1K words = 1,024 words; 1 word = 2 bytes)
No. of DM words	Total words in the DM area	Words (1 word = 2 bytes)
Kind of File Memory	00: No File Memory 01: SRAM 04: First half RAM, second half ROM	---
File Memory size	Total number of blocks in File Memory 0000: 0 (no File Memory) 0001: 1,000 blocks (decimal) 0002: 2,000 blocks (decimal)	

PC status (response): The following status (8 bits) is returned:

00: No recognized tool connected

80: Recognized tool connected

3-11 CONTROLLER STATUS READ

Reads the status of the Controller.

Command Block

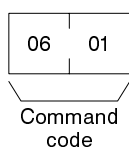

Response Block

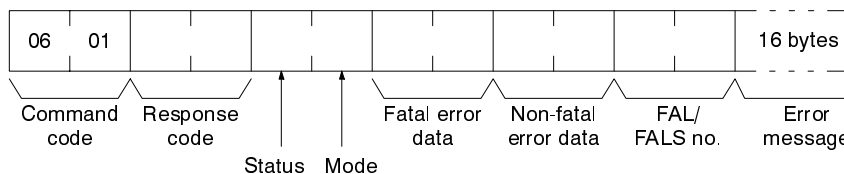

Parameters

Status (response): The operating status of the PC as follows:

00: Stop (program not being executed)

01: Run (program being executed)

80: CPU on standby (the start switch is OFF or the CPU is waiting for a signal from a device such as a Remote I/O Slave Unit).

Mode (response): One of the following PC modes:

00: PROGRAM

02: MONITOR

04: RUN

Fatal error data (response): The contents of fatal error information from the PC (for details refer to your *PC Operation Manual*).

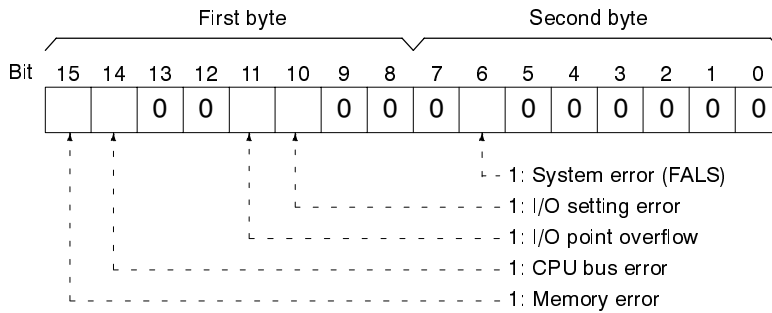

Non-fatal error data (response): The contents of non-fatal error information from the PC (for details refer to your *PC Operation Manual*).

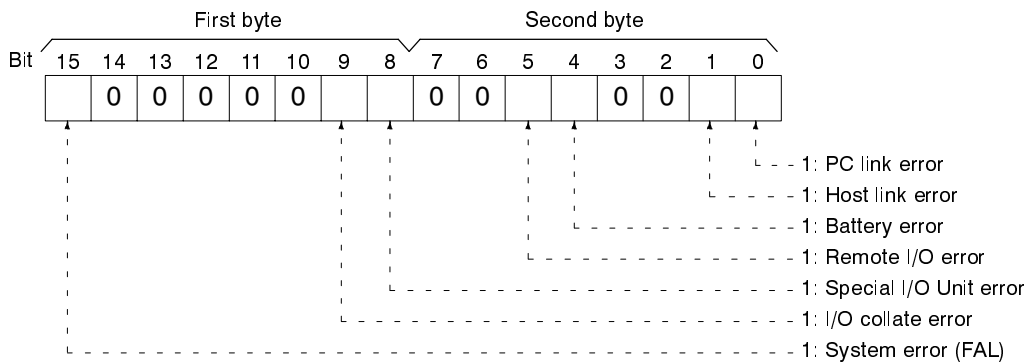

FAL/FALS no. (response): The number of the highest priority FAL/FALS error is returned as BCD between 00 and 99 (decimal) to the second byte. The first byte is always 00. If no error has occurred, 0000 is returned.

Error message (response): The error message of the present FAL/FALS number is returned as 16 ASCII characters (16 bytes). If there is no error, nothing will be returned.

3-12 CLOCK READ

Reads the clock. This command is valid for the C200H only.

Command Block

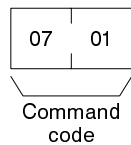

Response Block

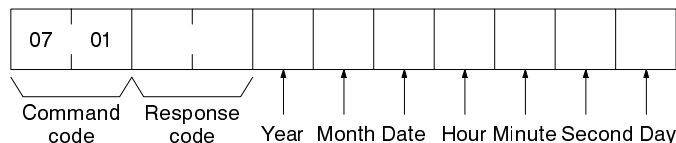

Parameters

Year, month, date, hour, minute, second, day (response): Each value is expressed in BCD.

Year: The rightmost two digits of the year.

Hour: 00 to 23.

Day: As follows:

Value	00	01	02	03	04	05	06
Day	Sun	Mon	Tues	Wed	Thur	Fri	Sat

3-13 CLOCK WRITE

Sets the clock. This command is valid for the C200H only.

Note Specify all data.

Command Block

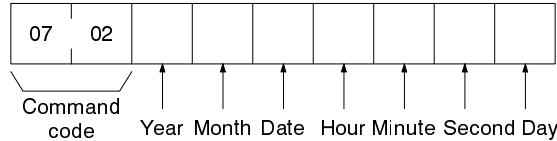

Response Block

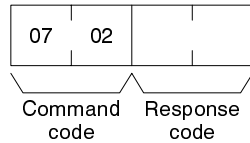

Parameters

Year, month, date, hour, minute, second, day (command): Each specified value is expressed in BCD.

Year: The rightmost two digits of the year.

Hour: Specify 00 to 23.

Day: As follows:

Value	00	01	02	03	04	05	06
Day	Sun	Mon	Tues	Wed	Thur	Fri	Sat

3-14 ERROR CLEAR

Clears errors from the PC. A normal response will be returned even if an error has not occurred.

Note The cause of the error must be removed before executing the ERROR CLEAR command or the same error will occur again after the ERROR CLEAR command is executed.

Command Block

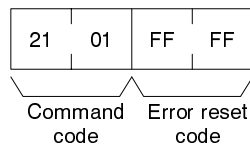

Response Block

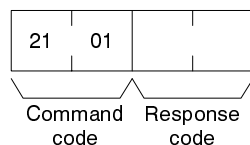

Parameters

Error reset code (command): Set to FFFF.

3-15 FILE MEMORY INDEX READ

Reads the File Memory index for the specified number of blocks from the specified beginning block number.

Note This command is valid for the C1000H and C2000H only. Refer to the *File Memory Unit Operation Manual* for details on the File Memory.

Command Block

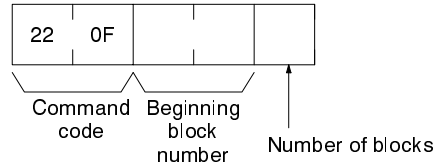

Response Block

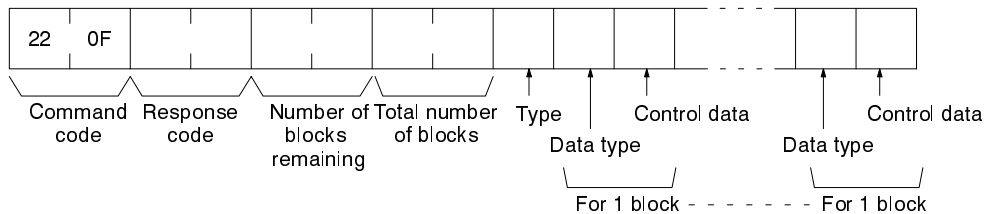

Parameters

Beginning block number and Number of blocks (command): Set the number of the first block and the total number of blocks whose index is to be read. The first block can be 0000 to 07CF (0 to 1999 decimal); the number of blocks can be 01 to 80 (1 to 128 decimal).

Number of blocks remaining and Total number of blocks (response): The number of blocks not to be read (0000 to 07D0 (0 to 2,000 in decimal)) and the total number of blocks in File Memory (0000, 03E8, or 07D0 (0, 1,000, or 2,000 in decimal, respectively)).

Type (response): The type of File Memory being used.

- 00: RAM
- 01: First half RAM; second half ROM

Data type and Control data (response): One byte for each parameter is returned with each block read.

Data type: As follows:

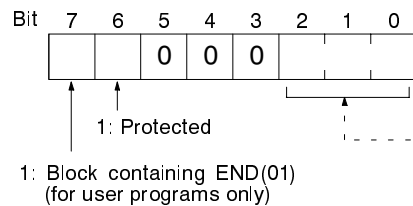

Bit	Data type	
2	1	0
0	0	0
0	0	1
0	1	0
0	1	1

Control data: The number of comments. Used for comment data only.

3-16 FILE MEMORY READ

Reads the contents of the specified File Memory block.

Note This command is valid for the C1000H and C2000H only. Refer to the *File Memory Unit Operation Manual* for details on the File Memory.

Command Block

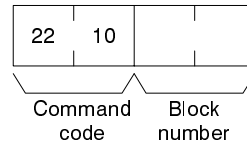

Response Block

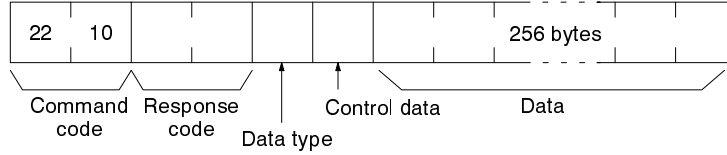

Parameters

Block number (command): Specify the number of the File Memory block to read between 0000 and 07CF (0 and 1,999 in decimal).

Data type and Control data (response): One byte for each index parameter is returned with each block read.

Data type: As follows:

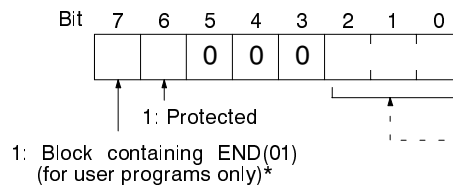

Bit			Data type
2	1	0	
0	0	0	Empty
0	0	1	User program
0	1	0	I/O data
0	1	1	Comments

Control data: The number of comments. Used for comment data only.

Data (response): The contents of the specified File Memory block (256 bytes (128 words)).

3-17 FILE MEMORY WRITE

Writes the specified contents to the specified File Memory block.

Note This command is valid for the C1000H and C2000H only. Refer to the *File Memory Unit Operation Manual* for details on the File Memory.

Command Block

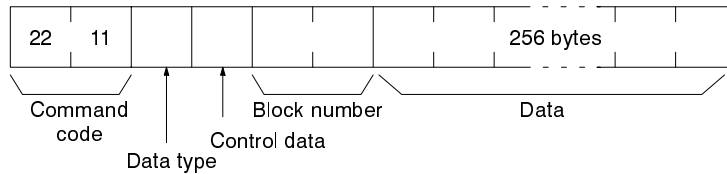

Response Block

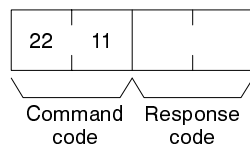

Parameters

Data type and Control data (command): Specify one byte for each index parameter.

Data type: Specify as follows:

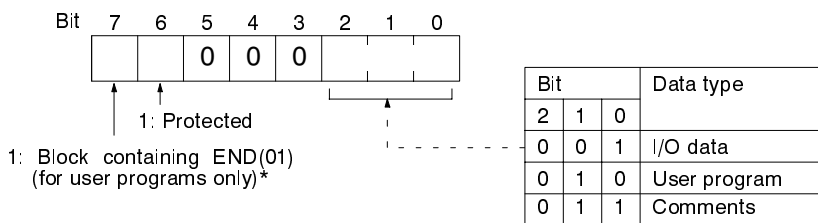

Note: *Turn ON (1) this bit only for a block containing END(01) or a final block.

Control data: Specify the number of comments. Used for comment data only. Control data specified for other data types will be ignored.

Block number (command): Specify the number of the File Memory block to write between 0000 and 07CF (0 and 1,999 blocks).

Data (command): Specify the contents for the specified File Memory block (256 bytes (128 words)).

3-18 FORCED SET/RESET

Force-sets (ON) or force-resets (OFF) bits/flags or releases force-set status. Bits/flags that are forced ON or OFF will remain ON or OFF and cannot be written to until the forced status is released.

Note This command cannot be used to release the status of Completion Flags for timers or counters. If forced status is released and the Completion Flag is turned ON, it will be force-set; if forced status is released and the Completion Flag is turned OFF, it will be force-reset.

Command Block

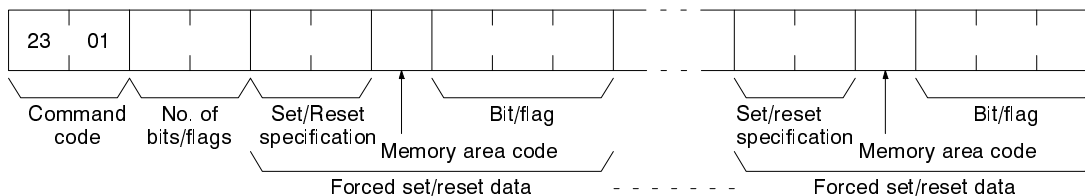

Response Block

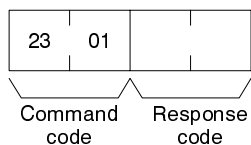

Parameters

No. of bits/flags (command): The number of bits/flags to be processed.

Note Only one bit/flag can be specified for the C1000H or C2000H for each command. If more than one bit/flag is specified, only the last one will be processed. Multiple bits/flags can be specified for the C200H.

Set/Reset specification (command): The action to be taken for each bit/flag:

Value	Name
0000	Force-reset (OFF)
0001	Force-set (ON)
8000	Forced status released and bit turned OFF (0)
8001	Forced status released and bit turned ON (1)
FFFF	Forced status released

Note Only 0000 and 0001 can be specified for the C1000H or C2000H.

Memory area code (command): The memory area of the bit or flag to be controlled.

Bit/Flag (command): The bit or flag to be controlled.

Memory Areas

Refer to 3-2 Memory Area Designations for memory area designations.

3-19 FORCED SET/RESET CANCEL

Cancels all bits (flags) that have been forced ON or forced OFF.

Command Block

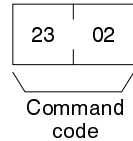

Response Block

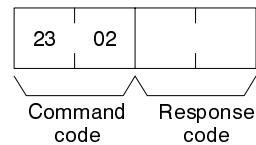

Note The bits (flags) in the following memory areas can be forced set or forced reset.

Memory area	Data
CIO, LR, HR, and AR areas	Bits status
Timer/Counter	Completion Flag status

3-20 MULTIPLE FORCED STATUS READ

Reads the forced status of the specified range of words or timers/counters.

Note This command is valid for the C200H only.

Command Block

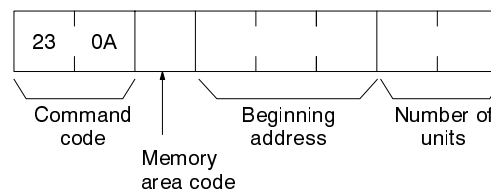

Response Block

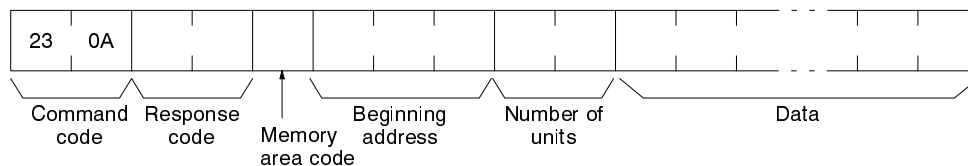

Parameters

Memory area code, Beginning address, Number of units (command, response): Specify the memory area code, the beginning address in that area,

and the number of words or timers/counters to read. The number of units can be between 0001 and 0040 (1 to 64 in decimal).

The actual area, beginning address, and number of unit to be read will be returned in the response.

Memory Areas

Forced status can be read in the following areas. Refer to 3-2 Memory Area Designations for memory area designations.

Area	Data type	Memory area code	Number of bytes
CIO, LR, HR, and AR areas	Current value of word	80	2
Timer/counter area	Completion Flag status	01	1

Note Forced status is read by words for the CIO, LR, HR, or AR area and by bits (flags) for the timer/counter area.

Data (response): Forced status is returned beginning from the specified word or timer/counter. The number of bytes returned will be (the number of units) x (the number of bytes/unit).

CIO, LR, HR, and AR Areas:

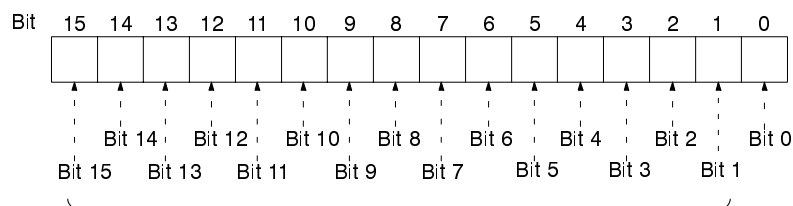

The status for each bit is as follows:
 OFF (0): No forced status in effect
 ON (1): Forced ON or forced OFF

Timers/Counters: Status of the Completion Flag will be returned as follows:

- 00: No forced status in effect
- 01: Forced ON or forced OFF

SECTION 4

Commands for SYSMAC NET Link Units

This section provides details on commands that can be sent to SYSMAC NET Link Units. The SYSMAC NET Link Units that support these commands are listed in the following table.

PC	Model number
CV500, CV1000	CV500-SNT31

4-1	Command List	74
4-2	DATA LINK TABLE READ	74
4-3	DATA LINK TABLE WRITE	75
4-4	RUN	77
4-5	STOP	77
4-6	RESET	78
4-7	CONTROLLER DATA READ	78
4-8	CONTROLLER STATUS READ	78
4-9	DATA LINK STATUS READ	79
4-10	LOOP-BACK TEST	80
4-11	ERROR LOG READ	81
4-12	ERROR LOG CLEAR	82
4-13	NAME SET	82
4-14	NAME DELETE	82
4-15	NAME READ	83

4-1 Command List

The beginning portions of the command and response block up to the command codes and the FCS and terminator have been omitted for simplicity, but must be added for actual transmission if not automatically generated for the transmission method being used. Refer to *1-3 Command/Response Transmission Data*.

In the illustrations of command and response blocks in this section, each box represents one byte (i.e., two hexadecimal or BCD digits). Be careful when adding the header, where each box represents one digit (i.e., four bits).

The following table lists the FINS commands supported by SYSMAC NET Link Units.

Command code		Name	Page
02	20	DATA LINK TABLE READ	74
	21	DATA LINK TABLE WRITE	75
04	01	RUN	77
	02	STOP	77
	03	RESET	78
05	01	CONTROLLER DATA READ	78
06	01	CONTROLLER STATUS READ	78
	03	DATA LINK STATUS READ	79
08	01	LOOP BACK TEST	80
21	02	ERROR LOG READ	81
	03	ERROR LOG CLEAR	82
26	01	NAME SET	82
	02	NAME DELETE	82
	03	NAME READ	83

4-2 DATA LINK TABLE READ

Reads the contents of the data link table.

Command Block

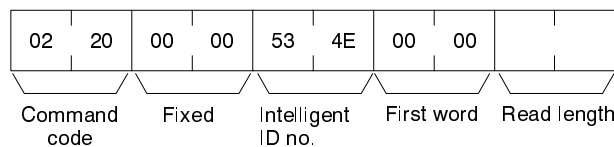

Response Block

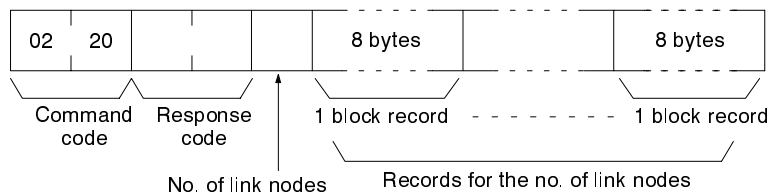

Parameters

Intelligent ID no. (command): Designate S (53) and N (4E) in ASCII.

Beginning word (command): Set to 0000.

Read length (command): Regardless of the value that you designate, the data link tables for the number of link nodes that has been set will be read.

No. of link nodes (response): The number of link nodes set in the data link table will be returned; the configuration is as follows (bit 7 is always set to 1):

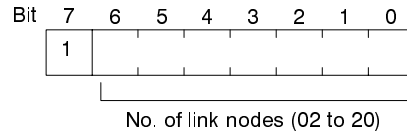

One-block record (response): One-block records will be returned in sequence according to the setting order in the data link table (in the case of automatic setting, they will be returned in node number order). The total number of bytes required is as follows:

$$\text{Number of link nodes} \times 8 \text{ bytes}$$

The configuration of the one-block record is as follows:

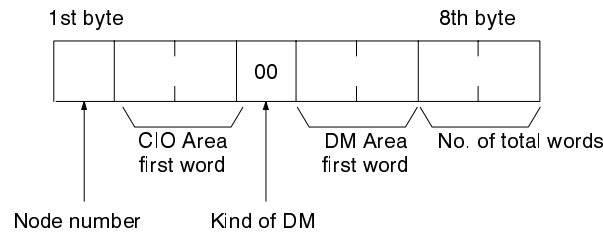

• Node Number

The configuration of a node number is shown below. It expresses the status of the data link node number of the one-block record and the data link on the node.

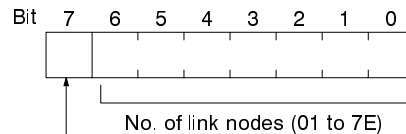

Data link status (0: normal; 1: warning)

• CIO Area First Word

The first word in a data link in the CIO Area.

• Kind of DM

Set to 00.

• DM Area First Word

The first word of a data link in the DM Area.

• No. of Total Words

The total number of words of the CIO and DM Area varies with the block as follows:

1st block: The total number of data link words in the CIO Area.

2nd block: The total number of data link words in the DM Area.

Other blocks: Set to 0000.

4-3 DATA LINK TABLE WRITE

Writes the data link table to the master from the CVSS or IBM PC/AT compatible.

Note

1. You cannot write a data link table when the data link is active
2. The data set on each node must begin with the first node of the data link area.
3. You cannot set a vacant area between two data link areas. For details, refer to the *SYSMAC NET Link System Manual*.

Command Block

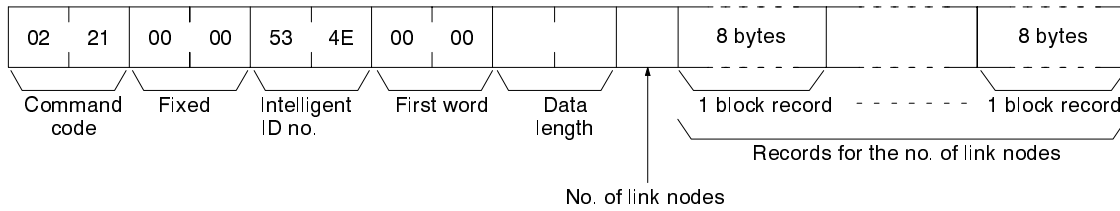

Response Block

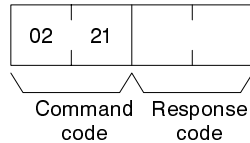

Parameters

Intelligent ID no. (command): Designate S (53) and N (4E) in ASCII.

First word (command): Set to 0000.

Data length (command): Regardless of the value you designate, the data link tables for the *number of link nodes* will be written.

No. of link nodes (response): Designate the number of link nodes in a range between 02 and 20 (2 and 32); the configuration is as follows (bit 7 is always set to 1):

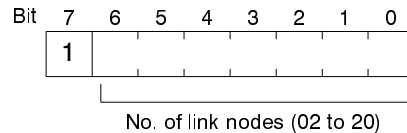

One-block record (command): One-block records will be sent in sequence according to the setting order in the data link table. The total number of bytes required is as follows:

$$\text{Number of link nodes} \times 8 \text{ bytes}$$

The configuration of the one-block record is as follows:

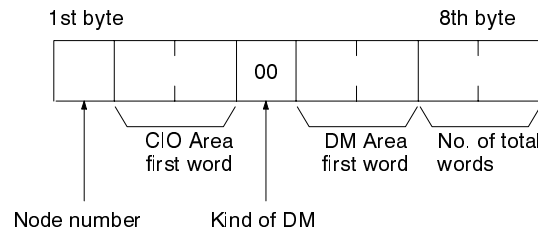

• **Node Number**

The node number provides the data link node number for the one-block record and the status of the data link. The configuration of the node number is as follows (bit 7 is always set to 0):

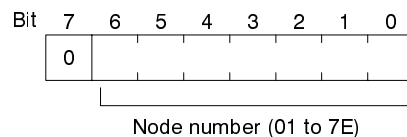

• **CIO Area First Word**

This is the first word in a data link in the CIO Area. The data link will extend from the first word through the word just before the first word designated for the CIO Area in the next record. For the last record, the data link will extend from the

first word through the number of words required to make the *total number of words* in the first block.

- Kind of DM
Set to 00.

- DM Area First Word

This is the first word in a data link in the DM Area. The data link will extend from the first word through the word just before the first word designated for the DM Area in the next record. For the last record, the data link will extend from the first word through the number of words required to make the *total number of words* in the second block.

- No. of Total Words

The total number of words used for data links in the CIO and DM Area. These are given only in the first and second blocks, as shown below

First block: The total number of data link words in the CIO Area.

Second block: The total number of data link words in the DM Area.

Other blocks: Set to 0000.

4-4 RUN

Activates the data links.

- Note**
1. This command will result in an error if data links have not be created either automatically or manually.
 2. This command must be sent to the master node or an error will result.

Command Block

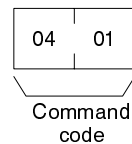

Response Block

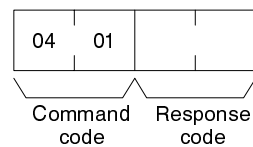

4-5 STOP

Stops the data links

- Note**
1. This command can be executed only when the data links are active or an error will result.
 2. This command must be sent to the master node or an error will result.

Command Block

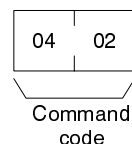

Response Block

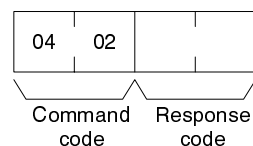

4-6 RESET

Resets the SYSMAC NET Link Unit.

- Note**
1. No response will be returned for this command.
 2. When this command is executed, only the data that has been stored in the transmission buffer will be sent.

Command Block

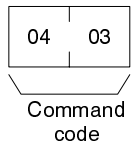

4-7 CONTROLLER DATA READ

Reads the model and version of the SYSMAC NET Link Unit.

Command Block

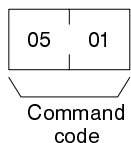

Response Block

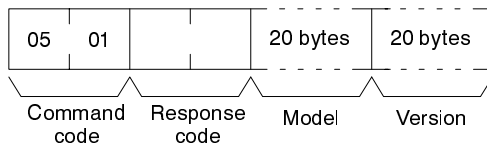

Parameters

Model and Version (response): Both are read in ASCII (20 bytes (i.e. 20 ASCII characters) max. each). If the model or version information does not require 20 bytes, the remainder of the 20 bytes will be filled with spaces (ASCII 20).

4-8 CONTROLLER STATUS READ

Reads the status of the PC and the SYSMAC NET Link Unit.

Command Block

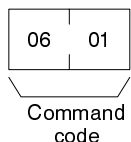

Response Block

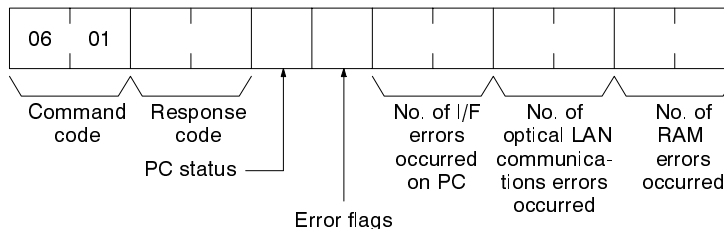

Parameters

PC status (response): The operating status of the PC will be returned as shown in the following diagram. For details on loop conditions, refer to the *SYSMAC NET Link System Manual*.

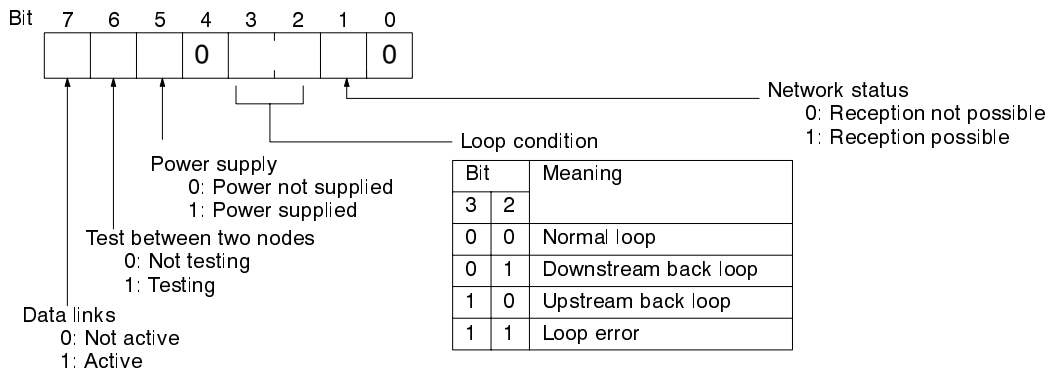

Error flags (response): The error flags of the PC will be returned as shown in the following diagram. Refer to the *SYSMAC NET Link System Manual* for details on errors.

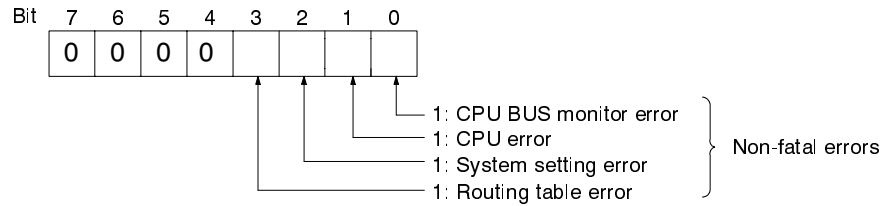

No. of I/F Errors Occurred on PC (response)

Refer to the *SYSMAC NET Link System Manual* for details.

No. of Optical LAN Communications Errors Occurred

Refer to the *SYSMAC NET Link System Manual* for details.

No. of RAM Errors Occurred

Refer to the *SYSMAC NET Link System Manual* for details.

4-9 DATA LINK STATUS READ

Reads the data link status of the SYSMAC NET Link.

Command Block

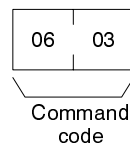

Response Block

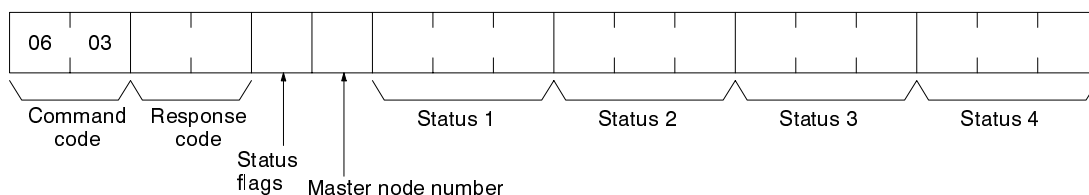

Parameters

Status flags (response): A one-byte data link status will be returned as follows:

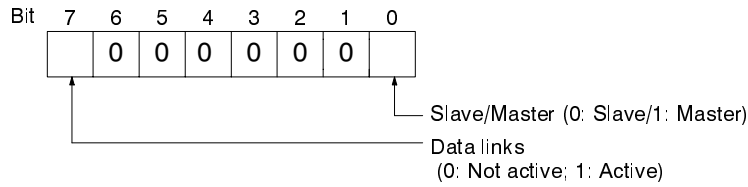

Slave/master: Bit 0 specifies the setting of the node on which the data link status has been read.

Master node number (response): The node number of the master node of the data link will be returned.

Status 1 through 4 (response): The data link status (error, mode, and warning status) on each node is returned in one-byte of data as follows:

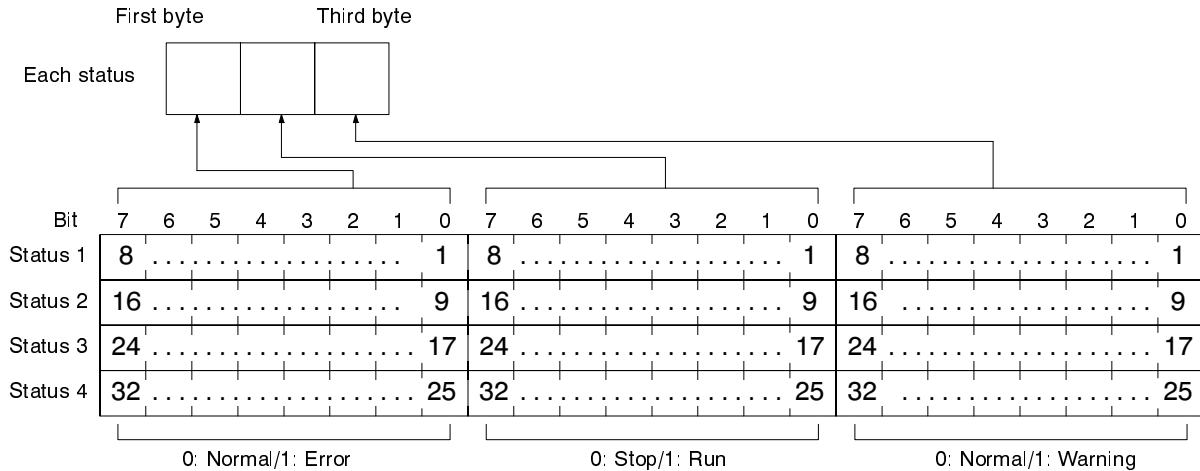

The figures as shown in each box specify the order of nodes set on the data link table. In the case of automatic setting, the figures will correspond to the node number.

4-10 LOOP-BACK TEST

Executes a loop-back test between the local node and a destination node.

- Note**
1. The destination node is designated in the control data of the CMND(194) instruction.
 2. The unit address must designate a SYSMAC NET Link Unit.

Command Block

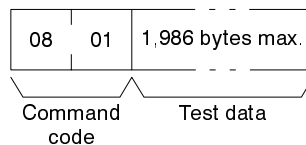

Response Block

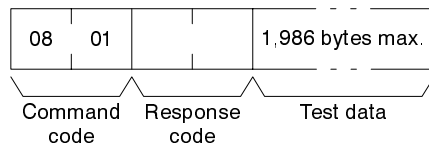

Parameters

Test data (command and response): In the command block, designate the data to be transmitted to the destination node. The designated data consists of 1,986 bytes maximum (binary data). In the response block, the test data from the command block will be returned as it is. If the test data in the response block is different from that in the command block, an error has occurred.

4-11 ERROR LOG READ

Reads the error log file.

Note If the number of records that you designate in the command block exceeds the actual number of stored records, all the stored records will be returned and no error will occur.

Command Block

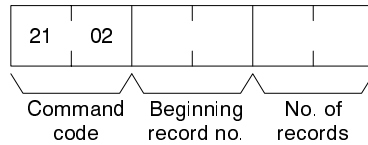

Response Block

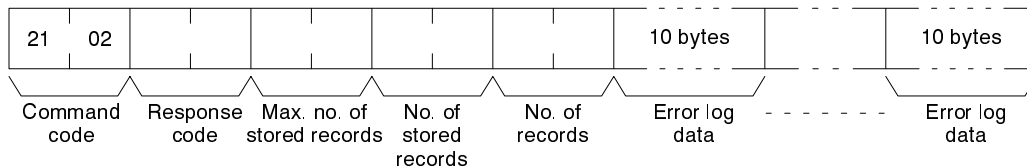

Parameters

Beginning record no. (command): Designates the beginning record number in a range of 0000 to 0018 (0 to 24 in decimal) (the first record is 0000).

No. of records (command and response): Designates the number of records to be read in a range of 0001 to 0019 (1 to 25 in decimal).

Max. no. of stored records (response): The maximum number of stored records varies with the kind of Unit. The SYSMAC NET Link Unit can store 25 records maximum.

No. of stored records (response): The number of records that have been recorded.

Error log data (response): The specified error log records will be returned in sequence starting from the beginning record number. The total number of bytes required is calculated as follows:

$$\text{No. of records} \times 10 \text{ bytes}$$

The configuration of each error record is as follows:

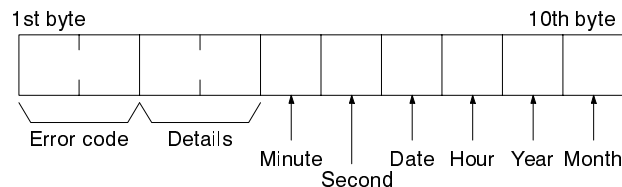

- Error Code and Details
The error code and details vary with the kind of Unit.
- Minute, Second, Date, Hour, Year, and Month
Each record includes the second, minute, hour (0 to 23), date, month, and year (the rightmost two digits) in BCD specifying the time that the error occurred.

4-12 ERROR LOG CLEAR

Clears all error log records to all zeros.

Note This command cannot be executed if any other device has the access right.

Command Block

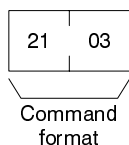

Response Block

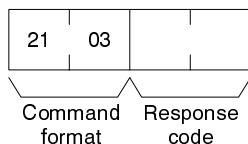

4-13 NAME SET

Registers a name for the SYSMAC NET Link Unit.

Command Block

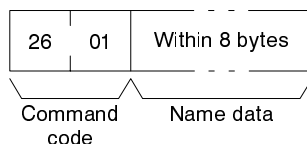

Response Block

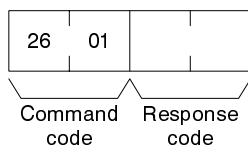

Parameters

Name data (command): The data set must be within 8 bytes in ASCII. Do not use the NULL (00) code.

4-14 NAME DELETE

Deletes the name of a SYSMAC NET Link Unit.

Command Block

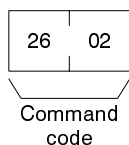

Response Block

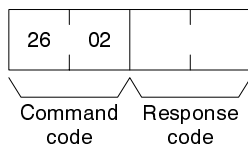

4-15 NAME READ

Reads the name of a SYSMAC NET Link Unit.

Command Block

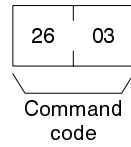

Response Block

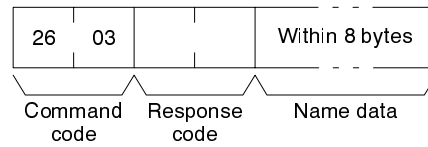

Parameters

Name data (response): The data previously set within 8 bytes in ASCII will be returned (except NULL (00) code).

SECTION 5

Commands for SYSMAC LINK Units

This section provides details on commands that can be sent to SYSMAC LINK Units. The SYSMAC LINK Units that support these commands are listed in the following table.

Unit	Applicable PC/computer	Cable	Model number
C-series SYSMAC LINK Units	C1000H or C2000H	Optical fiber	C1000H-SLK11
		Coaxial	C1000H-SLK21-V1
	C200H	Optical fiber	C200H-SLK11
		Coaxial	C200H-SLK21-V1
CV-series SYSMAC LINK Units	CV500 or CV1000	Optical fiber	CV500-SLK11
		Coaxial	CV500-SLK21
SYSMAC LINK Support Board	IBM PC/AT or compatible	Coaxial	3G8F5-SLK21-E

5-1	Command List	86
5-2	RUN	86
5-3	STOP	86
5-4	CONTROLLER DATA READ	87
5-5	CONTROLLER STATUS READ	88
5-6	NETWORK STATUS READ	90
5-7	DATA LINK STATUS READ	91
5-8	INTERNODE ECHO TEST	92
5-9	BROADCAST TEST RESULTS READ	93
5-10	BROADCAST TEST DATA SEND	93
5-11	ERROR LOG READ	94
5-12	ERROR LOG CLEAR	95

5-1 Command List

The beginning portions of the command and response block up to the command codes and the FCS and terminator have been omitted for simplicity, but must be added for actual transmission if not automatically generated for the transmission method being used.

In the illustrations of command and response blocks in this section, each box represents one byte (i.e., two hexadecimal or BCD digits). Be careful when adding the header, where each box represents one digit (i.e., four bits).

The following table lists the FINS commands supported by SYSMAC LINK Units and Support Boards.

Command code		Name	Page
04	01	RUN	86
	02	STOP	86
05	01	CONTROLLER DATA READ	87
06	01	CONTROLLER STATUS READ	88
	02	NETWORK STATUS READ	90
	03	DATA LINK STATUS READ	91
08	01	INTERNODE ECHO TEST	92
	02	BROADCAST TEST RESULTS READ	93
	03	BROADCAST TEST DATA SEND	93
21	02	ERROR LOG READ (Not supported by SYSMAC LINK Units)	94
	03	ERROR LOG CLEAR (Not supported by SYSMAC LINK Units)	95

5-2 RUN

Activates data links in the SYSMAC LINK Network.

Note This command will be completed normally when link words are allocated automatically or via data link tables only.

Command Block

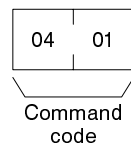

Response Block

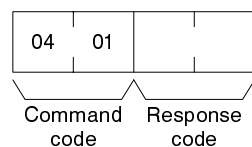

5-3 STOP

Stops data links in the SYSMAC LINK Network.

Note This command will be completed normally when the data link is in operation. If the data link is not in operation, an error will occur.

Command Block

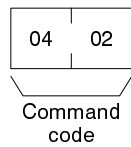

Response Block

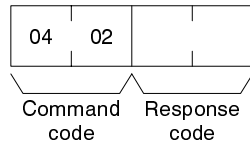

5-4 CONTROLLER DATA READ

Reads the following data:

- PC model and version
- Cable type
- Node number
- Common RAM size

Command Block

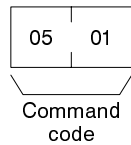

Response Block

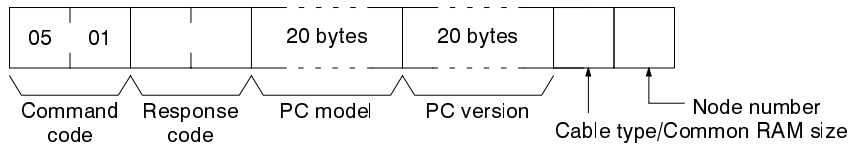

Parameters

PC model and version (response):

Both are read in ASCII codes (20 bytes (i.e. 20 ASCII characters) max. each). If the model or version requires less than 20 characters, the remaining bytes will be filled with spaces (ASCII code 20).

Cable type and Common RAM Size:

Bit 7 will be ON if the SYSMAC LINK Network is using optical fiber cable; OFF if it is using coaxial cable. The common RAM is the buffer for the communications controller. The size of the common RAM buffer will be returned in bits 00 to 02 as follows:

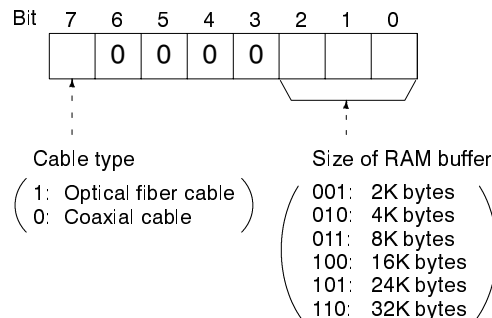

Node number:

The node number of the SYSMAC LINK Unit from 01 to 3E (1 to 62 decimal).

5-5 CONTROLLER STATUS READ

Reads the status of the controller.

Command Block

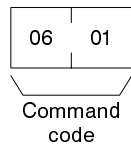

Response Block

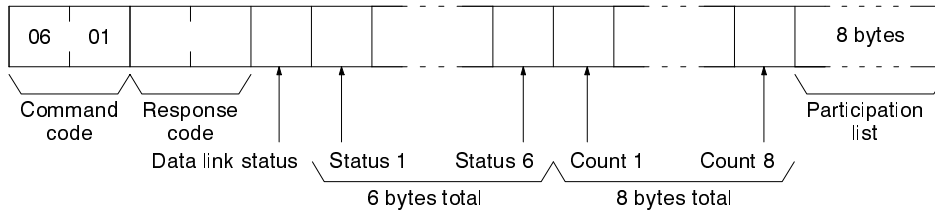

Parameters

Status (response): The operating status of the data links as follows:

00: Stopped

01: Active

Status 1 (response): Communications test status as follows:

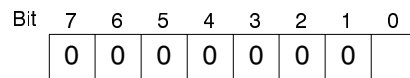

--- 1: Test running; 0: test stopped

Status 2 (response): Line status as follows:

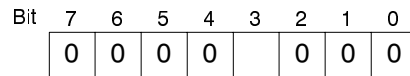

--- 1: Power supplied; 0: power not supplied

Status 3 (response): Error status as follows:

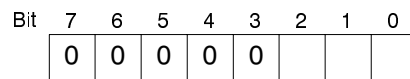

--- 1: Node number setting range error

--- 1: Node number duplication error

--- 1: Network parameter disagreement

Note The registered network parameters are compared to the actually network parameters upon power application the first time a Unit joins the network. If the parameters do not agree, bit 2, above, will be turned ON, but the system will not stop (the actual network parameters will automatically be registered).

Status 4 (response): The cause of communications controller errors as follows:

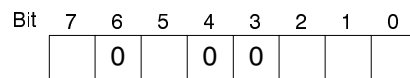

--- 1: Watchdog timer error

--- 1: Memory error

--- 1: Chip error

--- 1: Transmitter error

--- 1: Local node echo test error

Status 5 (response): Backup status as follows:

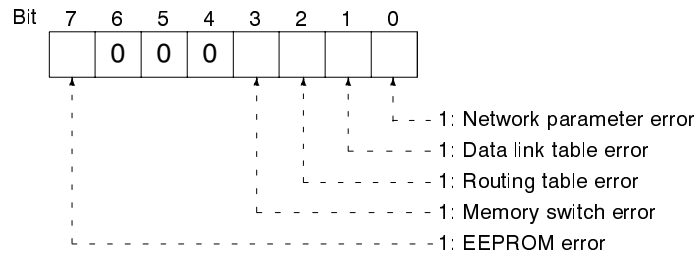

Status 6 (response): Error log status as follows (fixed to 00 for C-series SYSMAC LINK Units):

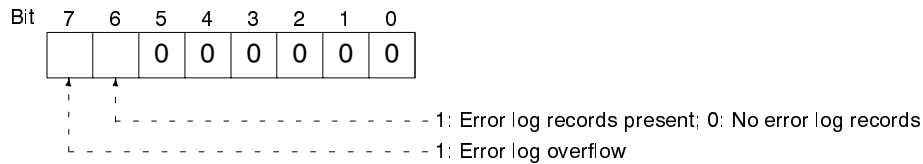

Counts 1 through 8 (response):

Each of the following bytes provides two hexadecimal digits giving the total number of occurrences of the following items since power was turned on. These counters will count to 255 and then remain there until power is turned off again.

- Count 1: Number of CRC errors
- Count 2: Number of times token has been resent
- Count 3: Number of times token has been passed
- Count 4: Number of token time-outs
- Count 5: Number of polling time-outs
- Count 6: Number of time polling unit has changed
- Count 7: Number of time participating Units have changed
- Count 8: Number of times communications controller transmit/receive operation has stopped.

Participation List (response):

Bits in the last eight bytes of the response are turned ON to indicate when a node is participating in the SYSMAC LINK network. The bit turned ON for each node number is shown in the following illustration. Bits given as “-” are always zero.

Bit	7	6	5	4	3	2	1	0
Byte 1	8	7	6	5	4	3	2	1
Byte 2	16	15	14	13	12	11	10	9
Byte 3	24	23	22	21	20	19	18	17
Byte 4	32	31	30	29	28	27	26	25
Byte 5	40	39	38	37	36	35	34	33
Byte 6	48	47	46	45	44	43	42	41
Byte 7	56	55	54	53	52	51	50	49
Byte 8	-	-	62	61	60	59	58	57

5-6 NETWORK STATUS READ

Reads the status of the SYSMAC LINK Network.

Command Block

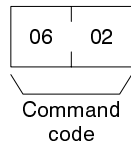

Response Block

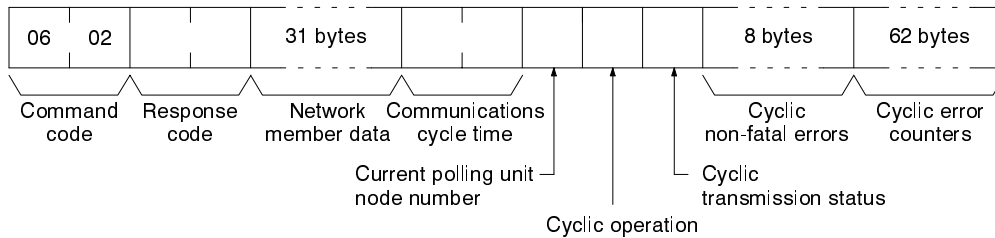

Parameters

Network member data (response): Four bits are allocated to each node number to provide information on the status of nodes in the network as shown below. The function of each of the 4 bits is shown in the diagram following the table.

Byte	Bits 4 to 7	Bits 0 to 3
Byte 1	Node number 2	Node number 1
Byte 2	Node number 4	Node number 3
Byte 3	Node number 6	Node number 5
...
Byte 31	Node number 62	Node number 61

Bit 3/7 2/6 1/5 0/4

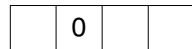

- 1: In network (0: Not in network)
- 1: Exited because of an error.* (0: Normal exit)
- 1: Unit does not respond to polling.

Note *Bit 1/5 is used to indicate why the node is not in the network when bit 0/4 is OFF.

Communications cycle time (response): The actual communications cycle time is provided here in 4-digit hexadecimal in increments of 100 ms.

Current polling unit node number (response): The node number of the unit that currently is the polling unit.

Cyclic operation (response): Indicates the current status of cyclic operation, as follows:

- 00: Stopped
- 01: Active

Cyclic transmission status (response): Indicates the current status of cyclic transmission, as follows:

- 00: No transmission
- 01: Transmission

Cyclic non-fatal errors (response): These eight bytes indicate nodes in which non-fatal errors occurred in cyclic transmission. When a bit in the following matrix is ON, a non-fatal error occurred in the corresponding node. Bit 0 of the first byte and bit 7 of the eighth byte are always OFF.

	Bit 7	6	5	4	3	2	1	0
First byte	7	6	5	4	3	2	1	-
Second byte	15	14	13	12	11	10	9	8
Third byte	23	22	21	20	19	18	17	16
Fourth byte	31	30	29	28	27	26	25	24
Fifth byte	39	38	37	36	35	34	33	32
Sixth byte	47	46	45	44	43	42	41	40
Seventh byte	55	54	53	52	51	50	49	48
Eighth byte	-	62	61	60	59	58	57	56

Cyclic error counters (response): One of these 62 bytes is allocated to each node to indicate how many cyclic errors occurred since start-up. The first byte is allocated to node number 1, the second to node number 2, etc. Each number is 2-digit hexadecimal, so 00 to FF (0 to 255 decimal) errors can be recorded for each node. If more than 255 errors occur, the number will remain at 255.

5-7 DATA LINK STATUS READ

Reads the status of the data link.

The various data link status information described here will not be updated while the data link is halted.

Command Block

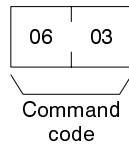

Response Block

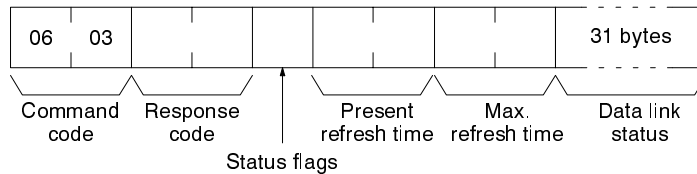

Parameters

Status flags (response): This byte contains flags providing information on overall data link status, as follows:

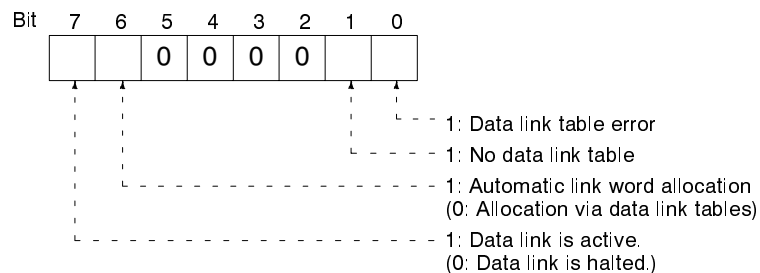

Present and Max. refresh time (response): The present and maximum data link refresh times in 4-digit hexadecimal in increments of 1 ms. The range is 0005 to 00FF (5 to 255 ms, in decimal).

Data link status (response): Four bits are allocated to each node number to provide information on the status of the data links, as shown below. The function of each of the 4 bits is shown in the diagram following the table.

Byte	Bits 4 to 7	Bits 0 to 3
Byte 1	Node number 2	Node number 1
Byte 2	Node number 4	Node number 3
Byte 3	Node number 6	Node number 5
⋮	⋮	⋮
Byte 31	Node number 62	Node number 61

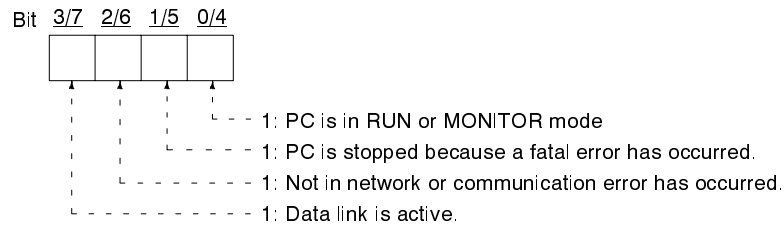

5-8 INTERNODE ECHO TEST

Performs a internode echo test with the indicated node.

Command Block

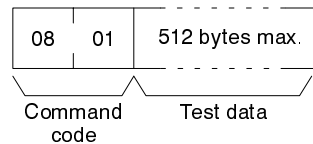

Response Block

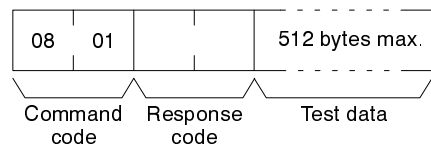

Parameters

Test data (command and response): Up to 512 bytes of test data can be included in the command. This data is transmitted to the indicated node and returned unchanged if communications are normal. If the data returned in the response differs from that transmitted in the command, an error occurred in the test.

5-9 BROADCAST TEST RESULTS READ

Reads the results (number of receptions for each node) of the broadcast tests carried out using the BROADCAST TEST DATA SEND command. Refer to 5-10 BROADCAST TEST DATA SEND for details on that command.

Command Block

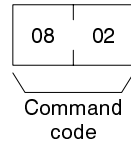

Response Block

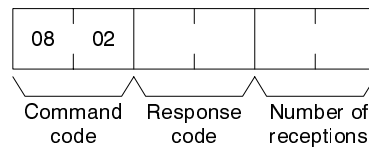

Parameters

Number of receptions (response): The number of times that the BROADCAST TEST DATA SEND command has been executed since the last BROADCAST TEST RESULTS READ command was executed.

When this command is executed, the number of receptions data stored in the destination nodes is cleared. If the number of receptions does not equal the number of times that the BROADCAST TEST DATA SEND command has been executed since the last BROADCAST TEST RESULTS READ command was executed, an error has occurred.

5-10 BROADCAST TEST DATA SEND

Sends the test data in the command to all nodes in the specified network. No response will be returned when this command is executed, but reception of the test data can be verified by executing the BROADCAST TEST RESULTS READ command. Refer to 5-9 BROADCAST TEST RESULTS READ for details.

Command Block

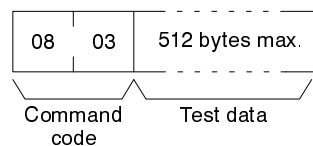

Note Make the following control data settings for CMND(194) when executing a broadcast test:

- a) Destination node number: FF (broadcast transmission)
- b) Destination node unit number: FE (to SYSMAC LINK Units or Support Board)
- c) Response Flag (bit 13 of C+1): ON (response not returned)

5-11 ERROR LOG READ

Reads the error log.

- Note**
1. When the specified number of records have not yet been stored, all the records that have been stored will be read and a normal response will be returned.
 2. If the data is too large and exceeds the permissible length of the response block (540 bytes), the part in excess will not be read and a normal response will be returned.
 3. This command is not supported by C-series SYSMAC LINK Units.

Command Block

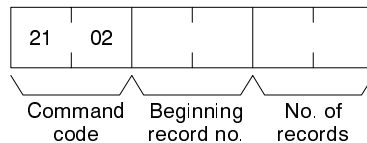

Response Block

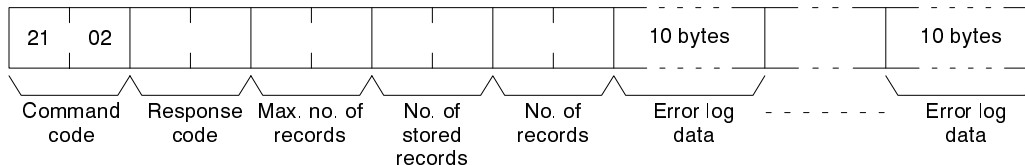

Parameters

Beginning record no. (command): The first record to be read (the first record number is 0000).

Max. no. of records (response): The maximum number of records that can be recorded. Error logs vary for the PC, computers, and CPU Bus Units. The maximum number of records for SYSMAC LINK Units or Support Boards is fixed at 40 (64 records).

No. of stored records (response): The number of records that have been recorded.

No. of records (command and response): The number of records to be read. Specify between 0000 and 0035 (0 and 53 in decimal). If the number of records is not specified, all records to present will be read and a normal response code will be returned. If the number of records causes the response to exceed 540 bytes, records through 540 bytes will be returned and an error response will be returned saying that the response was too long.

Error log data (response): The specified error log records will be returned in sequence starting from the beginning record number. The total number of bytes required is calculated as follows:

$$\text{Number of records} * 10 \text{ bytes}$$

The configuration of each error record is as follows:

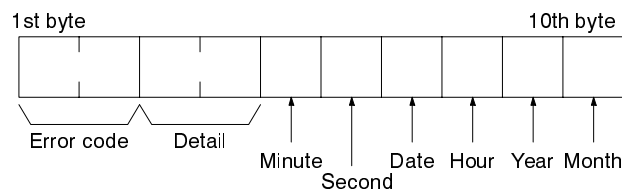

Each data includes the second, minute, hour (0 to 23), date, month, and year (the rightmost two digits) in BCD specifying the time that the error occurred. Refer to the *SYSMAC LINK System Manual* or *SYSMAC LINK Support Board Operation Manual* for details on error codes.

5-12 ERROR LOG CLEAR

Clears all error log records.

Note This command is not supported by C-series SYSMAC LINK Units.

Command Block

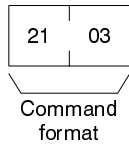

Response Block

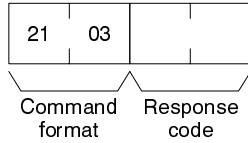

SECTION 6

Commands for Personal Computer Units

This section provides details on commands that can be sent to CV500-VP111-E or CV500-VP121-E Personal Computer Units.

6-1	Command List	98
6-2	CONTROLLER DATA READ	98
6-3	CLOCK READ	98
6-4	CLOCK WRITE	99
6-5	INTERNODE ECHO TEST	99
6-6	ERROR LOG READ	100
6-7	ERROR LOG CLEAR	101

6-1 Command List

The beginning portions of the command and response block up to the command codes and the FCS and terminator have been omitted for simplicity, but must be added for actual transmission if not automatically generated for the transmission method being used.

In the illustrations of command and response blocks in this section, each box represents one byte (i.e., two hexadecimal or BCD digits). Be careful when adding the header, where each box represents one digit (i.e., four bits).

The following table lists the FINS commands supported by Personal Computer Units.

Command code		Name	Page
05	01	CONTROLLER DATA READ	98
07	01	CLOCK READ	98
	02	CLOCK WRITE	99
08	01	INTERNODE ECHO TEST	99
21	02	ERROR LOG READ	100
	03	ERROR LOG CLEAR	101

6-2 CONTROLLER DATA READ

Reads the following data:

- Controller model and version

Command Block

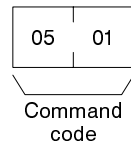

Response Block

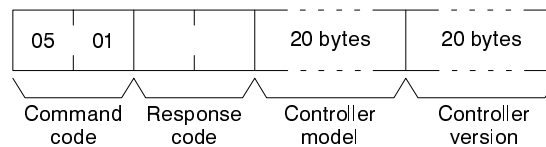

Parameters

Controller model and Controller version (response): Both are read in ASCII codes (20 bytes (i.e., 20 ASCII characters) max. each). If all 20 bytes are not required, remaining bytes will be filled with spaces (ASCII 20).

6-3 CLOCK READ

Reads the clock.

Command Block

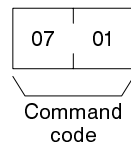

Response Block

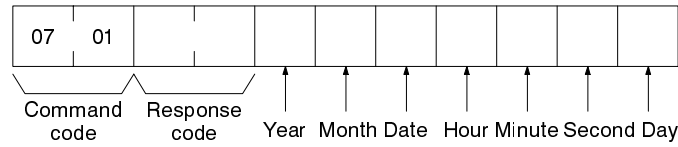

Parameters

Year, month, date, hour, minute, second, day (response): Each value is expressed in BCD.

Year: The rightmost two digits of the year.

Hour: 00 to 23.

Day: As follows:

Value	00	01	02	03	04	05	06
Day	Sun	Mon	Tues	Wed	Thur	Fri	Sat

6-4 CLOCK WRITE

Sets the clock.

Note If any other device holds the access right, the clock will not be set.

Command Block

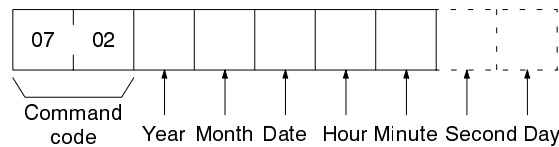

Response Block

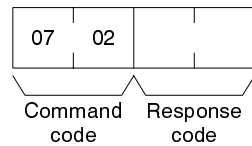

Parameters

Year, month, date, hour, minute, second, day (command): Each specified value is expressed in BCD.

Year: The rightmost two digits of the year.

Hour: Specify 00 to 23.

Day: As follows:

Value	00	01	02	03	04	05	06
Day	Sun	Mon	Tues	Wed	Thur	Fri	Sat

Note If the second or day are not specified, 00 will be set as the second and the previous value will be kept for the day .

6-5 INTERNODE ECHO TEST

Performs a internode echo test with the indicated node.

Command Block

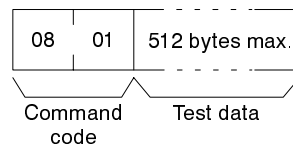

Response Block

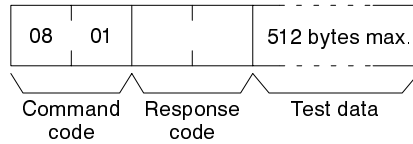

Parameters

Test data (command and response): Up to 512 bytes of test data can be included in the command. This data is transmitted to the indicated node and returned unchanged if communications are normal. If the data returned in the response differs from that transmitted in the command, an error occurred in the test.

6-6 ERROR LOG READ

Reads the error log.

- Note**
1. When the specified number of records has not yet been written, all the records that have been stored will be read and a normal response will be returned.
 2. All records that are read and any records older than the ones read will be cleared when the command is executed.

Command Block

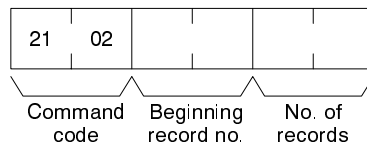

Response Block

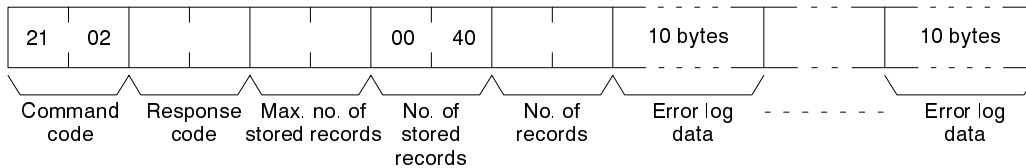

Parameters

Beginning record no. (command): The first record to be read (the first record number is 0000).

Max. no. of stored records (response): The maximum number of records that can be stored.

No. of stored records (response): The number of records that have been recorded. This value is fixed at 0040 (64 in decimal).

No. of records (command and response): The number of records to be read.

Error log data (response): The specified error log records will be returned in sequence starting from the beginning record number. The total number of bytes required is calculated as follows:

$$\text{No. of records} \times 10 \text{ bytes}$$

The configuration of each error record is as follows:

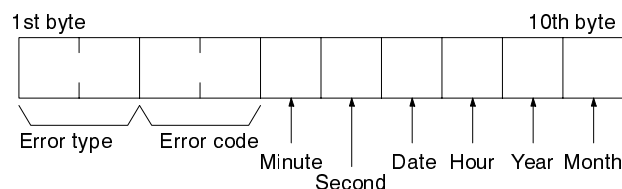

Error type:

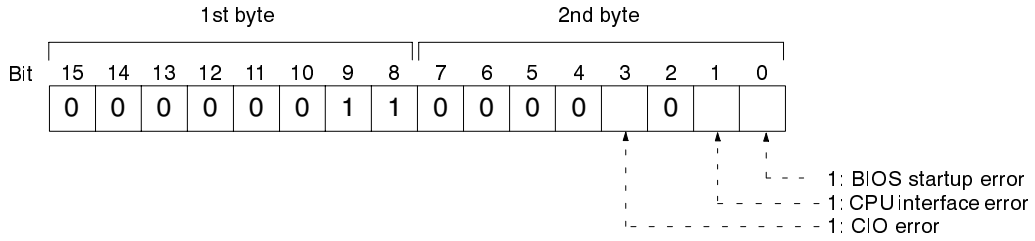

Error code: Refer to the *Personal Computer Unit Operation Manual* for details. Each data includes the second, minute, hour (0 to 23), date, month, and year (the rightmost two digits) in BCD specifying the time that the error occurred.

6-7 ERROR LOG CLEAR

Clears all error log records.

Command Block

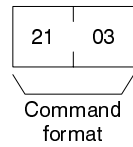

Response Block

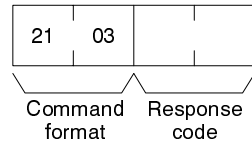

SECTION 7

Commands for BASIC Units

This section provides details on commands that can be sent to CV500-BSC11/21/31/41/51/61 BASIC Units.

7-1	Command List	104
7-2	CONTROLLER DATA READ	104
7-3	CONTROLLER STATUS READ	105
7-4	ERROR LOG READ	105
7-5	ERROR LOG CLEAR	106

7-1 Command List

The beginning portions of the command and response block up to the command codes and the FCS and terminator have been omitted for simplicity, but must be added for actual transmission if not automatically generated for the transmission method being used.

In the illustrations of command and response blocks in this section, each box represents one byte (i.e., two hexadecimal or BCD digits). Be careful when adding the header, where each box represents one digit (i.e., four bits).

The following table lists the FINS commands supported by BASIC Units.

Command code		Name	Page
05	01	CONTROLLER DATA READ	104
06	01	CONTROLLER STATUS READ	105
21	02	ERROR LOG READ	105
	03	ERROR LOG CLEAR	106

7-2 CONTROLLER DATA READ

Reads the following data:

- Controller model and version
- Program information
- Memory information

Command Block

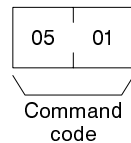

Response Block

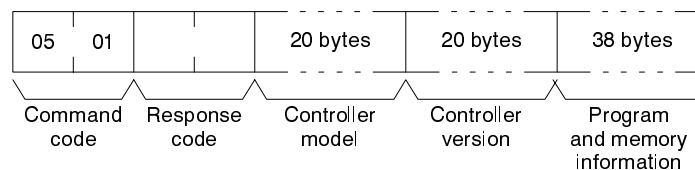

Parameters

Controller model and Controller version (response): Both are read in ASCII codes (20 bytes (i.e., 20 ASCII characters) max. each). If the model does not require 20 bytes, the remainder is filled with spaces (ASCII 20). If the version does not require 20 bytes, it is preceded by spaces (ASCII 20).

Program and memory information (response): As follows (refer to *BASIC Unit Operation Manual* for details):

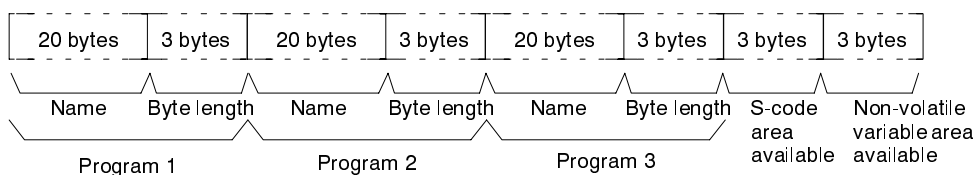

7-3 CONTROLLER STATUS READ

Reads the status of the Controller.

Command Block

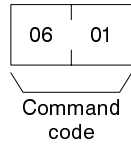

Response Block

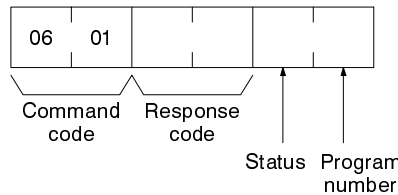

Parameters

Status (response): The operating status of the BASIC Unit as follows:

00: Stop (program not being executed)

01: Run (program being executed)

Program number (response): The number of the program that is currently executable or is being executed.

7-4 ERROR LOG READ

Reads the error log.

Command Block

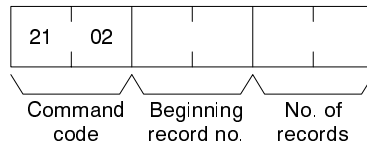

Response Block

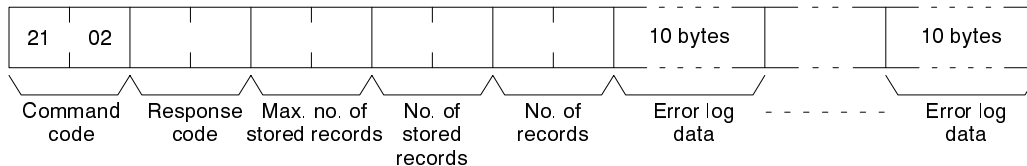

Parameters

Beginning record no. (command): The first record to be read (the first record number is 0000).

Max. no. of stored records (response): The maximum number of records that can be stored.

No. of stored records (response): The number of records that have been stored.

No. of records (command and response): The number of records to read.

Error log data (response): The specified error log records will be returned in sequence starting from the beginning record number. The total number of bytes required is calculated as follows:

$$\text{No. of records} \times 10 \text{ bytes}$$

The configuration of each error record is as follows:

Error type:

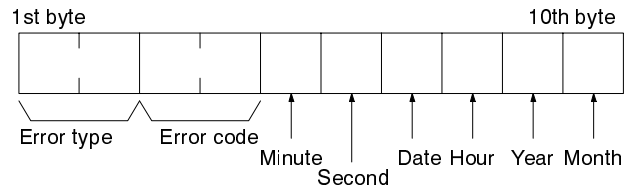

Error code: The error code in the error log record. Refer to the *BASIC Unit Operation Manual* for details.

Each data also includes the second, minute, hour (0 to 23), date, month, and year (the rightmost two digits) in BCD specifying the time that the error occurred.

7-5 ERROR LOG CLEAR

Clears all error log records.

Command Block

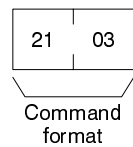

Response Block

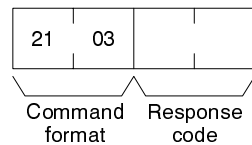

SECTION 8

Response Codes

This section describes the response codes returned with responses to FINS commands. Response codes can be used to confirm normal completion of command execution or to troubleshoot problems when commands fail. Refer to the operation manuals for specific Units or Systems for further troubleshooting information.

- 8-1 Configuration 108
- 8-2 Network Relay Errors 108
- 8-3 Response Codes and Troubleshooting 108

8-1 Configuration

Response codes for FINS commands consist of two bytes that indicate the result of executing a command. The structure of the response codes is shown in the following diagram.

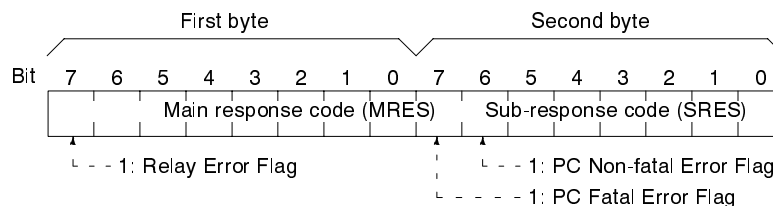

The main response code (MRES) in the first byte classifies the response and the sub-response code (SRES) in the second byte indicates details under the MRES classification.

If bit 7 of the first byte is ON, a network relay error has occurred. Refer to *Network Relay Errors* in this section for details on troubleshooting the error.

If bit 6 or 7 of the second byte is ON, an error has occurred in the PC or computer returning the response. Refer to the operation manual for the device returning the response for details when troubleshooting the error.

8-2 Network Relay Errors

A network relay error will occur whenever a command cannot reach the destination. These errors can occur for several reasons: 1) Data was not successfully passed between two Link Units, 2) Data was not passed successfully between a Link Unit and another Unit, such as the PC's CPU, or 3) The destination of a gateway does not exist. In any case, the Unit that was not able to transfer data will return a response indicating a network relay error.

Bit 7 of the first byte of the response code will be ON if a network relay error has occurred. When this happens, two more bytes of data will follow the response code to indicate the location of the error. This information, along with the response code, should enable you to track the error.

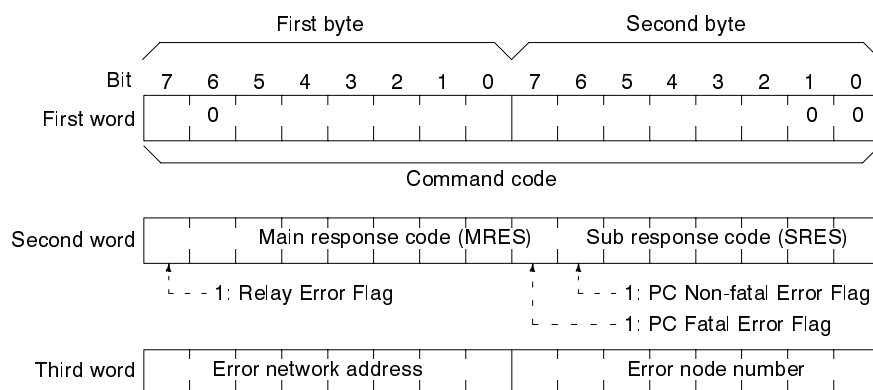

Error network address: 00 to 7F (0 to 127 decimal)

Error node number: SYSMAC NET: 01 to 7E (1 to 126 decimal)

SYSMAC LINK: 01 to 3E (1 to 62 decimal)

8-3 Response Codes and Troubleshooting

The table below lists response codes (main and sub-codes) returned after execution of the FINS commands, the probable cause of errors, and recommended remedies.

Upon receipt of some commands, the destination node will issue a request to another node; the other node is referred to as the third node.

Main code	Sub-code	Probable cause	Remedy
00: Normal completion	00	---	---
	01	Service was interrupted	Check the contents of the destination transmission area of third node. Check the data link status.
01: Local node error	01	Local node not part of Network	Add to Network.
	02	Token time-out, node number too large	Set the local node's node number below the maximum node number.
	03	Number of transmit retries exceeded	Check communications with internode echo test. If the test fails, check network.
	04	Maximum number of frames exceeded	Either check the execution of events in the network and reduce the number of events occurring in one cycle, or increase the maximum number of frames.
	05	Node number setting error (range)	Make sure the node number is within specified range and that there are no duplicate node numbers.
	06	Node number duplication error	Make sure that there are no duplicate node numbers.
02: Destination node error	01	Destination node not part of Network	Add to Network.
	02	No node with the specified node number	Check the destination node's node number.
	03	Third node not part of Network	Check the third node's node number.
		Broadcasting was specified.	Check the control data and specify only one node as the third node.
	04	Busy error, destination node busy	Increase the number of transmit retry attempts or re-evaluate the system so that the destination node is not so busy receiving data.
	05	Response time-out, message packet was corrupted by noise	Increase the number of transmit retry attempts.
		Response time-out, response watchdog timer interval too short	Increase the value for the response watchdog timer interval in the control data.
Frame lost in transmission		Check the error log and correct the process.	
03: Communications controller error	01	Error occurred in the communications controller, ERC indicator is lit	Take corrective action, referring to communications controller errors and remedies table at end of this section
	02	CPU error occurred in the PC at the destination node	Clear the error in the CPU (refer to the PC's operation manuals)
	03	A controller error has prevented a normal response from being returned.	Check network communications status and reset the controller board. If the error still exists, replace the controller board.
	04	Node number setting error	Make sure the node number is within specified range and that there are no duplicate node numbers.
04: Not executable	01	An undefined command has been used.	Check the command code and be sure that the Unit supports it.
	02	Cannot process command because the specified unit model or version is wrong.	Check the unit model and version.

Main code	Sub-code	Probable cause	Remedy
05: Routing error	01	Destination node number is not set in the routing table.	Set the destination node number in the routing table.
	02	Routing table isn't registered.	Set the source nodes, destination nodes, and relay nodes in the routing table.
	03	Routing table error	Set the routing table correctly.
	04	The maximum number of relay nodes (2) was exceeded in the command.	Redesign the network or reconsider the routing table to reduce the number of relay nodes in the command.
10: Command format error	01	The command is longer than the max. permissible length.	Check the command format of the command and set it correctly.
	02	The command is shorter than min. permissible length.	Check the command format of the command and set it correctly.
	03	The designated number of data items differs from the actual number.	Check the number of items and the data, and make sure that they agree.
	04	An incorrect command format has been used.	Check the command format of the command and set it correctly.
	05	An incorrect header has been used. (The local node's relay table or relay node's local network table is wrong.)	Set the routing table correctly.
11: Parameter error	01	A correct memory area code has not been used or Expansion Data Memory is not available.	Check the command's memory area code and set the appropriate code.
	02	The access size specified in the command is wrong, or the first address is an odd number.	Set the correct access size for the command.
	03	The first address is in an inaccessible area.	Set a first address that is in an accessible area.
	04	The end of specified word range exceeds the acceptable range.	Check the acceptable limits of the data area and set the word range within the limits.
			Check the data link tables to be sure the limit to link words has not been exceeded.
	06	A non-existent program no. has been specified.	Check the program number and be sure that it is set correctly.
	09	The sizes of data items in the command block are wrong.	Check the command data and be sure that the sizes of the data items are correct.
			Check the data link tables to be sure all nodes in the refresh parameters are in the common link parameters.
	0A	The IOM break function cannot be executed because it is already being executed.	Either abort the current IOM break function processing, or wait until it is completed and execute the command.
			Check the data link tables for duplicate node numbers.
0B	The response block is longer than the max. permissible length.	Check the command format and set the number of items correctly.	
0C	An incorrect parameter code has been specified.	Check the command data and reenter it correctly.	
		Check the data link table file for corruption.	

Main code	Sub-code	Probable cause	Remedy
20: Read not possible	02	The data is protected.	Execute the instruction again after issuing the PROGRAM AREA PROTECT CLEAR command.
		An attempt was made to download a file that is being uploaded.	Check the file name and either interrupt servicing or wait for servicing to complete before re-executing the command.
	03	The registered table does not exist or is incorrect.	Set or reset the registered table.
		Too many files open.	Close open files and re-execute the command.
	04	The corresponding search data does not exist.	---
	05	A non-existing program no. has been specified.	Check the program number and be sure that it is set correctly.
	06	A non-existing file has been specified.	Check whether the correct file name was used.
	07	A verification error has occurred.	Check whether the memory contents are correct and replace if incorrect.
Check the contents of the file. A read error may have occurred.			
21: Write not possible	01	The specified area is read-only or is write-protected.	If the specified area is read-only, the write cannot be performed. If it is write-protected, turn off the write-protect switch and execute the instruction again.
	02	The data is protected.	Execute the instruction again after issuing the PROGRAM AREA PROTECT CLEAR command.
		An attempt was made to simultaneously download and upload a file.	Check the file name and either interrupt servicing or wait for servicing to complete before re-executing the command.
		The data link table cannot be written manual because it is set for automatic generation.	Change the system settings to manual data link table generation.
	03	The number of files exceeds the maximum permissible.	Write the file(s) again after erasing unneeded files, or use different disk or Memory Card that has free space.
		Too many files open.	Close open files and re-execute the command.
	05	A non-existing program no. has been specified.	Check the program number and be sure that it is set correctly.
	06	A non-existent file has been specified.	---
07	The specified file already exists.	Change the name of the file and execute the instruction again.	
08	Data cannot be changed.	Check the contents of the memory area being written to.	

Main code	Sub-code	Probable cause	Remedy
22: Not executable in current mode	01	The mode is wrong (executing).	Check the operating mode.
		Data links are active.	Check the data link status before execution.
	02	The mode is wrong (stopped).	Check the operating mode.
		Data links are active.	Check the data link status before execution.
	03	The PC is in the PROGRAM mode.	Check the PC's mode.
	04	The PC is in the DEBUG mode.	Check the PC's mode.
	05	The PC is in the MONITOR mode.	Check the PC's mode.
	06	The PC is in the RUN mode.	Check the PC's mode.
	07	The specified node is not the control node.	Check which node is the control node.
08	The mode is wrong and the step cannot be executed.	Check whether the step has active status or not.	
23: No Unit	01	A file device does not exist where specified.	Mount the Memory Card or disk
	02	The specified memory does not exist.	Check the specifications of the installed file memory.
	03	No clock exists.	Check the model number.
24: Start/stop not possible	01	The data link table either hasn't been created or is incorrect.	Set the data link table correctly.

Main code	Sub-code	Probable cause	Remedy
25: Unit error	02	Parity/checksum error occurred because of incorrect data.	Transfer correct data into memory.
	03	I/O setting error (The registered I/O configuration differs from the actual.)	Either change the actual configuration to match the registered one, or generate the I/O table again.
	04	Too many I/O points	Redesign the system to remain within permissible limits.
	05	CPU bus error (An error occurred during data transfer between the CPU and a CPU Bus Unit.)	Check the Unit, Service Boards, and cable connections and issue the ERROR CLEAR command.
	06	I/O duplication error (A rack number, unit number, or I/O word allocation has been duplicated.)	Check the system's settings and eliminate any duplication.
	07	I/O bus error (An error occurred during data transfer between the CPU and an I/O Unit.)	Check the Unit, Service Boards, and cable connections and issue the ERROR CLEAR command.
	09	SYSMAC BUS/2 error (An error occurred during SYSMAC BUS/2 data transfer.)	Check the Unit, Service Boards, and cable connections and issue the ERROR CLEAR command.
	0A	Special I/O Unit error (An error occurred during CPU Bus Unit data transfer.)	Check the Unit, Service Boards, and cable connections and issue the ERROR CLEAR command.
	0D	Duplication in SYSMAC BUS word allocation.	Check and regenerate the I/O table.
	0F	A memory error has occurred in internal memory, in the Memory Card, or in Expansion DM during the error check.	If the error occurred in internal memory or the EM Unit, correct the data in the command and execute it again. If the error occurred in a Memory Card or EM used for file memory, the file data has been corrupted. Execute the MEMORY CARD FORMAT command. If the above remedies do not eliminate the error, replace the faulty memory.
10	Terminator not connected in SYSMAC BUS System.	Connect the terminator correctly.	

Main code	Sub-code	Probable cause	Remedy
26: Command error	01	The specified area is not protected. This response code will be returned if an attempt is made to clear protection on an area that is not protected.	The program area is not protected, so it isn't necessary to clear protection.
	02	An incorrect password has been specified.	Specify a password that is registered.
	04	The specified area is protected.	Execute the command again after the PROGRAM AREA PROTECT CLEAR command.
		To many commands at destination.	The destination has received more than 5 commands. Either interrupt servicing or wait for servicing to complete before re-executing the command.
	05	The service is being executed.	Execute the command again after the service has been completed or aborted.
	06	The service is not being executed.	Execute the service if necessary.
	07	Service cannot be executed from local node because the local node is not part of the data link.	Execute the service from a node that is part of the data link.
		A buffer error has prevented returning a normal response.	Reset the board. If the error persists, replace the board.
	08	Service cannot be executed because necessary settings haven't been made.	Make the necessary settings.
	09	Service cannot be executed because necessary settings haven't been made in the command data.	Check the command format of and make the necessary settings.
	0A	The specified action or transition number has already been registered.	Execute the command again using an action or transition number that hasn't been registered.
0B	Cannot clear error because the cause of the error still exists.	Eliminate the cause of the error and execute the ERROR CLEAR command.	
30: Access right error	01	The access right is held by another device.	Execute the command again after the access right has been released. (The command can be executed after the ACCESS RIGHT FORCED ACQUIRE or ACCESS RIGHT RELEASE command is completed. Releasing the access right might affect processes in progress at the node that held the access right.)
40: Abort	01	Command was aborted with ABORT command.	---

Appendix A

FINS Command List

The following table lists the FINS commands and the PCs, Systems, and/or Units that support them. If a page number is given, the command is supported and details can be found beginning on that page. If a page number is not given, the command is not supported.

The following table is meant for comparison and reference only. Refer to the pages indicated for all details. Even if a command is supported by more than one PC, System, or Unit, the actual function and format of the command/response will depend on the PC, System, or Unit.

Command code	Name	CV-series PCs	C-series PCs	SYSMAC NET	SYSMAC LINK	Personal Computer Unit	BASIC Unit
01	01	MEMORY AREA READ	Page 19	Page 60			
	02	MEMORY AREA WRITE	Page 20	Page 61			
	03	MEMORY AREA FILL	Page 21				
	04	MULTIPLE MEMORY AREA READ	Page 21	Page 61			
	05	MEMORY AREA TRANSFER	Page 23				
02	01	PARAMETER AREA READ	Page 23				
	02	PARAMETER AREA WRITE	Page 25				
	03	PARAMETER AREA CLEAR	Page 26				
	20	DATA LINK TABLE READ			Page 74		
	21	DATA LINK TABLE WRITE			Page 75		
03	04	PROGRAM AREA PROTECT	Page 27				
	05	PROGRAM AREA PROTECT CLEAR	Page 28				
	06	PROGRAM AREA READ	Page 28	Page 62			
	07	PROGRAM AREA WRITE	Page 29	Page 63			
	08	PROGRAM AREA CLEAR	Page 30				
04	01	RUN	Page 30	Page 63	Page 77	Page 86	
	02	STOP	Page 31	Page 64	Page 77	Page 86	
	03	RESET			Page 78		
05	01	CONTROLLER DATA READ	Page 31	Page 64	Page 78	Page 87	Page 98
	02	CONNECTION DATA READ	Page 33				
06	01	CONTROLLER STATUS READ	Page 33	Page 65	Page 78	Page 88	Page 105
	02	NETWORK STATUS READ				Page 90	
	03	DATA LINK STATUS READ			Page 79	Page 91	
	20	CYCLE TIME READ	Page 35				
07	01	CLOCK READ	Page 36	Page 66			Page 98
	02	CLOCK WRITE	Page 36	Page 67			Page 99
08	01	LOOP-BACK TEST/ INTERNODE ECHO TEST			Page 80	Page 92	Page 99
	02	BROADCAST TEST RESULTS READ				Page 93	
	03	BROADCAST TEST DATA SEND				Page 93	

Command code		Name	CV-series PCs	C-series PCs	SYSMAC NET	SYSMAC LINK	Personal Computer Unit	BASIC Unit
09	20	MESSAGE READ	Page 37					
		MESSAGE CLEAR	Page 38					
		FAL/FALS READ	Page 39					
0C	01	ACCESS RIGHT ACQUIRE	Page 40					
	02	ACCESS RIGHT FORCED ACQUIRE	Page 40					
	03	ACCESS RIGHT RELEASE	Page 41					
21	01	ERROR CLEAR	Page 42	Page 67				
	02	ERROR LOG READ	Page 43		Page 81	Page 94	Page 100	Page 105
	03	ERROR LOG CLEAR	Page 44		Page 82	Page 95	Page 101	Page 106
22	01	FILE NAME READ	Page 44					
	02	SINGLE FILE READ	Page 46					
	03	SINGLE FILE WRITE	Page 46					
	04	MEMORY CARD FORMAT	Page 47					
	05	FILE DELETE	Page 47					
	06	VOLUME LABEL CREATE/DELETE	Page 48					
	07	FILE COPY	Page 49					
	08	FILE NAME CHANGE	Page 49					
	09	FILE DATA CHECK	Page 50					
	0A	MEMORY AREA FILE TRANSFER	Page 50					
	0B	PARAMETER AREA FILE TRANSFER	Page 52					
	0C	PROGRAM AREA FILE TRANSFER	Page 53					
	0F	FILE MEMORY INDEX READ		Page 68				
	10	FILE MEMORY READ		Page 68				
11	FILE MEMORY WRITE		Page 69					
23	01	FORCED SET/RESET	Page 54	Page 70				
	02	FORCED SET/RESET CANCEL	Page 55	Page 71				
	0A	MULTIPLE FORCED STATUS READ		Page 71				
26	01	NAME SET			Page 82			
	02	NAME DELETE			Page 82			
	03	NAME READ			Page 83			

Index

A

- access right
 - acquiring, 40
 - releasing, 41
- AR area
 - reading, 60, 61
 - writing, 61
- ASCII, 4
 - conversion to binary, 5
- Auxiliary Area
 - reading, 19, 21
 - writing, 20, 21

B

- BASIC Units
 - reading controller data, 104
 - reading controller status, 105
- baud rate, 6
- binary data, 4
 - conversion to ASCII, 5
- bits, controlling, 54, 55, 70, 71
- block, response block format for network communications, 9
- Bridge, 2
- broadcasting, 3, 93

C

- C-mode commands, 2
- C-series command system, 2
- CIO Area, reading, 21
- clock
 - reading, 36, 66, 98
 - setting, 36, 67, 99
- command format, Host Link Systems, 8
- command list, commands for CV-series PCs, 14
- commands, maximum size, 12
- commands for BASIC Units
 - CONTROLLER DATA READ, 104
 - CONTROLLER STATUS READ, 105
 - ERROR LOG CLEAR, 106
 - ERROR LOG READ, 105

- commands for C-series PCs
 - CLOCK READ, 66
 - CLOCK WRITE, 67
 - CONTROLLER DATA READ, 64
 - CONTROLLER STATUS READ, 65
 - ERROR CLEAR, 67
 - FILE MEMORY INDEX READ, 68
 - FILE MEMORY READ, 68
 - FILE MEMORY WRITE, 69
 - FORCED SET/RESET, 70
 - FORCED SET/RESET CANCEL, 71
 - MEMORY AREA READ, 60
 - MEMORY AREA WRITE, 61
 - MULTIPLE FORCED STATUS READ, 71
 - MULTIPLE MEMORY AREA READ, 61
 - PROGRAM AREA READ, 62
 - PROGRAM AREA WRITE, 63
 - RUN, 63
 - STOP, 64
- commands for CV-series PCs
 - ACCESS RIGHT ACQUIRE, 40
 - ACCESS RIGHT FORCED ACQUIRE, 40
 - ACCESS RIGHT RELEASE, 41
 - CLOCK READ, 36
 - CLOCK WRITE, 36
 - CONNECTION DATA READ, 33
 - CONTROLLER DATA READ, 31
 - CONTROLLER STATUS READ, 33
 - CYCLE TIME READ, 35
 - ERROR CLEAR, 42
 - ERROR LOG CLEAR, 44
 - ERROR LOG READ, 43
 - FAL/FALS READ, 39
 - FILE COPY, 49
 - FILE DATA CHECK, 50
 - FILE DELETE, 47
 - FILE NAME CHANGE, 49
 - FILE NAME READ, 44
 - FORCED SET/RESET, 54
 - FORCED SET/RESET CANCEL, 55
 - MEMORY AREA FILE TRANSFER, 50
 - MEMORY AREA FILL, 21
 - MEMORY AREA READ, 19
 - MEMORY AREA TRANSFER, 23
 - MEMORY AREA WRITE, 20
 - MEMORY CARD FORMAT, 47
 - MESSAGE CLEAR, 38
 - MESSAGE READ, 37
 - MULTIPLE MEMORY AREA READ, 21
 - PARAMETER AREA CLEAR, 26
 - PARAMETER AREA FILE TRANSFER, 52
 - PARAMETER AREA READ, 23
 - PARAMETER AREA WRITE, 25
 - PROGRAM AREA CLEAR, 30
 - PROGRAM AREA FILE TRANSFER, 53

commands for CV-series PCs, continued
 PROGRAM AREA PROTECT, 27
 PROGRAM AREA PROTECT CLEAR, 28
 PROGRAM AREA READ, 28
 PROGRAM AREA WRITE, 29
 RUN, 30
 SINGLE FILE READ, 46
 SINGLE FILE WRITE, 46
 STOP, 31
 VOLUME LABEL CREATE/DELETE, 48

commands for Personal Computer Units
 CLOCK READ, 98
 CLOCK WRITE, 99
 CONTROLLER DATA READ, 98
 ERROR LOG CLEAR, 101
 ERROR LOG READ, 100
 INTERNODE ECHO TEST, 99

commands for SYSMAC LINK
 BROADCAST TEST DATA SEND, 93
 BROADCAST TEST RESULTS READ, 93
 CONTROLELR STATUS READ, 88
 CONTROLLER DATA READ, 87
 DATA LINK STATUS READ, 91
 ERROR LOG CLEAR, 95
 ERROR LOG READ, 94
 INTERNODE ECHO TEST, 92
 NETWORK STATUS READ, 90
 RUN, 86
 STOP, 86

commands for SYSMAC NET
 CONTROLLER DATA READ, 78
 CONTROLLER STATUS READ, 78
 DATA LINK STATUS READ, 79
 DATA LINK TABLE READ, 74
 DATA LINK TABLE WRITE, 75
 ERROR LOG CLEAR, 82
 ERROR LOG READ, 81
 LOOP-BACK TEST, 80
 NAME DELETE, 82
 NAME READ, 83
 NAME SET, 82
 RESET, 78
 RUN, 77
 STOP, 77

communications
 broadcast test, 93
 broadcasting, 93
 internetwork, 2
 internode, 3
 setting high-speed communications, 4
 testing, 80, 92, 99

counters
 changing PV, 20, 21, 61
 reading Completion Flag status, 21, 60, 61
 reading PV, 19, 21, 60, 61

CPU Bus Unit, configuration, 32
 CPU Bus Units, 4
 CV-mode commands. *See* FINS commands
 CV-series command system, 2
 cycle time, reading, 35

D

DA1, 7
 DA2, 7
 data areas. *See* Memory Areas
 data formats, 4
 data link tables
 reading, 74
 writing, 75
 data links
 activating, 77
 reading status, 79, 91
 starting, 86
 stopping, 77, 86
 data structure
 commands, 6
 responses, 6
 datagram service, 2
 destination network address, 7
 destination node number, 7
 destination unit address, 7
 destinations, 3, 6
 differences in commands, 4
 DM Area
 reading, 19, 21, 60, 61
 writing, 20, 21, 61
 DNA, 7

E

error flags, 79
 error logs
 clearing, 82, 101, 106
 reading, 81, 100, 105
 error messages, 35, 66
 errors
 clearing, 42, 44, 67, 82, 95, 106
 reading, 39, 43, 94, 105
 response codes, 108

F

FAL/FALS messages, 39
 FAL/FALS no., 35, 66
 fatal error data, 34, 66
 FCS (frame checksum) calculation, 10

File Memory
 reading, 68
 reading index data, 68
 writing, 69

files
 changing file names, 49
 checking data, 50
 comparing, 50, 52, 53
 copying, 49
 creating/deleting volume labels, 48
 deleting, 47
 file names, 18
 reading, 44, 46
 transferring, 50, 52, 53
 writing, 46

FINS commands
 errors, 108
 response codes, errors, 108

forced status
 canceling, 71
 controlling, 70
 reading, 71

frame checksum, 10

G-L

gateway, 2
gateway count, 7
GCT, 7
header, Host Link Systems, 7
header code, 8
header data, 6, 7
Host Link Systems
 command format, 8
 communications, 7
ICF, 6
IR area, reading, 60, 61
loop back test, 92

M

maximum data length, 6
memory areas
 comparing/transferring, 50
 designating addresses, 15, 58
 reading, 19, 21, 60
 reading contents, 19
 reading contents of Memory Area words, 61
 transferring data, 23
 writing, 20, 21, 61

Memory Cards, formatting, 47
message service, 2
messages, 35
 clearing, 38
 reading, 37, 39
model numbers
 BASIC Units, 104
 Personal Computer Unit, 98
 reading, 87
 reading model numbers of specified Units, 33
 reading PC model number, 31, 64

N

names, SYSMAC NET Link Units
 deleting, 82
 reading, 83
 setting, 82
network levels, 2
networks, 2
 differences, 5
 reading network status, 90
node number, 8
nodes, maximum number, 6
non-fatal error data, 35, 66

P

Parameter Areas
 clearing, 26
 comparing/transferring, 52
 reading, 23
 writing, 25
parameters, 6
PC
 aborting current process, 55
 changing to PROGRAM mode, 31, 64
 changing to RUN mode, 30, 63
 PC memory address. *See* Memory Areas
 PC memory addresses. *See* Memory Areas
 reading, 64
 reading controller data, 31
 reading controller status, 33, 65
 reading cycle time, 35
 reading data, 87
 reading status, 88
PC modes, 34, 65
PC status, 33, 65, 79
Personal Computer Unit, reading controller data, 98
program
 clearing, 30
 clearing protection of the program area, 28
 comparing/transferring, 53
 protecting the program area, 27
 reading, 28, 62
 writing, 63
 writing to program area words, 29

R

remote I/O systems, 33
response block. *See* block
response codes, 108
response delay, 8
responses, 3
 maximum number of characters, 9
 maximum size, 12
RSV, 7

S

SA1, 7
SA2, 7
service ID, 7
SID, 7
SNA, 7
source network address, 7
source node number, 7
source unit address, 7

SYSMAC LINK Systems, communications, 11

SYSMAC NET Link Units
 deleting names, 82
 reading controller data, 78
 reading controller status, 78
 reading names, 83
 resetting, 78
 setting names, 82

SYSMAC NET Systems, communications, 11

T–V

terminator, 9
test, loop back, 92
timers
 changing PV, 20, 21, 61
 reading Completion Flag status, 21, 60, 61
 reading PV, 19, 21, 60, 61
unit addresses, 4
unit number, 8
Units, reading the model numbers of connected Units,
 33
volume labels, 18
 creating/deleting, 48

Revision History

A manual revision code appears as a suffix to the catalog number on the front cover of the manual.

Cat. No. W227-E1-2

↑
Revision code

The following table outlines the changes made to the manual during each revision. Page numbers refer to the previous version.

Revision code	Date	Revised content
1	June 1993	Original production
2	June 2001	Page 8: "Hexadecimal" changed to "BCD" in node number description. Page 13: Model numbers updated.