

**SYSMAC**

**CX-Simulator Ver. 2.0**

**CXONE-AL□□D-V4**

**OPERATION MANUAL**

**OMRON**

## **NOTE**

All rights reserved. No part of this publication may be reproduced, stored in a retrieval system, or transmitted, in any form, or by any means, mechanical, electronic, photocopying, recording, or otherwise, without the prior written permission of OMRON.

No patent liability is assumed with respect to the use of the information contained herein. Moreover, because OMRON is constantly striving to improve its high-quality products, the information contained in this manual is subject to change without notice. Every precaution has been taken in the preparation of this manual. Nevertheless, OMRON assumes no responsibility for errors or omissions. Neither is any liability assumed for damages resulting from the use of the information contained in this publication.

## **Trademarks**

- Microsoft, Windows, and Windows Vista are either registered trademarks or trademarks of Microsoft Corporation in the United States and other countries.
- ODVA, CIP, CompoNet, DeviceNet, and EtherNet/IP are trademarks of ODVA.

Other company names and product names in this document are the trademarks or registered trademarks of their respective companies.

## **Copyrights**

Microsoft product screen shots reprinted with permission from Microsoft Corporation.

# **SYSMAC CX-Simulator Ver. 2.0**

## **CXONE-AL□□D-V4**

### **Operation Manual**

*Revised September 2019*

## **Notice:**

OMRON products are manufactured for use according to proper procedures by a qualified operator and only for the purposes described in this manual.

The following conventions are used to indicate and classify precautions in this manual. Always heed the information provided with them. Failure to heed precautions can result in injury to people or damage to property.

 **DANGER** Indicates an imminently hazardous situation which, if not avoided, will result in death or serious injury. Additionally, there may be severe property damage.

 **WARNING** Indicates a potentially hazardous situation which, if not avoided, could result in death or serious injury. Additionally, there may be severe property damage.

 **Caution** Indicates a potentially hazardous situation which, if not avoided, may result in minor or moderate injury, or property damage.

## **OMRON Product References**

All OMRON products are capitalized in this manual. The word "Unit" is also capitalized when it refers to an OMRON product, regardless of whether or not it appears in the proper name of the product.

The abbreviation "Ch," which appears in some displays and on some OMRON products, often means "word" and is abbreviated "Wd" in documentation in this sense.

In this manual, "PLC" is used as the abbreviation for Programmable Controller.

## **Visual Aids**

The following headings appear in the left column of the manual to help you locate different types of information.

**Note** Indicates information of particular interest for efficient and convenient operation of the product.

**1, 2, 3...** 1. Indicates lists of one sort or another, such as procedures, checklists, etc.

# About Upgrades:

## Version 1.1

The following functions have been added to the CX-Simulator with the upgrade from Version 1.0 to Version 1.1.

### Actual Serial Communications Possible

In Ver.1.0, the contents of messages sent by serial communications instructions are displayed on the computer screen. In Ver.1.1, actual serial communications to an external serial communications device connected to a COM port on the computer are also possible.

### NT Link (1:N Mode) Possible

In Ver.1.1, communications with OMRON's Programmable Terminal (PT) connected to a COM port on the computer via NT Link are possible.

### Multipoint Data Collection Tool Added

Time-series I/O memory data acquired from the actual PLC can be saved as a Data Replay File (CSV format). Unlike Data Trace, data can not be acquired every cycle. However, data of more than 50 words can be acquired.

### WindowsMe/2000 Supported

### Serial Number Entry on Installing Added

## Version 1.2

The following functions have been added to the CX-Simulator with the upgrade from Version 1.1 to Version 1.2.

### New PLCs Supported

Simulation is newly supported for the following PLCs.

Series	CPU Unit model numbers
CS	CS1H-CPU67H/66H/65H/64H/63H CS1G-CPU45H/44H/43H/42H
CJ	CJ1H-CPU66H/65H CJ1G-CPU45H/44H/43H/42H CJ1G-CPU45/44

### Functionality Improved

The following functions have been improved so that the same operation as that performed by the actual PLC is performed by the CX-Simulator. (There were some differences in operation with version 1.1.)

- Processing when using index registers for automatic incrementing or decrementing with sequence output instructions.
- Processing the current EM bank is changed during execution of the ladder program.
- Break processing for nested FOR-NEXT loops.
- Processing for decrementing counters in certain ladder program structures.

## Simplified System Exit Processing

When the system is exited while the CX-Simulator is connected, a confirmation dialog box will appear and, upon confirmation, the CX-Simulator will be disconnected and the system shut down.

## Version 1.3

The following functions have been added to the CX-Simulator with the upgrade from Version 1.2 to Version 1.3.

### New PLCs Supported

Simulation is newly supported for the following PLCs.

Series	CPU Unit model numbers
CJ	CJ1M-CPU23/22/13/12

New Units in the CS and CJ Series are also supported for PLC Unit registration.

### Starting and Connecting the CX-Simulator from the CX-Programmer

With CX-Programmer version 3.0 or higher, the CX-Simulator can be started and connected (placed online) from the CX-Programmer. After going online, program transfer to the CX-Simulator can be started immediately.

### Windows XP Supported

## Version 1.4

The following functions have been added to the CX-Simulator with the upgrade from Version 1.3 to Version 1.4.

### New PLCs Supported

Simulation is newly supported for the following PLCs.

Series	CPU Unit model numbers
CS	CS1D-CPU67H/65H CS1D-CPU67S/65S/44S/42S
CJ	CJ1M-CPU23/22/21/13/12/11

New Units in the CS and CJ Series are also supported for PLC Unit registration.

## Version 1.5

The changes that have been made from version 1.4 to version 1.5 of the CX-Simulator to enable support of new CPU Unit models are explained here.

### New PLCs Supported

CX-Simulator version 1.5 supports the following new CPU Units.

Series	CPU Unit model
CS	CJ1H-CPU67H

CPU Unit Version Upgrade Compatibility

CX-Simulator version 1.5 supports the following CS/CJ-series CPU Units with unit version 3.0.

Series	Device type
CS/CJ	CS1G-H, CS1H-H, CJ1G-H, CJ1H-H, CJ1M

## Function Block (Ladder Programming Language) Simulation

CX-Simulator version 1.5 can be used to simulate function blocks that are supported for CS/CJ-series CPU Units with unit version 3.0 (function block algorithms can be written in the ladder programming language or in the structured text (ST)). Step execution of instructions contained in ladder programming language or structured text within a function block, however, is not supported.

### Precautions

CX-Simulator version 1.5 can simulate the operations of a CS/CJ-series CPU Unit with version 3.0 on a personal computer. The simulation, however, operates differently from the actual CS/CJ-series CPU Unit with unit version 3.0 in the system.

- Processing when using index registers for automatic incrementing or decrementing with sequence output instructions. No-protocol communications instructions sent to the serial port of the Serial Communications Unit will not be executed.  
CX-Simulator version 1.5 does not support no-protocol instructions (TXDU(256) and RXDU(255)) sent to the serial port of the Serial Communications Unit and will not execute these instructions.
- The *Comms Instructions Settings in FB* field in PLC Settings is disabled.  
The *Comms Instructions Settings in FB* field (CPU Settings Tab) is a PLC setting specific to the OMRON FB library. Therefore, this setting is disabled when using CX-Simulator version 1.5.
- Free Running Timers in Auxiliary Area words A000 and A001 are disabled.  
The Auxiliary Area word 10-ms Incrementing Free Running Timer (A000) and 100-ms Incrementing Free Running Timer (A001) that are supported for CS/CJ-series CPU Units with version 3.0 or later cannot be used in simulation operations.

## Version 1.6

The changes that have been made from version 1.5 to version 1.6 of the CX-Simulator to enable support of new functions are explained here.

### New PLCs Supported

CX-Simulator version 1.6 supports the following new CPU Units.

Series	CPU Unit model
CP	CP1H-XA/X
NSJ (Controller Section)	G5D (Used for the NSJ5-TQ0□-G5D, NSJ5-SQ0□-G5D, NSJ8-TV0□-G5D, NSJ10-TV0□-G5D, and NSJ12-TS0□-G5D)

## CX-Programmer Simulation Functions

If CX-Programmer version 6.1 or higher and CX-Simulator version 1.6 or higher are installed, the following CX-Programmer simulation functions can be used.

- Applicability: Ladder programs or programs in function blocks (ladder programs or ST)
- Simulation functions: Step execution, continuous step execution, scan execution, and break-point operation (Note: I/O conditions cannot be set.)

Refer to the *CX-Programmer Operation Manual (W446)* for details.

## Version 1.7

The changes that have been made from version 1.6 to version 1.7 of the CX-Simulator to enable support of new functions are explained here.

## New PLCs Supported

CX-Simulator version 1.7 supports the following new CPU Units.

Series	CPU Unit model
CP	CP1H-XA□□□□-□ CP1H-X□□□□-□ CP1H-Y□□□□-□
NSJ (Controller Section)	M3D (Used for the NSJ5-TQ0□-M3D, NSJ5-SQ0□-M3D, and NSJ8-TV0□-M3D)

## Integrated Simulation with Screen Operations for Virtual PT (Programmable Terminal)

The *PLC-PT Integrated Simulation* icon can be used to perform integrated simulations using CX-Designer version 2.0 or higher and CX-Simulator version 1.7 or higher. This enables debugging by linking user program execution on a virtual PLC with the CX-Programmer/CX-Simulator with screen operations for a virtual PT using the CX-Designer's Test Tool.

- Starting the CX-Simulator:  
The CX-Simulator is started by selecting the *PLC-PT Integrated Simulation* menu item from CX-Designer version 2.0 or higher. (The user program is automatically transferred to the CX-Simulator when it starts.)
- Connecting the CX-Simulator to virtual PT screens:  
Automatically executed.

Refer to the operation manual for CX-Designer version 2.0 or higher for details.

## Version 1.8

The changes that have been made from version 1.7 to version 1.8 of the CX-Simulator to enable support of new functions are explained here.

## New PLCs Supported

CX-Simulator version 1.8 supports the following new CPU Units.

Series	CPU Unit model
CP	CP1L-M□□□□-□ CP1L-L□□□□-□
CJ	CJ1H-CPU67H-R/66H-R/65H-R/64H-R

## Version 1.9

The changes that have been made from version 1.8 to version 1.9 of the CX-Simulator to enable support of new functions are explained here.

## New PLCs Supported

CX-Simulator version 1.9 supports the following new CPU Units.

Series	CPU Unit model
CJ	CJ2H-CPU68-EIP/67-EIP/66-EIP/65-EIP/64-EIP

## Version 1.91

The changes that have been made from version 1.9 to version 1.91 of the CX-Simulator to enable support of new functions are explained here.

## New PLCs Supported

CX-Simulator version 1.91 supports the following new CPU Units.

Series	CPU Unit model
CJ	CJ2H-CPU68/67/66/65/64



## Version 1.94

The changes that have been made from version 1.9 to version 1.94 of the CX-Simulator to enable support of new functions are explained here.

### Support for Windows 7

**Note** This upgrade accompanies the upgrade of CX-One version 3.2 to CX-One version 4.03.

## Version 1.95

The following functions have been added to the CX-Simulator with the upgrade from Version 1.94 to Version 1.95.

### New PLCs Supported

Simulation is newly supported for the following PLCs.

Series	CPU Unit model
CJ	CJ2M-CPU11/12/13/14/15/31/32/33/34/35

## Version 1.98

The following functions have been added to the CX-Simulator with the upgrade from Version 1.95 to Version 1.98.

### New PLCs Supported

Simulation is newly supported for the CJ2M CPU Units with unit version 2.0.

## Version 1.991

The changes that have been made from version 1.98 to version 1.991 of the CX-Simulator to enable support of new functions are explained here.

### New PLCs Supported

CX-Simulator version 1.991 supports the following new CPU Units.

Series	CPU Unit model
CP	CP1L-EM□□□□-□ CP1L-EL□□□□-□

## Version 2.0

The changes that have been made from version 1.991 to version 2.0 of the CX-Simulator to enable support of new functions are explained here.

## New PLCs Supported

CX-Simulator version 2.0 supports the following new CPU Units.

Series	CPU Unit model
CS	CS1D-CPU68HA/67HA/67SA/44SA

## Version 2.01

The changes that have been made from version 2.0 to version 2.01 of the CX-Simulator to enable support of new functions are explained here.

## New PLCs Supported

CX-Simulator version 2.01 supports the following new CPU Units.

Series	CPU Unit model
CP2	CP2E- E□□DR-A CP2E- S□□D□-□ CP2E- N□□D□-□

# ***Unit Versions of CS/CJ/CP/NSJ-series CPU Units***

## **Unit Versions**

A “unit version” has been introduced to manage CPU Units in the CS/CJ/CP/NSJ Series according to differences in functionality accompanying Unit upgrades. This applies to the CJ2H, CJ2M, CS1-H, CJ1-H, CJ1M, CS1D, CP1H, CP1L, CP1E and CP2E CPU Units. Refer to the *Unit Versions of CS/CJ/CP-series CPU Units* of the *CX-Programmer Operation Manual* (Cat. No. W446) for details.



# TABLE OF CONTENTS

<b>PRECAUTIONS.....</b>	<b>XXII</b>
1 Intended Audience.....	xxiii
2 General Precautions.....	xxiii
3 Safety Precautions.....	xxiii
4 Application Precautions.....	xxiv
<b>SECTION 1</b>	
<b>INTRODUCTION.....</b>	<b>1</b>
1-1 What Is the CX-Simulator?.....	2
1-2 Features.....	9
1-3 Convenient Functions.....	13
1-4 Applicable PLC models and Computers.....	14
1-5 Operation List Arranged by Purpose.....	16
1-6 Comparison of CX-Simulator and SYSMAC CS/CJ-series PLCs.....	18
<b>SECTION 2</b>	
<b>SETUP.....</b>	<b>25</b>
2-1 Installing and Uninstalling the Software.....	26
<b>SECTION 3</b>	
<b>BASIC OPERATION.....</b>	<b>27</b>
3-1 Starting Methods for the CX-Simulator.....	28
3-2 Starting and Going Online from the CX-Programmer.....	29
3-3 Starting and Exiting from CX-Simulator Menus.....	32
3-4 Outline of Operation Procedure.....	34
3-5 Creating a New PLC.....	38
3-6 Each Part of the Windows.....	48
3-7 System Status Setting Window.....	50
3-8 Connecting to the CX-Programmer Version 2.1 or Lower.....	61
3-9 Debug Console Window.....	66
<b>SECTION 4</b>	
<b>DEBUGGING PROGRAMS.....</b>	<b>91</b>
4-1 Debugging Using the CX-Programmer.....	92
4-2 Debugging Operation.....	93
4-3 Step Run and Break.....	97
4-4 Task Debugging.....	105
<b>SECTION 5</b>	
<b>DEBUGGING SERIAL COMMUNICATIONS.....</b>	<b>109</b>
5-1 Outline of Serial Communications.....	110

5-2 Serial Communications Settings.....	113
5-3 Serial Communications Connection .....	117
5-4 Connecting PT via NT Link .....	120
5-5 Examples of Serial Communications Debugging.....	121
<b>SECTION 6</b>	
<b>DEBUGGING NETWORK COMMUNICATIONS .....</b>	<b>125</b>
6-1 Outline of Network Communications.....	126
6-2 Network Communications Settings .....	129
6-3 Network Connection.....	132
6-4 Example of Debugging Network Communications.....	133
6-5 Available FINS Commands.....	137
<b>SECTION 7</b>	
<b>CONNECTION WITH APPLICATION PROGRAMS .....</b>	<b>149</b>
7-1 Outline of Connection .....	150
7-2 Connection with Application Programs .....	151
<b>SECTION 8</b>	
<b>DEBUGGING USING VIRTUAL EXTERNAL INPUTS.....</b>	<b>147</b>
8-1 Outline of Virtual External Input Function .....	148
8-2 Debugging Using Virtual External Inputs.....	149
8-3 Generating Virtual External Inputs .....	152
8-4 Running by Virtual External Inputs .....	166
8-5 Checking the Result.....	174
<b>SECTION 9</b>	
<b>CPU UNIT OPERATION .....</b>	<b>177</b>
9-1 CPU Unit Operation .....	178
9-2 Cycle Time and Time .....	182
9-3 I/O Memory Allocation .....	190
9-4 Other Functions .....	227
<b>SECTION 10</b>	
<b>TROUBLESHOOTING.....</b>	<b>228</b>
10-1 Error Processing .....	229
10-2 Alarms and Remedies.....	234
10-3 Other Tips for Troubleshooting.....	236
<b>APPENDIX</b>	
<b>HOW TO USE DATA TRACE RECORDING TOOL .....</b>	<b>239</b>
<b>REVISION HISTORY.....</b>	<b>251</b>

## About this Manual:

This manual describes operating procedures of the CX-Simulator for SYSMAC CS/CJ/CP/NSJ-series Programmable Controllers (PLCs).

Please read this manual and all related manuals listed in the following table and be sure you understand the information provided before attempting to operate the CX-Simulator.

Name	Cat. No.	Use	Contents
CXONE-AL□□D-V4 CX-Simulator Operation Manual (this manual)	W366	To learn how to operate CX-Simulator for Windows personal computers. To use simulation functions on the CX-Programmer, with CX-Programmer Ver. 6.1 or higher.	Describes the operation of the CX-Simulator.  Use this together with the CX-Programmer Operation Manual (W446), CJ Series CJ2 CPU Unit Hardware User's Manual (W472), CJ Series CJ2 CPU Unit Software User's Manual (W473), CS Series and CJ Series Operation Manuals (CS Series: W339, CJ Series: W393), and CS/CJ/NSJ Series Instructions Reference Manual (W474).
CXONE-AL□□D-V4/ CXONE-LT□□□-V4 CX-One Setup Manual	W463	To install software from CX-One.	Provides an outline of the CX-One FA integration software package, and describes the method for installing CX-One.
CXONE-AL□□D-V4 CX-Programmer Ver. 9 Operation Manual	W446	To learn how to operate CX-Programmer for Windows personal computers.	Describes the operation of the CX-Programmer.  For programming, use this together with the <i>CJ2H Programmable Controllers Hardware User's Manual (W472)</i> , the <i>CJ2H Programmable Controllers Software User's Manual (W473)</i> , and the <i>Programmable Controllers Instructions Reference Manual (W474)</i> .
CXONE-AL□□D-V4 CX-Programmer Ver. 9 Operation Manual Function Blocks/Structured Texts	W447		
CXONE-AL□□D-V4 CX-Integrator Operation Manual	W464	To make network settings and monitor.	Describes the operation of the CX-Integrator.
CJ Series CJ2 CPU Unit Hardware User's Manual CJ2H-CPU6□-EIP, CJ2H-CPU6□, CJ2M-CPU1□, CJ2M-CPU3□	W472	---	Provides the following information on the CJ2 CPU Units:  Overview, system design, hardware specifications, hardware settings, installation, wiring, maintenance, and troubleshooting.  Use this manual together with the <i>CJ2 CPU Unit Software User's Manual (W473)</i> .
CJ Series CJ2 CPU Unit Software User's Manual CJ2H-CPU6□-EIP, CJ2H-CPU6□, CJ2M-CPU1□, CJ2M-CPU3□	W473	---	Provides the following information on the CJ2 CPU Units:  Overview of CPU Unit operation, programming, software settings, CPU Unit functions, and system startup.  Use this manual together with the <i>CJ2 CPU Unit Hardware User's Manual (W472)</i> .
SYSMAC CS Series CS1G/H-CPU□□H Programmable Controllers Operation Manual	W339	To learn the basic specifications of the CS-series PLCs, including a basic outline, settings, installation, and maintenance.	Describes the features, system configuration design, installation, wiring, I/O memory allocation, and troubleshooting of the CS-series PLCs.  Use this together with the Programming Manual (W394).
SYSMAC CJ Series CJ1H-CPU□□H-R, CJ1G/H-CPU□□H, CJ1G-CPU□□P, CJ1G-CPU□□, CJ1M-CPU□□ Programmable Controllers Operation Manual	W393	To learn the basic specifications of the CJ-series PLCs, including a basic outline, settings, installation, and maintenance.	Describes the features, system configuration design, installation, wiring, I/O memory allocation, and troubleshooting of the CJ-series PLCs.  Use this together with the Programming Manual (W394).
SYSMAC CS/CJ/NSJ Series CS1G/H-CPU□□-EV1, CS1G/H-CPU□□H, CS1D-CPU□□HA, CS1D-CPU□□SA, CS1D-CPU□□P, CS1D-CPU□□H, CS1D-CPU□□S, CJ1H-CPU□□H-R, CJ1G-CPU□□, CJ1G/H-CPU□□H, CJ1M-CPU□□, NSJ□-□□□□(B)-G5D, NSJ□-□□□□(B)-M3D Programmable Controllers Programming Manual	W394	To learn the functions of the CS/CJ-series PLCs.	Describes the programming, task functions, file memory functions, and other functions of the CS/CJ-series PLCs.

Name	Cat. No.	Use	Contents
SYSMAC CS/CJ/NSJ Series CS1G/H-CPU□□-EV1, CS1G/H-CPU□□H, CS1D-CPU□□HA, CS1D-CPU□□SA, CS1D-CPU□□P, CS1D-CPU□□H, CS1D-CPU□□S, CJ2H-CPU6□-EIP, CJ2H-CPU6□, CJ2M-CPU1□, CJ2M-CPU3□, CJ1H-CPU□□H-R, CJ1G-CPU□□P, CJ1G-CPU□□, CJ1G/H-CPU□□H, CJ1M-CPU□□, NSJ□-□□□□(B)-G5D, NSJ□-□□□□(B)-M3D Programmable Controllers Instructions Reference Manual	W474	To learn details of the instruction language.	Describes the details of the instruction language.  For programming, use this together with the CS Series and CJ Series Operation Manuals (CS Series: W339, CJ Series: W393), and Programming Manual (W394).
SYSMAC CS/CJ/CP/NSJ Series CS1G/H-CPU□□-EV1, CS1G/H-CPU□□H, CS1D-CPU□□HA, CS1D-CPU□□SA, CS1D-CPU□□P, CS1D-CPU□□H, CS1D-CPU□□S, CJ2H-CPU6□-EIP, CJ2H-CPU6□, CJ2M-CPU1□, CJ2M-CPU3□, CJ1H-CPU□□H-R, CJ1G-CPU□□, CJ1M-CPU□□, CJ1G-CPU□□P, CJ1G/H-CPU□□H, CS1W-SCU□□-V1, CS1W-SCB□□-V1, CJ1W-SCU□□-V1, CP1L-M/L□□□□-□, CP1H-X□□□□□-□, CP1H-XA□□□□□□-□, CP1H-Y□□□□□□-□, CP1E-E□□□□□-□, CP1E-N□□□□□-□, NSJ□-□□□□ (B)-G5D, NSJ□-□□□□(B)-M3D Communications Commands Reference Manual	W342	To learn about communications commands addressed to CS/CJ/CP-series CPU Units and NSJ-series Controllers.	Describes the following information.  • C-mode commands • FINS commands <b>Note:</b> Refer to this manual when sending C-mode or FINS commands to the CPU Unit. This manual describes commands addressed to the CPU Unit without reference to the communications path. (Commands can be sent via the serial ports on the CPU Unit, ports on a Serial Communications Board or Unit, or ports on Communications Units.)
NSJ5-TQ□□□(B)-G5D NSJ5-SQ□□□(B)-G5D NSJ8-TV□□□(B)-G5D NSJ10-TV□□□(B)-G5D NS12-TS□□□(B)-G5D NSJ5-TQ□□□(B)-M3D NSJ5-SQ□□□(B)-M3D NSJ8-TV□□□(B)-M3D NSJW-ETN21 NSJW-CLK21-V1 NSJW-IC101 NSJ Series NSJ Controllers Operation Manual	W452	To learn the basic specifications of the NSJ-series NSJ Controllers, including a basic outline, settings, installation, and maintenance.	Describes the following information about the NSJ-series NSJ Controllers:  Overview and features Designing the system configuration Installation and wiring I/O memory allocations Troubleshooting and maintenance  Use this manual in combination with the following manuals: SYSMAC CS Series Operation Manual (W339), SYSMAC CJ Series Operation Manual (W393), SYSMAC CS/CJ Series Programming Manual (W394), and NS-V1/-V2 Series Setup Manual (V083)
CP1H-X□□□□□-□, CP1H-XA□□□□□□-□, CP1H-Y□□□□□□-□, SYSMAC CP Series CP1H CPU Unit Operation Manual	W450	To learn the basic specifications of the CP-series CP1H CPU Units, including a basic outline, settings, installation, and maintenance.	Provides the following information on the CP Series CP1H CPU Unit: • Overview/Features • System configuration • Mounting and wiring • I/O memory allocation • Troubleshooting Use this manual together with the <i>CP1H Programmable Controllers Programming Manual (W451)</i> .
CP1L-M□□□□□-□, CP1L-L□□□□□-□, CP Series CP1L Operation Manual	W462	To learn the basic specifications of the CP-series CP1L CPU Units, including a basic outline, settings, installation, and maintenance.	Provides the following information on the CP Series CP1L CPU Unit: • Overview/Features • System configuration • Mounting and wiring • I/O memory allocation • Troubleshooting Use this manual together with the <i>CP1H Programmable Controllers Programming Manual (W451)</i> .
CP1H-X□□□□□-□, CP1H-XA□□□□□□-□, CP1H-Y□□□□□□-□, CP1L-M□□□□□-□, CP1L-L□□□□□-□ SYSMAC CP Series CP1H/CP1L CPU Unit Programming Manual	W451	To learn about programming CP-series CP1H/CP1L CPU Units.	Provides the following information on the CP Series CP1H/CP1L CPU Unit: • Programming instructions • Programming methods • Tasks



Name	Cat. No.	Use	Contents
CP1L-EM□□□□-□, CP1L-EL□□□□-□, SYSMAC CP Series CP1L-EL/EM CPU Unit Operation Manual	W516	To learn the basic specifications of the CP-series CP1L-EL/EM CPU Units, including a basic outline, settings, installation, and maintenance.	Provides the following information on the CP Series CP1L-EL/EM CPU Unit: <ul style="list-style-type: none"> <li>• Overview/Features</li> <li>• System configuration</li> <li>• Mounting and wiring</li> <li>• I/O memory allocation</li> <li>• Troubleshooting</li> </ul> Use this manual together with the <i>CP1H Programmable Controllers Programming Manual (W451)</i> .
CP2E-E□□D□-□, CP2E-S□□D□-□, CP2E-N□□D□-□, SYSMAC CP Series CP2E CPU Unit Hardware User's Manual	W613	To learn the hardware specifications of the CP2E PLCs	Describes the following information for CP2E PLCs. <ul style="list-style-type: none"> <li>• Overview and features</li> <li>• Basic system configuration</li> <li>• Part names and functions</li> <li>• Installation and settings</li> <li>• Troubleshooting</li> </ul>
CP2E-E□□D□-□, CP2E-S□□D□-□, CP2E-N□□D□-□, SYSMAC CP Series CP2E CPU Unit Software User's Manual	W614	To learn the software specifications of the CP2E PLCs	Describes the following information for CP2E PLCs. <ul style="list-style-type: none"> <li>• CPU Unit operation</li> <li>• Internal memory</li> <li>• Programming</li> <li>• Settings</li> <li>• CPU Unit built-in functions</li> <li>• Interrupts</li> <li>• High-speed counter inputs</li> <li>• Pulse outputs</li> <li>• Serial communications</li> <li>• Ethernet communications</li> <li>• Analog option board</li> <li>• Other functions</li> </ul>
CP1E-E□□D□-□, CP1E-N□□D□-□, CP1E-NA□□D□-□, CP2E-E□□D□-□, CP2E-S□□D□-□, CP2E-N□□D□-□, SYSMAC CP Series CP1E/CP2E CPU Unit Instructions Reference Manual	W483	To learn programming instructions in detail	Describes each programming instruction in detail.



### WARNING

Failure to read and understand the information provided in this manual may result in personal injury or death, damage to the product, or product failure. Please read each section in its entirety and be sure you understand the information provided in the section and related sections before attempting any of the procedures or operations given.

## About this Manual, Continued

This manual contains the following sections.

**Section 1** introduces the special features and functions of the CX-Simulator and a comparison between SYSMAC CS/CJ/CP/NSJ-series PLCs

**Section 2** provides the information on how to setup the CX-Simulator.

**Section 3** describes the basic operation of the CX-Simulator.

**Section 4** describes how to debug user programs.

**Section 5** describes how to debug Serial Communications functions.

**Section 6** describes how to debug Network Communications functions.

**Section 7** describes how to connect with application programs.

**Section 8** provides information on how to debug using virtual external inputs.

**Section 9** describes operations of the CPU Unit including cycle times and I/O Memory allocation.

**Section 10** provides information on errors and alarms that occur during the operation along with the remedies.

**Appendix** provides information on how to use the Data Trace Recording Tool.



# ***Terms and Conditions Agreement***

## **WARRANTY**

- The warranty period for the Software is one year from the date of purchase, unless otherwise specifically agreed.
- If the User discovers defect of the Software (substantial non-conformity with the manual), and return it to OMRON within the above warranty period, OMRON will replace the Software without charge by offering media or download from OMRON's website. And if the User discovers defect of media which is attributable to OMRON and return it to OMRON within the above warranty period, OMRON will replace defective media without charge. If OMRON is unable to replace defective media or correct the Software, the liability of OMRON and the User's remedy shall be limited to the refund of the license fee paid to OMRON for the Software.

## **LIMITATION OF LIABILITY**

- THE ABOVE WARRANTY SHALL CONSTITUTE THE USER'S SOLE AND EXCLUSIVE REMEDIES AGAINST OMRON AND THERE ARE NO OTHER WARRANTIES, EXPRESSED OR IMPLIED, INCLUDING BUT NOT LIMITED TO, WARRANTY OF MERCHANTABILITY OR FITNESS FOR PARTICULAR PURPOSE. IN NO EVENT, OMRON WILL BE LIABLE FOR ANY LOST PROFITS OR OTHER INDIRECT, INCIDENTAL, SPECIAL OR CONSEQUENTIAL DAMAGES ARISING OUT OF USE OF THE SOFTWARE.
- OMRON SHALL HAVE NO LIABILITY FOR DEFECT OF THE SOFTWARE BASED ON MODIFICATION OR ALTERNATION TO THE SOFTWARE BY THE USER OR ANY THIRD PARTY.
- OMRON SHALL HAVE NO LIABILITY FOR SOFTWARE DEVELOPED BY THE USER OR ANY THIRD PARTY BASED ON THE SOFTWARE OR ANY CONSEQUENCE THEREOF.

## **APPLICABLE CONDITIONS**

USER SHALL NOT USE THE SOFTWARE FOR THE PURPOSE THAT IS NOT PROVIDED IN THE ATTACHED USER MANUAL.

## **CHANGE IN SPECIFICATION**

The software specifications and accessories may be changed at any time based on improvements and other reasons.

## **ERRORS AND OMISSIONS**

The information in this manual has been carefully checked and is believed to be accurate; however, no responsibility is assumed for clerical, typographical, or proofreading errors, or omissions.



# **Notation**

This manual describes operation items as follows:

## **Notation Examples**

"[ ]" indicates a menu name, key, dialog box name, or button name. However, in some cases where it is obviously a menu name, [ ] is not attached.

Example: [File] menu, [Tab] key, [Search] dialog box, [OK] button

"|" indicates the hierarchy for a menu or display.

Example:

- "Select [File] | [Create]" indicates "select [Create] from the [File] menu."
- "Select [PLC] | [Operation Mode] | [Monitor]" indicates "select [Operation Mode] from the [PLC] menu and then select [Monitor]."
- "Select [System Status] | [Settings] | [UM Setting]" indicates "select the [Settings] button from the [System Status] window and then select [UM Setting] from the pop-up menu."

"[ ] + [ ]" indicates pressing multiple keys simultaneously.

Example:

- "[Ctrl] + [S]" indicates "press [S] key with the [Ctrl] key held down."
- "[Ctrl] + [Shift] + [L]" indicates "press the [L] key with the [Ctrl] and [Shift] keys held down."

## **About Operation Examples**

This manual describes operation and settings assuming that the target PLC is a CS/CJ-series PLC and the Programming Device is the CX-Programmer.



# PRECAUTIONS

This section provides general precautions for using the Programmable Controller (PLC) and related devices.

**The information contained in this section is important for the safe and reliable application of the Programmable Controller. You must read this section and understand the information contained before attempting to set up or operate a PLC system.**

1 Intended Audience .....	xxiii
2 General Precautions .....	xxiii
3 Safety Precautions .....	xxiii
4 Application Precautions .....	xxiv



## 1 Intended Audience

This manual is intended for the following personnel, who must also have knowledge of electrical systems (an electrical engineer or the equivalent).

- Personnel in charge of installing FA systems.
- Personnel in charge of designing FA systems.
- Personnel in charge of managing FA systems and facilities.

## 2 General Precautions

The user must operate the product according to the performance specifications described in the operation manuals.

Before using the product under conditions which are not described in the manual or applying the product to nuclear control systems, railroad systems, aviation systems, vehicles, combustion systems, medical equipment, amusement machines, safety equipment, and other systems, machines, and equipment that may have a serious influence on lives and property if used improperly, consult your OMRON representative.

Make sure that the ratings and performance characteristics of the product are sufficient for the systems, machines, and equipment, and be sure to provide the systems, machines, and equipment with double safety mechanisms.

This manual provides information for programming and operating the Unit. Be sure to read this manual before attempting to use the Unit and keep this manual close at hand for reference during operation.

 **WARNING** It is extremely important that a PLC and all PLC Units be used for the specified purpose and under the specified conditions, especially in applications that can directly or indirectly affect human life. You must consult with your OMRON representative before applying a PLC System to the above-mentioned applications.

## 3 Safety Precautions

 **WARNING** The CX-Simulator simulates PLC operation. However, there are some differences in operation and timings between those of the CX-Simulator and the actual PLC system. Be sure to confirm operation on the actual system as well as debugging the programs on the CX-Simulator before running the actual system. Unexpected operation may cause an accident.

 **Caution** Enabling serial communications function of the CX-Simulator may affect the operation of devices connected to the computer. When external devices are not being used, do not enable the serial communications function. Unexpected operation of the external devices may cause an accident.

 **Caution** When the CX-Simulator is used together with the Data Link function, the Memory Mapping function of the FinsGateway, or the Cyclic Server of the FinsServer Series, the operation of external devices connected to the personal computer may be affected. Do not activate these functions if they do not need to be used simultaneously. Unexpected operation of the external devices may cause an accident.

## 4 Application Precautions

Observe the following precautions when using the CX-Simulator.

- Confirm the destination is the CX-Simulator when the CX-Simulator is connected online with the CX-Programmer or other applications. When the CX-Simulator is disabled or not connected to the Simulator, the actual system may be activated.
- Confirm the destination is the PLC when another application connects online with the actual system while the CX-Simulator is activated. Connection may be made not with the actual system but with the CX-Simulator.





# SECTION 1

## Introduction

1-1 What Is the CX-Simulator? .....	2
1-1-1 Summary .....	2
1-1-2 Software Configuration of CX-Simulator .....	3
1-1-3 Basic Block Diagram.....	5
1-1-4 Summary of CX-Simulator Functions (Comparisons with Actual PLC) .....	6
1-2 Features.....	9
1-2-1 Features .....	9
1-3 Convenient Functions .....	13
1-4 Applicable PLC models and Computers.....	14
1-4-1 Applicable PLC models.....	14
1-4-2 Computer .....	15
1-5 Operation List Arranged by Purpose .....	16
1-5-1 Setting Operation Environment.....	16
1-5-2 Program Execution .....	16
1-5-3 Program Debugging .....	16
1-5-4 Monitor the Status .....	17
1-5-5 Set Serial Communications Settings.....	17
1-5-6 Set Network Communications Parameters .....	17
1-5-7 Execute Virtual External Input.....	17
1-6 Comparison of CX-Simulator and SYSMAC CS/CJ-series PLCs .....	18

## 1-1 What Is the CX-Simulator?

### 1-1-1 Summary

The CX-Simulator emulates the operation of the CS/CJ/CP-series CPU Unit (see note 1) or the Controller Section of the NSJ Controller (see note 2) to the computer, providing an equivalent development environment to that of an actual PLC system only with software. Furthermore, various debugging functions and tools that are not available in the actual PLC allow more effective development and debugging.

- Note**
1. In this manual, always assume that "CS/CJ-series PLC" also implies CP-series PLCs unless otherwise specified. When performing simulations for a CP-series PLC, use the instructions for the CS/CJ-series PLC. Functions not supported by CP-series PLCs, however, cannot be simulated.
  2. In this manual, always assume that "CJ-series PLC" also implies the Controller Section of an NSJ-series NSJ Controller unless otherwise specified. When performing simulations for the Controller Section of the NSJ Controller, use the instructions for the CJ-series PLC.
  3. Emulation for units other than network communications units and Serial Communications Boards/Units is not available. They are registered only for calculating the I/O refresh time and peripheral servicing time. CX-Simulator is used internally to simulate execution of ladder programs or function blocks (ladder programs or ST) on CX-Programmer Ver. 6.1 or higher.
  4. The CX-Simulator does not support all of the instructions of the CPU Units. Refer to *1-6 Comparison of the CX-Simulator and SYSMAC CS/CJ-series PLCs* for details.

The CX-Simulator will run on a computer that has any of the operating systems supported by the CX-One.

The CX-Simulator can execute the following operation by downloading programs from the CX-Programmer on the same computer to the virtual CPU Unit and by driving the virtual CPU Unit without connecting with the actual CS/CJ-series PLC.

- 1,2,3...**
1. Debug programs with virtual external inputs to the virtual CPU Unit using the Virtual External Input Tool or the Debugging Program.
  2. Use various debugging functions such as address execution and break point setting that are not available in CS/CJ-series PLCs.
  3. Simulate the cycle time, enabling to simulate the CPU Unit without an actual PLC.
  4. Debug functions of network/serial communications.

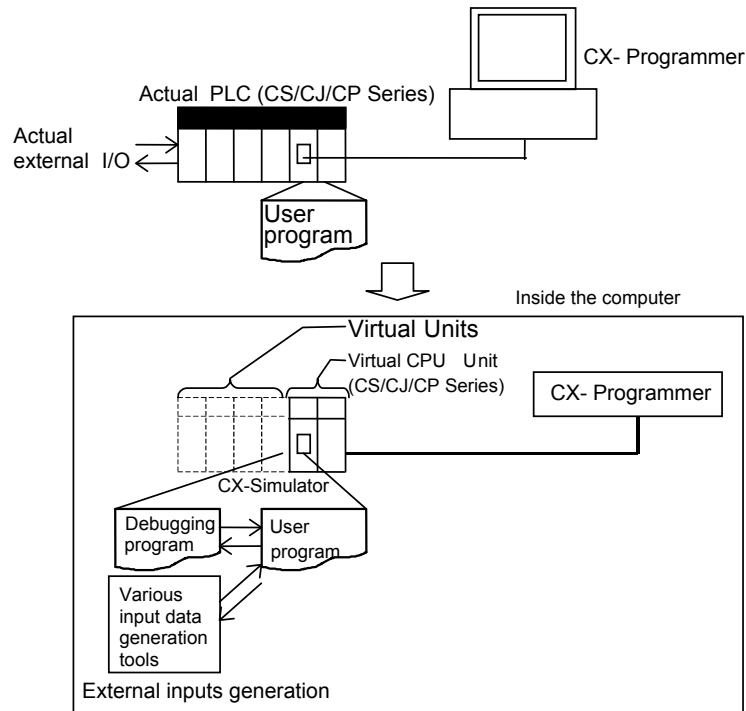

### 1-1-2 Software Configuration of CX-Simulator

The CX-Simulator consists of the Ladder Engine, which is composed of the virtual CPU Unit and other units (default: only the Simulator Communications Unit), the FinsGateway (version 2 or higher) Virtual Communications Unit, the Debugger, and the Virtual External Input Tool.

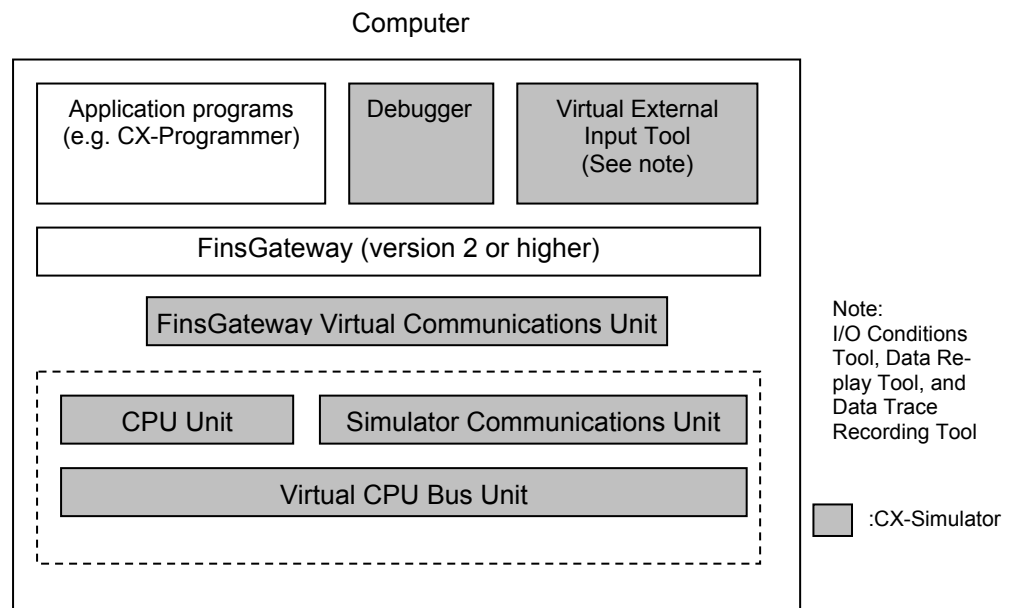

Item	Contents	
Ladder Engine	A platform for CS/CJ/CP-series PLC Emulation Consists of multiple units. Default: Consists of the CPU Unit and the Simulator Communications Unit.	
	CPU Unit	A virtual unit corresponding to the actual CPU Unit, including application programs (UM1), debugging programs (UM2), and I/O memory areas.
	Simulator Communications Unit	The CX-Simulator's own virtual and general-purpose communications unit, corresponding to PLC's network communications unit. Possible to communicate with the CX-Programmer.
FinsGateway (version 2 or higher) Virtual Communications Unit (See note.)	Connect Simulator Communications Unit in the Ladder Engine with FinsGateway version 2 or higher. Two types are available: Virtual Controller Link Unit and Virtual Ethernet Unit. The CX-Programmer also performs FINS communications with the Ladder Engine via the Virtual Communications Unit.	
Debugger	Controls the Ladder Engine and executes various CX-Simulator's own debugging functions.	
For virtual external I/O functions	Debugging program (UM2)	Possible to simulate I/O operation with a program in the program area for debugging other than the area for applications (UM1).
	Command log	The log for CX-Programmer's operations (e.g. I/O memory change, Force set/reset) is saved in a file (Command log file). Possible to replay operation for the Ladder Engine using the Data Replay Tool.

**Note** The FinsGateway Virtual Communications Unit is different from the FinsGateway itself. CX-Simulator does not include the FinsGateway itself.



Item	Contents		
For virtual external I/O functions	Virtual External Input Tool	Data Replay Tool	Read data in sequence from Command log file, Data Trace file, and Data Replay file, and issue FINS commands to the Ladder Engine to regenerate input data.
		I/O Conditions Tool	Change contents of designated I/O memory areas when the contents satisfy certain conditions.
		Data Trace Recording Tool	Possible to input trace data (Data trace file) actually obtained from PLC to the Ladder Engine using the Data Replay Tool. Possible to generate long-term data.
		Multipoint Data Collection Tool	Possible to acquire trace data of more than 50 words from an actual PLC and to input to the Ladder Engine using the Data Replay Tool.
For network communications	FinsGateway Virtual comm. Unit/Simulator Communications Unit	FINS commands send/receive to/from application programs on the Computers and the CPU Unit of FinsGateway are possible. Screen display of send messages is also possible. FINS commands send is not possible (receive is possible).	

### 1-1-3 Basic Block Diagram

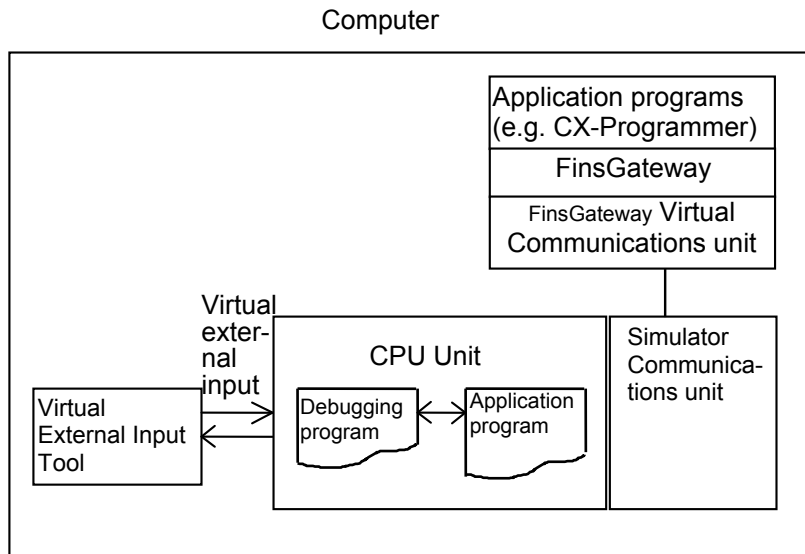

**1-1-4 Summary of CX-Simulator Functions (Comparisons with Actual PLC)**

Item		Actual PLC	CX-Simulator	
Hardware		CPU Unit (CS/CJ/CP-series)	Virtual CPU Unit (CS/CJ-series)	
System configuration		Basic I/O unit	Virtual Basic I/O Unit	No operations (*1). Registered for calculating I/O refresh time and peripheral servicing time.
		Special I/O unit	Virtual Special I/O Unit	
		CPU Bus Unit	Virtual CPU Bus Unit	*1: Excluding Controller Link Unit, Ethernet Unit, and Serial Communications Unit.
		Inner Board	Virtual Inner Board	
		Power Supply Unit	None	*1: Excluding Serial Communications Board
Peripheral device		CX-Programmer	CX-Programmer on the same computer (communicate via FinsGateway Virtual Communications Unit)	
		Programming Console	unusable	
CPU Unit basic functions	Program	Single user program	Application program (UM1)	Share I/O memory areas.
		None	Debugging program (UM2): For external I/O data generation	
	Task function	Available	Available (equivalent)	

Item	Actual PLC	CX-Simulator	
CPU Unit basic functions	Operating mode	Program mode	Stop
		Monitor mode and Run mode	Continuous execution of scan
		Minimum Cycle Time	Logical cycle time: Substitute cycle time for set value. Actual cycle time: Regulate actual execution time of one cycle on the computer.
		None	Scan Run (only one scan)
			Continuous Scan Run (one scan at regular intervals)
			Step Run (only one step)
			Continuous Step Run (repeat address execution at regular intervals)
			Block Run (Start point, break point, and I/O break conditions can be set.)
	Scan Replay (Return to the start point of the scan when pausing.)		
	Operation when power turns ON	Reset	
	I/O memory areas	Available	Available
	I/O area allocation	Required	PLC unit registration instead (No slot setting)
	I/O refresh	Available	None (Only for cycle time calculation. Controller Link Unit, Ethernet Unit, and Serial Communications Board/Unit performs virtual operation.)
Peripheral servicing	Available	None (Only for cycle time calculation. Controller Link Unit, Ethernet Unit, and Serial Communications Board/Unit performs virtual operation.)	
External input	Available	Generate virtual external input by one of the followings. <ul style="list-style-type: none"> <li>• Overwrite I/O memory areas using the debugging program.</li> <li>• Issue FINS commands using the command log and the Data Replay Tool.</li> <li>• Issue FINS commands using the data trace file and the Data Replay Tool.</li> <li>• Issue FINS commands using the data replay file and the Data Replay Tool.</li> <li>• Overwrite I/O memory areas using the I/O Conditions Tool.</li> </ul>	
Cycle time		Virtual cycle time: Estimated cycle time if operated on the actual CS/CJ/CP-series CPU (Application program) Computer cycle time: Actual cycle time on the computer (Application program + debugging program)	
PLC setup	Available	Available (except for the settings on the I/O Block Tab Page of the CJ2M CPU Units, and the Built-in Input Tab Page and the Pulse Output Tab Page of the CJ1M CPU Units and CP-series CPU Units)	

Item	Actual PLC	CX-Simulator
DIP switch setting	Available	Available (By software, some functions only)

Item	Actual PLC	CX-Simulator	
Operation of each unit	Network communications unit	Available (Ethernet Unit, Controller Link Unit)	Available (Simulator Communications Unit, Ethernet Unit, and Controller Link Unit)
	Serial Communications Board/Unit	Available	Available (Using SYSMAC WAY Host Link System, NT Link, or No-protocol)
	Other units	Available	None
Various functions	Force-set/reset	Available	Available
	Differential monitor	Available	Available
	Data trace	Available	Available
	Change set value of timer/counter	Available	Available (However, the set values of operands of binary-type timer and counter instructions for CJ2 Series cannot be changed. Use the online edit function to change them.)
	Online edit	Available	Available
	Serial communications	Available	Available (Only message display)
	Network communications	Available	Available (Using FinsGateway Virtual Communications Unit, where send/receive to/from the nodes in the computer.)

## 1-2 Features

Using the CX-Simulator with the following features can reduce man-days for program debugging.

### 1-2-1 Features

#### **Possible to simulate operation of the Virtual CPU Unit on the computer.**

The CX-Simulator simulates operation of the SYSMAC CS/CJ/CP-series CPU Unit. The operation of programs can be easily checked without an actual PLC being connected. Using the CX-Simulator combined with the CX-Programmer allows to develop/debug programs on a single computer.

#### **Easily use the CX-Programmer on the same computer**

Programs for the Virtual CPU Unit on the CX-Simulator can be seamlessly debugged with the CX-Programmer that has been used. The powerful monitoring functions (including those for a ladder diagram window and present values) can be used as they used to be.

Furthermore, when CX-Programmer version 3.0 or higher is used with CX-Simulator version 1.3, the CX-Simulator can be started and placed online from the CX-Programmer.

#### **Calculate the virtual cycle time**

An estimated cycle time for operation on the actual PLC can be obtained as a virtual cycle time, which is different from an elapsed time on the computer. Use it as a tentative time for operation on the actual PLC.

#### **Dedicated debugging function**

Adding dedicated debugging functions to the CX-Simulator enables more detailed debugging than that of CX-Programmer + actual CS/CJ/CP-series PLC.

#### **Step Run**

A program can be executed in the unit of instruction. Peripheral servicing during a stoppage by the address execution enables monitoring of program being executed.

#### **Start point, break point, and I/O break conditions**

A program can be executed from any mnemonic code by designating a start point. Setting multiple break points and break conditions depending on the I/O memory status enables to pause a program at any point and on any conditions.

#### **Scan Replay**

Scan Replay returns the program conditions to those just prior to the scan started. The program can be replayed on the same conditions any times.

#### **Check the number and the time of executions of each task**

Displaying the number and the time of executions of each task will help solve the bottleneck in executions, reducing the cycle time by re-division of the tasks.

#### **Simulated startup of interrupt tasks**

Simulated startup of interrupt tasks at any timing enables to debug interrupt processes.

#### **Serial communications**

In the CX-Simulator, debugging serial communications is possible by: (1) actual communications to an external serial communications device using a

COM port on the computer, (2) screen display of send messages, or (3) input/output from/to a file.

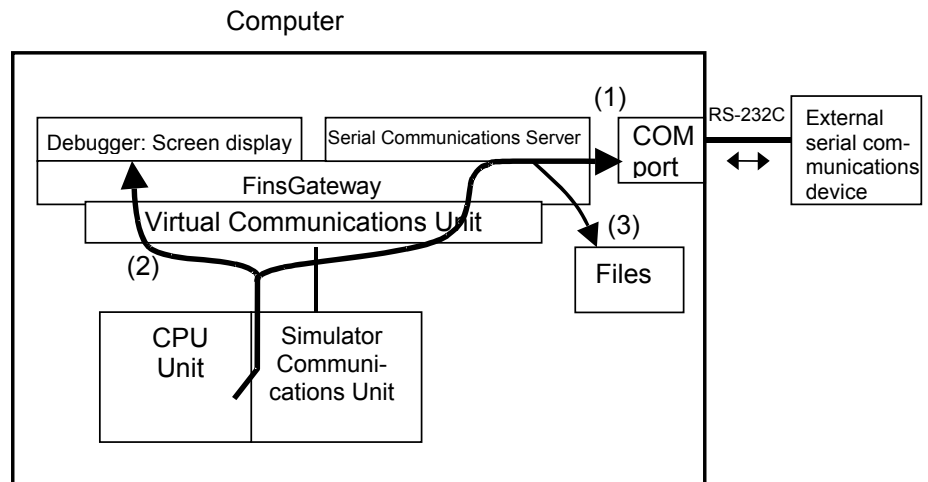

**Display send messages**

Display the contents of send messages sent by serial communications instructions (No external output is performed.).

**Disabling serial communications instructions possible**

Disabling serial communications instructions is possible by settings. This feature will be used when debugging a program section that is not related to serial communications.

**Debugging network communications possible**

The CX-Simulator can debug network communications by send/receive of FINS commands to application programs in the computer or the CPU Unit in the FinsGateway, or display of send messages (selected by Communications Settings). Also, the CX-Simulator can receive FINS commands from the external actual PLC or the computer to the Ladder Engine. (Can not send to external devices.)

**Send/receive FINS commands to nodes in the computer**

The CX-Simulator can send/receive FINS commands to nodes (the CPU Unit itself, application programs using FinsGateway, or the CPU Unit for FinsGateway) in the computer using network communications instructions in the CPU Unit. This capability enables debugging of network communications with the CPU Unit itself or the CPU Unit for FinsGateway as the tentative communications target.

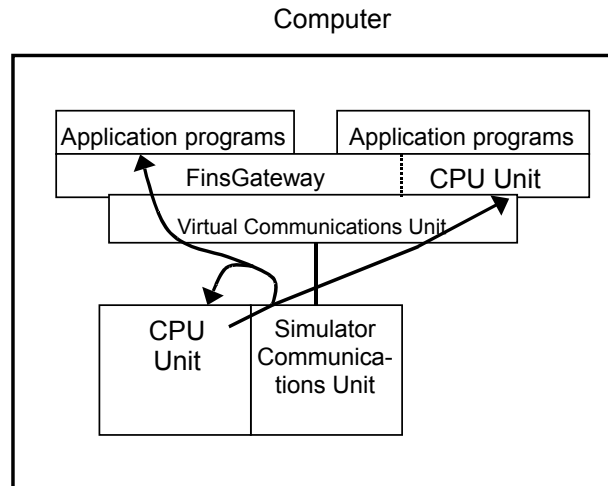

**Receive external FINS commands possible**

The CX-Simulator can receive external FINS commands from external networked computers or actual PLCs.

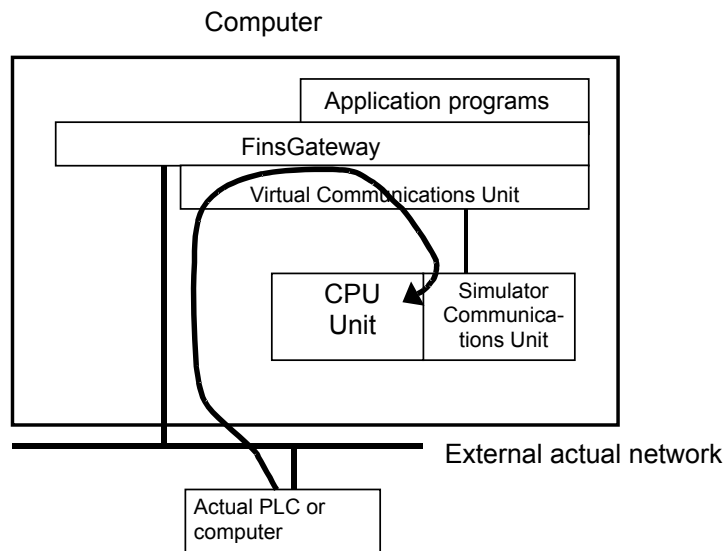

**Display FINS send messages**

Display FINS messages sent with network communications instructions on the message display window. (No actual send is executed.)

**Implement virtual external inputs using various methods.**

The CX-Simulator can generate/replay virtual external inputs using various methods to verify program operation.

- |   |  |
|---|--|
| <b>Replay input operation using the command log</b> | Save the history of manual input operation (e.g. I/O set/reset by the CX-Programmer and change of DM PVs) and settings by application programs, as a command log file. The saved data can be used instead of the input to the Ladder Engine by replaying using the data replay function as required.         |
| <b>Replay inputs using traced data</b>              | Replay the data of data trace obtained from the actual PLC by the CX-Programmer or the data monitored via a time chart, as inputs to the Ladder Engine using the data replay function.   |
| <b>Replay inputs using the data reply file</b>      | Replay data of the data reply file (a CSV-format text file) as inputs to ladder engine. The data replay file can be created using commercially available spreadsheet software (e.g. MS-Excel).   |
| <b>Simulate I/O using a debugging program</b>       | Hold a program to generate debugging data (debugging program) besides programs for actual applications (application programs). Input data can be produced using the debugging program. This capability enables to simulate I/O. (Application programs and the debugging program share the I/O memory areas.) |
| <b>Generate inputs using I/O Condition</b>          | When the contents of designated I/O memory area (bits or words) satisfy the contents of condition expression; the values are set to the designated I/O memory area after the designated delay time. Multiple expressions can be set.   |



## 1-3 Convenient Functions

The CX-Simulator provides the following convenient functions.

### Monitor IR/DR

By Step Run, the contents of IR/DR for each task during ladder diagram execution can be monitored with the CX-Programmer SV monitoring, which has been difficult to debug.

After setting break points to the mnemonic codes in the Step Run window, executing the ladder diagram allows to monitor the value before the mnemonic code is executed.

### Block Run

Any range of a program can be executed by designating the execution start point (the start pointer) and execution interrupt point (the break pointer).

### Support debugging of application programs on the computer

When developing a monitoring program or a data collection program on the computer, debugging communications functions was done with the actual PLC connected. If the CX-Simulator is used together, on the other hand, a single computer will do all of the debugging. (Valid only for application programs using FinsGateway.)

### Coordinated functions with commercial software

Coordinated functions with commercial spreadsheet programs and text editors allow using familiar software for data collection/display.

- Obtain mnemonic codes in a task.  
Refer to *3-9-7 Step Run Window*.
- Obtain task information.  
Refer to *3-9-8 Task Control Window*.
- Create virtual external input data.  
Refer to *8-3 Generating Virtual External Inputs*.
- Monitor the result by virtual external inputs.  
Refer to *8-5 Checking the Result*.
- Designate a program for alarm display. (Only for Windows 95/98/Me)  
Refer to *Console Display Settings* in *3-9-4 File Menu*.

## 1-4 Applicable PLC models and Computers

### 1-4-1 Applicable PLC models

The CX-Simulator supports the following PLC (Programmable Controller) models.

Series	CPU Unit Model
CS	CS1H-CPU67/66/65/64/63 CS1G-CPU45/44/43/42 CS1H-CPU67H/66H/65H/64H/63H CS1G-CPU45H/44H/43H/42H CS1D-CPU67H/65H/68HA/67HA CS1D-CPU67S/65S/44S/42S/67SA/44SA
CJ	CJ2H-CPU68/67/66/65/64 (See note 3.) CJ2H-CPU68-EIP/67-EIP/66-EIP/65-EIP/64-EIP (See note 3.) CJ2M-CPU11/12/13/14/15/31/32/33/34/35 CJ1H-CPU67H-R/66H-R/65H-R/64H-R CJ1M-CPU23/22/13/12/11 CJ1H-CPU66H/65H/67H CJ1G-CPU45H/44H/43H/42H CJ1G-CPU45/44
CP (See note 1.)	CP1H-XA□□□□-□ CP1H-X□□□□-□ CP1H-Y□□□□-□ CP1L-M□□□□-□ CP1L-L□□□□-□ CP1L-EM□□□□-□ (See note 4.) CP1L-EL□□□□-□ (See note 4.) CP1E-E□□□□-□ (See note 4.) CP1E-N□□□□-□ (See note 4.) CP1E-NA□□□□-□ (See note 4.) CP2E-E□□DR-A (See note 4.) CP2E-S□□D□-□ (See note 4.) CP2E-N□□D□-□ (See note 4.)
NSJ (Controller Section) (See note 2.)	G5D (Used for the NSJ5-TQ0□-G5D, NSJ5-SQ0□-G5D, NSJ8-TV0□-G5D, NSJ10-TV0□-G5D, and NSJ12-TS0□-G5D) M3D (Used for the NSJ5-TQ0□-M3D, NSJ5-SQ0□-M3D, and NSJ8-TV0□-M3D)

- Note**
1. In this manual, always assume that "CS/CJ-series PLC" also implies CP-series PLCs unless otherwise specified. When performing simulations for a CP-series PLC, use the instructions for the CS/CJ-series PLC. Unit version 1.0 or 1.1 of the CP-series CPU Units is equivalent to unit version 3.0 of the CS/CJ-series CPU Units. Functions added for unit version 4.0 or later of the CS/CJ-series CPU Units are not supported by the CP-series CPU Units. Functions not supported by CP-series PLCs, however, cannot be simulated.
  2. In this manual, always assume that "CJ-series PLC" also implies the Controller Section of an NSJ-series NSJ Controller unless otherwise specified. When performing simulations for the Controller Section of the NSJ Controller, use the instructions for the CJ-series PLC.
  3. The functions supported for CJ2-series CPU Units correspond to those for CS/CJ-series Units with unit version 4.0 or later.
  4. To connect the CX-Programmer to a CP1L-EM/EL, CP1E or CP2E CPU Unit, select [Simulation] | [Simulator Online Connection] from the main menus of the CX-Programmer.

## 1-4-2 Computer

The CX-Simulator is packaged with the CX-One. The system requirements are therefore the same as for the CX-One.

Refer to the *CX-One Setup Manual* (W463, provided with the CX-One) for the installation procedure for the CX-One.

Cat. No.	Model	Manual name	Contents
W463	CXONE-AL□□D-V4	CX-One Setup Manual	An overview of the CX-One FA Integrated Tool Package and the CX-One installation procedure

The required RAM memory capacity depends on the size of program created with the CX-Programmer. CX-Simulator will be slow if run on a computer with less than the required RAM memory capacity.

## 1-5 Operation List Arranged by Purpose

The following lists show the operation for each purpose.

### 1-5-1 Setting Operation Environment

Purpose	Menu or Button to select
Connect the CX-Simulator	Debug Console   File Menu   Work CX-Simulator   Connect Simulator
Disconnect the CX-Simulator	Debug Console   File Menu   Work CX-Simulator   Disconnect Simulator
Create a new PLC	Select System Status   Setting   Select PLC   Create a new PLC
Open existing PLC	Select System Status   Setting   Select PLC   Open existing PLC
Add a PLC unit	System Status   Setting   PLC unit Setting
Change UM	System Status   Setting   UM Setting
Initialize PLC memory	System Status   Initialize PLC

### 1-5-2 Program Execution

Objective	Menu or Button to select
Execute continuously	Debug Console   Continuous Run button
Execute a single scan	Debug Console   Scan Run button
Scan continuously	Debug Console   Continuous Scan Run button
Execute a single step	Debug Console   Step Run button
Execute steps continuously	Debug Console   Continuous Step Run button
Pause the program execution	Debug Console   Pause button
Stop the program	Debug Console   Stop button
Repeat scan from the beginning	Debug Console   Scan Replay button
Reset	Debug Console   Reset button

### 1-5-3 Program Debugging

Objective	Menu or Button to select
Set for Step Run	Debug Console   Show Step run
Set break points	In the above operation, right-click the program address to set a breakpoint to and set Select BreakPoint when the pop-up menu is displayed.
Clear the break point	In the above operation, right-click the program address to clear a breakpoint for and select Clear BreakPoint when the pop-up menu is displayed.
Clear all break points	In the above operation, right-click the Step Run window and select Clear All BreakPoints when the pop-up menu is displayed.
Designate a start point	In the above operation, right-click the program address to set a start point to and set Select Start Point when the pop-up menu is displayed.
Clear a start point	In the above operation, right-click the program address to clear a start point for and select Clear Start Point when the pop-up menu is displayed.
Stop the program when the content of I/O memory area meets certain conditions	Debug Console   I/O Break conditions Setting

### 1-5-4 Monitor the Status

Objective	Menu or Button to select
Display messages	System Status   Message Display
Display alarms	System Status   Alarm Display
Display cycle time details	System Status   Detail
Display each status of the task	Debug Console   Task Control

### 1-5-5 Set Serial Communications Settings

Objective	Menu or Button to select
Set Serial Communications settings	System Status   Set   Double-click the port used for Serial Communications.
Disable Serial Communications commands	In the above operation, set [- (Non)] to the Communications Settings. (default)
Display the content of output by the Serial Communications commands	In the above operation, set [Message] to the Communications Settings.
Use an actual RS-232C port on the computer for Serial Communications	In the above operation, set [Actual Communications] to the Communications Settings.

### 1-5-6 Set Network Communications Parameters

Objective	Menu or Button to select
Set network communications parameters	System Status   Set   Double-click the unit used for network communications
Change the node number of the network communications unit	In the above operation, change the value of FINS node address.
Disable network communications commands	In the above operation, set [- (Non)] to the Communications Settings. (default)
Display the content of output by network communications commands	In the above operation, set [Message] to the Communications Settings.
Issue a network communications command to the designated node in the computer	In the above operation, set [Local] to the Communications Settings.

### 1-5-7 Execute Virtual External Input

Objective	Menu or Button to select
Set a program area for debugging	System Status   Set   UM Setting
Invoke data for data replay from a file	Debug Console   Replay Menu   Data Replay
Set a command log	Debug Console   Replay Menu   Command Log   set
Start a command log	Debug Console   Replay Menu   Command Log   Start
Exit a command log	Debug Console   Replay Menu   Command Log   Stop
Display command log data	Debug Console   Replay Menu   Command Log   View Log
Set I/O Condition	Debug Console   Replay Menu   I/O Condition   File Menu   Set
Execute I/O Condition	Debug Console   Replay Menu   I/O Condition   Start

## 1-6 Comparison of CX-Simulator and SYSMAC CS/CJ-series PLCs

In the CX-Simulator, the part implementing PLC functions (CS/CJ CPU Unit and Communications Unit) is called the Ladder Engine. The following list compares SYSMAC CS/CJ-series PLC with and the Ladder Engine of the CX-Simulator. Take notice of the followings when using the CX-Simulator.

Item		CS/CJ-series PLC	CX-Simulator
Program structure	CS/CJ-series PLC: Multiple tasks (programs) vs. CX-Simulator: Multiple program areas/multiple tasks	In CS/CJ-series PLCs, the program is divided into tasks (cyclic tasks) that are executed in order when they are enabled. CS/CJ-series PLCs support up to 32 cyclic tasks (128 cyclic tasks for CJ2-series PLCs), 32 I/O interrupt tasks, 2 scheduled interrupt tasks, 1 power OFF interrupt task, and 256 external interrupt tasks.	In the CX-Simulator, the program is divided into two areas: the program area for applications (UM1) and for debugging (UM2). One program area corresponds to a CS/CJ's UM and accesses the same I/O memory area. Usually only UM1 is used. However, task numbers, subroutine numbers, and block program numbers can not overlap between program areas. The following functions that are supported by CS/CJ-series Ver.2.0 and CP-series CPU Units cannot be used. <ul style="list-style-type: none"> <li>• Task Transfer to PLC</li> <li>• Task Read Protection (Functions as UM read protection.)</li> </ul> The following functions that are supported by CJ2-series CPU Units cannot be used. <ul style="list-style-type: none"> <li>• "Clear automatic allocation area and forced status" of Transfer to PLC</li> </ul>
I/O allocation	"Create I/O table" CS-series PLC: Required vs. CX-Simulator: Own settings required	In CS/CJ-series PLCs, word allocation does not depend only on slot position, and it is not necessary to allocate words to an empty slot. If a Unit requires several words, those words can be allocated. When a CS-series PLC is being used, the I/O Table Registration operation must be executed. If it is not executed, the CPU Unit will not recognize each Basic I/O Unit, Special I/O Unit, and CPU Bus Unit that has been installed.	The I/O table is not used. In the PLC Setup wizard or PLC Unit Setting, the unit for own use is selected. Although the machine number and the unit number are set, the slot is not set. The I/O refresh time is calculated based on the selected units.
Online editing	CS/CJ-series PLC: RUN /MONITOR mode vs. CX-Simulator: Continuous run (Run/Monitor mode), Pause (Scan Run, Step Run, Break point, and I/O break condition)	In CS/CJ-series PLCs, peripheral servicing is performed for the cycle time of one cycle to multiple cycles (where the cycle time is extended up to 90 ms per one cycle).	In the CX-Simulator, the process is completed within one cycle. There is no limit for the maximum extension time per one cycle. When in Continuous Run, the peripheral servicing performs the process. When the ladder program is in pausing, the peripheral servicing is always working, enabling online editing. However, if online editing is performed during the program execution, The setting of [System Status Setting]   [Settings]   [PLC Operation Setting]   [Run the program from the top when online editing during Step Run] will cause the following operation. Not checked: Enter the Program mode. Checked: Scan Replay

Item		CS/CJ-series PLC	CX-Simulator	
Data Areas	CIO Area	I/O Area	CIO 0000 to CIO 0319	Not allocated actually even if the unit is set.
		Special I/O Unit Area	CIO 2000 to CIO 2959	Only Serial Communications Units and Network Communications Units are allocated.
		DeviceNet Area and SYSMAC BUS Area	DeviceNet Area: CIO 0050 to CIO 0099, CIO 0350 to CIO 0399	Not allocated actually even if the unit is set.
			SYSMAC BUS Area: CIO 3000 to CIO 3049	
			PLC Link Words	
		Optical I/O Unit and I/O Terminal Area	I/O Terminal Area: CIO 3100 to CIO 3131	
		Link Relay Area (LR)	Link Area: CIO 1000 to CIO 1199	Not used.
		Work/Internal I/O area	Internal I/O Area: CIO 1200 to CIO 1499 CIO 3800 to CIO 6143	Same as shown at left.
Data Areas	Work Area (WR)	Work Area: W000 to W511	Same as shown at left.	
	Temporary Relay Area	TR 00 to TR 15	Same as shown at left.	
	Holding Relay Area(HR)	H 000 to H 511	Same as shown at left.	
	Auxiliary Relay Area (AR)	Auxiliary Area: A 000 to A 959 For CJ2-series PLCs: A 000 to A 1471 and A 10000 to A 11535	Same as shown at left. (Refer to 9-3 I/O Memory Allocation for details.)	
	DM Area	DM Area D00000 to D32767 D20000 to D29599 are used by Special I/O Units, D30000 to D31599 are used by CPU Bus Units, and D32000 to D32099 are used by Inner Boards. The Error Log is stored in A100 to A199 and the PLC Setup is stored in the Parameter Area (not a part of I/O Memory).	Same as shown at left.	
	EM Area	CS/CJ-series CPU Units: EM Area E00000 to E32767 (25 banks max.) CJ2H CPU Units: EM Area E00000 to E32767 (25 banks max.) CJ2M CPU Units: EM Area E00000 to E32767 (4 banks max.) The EM Area in the CS/CJ-series CPU Unit can be accessed directly by most instructions. (There is no EM Area in the CP-series CPU Unit.) Regular instructions can access data in the current bank or any other bank. Part of the EM Area can be converted for use as a file memory.	Same as shown at left.	
	Timer Area	T0000 to T4095	Same as shown at left.	
Counter Area	C0000 to C4095 (Timer and counter numbers are independent.)	Same as shown at left.		

Item	CS/CJ-series PLC	CX-Simulator	
	Task Flag Area	CS/CJ-series CPU Units: TK0 to TK31 CJ2-series CPU Units: TK0 to TK127	Same as shown at left.
Data Areas	Index Registers	IR0 to IR15	Same as shown at left.
	Data Registers	DR0 to DR15	Same as shown at left.
	Arithmetic Flags (such as RE and EQ)	Condition Flags: In the CS/CJ-series CPU Unit these Flags are in a separate area and are specified by labels rather than addresses. With the CX-Programmer, these are specified using global symbols, such as "P_Instr_Error " and "P_Equals." With a Programming Console, they are specified using "ER," "=", etc.	Same as shown at left. (The Programming Console can not be used.)
	Clock Pulses	Clock Pulses: In the CS/CJ-series CPU Unit these pulses are in a separate area and are specified by labels such as "1s" and "0.1s" rather than addresses.	Same as shown at left.
PLC setup	Special Area	In the CS/CJ/CP-series CPU Unit, the PLC Setup is not stored in the DM Area, but a separate area (the Parameter Area) which is not a part of I/O memory. The PLC Setup is edited with CX-Programmer in a table format and user-friendly dialogue. Individual PLC Setup addresses can also be edited with a Programming Console.	Same as shown at left. (The Programming Console can not be used.) Refer to 9-3 I/O Memory Allocation.
	Built-in Input/Output Settings	Available	The settings on the I/O Block Tab Page of the CJ2M CPU Unit, and the Built-in Input Tab Page and the Pulse Output Tab Page of the CJ1M CPU Units and CP-series CPU Units are invalid.
Instruction variations	Up-differentiation	Available	Same as shown at left.
Instruction variations	Down-differentiation	Available for LD, AND, OR, RSET, and SET	Same as shown at left.
	Immediate refreshing	Available for LD, LD NOT, AND, AND NOT, OR, OR NOT, OUT, OUT NOT, RSET, SET, KEEP, DIFU, DIFD, CMP, CPS, and MOV	Same as shown at left. (Immediate refreshing is not performed.)
	Up-differentiation and immediate refreshing	Available for LD, AND, OR, RSET, SET, and MOV	Same as shown at left. (Immediate refreshing is not performed.)
	Down-differentiation and immediate refreshing	Available for LD, AND, OR, RSET, and SET	Same as shown at left. (Immediate refreshing is not performed.)
Instruction operand data format	Basically operands are specified in binary. In XFER(070), for example, the number of words is specified in binary (0001 to FFFF or 1 to 65,535 decimal). Specifying data in binary increases the setting range about six-fold.	Same as shown at left.	



Item	CS/CJ-series PLC	CX-Simulator
Specifying operands requiring multiple words	If an operand requiring multiple words is specified at the end of an area so that there are not enough words left in the area for the operand, the instruction can be executed and the Error Flag will not turn ON. The program, however, is checked when transferred from the CX-Programmer to the CPU Unit and cannot be transferred with incorrect operand specifications. Such programs also cannot be read from the CPU Unit.	Same as shown at left.

	Item	CS/CJ-series PLC	CX-Simulator
Instructions	Sequence Input	Equivalent	
	Sequence Output	Equivalent	
	Sequence Control	Equivalent	Equivalent (The MILH and MILR instructions, however, cannot be used to control the ON/OFF status of interlocks by forcing ON/OFF the bit specified for the second operand. The interlocks must be controlled through the execution condition of the instruction. In addition, when an up-differentiation instruction (to be executed only in a single cycle at rising edge. e.g. @MOV) is used in an interlock circuit (i.e. between an IL instruction and an ILC instruction), the up-differentiation instruction is executed regardless of the interlock status.)
	Timer/Counter	Equivalent (TRSET is equivalent only for CJ2-series PLCs.)	
	Comparison	Equivalent	
	Data Movement	Equivalent	
	Data Shift	Equivalent	
	Increment/Decrement	Equivalent	
	Symbol Math	Equivalent	
	Conversion	Equivalent (GRAY_BIN, GRAY_BINL, BIN_GRAY, BIN_GRAYL are equivalent only for CJ2-series PLCs.)	
	Logic	Equivalent	
	Special Math	Equivalent	
	Floating-point Math	Equivalent (A rounding error may occur.)	
	Table Data Processing	Equivalent	
	Tracking	Nothing is executed for the CX-Simulator.	
	Data Control	Equivalent (Nothing is executed for PID.)	
	Subroutines	Equivalent	
	Interrupt Control	Equivalent	
	Step	Equivalent	
	Basic I/O Unit	IORF, IORD, IOWR, TKY, HKY, 7SEG, and DSW available.	Nothing is executed for the IORF, IORD, or IOWR instructions.

Item		CS/CJ-series PLC	CX-Simulator
Instructions	Serial Communications	PMCR, and PMCR2 available. TXD, RXD, and STUP available.	Nothing is executed for PMCR or PMCR2. TXD, RXD, and STUP operate differently depending on communications parameters. TXDU2, and RXDU2 operate only for CJ2-series PLCs.
	Network	SEND, RECV, and CMND available. CSND available.	SEND, RECV, and CMND operate differently depending on communications parameters. Nothing is executed for CSND. SEND2, RECV2, and CMND2 operate only for CJ2-series PLCs.
	File Memory	Equivalent	
	Display	Equivalent (Messages of Programming Console are displayed on the screen.)	
	High-Speed Counter / Pulse Output Instructions	Nothing is executed on the CX-Simulator.	
	Clock	Equivalent (With the CX-Simulator, however, even if the time in the PLC is adjusted with the DATE instruction, it will be automatically corrected to the time in the computer at the end of the cycle in which the DATE instruction is executed.)	
	Debugging	Equivalent	
	Failure Diagnosis	Equivalent (Messages of Programming Console are displayed on the screen.)	
	Special	Equivalent	
	Block Programming	Equivalent	
	Text String Processing	Equivalent	
Task Control	Equivalent		

**Note** TIM/TIMH (Timer No. 2,048 to 4,095), TTIM, TIML, MTIM, and FPD will not operate normally when the cycle time is 100 ms or longer. Make sure that the cycle time is different from that of the CS/CJ/CP-series CPU Unit if set as the computer cycle time.

Item		CS/CJ-series PLC	CX-Simulator
I/O comment storage		In the CS/CJ-series PLCs, I/O comments can be stored in Memory Cards as I/O comment files.	Same as shown at left. (The destination is the hard disk of the computer.)
Battery installation		The battery is not installed when the PLC is shipped from the factory. Install the provided battery before using the PLC.	Not available.
Clock function		When the battery is installed in the PLC, the clock will begin from an arbitrary value. Set the clock with a Programming Device or the DATE(735) instruction.	Adjusted to the clock of the computer when the CX-Simulator is started.
Memory Cards and Memory Cassettes	I/O Memory	Any range of I/O Memory can be saved as a file in a Memory Card (flash ROM) or EM file memory with a Programming Device (including Programming Consoles) or the instruction provided for this operation. A Programming Device or instruction can be used to read the data back from file memory. These operations can also be performed with FINS commands.	Same as shown at left. (The hard disk of the computer is used as memory cards or EM file memory.) Batch save/read enable to save/read I/O memory, PLC Setup, UM, and other settings as the own files.

	Item	CS/CJ-series PLC	CX-Simulator
Memory Cards and Memory Cassettes	User program	<p>The entire program can be saved as a file in a Memory Card (flash ROM) or EM file memory with a Programming Device (including Programming Consoles) or the instruction provided for this operation. A Programming Device or instruction can be used to read the program back from file memory.</p> <p>These operations can also be performed with FINS commands.</p>	<p>Same as shown at left.</p> <p>(The hard disk of the computer is used as memory cards or EM file memory.)</p> <p>Batch save/read enable to save/read I/O memory, PLC Setup, UM, and other settings as the own files.</p>

Item			CS/CJ-series PLC	CX-Simulator
Serial communications (peripheral port or RS-232C ports)	Mode	Peripheral port	Host Link, peripheral bus, NT Link (1:N), (Programming Console and peripheral bus are automatically recognized.) (No-protocol is not possible for the peripheral port.)	The peripheral port is not supported.
		RS-232C port	Host Link, peripheral bus, NT Link (1:N), and No-protocol. (1:1 links and peripheral bus are not supported for the RS-232C port.)	Host Link, No-protocol, and NT Link are supported.
		USB port	Peripheral bus, EtherNet/IP (CJ2-series PLCs only)	The USB port is not supported.
	Baud rate	Peripheral port	300/600/1,200/2,400/4,800/9,600/19,200/38,400/57,600/115,200 bps (Baud rates of 38,400/57,600/115,200 bps are not standard for RS-232C.)	The peripheral port is not supported.
		RS-232C port		Same as shown at left. (The actual speed will vary depending on the hardware of the computer.)
Network communications timing			Performed as peripheral servicing.	When in Continuous Run, performed as peripheral servicing. When in pausing, the network communications processing is performed.
Interrupt control modes			If an interrupt occurs during Host Link servicing, Remote I/O servicing, Special I/O Unit servicing, or execution of an instruction, that process will be stopped immediately and the task will be executed instead.	Interrupt is prohibited during peripheral servicing and execution of an instruction.
Startup mode			The CS/CJ-series CPU Unit will start in PROGRAM mode if the Startup Mode is set in the PLC Setup to PRCH: Switch Setting on Programming Console (default setting) and the CPU Unit is started without a Programming Console connected.	Only "PRCH: Switch Setting on Programming Console" (default setting) (Will start in PROGRAM mode as a Programming Console is not connected.)

## **SECTION 2**

### **Setup**

2-1 Installing and Uninstalling the Software .....	26
--	----

## **2-1 Installing and Uninstalling the Software**

The CX-Simulator is installed from the CX-One Installer. For details, refer to the *CX-One Setup Manual* (Cat. No. W463), which is provided with the CX-One.

## SECTION 3

### Basic Operation

3-1 Starting Methods for the CX-Simulator.....	28
3-2 Starting and Going Online from the CX-Programmer.....	29
3-2-1 Basic Window .....	30
3-2-2 Pop-up Menu.....	30
3-2-3 Disconnecting the CX-Simulator from the CX-Programmer .....	31
3-2-4 Exiting the CX-Simulator from the CX-Programmer .....	31
3-2-5 Going Online with the CX-Simulator Already Started from CX-Simulator Menus .....	31
3-3 Starting and Exiting from CX-Simulator Menus .....	32
3-3-1 Starting CX-Simulator.....	32
3-3-2 Exiting CX-Simulator.....	33
3-4 Outline of Operation Procedure.....	34
3-4-1 Method 1: Starting and Going Online from the CX-Programmer (CX-Programmer Version 3.0 or Higher).....	34
3-4-2 Method 2: Starting from the CX-Simulator Menus.....	35
3-5 Creating a New PLC.....	38
3-5-1 PLC Setup Wizard.....	38
3-5-2 Open Existing PLC.....	45
3-5-3 Folder Used in CX-Simulator.....	46
3-6 Each Part of the Windows .....	48
3-6-1 Basic Windows Arrangement.....	48
3-6-2 Basic Windows Transition .....	49
3-7 System Status Setting Window.....	50
3-7-1 System Status Setting Window .....	50
3-7-2 Setting Menu of System Status Setting .....	54
3-7-3 Register PLC Unit .....	54
3-7-4 UM Settings.....	55
3-7-5 PLC Clock Settings .....	57
3-7-6 PLC Operation Settings.....	58
3-7-7 Initializing PLC .....	59
3-7-8 Message Display Window.....	59
3-7-9 Alarm Display .....	60
3-8 Connecting to the CX-Programmer Version 2.1 or Lower.....	61
3-8-1 Work CX-Simulator Window .....	62
3-8-2 How to Connect with CX-Programmer .....	63
3-9 Debug Console Window.....	66
3-9-1 Debug Console Window .....	66
3-9-2 Menu List of CX-Simulator Debug Console.....	68
3-9-3 Outline of Basic Operation for Debug Console Menu .....	69
3-9-4 [File] Menu.....	70
3-9-5 [Replay] Menu.....	74
3-9-6 [Help] Menu .....	83
3-9-7 [Step Run] Window.....	84
3-9-8 Task Control Window .....	86
3-9-9 I/O Break Condition Settings Window.....	87

### 3-1 Starting Methods for the CX-Simulator

There are two different methods that can be used to start the CX-Simulator.

Method 1: Starting and Going Online from the CX-Programmer

Select [Simulator Online Connection] from the [Simulation] menu.

Method 2: Starting from the CX-Simulator Menus

The CX-Simulator can be started separately from the CX-Simulator menus.

Settings are made using the PLC Setup Wizard, operations are performed on the Simulator Connections Window, and an online connection is made from the CX-Programmer.

**Note** Method 1 can be used to make an online connection for a CX-Simulator already started using the CX-Simulator menus for method 2.

The differences between these two methods are listed in the following table.

Method		Method 1: Starting and Going Online from the CX-Programmer		Method 2: Starting from the CX-Simulator Menus	
Main Differences		<ul style="list-style-type: none"> <li>Used when serial communications and connections to FinsGateway applications will not be performed.</li> <li>Used when a PLC data directory will not be specified and UM or I/O memory data saved or read.</li> </ul>		<ul style="list-style-type: none"> <li>Used when serial communications or connections to FinsGateway applications will be performed.</li> <li>Used when a PLC data directory will be specified and UM or I/O memory data saved or read.</li> </ul>	
System Status Settings	Select PLC	Supported.	Automatically selected according to CX-Programmer project.	Supported.	System Status Setting Window
	PLC Unit Registration	Not supported.			
	Register Network Communications	Not supported.			
	Serial Communications Setting	Not supported.			
	UM Settings	Not supported.			
	PLC Clock Settings	Supported.	Pop-up Menus		
	PLC Operation Settings	Supported.			
	Initialize PLC	Not supported.			
Status Display	Status Display LED	Not supported.		Supported.	System Status Setting Window
	Cycle Time Display				
	Operation Mode				
	UM Settings Display				
	Message Display				
	Alarm Display				
	Detail Status Display				
Program Execution Operation	Run	Supported.	Toolbar: Execution Operation	Supported.	Toolbar: Execution Operation
	Scan Run				
	Continuous Scan Run				
	Step Run				
	Continuous Step Run				
	Pause				
	Stop				
	Scan Replay				
Reset					
Debugging Operation	Show Step Run	Supported.	Toolbar: Debugging Operation	Supported.	Toolbar: Debugging Operation
	Task Control				
	I/O Break Condition Setting				
Files	Read All	Not supported.		Supported.	
	Save All	Not supported.		Supported.	
Replay	I/O Condition Operation	Supported.	Pop-up Menus	Supported.	Menus
	Data Replay	Supported.		Supported.	
	Command Log	Not supported.		Supported.	
Connection with Application Programs		Not supported.		Supported.	Work CX-Simulator Window



## 3-2 Starting and Going Online from the CX-Programmer

When using CX-Programmer version 3.0 or higher, the CX-Simulator can be started and placed online from the CX-Programmer. As soon as online status is reached, program transfer operations to the CX-Simulator can be performed.

**Note** The CX-Simulator must be started from the CX-Simulator menus (see 3-3 *Start and Exit*) to use a computer serial port from the CX-Simulator or to perform communications via a FinsGateway network from the CX-Simulator.

The procedure used to start the CX-Simulator from the CX-Programmer and create an online connection is described below. The CX-Programmer (version 3.0 or higher) must be installed on the computer in advance.

- 1,2,3...** 1. Start the CX-Programmer, create a new project, and set a CS/CJ-series PLC as the PLC model, or load an existing project with a CS/CJ-series PLC set as the PLC model.

**Note** Perform the following steps to automatically download the program to the CX-Simulator after creating an online connection from the CX-Programmer.

- a) Select [Tool] | [Option] from the main menu on the CX-Programmer.
- b) Click the [PLCs] tab. The following window will be displayed.

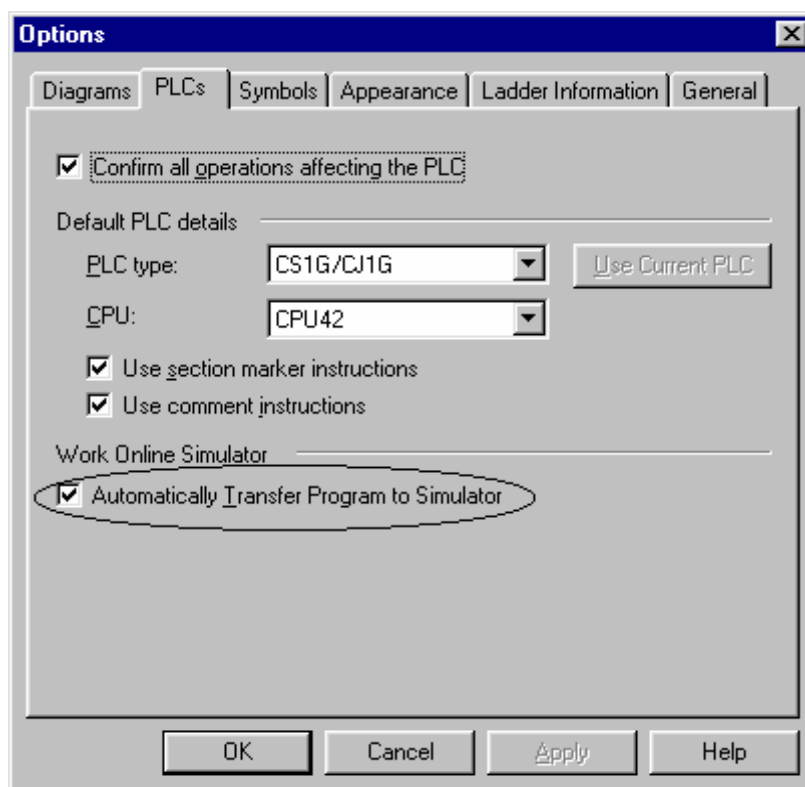

- c) Place a checkmark by [Automatically Transfer Program to Simulator] and click the [OK] button.

2. Select [Simulation] | [Simulator Online Connection] from the main menus. The CX-Simulator will be started automatically for the PLC model specified in the selected project and an online connect will be made unrelated to the communications settings in the current project.

**Note** If [Automatically Transfer Program to Simulator] was selected in the tool options, a dialog box for transferring the program to the CX-Simulator will appear and the program will be transferred to the CX-Simulator when the [OK] button is clicked.

### 3-2-1 Basic Window

If an online connection to the CX-Simulator is created from the CX-Programmer, the following [Debug Console] window will be displayed for the CX-Simulator.



Name	Function
Title bar	The title is displayed along with the current cycle count. The cycle count will be displayed in brackets [ ] when the cycle has been paused.
Toolbar	Click an icon to select a function. Refer to 3-9 <i>Debug Console Window</i> for details.

**Note** The main menus will not be displayed when an online connection to the CX-Simulator has been created from the CX-Programmer.

### 3-2-2 Pop-up Menu

The following pop-up menu will be displayed when the right mouse button is clicked anywhere in the [Debug Console] window except on the title bar or on an icon that can be selected.

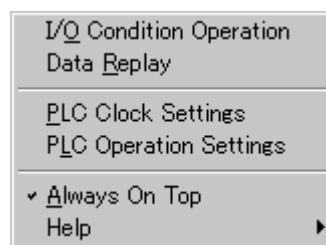

When an online connection to the CX-Simulator has been created from the CX-Programmer, this pop-up menu is used to select the following functions instead of using the main menus.

Name	Function
I/O Condition	Starts the I/O Condition Operation Tool. Refer to <i>I/O Condition</i> under 3-9-5 [Replay] Menu for details.
Data Replay	Sets Data Replay and starts the Data Replay Tool. Refer to <i>Data Replay</i> under 3-9-5 [Replay] Menu for details.
PLC Clock Settings	Sets the cycle time mode, the interval for continuous run, and others. Refer to 3-7-5 <i>PLC Clock Settings</i> for details.
PLC Operation Settings	Sets the WDT disable, DIP switches, and others. Refer to 3-7-6 <i>PLC Operation Settings</i> for details.
Initialize PLC	Initialize the I/O memory of PLC.
Always on Top	Pins the CX-Simulator windows on top.
Help	Displays help.

### 3-2-3 Disconnecting the CX-Simulator from the CX-Programmer

Use the following procedure to end the online connection to the CX-Simulator from the CX-Programmer.

Select [Simulation] | [Simulator Online Connection] from the main menus. The CX-Simulator will go offline and the CX-Simulator dialog box will return to the task tray. The CX-Simulator will automatically return to PROGRAM mode. The CX-Simulator dialog box will be restored to the original position if [PLC] | [Simulator Online Connection] is selected from the main menus of the CX-Programmer again.

### 3-2-4 Exiting the CX-Simulator from the CX-Programmer

You can exit the CX-Simulator using any of the following steps.

- Select [Exit Simulator] from the [Simulation] menu in the main menus of the CX-Programmer.
- Close the CX-Programmer project.
- Exit the CX-Programmer.

### 3-2-5 Going Online with the CX-Simulator Already Started from CX-Simulator Menus

[Simulator Online Connection] can be selected to go online with the CX-Simulator even if the CX-Simulator has already been started from CX-Simulator menus. To do this, the CX-Simulator Communications Unit must be the Controller Link.

- 1,2,3... 1. Open a project on the CX-Programmer and set the PLC model to the same model as the one used to start the CX-Simulator.
2. Select [Simulation] | [Simulator Online Connection] from the main menus of the CX-Programmer. An online connect will be made unrelated to the communications settings in the current project.

## 3-3 Starting and Exiting from CX-Simulator Menus

This section describes how to start and exit the CX-Simulator.

- Note** Use this method to start the CX-Simulator in the following cases:
- When the CX-Simulator performs serial communications using a computer's serial port.
  - When performing communications via a FinsGateway network.
  - When specifying a PLC data directory and saving or reading UM or I/O memory data for the Ladder Engine.

### 3-3-1 Starting CX-Simulator

The following shows the CX-Simulator's startup procedure.

- 1,2,3...** 3. After clicking the [Start] button on the task bar, select [program] | [Omron] | [CX-One] | [CX-Simulator] as shown below. (If installed in the CX-Simulator group.)

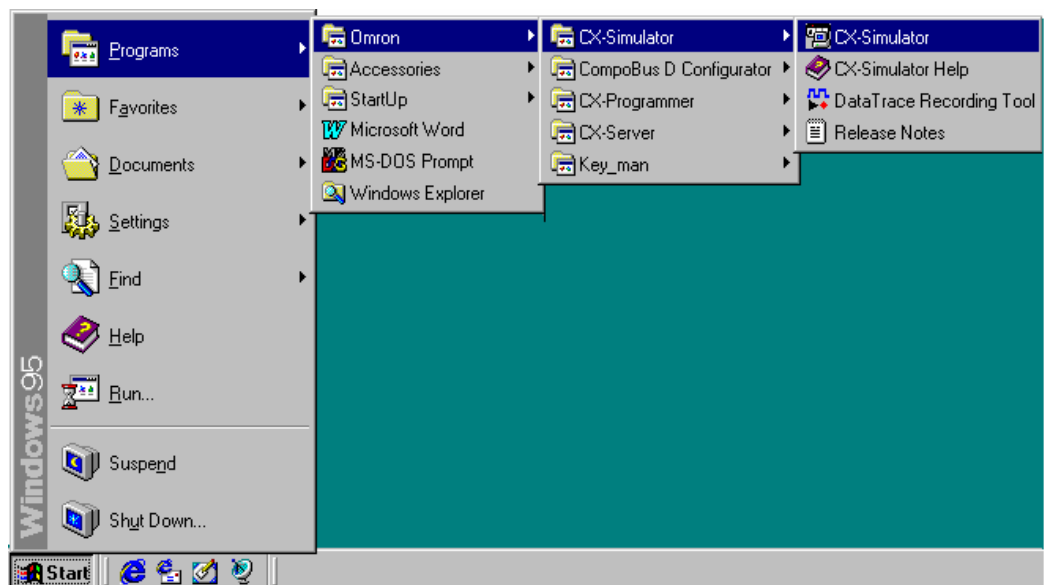

[Select PLC] of the CX-Simulator setup wizard will be displayed as shown below.

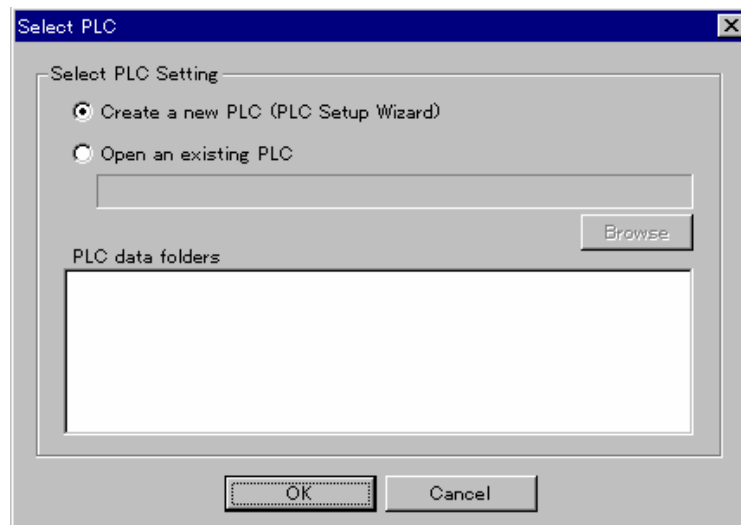

4. Selecting [Create a new PLC] allows to input necessary parameters for the simulation using the PLC setup wizard. Selecting [Open an existing PLC] enables to simulate the PLC with the parameters input so far.
5. When completing inputting parameters, the Ladder Engine will be started up and each window for the Debugger's connection to the CX-Simulator, the Debug Console, and the System Status Setting will be displayed.

### 3-3-2 Exiting CX-Simulator

The following shows how to exit the CX-Simulator.

Select [Exit system] from [File] of the Debug Console to exit the CX-Simulator.

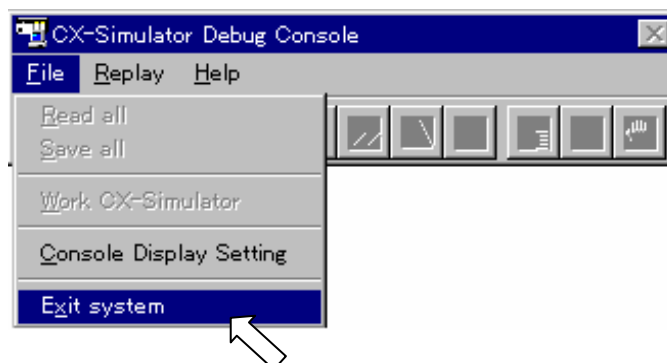

**Note** Refer to [Exit system] of 3-9 *Debug Console Window* for the details of the operation when [Exit system].

## 3-4 Outline of Operation Procedure

When using with the CX-Programmer, use the CX-Simulator in the following procedure.

### 3-4-1 Method 1: Starting and Going Online from the CX-Programmer (CX-Programmer Version 3.0 or Higher)

- 1,2,3...**
1. CX-Programmer Start  
Start the CX-Programmer.
  2. Programming  
Create a program for debugging by [Create] or by reading an existing project.
  3. PLC Online Connection and Program Transfer
    - a) Select [Automatically Transfer Program to Simulator] on the [PLCs] tab under [Tools] | [Options].
    - b) Select [Simulator Online Connection] from the [Simulation] menu.
    - c) Click the [OK] button on the dialog box for the program transfer option.  
Refer to 3-2 *Starting and Going Online from the CX-Programmer*.
  4. Trial Run  
Either turning the mode of the Ladder Engine to MONITOR by the CX-Programmer or pressing the [Continuous Run] button of the [Debug Console] leads to a trial run.  
Refer to the *CX-Programmer Operation Manual*.
  5. Monitor/ Debug
    - 5-1 Monitor  
Monitor I/O bit status and PV.  
Execute force-set/reset, trace, online edit, and others.
    - 5-2 Program Check by Break  
Set break points and I/O break conditions in the ladder diagram as required and stop the program step by step to monitor the contents of I/O memory.  
Refer to 4-3 *Step Run and Break*.
    - 5-3 Cycle Time Monitor  
Confirm the virtual cycle time so that the program execution time on the actual PLC is within the permissible range.
    - 5-4 Task Operation Check  
Check the number and time of the task execution in the [Task Control] window. If an interrupt task exists, execute the program with the interrupt timing changed to check the interrupt operation.  
Refer to 4-4 *Task Debugging*.
    - 5-5 Serial/ Network Communications

Display the contents of serial/network communications to debug with actual communications.

Refer to *5 Debugging Serial Communications* and *6 Debugging Network Communications*.

## 6. Debugging by Virtual External Inputs

### 6-1 Generating Virtual External Inputs

Create data/program for virtual external inputs.

Refer to *8-3 Generating Virtual External Inputs*.

### 6-2 Virtual Run

Generate virtual external inputs using the created data/program to virtually run the ladder diagram in more actual way.

Refer to *8-4 Running by Virtual External Inputs*.

### 6-3 Check Results

Check the results of the virtual run by the time chart monitor or spreadsheet software.

Refer to *8-5 Checking the Result*

## 7. Switching to the actual PLC

Disconnect the Simulator and check the program again with the actual PLC connected.

## 3-4-2 Method 2: Starting from the CX-Simulator Menus

### 1,2,3... 1. CX-Programmer Start

Start the CX-Programmer.

### 2. Programming

Create a program for debugging by [Create] or by reading an existing project.

### 3. CX-Simulator Start

Start the CX-Simulator.

Refer to *3-3 Starting and Exiting from CX-Simulator Menus*.

### 4. PLC Setting Wizard

Select either [Create a new PLC] or an existing PLC directory.  
For [Create a new PLC], set as follows.

- (1) Select the PLC type.
- (2) Select the Units used in PLC.
- (3) Set for network communications.
- (4) Set for serial communications.

Refer to *3-5 Creating a New PLC*.

## 5. Connecting with CX-Programmer

CX-Programmer Version 3.0 or Higher

- a) Select [Automatically Transfer Program to Simulator] on the [PLCs] tab under [Tool] | [Option].
- b) Select [Simulator Online Connection] from the [PLC] menu.
- c) Click the [OK] button on the dialog box for the program transfer option.  
Refer to 3-2 *Starting and Going Online from the CX-Programmer*.

CX-Programmer Version 2.1

Exiting the PLC Setup wizard will start the Ladder Engine according to the setting. Also, each window for Connect to Simulator, Debug Console, and System Status Setting is displayed. First, select a communications path (unit) in the [Connect to CX-Simulator] window. Second, press the [Connect] button to check the FINS destination address of the Ladder Engine displayed in the Connection Guidance.

Refer to 3-8 *Connecting to the CX-Programmer Version 2.1 or Lower*.

## 6. CX-Programmer Communications Setting

Set the communications setting for the PLC simulated by the CX-Programmer according to the communications unit and the FINS address checked in the [Connect to CX-Simulator] window.

Refer to 3-8 *Connecting to the CX-Programmer Version 2.1 or Lower*.

## 7. PLC Online Connection

Select [Work Online] by the CX-Programmer. When completing online connection, turn the mode of the Ladder Engine to PROGRAM.

## 8. Program Download

Download the program from the CX-Programmer to the CPU Unit of the Ladder Engine in the PROGRAM mode (remain unchanged).

Refer to the *CX-Programmer Operation Manual*.

## 9. Trial Run

Either turning the mode of the Ladder Engine to MONITOR by the CX-Programmer or pressing the [Continuous Run] button of the [Debug Console] leads to a trial run.

Refer to the *CX-Programmer Operation Manual*.



## 10. Monitor/ Debug

## 10-1 Monitor

Monitor I/O bit status and PV.  
Execute force-set/reset, trace, online edit, and others.

## 10-2 Program Check by Break

Set break points and I/O break conditions in the ladder diagram as required and stop the program step by step to monitor the contents of I/O memory.

*Refer to 4-3 Step Run and Break.*

## 10-3 Cycle Time Monitor

Confirm the virtual cycle time so that the program execution time on the actual PLC is within the permissible range.

## 10-4 Task Operation Check

Check the number and time of the task execution in the [Task Control] window. If an interrupt task exists, execute the program with the interrupt timing changed to check the interrupt operation.

*Refer to 4-4 Task Debugging.*

## 10-5 Serial/ Network Communications

Display the contents of serial/network communications to debug with actual communications.

*Refer to 5 Debugging Serial Communications and  
6 Debugging Network Communications.*

## 11. Debugging by Virtual External Inputs

## 11-1 Generating Virtual External Inputs

Create data/program for virtual external inputs.

*Refer to 8-3 Generating Virtual External Inputs.*

## 11-2 Virtual Run

Generate virtual external inputs using the created data/program to virtually run the ladder diagram in more actual way.

*Refer to 8-4 Running by Virtual External Inputs.*

## 11-3 Check Results

Check the results of the virtual run by the time chart monitor or spreadsheet software.

*Refer to 8-5 Checking the Result*

## 12. Switching to the actual PLC

Disconnect the Simulator and check the program again with the actual PLC connected.

## 3-5 Creating a New PLC

This section explains the data for the CX-Simulator to work with and the initial setting.

### 3-5-1 PLC Setup Wizard

When starting the CX-Simulator, input either of “Create a new PLC” or “Open an existing PLCs” first in the PLC setup wizard. When using the CX-Simulator for the first time, the PLC/CPU model and others must be set in the “Create a new PLC.” The following shows the procedure for “Create a new PLC” in the PLC setup wizard.

**Note** When setting the PLC/CPU model in “Create a new PLC,” be sure it is correct. When changing the model set before, specify the same folder and repeat the same procedure in the PLC setup wizard.

- 1,2,3...** 1. Selecting [Select PLC] in the PLC setup wizard when starting the CX-Simulator or in the [Settings] of [System Status Setting] window will display the following [Select PLC] dialog box.

- Select PLC

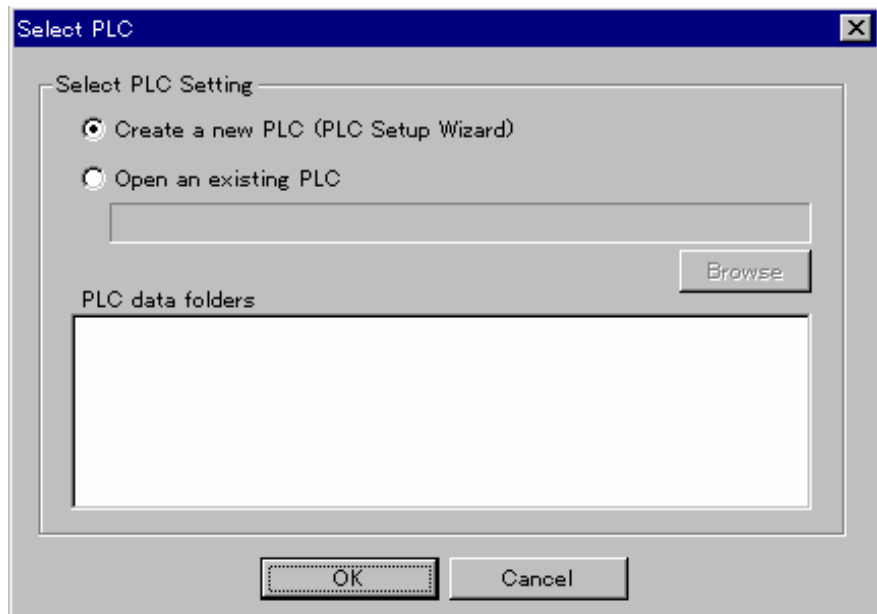

2. Selecting [Create a new PLC (PLC Setup Wizard)] and clicking the [OK] button will display the [PLC Data folder Settings] window. Here input the name of the new PLC data folder. Selecting the folder is also possible by clicking the [Browse] button.

- PLC Data Folder Settings

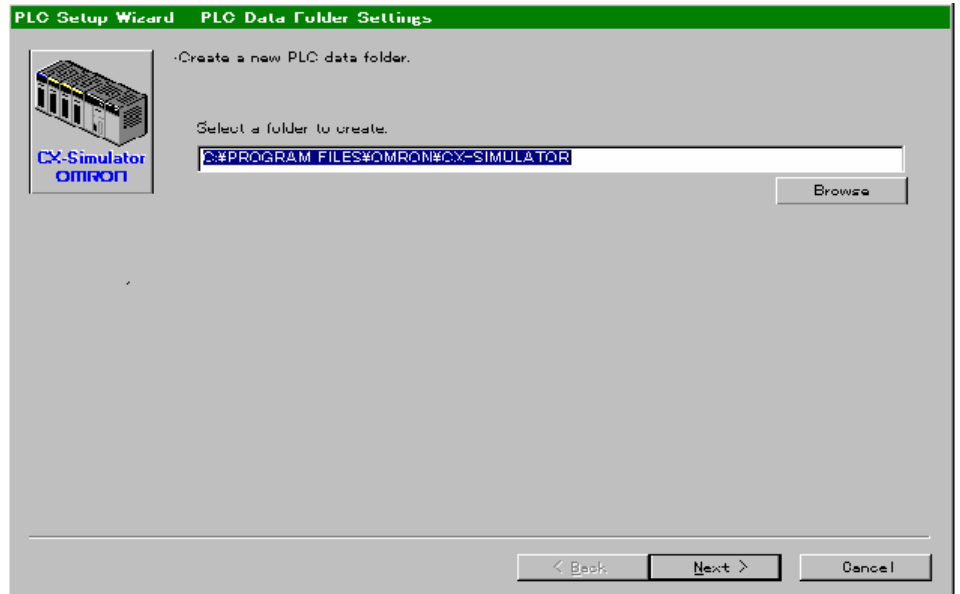

3. Clicking the [Next(N)>] button will display [Select PLC Type] window to select a CPU model.

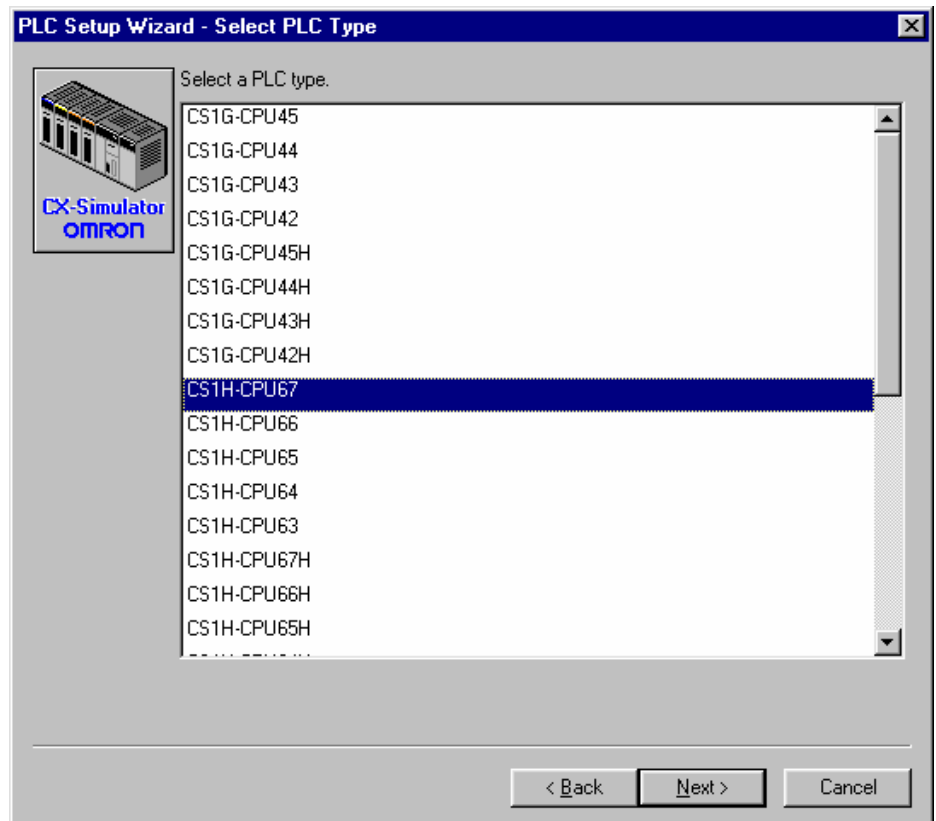

- PLC Type Selection
4. Clicking the [Next(N)>] button will display the [Register PLC Unit] window. Reregister the Unit number instead of I/O Table setting performed in the CX-Programmer. This registration is for calculating the cycle time influenced by each unit, not for actual operation. (For the Network Communications Unit and Serial Communications Unit, this will be used in the actual operation.)
- PLC Unit Registration

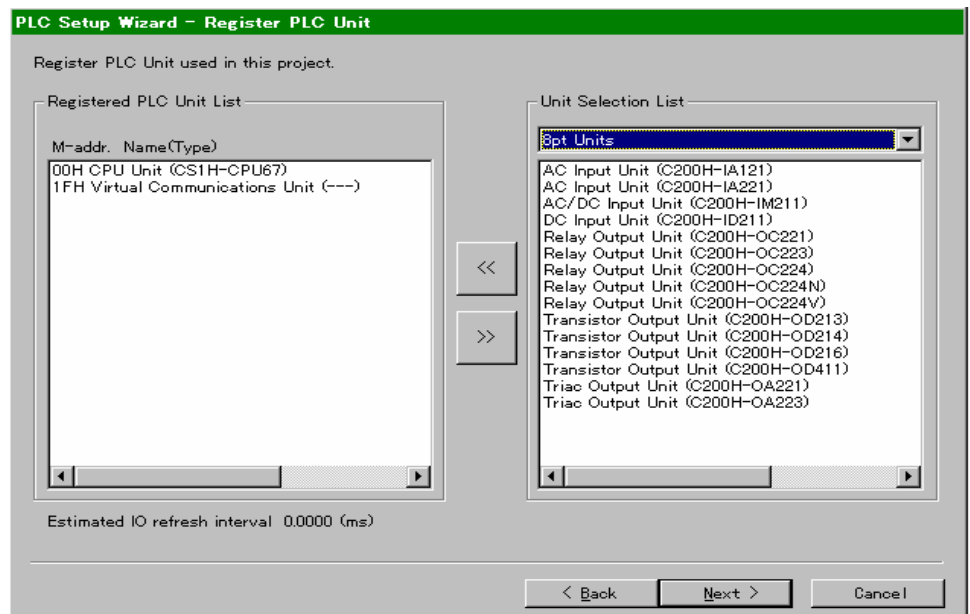

In the initial state, the CPU unit and the Simulator Communications Unit are registered. The Simulator Communications Unit is a virtual network communications unit, dedicated to the CX-Simulator, for the Ladder Engine to perform network communications with external devices. At least one virtual network communications unit (one of Controller Link unit, Ethernet unit, or simulator communications unit) is required to connect the Ladder Engine with a programming tool. Therefore, if the Controller Link unit or Ethernet Unit is not used, the Simulator Communications Unit will be used.

**Note** Refer to *6. Debugging Network Communications* for the detail of the Network Communications Unit.

- Pressing the [Unit Selection List] button will display the Unit Group List. Selecting the required group in the list will display the Units corresponding to the group.
- Select the group from [Unit Selection List], select the unit to be added, and press the [<<] button to add a unit.
- Select the unit to be deleted from [Registered PLC Unit List] and press the [>>] button to delete a unit.

- If the CPU Bus Unit or the Special I/O Unit is registered, the input dialog box for a Unit number or Machine number will be displayed as shown below.

Input Unit number for the CPU Bus Unit and Machine number for the Special I/O Unit. Unit number or Machine number will be converted to Unit address and displayed in the [Registered PLC Unit List].

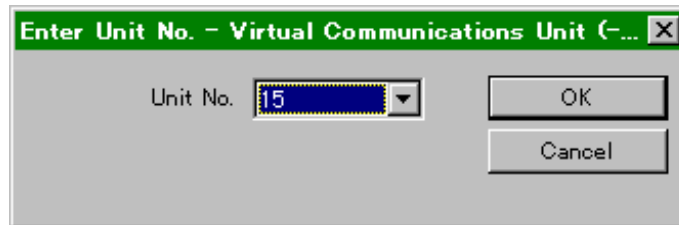

- If a unit is added, the typical I/O refresh interval for each unit will be added to the logical I/O refresh interval.
- Double-clicking the registered CPU Bus Unit or Special I/O Unit enables to change the Unit number.

**Note** Set the Unit numbers so as not to overlap each other. Register the Units for the number actually to be used. Mismatching number will cause incorrect calculation of the I/O refresh interval. As the Simulator Communications Unit is a virtual unit, the virtual I/O refresh interval will be 0 ms.

**Note** Unlike an actual PLC, the CX-Simulator does not limit the number of Units (excluding a CPU Bus Unit) to be registered.

**Note** Refer to 9-2 *Cycle Time and Time* for the detail of the cycle time.

5. Clicking the [Next(N)>] button after completing the registration of the Units to be used will display the [Network Communications Settings] window. Set for the network communications process from the ladder process to the external devices.

- Network Communications Settings

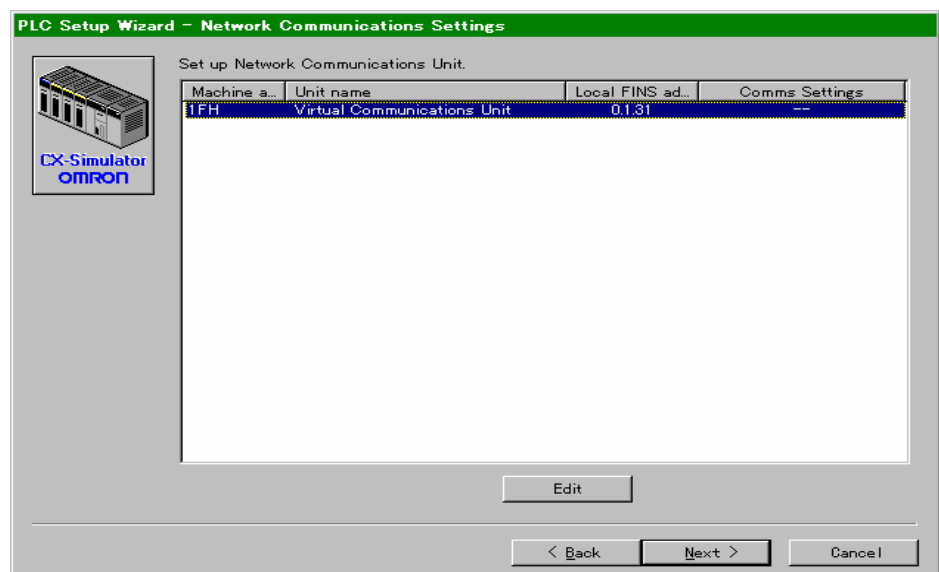

6. Select the network communications unit requiring setting and press the [Edit] button to display the [Register Network Communications] window.

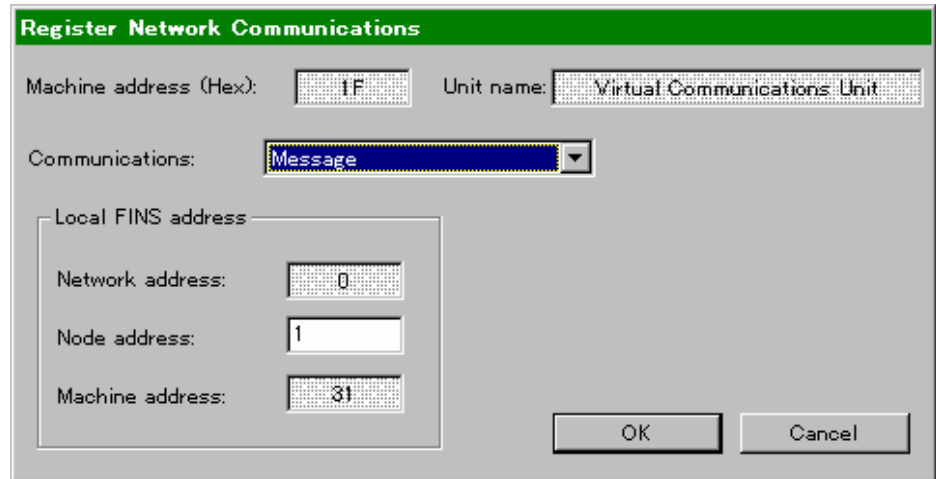

7. Set the node address and communications operation settings as required.

**Note** The detail settings of local FINS address and communications settings are explained in *6. Debugging Network Communications*.

8. Click the [OK] button. Exit the [Register Network Communications] window and return to the [Network communications settings] window.
9. Repeat the operation from 6 to 8 as required for each unit. After completing all settings, click the [Next(N)>] button to display the [Serial Communications Settings] window. For Serial comm. Settings, set for the Serial communications for each Serial port of the unit.

- Serial Communications Settings

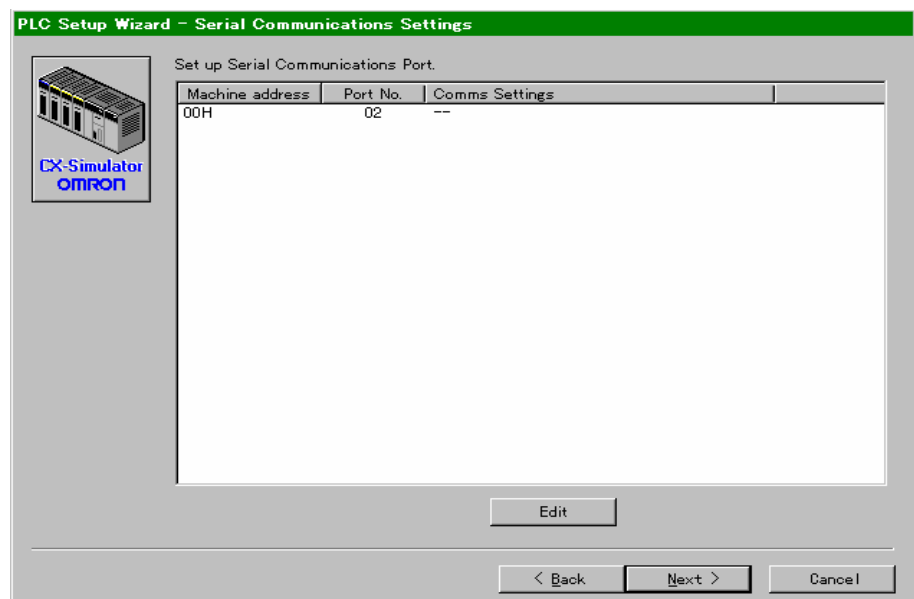

10. Select the serial port requiring setting and press [Edit] button to display the [Serial Port Settings] window shown below.

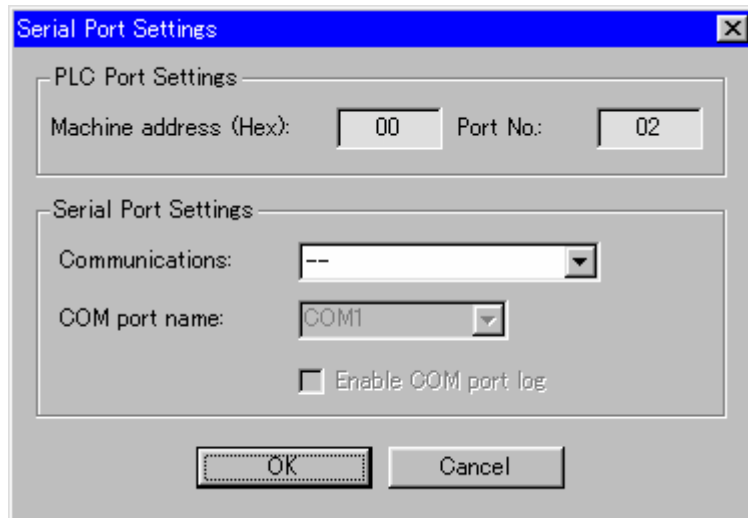

11. Set Comm. Settings, COM port name, and Enable COM port log as required.

**Note** The detail of [Serial Port Settings] will be explained in *5. Debugging Serial Communications*.

12. Click the [OK] button to exit the [Serial Port Settings] window and return to the [Serial Communications Settings] window.

13.Exit the Serial communications window

Repeat the operation from 10 to 12 as required. After completing all settings, click [Next(N)>] button to display the [Contents List] window.

- Contents

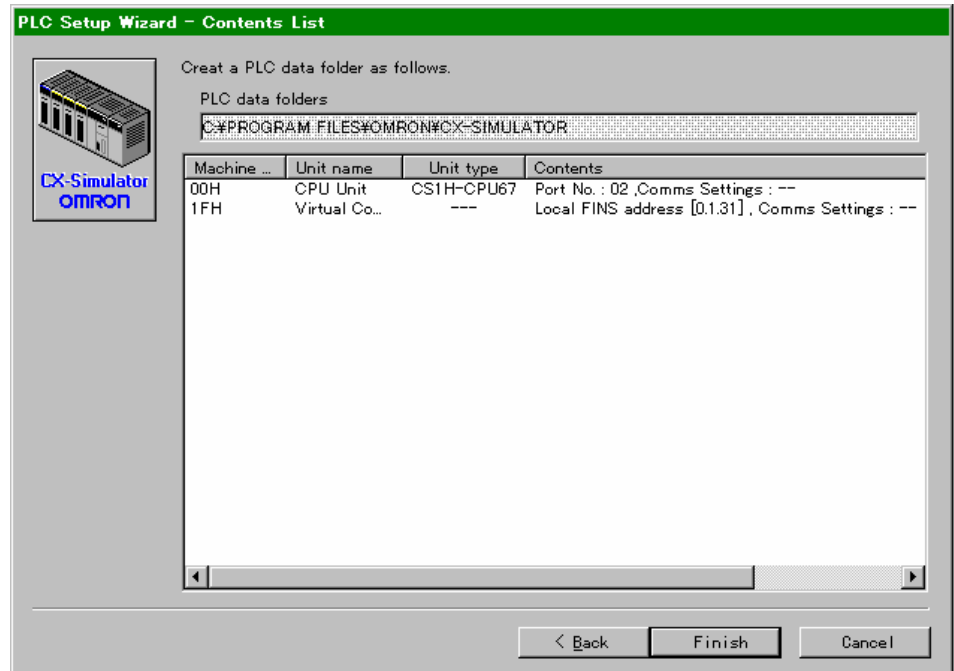

14.Pressing the [Complete] button after confirming the contents of the [PLC Setup] wizard will exit the [PLC Setup] wizard. Then the Ladder Engine is started and each window for Work CX-Simulator, CX-Simulator Debug Console, and Status will be displayed.

- The Work CX-Simulator window      The Ladder Engine of the Simulator will be connected to the CX-Programmer.
- The CX-Simulator Debug Console window      Execute operation for the Ladder Engine.
- The Status window      Display the status of the Ladder Engine and set for the Ladder Engine.

Refer to the following items for the contents of each window.

- Work CX-Simulator window      *3-8 Connecting to the CX-Programmer Version 2.1 or Lower*
- The CX-Simulator Debug Console window      *3-6 Each Part of the Windows*
- The Status window      *3-6 Each Part of the Windows*



15. Clicking the [Connect] button in the [Work CX-Simulator] window will display the network set to CX-Programmer and its FINS address in the [Guide to Connect]. Set for the CX-programmer as guided.

**Note** The details of [Work CX-Simulator] setting will be explained in 3-8 *Connecting to the CX-Programmer*.

### 3-5-2 Open Existing PLC

The Setting information of PLC previously created is saved in the PLC data folder. Opening the existing PLC enables to use the same setting any times.

- 1,2,3... 1. Selecting [Select PLC] in the PLC Setup wizard or in the [Settings] of System Status Setting when starting the CX-Simulator will display the [Select PLC] dialog box.

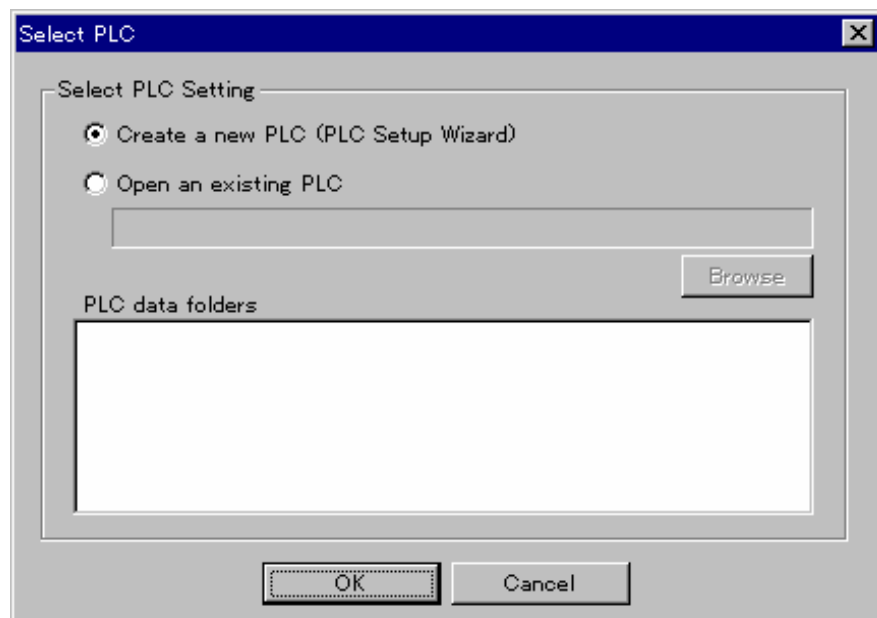

2. Select [Open an existing PLC] and specify the folder.
- Recently-used PLC data folders are selected from the list.
  - Also possible to set by browsing folders with Browse button.
3. Click the [OK] button to exit the [Select PLC] dialog box. The Ladder Engine is started with the contents set before and each window for Work CX-Simulator, CX-Simulator Debug Console, and Status is displayed.
4. Clicking the [Connect] button in the [Work CX-Simulator] window will display the network and its FINS address set to the CX-Programmer in the [Guide to Connect]. Set to the CX-Programmer guided by the display.

**Note** The details of [Work CX-Simulator] setting will be explained in 3-8 *Connecting to the CX-Programmer*.

**Note** When creating a new PLC or opening an existing PLC, the settings so far will be discarded. Save the data before these operations if the settings so far or the program downloaded to the Ladder Engine are needed.

### 3-5-3 Folder Used in CX-Simulator

The CX-Simulator creates folders for data used by each PLC created (PLC data folder). The PLC data folders contain setting information peculiar to the created PLC and file memories able to be accessed by the PLC. Contents of the PLC data folder are as follows:

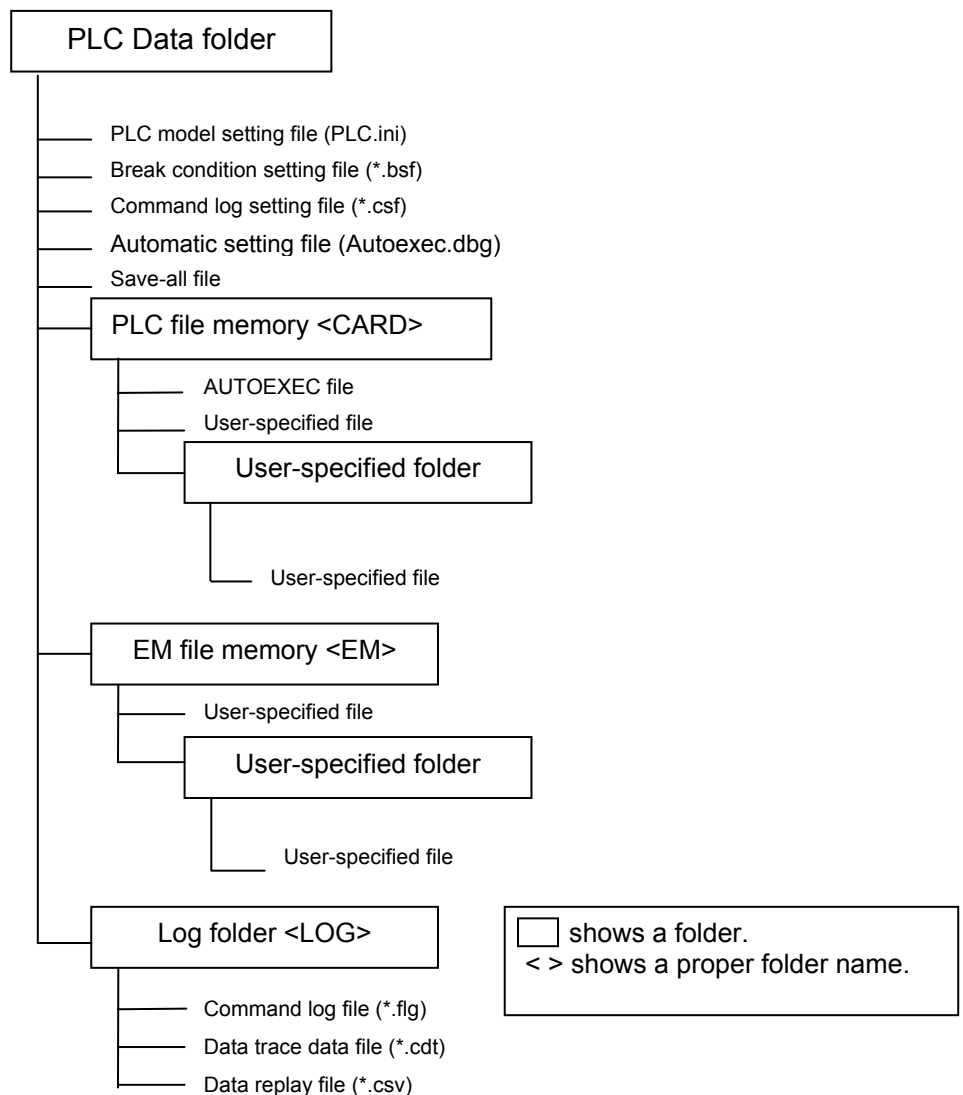

**PLC data folder**

Contain data files peculiar to each PLC used by the CX-Simulator. The following files are contained as data files.

File Type	Extension	Contents
PLC Model Setting File	ini	PLC model and registered unit setting file
Break Condition Setting File	bsf	I/O break condition setting data file
Command Log Setting File	csf	Command log setting data file
Automatic Setting File		File created when exiting the system
Debugger Setting File	dbg	Debugger automatic setting file (AUTOEXEC.DBG)
I/O Memory File	dat	Automatic setting file for I/O memory consisting of multiple files (Memory <sub>n</sub> .dat: the underlined part is a serial number)
Save-all File		File created on the [Save all] of the [File] menu in the [Debug Console] window.
Debugger Setting File	dbg	Debugger setting file
I/O Memory File	dat	I/O memory save file

**Note** A total size of the I/O Memory Files is about 10 MB.

**The folder for the file memory**

The folder for the file memory corresponds to CS/CJ/CP-series CPU Unit file memory function, which is fixedly allocated for each file system.

Name	Root Folder Name	Note
PLC file memory (Memory card)	CARD	No limited capacity (following the capacity of the computer hard disk)
EM file memory	EM	Capacity limit following the PLC Setting

The file created as the file memory is compatible with the one for CS/CJ/CP-series CPU Unit. The operation to the folder for the file memory can be performed in the same way as the file memory for CS/CJ/CP-series CPU Unit.

- Note**
1. If the hard disk capacity of the computer is smaller than that of the file memory, file write may fail.
  2. Refer to Section 5 *File Memory Functions* of *CS/CJ Series Programming Manual* for the details on the file memory functions.

**Log folder**

The test data for the CX-Simulator is stored. The following data files for each use are available.

File type	Extension	Content
Command Log File	flg	The data file storing CX-Programmer's operation log
Data Trace File	cdt	The compatible data file with the CX-Programmer's data trace file
Data Replay File	csv	CSV-format text file

**Note** Refer to 8-3 *Generating Virtual External Inputs* for the data file in the log folder.

### 3-6 Each Part of the Windows

This section explains each part of the windows in the CX-Simulator.

#### 3-6-1 Basic Windows Arrangement

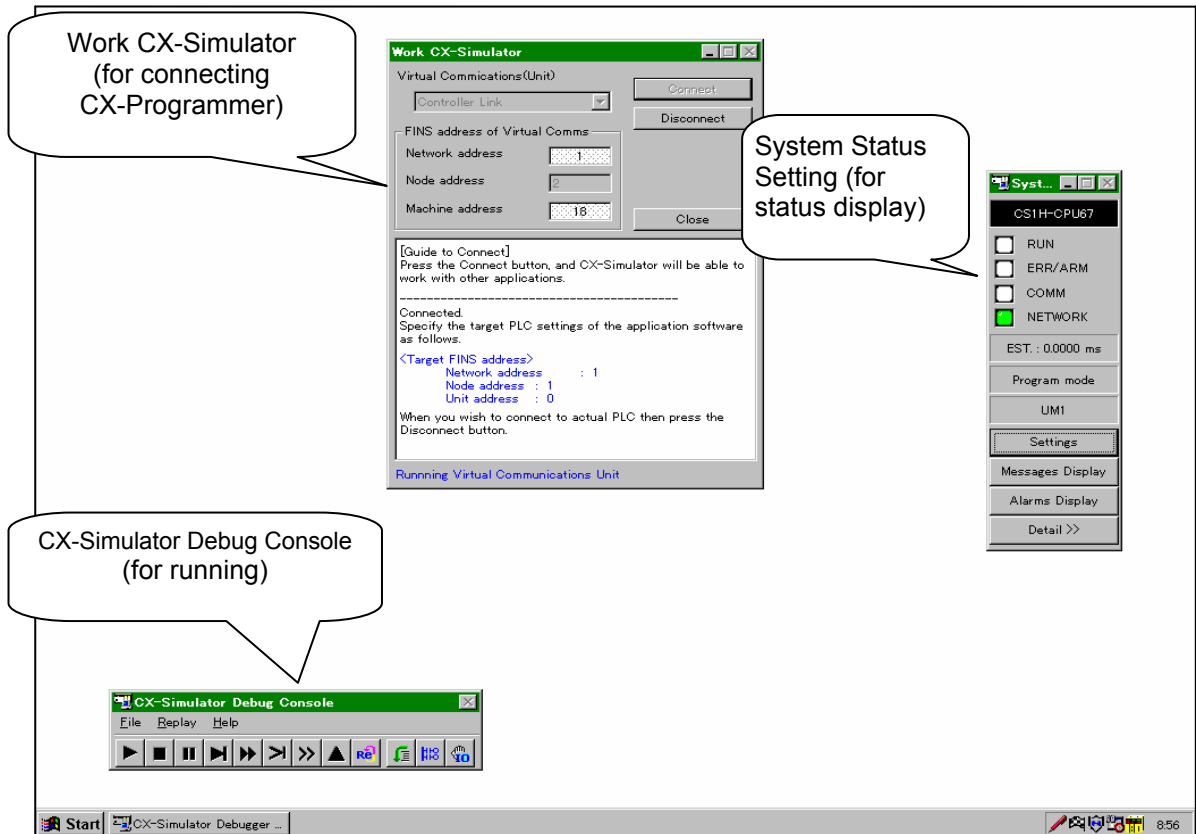

The basic operation of the CX-Simulator is performed in the [CX-Simulator Debug Console] window and the [System Status Setting] window. The [CX-Simulator Debug Console] window executes operation for the Ladder Engine. The [System Status Setting] window displays the status of the Ladder Engine and sets for the Ladder Engine.

**Note:** Only the [Debug Console] window will be displayed when the CX-Simulator is started from the CX-Programmer.

### 3-6-2 Basic Windows Transition

The following shows the basic windows transition of the CX-Simulator. There are two transitions: One from the [CX-Simulator Debug Console] window and the other from the [System Status Setting] window.

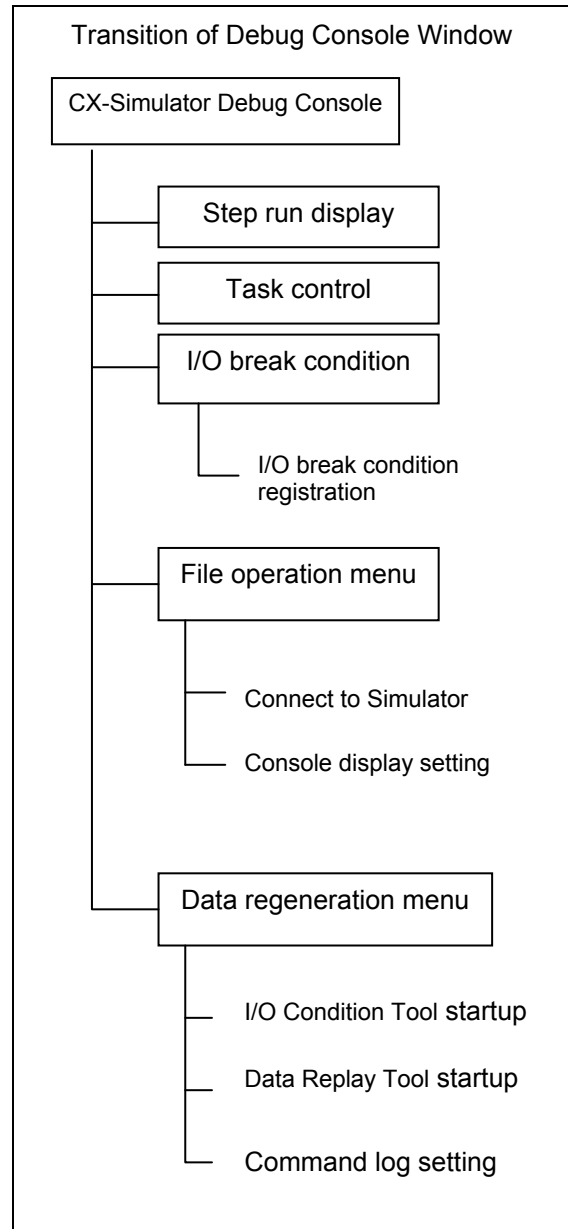
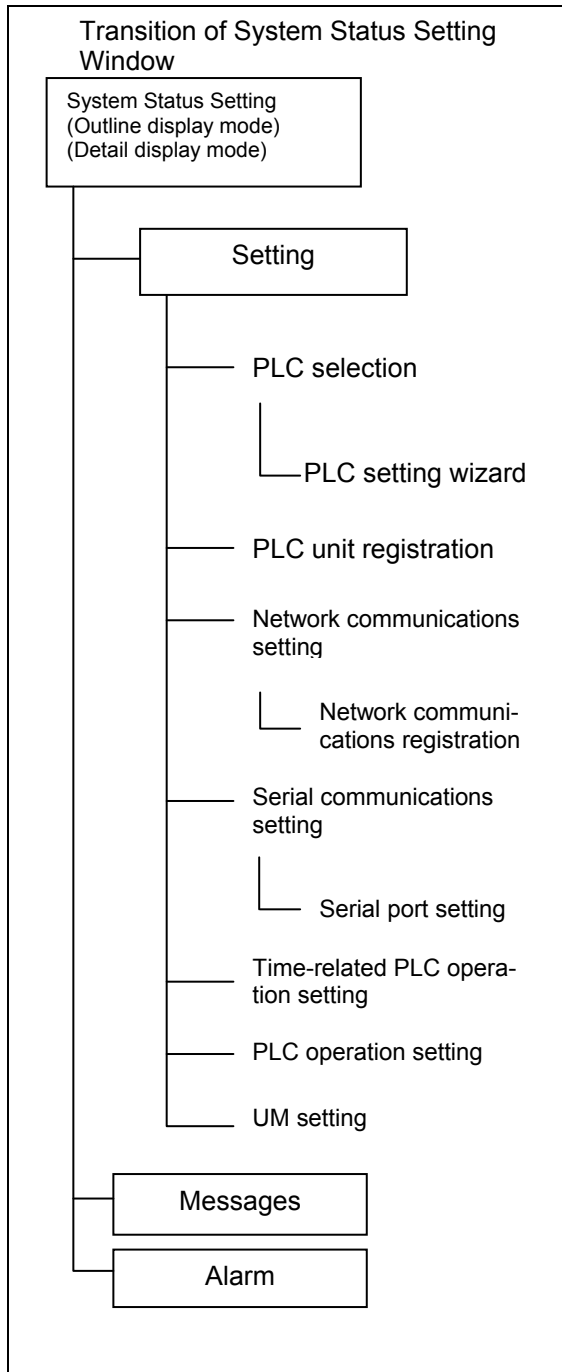

## 3-7 System Status Setting Window

### 3-7-1 System Status Setting Window

The [System Status Setting] window performs PLC model selection, the Ladder Engine status display, cycle time display, UM set/display, network communications set, Serial communications set, and others.

Transition of System Status Setting Window

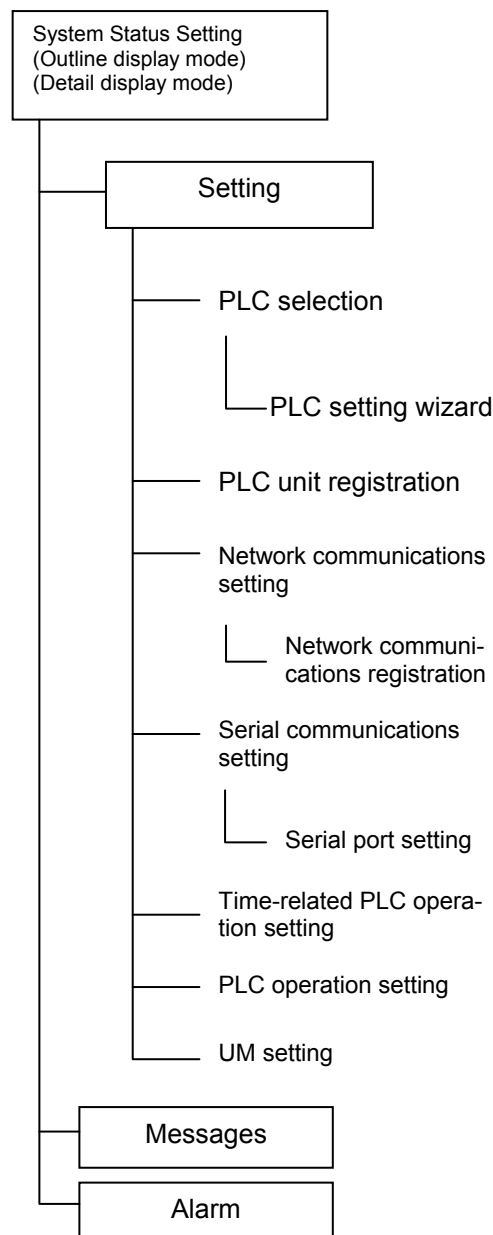

**Names and Functions**

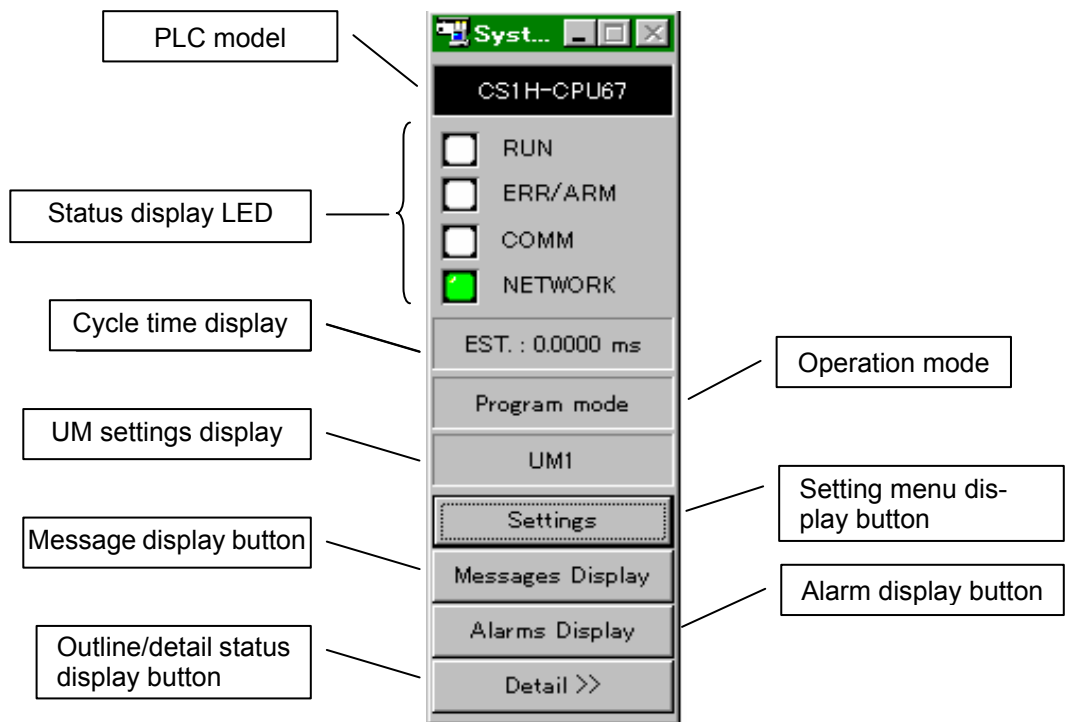

Name	Function
PLC Model	Display the PLC /CPU model currently set.
Status Display LED	Display operation status of the Ladder Engine.
Cycle time Display	Display the cycle time mode of the Ladder Engine (Estimated/Simulated cycle time) and the up-to-date cycle time (Unit: ms).
Operation Mode	Display the operation mode (RUN, MONITOR, or PROGRAM) of the Ladder Engine
UM Settings Display	Display the UM area able to be accessed by the Ladder Engine and the object name.
Setting Menu Display button	Display the setting menu.
Message Display button	Display the Message Display window.
Alarm Display button	Start the Alarm Display application.
Outline/Detail Status Display button	Switch the display mode of the System Status Setting window (Outline or Detail).

**Status Display LED**

LED	Display Status		Condition
	CS/CJ/CP-series PLC	CX-Simulator	
RUN	Lit (Green)	Green	Executing programs in RUN/MONITOR mode.
	Blink (Green)	–	Mode error in system downloading (Not used)
	Not lit	White	Error stop in the PROGRAM mode.
ERR/ARM	Lit (Red)	Red	Fatal error/Non-fatal error/Ladder Engine error
	Blink (Red)		
	Not lit	White	Normal
COMM.	Blink (Yellow)	Yellow	Comm. Port sending/receiving (not used)
	Not lit	White	Other than the above
NETWORK	–	Green	Starting Communications Unit
	–	white	Other than the above

**Setting Menu**

Pressing the [Settings] Menu button displays the setting menu.

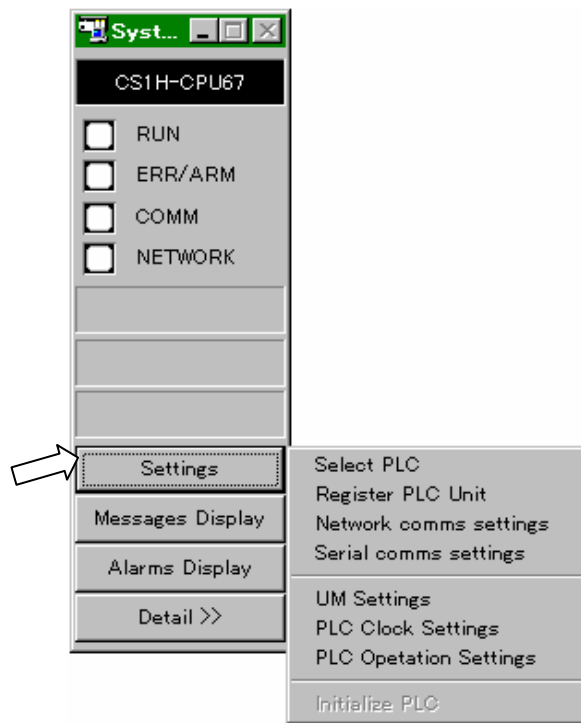

Name	Function
Select PLC	Create a new PLC (the PLC Setting wizard) and select an existing PLC.
Register PLC Unit	Set the unit mounting to PLC.
Network comms settings	Set for the Network Communications Unit.
Serial comms settings	Set for the Serial Communications Unit.
UM Settings	Set for the UM.
PLC Clock Settings	Set the cycle time mode, the interval for continuous run, and others.
PLC Operation Settings	Set WDT disable, DIP switches, and others.
Initialize PLC	Initialize the I/O memory of PLC.



**Outline/Detail Status Display Change**

Pressing the Outline/Detail Status Display button switches the [System Status Setting] window display between Outline and Detail.

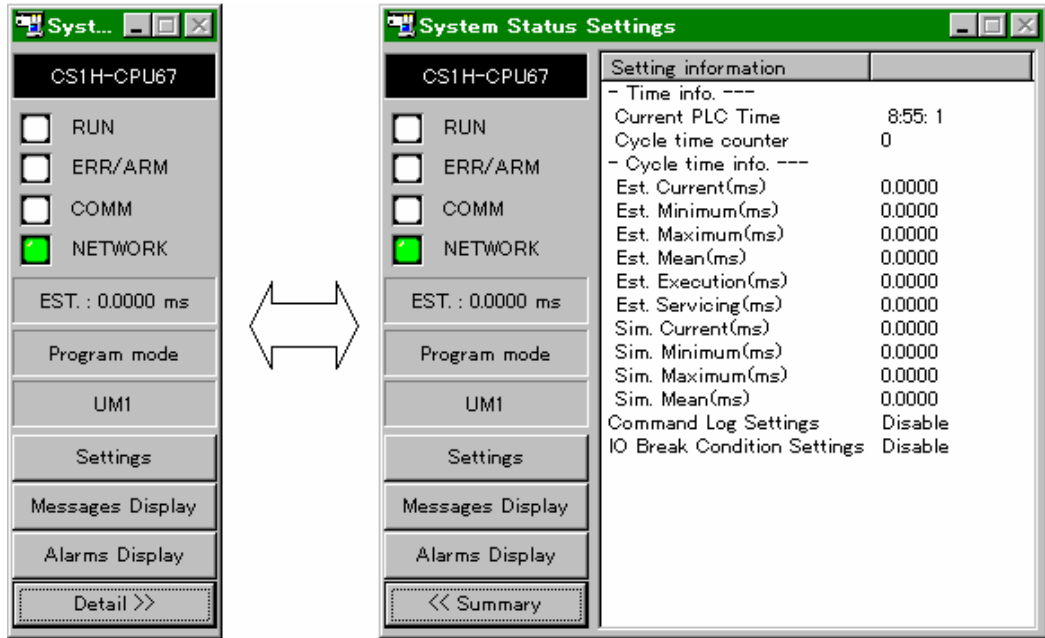

Outline display mode

Detail display mode

**Displayed Items in the Detail Status Display.**

Name		Function
Time in-format ion	Current PLC Time	Display current PLC time. The time may be different from that of the computer as they are independent each other.
	Cycle time counter	Display the cycle time counter.
Cycle time in-format ion	Virtual Cycle Time (Virtual time)	Display the values of present, minimum, maximum, and average (recent 8 times) virtual cycle times. (unit: ms)
	Virtual Ladder Diagram Execution Time	Display the present value of the virtual execution time only for UM1 program. (unit: ms)
	Virtual Time for Peripheral Servicing	Display the virtual value of peripheral servicing time including overseeing and I/O refreshing. (unit: ms)
	Computer Cycle Time (Computer time)	Display the present, minimum, maximum, and average (recent 8 times) values of computer cycle times
Command Log Settings		Yes/No of Command log settings presence
I/O Break Condition Settings		Yes/No of I/O break condition settings presence

### 3-7-2 Setting Menu of System Status Setting

Selecting the [Settings] button in the [System Status Setting] window will display the [Settings] menu. The [Settings] menu sets operation environment for the CX-Simulator. The [Settings] menu provides the following eight items to set various operation environments.

Name	Function
PLC Selection	Create a new PLC (the PLC Setting wizard) and select an existing PLC. Refer to <i>3-5 Creating a New PLC</i> for the details.
Register PLC Unit	Set the Unit for mounting to the PLC.
Network Communications Setting	Set for the Network Communications Unit. Refer to <i>6-2 Network Communications Settings</i> for details.
Serial Communications Setting	Set for the Serial communications Unit. Refer to <i>5-2 Serial Communications Settings</i> for details.
UM Setting	Change the UM setting.
PLC Clock Setting	Set the cycle time mode, the interval for continuous run, and others.
PLC Operation Setting	Set WDT Disable, DIP switches, and others.
PLC Initializing	Initialize the IO memory of the PLC.

**Note** Changing the node address of the communications unit in the [Network Communications Setting] will restart the Ladder Engine. Restarting the Ladder Engine will clear the I/O memory areas according to the PLC Setup and read the Autoexec file automatically.

### 3-7-3 Register PLC Unit

The unit selection performed in the [PLC Setup] wizard can be done again in the [Register PLC Unit] window.

- 1,2,3... 1. Selecting [Register PLC Unit] in the [System Status Setting][Settings] menu will display the [Register PLC Unit] window.

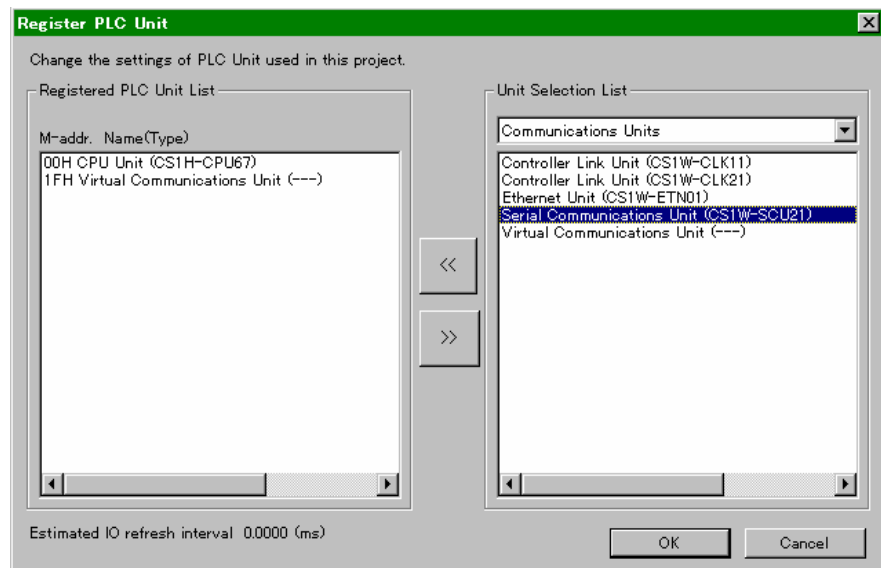

**Note** Refer to 3-5 *Creating a New PLC* for the operation in the [Register PLC Unit] window.

2. Click the [OK] button when the unit registration is completed. Changing the Unit configuration will display the Restart message of the Ladder Engine.

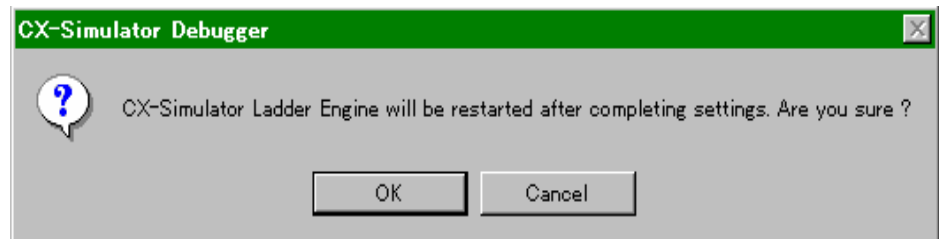

3. Click the [OK] button to restart. Clicking the [Cancel] button will return to the [Register PLC Unit] window.

**Note** Restarting the Ladder Engine will clear the I/O memory areas according to the PLC Setup and read the Autoexec file automatically.

### 3-7-4 UM Settings

The [UM Settings] window allows to set for the UM to store a ladder diagram. Unlike an actual PLC, the CX-Simulator has two program areas: (1) the program area for applications (UM1) where the ladder diagram to be simulated is stored and (2) the one for debugging (UM2) where the ladder diagram generating virtual external outputs.

- 1,2,3... 1. Selecting [UM Settings] in the [System Status Setting] | [Settings] menu will display the [UM Settings] window.

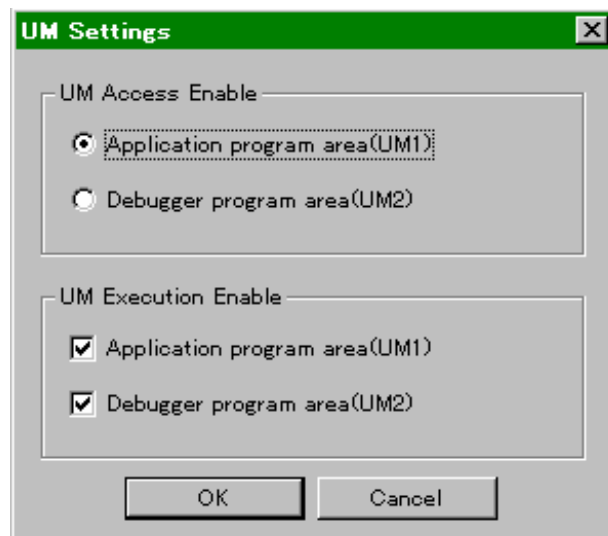

- UM Access Enable Set the UM for downloading/uploading and editing online by the CX-Programmer.
- UM Execution Enable Set whether to execute programs on the UM (enable) or not. Disabling both of UM1 and UM2 simultaneously is not possible.
- OK Save the current settings and exit the window.
- Cancel Discard the current settings and exit the window.

2. Click the [OK] button when UM setting is completed.

**Note** Refer to *8 Debugging Using Virtual External Inputs* for how to use the UM2.

### 3-7-5 PLC Clock Settings

The [PLC Clock Settings] window allows to set the clock-related PLC operation.

- 1,2,3... 1. Selecting [PLC Clock Settings] in the [System Status Setting] | [Settings] menu will display the [PLC Clock Settings] window.

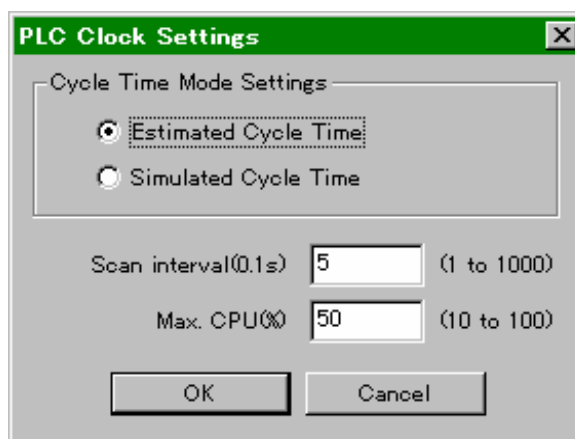

- **Cycle Time Mode Settings** Specify in which mode to display when monitoring the cycle time.
  - **Estimated Cycle Time:** Virtually estimated cycle time in the actual PLC.
  - **Simulated Cycle Time:** The elapsed time in the actual computer.
- **Scan interval** Specify the execution interval for Continuous step run and Continuous scan run in the unit of 0.1 seconds.
- **Max. CPU** Represent maximum CPU occupancy where the Ladder Engine occupies CPU in the computer. Exceeding the maximum occupancy causes Wait to be added in the cycle process automatically. (The initial value is 60%.)
- **OK** Save the current setting and exit the window.
- **Cancel** Discard the current setting and exit the window.

2. Click the [OK] button when setting is completed.

### 3-7-6 PLC Operation Settings

The [PLC Operation Settings] window allows to set for PLC operation.

- 1,2,3... 1. Selecting [PLC Operation Settings] in the [System Status Setting] | [Settings] menu will display [PLC Operation Settings] window.

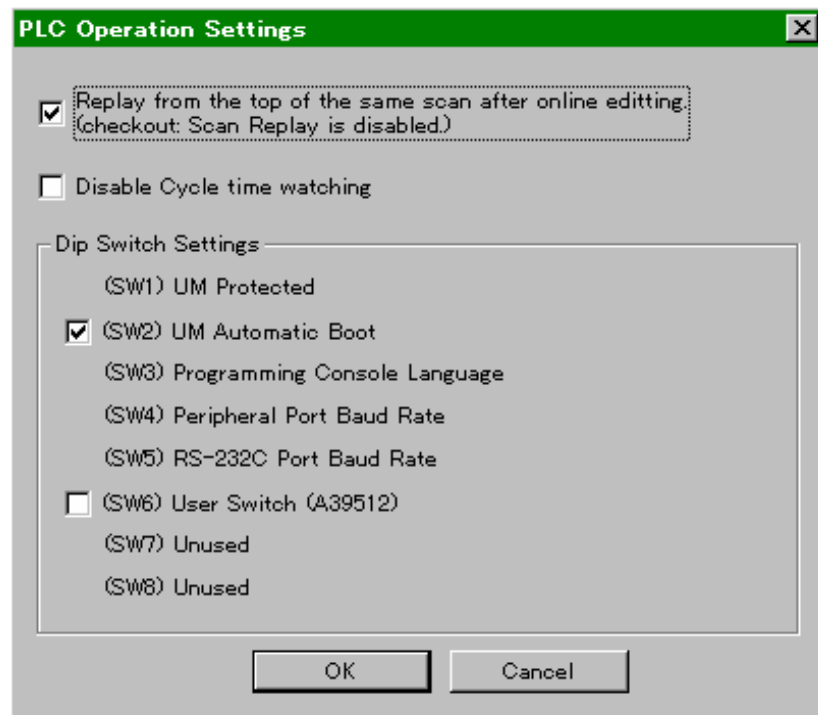

- **Replay from the top of the same scan after online...** Set whether or not to enable online edit when Scan Replay/Step Run.
- **Disable Cycle time watching** Disable the watchdog timer (WDT). The Watch Cycle Time in the PLC Setup and the WDT instruction setting are disabled. When disabled, a CPU error will not occur even if the cycle time exceeds the setting.
- **DIP Switch Settings** Set the equivalent setting to the DIP switches of the CPU Unit.
- **UM Automatic Boot** Set to read Autoexec file automatically when the power turns ON (When the Ladder Engine is started.).
- **User Switch** Set the DIP Switch (A39512) for User-customization.
- **OK** Save the current settings and exit the window.
- **Cancel** Discard the current settings and exit the window.

2. Click the [OK] button when setting is completed.

**Note** Invalid [Enable online edit when Scan Replay/Step Run] makes impossible to use the Scan Replay function. Also, online editing during Step Run automatically enters PROGRAM mode. (When valid, Scan Replay will automatically be performed.) Invalid [Enable online edit when Scan Replay/Step Run] improves the process speed of one scan than when valid. This setting is effective when debugging a large-scale program with the virtual external input.

### 3-7-7 Initializing PLC

Initialize the I/O memory of the Ladder Engine.

- 1,2,3... 1. Select [Initialize PLC] in the [System Status Setting] | [Settings] menu.
2. The following dialog box will be displayed before initialization.

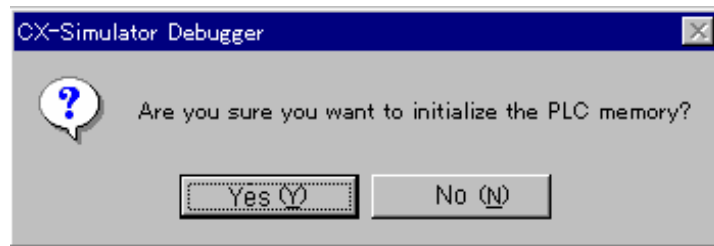

- Yes Initialize the following I/O memory areas.
  - CIO
  - W
  - DM
  - EM
- No Close the dialog box without initializing the memory.

3. Clicking the [OK] button will initialize the memory.

### 3-7-8 Message Display Window

The Message Display window displays the display contents of message/error display instructions as messages. Also, send contents of serial/ network communications instructions are displayed (only when "Message" is specified in the communications settings).

#### Message/Error Display Instructions

Instruction	Func. No.	Message
MSG	046	Occurrence time (cycle counter): Instruction(Message No.)[Display data]
FAL	006	Occurrence time (cycle counter): Instruction(FAL No.)[Display data]
FALS	007	Occurrence time (cycle counter): Instruction(FAL No.)[Display data]

**Note** The same message (cycle counter and the message No. are the same) is not displayed.

**Serial/Network Communications Instructions**

Instruction	Func. No.	Message					
		(1)	(2)	(3)	(4)	(5)	(6)
SEND	090	Occurrence time	Cycle counter	Network address, node address, unit address	Instruction	FINS command size	FINS command
RECV	098	Occurrence time	Cycle counter	Network address, node address, unit address	Instruction	FINS command size	FINS command
CMND	490	Occurrence time	Cycle counter	Network address, node address, unit address	Instruction	FINS command size	FINS command

Instruction	Func. No.	Message
TXD	236	Occurrence time (cycle counter): Instruction (Data length) [Send data]
RXD	235	Occurrence time (cycle counter): Instruction
STUP	237	Occurrence time (cycle counter): Instruction (Data length) [Setting data]

**Note** If a non-display character is included for the TXD instruction, it will be displayed in a hexadecimal value. (e.g. CR+LF as <0D><0A>)

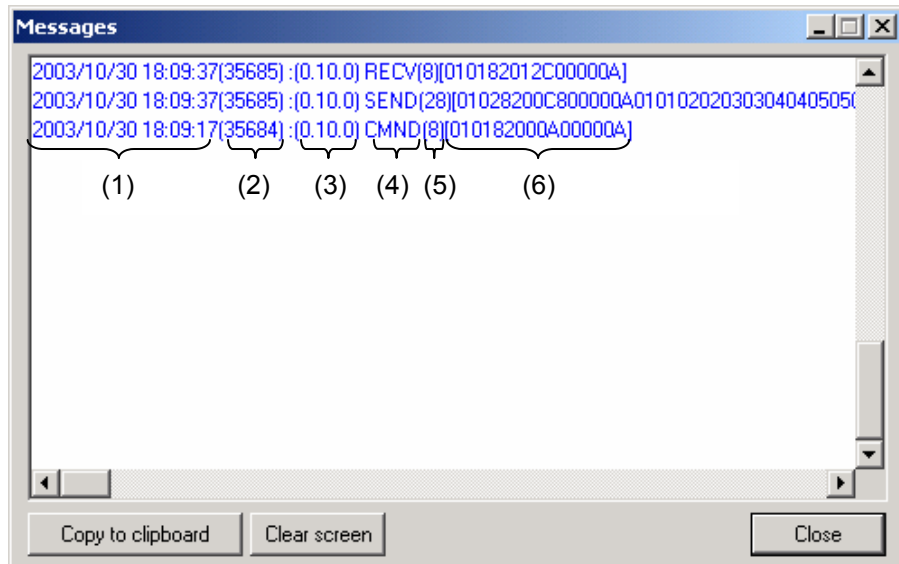

- Copy to clipboard  
The contents of the display buffer in the Message Display window will be copied to the clipboard.
- Clear screen  
Clear the display and its buffer.
- Close  
Exit the Message Display window.

**3-7-9 Alarm Display**

Start an alarm display application program to display the alarm history.

**Note** Refer to each online help, etc. for how to use the memo pad, or an alarm display application program.



### 3-8 Connecting to the CX-Programmer Version 2.1 or Lower

The CX-Programmer is connected to the Virtual CPU Unit in the Ladder Engine via FinsGateway. Therefore, the Virtual Communications Unit of FinsGateway must be started with the [Connect] operation to connect the CX-Programmer with the Virtual CPU Unit.

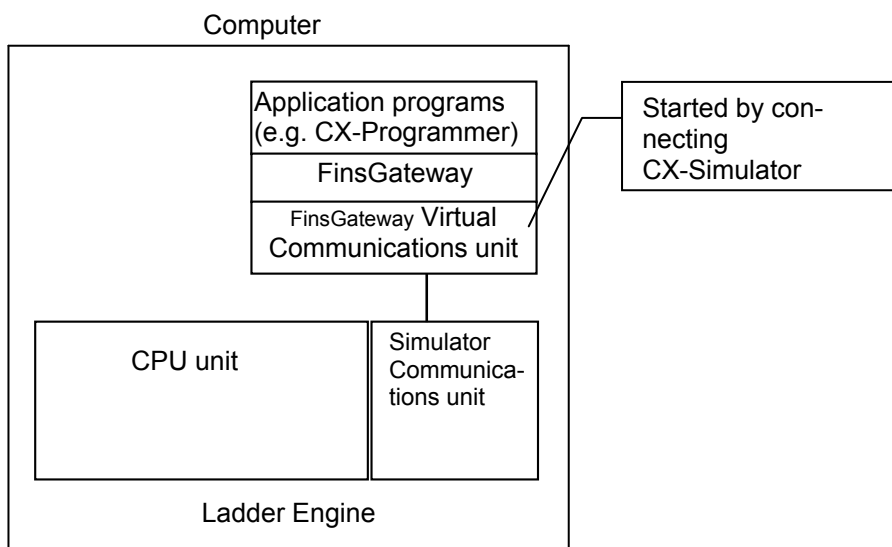

This section describes the procedure for connecting the CX-Programmer version 2.1 or lower with the CPU Unit in the Ladder Engine of the CX-Simulator. Application programs other than the CX-Programmer can be connected in the similar way.

With CX-Programmer version 3.0 or higher, the CX-Programmer can be connected to the Virtual CPU Unit in the Ladder Engine by selecting the [Auto Online Function] from the [PLC] menu of the CX-Programmer.

### 3-8-1 Work CX-Simulator Window

#### Names and Functions

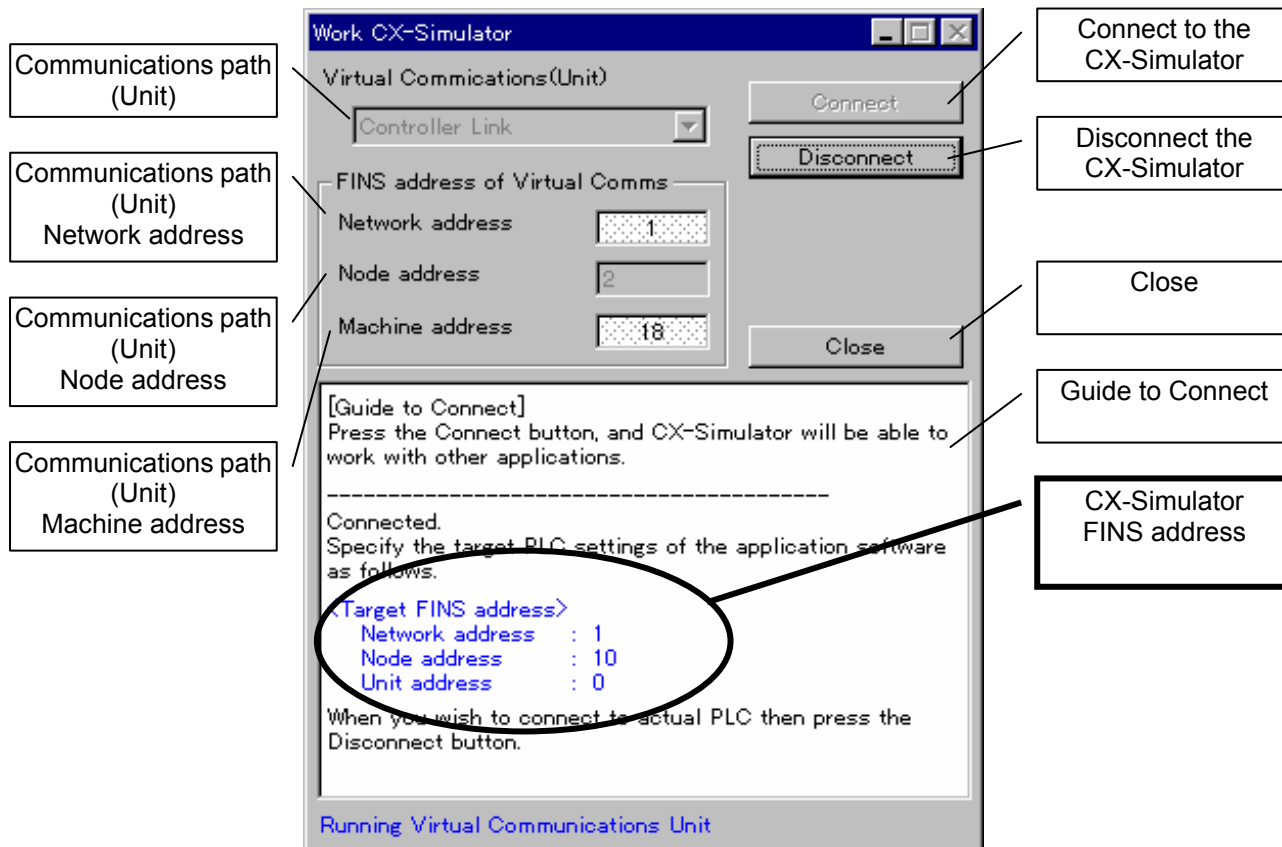

- Network address

Select a FinsGateway Communications Unit for connecting the Ladder Engine of the CX-Simulator with the CX-Programmer.

- Node address

Display the FINS Address for FinsGateway Communications Unit selected by the target Communications Unit. Setting only Node address is also possible.

- Machine address

Start the FinsGateway Communications Unit to connect the Ladder Engine to the CX-Programmer.

Connecting to the CX-Simulator will bring the CX-Simulator to the following.

- The FinsGateway Communications Unit is started.
- The routing tables for FinsGateway and the Ladder Engine are overwritten.

The Serial Communications Server is started following the Serial comm. Settings in the [Serial Communications Settings] window.

- Disconnect Exit the FinsGateway Communications Unit started when connecting to the CX-Simulator and return to the status before the startup. Disconnecting the CX-Simulator will bring the CX-Simulator to the following.
  - The FinsGateway Communications Unit stops.
  - Restore the routing table of FinsGateway to the original status.
  - The Serial Communications Server stops.
  - The mode will be in PROGRAM if the Ladder Engine is running.
- Guide to Connect Display the settings for connecting with the CX-Simulator.
- Close Exit the window with the present settings.

**Note** Correct the Node address of FinsGateway Communications Unit only if it overlaps with the node address of the Network Communications Unit when connecting to the CX-Simulator.

### 3-8-2 How to Connect with CX-Programmer

This section explains how to connect the CX-Simulator with the CX-Programmer.

- 1,2,3... 1. Start the CX-Simulator and select a PLC data folder needed for debugging application programs. The windows for [Work CX-Simulator], [CX-Simulator Debug Console], and [System Status Setting] are displayed.
2. Press the [Connect] button in the [Work CX-Simulator] window. The FINS Address to be set to the CX-Programmer will be displayed in the Guide to Connect.

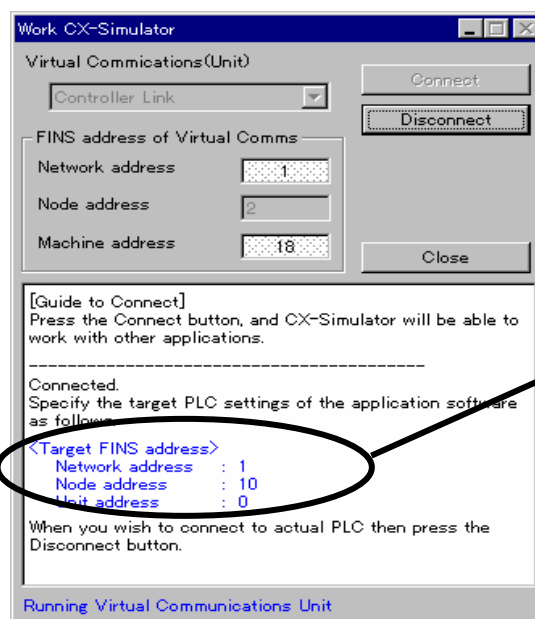

FINS address to be set to the CX-Programmer

3. Register the FINS address displayed in the Guide to Connect to the CX-Programmer. Double-click the PLC name in the Project Tree of the CX-Programmer to display the [Change PLC] window.

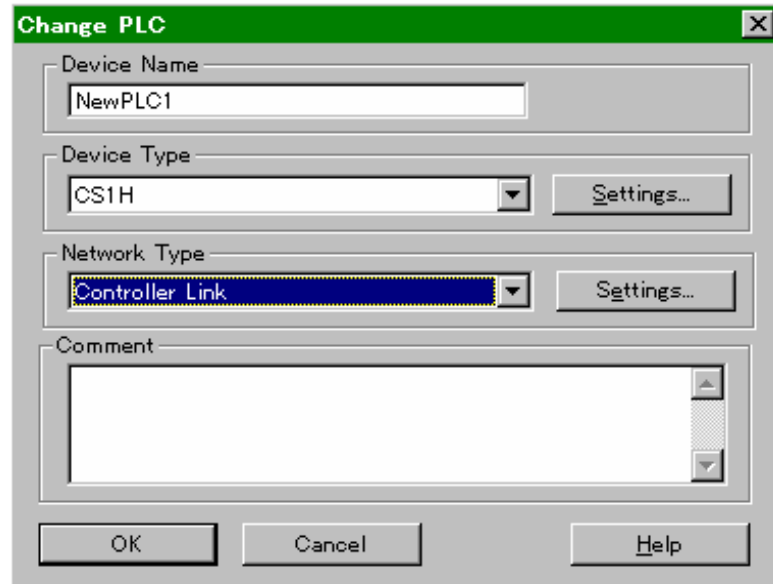

4. Change the [Network Type] to the network type selected by the target Communications Unit in the [Work CX-Simulator] window. Pressing the [Settings] button of the [Network Type] will display the [Network Settings] window.

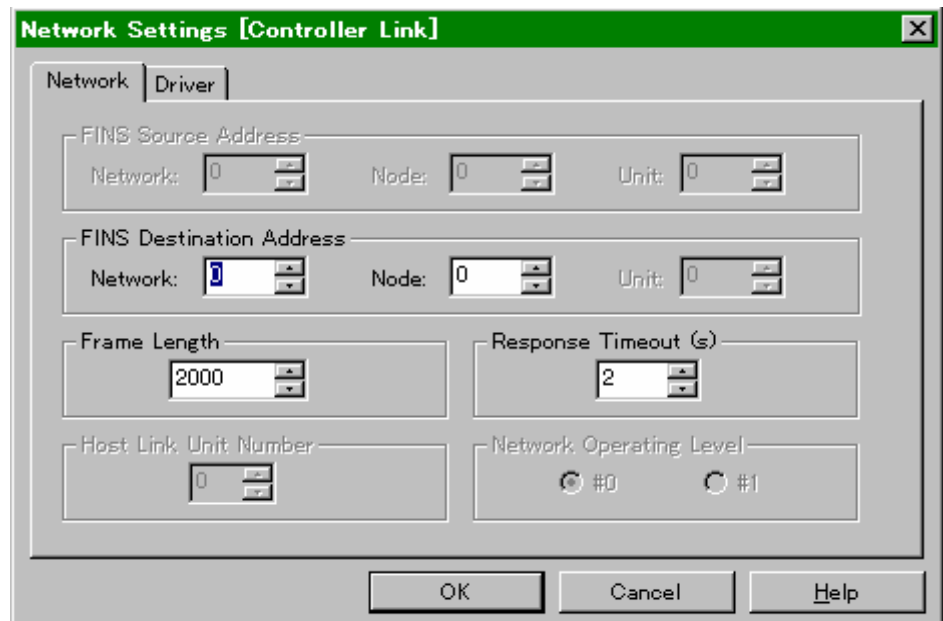

5. Change the settings of [Network] and [Node] for [FINS Destination Address] to the network address and the node address for the FINS address displayed in the Guide to Connect.
  - The routing table for FinsGateway must be changed if the Network address is to be changed.

- Note**
1. Do not change the unit address for the FinsGateway Communications Unit with FinsGateway setting tool, etc. Changing the unit address may cause the [Connect] operation to fail.
  2. Do not set items to the local network table when setting the routing table to the CX-Simulator. The local network table will automatically be changed when [Connect] is executed. If communications with the Ladder Engine can not be executed after setting the routing table, [Disconnect] and then [Connect] again.
  3. If a new FinsGateway Communications Unit with the same name is started by the FinsGateway service manager, etc. during [Connect], the new unit will fail to start. The Communications Unit with the same name can not be used simultaneously.
  4. For instructions on changing the routing tables, refer to *Section 3* of the *CX-Integrator Operation Manual (W445)*.

### 3-9 Debug Console Window

#### 3-9-1 Debug Console Window

In the Debug Console window, various debugging operations (e.g. Step Run and Scan Run for the Ladder Engine) are performed.

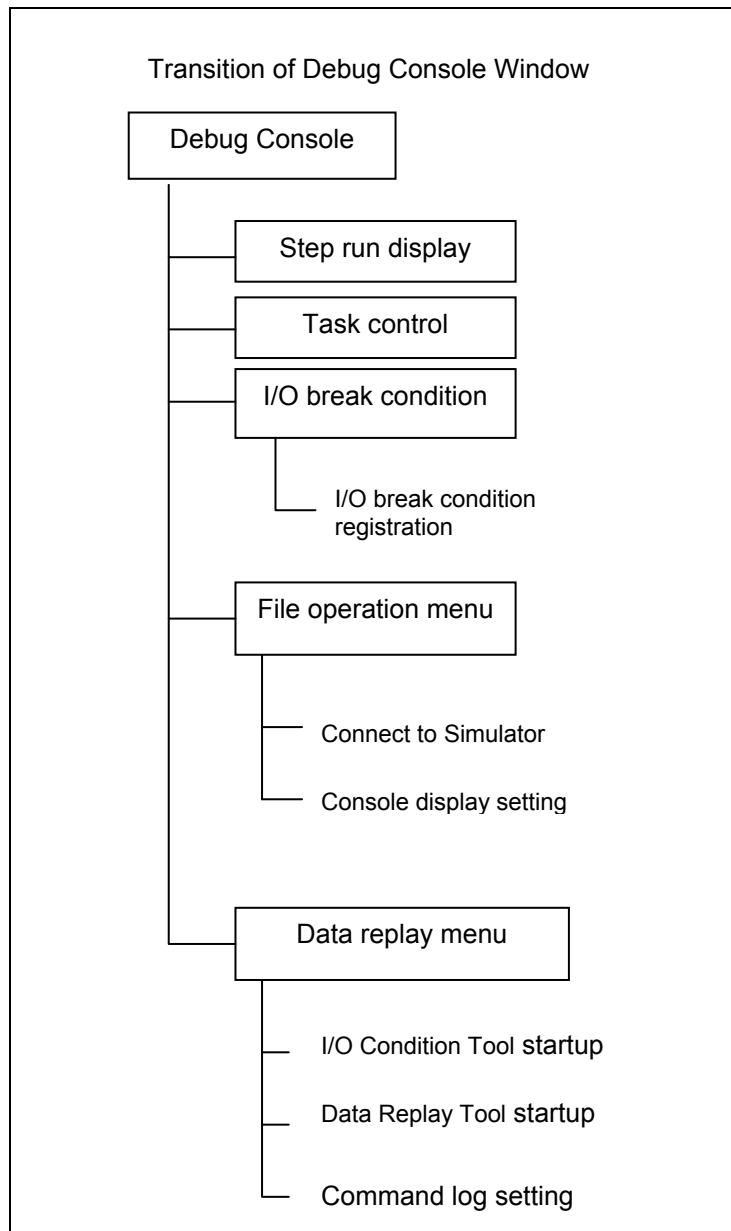

**Names and Functions**



Name	Function
Title bar	The title is displayed.
Main menu	Select a menu.
Toolbar	Click an icon to select a function.

**Icons on the Toolbar**

**Icons for Execution Operation**

Name	Function
Run (Monitor mode)	Execute Scan continuously.
Stop (Program mode)	Stop the execution. The operation mode for the Ladder Engine will become PROGRAM automatically.
Pause	Pause the execution. The execution can be resumed in each execution mode.
Step Run	Process each step of the mnemonic codes.
Continuous Step Run	Execute Step Run at a fixed interval continuously.
Scan Run	Execute a ladder diagram for a single scan. If Scan Run is executed during Step Run, the program will be executed to its end.
Continuous Scan Run	Execute Scan Run at a fixed interval continuously.
Scan Replay	Return the I/O memory status to the one before the scan started during Step Run. The program counter is also cleared.
Reset	Reset the hardware and perform the Startup procedure. The power interrupt task is started.

**Note** Refer to 4-2 Debugging Operation for each execution operation.

**The Icons for Debugging Operation**

Name	Function
Show Step Run	Display the Step Run window.
Task Control	Display the Task Control window.
I/O Break Condition Setting	Display the I/O Break Condition Setting window.

**Note** Refer to 4 Debugging Programs for each operation.

**Contents of Main Menu**

Name	Function
File	Display the File menu.
Replay	Display the Data Replay menu.
Help	Display the Help information and the version.

### 3-9-2 Menu List of CX-Simulator Debug Console

The following shows the function list of the main menu and submenu in the [CX-Simulator Debug Console].

Main Menu	Submenu		Shortcut	Function
File	Read all			Read the settings "saved all."
	Save all			Save the I/O memory of the Ladder Engine and the present settings of the Debugger to the specified file.
	Work CX-Simulator			Allow the CX-Simulator to participate into the network. Refer to 3-8 <i>Connecting to the CX-Programmer Version 2.1 or Lower</i> for details.
	Console Display Settings			Change the display settings of the Debug Console window.
	Exit system			Exit the CX-Simulator.
Replay	IO Condition			Start the I/O Condition Operation Tool.
	Data Replay			Set for Data Replay and start the Data Replay Tool.
	Command log	Start		Start the Command log with the present settings.
		Stop		Stop the Command log.
		Configura- tion		Set for the Command log.
View Log			Display the contents of Command log with the Memo Pad.	
Help	Help			Display Help Contents.
	Help Index			Search the Index.
	About			Display the version information of the CX-Simulator.



### 3-9-3 Outline of Basic Operation for Debug Console Menu

This section explains the following basic menu operation of the CX-Simulator.

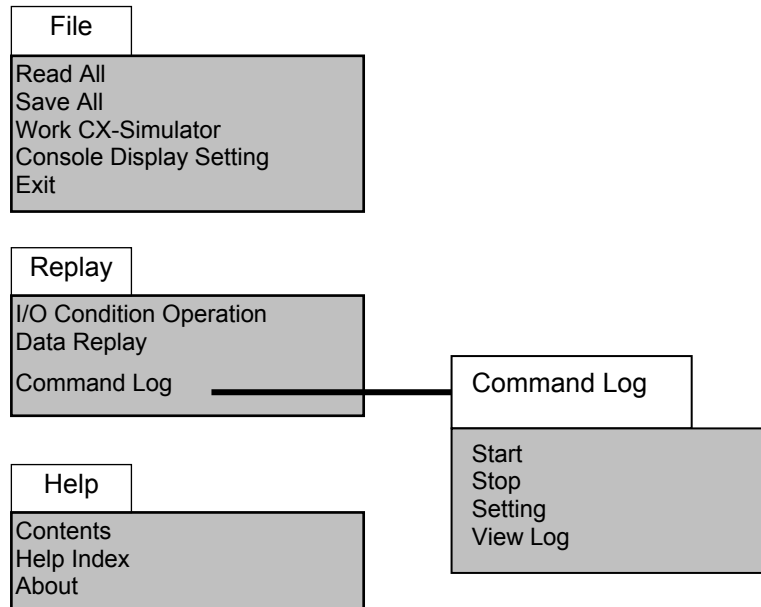

**Note** The menus above may grayed-out depending on the function selected. The gray-displayed menu can not be used during the function execution.

The following explains the basic operation by the menu.

### 3-9-4 [File] Menu

This section explains how to operate the sub-menus in the [File] menu.

#### [Read all]

Open the [Save all] file.

- 1,2,3... 1.Select [Read all] in the [File] menu.

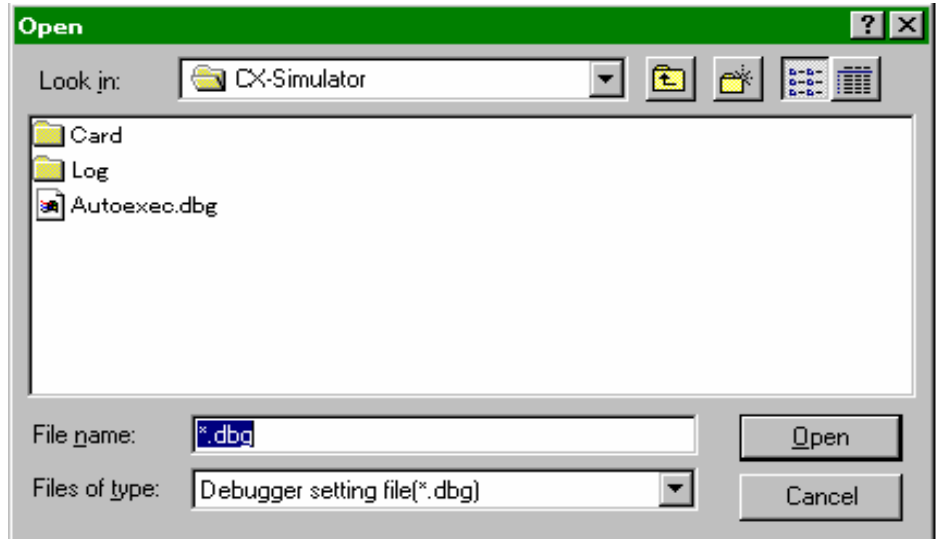

- Look in                    The PLC data folder will be displayed in default. Specify the folder after pressing the drop-down list to move to the other drive and folder.
- File name                Clicking the file name displayed in the [File name] box will display the file name. Alternatively input the file name of the Save-all file.
- Files of type            Select the extension to specify the type of file displayed in the [File name] box.
- Open                     Pressing this button after selecting the Save-all file will read the file.
- Cancel                  Cancel reading the Save-all file and close the dialog box.

2.Select the Save-all file and then click [Open] button.

**Note** In [Read all], the Debugger Setting File (.dbg) will be specified. Actually, however, the I/O memory file (.dat) that has the same name as the Debugger Setting File (+ serial number) will also be read.

**[Save All]**

Create the Save-all file.

1,2,3... 1. Selecting the [Save all] in the [File] will display the following dialog box.

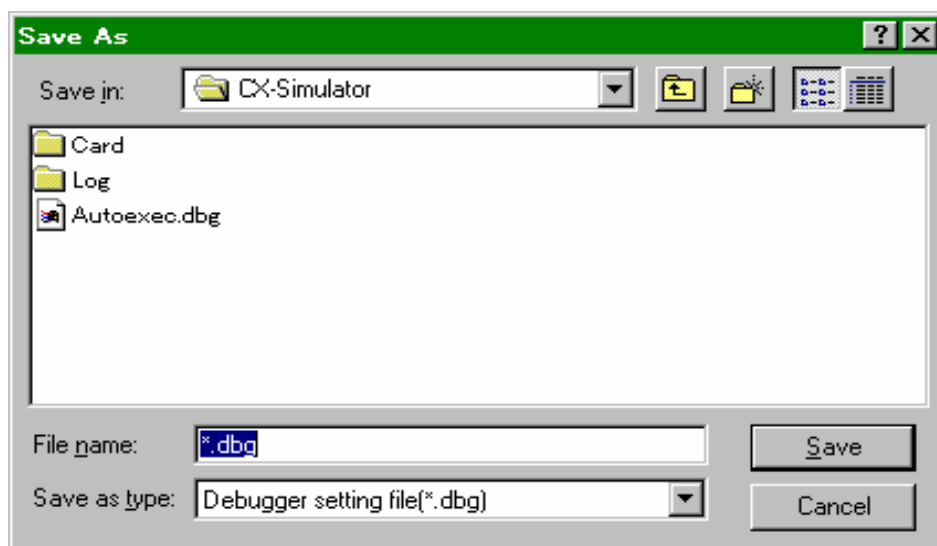

- Save in            The PLC data folder will be displayed in default. Specify the folder after pressing the dropdown list to save into the other drive or folder.
- File name        Name a Save-all file.
- Save as type    Select an extension and specify the type of file displayed in the [File name] box.
- Save             Press this button when the file name and the folder for save are determined.
- Cancel          Cancel saving the file and close the dialog box.

2. Select a drive and folder for Save-all

3. Input a file name in the [File name] box or select a file name from the list.

4. Click the [Save] button to save the Save-all file.

**Note** The file will be saved in the format specified with the file type even when it is specified with an extension. Actually the I/O memory file (.dat) that has the same name as the Debugger Setting File (+ serial number) will also be saved.

**[Work CX-Simulator]**

Refer to 3-8 *Connecting with the CX-Programmer Version 2.1 or Lower* for Work CX-Simulator.

**[Console Display Settings]**

Console Display Settings sets for the CX-Simulator display.

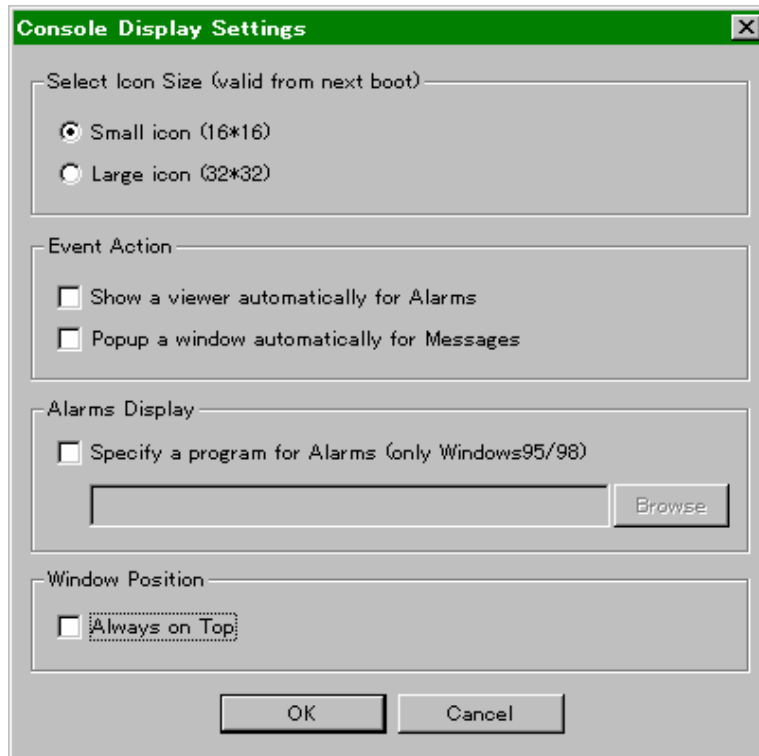

- **Select Icon Size**      Select the icon size for the CX-Simulator Debug Console, which will be reflected at the next startup.
  
- **Event Action**        Set for the event action. Checking [Show a viewer automatically for Alarms] will start the Alarm Display program when an alarm occurs. Checking [Popup a window automatically for Messages] will automatically display the Messages window when its contents are updated.
  
- **Alarms Display**      The alarm display is performed only by the event viewer (OS standard).
  
- **Window Position**     Checking [Always on Top] will display each window for the Debugger in front.
  
- **OK**                      Save the present settings and exit the window.
  
- **Cancel**                 Discard the present settings and exit the window.

**[Exit system]**

Exit from the CX-Simulator.

- 1,2,3... 1. Select [Exit system] in [File] to display the exit message.

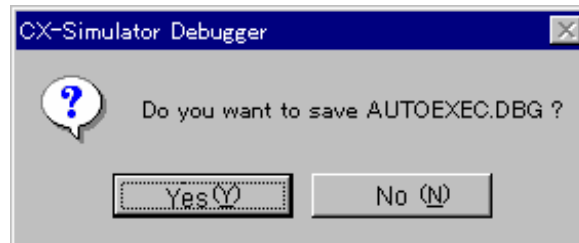

- Yes      Disconnect the CX-Simulator to exit the application
  - No      Close the dialog box to cancel exiting the CX-Simulator.
2. Clicking the [Yes] button will display the dialog box for saving the Debugger setting.
3. Clicking the [Yes] button will save the current setting to exit the CX-Simulator.
4. Attempting to exit without disconnecting the Simulator will display the dialog box below, followed by the [Work CX-Simulator] window.

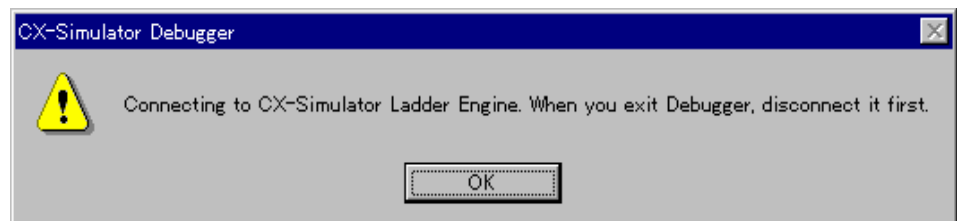

After Disconnect, exit the system again.

### 3-9-5 [Replay] Menu

This section explains how to operate the sub-menu of the [Replay] menu.

#### [IO Condition]

Start the IO Condition tool to display the [Run] window (the startup window for this tool).

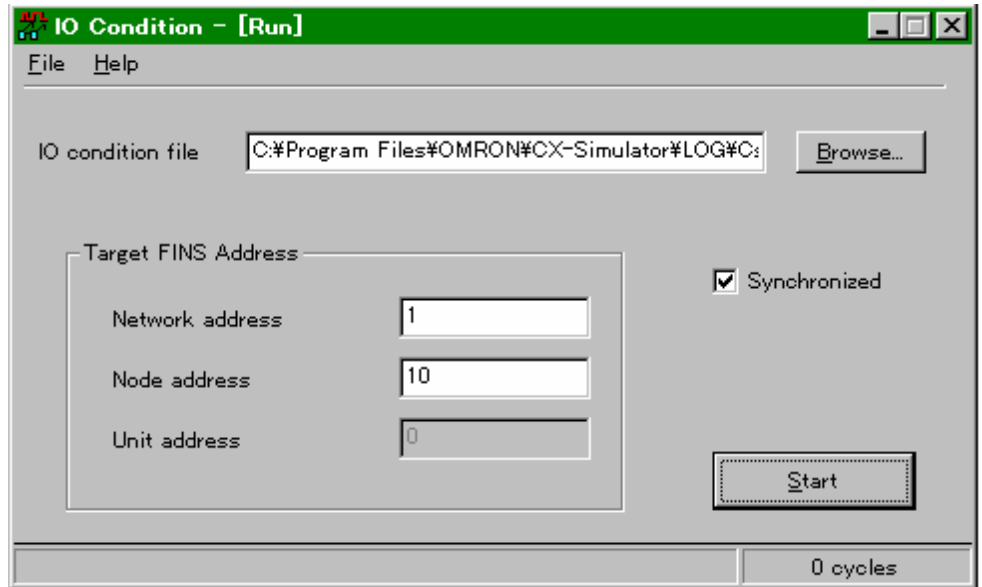

**Note** Refer to *8 Debugging Using Virtual External Inputs* for the details of the I/O Condition tool.

- IO condition file      Input the name of the execution file for I/O Condition. Browsing files with the Browse button is also possible.
- Target FINS Address      Input the destination FINS address for monitoring I/O Condition. The FINS address for the Ladder Engine is displayed as the initial value. Changing it during the execution is not possible.
- Synchronized      Specify whether or not to perform the synchronous process. When in the process, the conditional monitoring will be performed to the Ladder Engine in the unit of a single scan. When in the asynchronous, at a fixed interval.
- Start/Stop button      Pressing the Start button will monitor I/O Condition. The button works as Stop button during execution. When starting, the message box is displayed at the destination. The process will be started after confirmation.
- Status Display      Display the process status on the Status bar.

- Cycle Count Display      Display the cycle increase after starting monitoring. When in asynchronous process, display the count of monitoring operation.
- Destination Model Name      Display the model name of connecting destination in the title.

**File**

- Open      Input the execution file using Browse.
- Start      Monitor the I/O Condition whose execution flag is D in the set execution file. Not selectable if the execution file is not input.
- Stop      Stop I/O condition monitoring. Not selectable unless monitoring is being executed.
- Configuration      Display the I/O Condition Setting window.
- Exit      Exit I/O Condition.

**Help Menu**

- Help Contents      Display Help Contents for Windows
- Help Index      Display Help Index for Windows.
- About      Display the version information.

**Configuration Window**

In the Configuration window, the IO Condition Equation is set. The IO Condition Equation consists of the logical equation (the conditional equation) combining I/O memory conditions to be monitored, the delay time from when the conditional equation holds till when the output equation is executed, and the settings to the I/O memory to be executed after the delay time elapses.

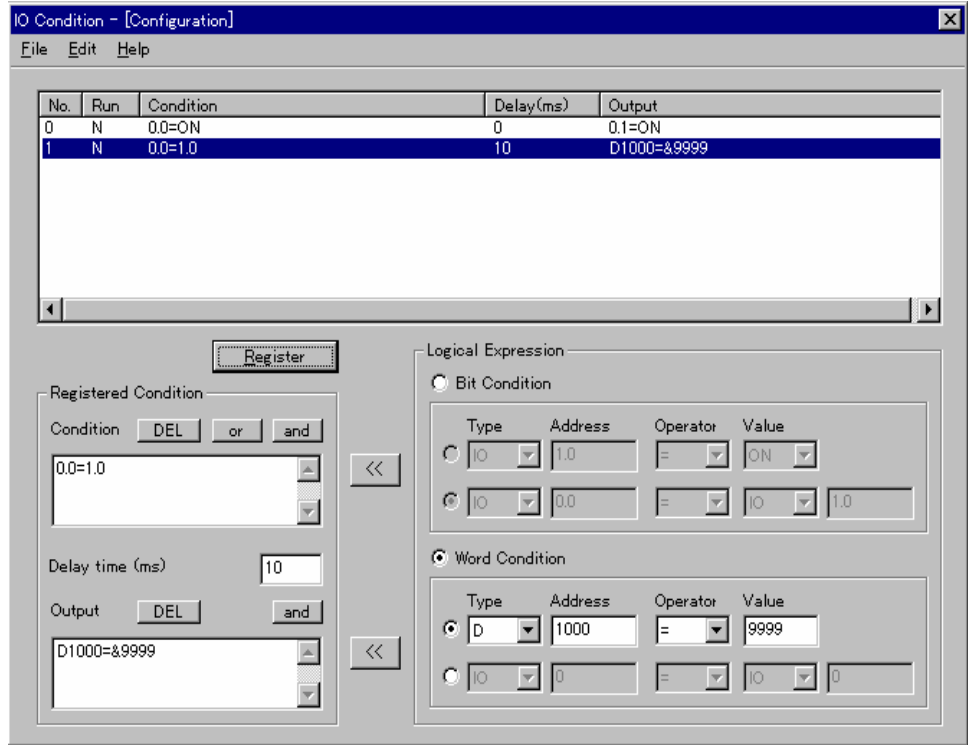

**List of IO Condition Equation**

- Run Flag                      Display whether or not to execute IO Condition (D(o),N(on),E(rror)). When registering the equation, N is set as the initial value. If the contents of the conditional equation and output equation can not be analyzed, E(rror) will occur. Double-clicking with the line selected will switch between D and N.
- Condition                      Display the logical equation combining I/O memory conditions to be monitored.
- Delay                            Display the time (unit: ms) from when the conditional equation holds till when the output equation is executed.
- Output                            Display the logical equation combining operations to be executed when the conditional equation holds.
- Register Button                Register the data set in the registration condition as the IO Condition equation.



**Registered Condition**

- Condition Describe the Conditional Equation to register in the I/O Condition equation. Insert the contents set in the Insert Equation, insert by Logical Operator button, and paste from the clip board are possible.

• DEL button	Delete the contents of the Conditional Equation.
• or button	Insert the character string "or" as a logical operator.
• and button	Insert the character string "and" as a logical operator.
• << button	Insert the contents set in the Insert Equation to the Conditional Equation.

- Delay time Input the delay time (unit: ms) to be registered to the I/O condition Equation.

- Output Describe the Output Equation to be registered in the I/O Condition equation. Insert the contents set in the Insert Equation, insert by [Operator] button, and paste from the clipboard are possible.

• DEL button	Delete the contents of Output Equation.
• and button	Insert the character string "and" as a logical operator.
• << button	Insert the contents set in the Insert Equation.

**Insert Equation**

- Insert Equation Select Select which to insert the Bit Conditional Equation or the Word Conditional Equation
- Bit Conditional Equation Set the Bit Conditional Equation to be inserted to the Conditional/Output Equation.

• Value Select	Select which is the value of Conditional Equation, fixed (upper) or I/O memory (lower).
• Type	Select I/O memory type.
• Address	Input the address of I/O memory type.
• Operation	Select from either = or NOT. Selecting NOT will not reflect the value to the Conditional Equation/Output Equation.
• Value	For "Fixed Value", select ON/OFF as Bit information in the drop down list. For "I/O Memory", set the type and the address.

- Word Conditional Equation Set the Word Conditional Equation to be inserted to the Conditional Equation/Output Equation.

• Value Selection	Select which is the value of Conditional Equation, fixed (upper) or I/O memory (lower).
• Type	Select the I/O memory type.
• Address	Input the address of I/O memory type.
• Operator	Select =, <>, <=, >=, <, >, or NOT as an operator from the drop down list. Selecting NOT will not reflect the value to the Conditional Equation/Output Equation.
• Value	For "Fixed Value", input BCD(0 to 9999) or BIN(0x0 to 0xFFFF). For "I/O memory", set the type and the address.

**File Menu**

- Open Read the I/O Condition file from the File dialog. If some settings are already input in the window, the current input data will be discarded.
- Save If the file already opened by Open in the File menu exists, save the current data to the existing open file. If a file is not open, this selection is not possible.
- Save As Save the present setting data in the File Save dialog box.
- Exit Close the Setting window. (Different from Exit of a tool)

**Edit Menu**

- line Insert Insert specified number of lines just before the line currently selected.
- line Delete Delete the specified lines
- line Copy Copy the specified lines to the clipboard. The data on the clipboard can be used in the commercial spread sheet software.
- Insert copied lines Insert the data on the clipboard to the currently specified line. The line data is evaluated when inserting.

**Help Menu**

- Help Contents Display Help Contents for Windows.
- Help Index Display Help Index for Windows.
- About Display the version information.

Start the [Data Replay Settings] window and then Data Replay Tool using the set file.

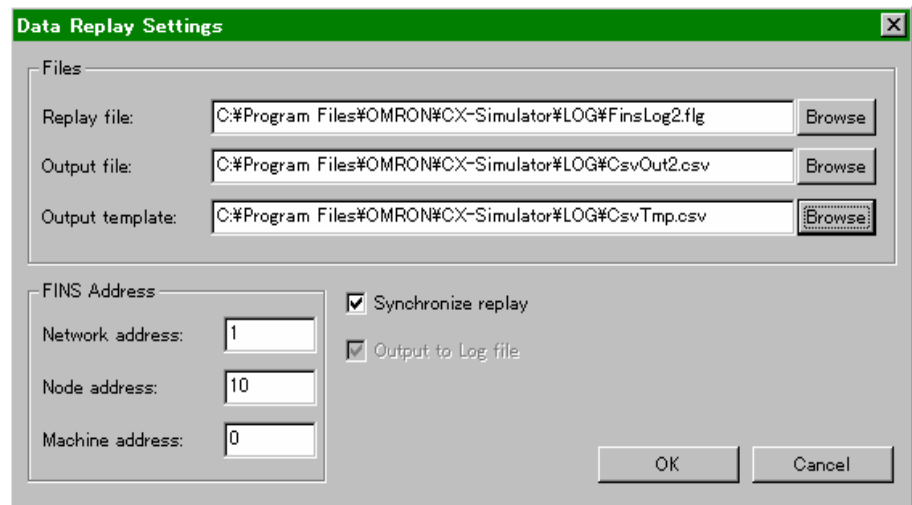

- **Replay file**                      Input the file name to be replayed by Data Replay Tool. The Command Log file (.flg), the data trace data file (.cdt), and the data replay file (.csv) can be replayed.
  
- **Output file**                      Input the file name to output the monitor data corresponding to the replay data to. The format of the output file will be that of the data replay file(.csv).
  
- **Output template**                If the data to be monitored into the output file is set to the other data replay file, the file can be specified as the output template file.
  
- **Browse**                            Select the name of the replay file, output file, and output template file specifying the destination for browsing.
  
- **FINS Address**                    Set the destination FINS address for the data replay. The FINS address for the Ladder Engine is set in default.
  
- **Synchronous replay**          Replay synchronously.
  
- **OK**                                 Start the Data Replay Tool with the present settings.
  
- **Cancel**                            Discard the present settings and exit the window.

**Data Replay Tool**

Data Replay Tool reads the data in the specified input file and set them in sequence as the virtual external input to the Ladder Engine.

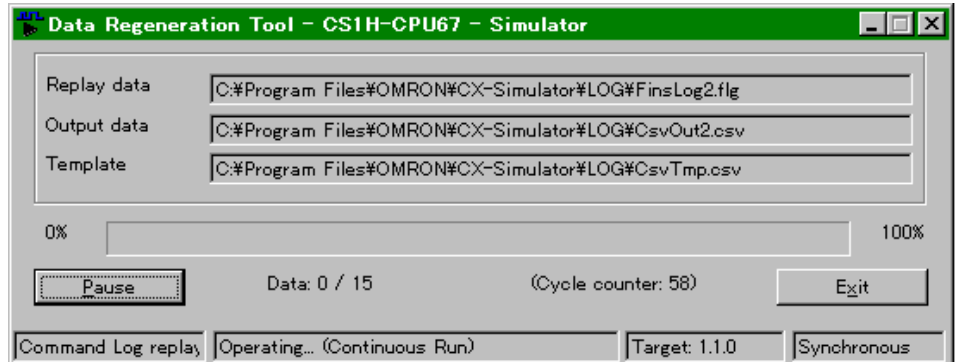

- **Replay data**      Display the replay file set in the [Data Replay Settings] window.
- **Output Data**      Display the output file set in the [Data Replay Settings] window.
- **Template**            Display the output template file set in the [Data Replay Settings] window.
- **Pause**                Pause the data replay. The button works as [Resume] during pausing.
- **Exit**                 Exit the Data Replay Tool forcibly.

**Status Bar**

- **Type**                Display the type of the input data.
- **Operation Status**    Display the operation status of the Data Replay Tool.
- **Destination FINS address for Connection**    Display the destination FINS address for connection where the data is replayed.
- **Synchronous/Asynchronous Display**      Display "[Synchronous]" while the synchronous replay is performed.

**Note** Refer to 8-4 *Running by Virtual External Inputs* for [Data Replay Tool].

**[Command log]**

Display the sub-menu of the Command Log.

**[Command log] | [Start]**

Start the Command Log with the contents of the Command Log Settings. Can not be selected when the Command Log has been started or Command Log Settings are not set.

**[Command log] | [Stop]**

Exit the Command Log. Can not be selected if the Command Log has not been started.

**[Command log] | [Configuration]**

Set the Command log. The Command log saves the CX-Programmer commands with FINS commands.

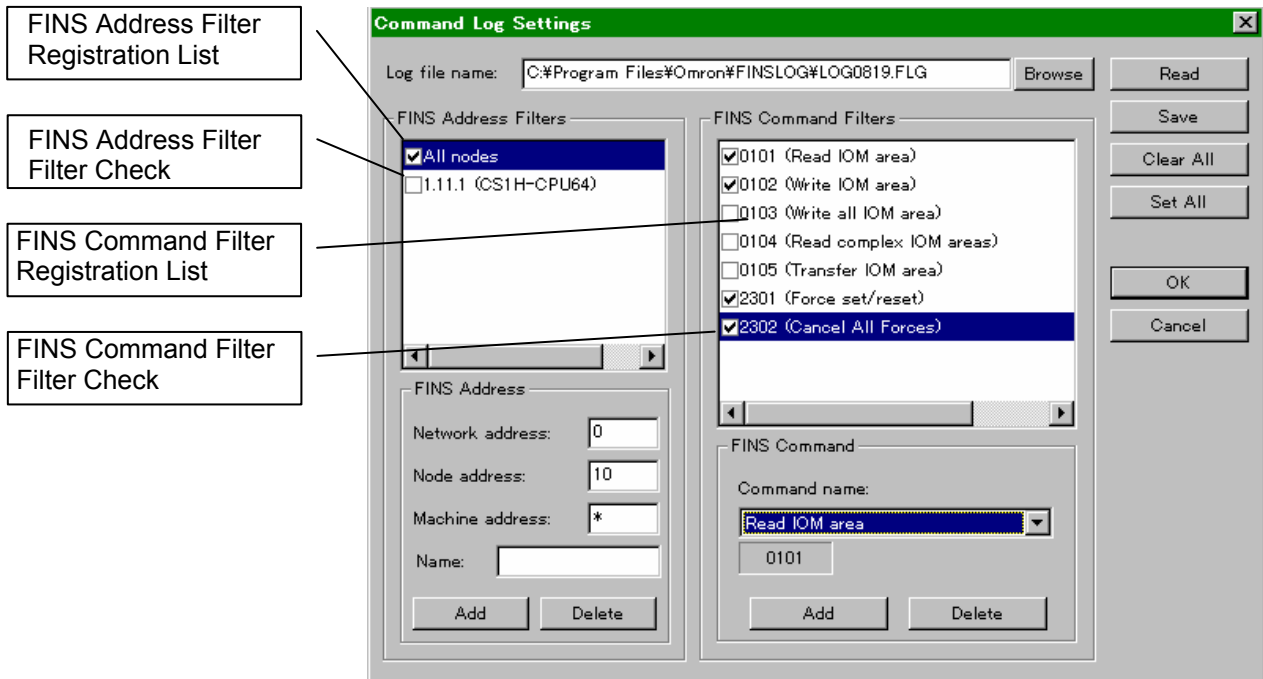

- Log file name      Input the file name for saving the Command Log. If the existing file is specified, the log data will be appended to the bottom of the file.
- Browse              The Log file can be selected by browsing.
- Read                Read the Command Log settings from the file.
- Save                Save the Command Log settings to the file.
- Clear All          Clear the filter check for all of the registered items of the FINS address filter and the FINS command filter.
- Set All             Select the filter check for all of the registered items of the FINS address filter and the FINS command filter.
- OK                 Save the present settings and exit the window.
- Cancel             Discard the present settings and exit the window.

**FINS Address Filters**

- Registration List      Display the FINS address selectable as the FINS address filter. The [All local nodes] shows all FINS addresses in the computer. Usually specify the [All local nodes] as the filter (registered as the initial value and can not be deleted).
- Filter Check          Check here if selecting items in the Registration List.
- Add                      Add the FINS address to the Registration List.
- Delete                  Delete the selected items in the Registration List.
- Network address      Specify the FINS network address to be added to the Registration List. Specifying "\*" will target all of the network addresses.
- Node address         Specify the FINS node address to be added to the Registration List. Specifying "\*" will target all of the node addresses.
- Machine address      Specify the FINS node address to be added to the Registration List. Specifying "\*" will target all of the machine numbers.
- Name                    Specify the name of the FINS address to be added to the Registration List.

**FINS Command Filters**

- The Registration List      Display the filter of the FINS commands selectable as the FINS command filter. When selecting, compare from top of the FINS commands and save the matched commands as the log.
- Filter Check          Check here if selecting the item in the Registration List.
- Add                      Add the filter of the FINS command to the Registration List.
- Delete                  Delete the selected items in the Registration List.
- Command name        Display the list of FINS command filters registered in advance.

**Note** Refer to 8-3 *Generating Virtual External Inputs* for the details of the Command Log setting.

**[Command log] | [View Log]**

Display the contents of the saved Command Log. Display the content of the file set as the log file in the Command log Setting with the Memo Pad (OS standard).

### **3-9-6 [Help] Menu**

This section explains how to operate the sub-menu of the [Help] menu.

#### **[Help Contents]**

Display the Help Contents of the CX-Simulator.

#### **[Help Index]**

Search for the topic in the online help using the keyword.

#### **[About]**

Select [About] in the [Help] menu to display the version information for the CX-Simulator.

- OK                                      Close the [About] dialog box.

**Note** The license information is not displayed when upgrading from CX-Simulator Ver. 1.3 or higher.

### 3-9-7 [Step Run] Window

The Step Run window displays the content of the program area for application programs(UM1) by the task in mnemonic codes and allows to monitor the step transition.

#### Names and Functions

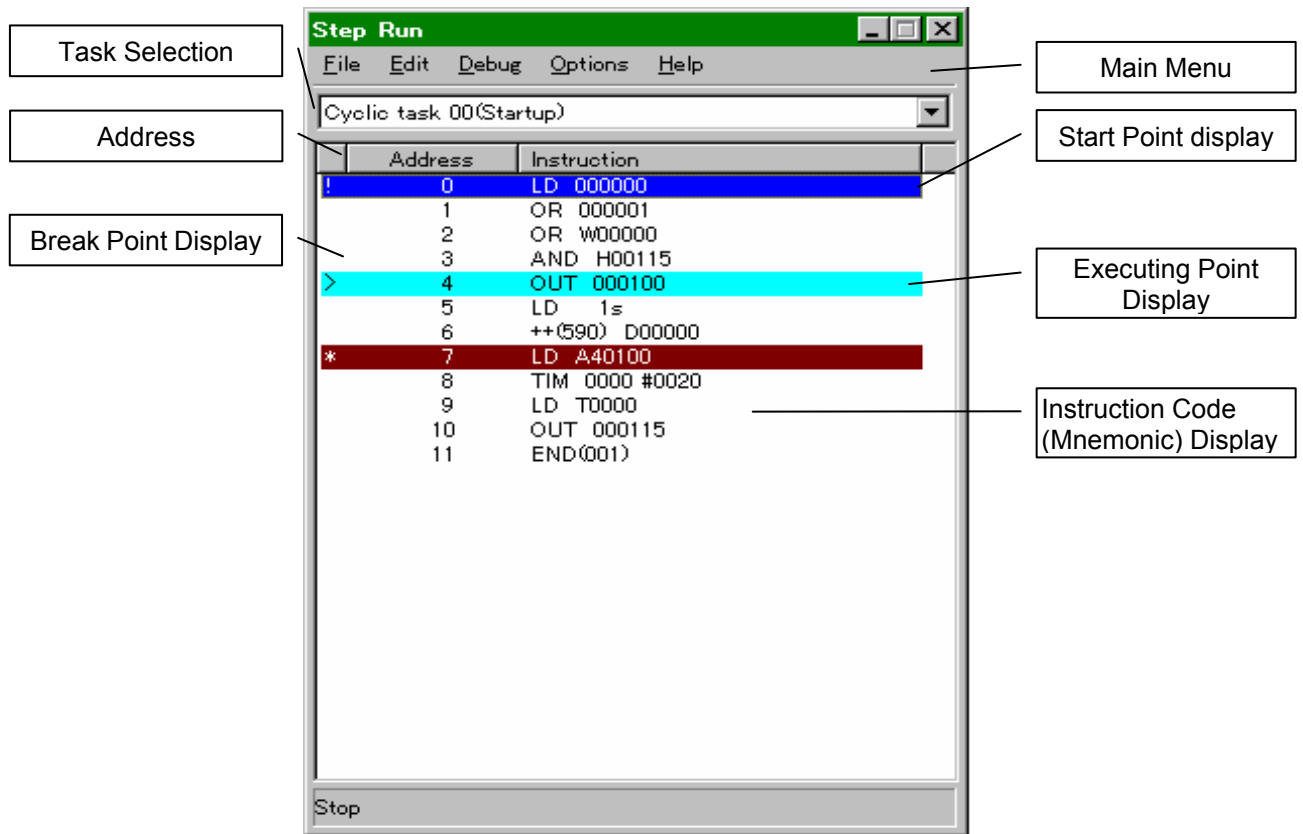

Name	Function
Main Menu	Select a menu.
Task Selection	Select a task to display from the tasks registered in the program.
Address	Display the program address in the task.
Instruction Code (Mnemonic) Display	Display instruction codes and operands.
Break Point Display	Display the break points set in the program.
Executing Point Display	Display the program address presently being executed.
Start Point display	Specify the execution start point.

#### Contents of the Main Menu

Name	Function
File	Display the File menu.
Edit	Display the Edit menu.
Debug	Display the Debug menu.
Options	Display the Option menu.
Help	Display the Help and About.



**Menu List of the Step Run Window**

Main Menu	Submenu	Shortcut	Function
File	Close		Close the Step Run window.
Edit	Copy		Copy the contents of the task being displayed to the clipboard.
	Go to		Jump to the specified program address.
	Go to Top		Jump to the top of the task.
	Go to End		Jump to the bottom of the task.
Debug	Start a start point		Set the start point to the selected step.
	Remove a start point		Reset the start point of the selected step.
	Set a break point		Set the break point to the selected step.
	Clear a break point		Reset the break point of the selected step.
	Clear all break points		Reset all of the break points.
Options	Auto scroll		Set whether or not to scroll automatically.
Help	Help Contents		Display the Help Contents.
	Help Index		Display the Help Index.
	About		Display the version information.

**Content of Pop-up Menu**

Clicking a mnemonic code and right-clicking will display the pop-up menu.

Name	Function
Start point Set	Set the start point to the selected step.
Start point Reset	Reset the start point of the selected step.
Break point Set	Set the break point to the selected point.
Break point Reset	Reset the break point of the selected step.
All Break points Reset	Reset all break points.

**Contents of Step Display**

The [Step Run] window displays the lines distinctively.

Line Display	Background/Color of Character	Line Mark	Remarks
Regular Line	White/Black	None	
Start Point	Blue/White	!	
Break Point	Brown/White	*	
Executing Line	Light Blue/Black	>	
Stop on I/O Break Condition	Magenta/Black	#	
Non-executing State (e.g. interlocked)	Green/Black	>	Step Run with non-execution for IL, JMP, FOR/BREAK, etc.

- Note**
1. In the Step window, the lower part of the table has a priority in display.
  2. Refer to 4-3 Step Run and Break for the details of Step Run.

### 3-9-8 Task Control Window

The Task Control window displays the status of the task in the program area for application programs (UM1).

#### Names and Functions

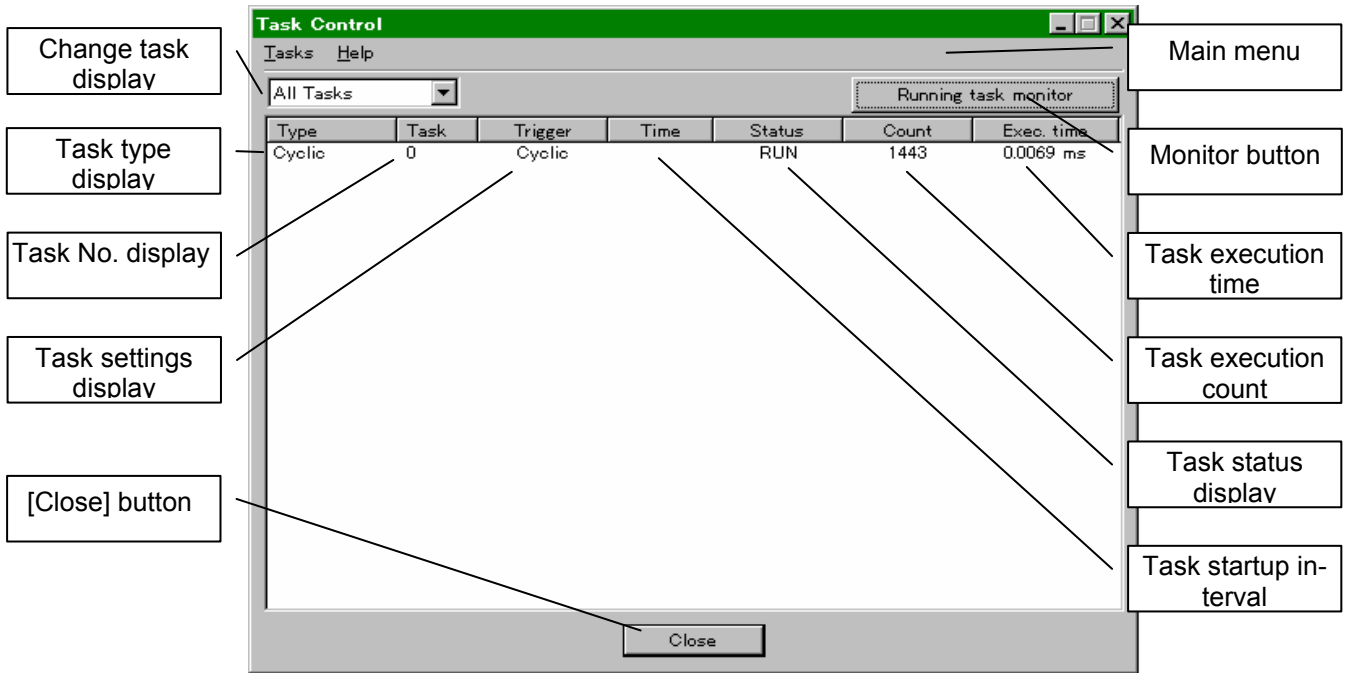

Name	Function
Main menu	Select a menu.
Change task display	Select the task to be displayed from the tasks registered in the program (Cycle, interrupt, or All tasks).
Task type display	Display the task type (Cycle execution task or interrupt task). If multiple interrupt types are set to a single interrupt task, they will be displayed as separate lines.
Task No. display	Display the task No. of cycle tasks and interrupt tasks.
Task settings display	For the cyclic task, display "Cycle." For the interrupt task, display its interrupt type (Power interrupt, scheduled interrupt, I/O interrupt, or External interrupt).
Task startup interval	Display the time (unit: ms) for the clock interrupt task.
Task status display	For a cyclic task, display the execution status (Initial, Ready, Run, or Wait). For an interrupt task, display "Run" if it is being executed and nothing if it is not.
Task execution count	Display the count for each task after the Ladder Engine is started or reset.
Task execution time	Display the time required to execute each task (The latest value, Unit: ms). If an interrupt task is executed while executing the cyclic task, the execution time for the interrupt task is also added. If set as the computer cycle time, the standby time for pausing with Step Run and Scan Run is added, too.
Monitor button	Switch between update (monitoring) and not update (stop monitoring) of the window.
[Close] button	Exit the Task Control window.

**Contents of Menu**

Name	Function
Tasks	Display the task menu.
Help	Display the information on Help and the version.

**Menu List of [Step Run] Window**

Main Menu	Submenu	Shortcut	Function	
Tasks	Cyclic tasks	Run Mode	Turn the selected cyclic task into the execution mode.	
		Wait Mode	Turn the selected cyclic task into the standby mode.	
		Block Run	Execute the selected cyclic task in block. Used in Program mode.	
	Extra cyclic tasks	Start		Start the selected task as an extra cyclic task.
		Stop		Stops the selected task.
	Activate Interrupt Task			In Program mode, execute the selected interrupt task in block. In Monitor/Run mode, an interrupt occurs at the moment and the process moves to the specified interrupt task.
	Copy task data			Copy the list of Task Control being displayed to the clipboard.
	Exit			Close the Task Control window.
Help	Help Contents		Display the Help Contents	
	Help Index		Display the Help Index.	
	About		Display the version information.	

**Content of Pop-up Menu**

Clicking the task line and right-clicking will display the pop-up menu.

Name	Function	
Cyclic Task	Execution Mode	Turn the selected cyclic task to Execution mode.
	Standby Mode	Turn the selected cyclic task to Standby mode.
	Execution in Block	Execute the selected cyclic task in block. Available only in Program mode.
Interrupt Task Startup		In Program mode, execute the selected interrupt task in block. In Monitor/Run mode, an interrupt occurs at the moment and the process moves to the specified interrupt task.
Copy		Copy the list of Task Control being displayed to the clipboard.
Close		Close the Task Control window.

- Note**
1. Block execution of task sets a start point at the top of the task and a break point at the bottom (END line), and operates in the same way as Step Run.
  2. Refer to 4-4 Task Debugging for the details of Task Control.

**3-9-9 I/O Break Condition Settings Window**

I/O Break Condition Setting sets the values of I/O memory with the logical equation and registers the I/O Break Conditional Equation for breaking at the step where the set equation holds.

**Names and Functions**

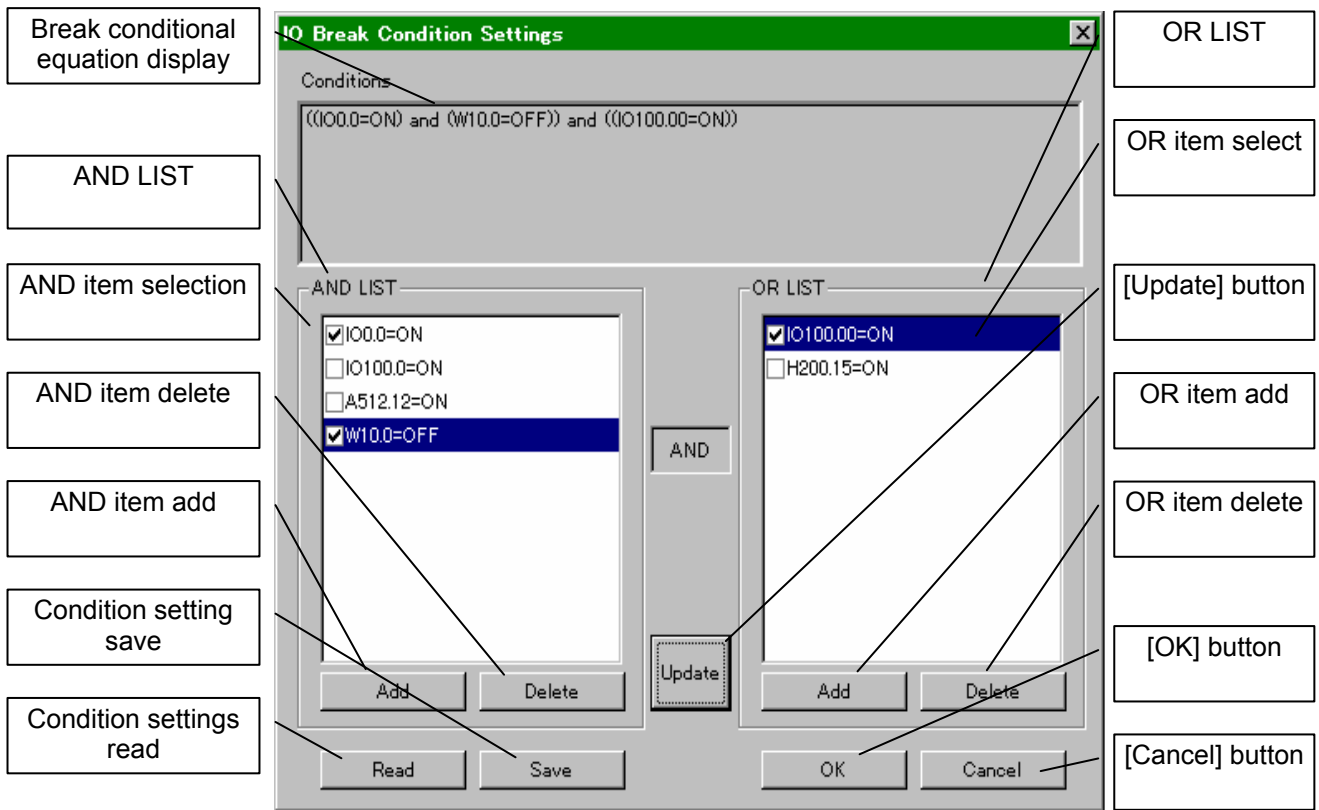

Name		Function
Break conditional equation display		Display the conditions selected in AND LIST and OR LIST as the I/O break conditional equation.
[Update] button		Update the I/O break condition setting expression in the window with the present configuration of AND LIST and OR LIST.
AND LIST	AND item selection	Select the conditions registered in AND LIST with check boxes.
	AND item add	Add conditions set in [Register I/O Break Condition] to AND LIST.
	AND item delete	Delete the selected conditions in AND LIST.
OR LIST	OR item select	Select conditions registered in OR LIST with check boxes.
	OR item add	Add the conditions set in [Register I/O Break Condition] to OR LIST.
	OR item delete	Delete the selected conditions in OR LIST.
Condition settings read		Read conditions saved in the I/O break condition Setting file.
Condition setting save		Save the present settings in the I/O break condition Setting file.
[OK] button		Set the present I/O break condition and exit the window.
[Cancel] button		Exit the window without setting the present condition.

**Register IO Break Condition Window**

The Register IO Break Condition window sets conditions to be registered to AND LIST or OR LIST in the I/O Break Settings window.

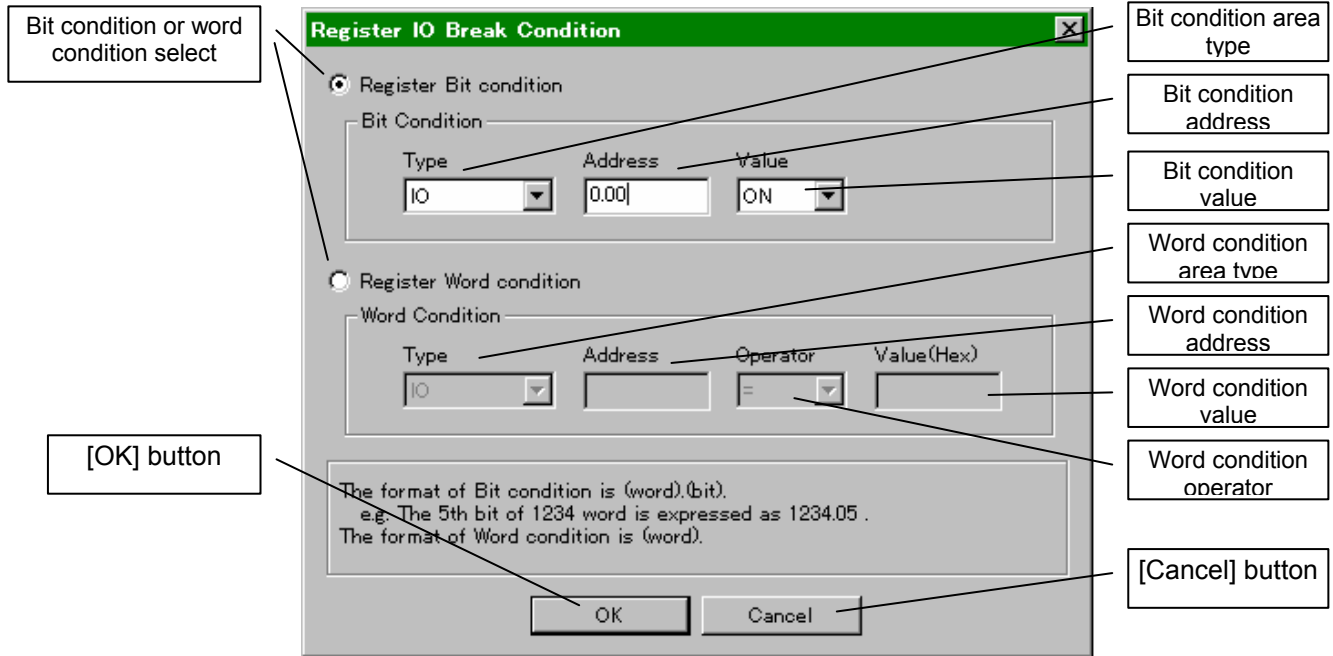

Name	Function
Bit condition or word condition select	Select bit condition or word condition as the Conditional Equation to be input.
Bit condition area type	(See the table below.)
Bit condition address	(See the table below.)
Bit condition value	Select from ON, OFF, or NOT (value change).
Word condition area type	(See the table below.)
Word condition address	(See the table below.)
Word condition operator	Select from =, <=, >=, <>, <, >, or NOT (value change).
Word condition value	Input the value to be compared in binary (0000 to FFFF).
[OK] button	Register the present I/O break condition and exit the window.
[Cancel] button	Exit the window without setting the present condition.

**Available Area Type and Address Range**

**Bit Condition**

Area Name	Area Type	Address Range
CIO Area	IO	0.00 to 6143.15
Work Area	W	0.00 to 511.15
Holding Area	H	0.00 to 511.15
Auxiliary Area	A	0.00 to 959.15

**Word Condition**

Area Name	Area Type	Address Range
CIO Area	IO	0 to 6143
Work Area	W	0 to 511
Holding Are	H	0 to 511
Auxiliary Area	A	0 to 959
DM Area	D	0 to 32767
EM Area	E?_	E0_0 to E0_32767 and EC_0 to EC_32767
Timer Area (TIM)	T	0 to 4095
Counter Area (CNT)	C	0 to 4095

**Note** Refer to 4-3 Step Run and Break for the details of I/O break condition.

## SECTION 4

# Debugging Programs

4-1 Debugging Using the CX-Programmer .....	92
4-2 Debugging Operation.....	93
4-2-1 CS/CJ/CP-series PLC's Modes and Execution Mode.....	93
4-2-2 Scan Run .....	94
4-2-3 Step Run .....	94
4-2-4 Stop (■).....	95
4-2-5 Pause (  ).....	96
4-2-6 Other Operation.....	96
4-3 Step Run and Break .....	97
4-3-1 Operations for Step Run.....	97
4-3-2 Break Setting.....	97
4-3-3 Break Point.....	98
4-3-4 Start Point Setting.....	99
4-3-5 I/O Break Condition Setting.....	100
4-4 Task Debugging.....	105
4-4-1 Execution Time and Count of Task.....	105
4-4-2 Task Execution Status .....	105
4-4-3 Executing Tasks Individually .....	106
4-4-4 Precautions when Debugging Task.....	107

## 4-1 Debugging Using the CX-Programmer

Debugging using the CX-Programmer can be performed in the same operation as the CS/CJ/CP-series PLC because the CX-Simulator implements equivalent functions as the CS/CJ/CP-series PLC.

**Note** For details of program debugging with CX-Programmer, refer to the *CX-Programmer Operation Manual (W446)*.

This section shows the differences with the actual CS/CJ/CP-series PLC and notices when operating the CX-Simulator from the CX-Programmer.

Operation of the CX-Programmer	Differences/Notices
Transfer/compare a program.	Same
Monitoring	Monitoring is possible even during a scan when in Step Run.
Force Set/Reset and Set/Reset Bits	Force Set/Reset and Set/Reset Bits are possible even during a scan when in Step Run.
Change the present value of a word.	Changing the present value of a word is possible even during a scan when in Step Run.
Change the set value of the Timer/Counter.	Changing the set value of the Timer/Counter is possible even during a scan when in Step Run.
Detect a rising/falling edge (differential monitor)	Differential monitor is possible even during a scan when in Step Run.
Online Editing	Online Editing is possible even during Step Run and scan. Online Editing during Step Run (including Continuous Step Run) will return the program control to the head (when Online Editing enabled for Scan Replay/ Step Run).
Data Trace/Time Chart Monitoring	The time axis (the horizontal axis) of the time chart monitoring shows the different time with that of the CX-Simulator operation when in the virtual cycle time mode or pausing.
Cycle Time Display	Setting from the CX-Simulator allows to display the cycle time in the virtual cycle time or computer cycle time.
Occurring Error and Error History Display	Same
Register/Set a Password	Same
Read/Set Clock	Same (The day of the week is automatically corrected following the calendar in the CX-Simulator.)
Release an access right	Same

**Note** When operating the Ladder Engine only from the CX-Programmer and not from the CX-Simulator Debug Console (in the Monitor mode and in Continuous Run), the same operation as when the CS/CJ-series CPU Unit is connected to the CX-Programmer can be performed.



## 4-2 Debugging Operation

The Ladder Engine has the execution mode for operating from the [CX-Simulator Debug Console] as well as the modes in the CS/CJ/CP-series PLC. Changing the execution mode from the [CX-Simulator Debug Console] allows more detailed debugging.

### 4-2-1 CS/CJ/CP-series PLC's Modes and Execution Mode

The Ladder Engine of the CX-Simulator performs the same operation as the actual PLC. Thus it has the actual PLC's modes (Program/Monitor/Run).

#### Relationship between Actual PLC's Modes and Execution Mode

The table below shows the relationship between the actual PLC's modes and the Execution Mode

Execution Mode \ Mode		Program Mode	Monitor mode	Run mode
Scan Run	Scan Run	–	○	Same as the Monitor mode. Changed only by the CX-Programmer setting.
	Continuous Scan Run	–	○	
	Continuous Run	–	○	
Step Run	Step Run	–	○	
	Continuous Step Run	–	○	
Pause		–	○	
Stop		○	–	
Scan Replay		–	○	
Reset		Follow the settings.		

**Note** The Ladder Engine runs in the Monitor mode. A Run operation turns the mode to Monitor even when the mode is changed to Run from the CX-Programmer.

#### Mode Change from CX-Programmer

Changing the mode from the CX-Programmer will change the execution mode of the Ladder Engine as follows.

- Program mode → Monitor/Run mode : Continuous Run
- Monitor/Run mode → Program mode : Stop mode
- Monitor mode → Run mode : No change
- Run mode → Monitor mode : No change

#### Execution mode and CX-Simulator Connection

Selecting [Disconnect] in the [Work CX-Simulator] window will automatically turn the execution mode to the Stop mode. Changing the execution mode from the [CX-Simulator Debug Console] or changing the mode from the CX-Programmer can not be performed during Disconnect.

Change the execution mode after [Connect].

## 4-2-2 Scan Run

The Scan Run executes the program from overseeing processing to peripheral servicing in a single scan (cycle).

There are three types of Scan Run: [Scan Run], [Continuous Scan Run], and [Continuous Run].

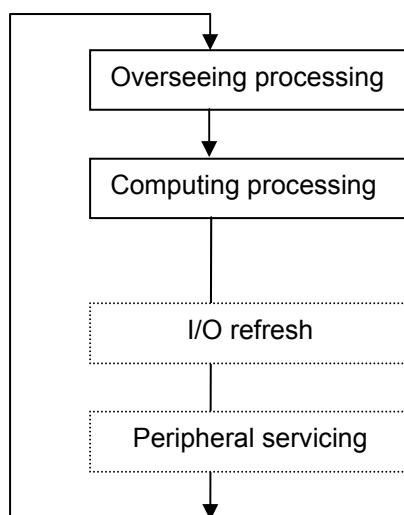

### Scan Run (>|)

Scan Run executes a program from the present executing point by a single scan. The mode turns to Pause when completed.

### Continuous Scan Run (>>|)

Continuous Scan Run repeats Scan Run at a fixed interval.

The minimum cycle time function of PLC fixes the time from the cycle start time to the next start time. In Continuous Scan Run, on the other hand, fixes the time from the cycle end time to the next start time.

### Continuous Run (>>)

Continuous Run repeats a single scan (cycle) from overseeing processing to peripheral servicing. Changing the mode of the Ladder Engine to Monitor mode from the CX-Programmer will automatically turn to Continuous Run mode.

**Note** Refer to 9-1 CPU Unit Operation for the details of the CPU Unit operation.

## 4-2-3 Step Run

The Step Run executes a program by instruction (step).

While executing, the mnemonic list is displayed in the Step Run window to monitor the line (step) currently being executed.

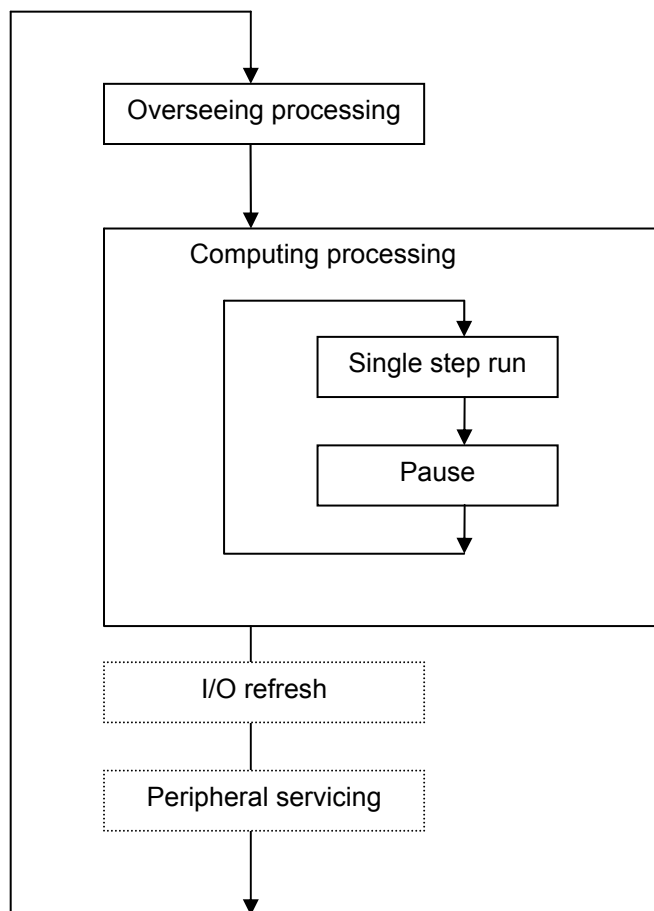

There are two types of Step Run: [Single Step Run] and [Continuous Step Run].

**Step Run (>)**

The Step Run executes a program by step. Executing Single Step Run during Continuous Run or Scan run will pause the program at the top.

**Continuous Step Run (▶▶)**

The Continuous Step Run repeats Step Run at a fixed interval.

**4-2-4 Stop (■)**

The Stop stops executing the ladder diagram for Continuous Run, Scan Run, Continuous Scan Run, Continuous Step Run, or Pause

Changing the mode of the Ladder Engine to the Program mode from the CX-Programmer will stop executing the ladder diagram.

### 4-2-5 Pause (⏸)

Pause pauses executing the ladder diagram.

The situation is also the same when the execution of the ladder program is stopping in Scan Run, Step Run, a break point, or an I/O break condition. While pausing, the peripheral servicing is performed.

### 4-2-6 Other Operation

#### Scan Replay (▶)

The Scan Replay returns the execution status to the first of the scan when pausing.

The Scan Replay returns all of the status including values changed by the program execution to that of the scan start.

As long as it is within a scan, monitoring can be done with conditions changed any times.

#### Reset (R↺)

The Reset simulates the process in the Ladder Engine when from power interruption to power on. The power interruption task is started at power interruption to allow debugging the power interruption process (only when registered).

Returning from the Reset turns the mode to Program.

## 4-3 Step Run and Break

The Step Run allows to debug by step, which was impossible in debugging using an actual CS/CJ/CP-series PLC.

In addition, combining execution with a break/start point specified, and break with I/O memory conditions (I/O break conditions) specified will allow closer debugging.

The Step Run is available only for a program on the program area for applications (UM1), not for debugging (UM2).

### 4-3-1 Operations for Step Run

#### Peripheral Servicing

The Ladder Engine accepts and process FINS commands even during a cycle execution as long as it is during pausing (e.g. Step Run).

This enables monitoring the values during a cycle execution, which is usually impossible.

#### Online Editing

When performing Online Editing to the Ladder Engine during Step Run or pausing during a cycle, the program execution returns to the status just prior to the cycle start and pauses (when set as Online Editing enabled for Scan Re-run/Step Run).

#### Cycle Time during Step Run

The cycle time during Step Run (including pausing), for both virtual cycle time and computer cycle time, does not include the time of pausing. Similarly, the Timer, Clock Pulses, etc. do not operate during pausing. However, only the time clocks the actual time if set as "computer cycle time." If set as "virtual cycle time", the time stays unchanged during pausing because the time accumulates the virtual cycle time.

### 4-3-2 Break Setting

		Start point	Break point	I/O Break Condition
The Number of settings		One point	32 points max	One condition
For applications program area (UM1)		Usable		
For debugging program area (UM2)		Unusable		
Action when a program changed	When online editing	Clear	Clear only the break points in the changed task.	No change
	When downloading	Clear	All clear	No change
Operation after execution		Clear setting after execution	No change (Continuous setting)	After the break condition is met, the values of I/O memory area within the conditions are reevaluated only when they have changed.

### 4-3-3 Break Point

The break point is where the program execution is paused. Specifying a break point will automatically stop the program execution at the specified point.

As an example of break point, the following introduces the case where monitoring the IR value used between FOR and NEXT.

#### Monitoring IR

The Step Run enables monitoring the contents of Index Registers (IR) while executing a ladder diagram in the CX-Programmer's [Set Values] window, which used to be impossible.

Following diagram shows an example of IR usage extracted from the sample in 6-2 *Index Registers of CS/CJ Series Programming Manual(W394)*. Setting a break pointer within the FOR to NEXT loop (the hatched part in the diagram) enables to check the change of IR within the FOR to NEXT loop.

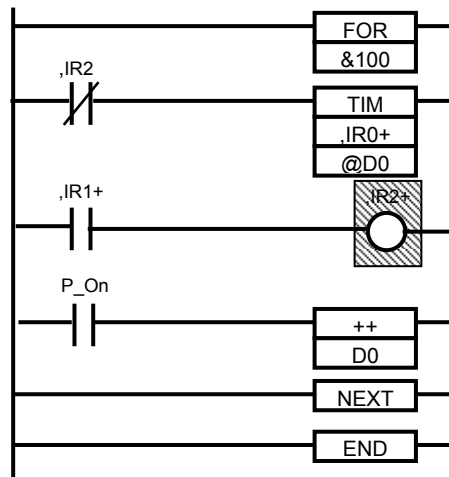

Program address	Instruction word (mnemonic)	Operand
000000	FOR	&100
000001	LD NOT	,IR2
000002	TIM	,IR0+ @D0
000003	LD	,IR1+
000004	OUT	IR2+
000005	LD	P_On
000006	++	D0
000007	NEXT	
000008	END	

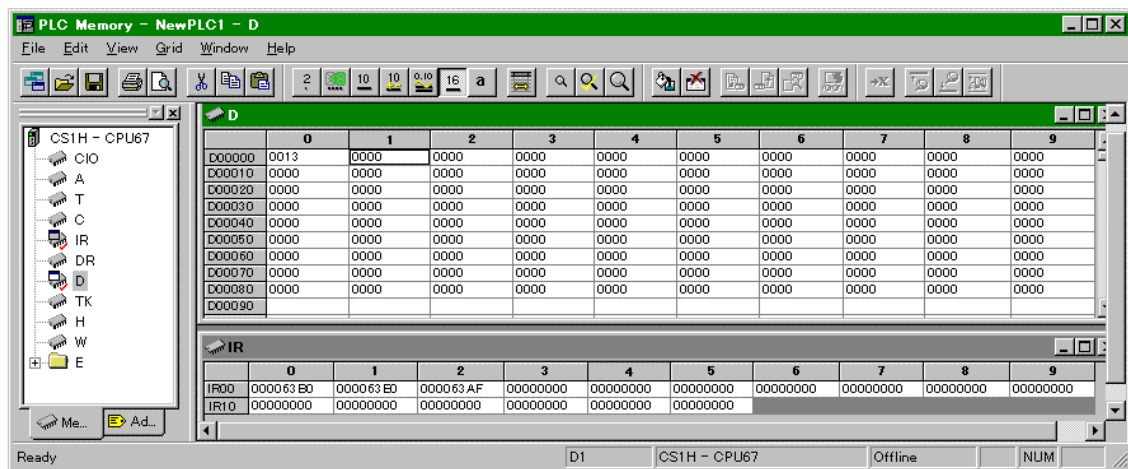

### 4-3-4 Start Point Setting

Setting a start point enables to specify an instruction to be executed next by the program.

#### Start Point Setting

A start point can be set only in the Program mode. The program is executed from the start point when an execution is operated from the Debug Console or the mode is changed to the Monitor mode by the CX-Programmer. For example, executing Step Run with a start point specified will move the execution control to the start point and begin the next Step Run.

#### Start Point Location

If a start point is set halfway in the rung, the previous value of power flow turns OFF (false) forcibly regardless of the present value. For example, setting a start point at the right hatched part in the diagram below will not execute the rung, which originally would be executed, because the power flow is forcibly turned OFF.

When executing the diagram with a start point set, set the start point at the top of the rung (the left hatched part in the diagram).

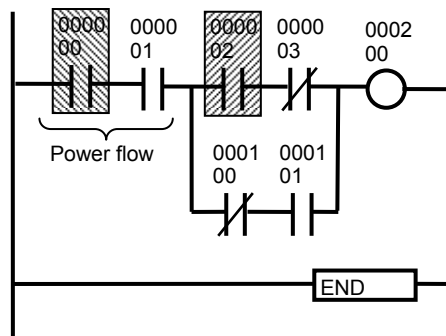

Program address	Instruction word (Mnemonic)	Operand
000000	LD	000000
000001	AND	000001
000002	LD	000002
000003	AND NOT	000003
000004	LD NOT	000100
000005	AND	000101
000006	OR LD	
000007	AND LD	
000008	OUT	000200
000009	END	

**Note** Be careful when setting a start point in JUMP instructions or a loop rung as shown below. Doing so may cause an unstable JUMP address and an unexpected operation.

- Setting within a subroutine
- Setting within a FOR to NEXT loop
- Setting within a block program

Looping may fail (exit the loop unexpectedly) because the loop condition is not evaluated correctly. For JUMP instructions (including subroutines), the JUMP destination address when the JUMP instruction was last executed will be executed or an instruction error will occur. If an instruction error occurs, once stop the program or set to the Program mode and then resume the operation.

**Note** Refer to 2-1 Basic Concepts of CS/CJ Series Programming Manual (W394) for the power flow.

**Executing Only Specific Rung (Partial Execution)**

When debugging only a specific rung, set a start point at the top of the rung and a break point at the top of the next rung (shown by the hatching in the diagram) to execute the specified range of the rung.

However, when repeating executing a specific rung continuously, reset a start point, which is automatically cleared on execution, after stopping at the break point.

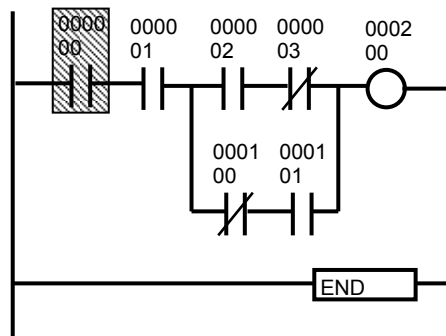

Program Address	Instruction Word (Mnemonic)	Operand
000000	LD	000000
000001	AND	000001
000002	LD	000002
000003	AND NOT	000003
000004	LD NOT	000100
000005	AND	000101
000006	OR LD	
000007	AND LD	
000008	OUT	000200
000009	END	

**Block Run of Task**

When the Ladder Engine is in stop (the Program mode), if a task is executed from the pop-up menu after selecting the task in the [Task Control], Step Run will be executed with a start point set at the top of the task and a break point at the bottom of the task automatically. (While the program is being executed, an interrupt will occur at the timings: when a task execution flag is set for a Cyclic Task and when the interruption occurs for an interrupt task.)

**Note** In the Block Run, the following operation will be performed after stopped by an End instruction:

- (1) For a cycle task, the next executable task is executed,
- (2) For an interrupt task, a cyclic task in the next cycle is executed.

**4-3-5 I/O Break Condition Setting**

The setting expression of I/O break condition is a logic expression combining multiple I/O break conditions. If an I/O break condition is set, the I/O break pauses the program execution when the contents of the I/O memory area get to satisfy the specified condition. Only one condition can be set for the setting expression.



**I/O Break Condition**

The I/O break condition is expressed with the following elements for both I/O Condition and Word Condition.

<Target I/O memory area >( <Condition operator >)( <Value >)

Element	Content
Target I/O memory area	Specify the target I/O memory area in its type and address.
Condition operator	For Word Condition, a condition operator exists.
Value	For I/O Condition, set ON/OFF/NOT, for Word Condition the fixed value (BIN), and for NOT operator of Word Condition nothing.

Condition operators (and values for I/O Condition) to be set are shown below.

I/O Condition Value	Contents
ON	The bit value is ON(1)
OFF	The bit value is OFF(0)
NOT	Hold if the value is changed.

Word Condition Operator	Contents
=	Hold if the value is the same as that of the target I/O memory area.
<	Hold if the value is smaller than that of the target I/O memory area.
>	Hold if the value is greater than that of the target I/O memory area.
<=	Hold if the value is equal to or smaller than that of the target I/O memory area.
>=	Hold if the value is equal to or greater than that of the target I/O memory area.
<>	Hold if the value is not equal to that of the target I/O memory area.
NOT	Hold if the value has been changed.

## Register IO Break Condition

Here shows the registration procedure for I/O break condition.

- 1,2,3...** 1. Display [Register IO Break Condition] by [CX-Simulator Debug Console] | [IO Break Condition] and click the [Add] in the list (AND LIST/OR LIST) for registering I/O break condition to register I/O break condition. Display the [Register IO Break Condition] window.

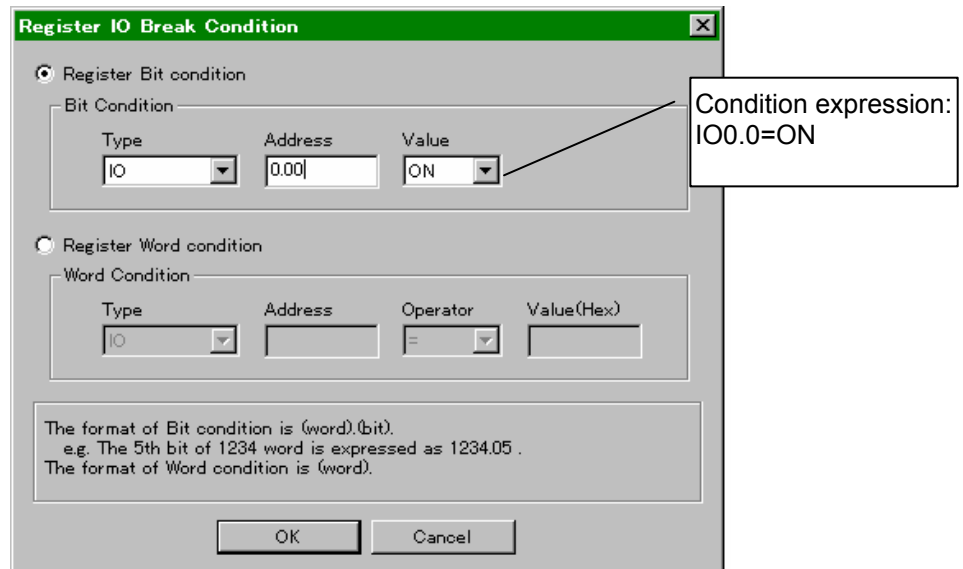

2. Select either I/O Condition or Word Condition and input the type of the target I/O memory area, condition operator (only Word Condition), and the value followed by the [OK] button.

**Condition Combination**

The I/O break condition expression can be set by combining conditions (Turn on check boxes for conditions registered in AND LIST or OR LIST). The I/O break condition expression is configured by combining [AND LIST] (Conditions are combined with AND operators) and [OR LIST] (Conditions are combined with OR operators) with logical operators (AND/OR). The relationship between [AND LIST] and [OR LIST] is expressed by the following logic expression.

$$([AND LIST]) AND ([OR LIST])$$

I/O break condition setting expression  
 (IO0.0=ON and H1.15=ON) and (DM0>=#7FFF or A401.08=ON)

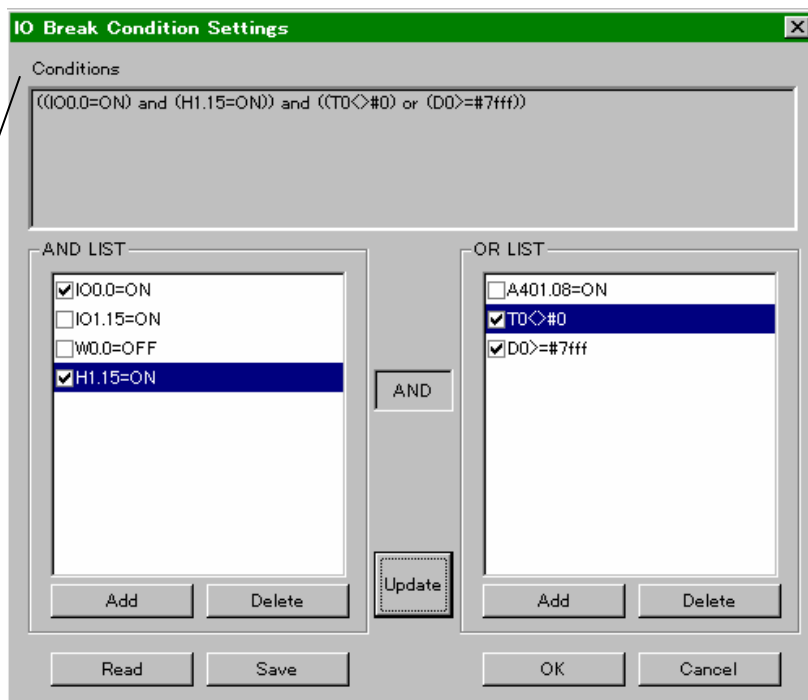

A maximum of 64 items can be registered in AND LIST and OR LIST respectively. Also, a maximum of 64 combinations of logic expressions can be created for both the lists together.

### Operation when I/O Break Condition Met

Continuous Run with I/O break condition set is executed in the diagram below. I/O break condition holds when the content of DM00000 that is incremented by one-second pulse becomes equal to or greater than #7FFF while both values of IO0.0 and H1.15 are ON, and the ladder diagram execution breaks.

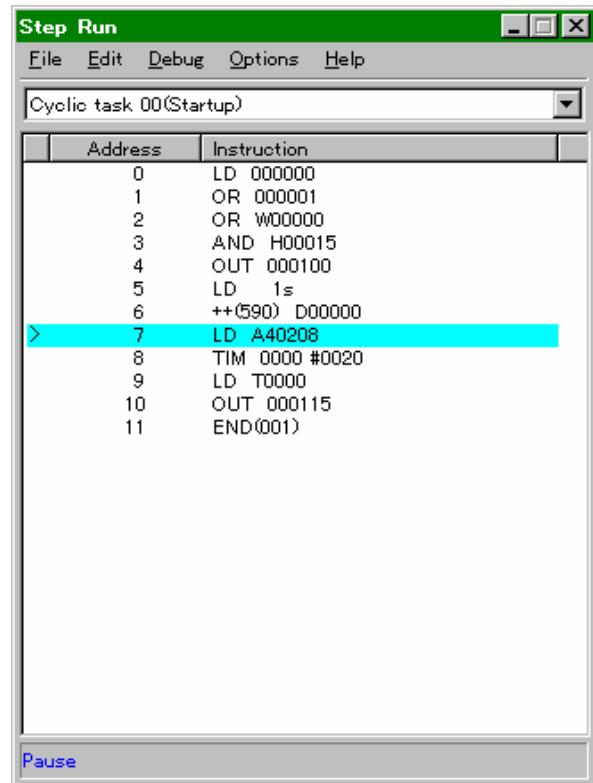
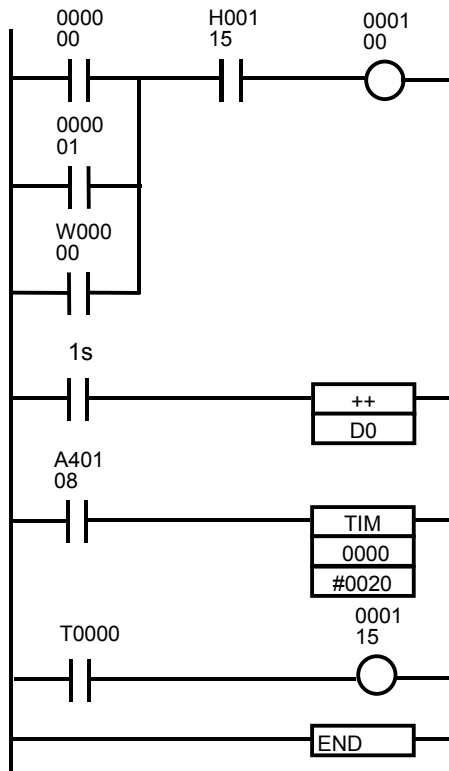

I/O break condition setting expression:

$(IO0.0=ON \text{ and } H1.15=ON) \text{ and } (DM0 \geq \#7FFF \text{ or } A401.08=ON)$

For example, if the break occurs when the DM00000 count is completed (Shown by the left arrow in the above diagram), the I/O break line is displayed on the next line in the [Step Run] window and the program pauses.

In addition, continuing the running in this condition will cause the execution to pause again in the following case: (1) the I/O break condition expression changes "true"→"false"→"true," or (2) the values of each condition expression change within the range where the condition expression holds.

- Note**
1. Do not perform online editing while setting I/O break conditions. Doing so may cause the same operation (i.e. Scan Replay or enter the Program mode) as the case where performing online editing when Step Run.
  2. If Continuous Run/Scan Run/Continuous Scan Run is performed while setting I/O break conditions, clicking the Step Run/Pause button may cause the execution to pause halfway in the scan. (Usually stops on the top.)

## 4-4 Task Debugging

One of the functions added in CS/CJ/CP-series PLCs is a concept of "task." This section explains debugging a task using the CX-Simulator.

### 4-4-1 Execution Time and Count of Task

#### Execution Time and Count of Task

The [Task Control] window monitors execution time and count of each task. The time and count are cleared in the Stop/Program mode.

This function is effective when redesigning so as to reduce the overall cycle time by dividing a time-consuming task by the execute/non-execute condition and controlling execute/wait of the task.

#### Confirming Upper Limit of Execution Time of Interrupt Task

When using the C200H Special I/O Unit or the SYSMAC BUS Remote I/O Unit, the execution time of the interrupt task must not exceed 10 ms. If an interrupt task is executed for more than 10 ms during refreshing, an interrupt task error will occur ("Executed for more than 10 ms" error). Also, the execution time of the power interruption task must be less than 10 ms (Power OFF Detection Delay Time) regardless of units mounted.

Execution time of an interrupt task can be monitored with the task execution time in the [Task Control].

Starting interrupt tasks successively during the program execution in [Task Control] enables to monitor the execution time of interrupt tasks individually.

### 4-4-2 Task Execution Status

[Task Control] displays the execution status of each task (cyclic tasks and interrupt tasks).

For a cyclic task, show four statuses of a cyclic task: Initial status, READY status, RUN status, and WAIT status.

For an interrupt task, display "each interrupt task is enabled or disabled." The status of interrupt tasks are changed by the following instructions.

Name	Instruction word	Target	Function
Interrupt task Execution prohibit	DI (693)	All interrupt tasks other than Power OFF interrupt task	Used within a cyclic task and prohibit all interrupt tasks other than Power OFF interrupt task.
Interrupt task Clear interrupt mask	EI (694)	All interrupt tasks other than Power OFF interrupt task	Clear the interrupt mask for an interrupt task masked by DI instruction.
Masking set	MSKS (690)	I/O interrupt task and scheduled interrupt task	Apply masking of initial setting to an I/O interrupt task and a scheduled interrupt task.

**Note** Trying to start a masked interrupt task in the [Task Control] will not execute the task.

### 4-4-3 Executing Tasks Individually

[Task Control] displays the execution status of cyclic tasks and interrupt tasks and executes the tasks.

#### Change Execution Status of Cyclic Tasks

Selecting an execution status (enabled/wait) of a task in the pop-up menu allows to change the status.

The setting is reflected in the next cycle for Scan Run, in the same cycle if the task is to be executed after the currently executed task for Step Run, or in the next cycle if the task has already been executed.

**Note** Getting all cyclic tasks in wait will cause a program execution error.

#### Block Run of Cyclic Task

Selecting the Block Run of Cyclic Task in the pop-up menu will set a start point at the top of the selected task and a break point at the end (END instruction) of the task to execute [Step Run]. The break point at the end is a tentative setting, which is automatically cleared when the task is completed or in the Program mode. (In the [Step Run] window, the break point at the end is not displayed.)

The next cycle execution task is executed after the Block Run.

#### Interrupt Task Execution

Execution of an interrupt task has two types depending on the program execution status.

Executing an interrupt task during program execution from the [Task Control] pop-up menu will start the interrupt task to return to the original task after the interrupt task is completed. This process corresponds to the case where an interrupt task is started by an external factor in CS/CJ/CP-series CPU Units.

Executing an interrupt task during the program stop will cause a Block Run of the interrupt task. The Block Run runs in the same way as that of a cyclic task. In this case the regular execution will be performed from the top of the scan after the interrupt task is completed.

- Note**
1. If an interrupt task being disabled to execute is started from the [Task Control], the task will not be executed. The power interrupt task will be started regardless of the setting of "Power OFF Interrupt Task Enabled/Disabled" of PC Setup.
  2. If an interrupt task in the program area for applications (UM1) is started while executing in that for debugging (UM2), the interrupt task will be executed. The control will return to the UM2 after the execution.

## 4-4-4 Precautions when Debugging Task

### Display Task in Program Area for Debugging

No tasks other than ones used in the program area for applications are displayed in the [Task Control].

### Interrupt Factor for Interrupt Task

The interrupt factor for an interrupt task is identified by the task number if the task is started in the [Task Control].

Interrupt factor	Task number
Power OFF interrupt task	1
Scheduled interrupt task	2,3
I/O interrupt task	100 to 131
External interrupt task	The task numbers other than the above.

### Starting I/O Interrupt Task

An I/O interrupt task will not be started even if Interrupt Input Unit is registered in the [Register PLC Unit] window and the I/O memory area corresponding to the input allocated to the Interrupt Input Unit is turned ON.





## **SECTION 5**

# **Debugging Serial Communications**

5-1 Outline of Serial Communications.....	110
5-2 Serial Communications Settings .....	113
5-3 Serial Communications Connection .....	117
5-3-1 Access from External Devices via Serial Communications .....	117
5-3-2 Access to External Device Using Serial Communications .....	118
5-3-3 Precautions in Using Serial Communications .....	118
5-4 Connecting PT via NT Link .....	120
5-5 Examples of Serial Communications Debugging .....	121
5-5-1 Procedure for Debugging Serial Communications Instructions .....	121
5-5-2 Debugging by Message Display .....	122
5-5-3 Debugging by Serial Data File .....	122

## 5-1 Outline of Serial Communications

This section explains how to perform serial communications.

### Introduction

The CX-Simulator can debugs serial communications using (1) actual communications to an external serial communications device using a COM port on the computer,(2) screen display of send messages, or (3) input/output from/to a file.

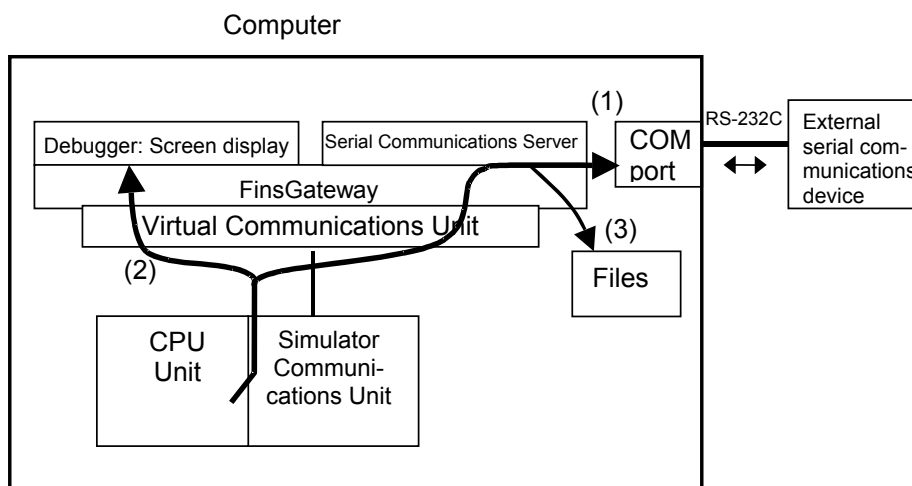

- Note**
1. Serial communications cannot be performed when the CX-Simulator is started and the online connection is performed from the CX-Programmer.
  2. Refer to 6-3 *Serial Communications* of *CS/CJ Series Programming Manual* for the outline of CS/CJ-series serial communications.

### Supported Protocols and Units

The CX-Simulator supports Host Link (SYSMAC WAY), NT Link, and No-protocol as a protocol for serial communications. These protocols support differently depending on a Unit that performs serial communications. The relationship between serial communications protocols and Units is shown below.

Hardware	CPU Unit		Serial Communications Board	Serial Communications Unit
	Peripheral port (Port 1)	RS-232C port (Port 2)		
Protocol				
Host Link (SYSMAC WAY)	No	Yes (FINS/C-mode communications)		
Protocol macro		-	No	No
NT Link (1:N mode)		Yes (Only Unit No.0 connectable)		
No-protocol		Yes	-	-
Peripheral bus		No	-	-
Loopback test		-	No	No

Yes: Supported No: Not supported -: Does not exist

**Note** For the RS-232C port on the CPU Unit, if a protocol not supported by the CX-Simulator in the PLC Setup settings is set, communications can not be performed.  
For the Serial Communications Board/Unit, if the Serial Communications mode of System Setup is No-protocol, communications can not be performed.

### Supported Serial Communications Instructions

The instructions related to serial communications that can be used in a program and their supporting status are shown below.

Instruction	Support	Remarks
TXD/RXD instruction	Yes	with No-protocol
PMCR instruction	No	NOP for instruction processing.
STUP instruction	Yes	
SEND/RECV instructions	Yes	Slave initiation with Host Link (FINS communications)
CMND instruction	Yes	Slave initiation with Host Link (FINS communications)

### I/O Memory Allocation

The outline of I/O memory allocation for each piece of hardware and the supporting status in the CX-Simulator are shown below. (Only for No-protocol and Host Link)

Hardware	Area	Allocation name	Support	
CPU Unit RS-232C port (Port 2)	PLC Setup Area (RS-232C Port Settings)	RS-232C Port Settings Selection	Yes	
		Communications mode	Yes	
		Data bits/Stop bits/Parity/Baud rate	Yes	
		No-protocol mode delay	Yes	
		CPU Unit's Unit Number in Host Link Mode	Yes	
		No-protocol frame format	Yes	
	Auxiliary Area	RS-232C Port Error Flag (A39204)	Yes	
		RS-232C Port Send Ready Flag (A39205)	Yes	
		RS-232C Port Reception Completed Flag (A39206)	Yes	
		RS-232C Port Reception Overflow Flag (A39207)	Yes	
		RS-232C Port Reception Counter (A393)	Yes	
		RS-232C Port Restart Flag (A52600)	Yes	
		RS-232C Port Error Code (A528)	Yes	
		RS-232C Port Settings Changing Flag (A61902)	Yes	
Serial Commu- nications Unit/Board	Setup Area	Port settings	Yes	
		Serial communications mode	Yes	
		Start bits/Data length/Stop bits/Parity/Baud rate	Yes	
		Send delay time	Yes	
		CTS control	Yes	
		Host Link unit number	Yes	
		Software Switches	-	
	Status Area (I/O Memory Alloca- tions)	Error log EEPROM error	No	
		Protocol data error	No	
		Port setting status	Yes	
		Communications status	-	
		Transmission control signal status	Yes	
		Transmission error status	Yes	
	Auxiliary Area	Restart Bit (A501: Unit, A60800: Inner Board)	Yes	
		Port 1 and Port 2 Port Settings Change Bits (A620 to A636)	Yes	
	Serial Commu- nications Board	Auxiliary Area	Error Details (A424)	No

Yes: Supported No: Not supported -: Not used

**Note** Refer to 2-3 I/O Memory Allocations in SYSMAC CS/CJ Series Serial Communications Boards/Unit Operation Manual (W336) for the details of Serial Communications Boards/Unit settings.

**Communications Settings for Serial Communications**

**Communications Settings for Serial Communications** When using serial communications instructions in a program, communications settings for each port number to be used can be specified. Serial communications settings include the following settings.

Communications Settings	Contents
–	Communications are not processed.
Messages	Display the contents of messages that would be sent to an external device. (Actually messages are not sent.)
File	Write communications data to a file and read from the file.
Actual communications	Possible to communicate in Host Link (SYSMAC WAY), NT Link, or No-protocol via a COM port on the computer.

**Operations of Auxiliary Area** The table below shows differences in operation of Status Area and Auxiliary Area when set as communications are not actually performed (“-/”Messages”).

Instruction		Contents
TXD	RS-232C Port Send Ready Flag	Always ON
RXD	RS-232C Port Reception Completed Flag	Always OFF
	RS-232C Port Reception Overflow Flag	Always OFF (No error)
	RS-232C Port Reception Counter	Always 0
STUP	RS-232C Port Settings Changing Flag	Always OFF
Network instructions SEND/RECV /CMND	Network Communications Error Flag	Always OFF (No error)
	Network Communications Enabled Flag	Disabled (OFF) at command issue and enabled (ON) at peripheral servicing in the same cycle.
	Network Communications Completion Code	Cleared (always normal status)

**COM Port Logging Function** Save communications history to a file when serial communications are performed with a COM port on the computer allocated. This function is available when the communications setting for serial communications is set to “File” or “Actual communications,” although disabled for NT Link.

- Folder                    PLC data folder\LOG
- Input file name        COM port name LOG.txt

**Error Logs**

The error logs function of Serial Communications Boards/Unit is not available.

## 5-2 Serial Communications Settings

**Note** If necessary Serial Communications Units have already been registered, go to Procedure 5.

- 1,2,3...** 3. Add Serial Communications Unit  
Add necessary Serial Communications Units in [Status] | [Settings] | [Register PLC Unit].

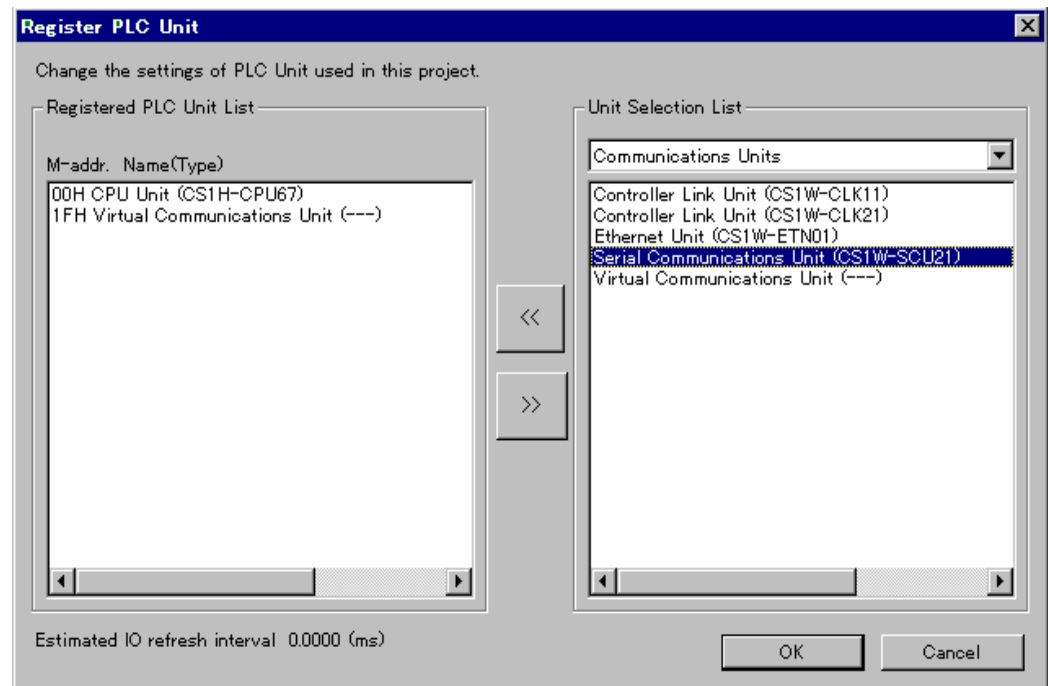

Select Communications Unit or Inner Board in the Unit Selection List and click Serial Communications Unit or Serial Communications Board, and then press the [<<] key to register to the Registered PLC Unit List.

**Note** Adding Units is not required when using the RS-232C port of the CPU Unit. It is required only if using Serial Communications Board/Unit.

4. Input Unit Number  
Input the Unit number if the Serial Communications Unit is added.

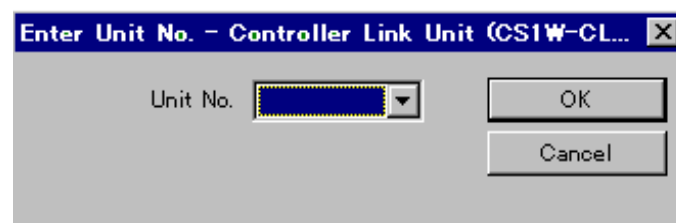

**Note** Set the Unit number so as not to overlap with that of another CPU Bus Unit.

5. Press the [OK] button to return to the [Register PLC Unit] and to register the Unit to the Registered PLC Unit List.
6. Press the [OK] button to register the Serial Communications Unit.
7. Serial Communications Settings  
Selecting [Status] | [Settings] | [Serial comms. settings] will display [Serial Communications Settings]. The displayed Unit address 00H shows the RS-232C port of the CPU Unit, 10H to 1FH; Serial Communications Unit No. 0 to 15, and E1H; Serial Communications Board respectively.
8. Serial Port Setting

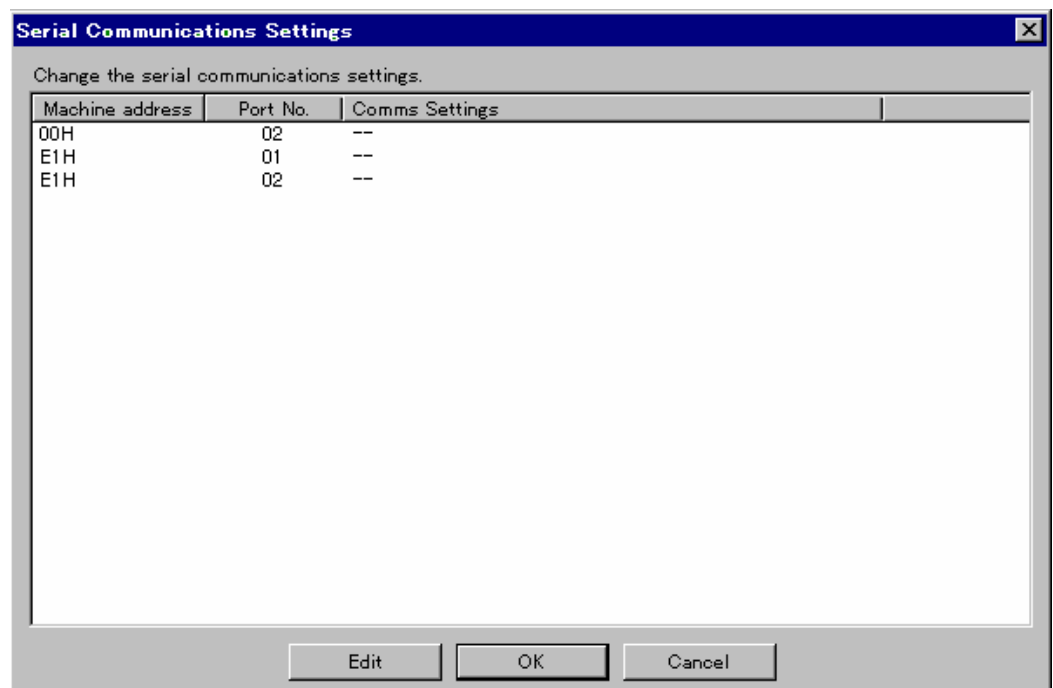

Double-click the port number of the Serial Communications Unit to be set to display the [Serial Port Settings] window.

## 9. Communications Settings of Serial Port Settings

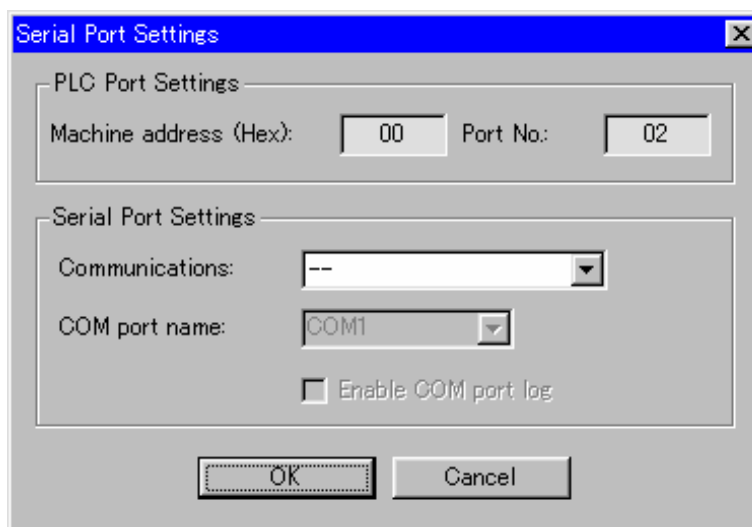

Select Serial Port Settings from the combo boxes of Communications Settings according to the purpose of debugging. The followings can be selected.

Communications Settings	COM port name	COM port log	Contents
–	–	–	Communications are not processed.(Default)
Messages	–	–	Display the contents of messages to be sent to the Message Display window. The process for RXD is not executed.
File	○	○	Input/output from/to a file instead of a COM port on the computer.
Actual communications	○	○	Possible to communicate via a COM port on the computer.

## 10. Setting a COM port name

Specify a COM port to perform actual serial communications. A COM port name (COM 1 to COM 4) can be selected in the list, and also can be input directly for an additional COM port on the computer.

**Note** Communications will be disabled if the default port number allocated to the CS1W-CIF31 Conversion Adapter is changed. Press the [Reset] button to resume communications.

**Note** If the selected COM port name is already allocated to another one, a setting error will occur.

**Note** If running the CX-Simulator and an application that uses a computer's COM port simultaneously, set the COM ports so as not to overlap. For example, if the COM port used by the CX-Programmer and that used by the CX-Simulator overlap, communications may fail.

11. Press [OK] to exit the Serial Port Settings window and to return to Serial Communications Settings window.
12. Exit Serial Communications settings window  
Repeat the procedures 5 to 9 as required. Press the [OK] button when completed.
13. System setup for serial communications  
When an actual PLC performs serial communications, it is necessary to set communications parameters to the PLC's I/O memory areas. Also for the CX-Simulator, use the CX-Programmer to set Serial Communications mode, Start bits, Data length, Stop bits, Parity, Baud rate, etc., according to the manuals for each Serial Communications Unit.

**Note** DIP switch setting for "RS-232C port communications parameters" (pin 5) is fixed to "Use parameters set in the PLC Setup" (OFF).  
For CPU Unit's RS-232C port (Port 2) settings, refer to 7-1-2 *PC Setup* in *CS/CJ Series Operation Manual*, and for Serial Communications Board/Unit settings, refer to 4-2 *Setup Area Allocations* in *CS/CJ Series Serial Communications Boards/Unit Operation Manual (W336)*.

**Note** When using the RS-232C port (Port 2) on the CPU Unit, if a protocol not supported by the CX-Simulator is set in PLC Setup, communications cannot be performed.



## 5-3 Serial Communications Connection

The CX-Simulator provides various types of connections via serial communications according to debugging needs and a protocol to be used.

### 5-3-1 Access from External Devices via Serial Communications

#### Access by Programmable Terminal (PT)

Serial connection of OMRON's Programmable Terminal (PT) via NT Link allows to debug a ladder program that processes data input to the CX-Simulator from PT and creates data for PT display.

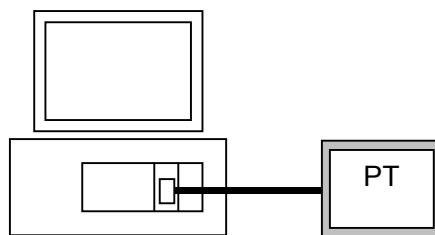

#### Access from a program directly operating a serial port

Serial connection to a program directly operating a computer's COM port via Host Link between the computers allows to access the CX-Simulator from the program.

- Note** Be sure to specify the CX-Simulator's network number and its node number (1 and 10 in default) when performing FINS communications via Host Link.
- Note** A connection cable for PLC can not be used because the pin arrangement of the serial port for an IBM PC/AT or compatible computer is different from that of a PLC. Make a new connection cable according to the pin arrangements for the computer and the device to be connected.

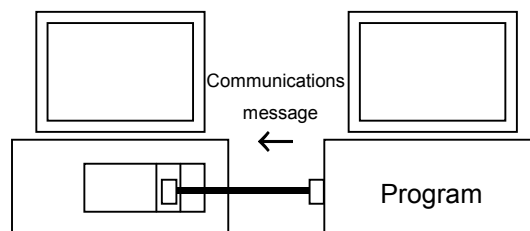

#### Access from a program using FinsGateway Serial Communications Unit

When connecting a program using FinsGateway serial communications to the Ladder engine, connection can be made without practical problems for an Ethernet Unit or a Controller Link Unit as long as the FINS address for the CX-Simulator Communications Unit of the Ladder Engine is set by the program after starting the FinsGateway Virtual Communications Unit.

## 5-3-2 Access to External Device Using Serial Communications

### Slave initiation via Host Link (FINS communications)

When performing FINS communications via Host Link by a ladder program, external communications from a computer are not restricted, which is different from the case of FINS communications for a network (communications via a Network Communications Unit). (Network communications are restricted within the local computer. Refer to 6-1 *Outline of Network Communications* for details.) Thus the slave initiation function can be checked by connecting the COM port on the computer to another computer.

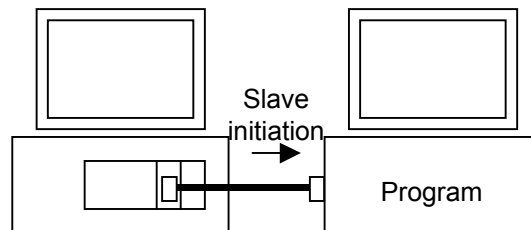

### Access via No-protocol

No-protocol communications are available for connecting a barcode reader, etc., allowing to process data read from a barcode reader in more practical way.

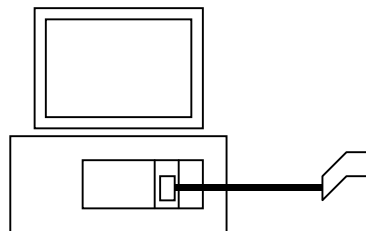

## 5-3-3 Precautions in Using Serial Communications

### Using Programmable Terminal via NT Link

Even when connecting a PT via NT Link, the Programming Console function and Device Monitoring function are not available. In addition, use a PT with a version of NT31/631-V2 or higher. When connecting a PT with the previous version, select Host Link as the communications protocol.

### FINS Command addressed to Serial Port

In the CX-Simulator's FINS communications, only a command addressed to the CPU Unit is accepted. FINS communications addressed to the serial port of individual Ladder Engines are not available.

### Changing Communications Protocol during [Work CX-Simulator]

When the communications protocol has been changed by the CX-Programmer's PLC Setup settings, etc., be sure to once [Disconnect] and then [Connect] again. The newly set protocol becomes effective after the [Connect].

**When Serial Communications on the CX-Simulator Become Disabled**

When Serial Communications on the CX-Simulator become disabled, for example, when the RS-232C Port Error Flag (A39204) in the Auxiliary area turns ON while executing serial communications on the CX-Simulator, either press [Reset] button in the [Debug Console], or once [Disconnect] and then [Connect] again.

## 5-4 Connecting PT via NT Link

The diagram below illustrates how to connect OMRON's Programmable Terminal (PT) via NT Link.

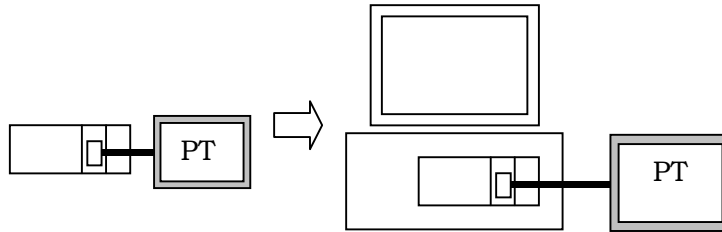

- 1,2,3...** 1. Set to NT Link (1:N) the communications protocol setting for the Ladder Engine's port used by the CX-Programmer.

**Note** Only the RS-232C port of the CPU Unit (Unit No.: 00H) can be changed using the CX-Programmer's PLC Setup setting. Otherwise, directly change the corresponding DM values from the PLC memory window, etc.

2. Once [Disconnect].
3. Select [Status] | [Settings] | [Serial communications settings] to display [Serial communications settings] window.
4. Select the Serial port of the Serial Communications Unit to be used, followed by pressing the [Edit] button to display [Serial communications registration] window.
5. Set the Communications Setting to [Actual communications] to select a COM port name.

**Note** Do not select a COM port name that overlaps with the one allocated in actual communications or the Serial Data File.

6. Press the [OK] button to exit the [Serial communications registration] window and to return to the [Serial communications settings] window.
7. Confirm the communications settings and the COM port name are identical to the contents set in procedure 5 to press the [OK] button.
8. Download the screen data to the PT. For the communications settings on the PT, set as Protocol: NT Link (1:N), Unit No.: 0, Communications speed: Standard.

**Note** If a COM port used by the PT's support tool overlaps with the one used by the CX-Simulator, downloading may fail in the [Connect] status. After [Disconnect], download by the support tool.

9. After completing setting on the PT, [Connect] to perform actual communications via NT Link.

**Note** In the NT Link communications, I/O memory values are read/written from/to the PT halfway during the Ladder Engine's scanning because the communications are executed asynchronously to the Ladder Engine.

## 5-5 Examples of Serial Communications Debugging

### 5-5-1 Procedure for Debugging Serial Communications Instructions

- 1,2,3... 1. Set the communications settings of serial communications to "-" to debug the portions unrelated to serial communications.

Display the [Serial Comm. Setting] window by [Status] | [Settings] | [Serial Comm. Setting].

Set the communications settings for all the Serial Communications Units to "-."

2. Set the communications settings of serial communications to "Messages" to display send messages through actual serial communications. Check the contents of the send messages.

Display the [Serial Comm. Setting] window by [Status] | [Settings] | [Serial Comm. Setting].

Set the communications settings for the Serial Communications Units to be debugged to "Messages."

3. Set the communications settings of serial communications to "File" to debug the serial communications portion by file I/O instead of actual serial communications.

Display the [Serial Comm. Setting] window by [Status] | [Settings] | [Serial Comm. Setting].

Set the communications settings for the Serial Communications Units to be debugged to "File."

4. Set the communications settings of serial communications to "Actual communications." Connect the actual communications target to the computer's COM port, and after confirming Setup for serial communications with I/O Memory Allocation, debug operations with actual serial communications.

Display the [Serial Comm. Setting] window by [Status] | [Settings] | [Serial Comm. Setting].

Set the communications settings for the Serial Communications Units to be debugged to "Actual communications."

Confirm the Setup of the Unit for serial communications with I/O Memory Allocation,

**Caution**

Enabling serial communications function of the CX-Simulator may affect the operation of devices connected to the computer. When external devices are not being used, do not enable the serial communications function. Unexpected operation of the external devices may cause an accident.

### 5-5-2 Debugging by Message Display

The following items can be confirmed in debugging by message display.

Confirmation item	Confirmation contents
If the setting is "Message Send Enabled"?	A message will be displayed when executing a send instruction. Possible to confirm if the system setting is correct.
If communications parameters are correct?	Possible to confirm the setting by a STUP instruction.
The Send Message Format of a TXD Instruction	The communications data sent by a TXD instruction is displayed as a message.
The Receive Timing of a RXD Instruction	The timing of a RXD instruction issue is displayed.
The Send Message Format of SEND/RECV/CMND	The content of FINS command sent by each command is displayed as a message.

A sample of message display when debugging serial communications is shown below. Date, Time, (Cycle count), Communications instruction executed, (Number of bytes sent), and send data are displayed in sequence from the left.

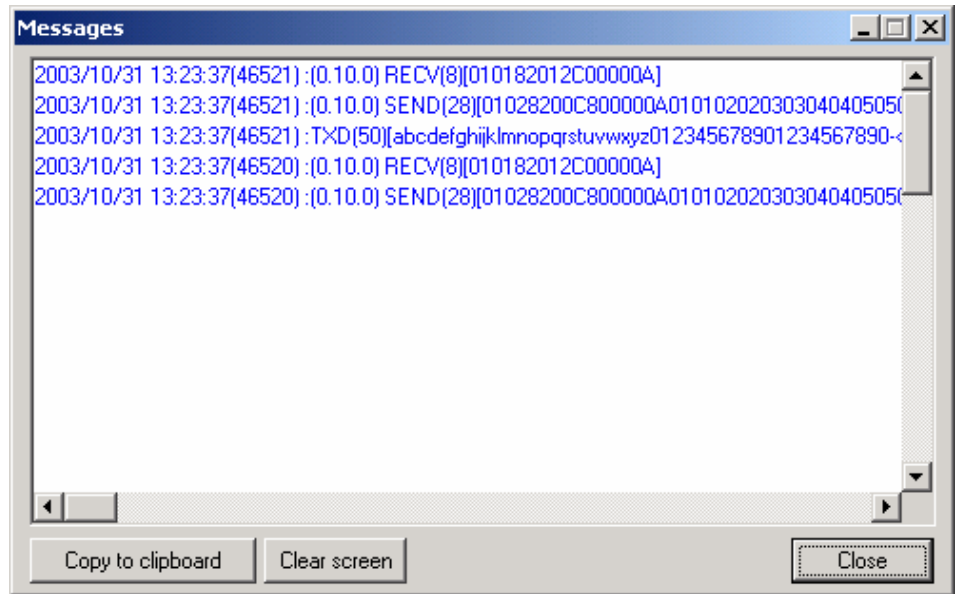

### 5-5-3 Debugging by Serial Data File

Setting the communications settings of serial communications to "File" causes send/receive by serial communications instructions to be performed with read/write from/to a Serial Data File (Write for send and read for receive).

#### Serial Data File

The Serial Data File is a data file individually allocated to each COM port on the computer.

- Folder : PLC data folder\LOG
- Input (receive) file name : COM port name In.txt
- Output (send) file name : COM port name Out.txt

The whole data in the file is read for a single receive operation. For send operation, send data is appended at the end of the file.

Use a commercial text editor or a binary editor to edit a Serial Data File.

### Creating and Using Serial Data Files

Example: Input (Receiving)

Use the following procedure to create and use a serial data file.

- 1,2,3... 1. Create a text file with a user-set name to be used for the receive data.
2. Input the receive data text in the text file created in step 1.
3. Copy the text input as receive data, and paste in the input (receive) file (COM port name In.txt) under the Log Folder (LOG) in the PLC Data Folder.  
Text can also be input directly into an input (receive) file, omitting steps 1 and 2.
4. Save the input (receive) file. (The file's update time will change, and be considered as a received file.)
5. All the data in the file is stored in the reception buffer of the virtual PLC.
6. Input is completed.

This procedure can be used, for example, to receive data in the reception buffer using the virtual PLC's RXD instruction.

**Note** Read the whole data in the input (receive) file when the file update time changes, which is regarded as a receive operation.

**Note** For Host Link communications, a single issue of instruction causes a command send (write to the output file) and a response receive (read from the input file). In this case, it is necessary to create a response data in advance assuming a command to be sent.

### Example of Debugging Program using Barcode reader

The followings show an example of debugging No-protocol communications using a Serial Data File.

- 1,2,3... 1. Display the [Serial Comm. Setting] window by [Status] | [Settings] | [Serial Comm. Setting].
2. Select a serial port for the Serial Communications Unit to be used, followed by pressing [Edit] button to display [Serial Communications Registration] window.
3. Set the communications settings to "File" to select a COM port name.

**Note** Select a COM port name that does not overlap with one allocated in actual communications or another file. Also, a COM port name to be allocated to the Serial Data File can be one that does not actually exist.

4. Press the [OK] button to exit [Serial Communications Registration] window and to return to [Serial Communications Settings] window.
5. After confirming the communications settings and the COM port name are identical to the contents set in procedure 3, press the [OK] button.
6. Create receive data for debugging. Use a commercial text editor or a binary editor to create data conforming to the format of data to be received from the barcode reader. Prepare multiple data according to debugging patterns.

7. Copy the data file created in procedure 6 in the input file (COM port name In.txt).
8. Changing in the file update time causes automatic reception of data from the input file.
9. Execute Step Run, etc. to confirm the process of data received.
10. Repeat the debugging procedures 7 to 9 depending on the contents of serial input data.

**Note** Escape sequences contained in the send/receive data are handled as '\n' (n is a lower-case alphanumeric character.) in the file. For example, the delimiter for Host Link is '\r'.



## **SECTION 6**

# **Debugging Network Communications**

6-1 Outline of Network Communications .....	126
6-2 Network Communications Settings .....	129
6-3 Network Connection .....	132
6-3-1 Send FINS Commands to the External Devices via Network Communications .....	132
6-3-2 Receive FINS Commands from the External Devices via Network Communications .....	132
6-3-3 Precautions when Using Network Communications .....	132
6-4 Example of Debugging Network Communications .....	133
6-4-1 Outline of Debugging Network Communications Instructions .....	133
6-4-2 Debugging with Display Messages .....	134
6-4-3 Debugging with Local Communications .....	134
6-5 Available FINS Commands .....	137
6-5-1 The List of Available FINS Commands .....	137
6-5-2 Restrictions on FINS Commands .....	138

## 6-1 Outline of Network Communications

This section explains the outline of the network communications.

### Introduction

The CX-Simulator can debug network communications by: (1) send/receive FINS commands to the application program (the CPU Unit itself, an application program using FinsGateway, or the CPU Unit of FinsGateway) or (2) screen display of send messages. However, the destination of the FINS commands is only the CPU Unit itself, an application program using FinsGateway, or the CPU Unit of FinsGateway. Thus debugging network communications is possible with the CPU Unit itself or the CPU Unit of FinsGateway as a tentative destination.

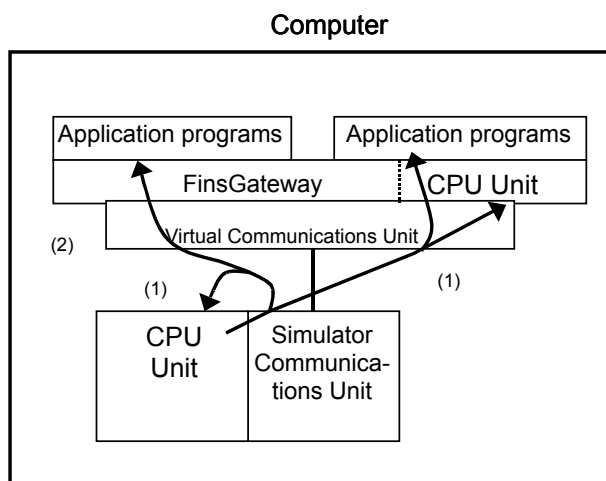

Also, receiving FINS commands from an actual external PLC or a computer connected in the network to the Ladder Engine is possible. (Where sending by network communications instruction is not possible.)

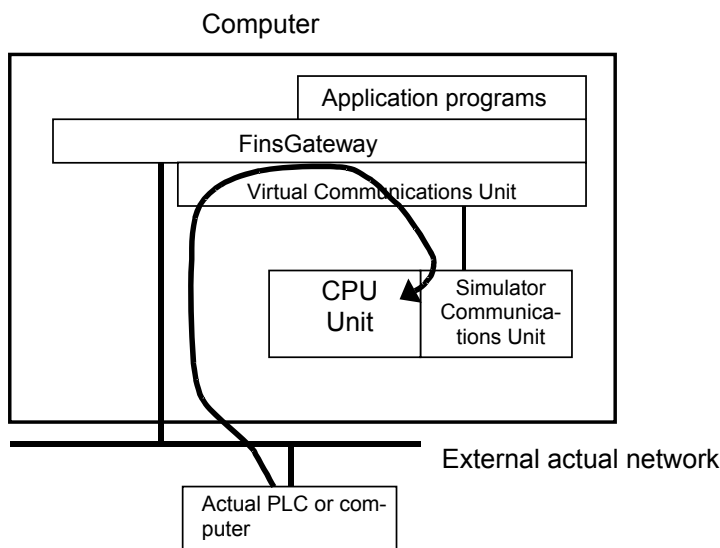

### Supported Protocols and Units

The CX-Simulator supports only FINS communications for network communications and does not support the other communications (e.g. socket communications of the Ethernet Unit). The following virtual Network Communications Units can be used in the CX-Simulator.

Virtual Communications Unit Protocol	Controller Link Unit	Ethernet Unit	Simulator Communications Unit
FINS Communications Servicing	Supported	Supported	Supported
Data Link Function	Not supported	None	None
Socket Servicing	None	Not supported	None
FTP Server Function	None	Not supported	None
Mail Send Function	None	Not supported	None

- Note**
1. The Simulator Communications Unit is the CX-Simulator's own communications unit supporting only FINS communications. When the Controller Link Unit or Ethernet Unit is not used, this unit will be used (default).
  2. This unit is a virtual unit for maintaining the compatibility with CS/CJ/CP-series PLCs. No settings are required for this unit.

### Supported Network Instructions

The instruction words related to serial communications that can be used in a program are shown below.

Instruction	Support	Remarks
SEND/RECV instruction	Yes	Send/Receive data using FINS commands
CMND instruction	Yes	Any FINS command Issue

### I/O Memory Allocation

The outline of I/O memory allocation and the supporting status by the CX-Simulator are shown below.

Area	Allocation Name	Support
Auxiliary Area	Network Communications Enabled Flag (A202)	Yes
	Communications Port Error Flag (A219)	Yes
	Network Communications Completion Code (A203 to A210)	Yes

**Communications Settings of Network communications**

**Communications Settings of Network Communications**

When using network communications instructions in a program, the Communications Settings can be specified for each Unit to be used. The following settings are provided as the Communications Settings of network communications instructions.

Communications Settings	Contents
– (None)	Communications instructions are not processed. (initial value)
Messages	Display the contents of messages sent to the [Display Messages] window. (Actual communications to the node in the computer are not performed.)
Local	Actual communications to the node in the computer are performed (send/receive of FINS commands). (See note.)

**Note** The CX-Simulator does not send FINS commands to outside of the computer. However, FINS commands from outside of the computer to the Ladder Engine can be received. Refer to 6-3 *Network Connection* for details.

**Differences between when set to “–”/ message and when real communications are performed**

The operational differences of the Status Area and Auxiliary Area when set as actual communications are not performed (“–”/ message) are shown below.

Instruction words		Contents
Network instructions SEND/RECV/CMND	Network Communications Error Flag	Always OFF (An error does not occur.)
	Network Communications Enabled Flag	Turns OFF (Disabled) when the command is issued and ON (Enabled) when peripheral servicing in a cycle started.
	Network Communications End code	Cleared (Always normal)

**Functional Restrictions**

**Network Communications Settings**

When adding/changing Network Unit Settings, exit the PLC once. Save I/O memory and take other measures before adding/changing the Unit.

**Software Switch Setting**

Setting the software switch for the Communications Unit can not be performed. Although setting by browsing can be done, it is not used by the CX-Simulator.

**Unit Setting for Ethernet Unit**

Setting the software switch for the Ethernet Unit can not be performed. Although setting by browsing can be done, it is not used by the CX-Simulator.

**Network Instructions when Using Virtual Communications Unit**

Network communications instructions with the FINS address for the Virtual Communications Unit specified can be used even when only the Virtual Communications Unit is set.

**FINS commands to Network Communications Unit**

FINS commands to Network Communications Unit are not supported.

## 6-2 Network Communications Settings

**Note** If the necessary Network Communications Units are registered, proceed to the procedure 5.

- 1,2,3... 1. Adding Network Communications Units: Add Network Communications Units with [System Status] | [Settings] | [Register PLC Unit].

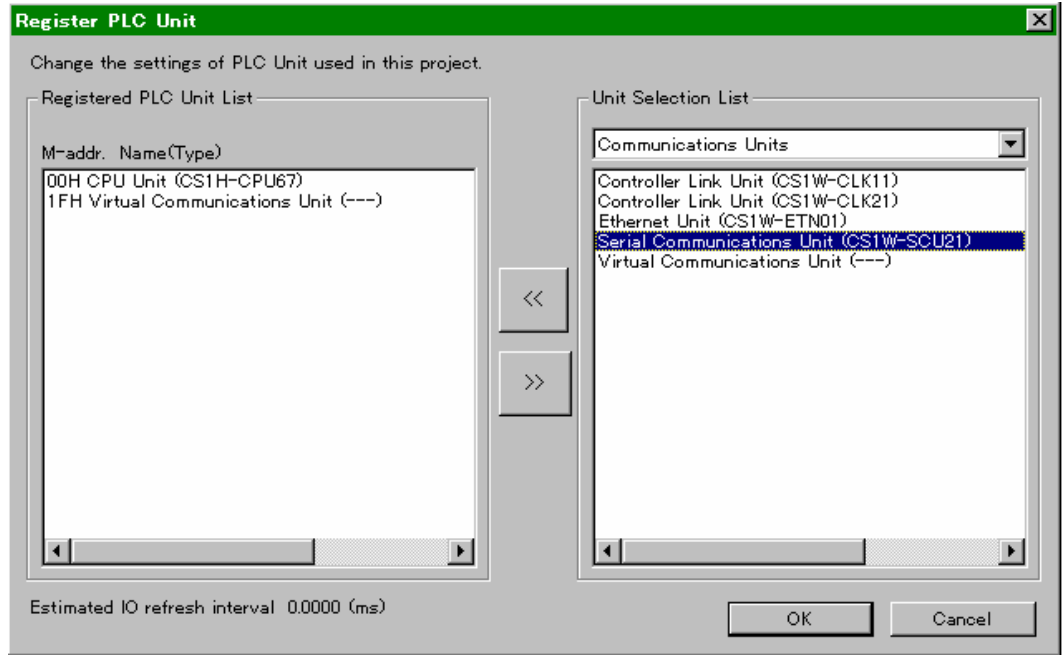

Select the Communications Unit in the Unit Selection List, click the Controller Link Unit or Ethernet Unit, and press the [<<] key to add to the Unit Selection List.

**Note** If Network Communications Units are added/deleted anew, the Ladder Engine will be restarted.

**Note** Register at least one Network Communications Unit even when network communications are not performed. When network communications are not used, use the Virtual Communications Unit registered in default. Registration of the Virtual Communications Unit does not affect the cycle time because its virtual I/O refresh time is 0 ms.

2. The Unit Number Input: Input the Unit number if the Network Communications Unit is added.

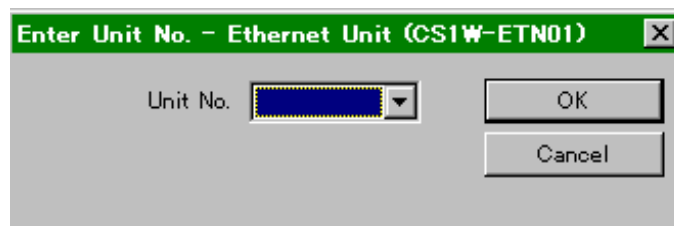

**Note** Set the Unit number so as not to overlap with the one of another CPU Bus Unit. The Unit number of the Virtual Communications Unit is set to "15" in default.

3. Press the [OK] button to return to the [Register PLC Unit] window and register the Unit in the Unit Registration List.
4. Press the [OK] button to register the Network Communications Unit.
5. The Network Communications settings will be displayed in the [System Status] | [Settings] | [Network Communications Settings] window.

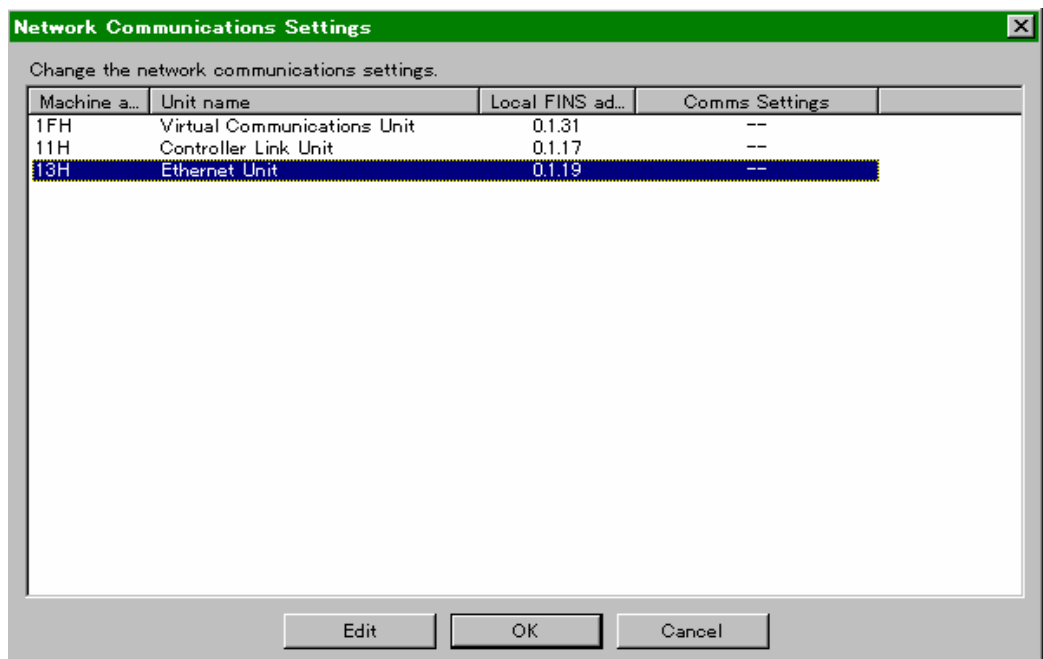

6. Network Communications Settings Registration: Selecting the Network Communications Unit to be set followed by clicking the [Edit] button will display the [Register Network Communications] window.

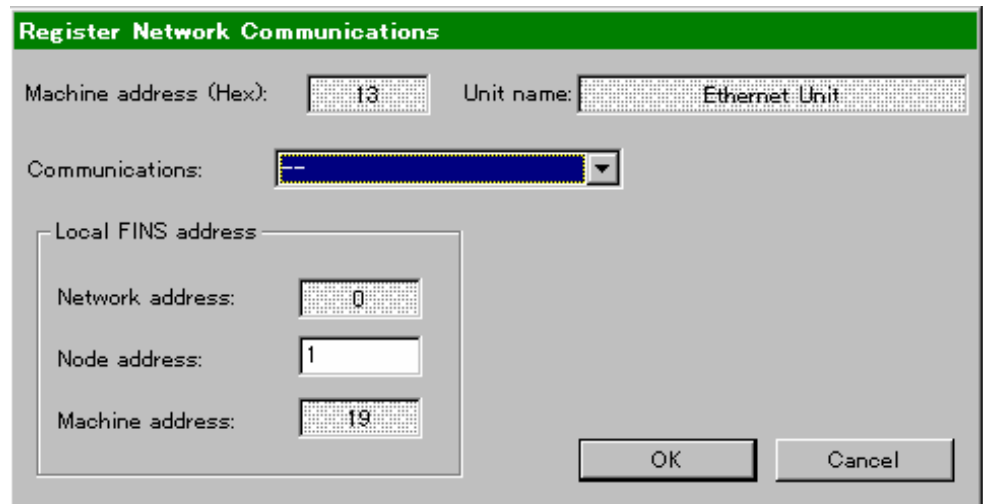

7. The Node Address Setting: Set the node address within the local FINS address for the Network Communications Unit. The network address and the unit address can not be changed.

**Note** Set the node address so as not to overlap with the one of other Communications Unit or FinsGateway Virtual Communications Unit. [Connect to the CX-Simulator] will fail if overlapped. If the node address is changed, the Ladder Engine will be restarted.

8. Communications Settings: Select from the [Communications] drop down list according to the purpose. The following items can be selected.

Comm. Settings	Contents
– (None)	Communications instructions are not processed. (default)
Messages	Display the contents of the messages sent to the [Display Messages] window.
Local	Perform actual communications to a node in the computer.

**Note** Comm. Settings is for ladder diagram instructions (SEND/RECV/CMND). All of the communications from external devices to the Ladder Engine will be valid regardless of the restrictions in the Comm. Settings.

9. Press [OK] to exit the [Register Network Communications] window and to return to the [Network Communications Settings] window.
10. Exit the Network Communications Settings window: Repeat the procedures 5 to 9 as required. Press [OK] when completed.

## 6-3 Network Connection

### 6-3-1 Send FINS Commands to the External Devices via Network Communications

FINS commands by the Network Communications instruction of the CX-Simulator can not be sent to the outside of the computer due to the CX-Simulator's restrictions.

FINS commands by the Network Communications instruction can be sent only within the computer. Therefore, communications with an application program using FinsGateway on the computer or the CPU Unit of FinsGateway are possible.

### 6-3-2 Receive FINS Commands from the External Devices via Network Communications

When sending FINS commands from the external devices to the Ladder Engine via Network Communications, there are no special restrictions. The same network connection as actual CS/CJ/CP-series PLCs can be performed.

#### Create the Routing Table

The following operation is required because the network used by the CX-Simulator is different from the one connected to external devices.

- Set the routing table for FinsGateway of the computer.
- Set the relay network table for the Ladder Engine.

**Note** For instructions on setting the routing tables, refer to *Section 3* of the *CX-Integrator Operation Manual (W464)*.

### 6-3-3 Precautions when Using Network Communications

#### Duplicate FINS Address

If the node address for the network communications unit of the Ladder Engine overlaps with the one of the FinsGateway Virtual Communications Unit when [Connect], communications can not be performed. To avoid this situation, change the FINS node address for either the network communications unit of the Ladder Engine or for the FinsGateway Virtual Communications Unit.

#### Update the Routing Table

Do not transfer the routing table (local network table) to the Ladder Engine. Doing so may disable an access from external devices depending on the setting contents of the own network table.

Even when the file saved by the other PLC is read, a similar trouble may occur depending on the setting contents of the PLC routing table.

If an access from external devices is disabled, perform [Disconnect] and then [Connect]. The routing table (local network table) will automatically be changed and an access from external devices will be enabled.

When reconnecting, set the FINS address displayed in the Guide to Connect of the [Work CX-Simulator] window to the CX-Programmer.

The relay network table will not be changed automatically. Set the relay network table as required.



## 6-4 Example of Debugging Network Communications

### 6-4-1 Outline of Debugging Network Communications Instructions

- 1,2,3...
1. Set the Communications settings as "-" to debug a part unrelated to the network.
    - Select [System status] | [Settings] | [Network Communications Settings] to display the [Network Communications Settings] window.
    - Set the Communications settings as "-" for all communications units.
  2. Set the Communications settings as "Messages" for displaying the FINS commands to check the contents of the messages.
    - Select [System status] | [Settings] | [Network Communications Settings] to display the [Network Communications Settings] window.
    - Set the Communications settings as "Messages" for the communications unit to be debugged.
  3. Set the Communications settings as "Local" followed by issuing SEND/RECV instructions to the CPU Unit of FinsGateway to check the FINS communications (only for DM and CIO).
    - Select [System status] | [Settings] | [Network Communications Settings] to display the [Network Communications Settings] window.
    - Set the Communications settings as "Local" for the communications unit to be debugged.
    - Change the FINS address for the control data of SEND/RECV instruction to the one for the CPU Unit of FinsGateway.

**Note** Confirm that the target area is not used by other application programs when using a SEND instruction to the CPU Unit of FinsGateway.



**How to Specify FINS address for CPU Unit of FinsGateway**

Specify the network FINS address and node FINS address of FinsGateway Communications Unit displayed in the [Work CX-Simulator]. Specify "00" for the Machine No.

The diagram illustrates the mapping of FINS addresses. A 'SEND' block contains addresses D00100, D00200, and D00300. Arrows indicate: S: Send origin send start word address (D00100), D: Send origin receive start word address (D00200), and C: Control data lower word address (D00300). Below, two tables show word data for addresses C: D00300 through C+4: D00304. The top table shows Node No. = 03 and Machine No. = 00. The bottom table shows Node No. = 11 and Machine No. = 00. An arrow points from the circled 'Node address' field in the simulator to the 'C: D00300' row in the bottom table.

C: D00300	00	0A	Send words = 10
C+1: D00301	00	00	The device on the local network
C+2: D00302	03	00	Node No. = 03
C+3: D00303	07	03	Machine No. = 00
C+4: D00304	00	64	

C: D00300	00	0A	Send words = 10
C+1: D00301	00	00	The device on the local network
C+2: D00302	11	00	Node No. = 11
C+3: D00303	07	03	Machine No. = 00
C+4: D00304	00	64	

**Setting and Checking Values**

Use the following tools to set and check the values for the CPU Unit of FinsGateway.

- The CX-Programmer User Using an OMRON easy monitoring tool allows to check the values if the CPU Unit of FinsGateway is set as the destination.
- FinsGateway RUNTIME User Using the event memory utility attached to FinsGateway allows to check the values if the CPU Unit of FinsGateway is set as the destination.



**Caution**

When the CX-Simulator is used together with the Data Link function, the Memory Mapping function of the FinsGateway, or the Cyclic Server of the FinsServer Series, the operation of external devices connected to the computer may be affected. Do not activate these functions if they do not need to be used simultaneously. Unexpected operation of the external devices may cause an accident.

**Note** Refer to *FinsGateway Version2 RUNTIME Operation Manual* for FinsGateway data link setting. Refer to the operation manuals attached to the hardware such as Controller Link support board for data link function itself. Refer to *Section 5 FinsServer Series Common Functions Cyclic Server* of *FinsServer Series Handbook* attached to FSV-Comm or DataFlowNavi for Access for the Cyclic Server of FinsServer Series.

## 6-5 Available FINS Commands

### 6-5-1 The List of Available FINS Commands

Type	Command code		Name	Function
I/O Memory Area Access	01	01	MEMORY AREA READ	Reads consecutive data from the I/O memory area.
	01	02	MEMORY AREA WRITE	Writes consecutive data to the I/O memory area.
	01	03	MEMORY AREA FILL	Fills the specified range of I/O memory with the same data.
	01	04	MULTIPLE MEMORY AREA READ	Reads non-consecutive data from the I/O memory area.
	01	05	MEMORY AREA TRANSFER	Copies and transfers consecutive data from one part of the I/O memory area to another.
Parameter Area Access	02	01	PARAMETER AREA READ	Reads consecutive data from the parameter area.
	02	02	PARAMETER AREA WRITE	Writes consecutive data to the parameter area.
	02	03	PARAMETER AREA FILL	Fills the specified range of the parameter area with the same data.
Program Area Access	03	06	PROGRAM AREA READ	Reads data from the user program area.
	03	07	PROGRAM AREA WRITE	Writes data to the user program area.
	03	08	PROGRAM AREA CLEAR	Clears the specified range of the user program area.
Execution Control	04	01	RUN	Switches the CPU Unit to RUN, MONITOR, or DEBUG mode.
	04	02	STOP	Switches the CPU Unit to PROGRAM mode.
Configuration Read	05	01	CONTROLLER DATA READ	Reads CPU Unit information.
	05	02	CONNECTION DATA READ	Reads the model numbers of the specified Units.
Status Read	06	01	CONTROLLER STATUS READ	Reads the CPU Unit's status information.
	06	20	CYCLE TIME READ	Reads the average, maximum, and minimum cycle times.
Clock Access	07	01	CLOCK READ	Reads the clock.
	07	02	CLOCK WRITE	Sets the clock.
Message Access	09	20	MESSAGE READ/CLEAR	Reads/Clears messages and FAL(S) messages.
Access Right	0C	01	ACCESS RIGHT ACQUIRE	Acquires the access right if no other device holds it.
	0C	02	ACCESS RIGHT FORCED ACQUIRE	Acquires the access right even if another device currently holds it.
	0C	03	ACCESS RIGHT RELEASE	Releases the access right regardless of what device holds it.
Error Access	21	01	ERROR CLEAR	Clears errors and error messages.
	21	02	ERROR LOG READ	Reads the error log.
	21	03	ERROR LOG CLEAR	Clears the error log pointer to zero.
File Memory	22	01	FILE NAME READ	Reads the file memory's file information.
	22	02	SINGLE FILE READ	Reads the specified amount of data from the specified point in a file.
	22	03	SINGLE FILE WRITE	Writes the specified amount of data from the specified point in a file.
	22	04	FILE MEMORY FORMAT	Formats file memory.
	22	05	FILE DELETE	Deletes the specified files from file memory.
	22	07	FILE COPY	Copies a file within file memory or between two file memory devices in a system.
	22	08	FILE NAME CHANGE	Changes a file name.

Type	Command code		Name	Function
File Memory	22	0A	MEMORY AREA FILE TRANSFER	Transfers or compares data between the I/O memory area and file memory.
	22	0B	PARAMETER AREA FILE TRANSFER	Transfers or compares data between the parameter area and file memory.
	22	0C	PROGRAM AREA FILE TRANSFER	Transfers or compares data between the program area and file memory.
Forced Status	23	01	FORCED SET/RESET	Force-sets, force-resets, or clears the forced status of the specified bits.
	23	02	FORCED SET/RESET CANCEL	Cancels the forced status of all force-set and force-reset bits.

## 6-5-2 Restrictions on FINS Commands

### Formatting File Device

In the CX-Simulator, the file device of the CS/CJ-series PLC is virtually allocated to the part of the hard disk in the computer. Thus, "Formatting the File Device" will not actually format the file. If a folder allocated as a file memory does not exist, the folder will be created.

## **SECTION 7**

# **Connection with Application Programs**

7-1 Outline of Connection.....	140
7-1-1 What is Connection with Application? .....	140
7-2 Connection with Application Programs.....	141
7-2-1 Connection Methods.....	141
7-2-2 Coexist in the Same Computer .....	141
7-2-3 Connection via Network.....	143

## 7-1 Outline of Connection

This section explains the methods of connection with applications that perform communications with the PLC to debug them using the CX-Simulator.

### 7-1-1 What is Connection with Application?

The CX-Simulator can debug application programs that perform communications with OMRON's PLC (e.g. a monitor program and a data collection program) without an actual PLC connected, only on a computer.

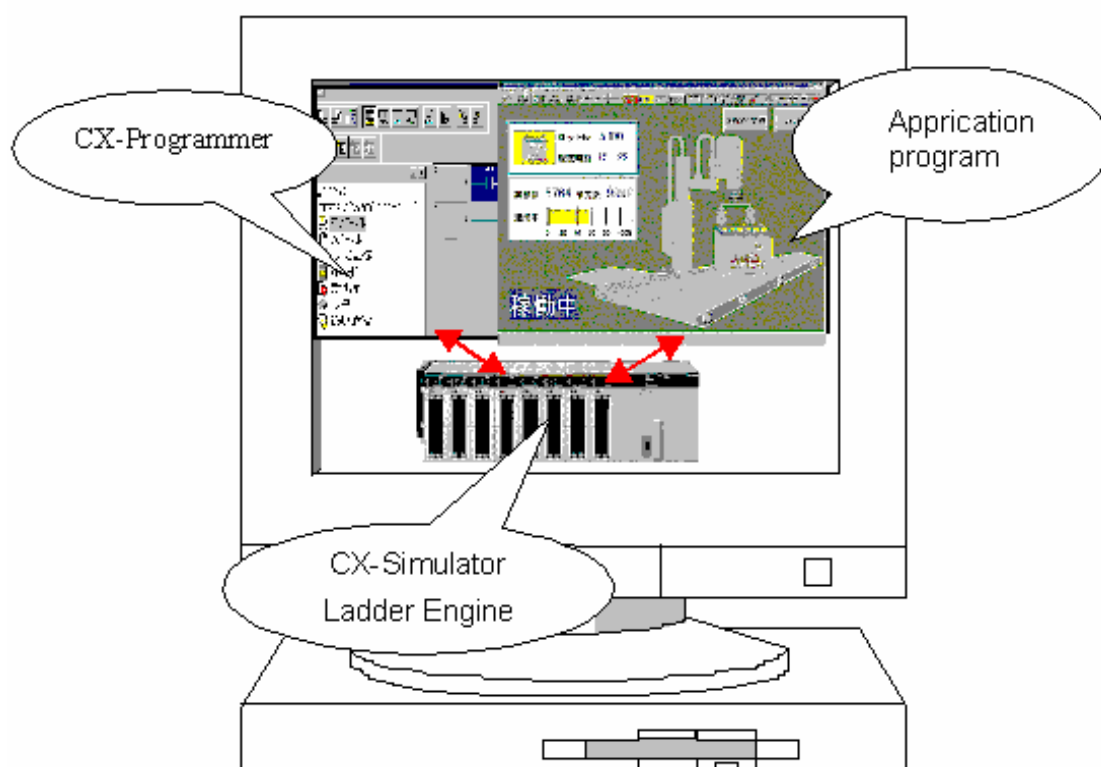

**Note** When using an application program, the CX-Simulator, and the CX-Programmer simultaneously, use them in an environment with enough memory capacity: the capacity mentioned in *1-4 Applicable PLC models and Computers* plus that required by the application program.



## 7-2 Connection with Application Programs

### 7-2-1 Connection Methods

There are two methods for connecting the CX-Simulator with application programs as follows:

- Coexist in the same computer      An application program using FinsGateway for communications.
- Connection via network      An application program sending/receiving FINS commands via Ethernet from a real-time OS, UNIX, or another computer.

- Note**
1. Always install FinsGateway separately when connecting to applications.
  2. All of the above methods assume the connection by polling from an application program (An application program sends a FINS command and the Ladder Engine returns a FINS response.). Connection via network is not available for "slave initiation" from the Ladder Engine (Communications using SEND from a sequence program to an application program.).

### 7-2-2 Coexist in the Same Computer

The following shows a connection method where the CX-Simulator, the CX-Programmer, and an application program coexist in the same computer.

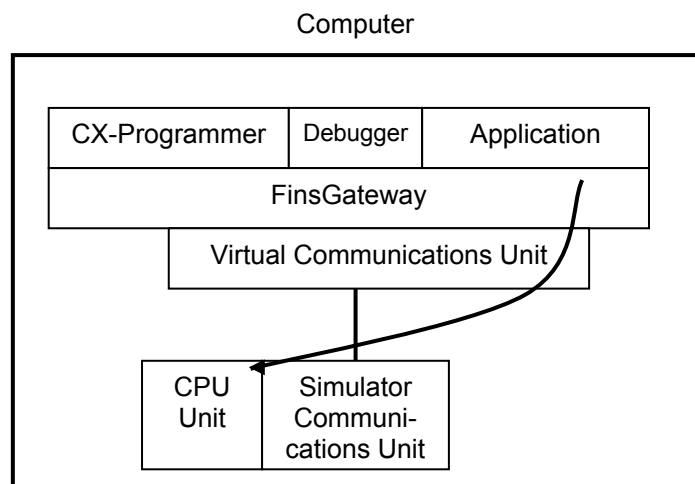

- 1,2,3...**
1. Start the CX-Simulator and select a PLC data folder required in debugging an application program to display the windows of [CX-Simulator Debug Console], [System Status], and [Work CX-Simulator].
  2. Click the [Connect] button in the [Work CX-Simulator] window.
  3. Register the FINS address displayed in the [Guide to Connect] window to the FINS communications address settings.

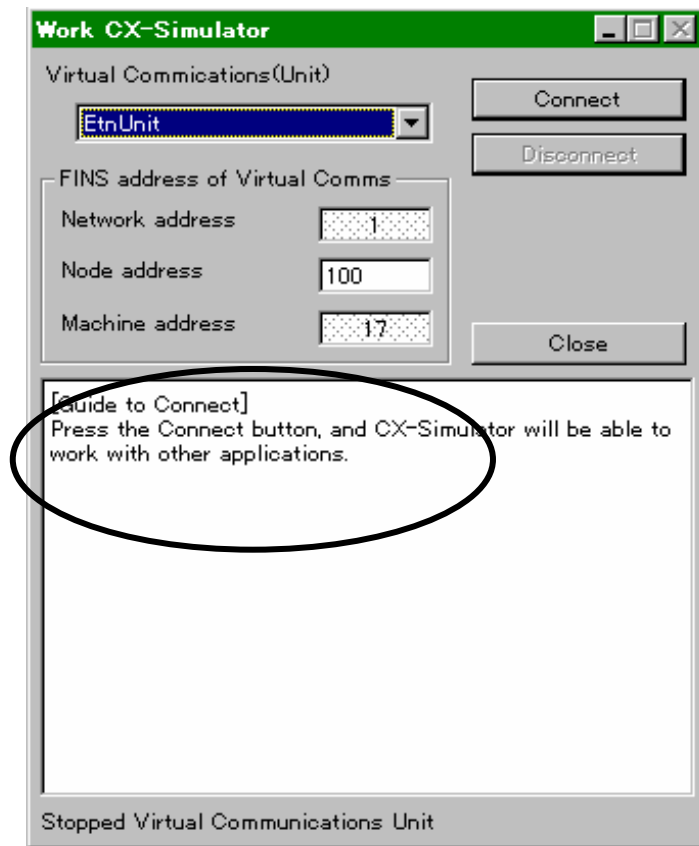

- If the FINS address set by the application program can not be changed, [Disconnect the Simulator] and then change the node address of the network communications unit in the [System Status] | [Settings] | [Network Communications Settings] window.

**Note** The CX-Simulator generates a FINS network address automatically when [Connect]. Use the FINS network address displayed when [Connect] as that to be used by the application program.

- If multiple networks exist, the routing table for FinsGateway must be changed. For instructions on changing the routing tables, refer to *Section 3* of the *CX-Integrator Operation Manual (W445)*.

4. Turn the Run mode of the Ladder Engine to [Continuous Run] in the [CX-Simulator Debug Console] window.

5. Execute the application program to check its operation.

**Note** When changing the contents of I/O memory areas of the Ladder Engine for debugging application programs, use the CX-Programmer.

### 7-2-3 Connection via Network

This section describes how to connect an application program on another computer to the Ladder Engine via network (Ethernet).

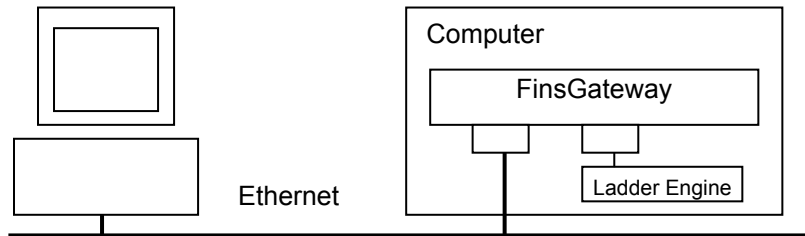

**Note** When connecting via network, the routing table must be set for FinsGateway and the relay network table for the Ladder Engine because two communications lines are required for the computer with the CX-Simulator. For instructions on setting the routing tables (including the relay network table), refer to *Section 3* of the *CX-Integrator Operation Manual (W464)*.

**Note** When connecting via Ethernet, the Runtime version of FinsGateway is separately required for the computer with the CX-Simulator.

- 1,2,3...**
1. Start the FinsGateway Service Manager to activate the CPU Unit and the Ethernet Unit of FinsGateway.
  2. Start the CX-Simulator to select the PLC data folder required to debug application programs. Each window of [Work CX-Simulator], [CX-Simulator Debug Console], and [System Status] will be displayed.
  3. Clicking the [Target Comm. Unit] drop-down list in the [Work CX-Simulator] window will display the list of usable communications units of FinsGateway. Select Controller Link Unit in the list.
  4. Click the [Connect] button to display the FINS address of the Ladder Engine in the [Guide to Connect].

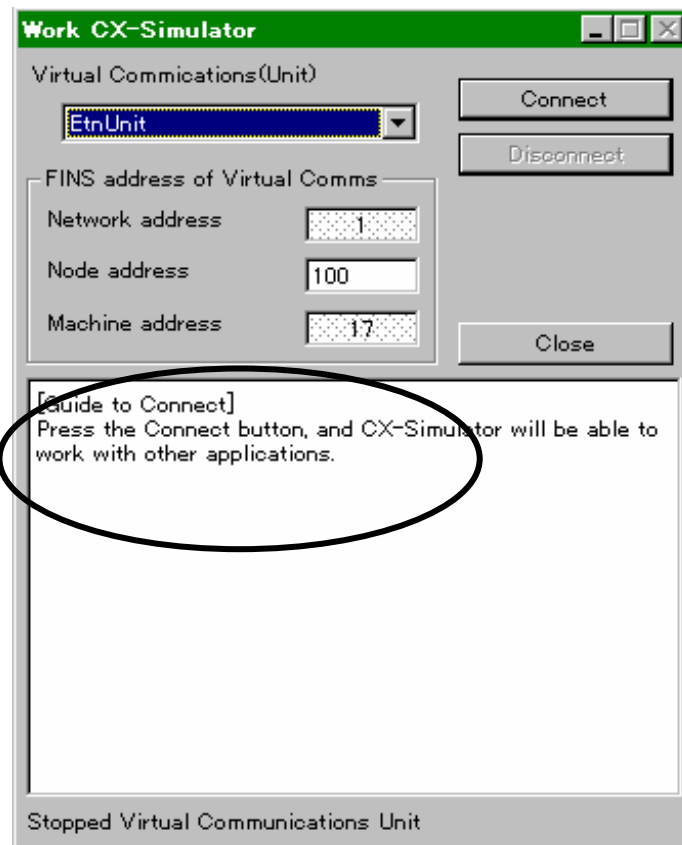

5. Set the FINS address displayed in the [Guide to Connect] to the target FINS address of the application program.
  - If the node address set by the application program can not be changed, change the node address of the network communications unit in the [System Status] | [Settings] | [Network Communications Settings] window.
6. Start the CX-Programmer on the computer where the CX-Simulator was started to select CX-Integrator (network settings) in the [Tool] menu, displaying CX-Net.

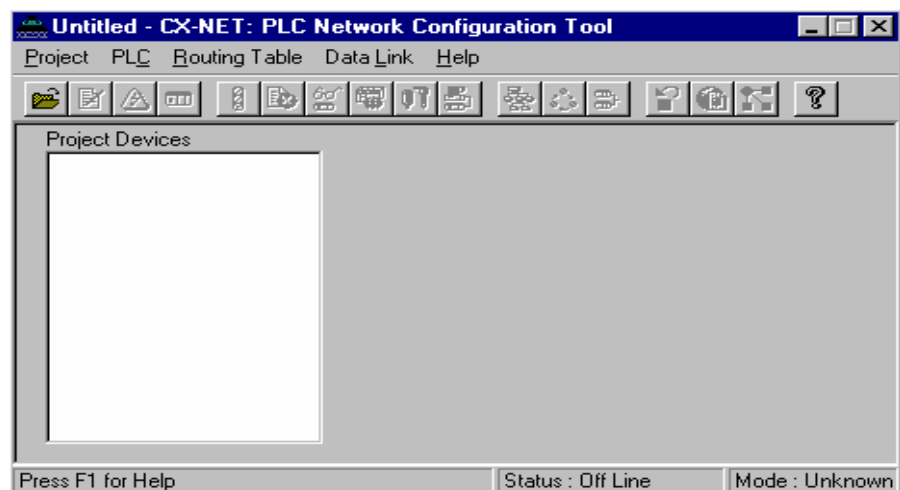

**Note** For instructions on setting the routing tables (including the relay network table), refer to *Section 3* of the *CX-Integrator Operation Manual (W464)*.

7. Set the relay network table for the Ladder Engine.
8. Set the Run mode of the Ladder Engine to [Continuous Run] in the [Debug Console] window.
9. Execute the application program to check its operation.

**Note** The relay network table will be deleted when [Disconnect]. Set the relay network table using the CX-Integrator again after [Connect] when needed.



## SECTION 8

# Debugging Using Virtual External Inputs

8-1 Outline of Virtual External Input Function.....	148
8-1-1 Outline of Virtual External Input Function .....	148
8-2 Debugging Using Virtual External Inputs .....	149
8-2-1 Outline of Debugging Using Virtual External Inputs.....	149
8-3 Generating Virtual External Inputs.....	152
8-3-1 Command Log.....	152
8-3-2 Data Trace File .....	156
8-3-3 Data Replay File (CSV-format text file) .....	157
8-3-4 Multipoint Data Collection Tool .....	159
8-3-5 Messages Displayed in the Error history .....	162
8-3-6 I/O Condition Expressions .....	162
8-3-7 Ladder Program for Debugging .....	165
8-4 Running by Virtual External Inputs.....	166
8-4-1 Running by Virtual External Inputs .....	166
8-4-2 How to Run by Data Replay Tool .....	166
8-4-3 Replay Using the I/O Condition Tool .....	170
8-4-4 How to Replay Using the Program Area for Debugging.....	172
8-5 Checking the Result.....	174
8-5-1 Checking by Time Chart Monitor of the CX-Programmer .....	174
8-5-2 Checking with Graphing by Excel Using the Data Replay File .....	175

## 8-1 Outline of Virtual External Input Function

### 8-1-1 Outline of Virtual External Input Function

After completing static debugging, it is necessary to debug a program assuming external inputs such as a sensor in the actual running.

In the conventional debugging, it used to be necessary to give actual inputs from switches or tools assuming sensor inputs, motor outputs, or others and to visually check the outputs, requiring a lot of man-days.

The CX-Simulator is equipped with such functions as to automate creating virtual external inputs and the data for executing/monitoring debugging patterns and to save its workload.

Function	Contents
Command log save	The CX-Simulator saves operation history of the CX-Programmer as FINS commands. Executing the saved data can be repeated using the Data Replay Tool.
Data Trace	The actual PLC's data trace data saved by the CX-Programmer's data tracing or time chart monitoring can be input to the CX-Simulator using the Data Replay Tool. Also, long-term data that can not be saved by the CX-Programmer's data tracing can be saved using Data Trace Recording Tool.
Multipoint Data Collection Tool	Possible to take in data from an actual PLC and to give the data as input data to the CX-Simulator using the Data Replay Tool. Unlike Data Trace, every-cycle data can not be read. However, more than 50 words of data can be read.
Data Replay	Each data of the command log (.flg), the Data Trace file (.cdt), and Data Replay file (.cvs) can be input to the CX-Simulator as virtual external inputs. Also, the results can be saved as the Data Replay file.
I/O Condition Operation	The trigger conditions of I/O memory areas can be described in logic expressions and the value can be given to the I/O memory area as virtual external inputs when a set time elapses after the expressions hold. Multiple expressions can be processed simultaneously.
Program area for debugging (UM2)	In addition to the program area for applications (UM1), the CX-Simulator provides the program area where the ladder program, sharing the I/O memory area with UM1, for creating virtual external inputs is executed (UM2). Virtual external inputs can be created in the ladder program.



## 8-2 Debugging Using Virtual External Inputs

### 8-2-1 Outline of Debugging Using Virtual External Inputs

#### 1,2,3... 1. Considering debugging items.

Decide debugging items using virtual external inputs.

#### 2. Considering debugging methods

Decide debugging methods using virtual external inputs. Decide the generation method of the virtual external input data according to the debugging contents.

#### 3. Generating virtual external inputs

Generate virtual external inputs. The contents are different depending on a data generation method.

Refer to 8-3 *Generating Virtual External Inputs*.

#### 4. Running by virtual external inputs

Actually generate virtual external inputs to run the program.

Refer to 8-4 *Running by Virtual External Inputs*.

#### 5. Checking the result

Check the result caused the program execution. The time chart monitoring, the data tracing, and the Data Replay file of the CX-Programmer can be used to check.

Refer to 8-5 *Checking the Result*.

### Debugging Items

Consider debugging items in the following viewpoints, for example.

- Normal/Abnormal operation
- Automatic/Semi-automatic/Manual
- Interlocking among equipment
- Data collection/monitoring from the application programs on the computer

### Debugging Methods

Consider debugging methods in the following viewpoints, for example.

- Data from actual units is available. → Data tracing
- Easily operable from the CX-Programmer. → Command log
- Describe operation conditions in logic expressions. → I/O Condition
- Try complicated input conditions. → Ladder program for debugging

**Generating Virtual External Inputs**

	Setting data	Contents
Command log	Static setting with a data file	Perform necessary operation from the CX-Programmer and save its history to a file.
Data trace	Static setting with a data file	Read the contents of data trace from the actual CS/CJ-series CPU Unit by the CX-Programmer and save them to a file.
Data Replay File	Static setting with a data file	Register necessary data to a CSV-format data file.
I/O Condition Setting	Dynamic setting with I/O condition expressions	Set I/O conditions for inputting in logic expressions combining I/O memory conditions.
Program area for debugging (UM2)	Dynamic setting with ladder programs	Create a ladder program that inputs to a ladder program for applications.

**Running by Virtual External Inputs**

	Contents
Data Replay Tool	Read data in sequence from the data file (command log, data trace, or Data Replay file) and set them to the Ladder Engine.
I/O Condition Tool	Monitor the I/O memory areas and set data when the conditions hold.
Program area for debugging (UM2)	Download the ladder program for debugging to the program area for debugging (UM2) and execute it at the same time as the ladder program for application.

**Checking the result**

	Contents
Time chart monitor/Data trace	Check the result caused by virtual external inputs using the CX-Programmer's time chart monitoring and the display function of data trace.
Data Replay File/Table and Graph display	Output the result as a file (CSV format) while Data Replay and read it to a commercial spreadsheet software to check it as tables and graphs.

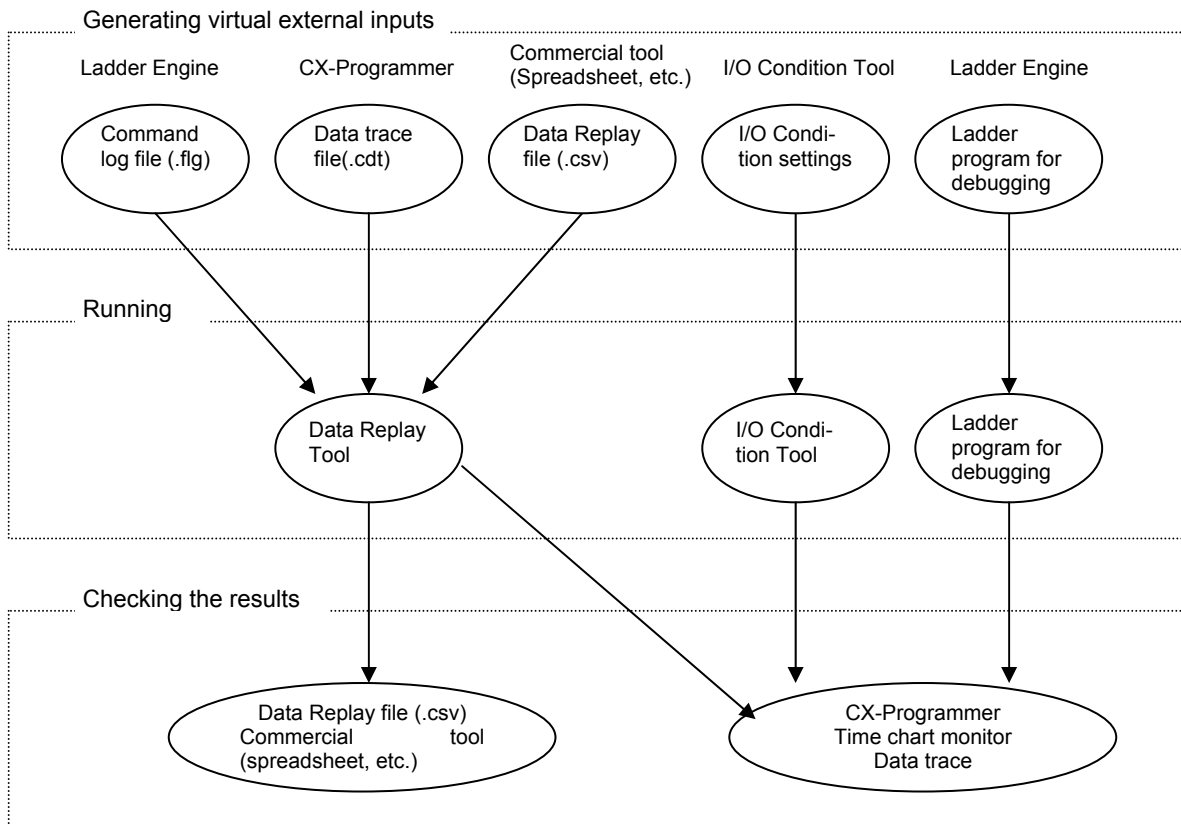

## 8-3 Generating Virtual External Inputs

### 8-3-1 Command Log

The Command Log File (.flg) contains the operation history (actually the communications commands history of FINS communications) such as read/write of I/O memory areas and force-set/reset executed by the CX-Programmer. Besides, FINS communications from application programs, etc. can be stored as a history. Replaying this file using Data Replay Tool substitutes manual input operation to the Ladder Engine.

**Note** Refer to 8-4 *Running by Virtual External Inputs* for replaying with Data Replay Tool.

#### Setting for Creating Command Log

Set for saving the command log in the [CX-Simulator Debug Console] | [Replay] | [Command log] | [Settings].

- 1,2,3... 1. Select [Settings] in the [CX-Simulator Debug Console] | [Replay] | [Command log] to display the [Command Log Settings] window.

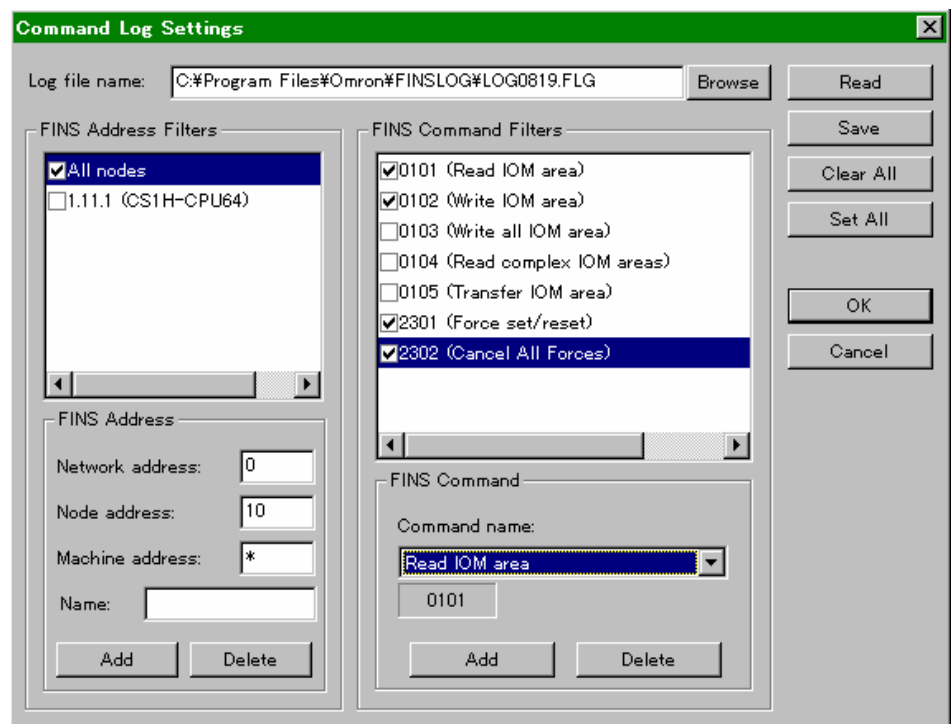

2. Specify the file name for saving the log file. Key-in the name to the text box for the log file name or click the [Browse] button to input from the file dialog box.
3. Set the FINS address filter. Mark the appropriate items in the list of the FINS address filter. Usually "All nodes" is selected. Add/delete of items are also possible.
4. Set the FINS command filter. Mark the appropriate items in the list of the FINS command filter. Add/delete of items are also possible.

5. Click the [Set All] button if selecting all items registered in the FINS address/command filter. Click the [Clear All] if clearing all check items.
6. Selecting the [OK] button will cause the settings valid.

### **Command Log Save Start/Exit**

Set the “Command Log Save Start” after setting the “Command log.”

Start the “Command Log Save” by [CX-Simulator Debug Console] | [Replay] | [Command log] | [Start]. If exiting or pausing the “Command Log Save,” select [Stop] in [Debug Console] | [Replay] | [Command log].

### **FINS Address Filter**

Specify the FINS address filter if filtering by the FINS address.

Some FINS addresses for application programs on the computer change dynamically (FINS addresses of the CX-Programmer change, also.). So usually use the CX-Simulator in the default setting (FINS address =\*. \*.\*: All nodes).

When adding items to the list of FINS address filter, input the FINS address to be added (the network address, node address, and Machine address (Unit address)) and its name (tentative) followed by the [Add] button.

In specifying the address, an "\*" can also be specified. For example, if an "\*" is specified for the Machine address setting, the FINS command to/from the specified address will be saved as the command log.

When deleting the items in the list of FINS address filter, select the item to be deleted in the list and click the [Delete] button.

### **FINS Command Filter**

Specify the FINS command filter when filtering by the FINS command. Filtering is performed by comparing the character string data (hex) from the top of the FINS command. For example, when writing to the EM area (common), the filtering pattern will be 01012, saving 010121 (EM area write (Bank 1), 01012A (EM area write (Bank 10), etc. to the Command Log File.

Refer to *List of Usable FINS Command Filters and Data Replay Possible/Not possible* for usable FINS command filters and whether the saved data is possible to be replayed or not.

When adding items to the list of FINS command filter, select the items to be added (FINS command name) in the dropdown list of the FINS command filter.

When deleting items from the list of FINS command filter, select the items to be deleted in the list and click the [Delete] button of the FINS command filter.

- Note** At least one FINS address/command filter must be set respectively to create the command log. An error will not occur in the Data Replay Tool even if a filter that can not be replayed is set.
- Note** The details for FINS commands are given in the *Communications Commands Reference Manual*.
- Note** The upper limit of the command log file size is 30 MB. If exceeded, the log data will not be saved after that.

List of Usable FINS Command Filters and Data Replay Possible/Not possible

**Access IOM area**

MR	SR	FINS Command	Replay possible
01	01	Read IOM area	Not possible
01	02	Write IOM area	Possible
01	03	Write all IOM area	Possible
01	04	Read complex IOM areas	Not possible
01	05	Transfer IOM area	Possible

**Access parameter area**

MR	SR	FINS Command	Replay possible
02	01	Read IOM area	Not possible
02	02	Write IOM area	Possible
02	03	Write all IOM area	Possible

**Execution controls**

MR	SR	FINS Command	Replay possible
04	01	Execution Controls (Start)	Possible
04	02	Execution Controls (Stop)	Possible

**Access time info**

MR	SR	FINS Command	Replay possible
07	01	Read time info	Not possible
07	02	Write time info	Possible

**Exchange messages**

MR	SR	FINS Command	Replay possible
09	20	Message read/cancel	Possible

**Maintenance**

MR	SR	FINS Command	Replay possible
21	01	Cancel Error	Possible
21	02	Read Error log	Not possible
21	03	Clear Error log	Possible

**Peripheral devices**

MR	SR	FINS Command	Replay possible
22	0A	IOM area←→File transfer	Possible
22	0B	Parameter←→File transfer	Possible
22	0C	IN-UM←→File transfer	Possible

**Debugging**

MR	SR	FINS Command	Replay possible
23	01	Force set/reset	Possible
23	02	Cancel All Forces	Possible

**Read IOM area**

MR	SR	PM	FINS Command	Replay possible
01	01	30	Read CIO Area bits	Not possible
01	01	31	Read Work Area bits	Not possible
01	01	32	Read Hold Area bits	Not possible
01	01	33	Read Auxiliary Area bits	Not possible
01	01	B0	Read CIO Area words	Not possible
01	01	B1	Read Work Area words	Not possible
01	01	B2	Read Hold Area words	Not possible
01	01	B3	Read Auxiliary Area words	Not possible
01	01	09	Read Timer/Counter Completion Flag	Not possible
01	01	89	Read Timer/Counter PV	Not possible
01	01	02	Read DM bits	Not possible
01	01	82	Read DM words	Not possible
01	01	2	Read EM bits (common)	Not possible
01	01	A	Read EM words (common)	Not possible
01	01	98	Read EM words (current bank)	Not possible
01	01	BC	Current EM Bank No.	Not possible
01	01	06	Read task flag bit	Not possible
01	01	46	Read task flag status	Not possible
01	01	DC	Read Index Register PV	Not possible
01	01	BC	Read Data Register PV	Not possible
01	01	07	Read Clock/Condition bit	Not possible

**Write IOM area**

MR	SR	PM	FINS Command	Replay possible
01	02	30	Write CIO Area bits	Possible
01	02	31	Write Work Area bits	Possible
01	02	32	Write Hold Area bits	Possible
01	02	33	Write Auxiliary Area bits	Possible
01	02	B0	Write CIO Area words	Possible
01	02	B1	Write Work Area words	Possible
01	02	B2	Write Hold Area words	Possible
01	02	B3	Write Auxiliary Area words	Possible
01	02	89	Write Timer/Counter PV	Possible
01	02	02	Write DM bits	Possible
01	02	82	Write DM words	Possible
01	02	2	Write EM bits (common)	Possible
01	02	A	Write EM words (common)	Possible
01	02	98	Write EM words (current bank)	Possible
01	02	BC	Current EM Bank No.	Possible
01	02	DC	Write Index Register PV	Possible
01	02	BC	Write Data Register PV	Possible

MR: Main, SR: Sub, PM: Parameter

**Note** If Replay is not possible, the I/O memory areas do not change although send/receive of data is executed when Replay.

### 8-3-2 Data Trace File

The time-series data (Data Trace File) of I/O memory area acquired from an actual PLC can be replayed on the Ladder Engine using the Data Replay Tool.

**Note** Refer to *8-4 Running by Virtual External Inputs* for replaying by Data Replay Tool.

Create a Data Trace File using the data trace or the time chart monitor of the CX-Programmer, or Data Trace Recording Tool for long-term data.

#### Creating Data Trace Data using CX-Programmer

Use the Data Trace File (.cdt) created in the data trace or the time chart monitor of the CX-Programmer for the data of data trace.

Set necessary data using the CX-Programmer and execute the data trace or the time chart monitor on the CS/CJ/CP-series CPU Unit. The result will be saved as a file and operation by virtual external inputs will be performed.

- Note**
1. All data of the Data Trace File is regarded as data for input, fed to the Ladder Engine. When setting for I/O memory areas that will be sampled in the CX-Programmer, make sure they can be used as inputs.
  2. Refer to the *Data Trace/Time Chart Monitoring* of *CHAPTER 4 - Reference of PART 1: CX-Programmer* in the *CX-Programmer Operation Manual (W446)* for how to operate the data trace and time chart monitoring.

#### Replaying Data of Data Trace

The data of the data trace differs in replay timing depending on the sampling setting when saving. In addition, all saved data is replayed regardless of the trigger setting.

	Replay timing (Synchronous)	Replay timing (Asynchronous)
Every cycle	Every cycle	Fixed interval
Regular sampling	Sampling interval	Sampling interval
Sampling by the TRSM	Every cycle	Fixed interval

**Note** Some data of the data trace with short sampling cycle can not be replayed in the timing of the sampling cycle if replayed asynchronously. Furthermore, the data with a sampling cycle shorter than that when replaying can not be replayed.

#### Saving Long-term Data with Data Trace Recording Tool

A Data Trace File can contain up to 32,762 sets of data.

When more data or long-term trace data is required, it can be saved in multiple Data Trace Files by using the Data Trace Recording Tool attached to the CX-Simulator.

**Note** Refer to *Appendix How to Use Data Trace Recording Tool* for how to use the Data Trace Recording Tool.



### 8-3-3 Data Replay File (CSV-format text file)

The CSV-format text file (Data Replay File (.csv)) created by a commercial spreadsheet software can be replayed on the Ladder Engine using the Data Replay Tool. Besides, the execution result of the Ladder Engine can be saved in the Data Replay file as the values of I/O memory areas.

**Note** Refer to 8-4 Running by Virtual External Inputs for Replay with Data Replay Tool.

#### File Format of Data Replay File

A Data Replay File is an indefinite-length CSV-format text file containing a parameter line (1st line) and data lines (2nd line and after).

```
Creator's ID, Data category, I/O address 1, I/O address 2, ..., I/O address n <CR><LF>
Date and time, Cycle counter, Value 1, Value 2, ..., Value n <CR><LF>
.
.
.
```

No	Name	The number of characters	Remarks
1	Creator's ID	Indefinite length	File creator's ID (possible to omit, usually a program name to be saved)
2	Data category	2 or 3	IN/OUT: Input to PLC (IN) or output from PLC (OUT)
3	I/O address	Indefinite length	I/O memory address for input/output (167 data max.)
4	Date and time	19	YYYY/MM/DD HH:MM:SS (Date and time of computer, possible to omit)
5	Cycle counter	Indefinite length	Cycle counter Value when send/receive
6	Value	Indefinite length	The memory value of the specified I/O memory address (decimal data or hexadecimal data starting with 0x)

#### Area Type and Address Range of Usable I/O Memory Area

The following I/O memory areas can be specified by the Data Replay File.

##### Bit

Area name	Area type	Address range
I/O Area (CIO)	IO	0.00 to 6143.15
Work Area (WR)	W	0.00 to 511.15
Hold Area (HR)	H	0.00 to 511.15
Auxiliary Area (AR)	A	0.00 to 959.15

**Word**

Area name	Area type	Address range
I/O Area (CIO)	IO	0 to 6143
Work Area (WR)	W	0 to 511
Hold Area (HR)	H	0 to 511
Auxiliary Area (AR)	A	0 to 959
Data Memory (DM)	D	0 to 32767
Extended Data Memory Area (EM)	E?_	E0_0 to E0_32767, EC_0 to EC_32767
Timer (TIM)	T	0 to 4095
Counter (CNT)	C	0 to 4095

**Example of Creating Data Replay File by Spreadsheet Software (Input File)**

It is convenient to create the data for input of the Data Replay File using spreadsheet software such as MS-Excel as follows:

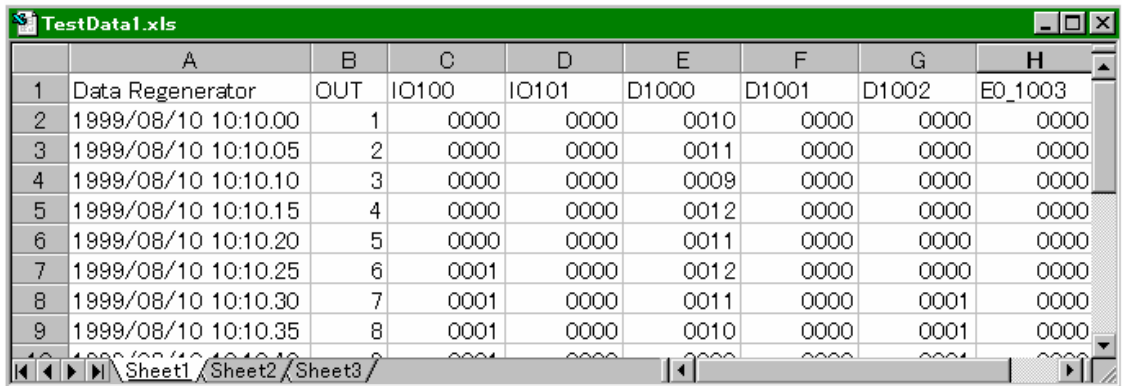

**Note** It is not required to input date and time data when using a Data Replay File as inputs.

**Specifying Output Data by Data Replay Tool (Output File)**

A Data Replay File has an input format for the Data Replay Tool. However, it also works as an output data file for saving values of I/O memory areas to monitor the results of the program execution. In order to save values of I/O memory areas using the Data Replay Tool, the I/O memory area to be saved must be specified as an output data file in advance using a spreadsheet software, etc.

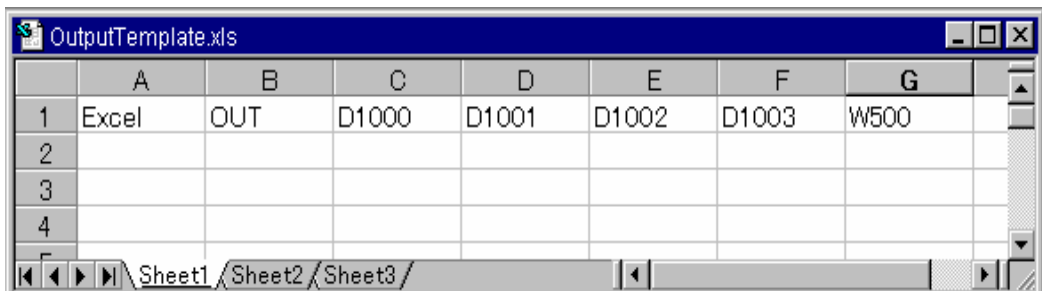

If a file output by the Data Replay Tool exists, specifying the I/O memory as an output file can be omitted by specifying the file as an output template when starting the Data Replay Tool. Specifying a template file by the Data Replay Tool will copy the I/O memory specification (parameter line) of the template file to the output file as is.

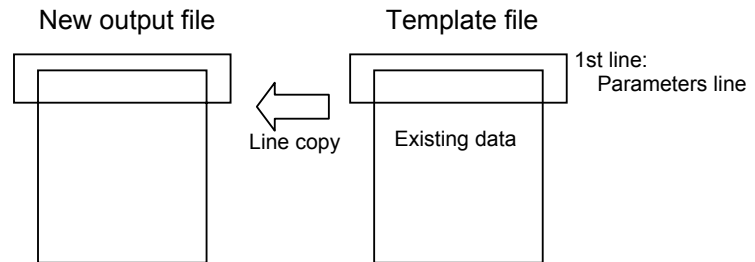

### 8-3-4 Multipoint Data Collection Tool

Time-series I/O memory data (Data Replay File) acquired from an actual PLC can be replayed on the Ladder Engine using the Data Replay Tool. Unlike Data Trace, data can not be acquired every cycle. However, time-series data of more than 50 words can be acquired. This function enables to take in data from an actually running PLC and to replay the data along with the program using the CX-Simulator, allowing confirming the operations.

- Note** Refer to *8-4 Running by Virtual External Inputs* for replay with Data Replay Tool.
- Note** The CX-Server is required to use the Multipoint Data Collection Tool. Therefore, be sure to install the CX-Programmer Ver.1.20 or after on the same computer.
- Note** The Multipoint Data Collection Tool fails to acquire data of operations shorter than a few tens of milliseconds. Also, replaying actually acquired data on the PLC may cause time lags because the tool does not acquire data in synchronization with the PLC's cycle time.

#### Setting for Multipoint Data Collection

In order to acquire and save multipoint data from an actual PLC, after clicking the [Start] button on the task bar, select [Program] | [Omron] | [CX-Simulator] | [Multipoint Data Collection Tool].

- 1,2,3... 1. Select [Program] | [Omron] | [CX-Simulator] | [Multipoint Data Collection Tool] to display the Multipoint Data Collection Tool dialog box.

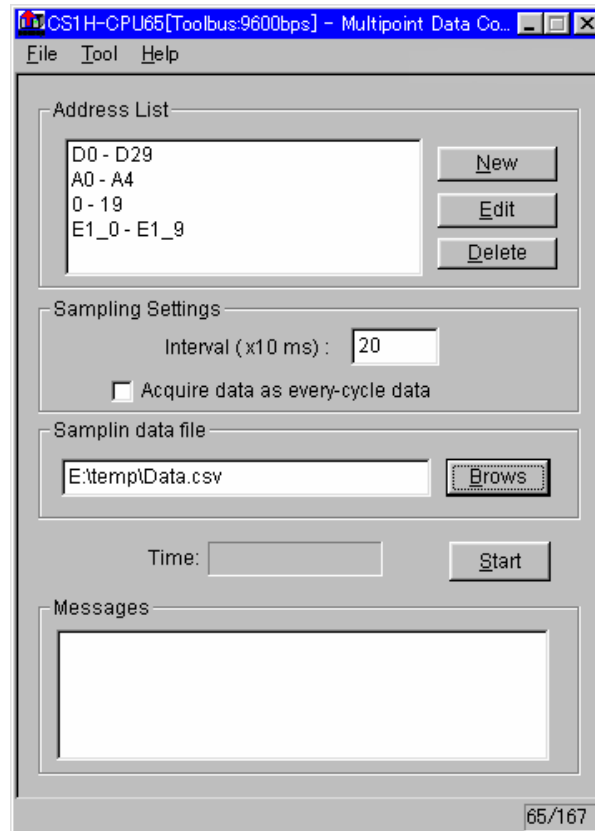

- |   |  |
|---|--|
| <ul style="list-style-type: none"> <li>• Address List</li> <li>• New</li> <li>• Edit</li> <li>• Delete</li> <li>• Sampling Interval</li> <li>• Acquire data as every-cycle data</li> <li>• Sampling data file</li> <li>• Browse</li> <li>• Start/Stop</li> <li>• Time:</li> <li>• Messages</li> <li>• Exit</li> </ul> | <p>An address to be sampled is displayed.</p> <p>An address to be sampled is registered in the form of “Start address – End address” in the unit of word. Multiple addresses can be registered. The content of the registered address can be changed.</p> <p>The registered address can be deleted.</p> <p>A sampling interval can be set to a minimum of 100 ms. (in the unit of 10 ms)</p> <p>Check here to save the sampled data as every-cycle data, independently of the PLC’s cycle count. This is effective when acquiring data in order to confirm operation with ON/OFF of the bits. (allows efficient debugging when replaying on the CX-Simulator.)</p> <p>Input a name of CVS file where the sampled data will be saved.</p> <p>Browse a name of save file to select.</p> <p>Pressing the Start button will start sampling. Works as Stop button during execution.</p> <p>Displays elapse time after starting sampling.</p> <p>When an error occurs in the operation of the Multipoint Data Collection Tool, the error content will be displayed.</p> <p>Quit the Multipoint Data Collection Tool.</p> |
|---|--|

2. Select [File] | [Set Communications] to set [Device Type] to be connected and [Network Type]. Always select the CS/CJ/CP Series for [Device Type].
3. Click the [New] button to display the [Set Address] dialog box. Input arbitrary word data in the form of [Start Address]-[End Address], followed by the OK button. Multiple data can be registered. Further, the maximum number of addresses that can be registered with the currently set communications method and the present registered number are displayed on the status bar. Also, the saved address can be read by [File] | [Open Address List].

**Note** The number of sampling is limited as follows depending on the communications method because this tool acquires data from an actual PLC using FINS commands.

- Via Peripheral bus 167 addresses max.
- Via SYSMAC WAY 134 addresses max.
- Even for other networks, the number of sampling is limited depending on the frame size of the FINS command at that time. The maximum number of addresses that can be registered according to the communication method currently set in the status bar is displayed.

4. Input [Sampling interval]. A value of 10 or more (to be multiplied by 10 ms) can be set with the default value of 20 (200 ms).

**Note** The [Sampling Interval] set here is, from the internal viewpoint, the one in which the Multipoint Data Collection Tool issues a FINS command in order to read the registered addresses from an actual PLC. The actual intervals at which a response is returned from the PLC may differ from the specified interval depending on the cycle process timing on the actual PLC.

5. Check [Acquire data as every-cycle data] as required. In this case, the data acquired is saved in a file as every-cycle data, independently of the specified sampling interval and the PLC's cycle time. When not timing but confirming operation with ON/OFF of the bits is important, the saved file with a check mark can be replayed fast on the CX-Simulator.

**Note** If this option is not checked, the data will be saved to the file with the estimated cycle count calculated from the actual PLC's average cycle time when starting sampling and the sampling interval set in the Multipoint Data Collection Tool. When this data is replayed on the CX-Simulator, the data replay speed may become very slow if the cycle count of the CX-Simulator proceeds slowly.

6. Input to [Sampling data file] a name of file where sampled data will be saved. Also, clicking the [Browse] button allows to specify a destination file name directly.

**Note** If an existing file is specified, the file will automatically be overwritten when sampling starts. Make sure in advance the file may be overwritten.

7. Clicking the [Start] button will start sampling data according to the set contents.
8. Once the sampling is started, the elapse time after starting sampling is displayed in [Time:].

9. Clicking the [Stop] button will stop the data sampling to save the sampled data in the file.

**Note** When the sampling count from the sampling start exceeds 65,535, the file is automatically divided. In this case, the name of second sampling data save file is the specified file name with “2” appended at the end of it. (e.g. “sample2.csv” for “sample”) Further, when the sampling count for the second save file exceeds 65,535, “3” is appended similarly. (e.g. “sample3.csv” for “sample”)

10. The registered address can be saved by [File] | [Save Address List] to be reused after the Multipoint Data Collection Tool is started next time.

**Note** In order to keep time accuracy to some extent in replaying with the Data Replay Tool, follow the next steps.  
 Step 1: Check [Acquire data as every-cycle data] to sample at the sampling intervals of N (ms).  
 Step 2: When replaying the data, set the above sampling interval of N (ms) to Minimum Cycle Time, and then run the CX-Simulator with the minimum cycle time.

**Note** Be sure to set a sampling interval greater than the PLC’s cycle time. In addition, when setting a sampling interval shorter than 200 ms, or registering addresses of more than 100 words, be sure to connect with the Peripheral bus and to set a fastest possible baud rate. Further, exit all other applications. Otherwise, data may not be acquired normally. In this case, the Multipoint Data Collection Tool displays an error message to stop sampling.

### 8-3-5 Messages Displayed in the Error history

Message display	Contents
“Received an error response.”	An error occurred in the received data. Non-existent EM bank may have been tried to read or communications condition may be unstable.
“Timing Error. Check the log file (Errorlog.txt) after exiting.”	Data can not be acquired at the specified sampling intervals. To avoid this situation, either extend the sampling interval or reduce the sampling address count. If the CX-Programmer is activated at the same time and connected online, once place it offline. Alternatively, setting the maximum value (25.5 ms) to [Fixed Peripheral Servicing Time] in the PLC Setup may be effective. (although the cycle time extends) For details, check the Errorlog.txt that is created in the same folder as for the saved CSV file.
“Data sampling stopped.”	The above situation repeated 10 times continuously or communications with the PLC is broken. Check the communications path with the PLC.

### 8-3-6 I/O Condition Expressions

I/O Condition Expressions describe the operation that sets values to the I/O memory area (output expression) after the specified time (delay time) when the conditions of the specified I/O memory (conditional expression) hold. The combination of the conditions generates virtual external outputs.

**Procedure for Setting I/O Condition Expressions**

This section explains the testing procedure using the I/O Condition Tool.

- 1,2,3... 1. Select [IO Condition] in the [CX-Simulator Debug Console] | [Replay] menu to display the [Run] window of the I/O Condition Tool.

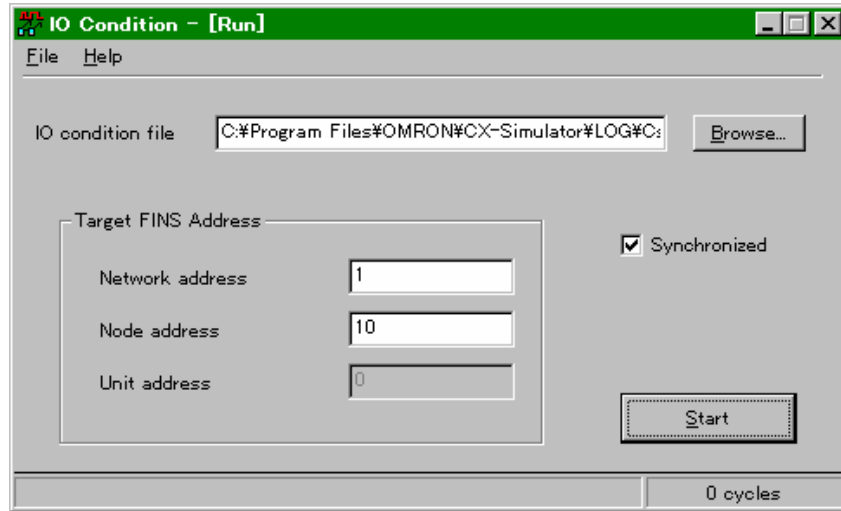

2. Select [Settings] in the [File] menu to display the [Configuration] window of the I/O Condition Tool.

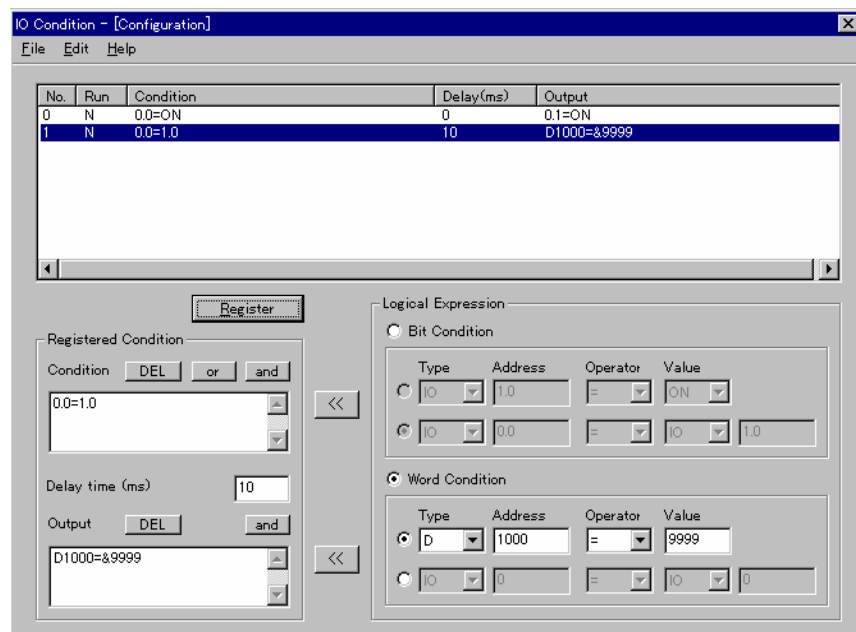

3. Select “Bit Condition” or “Word Condition” and set logical expressions to be added to the condition expressions.

**Note** Refer to 4-3-5 I/O Break Condition Setting for the setting method of logical expressions.

4. Click the [<<] button on the side of condition expressions to add the set logic expression to the condition expression.

5. When registering multiple logic expressions to the condition expression, insert logic operators between logic expressions (Click the [or] or [and] button.).
6. Repeat 4 and 5 until completing the condition expression. Directly editing the condition expression is also possible.
7. Input a delay time (unit: ms).
8. Select "Bit Condition" or "Word Condition" and set logic expressions to be added to the output expression.

**Note** In the output expressions, only [=] can be used as a condition operator and only [and] as a logic operator. If other operators are used, the I/O Condition expression will cause an error ("E").

9. Click the [<<] button on the side of the output expressions to add the set logic expression to the output expressions.
10. When registering multiple logic expressions to the output expression, insert logic operators between logic expressions (Click the [and] button.).
11. Repeat 9 and 10 until completing the output expression. Directly editing the output expression is also possible.
12. Click the [Expression Registration] button to register the input condition expressions, the delay time, and the output expressions as the I/O Condition expression. The expression is evaluated when registered. "N" (o) is shown in the execution field for a valid input and "E"(rror) for an invalid input.
13. Repeat 3 to 12 until inputting necessary I/O Condition expressions completes.
14. When changing the input I/O Condition expression, left-click the relevant line in the list to reflect the selected I/O Condition expression to the registration condition area. Correct it as required and click the [Expression Registration] button to re-register.
15. Double-click the expression where actually judging conditions out of the registered I/O Condition expressions to change the display from "N" to "D"(o), showing judging conditions is possible. Also, repeating the same process will change the display from "D" to "N."
16. After making relevant I/O Condition expressions executable, select [Save as] in the [File] menu to save the input I/O condition expressions.
17. Select [Close] in the [File] menu to return to the [Run] window.

## **Restrictions**

Up to 512 I/O Condition expressions can be registered.

Up to 6 combinations of logic expression can be registered for one condition expression.



### 8-3-7 Ladder Program for Debugging

The CX-Simulator can run a ladder program for debugging on the program area for debugging (UM2) besides the program area for applications (UM1), dynamically creating input data for virtual external inputs.

The program area for debugging is independent of that for applications, sharing the I/O memory area with for applications. Thus the outputs from the program area for debugging can be used as inputs to that for applications.

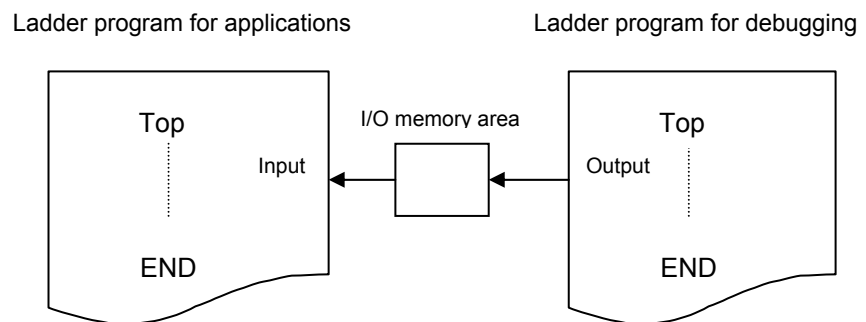

**Note** Refer to 9 CPU Unit Operation for the operation of the program areas for applications/debugging.

### Restrictions when Using Program Area for Debugging

**Not possible to overlap with the program area for applications.**

Do not overlap the task number with that of ladder program for applications. If the task number overlaps, the task in the UM2 will not be executed. Besides, if the following items overlap, a program error will occur.

- The jump number of JMP
- The subroutine number of subroutine/macro instructions
- The block number of block programming instructions

**Not possible to use interrupt tasks**

Do not use interrupt tasks in the program area for debugging (UM2). The interrupt tasks in the UM2 will not be executed.

**Program Area for Debugging and I/O Break Condition Setting**

The program area for debugging is not displayed on the [Step Run] window. If the I/O break condition holds while executing a ladder program on the program area for debugging, the [Step Run] window displays as if an I/O break occurred at the end of the ladder program for applications (END).

## 8-4 Running by Virtual External Inputs

### 8-4-1 Running by Virtual External Inputs

#### How to Run by Virtual External Inputs

Perform running by virtual external inputs in the following 3 methods.

1. By Data Replay Tool
2. By the I/O Condition Tool
3. By the ladder program for debugging

**Note** Be careful when performing Run-mode operation from the [Debug Console] while executing the Data Replay Tool or I/O Condition Tool. If the [Continuous Run] button is pressed during a Synchronous process, synchronism may be lost temporarily. Also, if the [Pause] ( ), [Scan Run], or [Step Run] button is pressed during an Asynchronous process, the virtual external input data will be replayed even if the ladder execution is interrupted temporarily.

#### Synchronous/Asynchronous Processes

In the Data Replay Tool and I/O Condition Tool, whether or not to perform synchronous process can be selected.

The Synchronous (Replay) process is a process where the Ladder Engine and each tool operate synchronously in the unit of a scan. If the Synchronous process is not performed (Asynchronous process), setting/monitoring of I/O memory values from each tool to the Ladder Engine are performed asynchronously with scan of the Ladder Engine. In this case, like operation to an actual PLC, scan from each tool to the Ladder Engine is will not be performed.

When using multiple tools at the same time, execute the synchronous process on one tool. Perform the other tools asynchronously.

**Note** Synchronous execution of multiple tools will lose synchronism in the unit of a scan for each tool. Execute one tool synchronously and the others asynchronously or alternatively execute all tools asynchronously.

#### Virtual Cycle Time and Computer Cycle Time

When performing virtual external inputs, use the Simulator in the Computer Cycle Time. In the Synchronous process, the execution result will be the same for Virtual Cycle Time and Computer Cycle Time. In the Asynchronous process, on the other hand, the result will be different because the time elapses differently between the Ladder Engine and tools in Virtual Cycle Time and the timing of data setting is different from that of Computer Cycle Time.

### 8-4-2 How to Run by Data Replay Tool

The [Data Replay Tool] reads the data of the specified replay file (Command log file, Data Trace file(See note), or Data Replay file) and set the data to the Ladder Engine in sequence. Furthermore, the changes caused by setting of the data can be saved to an output file as monitor data.

**Note** The Data Trace files saved on the Data Trace Window for CS/CJ/CP Series of the CX-Programmer version 8.0 or higher cannot be used.

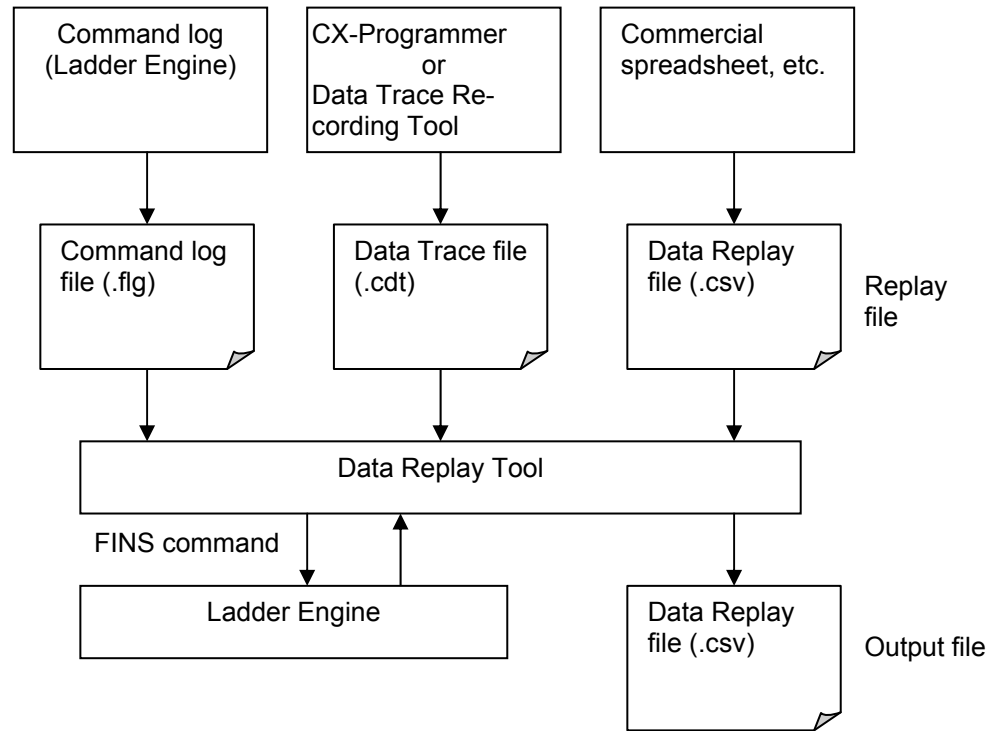

Basic Operation

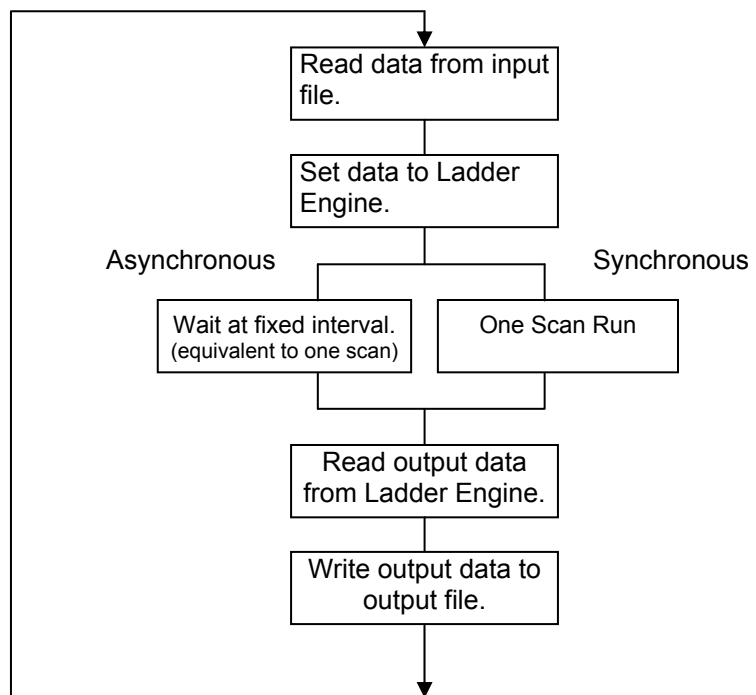

**Input Data File**

The following data files can be specified as an input data file.

Replay file	Replay method
Command log file(.flg)	Read in sequence the history of operation (Command log) performed to the Ladder Engine saved in the file and issue commands again to the Ladder Engine. In the Synchronous process, each operation will be replayed in the same interval as the cycle counter when saved.
Data trace file (.cdt)	Read in sequence the data saved as trace data and feed it to the Ladder Engine. The data will be replayed according to the sampling cycle when saved.
Data Replay file(.csv)	Read in sequence the data saved in CSV format and feed them to the Ladder Engine. The set data will be replayed in the interval of the cycle time counter saved at the same time as the data.

**Output Data File**

The Output Data File is a text file of the same format as the Data Replay File (.csv). The data to be output to the file must be registered in advance at the 1st line (parameter line) of the Data Replay File.

The parameter line needs to be set using a commercial text editor or a spreadsheet software, etc. or the template file must be specified before starting the Data Replay Tool.

**Template File**

The Template File is a text file of the same format of the Data Replay File. When creating a new output data file by the Data Replay Tool and monitoring the same data as the Data Replay File, specifying the Data Replay File as a template file will copy the parameters line automatically.

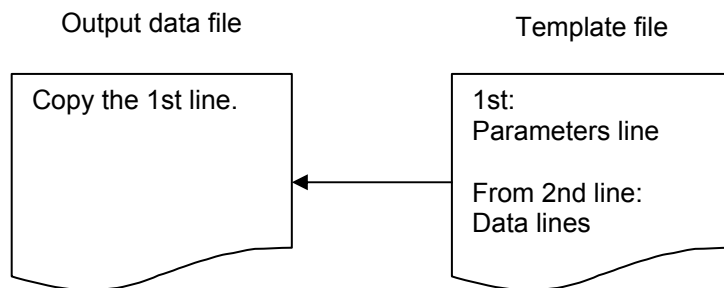

**Note** If an existing output file is specified in the Data Replay Tool, monitor data will be appended to the end of the output file. If both the output file and the output template specify "I/O memory," that of the output file is given priority.

## How to Run the Data Replay Tool

**Starting the Data Replay Tool** This section explains the testing procedure using the Data Replay Tool.

- 1,2,3... 1. Select [Data Replay] in the [CX-Simulator Debug Console] | [Replay] to display the [Data Replay Settings] window.

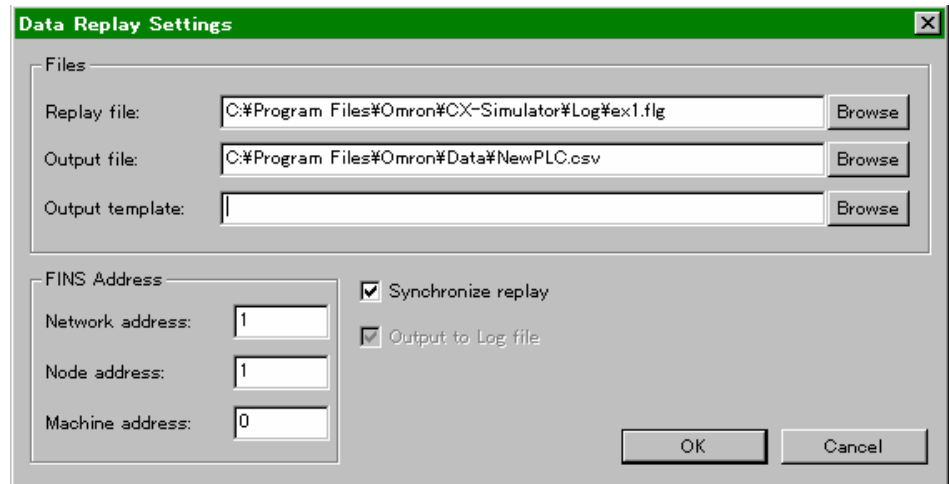

2. Specify the Data Replay File. The [Browse] button can be used, too. The Command log file (.flg), Data Trace File (.cdt), and Data Replay File(.csv) can be specified.
3. Specify the output file as required. Only the Data Replay File (.csv) can be specified as the output file. If an existing file is specified, new data will be appended to the end of the file.
4. When using a new output file, set a template file. Only the Data Replay File (.csv) can be specified as the template file.
5. Pressing the [OK] button will start the Data Replay Tool to display its Execution window.

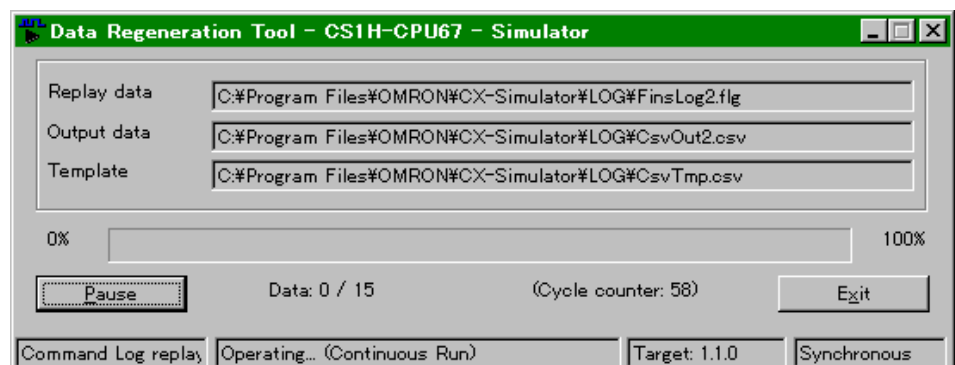

6. Completing the input data replay will exit the Data Replay Tool automatically.

**Pausing the Data Replay Tool** Clicking the [Pause] button in the [Run] window will pause the data replay. Also, the following conditions of the Ladder Engine will pause the replay.

Conditions of the Ladder Engine	Synchronous/Asynchronous	How to clear
Program/Run mode	Synchronous/Asynchronous	Scan Run for Synchronous and Continuous Run (Monitor mode) for Asynchronous.
Break on Break Points	Synchronous	Scan Run
Break on I/O Break Condition	Synchronous	Scan Run

**Note** Keep the Ladder Engine in Scan Run Status while synchronizing the Data Replay Tool. If Continuous Run (Monitor Mode) or Continuous Scan Run is used, synchronism in the unit of a scan will be lost. When the program has been interrupted on a break point, etc., resume it with Scan Run.

**Note** While executing asynchronously, the data will be replayed even while the Ladder Engine is not executing a ladder program.

**Getting monitor data using the Data Replay Tool**

The Data Replay Tool can save only the monitor data of the specified I/O memory areas to the output file regardless of the Replay File. When outputting only the monitor data, specify only an output file (and the template file as required), not the Replay File.

**8-4-3 Replay Using the I/O Condition Tool**

The I/O Condition Tool specifies the execution file of the I/O Condition expressions specified in the [Settings] window in advance and monitors the changes of the I/O memory areas set by the condition expressions of the I/O Condition expressions, outputting when the conditions hold.

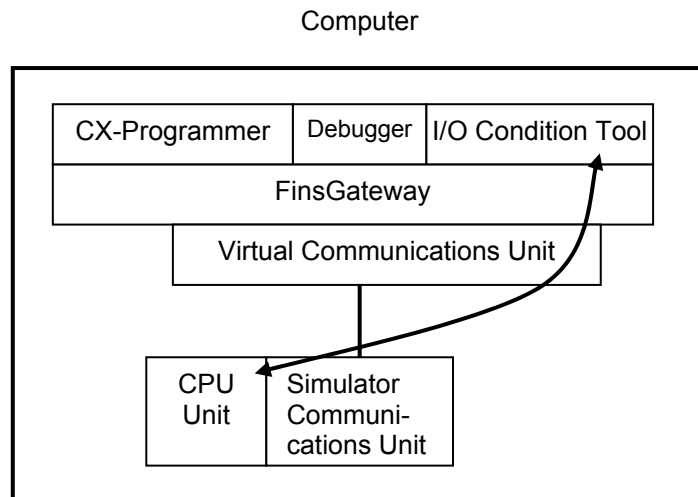

The I/O Condition Tool operates independently of the Debugger.

**Example for Operation Timing of the I/O Condition Expressions**

The following example shows the timing from when the I/O Condition expressions hold to when the values registered in the output expressions are set, if the delay time is 200 ms.

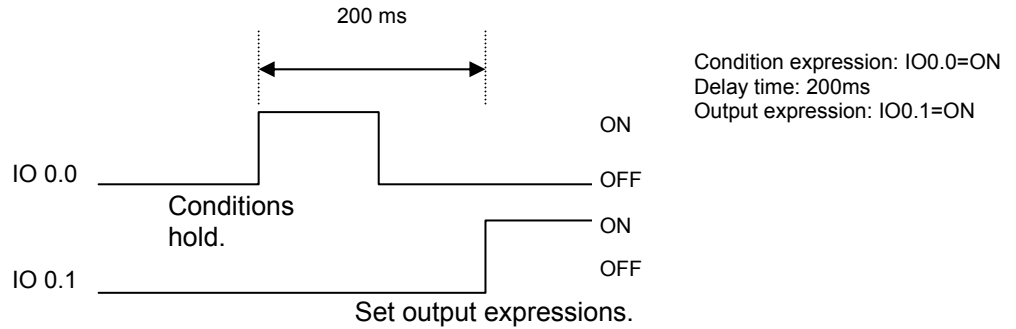

**How to Replay using the I/O Condition Tool**

This section explains how to perform virtual external input using the I/O Condition Tool.

- 1,2,3... 1. Select [IO Condition] in the [CX-Simulator Debug Console] | [Replay] menu to display the [Run] window of the I/O Condition Tool.

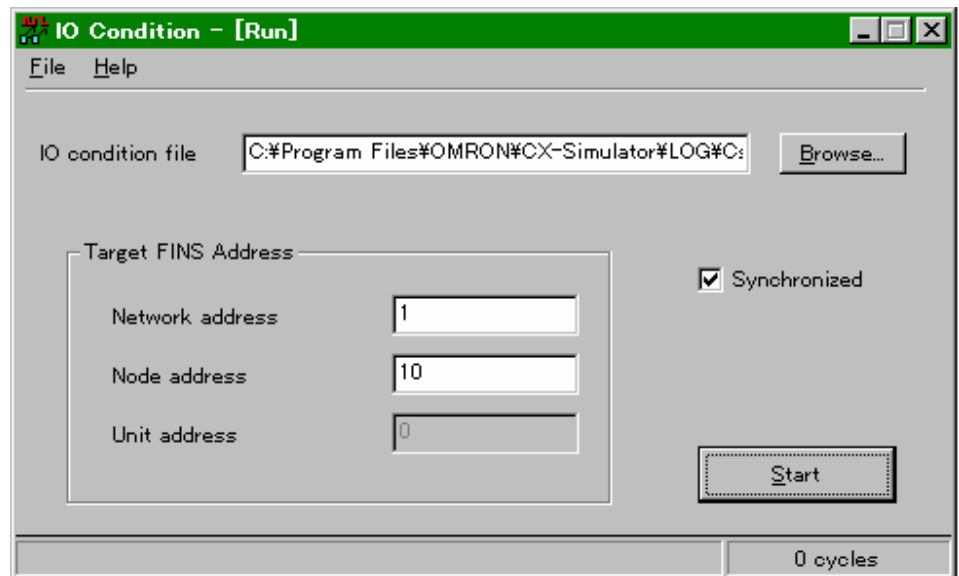

2. Input "IO condition file" to the execution file. Browsing files using the [Browse] button or [Open] in the [File] menu is also possible.
3. Check the target FINS address. Usually there is no need to change it because the FINS address for the Ladder Engine is set in default.
4. Check whether synchronized processing (see note) is enabled. The Data Replay Tool also allows synchronized processing, but not for multiple operations at the same time. To perform other synchronized processing, deselect [Synchronized] for the I/O Condition Tool.  
 Note: When synchronized processing is not used, I/O condition proc-

essing is performed asynchronously with the PLC scan. As a result, data may be lost if I/O status changes too quickly. If synchronized processing is used, data will not be lost, but processing will be slowed down by the amount of time required to synchronize.

5. After checking the settings, click the [Start] button.

### Pausing the I/O Condition Tool

The I/O Condition Tool pauses in the following conditions of the Ladder Engine.

Conditions of the Ladder Engine	Synchronous/Asynchronous	How to clear
Program/Run mode	Synchronous/Asynchronous	Scan Run for Synchronous and Continuous Run (Monitor mode) for Asynchronous.
Step Run, or Pause in the Debug Console	Synchronous	Scan Run
Break on Break Points	Synchronous	Scan Run
Break on I/O Break Condition	Synchronous	Scan Run

**Note** When the computer cycle time is 10 ms or more, hold of conditions may fail to be caught. In this case, use in the virtual cycle time.

**Note** Do not perform Continuous Run (in the Monitor mode) or Continuous Scan Run while synchronizing the I/O Condition Tool. Doing so will lose synchronism in the unit of a scan. When the program has been interrupted on a break point, etc., resume it with Scan Run.

**Note** While executing asynchronously, the I/O memory areas are monitored even while the Ladder Engine is not executing a ladder program due to break, etc.

## 8-4-4 How to Replay Using the Program Area for Debugging

This section explains how to perform virtual external input (download and execute) using the program area for debugging.

- 1,2,3... 1. Press the [Settings] button in the [System Status Settings] dialog box, and then select [UM Settings] to display the [UM Settings] window.

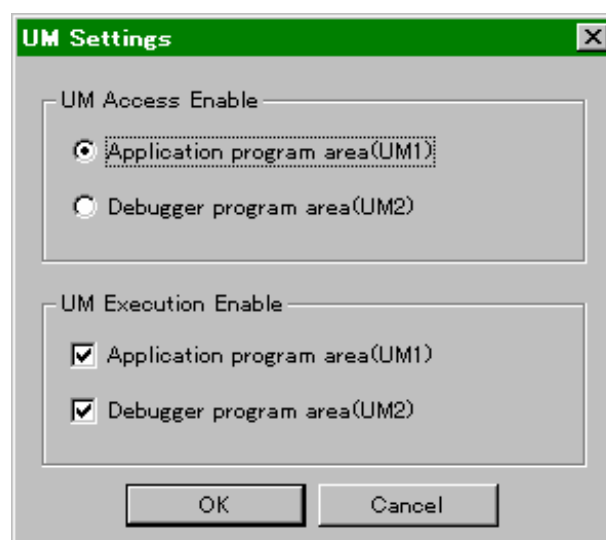



2. Select [Debugger program area (UM2)] in [UM Access Enable] followed by clicking the [OK] button.
3. After confirming that the CX-Simulator is connected in the [Work CX-Simulator] window, download the ladder program from the CX-Programmer.
4. After the download is completed, select [UM Settings] in [System Status] | [Settings] again and select [Application program area (UM1)] in [UM Access Enable]. Also, check both boxes for [Application program area (UM1)] and [Debugger program area (UM2)] in [UM Execution Enable], followed by clicking the [OK] button.
5. Select [Save all] in the [CX-Simulator Debug Console] | [File] menu to save the status before starting virtual external inputs.
6. Clicking the [Continuous Run] button from [CX-Simulator Debug Console] or turning the mode of the Ladder Engine to Monitor from the CX-Programmer will start running using virtual external inputs.

**Note** The CX-Simulator can not debug a ladder program in the program area for debugging. Before downloading the ladder program to the program area for debugging, check it in the area for applications in advance.

## 8-5 Checking the Result

### 8-5-1 Checking by Time Chart Monitor of the CX-Programmer

The results from virtual external inputs can be checked by the time chart monitor or the data trace of the CX-Programmer. Displaying the data of virtual external inputs and its results simultaneously allows to confirm the operation results and timing of the ladder program.

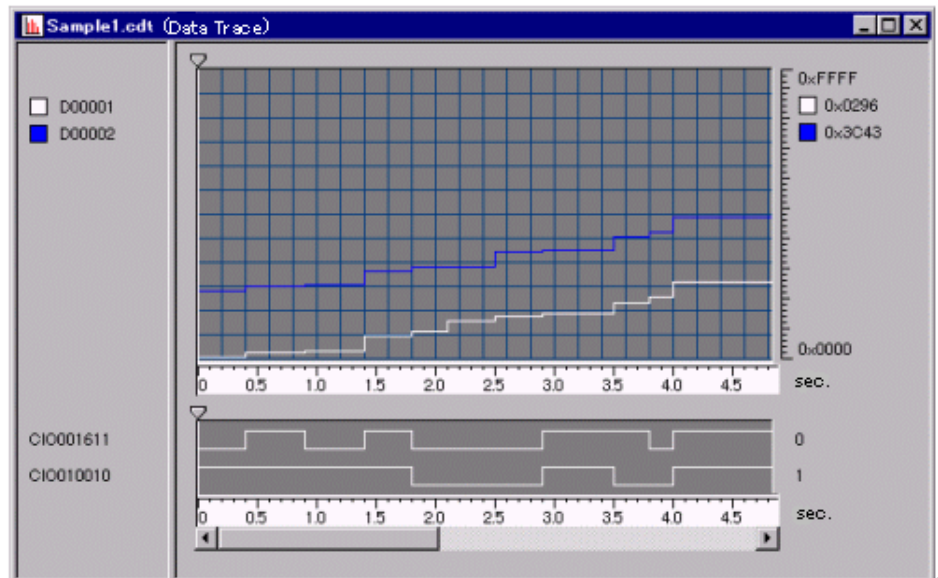
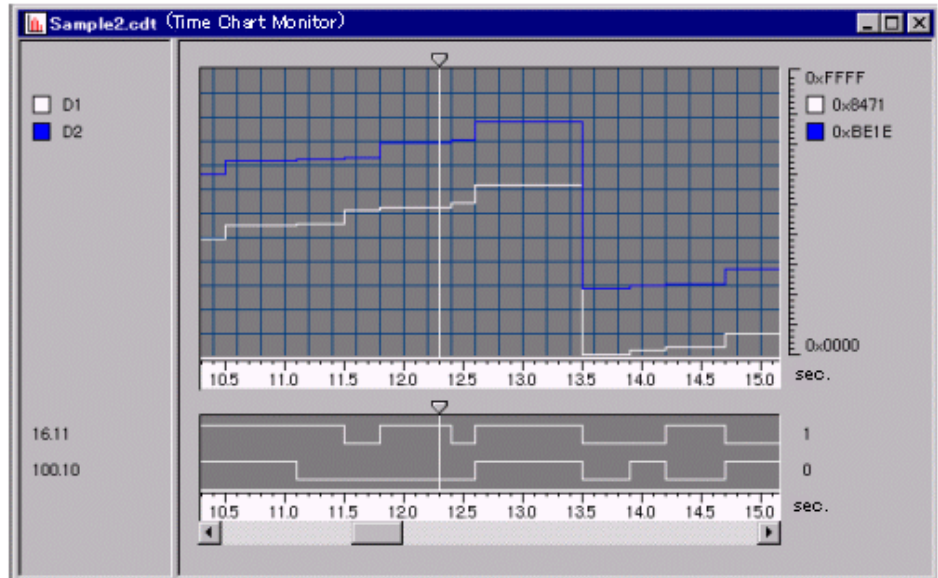

**Note** Refer to the *Data Trace/Time Chart Monitoring* of *CHAPTER 4 - Reference of PART 1: CX-Programmer* in the *CX-Programmer Operation Manual (W446)* for how to operate the data trace and time chart monitoring.

### 8-5-2 Checking with Graphing by Excel Using the Data Replay File

Using the output file of the Data Replay Tool allows checking the data.

The Data Replay File output by the Data Replay Tool is a CSV-format text file, thus enabling to check with graphing by reading it to spreadsheet software such as MS-Excel.

The following shows an example of the Data Replay file being read to MS-Excel and graphed.

	A	B	C	D	E	F	G	H
1	DataRegenerator	OUT	IO1 00	IO1 01	D1 000	D1 001	D1 002	EO_1 003
2	1999/08/10 10:10:00	1	0000	0000	0010	0000	0000	0000
3	1999/08/10 10:10:05	2	0000	0000	0011	0000	0000	0000
4	1999/08/10 10:10:10	3	0000	0000	0009	0000	0000	0000
5	1999/08/10 10:10:15	4	0000	0000	0012	0000	0000	0000
6	1999/08/10 10:10:20	5	0000	0000	0011	0000	0000	0000
7	1999/08/10 10:10:25	6	0001	0000	0012	0000	0000	0000
8	1999/08/10 10:10:30	7	0001	0000	0011	0000	0001	0000
9	1999/08/10 10:10:35	8	0001	0000	0010	0000	0001	0000

↓  
Graphing

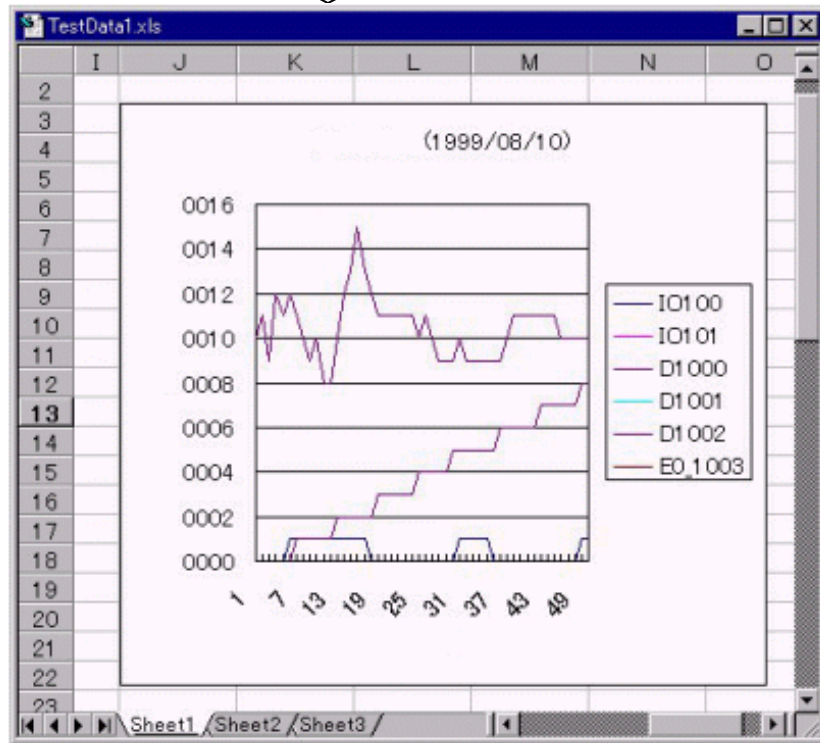

**Note** Refer to the online help, etc. for how to read a CSV file to MS-Excel and to graph it.



## SECTION 9

# CPU Unit Operation

9-1 CPU Unit Operation .....	178
9-1-1 General Flow .....	178
9-1-2 Startup (Initial) Process .....	179
9-1-3 Overseeing Processing .....	180
9-1-4 Computing Process .....	180
9-1-5 Details of I/O Refresh and Peripheral Servicing .....	181
9-2 Cycle Time and Time .....	182
9-2-1 Cycle Time .....	182
9-2-2 Maximum CPU Occupancy and Execution Time .....	188
9-2-3 Differences with CS/CJ/CP Series .....	189
9-3 I/O Memory Allocation .....	190
9-3-1 PLC Setup Settings .....	190
9-3-2 Auxiliary Area (Read-only Area) .....	195
9-3-3 Auxiliary Area (Read/Write Area) .....	220
9-4 Other Functions .....	227
9-4-1 Differences in CX-Programmer Operation .....	227
9-4-2 Other Precautions .....	227

## 9-1 CPU Unit Operation

### 9-1-1 General Flow

The CPU Unit operation of the Ladder Engine flows as follows (excluding when Step Run).

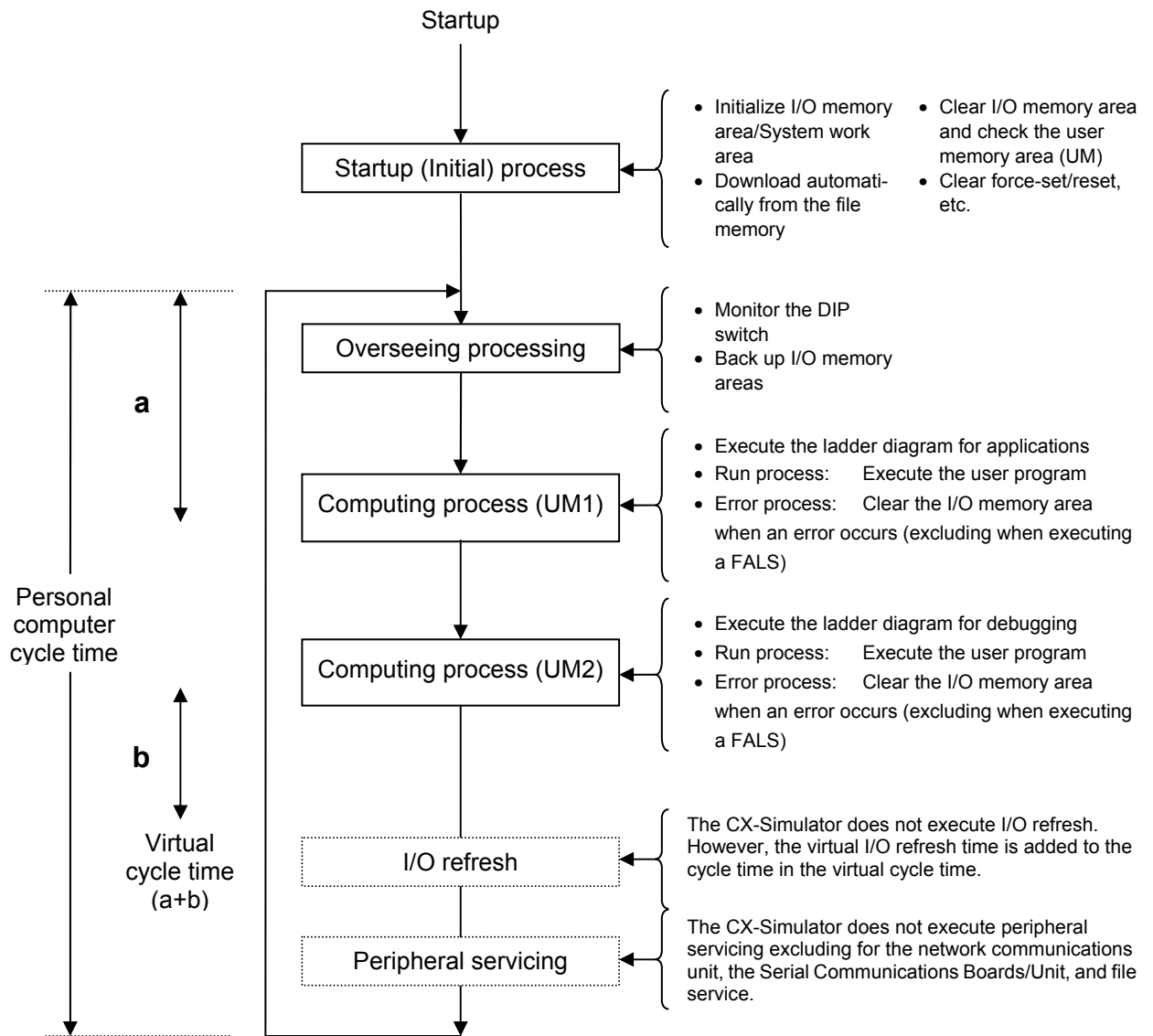

**Note** Refer to 9-2 Cycle Time and Time for the computer cycle time and the virtual cycle time.

### 9-1-2 Startup (Initial) Process

The following Startup (Initial) process is performed once when start-up, changing the configuration of the Ladder Engine, reset, or changing the operating mode (between Run/Monitor and Program).

- Clear the non-hold-type area in the I/O memory areas  
Processed as follows depending on IOM Hold Bit and PLC Setup (setting for Hold/Non-hold of IOM Hold Bit when startup).

PLC Setup		Auxiliary Area		IOM Hold Bit (A50012)	
				Non-hold (0)	Hold(1)
Setting for Hold/Non-hold of IOM Hold Bit when startup	Non-hold (0)	Startup: Cleared	Startup: Cleared	Changing the mode: Cleared	Changing the mode: Hold
	Hold (1)	Cleared	Startup: Hold	Changing the mode: Hold	Changing the mode: Hold

- Clear Force-set/reset  
Processed as follows depending on Force-set/reset Hold Bit and PLC Setup (setting for Hold/Non-hold of Force-set/reset Hold Bit).

PLC Setup		Auxiliary Area		Force-set/reset Hold Bit (A50013)	
				Non-hold (0)	Hold(1)
Setting for Hold/Non-hold of Force-set/reset Hold Bit	Non-hold (0)	Startup: Cleared	Startup: Cleared	Changing the mode: Cleared	Changing the mode: Hold
	Hold (1)	Cleared	Startup: Hold	Changing the mode: Hold	Changing the mode: Hold

- Automatically executed if the program for automatic execution (Autoexec file) exists in the file memory.
- Self-diagnosis (UM area check)

**Note** Refer to 9-2 I/O Memory Areas of CS/CJ Series Operation Manual for the startup process for I/O memory areas.

### 9-1-3 Overseeing Processing

Back up I/O Memory Areas for re-execution of scan as the CX-Simulator's own process. The I/O Memory Areas to be backed-up are as follows.

Name	Word Address	Remarks
CIO area	CIO0000 to CIO6143	
WR	W000 to W511	
HR	H000 to H511	
AR	A000 to A959	CJ2-series CPU Units: A0000 to A1471 and A10000 to A11535
TR	TR0 to TR15	
DM	D00000 to D32767	
EM	E0_00000 to EC_32767	
Timer Completion Flag (T)	T0000 to T4095	
Counter Completion Flag(C)	C0000 to C4095	
Timer PV (T)	T0000 to T4095	
Counter PV(C)	C0000 to C4095	
Task Flag (TK)	TK0 to TK31	
Index Registers (IR)	IR0 to IR15	
Data Registers (DR)	DR0 to DR15	
Force-set/reset Bit	–	
Differential Flag	–	
Internal Work Area	–	Elapsed Time, etc.

### 9-1-4 Computing Process

The computing process is performed for the program area for applications (UM1) and program area for debugging (UM2) respectively.

The execution order is UM1 to UM2.

Setting Enable/Disable of UM in [System Status] | [Settings] | [UM Setting] will disable either UM1 or UM2 so as to execute only one (Disabling both is not possible.).

**Note** The computing time for the program area for debugging (UM2) is not reflected in the virtual cycle time.



## 9-1-5 Details of I/O Refresh and Peripheral Servicing

Type of Service		CS/CJ-series PLC		CX-Simulator
		Contents	Target Unit Group	
I/O refresh		The data in the pre-allocated area is exchanged within the servicing time without interruption (time slicing).	Basic I/O Unit (including C200H High-density I/O Unit)	I/O refresh is not executed because external I/O Units are not connected to the CX-Simulator.
			SYSMAC BUS Remote I/O System and DeviceNet	
			Special I/O Unit (for CS/CJ/C200H)	
			CPU Bus Unit	
			Inner Board	
Peripheral Servicing	Event Service (Will be serviced for the cycles required.)	Allocate the fixed time defined by the system to each service execute every cycle. If the processing has completed within the allocated time, do not process for the remaining time but go to the next process.	CS/CJ-series Special I/O Unit	Execute only servicing for Network Communications Unit, Serial Communications Unit, and file access within the servicing time without interruption (time slicing).
	Fixed Event service (Will be serviced for every cycle if required.)		CPU Bus Unit	
			Peripheral Port	
			Serial Communications Port	
			Inner Board Bus Service	
	File Access Service			

- Note**
1. The peripheral servicing is not reflected in the virtual cycle time. The computer time required for processing is added for the computer cycle time.
  2. For the computer cycle time, short computing process time of a ladder program may cause the cycle time and the execution time to be 0.0 ms.

## 9-2 Cycle Time and Time

The CX-Simulator has its own expansion for the cycle time and the time.

### 9-2-1 Cycle Time

The CX-Simulator has two modes of cycle time: the virtual cycle time and the computer cycle time. Select from the cycle time mode in the [System Status] | [Settings] | [PLC Clock Settings] dialog box (Default: the computer cycle time).

- **Virtual Cycle Time** The virtual cycle time assuming that a program is executed on the CS/CJ/CP-series PLC, tentative time for the actual PLC.
- **Computer Cycle Time** The actual time required for processing one cycle on the computer.

The cycle time of the CX-Simulator displayed by the CX-Programmer, etc. is the one in the selected mode.

### Calculating Cycle Time for CS/CJ/CP-series PLC

The cycle time for CS/CJ/CP-series PLC is the sum of each processing time.

$$\text{Cycle time} = (1) + (2) + (3) + (4) + (5)$$

Process Name		Process Contents	Processing Time and Fluctuation Factor
(1)	Overseeing Processing	I/O bus check, user program memory check, and clock refresh	0.5ms
(2)	Computing Process	Process instructions of a user program. Sum of the execution time for instruction words.	Sum of the instruction execution time
(3)	Minimum Cycle Time Calculation	Specifying "Minimum Cycle Time" in PLC Setup waits for cycle time to complete with the WDT resetting. Calculate the cycle time.	Approximate to 0 for the time when "Minimum Cycle Time" is not set. The additional time for "Minimum Cycle Time" = The cycle time specified as "Minimum Cycle Time" – the computer cycle time((1)+(2)+(4)+(5))
(4)	I/O refresh	Perform I/O refresh for Basic I/O Unit, Inner Board, Special I/O Unit, CPU Bus Unit, SYSMAC BUS Remote I/O System, and DeviceNet.	The I/O refresh time for each Unit multiplied by The number of Units used
(5)	Peripheral servicing	Event service with Special I/O Unit (0 ms when no Unit is mounted) Event service with the CPU Bus Unit (0 ms when no Unit is mounted) Event service with the Peripheral Port (0 ms when no Unit is connected to the port) Event service with the RS-232C port (0 ms when no Unit is connected to the port) Event service with the Inner Board (0 ms when no Unit is mounted) File access service (0 ms when no files are accessed)	(For each event service) If the "Fixed Peripheral Servicing time" of the PLC Setup is "Disabled", the servicing time will be 4% of the cycle time just before calculated in (3). If "Enabled", it will be the specified time. In each case, the minimum servicing time is 0.1 ms.

**Virtual Cycle Time**

The cycle time of the CX-Simulator is set as "virtual cycle time" in default. The virtual cycle time is given by converting the time required for the Ladder Engine to operate one cycle to the actual PLC cycle time.

**Calculating Virtual Cycle Time**

In calculating the virtual cycle time, the followings are different from that of the CS/CJ/CP-series PLC.

Process name		Process Contents	Processing time and Fluctuation factors
(1)	Overseeing Processing	Fixed Value	0.5 ms
(2)	Computing Process	Process instruction execution of the user program in the UM1. The sum of the execution time of instruction words.	The sum of the execution time of UM1 instruction words.
(3)	Calculating the Minimum Cycle Time"	Calculate the cycle time. When "Minimum Cycle Time" is specified in the PLC Setup, if ((1)+(2)+(4)) is smaller than the specified "Minimum Cycle Time", it is regarded as the virtual cycle time.	When "Minimum Cycle Time" is not specified, the cycle time is 0 ms. In "Minimum Cycle Time", there is no waiting time and only the cycle time is set.
(4)	I/O refresh	The accumulated I/O refresh time for each Unit registered in PLC unit settings.	I/O refresh time for each Unit multiplied by The number of Units used.
(5)	Peripheral servicing	Not calculated in the virtual cycle time.	0 ms

**Note** Although some instructions have different process time depending on conditions, the CX-Simulator calculates the cycle time with the process time on the standard conditions.

**I/O Refresh Time for Typical Basic I/O Units**

Type	Unit name	Model	I/O refresh time per 1 Unit
C200H Basic I/O Unit	16-input-point Unit	C200H-ID212	0.02 ms
	16-output-point Unit	C200H-OD212	0.03 ms
	Interrupt Input Unit	C200HS-INT01	0.10 ms
C200H Group2 High-density I/O Unit	32-point Input Unit	C200H-ID216	0.10 ms
	32-point Output Unit	C200H-OD218	0.10 ms
	64-point Input Unit	C200H-ID217	0.20 ms
	64-point Output Unit	C200H-OD219	0.13 ms
CS/CJ/CP-series Basic I/O Unit	96-point Input Unit	CS1W-ID291	0.02 ms
	96-point Output Unit	CS1W-OD291	0.02 ms

**I/O Refresh Time for Typical Special I/O Units**

I/O refresh time is calculated statically. For Units with variable I/O refresh time depending on the status, typical values are used. (e.g. The I/O refresh time for the Position Control Unit (C200H-NC413) is 2.2 ms.)

Type	Unit name	Model	I/O refresh time per 1 Unit
C200H Special I/O Unit	Temperature Control Unit	C200H-TC□□□□	2.6 ms
	ASCII Unit	C200H-ASC02	1.8 ms
	Analog Input Unit	C200H-AD001	1.0 ms
	High-speed Counter Unit	C200H-CT001-V1	2.4 ms
		C200H-CT002	
	Position Control Unit	C200H-NC111	2.2 ms
		C200H-NC112	(4.0 ms when read)
		C200H-NC413	4.3 ms (5.5 ms when read/write)
PLC Link Unit	C200H-LK401	0.3 ms	
CS/CJ-series Special I/O Unit	Analog I/O Unit	CS1W-MAD44	0.2 ms

**Calculating Cycle Time**

An example of calculating the cycle time when only Basic I/O Units are mounted.

**Condition**

Item	Contents		
CPU Rack (for 8 slots)	96-point Input Unit	CS1W-ID291	4 Units
	96-point Output Unit	CS1W-OD291	4 Units
CS/CJ-series Expansion Rack (for 8 slots) × 1Unit	96-point Input Unit	CS1W-ID291	4 Units
	96-point Output Unit	CS1W-OD291	4 Units
User program	5 k steps	LD 2.5 k steps, OUT 2.5 k steps	
Minimum Cycle Time Process	None		
Peripheral servicing with other Units (Special I/O Unit, CPU Bus Unit, Inner Board, and file access)	None		

**Calculation example**

Process name	Calculation example	Processing time
(1) Overseeing processing	–	0.5 ms
(2) Computing process	0.04 μs × 2500 + 0.17 μs × 2500 (The actual computing time varies depending on execute/non-execute.)	(0.53 ms)
(3) Calculating for Minimum Cycle Time	(Minimum Cycle Time disabled)	0 ms
(4) I/O refresh	0.02 ms × 8 + 0.02 ms × 8	0.32 ms
(5) Peripheral servicing	–	0 ms
Cycle time	(1) + (2) + (3) + (4) + (5)	1.35 ms

**Time Elapse in Virtual Cycle Time**

In virtual cycle time, the standard processing time (virtual time) for the instruction is added each time one instruction of the program is executed.

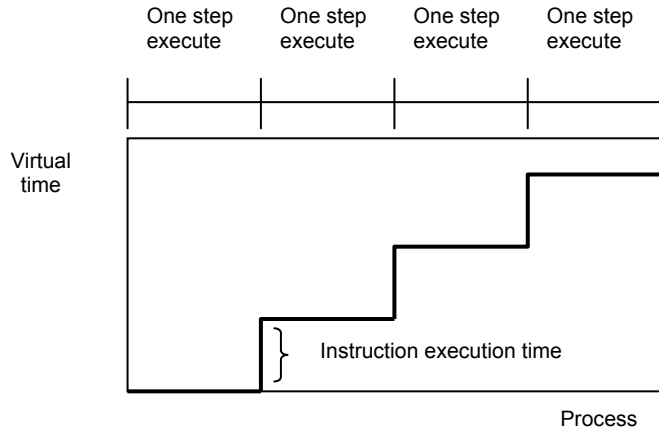

The virtual time will be the base for the following time-related functions.

- Virtual Cycle Time    The accumulated virtual time will be the computing time.
- Timer                    Update in the unit of virtual time.
- Pulse                    Update in the unit of virtual time.
- Clock                    Update in the unit of virtual time.

The CX-Simulator can execute two program areas: the program area for applications (UM1) and for debugging (UM2). However, only the execution time of instructions in UM1 is added as the virtual time, and not in UM2.

In the virtual cycle time, based on the virtual time, the time elapse on the computer does not agree with that on the Ladder Engine. Also, the clock will not advance in the Program mode, where instructions are not executed. Thus this causes a time lag with the clock on the computer. Therefore, set the clock from the CX-Programmer as required.

The time elapse when Step Run will be as follows.

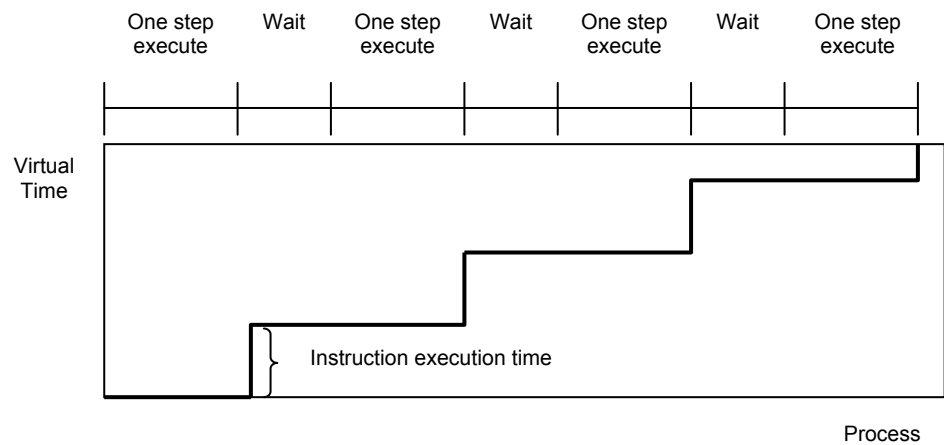

**Minimum Cycle Time**

Enabling Minimum Cycle Time will set either the calculated value of the virtual cycle time or the specified Minimum Cycle Time, whichever is greater, as the virtual cycle time. The calculated value of the virtual cycle time can be monitored in the detailed mode display of the [System Status].

**Note** The Minimum Cycle Time process in the virtual cycle time is not a process where the execution stands by till the cycle time reaches the specified value, but where the Minimum Cycle Time is set.

**Major Error Factors in the Virtual Cycle Time and Actual CS/CJ/CP-series CPU Unit's Cycle Time**

Process Item	Error factor/Error range
Computing Time	Using such a lot of instructions that greatly varies in instruction processing time depending on their parameters (e.g. Data Movement instructions) influences the computing time. For example, a maximum of $322.35 \pm 311.15 \mu s$ (1 word vs. 1000 words) error will occur for one Block Transfer instruction execution.
I/O Refresh Time	For the Special I/O Unit, CPU Bus Unit, or Inner Board, using such a Unit that varies in I/O refresh time depending on the Unit's status or settings changes I/O refresh time. For example, I/O refresh time will be 4.3 ms when the Position Control Unit (C200HW-NC413) is mounted and 5.5 ms when reading/writing, making an error of 1.2 ms.
Peripheral Servicing time	When "Fixed Peripheral Servicing Time" is disabled, 4% of the immediately previous cycle time is serviced for each event service. When the immediately previous cycle time is 10 ms, an error of $10 \text{ ms} \times 0.04 \times 6$ (event services) = 2.4 ms will occur if the longest time is serviced for all of the event services.

**Computer Cycle Time**

The computer cycle time is the actual elapsed time of the Ladder Engine executed on the computer, which is the execution time depending on the computer's performance. It is different from the cycle time where an actual PLC operates.

**Calculating Computer Cycle Time**

In calculating the computer cycle time, the followings are different from that of the CS/CJ/CP-series CPU Unit.

Process name		Process Contents	Processing time and Fluctuation factors
(1)	Overseeing Processing	Back up the I/O memory areas	Time for I/O memory areas back-up
(2)	Computing Process	Process instructions of the user program in UM1 and UM2. Sum of the execution time of instructions.	Sum of the instruction execution time for UM1 and UM2
(3)	Minimum Cycle Time Calculation	Calculate the cycle time. Enabling "Minimum Cycle Time" in PLC Setup will wait for the cycle time to complete with WDT resetting.	Approximate to 0 for the time when Minimum Cycle Time is not set. The additional time for Minimum Cycle Time = The cycle time specified as Minimum Cycle Time - The computer cycle time ((1)+(2)+(4)+(5))
(4)	I/O Refresh	Not processed in the computer cycle time.	0 ms
(5)	Peripheral Servicing	An event service with the CS/CJ-series Special I/O Unit, targeting the Network Communications Unit and the Serial Communications Unit. <b>Note:</b> I/O refresh is not included.	All of the services that occurred in the cycle are executed regardless of the setting of Fixed Peripheral Servicing Time" of PLC Setup.

Computer cycle time = (1) + (2) + (3) + (5)

**Note** The computer cycle time may greatly fluctuate depending on the execution environment such as file access and memory swapping.

**Time Elapse in Computer Cycle Time**

The time elapse when Continuous Run in the computer cycle time is the same as that on the computer.

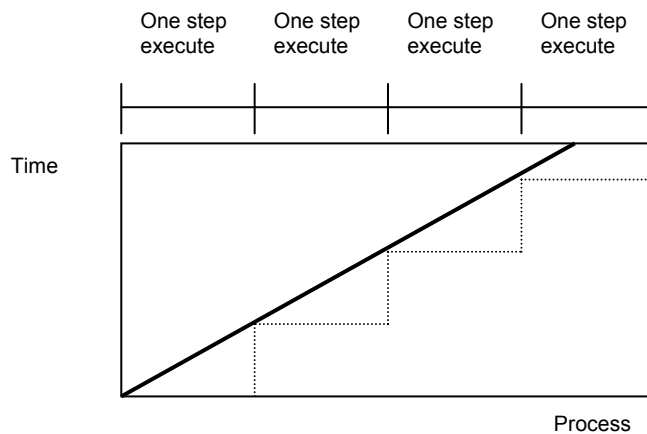

Note: The dashed line shows the time elapse in the virtual cycle time.

For Step Run and Scan Run, time elapse during pausing is included in the computer cycle time.

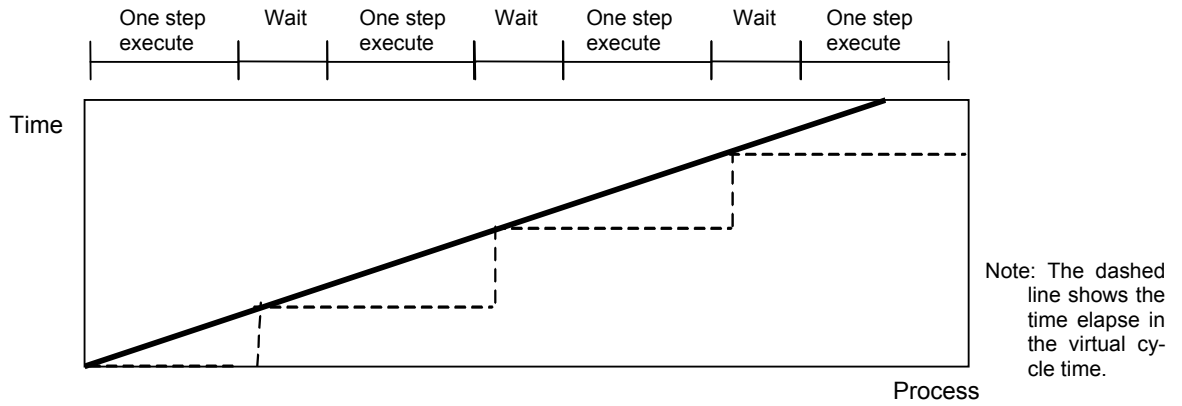

- Computer Cycle Time      The actual time given by subtracting standby time from one cycle time.
- Timer                              The standby time is added.
- Pulse                                The standby time is added.
- Clock                                The standby time is added as the clock time (same as the computer elapse time).

**Note** When stood by (paused), the accumulated computer cycle time is different from the elapse clock time in the same period.

**Minimum Cycle Time**

When Minimum Cycle Time is enabled in the computer cycle time, the Ladder Engine gets the scan to wait till the specified cycle time completes. If the CPU occupancy is larger than the set value then, the CPU occupancy overrides the Minimum Cycle Time to set the wait time.

**9-2-2 Maximum CPU Occupancy and Execution Time**

Set the following maximum CPU occupancy in the Maximum CPU Occupancy of the [Status] | [Settings] | [PLC Clock Settings] dialog box.

Set the upper limit of the CPU occupancy of the Ladder Engine on the computer as the maximum CPU occupancy. If the CX-Simulator responses slowly in the window operation, reducing the CPU occupancy will decrease the CPU occupancy of the Ladder Engine (60% in default).

On the contrary, if the computer cycle time is long, raising the CPU occupancy may decrease the computer cycle time (The virtual cycle time is not affected.) The setting of the CPU occupancy will be reflected from the next cycle.



### **9-2-3 Differences with CS/CJ/CP Series**

<b>Built-in Clock Function</b>	The clock of the Ladder Engine is the same as that of the computer when startup. However, it will not synchronize with the clock of the computer because it advances according to the virtual cycle time. So if synchronization is required, operate the CX-Simulator in the computer cycle time.
<b>High-speed Timer</b>	When executing a program in the computer cycle time, the High-speed Timer and 1-ms Timer will not be guaranteed to operate correctly.
<b>Interrupt Time when Online Editing</b>	When editing online by the CX-Simulator, the cycle time will not be affected in the virtual cycle time. However, interrupt time will occur in the computer cycle time as well as the actual CS/CJ/CP-series PLC.

## 9-3 I/O Memory Allocation

### 9-3-1 PLC Setup Settings

Item	CS/CJ-series PLC		CX-Simulator	
	Settings	Function	Settings	Function
Basic I/O Unit Input Response Time Rack 0 to 7, Slot 0 to 9	00: 8 ms 10: 0 ms 11: 0.5 ms 12: 1 ms 13: 2 ms 14: 4 ms 15: 8 ms 16: 16 ms 17: 32 ms  Default: 00 (8 ms)	Sets the input response time (ON response time = OFF response time) for CS/CJ-series Basic I/O Units. The default Setting is 8 ms and the setting range is 0 ms to 32 ms.	Not used.	
IOM Hold Bit Status at Startup	0: Cleared 1: Retained  Default: 0	This setting determines whether or not the status of the IOM Hold Bit (A50012) is retained at startup. When you want all of the data in I/O Memory to be retained when the power is turned on, turn ON the IOM Hold Bit and set this setting to 1 (ON).	Same as CS/CJ-series PLC.	
Forced Status Hold Bit at Startup	0: Cleared 1: Retained  Default: 0	This setting determines whether or not the status of the Forced Status Hold Bit (A50013) is retained at startup. When you want all of the bits that have been force-set or force-reset to retain their forced status when the power is turned on, turn ON the Forced Status Hold Bit and set this setting to 1 (ON).	Same as CS/CJ-series PLC.	
Startup Mode	PRCN: Programming Console's mode switch  PRG: PROGRAM mode  MON: MONITOR mode  RUN: RUN mode  Default: RPCN	This setting determines whether the startup mode will be the mode set on the Programming Console's mode switch or the mode set here in the PLC Setup. (If this setting is PRCN and a Programming Console isn't connected, the CPU Unit will automatically enter PROGRAM mode at startup.)	PRCN (fixed)	As this setting is fixed to PRCN, the CPU Unit will automatically enter PROGRAM mode.
Detect Low Battery	0: Detect 1: Do not detect  Default: 0	This setting determines whether CPU Unit battery errors are detected. If this setting is set to 0 and a battery error is detected, the Battery Error Flag (A40204) will be turned ON.	Not used.	

Item		CS/CJ-series PLC		CX-Simulator	
		Settings	Function	Settings	Function
Detect Interrupt Task Error		0: Detect 1: Do not detect  Default: 0	This setting determines whether interrupt task errors are detected. If this setting is set to 0 and an interrupt task error is detected, the Interrupt Task Error Flag (A40213) will be turned ON.	Not used.	
EM File Memory Settings	EM File Memory	0: None 1: EM File Memory Enabled  Default: 0	This setting determines whether part of the EM Area will be used for file memory.	Same as CS/CJ-series PLC.	
	EM File Memory Starting Bank	0 to C (0 to 12)  Default: 0	If Bit 7 (above) is set to 1, the setting here specifies the EM bank where file memory begins. The specified EM bank and all subsequent banks will be used as file memory. This setting will be disabled if bit 7 is set to 0.	Same as CS/CJ-series PLC.	The EM file memory allocates the hard disk of the same capacity actually.
Peripheral Port Settings	Peripheral Port Settings Selection	0: Default 1: PLC Setup  Default: 0	This setting is effective only when pin 4 of the DIP switch on the front of the CPU Unit is ON.	Not used.	
	Communications mode	00: Host Link 02: 1:N NT Links 04: Peripheral bus 05: Host Link  Default: 00	This setting determines whether the peripheral port will operate in host link mode or another serial communications mode. (Host link can be specified with 00 or 05.)		
	Data bits	0: 7 bits 1: 8 bits  Default: 0	These settings are valid only when the communications mode is set to Host Link.		
	Stop bits	0: 2 bits 1: 1 bit  Default: 0	These settings are also valid only when the Peripheral Port Settings Selection is set to 1: PLC Setup.		
	Parity	00: Even 01: Odd 10: None  Default: 00			

Item		CS/CJ-series PLC		CX-Simulator	
		Settings	Function	Settings	Function
Peripheral Port Settings	Communications rate (bps)	00: 9,600 01: 300 02: 600 03: 1,200 04: 2,400 05: 4,800 06: 9,600 07: 19,200 08: 38,400 09: 57,600 0A: 115,200  Default: 00	Settings 00 and 06 through 0A are valid when the communications mode is set to peripheral bus. This setting is not valid when the communications mode is set to NT Link.	Not used.	
	CPU Unit's Unit Number in Host Link Mode	00 to 1F (0 to 31)  Default: 00	This setting determines the CPU Unit's unit number when it is connected in a 1-to-N (N=2 to 32) host link.		
	Maximum Unit Number in NT Link Mode	0 to 7  Default: 0	This setting determines the highest unit number of PT that can be connected to the PLC in NT Link mode.		
RS-232C Port Settings	RS-232C Port Settings Selection	0: Default* 1: PLC Setup  Default: 0	This setting is effective only when pin 5 of the DIP switch on the front of the CPU Unit is OFF. *The default settings are: host link mode, 1 start bit, 7 data bits, even parity, 2 stop bits, and a baud rate of 9,600 bps.	Not used.	
	Communications mode	00: Host link 02: NT link (1: N mode) 03: No-protocol 04: Peripheral bus 05: Host link  Default: 0	This setting determines whether the RS-232C port will operate in host link mode or another serial communications mode. (Host link can be specified with 00 or 05.)The Peripheral bus mode is for communications with Programming Devices other than the Programming Console.		
	Data bits	0: 7 bits 1: 8 bits  Default: 0	These settings are valid only when the communications mode is set to host link or no-protocol. These settings are also valid only when the RS-232C Port Settings Selection is set to 1: PLC Setup.		
	Stop bits	0: 2 bits 1: 1 bit  Default: 0			
	Parity	00: Even 01: Odd 10: None  Default: 00			

Item		CS/CJ-series PLC		CX-Simulator	
		Settings	Function	Settings	Function
RS-232C Port Set-tings	Baud rate (bps)	00: 9,600 01: 300 02: 600 03: 1,200 04: 2,400 05: 4,800 06: 9,600 07: 19,200 08: 38,400 09: 57,600 0A: 115,200  Default: 00	Settings 00 and 06 through 0A are valid when the communications mode is set to peripheral bus. This setting is not valid when the communications mode is set to NT Link.	Same as CS/CJ-series PLC.	
	No-protocol mode delay	0000 to 270F: 0 to 99990 ms (10-ms units)  Default: 0	This setting determines the delay from execution of TXD(236) until the data is actually transmitted from the specified port.	Same as CS/CJ-series PLC.	
	CPU Unit's Unit Number in Host Link Mode	00 to 1F: (0 to 31)  Default: 00	This setting determines the CPU Unit's unit number when it is connected in a 1-to-N (N=2 to 32) host link.	Same as CS/CJ-series PLC.	
	No-protocol Mode	00 to FF  Default: 00	Start code: Set this start code only when the start code is enabled (1) in bits 12 to 15 of 165.	Same as CS/CJ-series PLC.	
		00 to FF  Default: 00	End code: Set this end code only when the end code is enabled (1) in bits 8 to 11 of 165.	Same as CS/CJ-series PLC.	
		0: None 1: Code in 164  Default: 0	Start code setting: A setting of 1 enables the start code in 164 bits 8 to 15.	Same as CS/CJ-series PLC.	
		0: None 1: Code in 164 2: CR+LF  Default: 0	End code setting	Same as CS/CJ-series PLC.	
		00: 256 bytes 01 to FF: 1 to 255 bytes  Default: 00	Set this value only when the end code setting in bits 8 to 11 of 165 is "0: None." This setting can be used to change the amount of data that can be transferred at one time by TXD(236) or RXD(235). The default setting is the maximum value of 256 bytes.	Same as CS/CJ-series PLC.	
	Max. Unit Number in NT Link Mode	0 to 7  Default: 0	This setting determines the highest unit number of PT that can be connected to the PLC in NT Link mode.	Not used.	
	Scheduled Interrupt Time Units	0: 10 ms 1: 1.0 ms  Default: 0	This setting determines the time units used in scheduled interrupt interval settings.	Same as CS/CJ-series PLC.	

Item		CS/CJ-series PLC		CX-Simulator	
		Settings	Function	Settings	Function
Instruction Error Operation		0: Continue 1: Stop  Default: 0	This setting determines whether instruction errors (instruction processing errors (ER) and illegal access errors (AER)) are treated as non-fatal or fatal errors. When this setting is set to 1, CPU Unit operation will be stopped if the ER or AER Flags is turned ON (even when the AER Flag is turned ON for an indirect DM/EM BCD error). Related Flags: A29508 (Instruction Processing Error Flag) A29509 (Indirect DM/EM BCD Error Flag) A29510 (Illegal Access Error Flag)	Same as CS/CJ-series PLC.	
Minimum Cycle Time		0001 to 7D00: 1 to 32,000 ms (1-ms units)  Default: 0000 (No minimum)	Set to 0001 to 7D00 to specify a minimum cycle time. If the cycle time is less than this setting, it will be extended until this time passes. Leave this setting at 0000 for a variable cycle time.	Same as CS/CJ-series PLC.	
Watch Cycle Time	Enable Watch Cycle Time Setting	0: Default 1: Bits 0 to 14  Default: 0	Set to 1 to enable the Watch Cycle Time Setting in bits 0 to 14. Leave this setting at 0 for a maximum cycle time of 1 s.	Same as CS/CJ-series PLC.	
	Watch Cycle Time Setting	001 to FA0: 10 to 40,000 ms (10-ms units)  Default: 001 (1 s)	This setting is valid only when bit 15 of 209 is set to 1. The Cycle Time Too Long Flag (A40108) will be turned ON if the cycle time exceeds this setting.	Same as CS/CJ-series PLC.	
Fixed Peripheral Servicing Time	Enable Fixed Servicing Time	0: Default* 1: Bits 0 to 7  Default: 0	Set to 1 to enable the fixed peripheral servicing time in bits 0 to 7. *Default: 4% of the cycle time	Not used.	
	Fixed Servicing Time	00 to FF: 0.0 to 25.5 ms (0.1-ms units)  Default: 00	This setting is valid only when bit 15 of 218 is set to 1.	Not used.	
Power OFF Interrupt Task		0: Disabled 1: Enabled  Default: 0	When this setting is set to 1, the power OFF interrupt task will be executed when power is interrupted.	Same as CS/CJ-series PLC.	
Power OFF Detection Delay Time		00 to 0A: 0 to 10 ms (1-ms units)  Default: 00	This setting determines how much of a delay there will be from the detection of a power interruption (approximately 10 to 25 ms after the power supply voltage drops below 85% of the rated value) to the confirmation of a power interruption. The default setting is 0 ms.	Not used.	

Item	CS/CJ-series PLC		CX-Simulator	
	Settings	Function	Settings	Function
Special I/O Unit Cyclic Refreshing  Units 0 to 95	0: Enabled 1: Disabled  Default: 0	These settings determine whether data will be exchanged between the specified Unit and the Special I/O Unit's allocated words (10 words/Unit) during cyclic refreshing for Special I/O Units.	Not used.	

### 9-3-2 Auxiliary Area (Read-only Area)

A000 to A447: Read-only Area, A448 to A959: Read/Write Area

Address		Name	CS/CJ-series PLC		CX-Simulator	
Words	Bits		Function	Settings	Function	Settings
A050 to A089		Basic I/O Unit Information.	A bit will turn ON to indicate when a fuse has blown. The bit numbers correspond to the fuse number on the Unit.	1: Fuse blown 0: Normal	Not used.	
A099	A09914	IR/DR Operation between Tasks (CS1-H CPU Units only)	Turn ON this bit to share index and data registers between all tasks. Turn OFF this bit to use separate index and data registers in each task.	1: Shared (default) 0: Independent	Same as CS/CJ-series PLC.	
	A09915	Timer/Counter Present Value Refresh Method Flag (CS1-H CPU Units only)	Indicates if the CPU Unit is using BCD or binary (hexadecimal) for timer/counter operation.	1: Binary 0: BCD	Same as CS/CJ-series PLC.	

Address		Name	CS/CJ-series PLC		CX-Simulator	
Words	Bits		Function	Settings	Function	Settings
A100 to A199		Error Log Area	<p>When an error has occurred, the error code, error contents, and error's time and date are stored in the Error Log Area. Information on the 20 most recent errors can be stored.</p> <p>Each error record occupies 5 words; the function of these 5 words is as follows:</p> <ol style="list-style-type: none"> <li>1) Error code (bits 0 to 15)</li> <li>2) Error contents (bits 0 to 15)</li> <li>3) Minutes (bits 8 to 15), Seconds (bits 0 to 7)</li> <li>4) Day of month (bits 8 to 15), Hours (bits 0 to 7)</li> <li>5) Year (bits 8 to 15), Month (bits 0 to 7)</li> </ol>	<p>Error code</p> <p>Error contents: Address of Aux. Area word with details or 0000.</p> <p>Seconds: 00 to 59, BCD</p> <p>Minutes: 00 to 59, BCD</p> <p>Hours: 00 to 23, BCD</p> <p>Day of month: 00 to 31, BCD</p> <p>Year: 00 to 99, BCD</p>	Same as CS/CJ-series PLC.	
A200	A20014	Task Started Flag	<p>When a task switches from WAIT or INI to RUN status, this flag will be turned ON within the task for one cycle only.</p> <p>The only difference between this flag and A20015 is that this flag also turns ON when the task switches from WAIT to RUN status.</p>	ON for the first cycle (including transitions from WAIT to INI)	Same as CS/CJ-series PLC.	



Address		Name	CS/CJ-series PLC		CX-Simulator	
Words	Bits		Function	Settings	Function	Settings
A200	A20011	First Cycle Flag	ON for one cycle after PLC operation begins (after the mode is switched from PROGRAM to RUN or MONITOR, for example).	ON for the first cycle	Same as CS/CJ-series PLC.	
	A20012	Step Flag	ON for one cycle when step execution is started with STEP(008). This flag can be used for initialization processing at the beginning of a step.	ON for the first cycle after execution of STEP(008).	Same as CS/CJ-series PLC.	
	A20015	First Task Startup Flag	ON when a task is executed for the first time. This flag can be used to check whether the current task is being executed for the first time so that initialization processing can be performed if necessary.	1: First execution 0: Not executable for the first time or not being executed.	Same as CS/CJ-series PLC.	
A201	A20110	Online Editing Wait Flag	ON when an online editing process is waiting. (If another online editing command is received while waiting, the other command won't be recorded and an error will occur.)	1: Waiting for online editing  0: Not waiting for online editing	Not used.	
	A20111	Online Editing Flag	ON when an online editing process is being executed.	1: Online editing in progress  0: Online editing not in progress	Not used.	
A202	A20200 to A20207	Communications Port Enabled Flags	ON when a network instruction (SEND, RECV, CMND, or PMCR) can be executed with the corresponding port number. Bits 00 to 07 correspond to communications ports 0 to 7. When two or more network instructions are programmed with the same port number, use the corresponding flag as an execution condition to prevent the instructions from being executed simultaneously. (The flag for a given port is turned OFF while a network instruction with that port number is being executed.)	1: Network instruction is not being executed  0: Network instruction is being executed (port busy)	Same as CS/CJ-series PLC.	

Address		Name	CS/CJ-series PLC		CX-Simulator	
Words	Bits		Function	Settings	Function	Settings
A202	A20208	CJ2 Network Instructions Enabled Flag	ON when the CJ2 network instructions can be used. The default is ON. This flag is used to show the availability of the SEND2, CMND2, PMCR2, and RECV2 network instructions. (CJ2-series PLCs only)			
A203 to A210	All	Communications Port Completion Codes	These words contain the completion codes for the corresponding port numbers when network instructions (SEND, RECV, CMND, or PMCR) have been executed. Words A203 to A210 correspond to communications ports 0 to 7. (The completion code for a given port is cleared to 0000 when a network instruction with that port number is executed.)	Non-zero: Error code  0000: Normal condition	Same as CS/CJ-series PLC.	
A211	All	Number of Ports Available for CJ2 Network Instructions	When the value of this word becomes 0, the A20208 bit will turn OFF. This word is used for the SEND2, CMND2, PMCR2, and RECV2 network instructions only. The communications load can be checked with this bit. (CJ2-series PLCs only)	0 to 64	Same as CS/CJ-series PLC.	
A219	A21900 to A21907	Communications Port Error Flags	ON when an error occurred during execution of a network instruction (SEND, RECV, CMND, or PMCR). Bits 00 to 07 correspond to communications ports 0 to 7. (All of these flags are turned OFF at the start of program execution and the flag for a given port is turned OFF when a network instruction with that port number is executed.)	1: Error occurred  0: Normal condition	Same as CS/CJ-series PLC. (Not cleared at startup.)	
A220 to A259	A22000 to 25915	Basic I/O Unit Input Response Times	These words contain the actual input response times for CS/CJ-series Basic I/O Units.	0 to 17 hexadecimal	Not used.	
A262 and A263	All	Maximum Cycle Time	These words contain the maximum cycle time since the start of PLC operation. The cycle time is recorded in 8-digit hexadecimal with the leftmost 4 digits in A263 and the rightmost 4 digits in A262.	0 to FFFFFFFF:  0 to 429,496,729.5ms (0.1ms units)	Same as CS/CJ-series PLC.	

Address		Name	CS/CJ-series PLC		CX-Simulator	
Words	Bits		Function	Settings	Function	Settings
A264 and A265	All	Present Cycle Time	These words contain the present cycle time in 8-digit hexadecimal with the leftmost 4 digits in A265 and the rightmost 4 digits in A264.	0 to FFFFFFFF:  0 to 429,496,729.5ms	Same as CS/CJ-series PLC.	
A266 and A267	All	Present Cycle Time (0.01 ms units)	These words contain the 0.01ms-unit present cycle time in 8-digit hexadecimal with the leftmost 4 digits in A267 and the rightmost 4 digits in A266. 0 to FFFFFFFF: 0 to 42,949,672.95 ms (0.01 ms units) (CJ2-series PLCs only)	0 to FFFFFFFF:  0 to 42,949,672.95 ms (0.01 ms units)	Not used	
A294	All	Task Number when Program Stopped	This word contains the task number of the task that was being executed when program execution was stopped because of a program error. (A298 and A299 contain the program address where program execution was stopped.)	Normal tasks: 0000 to 001F (task 0 to 31)  Interrupt tasks: 8000 to 80FF (task 0 to 255)	Same as CS/CJ-series PLC.	

Address		Name	CS/CJ-series PLC		CX-Simulator	
Words	Bits		Function	Settings	Function	Settings
A295	A29508	Instruction Processing Error Flag	This flag and the Error Flag (ER) will be turned ON when an instruction processing error has occurred and the PLC Setup has been set to stop operation for an instruction error. CPU Unit operation will stop and the ERR/ALM indicator will light when this flag goes ON. (The task number where the error occurred will be stored in A294 and the program address will be stored in A298 and A299.)	1: Error Flag ON  0: Error Flag OFF	Same as CS/CJ-series PLC.	
	A29509	Indirect DM/EM BCD Error Flag	This flag and the Access Error Flag (AER) will be turned ON when an indirect DM/EM BCD error has occurred and the PLC Setup has been set to stop operation an indirect DM/EM BCD error. (This error occurs when the content of an indirectly addressed DM or EM word is not BCD although BCD mode has been selected.) CPU Unit operation will stop and the ERR/ ALM indicator will light when this flag goes ON. (The task number where the error occurred will be stored in A294 and the program address will be stored in A298 and A299.)	1: Not BCD  0: Normal	Same as CS/CJ-series PLC.	

Address		Name	CS/CJ-series PLC		CX-Simulator	
Words	Bits		Function	Settings	Function	Settings
A295	A29510	Illegal Access Error Flag	<p>This flag and the Access Error Flag (AER) will be turned ON when an illegal access error has occurred and the PLC Setup has been set to stop operation an illegal access error. (This error occurs when a region of memory is access illegally.) CPU Unit operation will stop and the ERR/ALM indicator will light when this flag goes ON.</p> <p>The following operations are considered illegal access:</p> <ol style="list-style-type: none"> <li>1) Reading/writing the system area</li> <li>2) Reading/writing EM File Memory</li> <li>3) Writing to a write-protected area</li> <li>4) Indirect DM/EM BCD error (in BCD mode)</li> </ol> <p>(The task number where the error occurred will be stored in A294 and the program address will be stored in A298 and A299.)</p>	<p>1: Illegal access occurred</p> <p>0: Normal condition</p>	Same as CS/CJ-series PLC.	

Address		Name	CS/CJ-series PLC		CX-Simulator	
Words	Bits		Function	Settings	Function	Settings
A295	A29511	No END Error Flag	ON when there isn't an END(001) instruction in each program within a task. CPU Unit operation will stop and the ERR/ALM indicator will light when this flag goes ON. (The task number where the error occurred will be stored in A294 and the program address will be stored in A298 and A299.)	1: No END 0: Normal condition	Same as CS/CJ-series PLC.	
	A29512	Task Error Flag	ON when a task error has occurred. The following conditions generate a task error. There isn't even one regular task that is executable (started). <ul style="list-style-type: none"> <li>• There isn't a program allocated to the task.</li> <li>• (The task number where the error occurred will be stored in A294 and the program address will be stored in A298 and A299.)</li> </ul>	1: Error 0: Normal	Same as CS/CJ-series PLC.	
	A29513	Differentiation Overflow Error Flag	The allowed value for Differentiation Flags which correspond to differentiation instructions has been exceeded. CPU Unit operation will stop and the ERR/ALM indicator will light when this flag goes ON. (The task number where the error occurred will be stored in A294 and the program address will be stored in A298 and A299.)	1: Error 0: Normal	Same as CS/CJ-series PLC.	
	A29514	Illegal Instruction Error Flag	ON when a program that cannot be executed has been stored. CPU Unit operation will stop and the ERR/ALM indicator will light when this flag goes ON. (The task number where the error occurred will be stored in A294 and the program address will be stored in A298 and A299.)	1: Error 0: Normal	Same as CS/CJ-series PLC.	
	A29515	UM Overflow Error Flag	ON when the last address in UM (User Memory) has been exceeded. CPU Unit operation will stop and the ERR/ALM indicator will light when this flag goes ON.	1: Error 0: Normal	Same as CS/CJ-series PLC.	
A298	All	Program Address Where Program Stopped (Rightmost 4 digits)	These words contain the 8-digit binary program address of the instruction where program execution was stopped due to a program error.	Right 4 digits of the program address	Same as CS/CJ-series PLC.	

Address		Name	CS/CJ-series PLC		CX-Simulator	
Words	Bits		Function	Settings	Function	Settings
A299	All	Program Address Where Program Stopped (Leftmost 4 digits)	(A294 contains the task number of the task where program execution was stopped.)	Left 4 digits of the program address	Same as CS/CJ-series PLC.	
A300	All	Error Log Pointer	When an error occurs, the Error Log Pointer is incremented by 1 to indicate the location where the next error record will be recorded as an offset from the beginning of the Error Log Area (A100 to A199). The Error Log Pointer can be cleared to 00 by turning A50014 (the Error Log Reset Bit) from OFF to ON. When the Error Log Pointer has reached 14 (20 decimal), the next record is stored in A195 to A199 when the next error occurs.	00 to 14 hexadecimal	Same as CS/CJ-series PLC.	
A301	All	Current EM Bank	This word contains the current EM bank number in 4-digit hexadecimal. The current bank number can be changed with the EMBC(281) instruction.	0000 to 000C hexadecimal	Same as CS/CJ-series PLC.	
A302	A30200 to A30215	CS/CJ-series CPU Bus Unit Initializing Flags	These flags are ON while the corresponding CS/CJ-series CPU Bus Unit is initializing after its CS/CJ-series CPU Bus Unit Restart Bit (A50100 to A50115) is turned from OFF to ON or the power is turned ON. Bits 00 to 15 correspond to unit numbers 0 to 15.	0: Not initializing 1: Initializing (Reset to 0 automatically after initialization.)	Not used.	

Address		Name	CS/CJ-series PLC		CX-Simulator	
Words	Bits		Function	Settings	Function	Settings
A315	A31504	System Work Error Flag (Non-fatal Error Flag)	ON when an error has been detected in the work memory for online editing. While this flag is ON, online editing is disabled. (CJ2-series PLCs only)	0: No error 1: Error	Not used	
	A31512	Tag Memory Error Flag (Non-fatal Error Flag)	ON when an error has occurred in the tag memory where network symbols are stored. (CJ2-series PLCs only)		Not used	
	A31515	Backup Memory Error Flag	ON when writing of backup data or source/comments has been failed. When the detected error is cleared, this flag will turn OFF. (CJ2-series PLCs only)		Not used	
A330 to A335	A33000 to A33515	Special I/O Unit Initializing Flags	These flags are ON while the corresponding Special I/O Unit is initializing after its Special I/O Unit Restart Bit (A50200 to A50715) is turned from OFF to ON or the power is turned ON. The bits in these words correspond to unit numbers.	0: Not initializing 1: Initializing (Reset to 0 automatically after initialization.)	Not used.	
A339 and A340	All	Maximum Differentiation Flag Number	These words contain the maximum value of the differentiation flag numbers being used by differentiation instructions.		Same as CS/CJ-series PLC.	



Address		Name	CS/CJ-series PLC		CX-Simulator	
Words	Bits		Function	Settings	Function	Settings
A343	A34300 to A34302	Memory Card Type	Indicates the type of Memory Card, if any, installed.	0: None 4: Flash ROM	Set as Memory Card is always installed.	4:Flash ROM
	A34306	EM File Memory Format Error Flag	ON when a format error occurs in the first EM bank allocated for file memory. (The flag is turned OFF when formatting is completed normally.)	1: Format error 0: No format error	Same as CS/CJ-series PLC.	
	A34307	Memory Card Format Error Flag	ON when the Memory Card is not formatted or a formatting error has occurred. (The flag is turned OFF when formatting is completed normally.)	1: Format error 0: No format error	Same as CS/CJ-series PLC.	
	A34308	File Transfer Error Flag	ON when an error occurred while writing data to file memory. (The flag is turned OFF when PLC operation begins or data is written successfully.)	1: Error 0: No error	Same as CS/CJ-series PLC.	
	A34309	File Write Error Flag	ON when data cannot be written to file memory because it is write-protected or the data exceeds the capacity of the file memory. (The flag is turned OFF when PLC operation begins or data is written successfully.)	1: Write not possible 0: Normal condition	Not used.	
	A34310	File Read Error	ON when data could not be read from file memory because the file was corrupted. (The flag is turned OFF when PLC operation begins or data is read successfully.)	1: Read not possible 0: Normal condition	Same as CS/CJ-series PLC.	
	A34311	File Missing Flag	ON when the file memory doesn't exist or the source file doesn't exist. (The flag is turned OFF when PLC operation begins or data is read successfully.)	1: Specified file missing 0: Normal condition	Not used.	
	A34313	File Memory Instruction Flag	ON when a file memory instruction is being executed.	1: Instruction being executed. 0: Instruction not being executed.	Not used.	
	A34314	Accessing File Data Flag	ON while file data is being accessed.	1: File being accessed 0: File not being accessed	Not used.	
A34315	Memory Card Detected Flag	ON when a Memory Card has been detected. OFF when a Memory Card has not been detected.	1:Memory Card detected 0:Memory Card not detected	Not used.		

Address		Name	CS/CJ-series PLC		CX-Simulator	
Words	Bits		Function	Settings	Function	Settings
A344	All	EM File Memory Starting Bank	Contains the starting bank number of EM file memory (bank number of the first formatted bank). All EM banks from this starting bank to the last bank in EM are formatted for use as file memory.	0000 to 000C Hex  Bank 0 to C	Same as CS/CJ-series PLC.	
A346 and A347	All	Number of Remaining Words to Transfer	These words contain the 8-digit hexadecimal number of words remaining to be transferred by FREAD(700) or FWRT(701). When one of these instructions is executed, the number of words to be transferred is written to A346 and A347. While the data is being transferred, the value in these words is decremented each time that 1,024 words are transferred.	Data remaining in transfer (1,024 word, or 1-KW units)	Not used.	
A351 to A354	All	Calendar/Clock Area	These words contain the CPU Unit's internal clock data in BCD. The clock can be set from a Programming Device such as a Programming Console, with the DATE(735) instruction, or with a FINS command (CLOCK WRITE,0702).		Switches between Virtual Clock and Computer Clock depending on the Cycle Time Mode.	Same as CS/CJ-series PLC.
	A35100 to A35107		Seconds (00 to 59) (BCD)			
	A35108 to A35115		Minutes (00 to 59) (BCD)			
	A35200 to A35207		Hours (00 to 23) (BCD)			
	A35208 to A35215		Day of the month (01 to 31) (BCD)			
	A35300 to A35307		Month (01 to 12) (BCD)			
	A35308 to A35315		Year (00 to 99) (BCD)			
	A35400 to A35407		Day of the week (00 to 06) (BCD) 00: Sunday, 01: Monday, 02: Tuesday, 03: Wednesday, 04: Thursday, 05: Friday, 06: Saturday			
A355	A35500 to A35915	Inner Board Monitoring Area	The function of these words is defined by the Inner Board.		Not used.	

Address		Name	CS/CJ-series PLC		CX-Simulator	
Words	Bits		Function	Settings	Function	Settings
A360 to A391	A36001 to A39115	Executed FAL Number Flags	The flag corresponding to the specified FAL number will be turned ON when FAL(006) is executed. Bits A36001 to A39115 correspond to FAL numbers 001 to 511. The flag will be turned OFF when the error is cleared.	1: That FAL was executed  0: That FAL wasn't executed	Same as CS/CJ-series PLC.	
A385	A38506	File Deleted Flags	The system deleted the remainder of an EM file memory file that was being updated when a power interruption occurred.	1: File deleted 0: No files deleted	Not used.	
	A38507		The system deleted the remainder of a Memory Card file that was being updated when a power interruption occurred.	1: File deleted 0: No files deleted	Not used.	
A392	A39204	RS-232C Port Error Flag	ON when an error has occurred at the RS-232C port. (Not valid in peripheral bus mode or NT Link mode.)	1: Error 0: No error	Same as CS/CJ-series PLC.	
	A39205	RS-232C Port Send Ready Flag (No-protocol mode)	ON when the RS-232C port is able to send data in no-protocol mode.	1: Able-to-send 0: Unable-to-send	Same as CS/CJ-series PLC.	
	A39206	RS-232C Port Reception Completed Flag (No-protocol mode)	ON when the RS-232C port has completed the reception in no-protocol mode. • When the number of bytes was specified: ON when the specified number of bytes is received. • When the end code was specified: ON when the end code is received or 256 bytes are received.	1: Reception completed 0: Reception not completed	Same as CS/CJ-series PLC.	
	A39207	RS-232C Port Reception Overflow Flag (No-protocol mode)	ON when a data overflow occurred during reception through the RS-232C port in no-protocol mode. • When the number of bytes was specified: ON when more data is received after the reception was completed but before RXD(235) was executed. • When the end code was specified: ON when more data is received after the end code was received but before RXD(235) was executed. ON when 257 bytes are received before the end code.	1: Overflow 0: No overflow	Same as CS/CJ-series PLC.	

Address		Name	CS/CJ-series PLC		CX-Simulator	
Words	Bits		Function	Settings	Function	Settings
A392	A39212	Peripheral Port Communications Error Flag	ON when a communications error has occurred at the peripheral port. (Not valid in peripheral bus mode or NT Link mode.)	1: Error 0: No error	Not used.	
A393	A39300 to A39307	RS-232C Port PT Communications Flag	The corresponding bit will be ON when the RS-232C port is communicating with a PT in NT link mode. Bits 0 to 7 correspond to units 0 to 7.	1: Communicating 0: Not communicating	Same as CS/CJ-series PLC.	
	A39308 to A39315	RS-232C Port PT Priority Registered Flags	The corresponding bit will be ON for the PT that has priority when the RS-232C port is communicating in NT link mode. Bits 0 to 7 correspond to units 0 to 7.	1: Priority registered 0: Priority not registered	Not used.	
	A39300 to A39315	RS-232C Port Reception Counter (No-protocol mode)	Indicates (in binary) the number of bytes of data received when the RS-232C port is in no-protocol mode.		Same as CS/CJ-series PLC.	
A394	A39400 to A39407	Peripheral Port PT Communications Flag	The corresponding bit will be ON when the peripheral port is communicating with a PT in NT link mode. Bits 0 to 7 correspond to units 0 to 7.	1: Communicating 0: Not communication	Not used.	
	A39408 to 39415	Peripheral Port PT Priority Registered Flags	The corresponding bit will be ON for the PT that has priority when the peripheral port is communicating in NT link mode. Bits 0 to 7 correspond to units 0 to 7.	1: Priority registered 0: Priority not registered	Not used.	
A395	A39511	Memory Corruption Detected Flag	ON when memory corruption is detected when the power supply is turned ON.	1: Memory corruption 0: Normal operation	Not used.	
	A39512	DIP Switch Pin 6 Status Flag	The status of pin 6 on the DIP switch on the front of the CPU Unit is written to this flag every cycle.	1: Pin 6 ON 0: Pin 6 OFF	Same as CS/CJ-series PLC.	Not set in the Program mode

Address		Name	CS/CJ-series PLC		CX-Simulator	
Words	Bits		Function	Settings	Function	Settings
A400	All	Error code	When a non-fatal error (user-defined FALS(006) or system error) or a fatal error (user-defined FALS(007) or system error) occurs, the 4-digit hexadecimal error code is written to this word. When two or more errors occur simultaneously, the highest error code will be recorded. Refer to the <i>CS/CJ Series Operation Manual</i> for details on error codes.	Error code	Same as CS/CJ-series PLC.	
A401	A40103	Card Transfer Error Flag	ON when the contents of the memory card cannot be transferred to the CPU Unit at power ON. (CJ2H-CPU6□ and CJ2M-CPU1□ only)	0: No error 1: Error	Not used.	
	A40105	Version Error Flag	ON when the transferred user program contains a function that is not supported by the unit version of the CPU Unit.		Not used.	
	A40106	FALS Error Flag (Fatal error)	ON when a non-fatal error is generated by the FALS(006) instruction. The CPU Unit will continue operating and the ERR/ALM indicator will flash. The corresponding error code will be written to A400. Error codes C101 to C2FF correspond to FALS numbers 001 to 511. This flag will be turned OFF when the FALS errors are cleared.	1: FALS(006) executed 0: FALS(006) not executed	Same as CS/CJ-series PLC.	
	A40108	Cycle Time Too Long Flag (Fatal error)	ON if the cycle time exceeds the maximum cycle time set in the PLC Setup (the cycle time monitoring time). CPU Unit operation will stop and the ERR/ALM indicator on the front of the CPU Unit will light. This flag will be turned OFF when the error is cleared.	0: Cycle time under max. 1: Cycle time over max.	Same as CS/CJ-series PLC.	

Address		Name	CS/CJ-series PLC		CX-Simulator	
Words	Bits		Function	Settings	Function	Settings
A401	A40109	Program Error Flag (Fatal error)	ON when program contents are incorrect. CPU Unit operation will stop and the ERR/ALM indicator on the front of the CPU Unit will light. The task number where the error occurred will be stored in A294 and the program address will be stored in A298 and A299. The type of program error that occurred will be stored in bits 8 to 15 of A295. Refer to the <i>CX-Programmer Operation Manual (W446)</i> . This flag will be turned OFF when the error is cleared.	1: Error 0: No error	Same as CS/CJ-series PLC.	
	A40110	I/O Setting Error Flag (Fatal error)	ON when an Input Unit has been installed in an Output Unit's slot or vice versa, so the Input and Output Units clash in the registered I/O table.	1: Error 0: No error	Not used.	
	A40111	Too Many I/O Points Flag (Fatal error)	ON when the number of I/O points being used in Basic I/O Units exceeds the maximum allowed for the PLC.	1: Error 0: No error	Not used.	
	A40112	Inner Board Stopped Error Flag (Fatal error)	ON when there is an Inner Board Error (Watchdog timer error or Inner bus error).	1: Error 0: No error	Not used.	
	A40113	Duplication Error Flag (Fatal error)	ON in the following cases: <ul style="list-style-type: none"> <li>• Two CS/CJ-series CPU Bus Units have been assigned the same unit number.</li> <li>• Two Special I/O Units have been assigned the same unit number.</li> <li>• Two Basic I/O Units have been allocated the same data area words.</li> </ul>	1: Duplication error 0: No duplication	Not used.	
	A40114	I/O Bus Error Flag (Fatal error)	ON when an error occurs in a data transfer between the CPU Unit and a Unit mounted to a slot.	1: Error 0: No error	Not used.	

Address		Name	CS/CJ-series PLC		CX-Simulator	
Words	Bits		Function	Settings	Function	Settings
A401	A40115	Memory Error Flag (Fatal error)	ON when an error occurred in memory or there was an error in automatic transfer from the Memory Card when the power was turned ON. CPU Unit operation will stop and the ERR/ALM indicator on the front of the CPU Unit will light. The location where the error occurred is indicated in A40300 to A40308, and A40309 will be turned ON if there was an error during automatic transfer at start-up. This flag will be turned OFF when the error is cleared. (The automatic transfer at start-up error cannot be cleared without turning off the PLC.)	1: Error 0: No error	Same as CS/CJ-series PLC.	

Address		Name	CS/CJ-series PLC		CX-Simulator	
Words	Bits		Function	Settings	Function	Settings
A402	A40202	Special I/O Unit Setting Error Flag (Non-fatal error)	ON when an installed Special I/O Unit does not match the Special I/O Unit registered in the I/O table. The CPU Unit will continue operating and the ERR/ALM indicator on the front of the CPU Unit will flash. The unit number of the Unit where the setting error occurred is indicated in A428 to A433. (This flag will be turned OFF when the error is cleared.)	1: Setting error detected 0: No setting error	Not used.	
	A40203	CS/CJ-series CPU Bus Unit Setting Error Flag (Non-fatal error)	ON when an installed CS/CJ-series CPU Bus Unit does not match the CS/CJ-series CPU Bus Unit registered in the I/O table. The CPU Unit will continue operating and the ERR/ALM indicator on the front of the CPU Unit will flash. The unit number of the Unit where the setting error occurred is written to A427. (This flag will be turned OFF when the error is cleared.)	1: Setting error detected 0: No setting error	Not used.	
	A40204	Battery Error Flag (Non-fatal error)	ON if the CPU Unit's battery is disconnected or its voltage is low and the Detect Battery Error setting has been set in the PLC Setup.	1: Error 0: No error	Not used.	
	A40205	SYSMAC BUS Error Flag (Non-fatal error)	ON when an error occurs in a data transfer in the SYSMAC BUS system. The number of the Master involved is indicated with bits A40500 and A40501.	1: Error 0: No error	Not used.	
	A40206	Special I/O Unit Error Flag (Non-fatal error)	ON when an error occurs in a data exchange between the CPU Unit and a Special I/O Unit (including an error in the Special I/O Unit itself).	1: Error in one or more Units 0: No errors in any Unit	Not used.	



Address		Name	CS/CJ-series PLC		CX-Simulator	
Words	Bits		Function	Settings	Function	Settings
A402	A40207	CS/CJ-series CPU Bus Unit Error Flag (Non-fatal error)	ON when an error occurs in a data exchange between the CPU Unit and a CS/CJ-series CPU Bus Unit (including an error in the CS/CJ-series CPU Bus Unit itself). The CPU Unit will continue operating and the ERR/ALM indicator on the front of the CPU Unit will flash. The CS/CJ-series CPU Bus Unit where the error occurred will stop operating and the unit number of the Unit where the data exchange error occurred is indicated in A417. (This flag will be turned OFF when the error is cleared.)	1: Error in one or more Units 0: No error in any Unit	Not used.	
	A40208	Inner Board Error Flag (Non-fatal error)	ON when an error occurs in a data exchange between the CPU Unit and the Inner Board (including an error in the Inner Board itself). The CPU Unit will continue operating and the ERR/ALM indicator on the front of the CPU Unit will flash. The Inner Board will stop operating and details on the error will be written to A424. (This flag will be turned OFF when the error is cleared.)	1: Error 0: No error	Not used.	
	A40209	I/O Verification Error Flag (Non-fatal error)	ON when a Basic I/O Unit registered in the I/O Table does not match the Basic I/O Unit actually installed in the PLC because a Unit was added or removed.	1: Mismatch 0: No mismatch	Not used.	
	A40210	PLC Setup Error Flag (Non-fatal error)	ON when there is a setting error in the PLC Setup. The CPU Unit will continue operating and the ERR/ALM indicator on the front of the CPU Unit will flash. The location of the error will be written to A406. (This flag will be turned OFF when the error is cleared.)	1: Error 0: No error	Same as CS/CJ-series PLC.	
	A40212	Basic I/O Unit Error Flag (Non-fatal error)	ON when an error has occurred in a Basic I/O Unit (including C200H Group-2 High-density I/O Units and C200H Interrupt Input Units).	1: Error 0: No error	Not used.	

Address		Name	CS/CJ-series PLC		CX-Simulator	
Words	Bits		Function	Settings	Function	Settings
A402	A40213	Interrupt Task Error Flag (Non-fatal error)	ON when the Detect Interrupt Task Errors setting in the PLC Setup is set to "Detect" and an interrupt task is executed for more than 10 ms during I/O refreshing of a C200H Special I/O Unit or a SYSMAC BUS I/O Unit. This flag will also be turned ON if an attempt is made to refresh a Special I/O Unit's I/O from an interrupt task with IORF(097) while the Unit's I/O is being refreshed by cyclic I/O refreshing(duplicate refreshing).	1: Interrupt task error 0: No error	Not used.	
	A40215	FAL Error Flag (Non-fatal error)	ON when a non-fatal error is generated by executing FALS(006). The CPU Unit will continue operating and the ERR/ALM indicator on the front of the CPU Unit will flash. The bit in A360 to A391 that corresponds to the FAL number specified in FALS(006) will be turned ON and the corresponding error code will be written to A400. Error codes 4101 to 42FF correspond to FAL numbers 001 to 2FF (0 to 511). (This flag will be turned OFF when the error is cleared.)	1: FALS(006) error occurred 0: FALS(006) not executed	Same as CS/CJ-series PLC.	
A403	A40300 to A40308	Memory Error Location	When a memory error occurs, the Memory Error Flag (A40115) is turned ON and one of the following flags is turned ON to indicate the memory area where the error occurred A40300: User program A40304: PLC Setup A40305: Registered I/O Table A40307: Routing Table A40308: CS/CJ-series CPU Bus Unit Settings When a memory error occurs, the CPU Unit will continue operating and the ERR/ALM indicator on the front of the CPU Unit will flash. (The corresponding flag will be turned OFF when the error is cleared.)	1: Error 0: No error	Same as CS/CJ-series PLC.	

Address		Name	CS/CJ-series PLC		CX-Simulator	
Words	Bits		Function	Settings	Function	Settings
A403	A40309	Memory Card Start-up Transfer Error Flag	ON when automatic transfer at startup has been selected and an error occurs during automatic transfer. An error will occur if there is a transfer error, the specified file does not exist, or the Memory Card is not installed. (This flag will be turned OFF when the error is cleared by turning the power off. The error cannot be cleared without turning the power off.)	1: Error 0: No error	Same as CS/CJ-series PLC.	
A404	A40400 to A40407	I/O Bus Error Slot Number	Contains the 8-bit binary slot number (00 to 09) where an I/O Bus Error occurred.	1: Error 0: No error	Not used.	
	A40408 to A40415	I/O Bus Error Rack Number	Contains the 8-bit binary rack number (00 to 07) where an I/O Bus Error occurred.	1: Error 0: No error	Not used.	
A405	A40500 and A40501	SYSMAC BUS Master Flags	When a transmission error occurs in the SYSMAC BUS system, the flag for the affected Master Unit will be turned ON. A40500: Flag for Master Unit #0 A40501: Flag for Master Unit #1	1: Error 0: No error	Not used.	
A406	All	PLC Setup Error Location	When there is a setting error in the PLC Setup, the location of that error is written to A406 in 4-digit hexadecimal. The location is given as the address displayed on a Programming Console. The CPU Unit will continue operating and the ERR/ALM indicator on the front of the CPU Unit will flash. (A406 will be cleared when the cause of the error is eliminated.)	000A to 009F hexadecimal	Same as CS/CJ-series PLC.	

Address		Name	CS/CJ-series PLC		CX-Simulator	
Words	Bits		Function	Settings	Function	Settings
A407	A40700 to A40712	Too Many I/O Points, Details	<p>The 6 possible causes of the Too Many I/O Points Error are listed below. The 3-digit binary value in A40713 to A40715 indicates the cause of the error (values 0 to 5 correspond to causes 1 to 6, below).</p> <p>The 13-bit binary value in A40700 to A40712 indicates the details: the excessive value or the duplicated unit number.</p> <p>CPU Unit operation will stop and the ERR/ALM indicator on the front of the CPU Unit will light.</p> <ol style="list-style-type: none"> <li>1) The number of I/O points will be written here when the total number of I/O points set in the I/O Table (excluding Slave Racks) exceed the maximum allowed for the CPU Unit.</li> <li>2) The number of interrupt inputs will be written here when there are more than 32 interrupt inputs.</li> <li>3) The unit number of the Slave Unit will be written here when a unit number is duplicated or the number of I/O points on a C500 Slave Unit exceeds 320.</li> <li>4) The unit number of the I/O Terminal (excluding Slave Racks) will be written here when a unit number is duplicated</li> <li>5) The unit number of the Master Unit will be written here when a unit number is duplicated or the unit number is outside of the allowed setting range.</li> <li>6) The number of Racks will be written here when the number of Expansion I/O Racks exceeds the maximum.</li> </ol>	0000 to 1FFF hexadecimal	Not used.	
	A40713 to A40715	Too Many I/O Points, Cause	<p>The 3-digit binary value of these bits indicates the cause of the Too Many I/O Points Error and shows the meaning of the value written to bits A40700 to A40712. Values of 000 to 101 (0 to 5) correspond to causes 1 through 6 described in "Too Many I/O Points, Cause 1," above.</p>		Not used.	

Address		Name	CS/CJ-series PLC		CX-Simulator	
Words	Bits		Function	Settings	Function	Settings
A408	A40800 to A40807	Basic I/O Unit Error, Slot Number	When an error has occurred in a Basic I/O Unit (including C200H Group-2 High-density I/O Units and C200H Interrupt Input Units), A40212 will be turned ON and the slot number where the error occurred will be written here in binary.	00 to 09 hexadecimal (Slots 0 to 9)	Not used.	
	A40808 to A40815	Basic I/O Unit Error, Rack Number	When an error has occurred in a Basic I/O Unit (including C200H Group-2 High-density I/O Units and C200H Interrupt Input Units), A40212 will be turned ON and the Rack number where the error occurred will be written here in binary.	00 to 07 hexadecimal (Racks 0 to 7)	Not used.	
A409	A40900 to A40907	Expansion I/O Rack Number Duplication Flags	The corresponding flag will be turned ON when an Expansion I/O Rack's starting word address was set from a Programming Device and two Racks have overlapping word allocations or a Rack's starting address exceeds CIO 0901. Bits 00 to 07 correspond to Racks 0 to 7.	1: Error 0: No error	Not used.	
A410	A41000 to A41015	CS/CJ-series CPU Bus Unit Number Duplication Flags	The Duplication Error Flag (A40113) and the corresponding flag in A410 will be turned ON when a CS/CJ-series CPU Bus Unit's unit number has been duplicated. Bits 00 to 15 correspond to unit numbers 0 to F. CPU Unit operation will stop and the ERR/ALM indicator on the front of the CPU Unit will light.	1: Duplication detected 0: No duplication	Not used.	
A411 to A416	A41100 to A41615	Special I/O Unit Number Duplication Flags	The Duplication Error Flag (A40113) and the corresponding flag in A411 through A416 will be turned ON when a Special I/O Unit's unit number has been duplicated.	1: Duplication detected 0: No duplication	Not used.	

Address		Name	CS/CJ-series PLC		CX-Simulator	
Words	Bits		Function	Settings	Function	Settings
A417	A41700 to A41715	CS/CJ-series CPU Bus Unit Error, Unit Number Flags	When an error occurs in a data exchange between the CPU Unit and a CS/CJ-series CPU Bus Unit, the CS/CJ-series CPU Bus Unit Error Flag (A40207) is turned ON and the bit in A417 corresponding to the unit number of the Unit where the error occurred is turned ON. Bits 00 to 15 correspond to unit numbers 0 to F. The CPU Unit will continue operating and the ERR/ALM indicator on the front of the CPU Unit will flash.	1: Error 0: No error	Not used.	
A418 to A423	A41800 to A42315	Special I/O Unit Error, Unit Number Flags	When an error occurs in a data exchange between the CPU Unit and a Special I/O Unit, the Special I/O Unit Error Flag (A40206) will be turned ON.	1: Error 0: No error	Not used.	
A424	A42400 to A42415	Inner Board Error Information	When an error occurs in a data exchange between the CPU Unit and the Inner Board, the Inner Board Error Flag (A40208) and the appropriate bits in A424 will be turned ON. • The meaning of the bits in A424 depends upon the model of Inner Board that is being used. Refer to the Board's operation manual for details. A424 will be cleared when the error is cleared.		Not used.	
A425	A42504 to A42506	Slave Number of SYSMAC BUS Error	When there is an error in a Slave Rack, these bits contain the Slave's unit number.	0 to 4 Hex (Unit No. 0 to 4)	Not used.	
	A42504	After Start-up	When there is an error in an Optical I/O Unit (excluding Slave Racks), the status of A42504 (ON or OFF) indicates whether the Unit is allocated high or low bytes.	1: High 0: Low	Same as CS/CJ-series PLC.	
	A42508 to A42515		When there is an error in a Slave Rack, this byte contains the 2-digit hexadecimal unit number of the Master to which the Slave is connected.	B0: Unit 0 B1: Unit 1	Same as CS/CJ-series PLC.	
			When there is an error in an Optical I/O Unit, this byte contains its 2-digit hexadecimal unit number (00 to 1F, or 0 to 31 decimal).	00 to 1F hex (0 to 31)		

Address		Name	CS/CJ-series PLC		CX-Simulator	
Words	Bits		Function	Settings	Function	Settings
A426	A42600 to A42611	Interrupt Task Error, Task Number	When A40213 is ON, the content of these bits depends upon the status of A42615 (the Interrupt Task Error Cause Flag). 1) A42615 OFF: An interrupt task was executed for more than 10 ms during I/O refreshing of a C200H Special I/O Unit or a SYSMAC BUS Remote I/O Unit. A42600 to A42611: contain the interrupt task number. 2) A42615 ON: An attempt was made to refresh a Special I/O Unit's I/O from an interrupt task with IORF(097) while the Unit's I/O is being refreshed by cyclic I/O refreshing (duplicate refreshing). A42600 to A42611: contain the Special I/O Unit's unit number.	Task number: 000 to 0FF (0 to 255) Unit number: 000 to 05F (0 to 95)	Not used.	
	A42615	Interrupt Task Error Cause Flag	When A40213 (the Interrupt Task Error Flag) is ON, this flag indicates the cause of the error. A42615 will be ON if a Special I/O Unit was refreshed from the interrupt task while it was already being refreshed. A42615 will be OFF if the interrupt task was executed for more than 10 ms during I/O refreshing of a C200H Special I/O Unit or a SYSMAC BUS Remote I/O Unit.	1: Duplicated refreshing 0: Interrupt task executed over 10 ms	Not used.	
A427	A42700 to A42715	CS/CJ-series CPU Bus Unit Setting Error, Unit Number Flags	When a CS/CJ-series CPU Bus Unit Setting Error occurs, A40203 and the bit in this word corresponding to the Unit's unit number are turned ON. Bits 00 to 15 correspond to unit numbers 0 to F. The CPU Unit will continue operating and the ERR/ALM indicator on the front of the CPU Unit will flash.	1: Setting error 0: No setting error	Not used.	
A428 to A433	A42800 to A43315	Special I/O Unit Setting Error, Unit Number Flags	When a Special I/O Unit Setting Error occurs, A40202 and the bit in these words corresponding to the Unit's unit number are turned ON. Bits 00 to 15 correspond to unit numbers 0 to F.	1: Setting error 0: No setting error	Not used.	

Address		Name	CS/CJ-series PLC		CX-Simulator	
Words	Bits		Function	Settings	Function	Settings
A440	All	Max. Interrupt Task Processing Time	Contains the Maximum Interrupt Task Processing Time in units of 0.1 ms. (This value is cleared when PLC operation begins.)	0000 to FFFF hexadecimal	Same as CS/CJ-series PLC. (Binary data in the unit of 0.1 μs)	
A441	All	Interrupt Task With Max. Processing Time	Contains the task number of the interrupt task with the maximum processing time. Hexadecimal values 8000 to 80FF correspond to task numbers 00 to FF. Bit 15 is turned ON when an interrupt has occurred. (This value is cleared when PLC operation begins.)	8000 to 80FF hexadecimal	Same as CS/CJ-series PLC.	
A442	A44211 to A44212	PLC Link Operating Level Detection Flags	Indicate whether PLC Link Units are mounted to the PLC as follows: A44211: PLC Link operating level 1 A44212: PLC Link operating level 0	1: Unit mounted 0: Unit not mounted	Not used.	

### 9-3-3 Auxiliary Area (Read/Write Area)

Address		Name	CS/CJ-series PLC		CX-Simulator	
Words	Bits		Function	Settings	Function	Settings
A500	A50012	IOM Hold Bit	Turn this bit ON to preserve the status of the I/O Memory when shifting from PROGRAM to RUN or MONITOR mode or vice versa. (If the status of the IOM Hold Bit itself is preserved in the PLC Setup (IOM Hold Bit Status), the status of the I/O Memory Area will be retained when the PLC is turned ON or power is interrupted.)	1: Retained 0: Not retained	Same as CS/CJ-series PLC.	
	A50013	Forced Status Hold Bit	Turn this bit ON to preserve the status of bits that have been force-set or force-reset when shifting from PROGRAM to MONITOR mode or vice versa. (If the status of the Forced Status Hold Bit itself is preserved in the PLC Setup (Forced Status Hold Bit Status), the status of force-set and force-reset bits will be retained when the PLC is turned ON or power is interrupted.)	1: Retained 0: Not retained	Same as CS/CJ-series PLC.	



Address		Name	CS/CJ-series PLC		CX-Simulator	
Words	Bits		Function	Settings	Function	Settings
A500	A50014	Error Log Reset Bit	Turn this bit ON to reset the Error Log Pointer (A300) to 00. The contents of the Error Log Area itself (A100 to A199) are not cleared. These words can be cleared from a Programming Device or by writing 0000 to all of the words. (This bit is automatically reset to 0 after the Error Log Pointer is reset.)	0→1: Clear	Same as CS/CJ-series PLC.	Not reset in the Program mode.
	A50015	Output OFF Bit	Turn this bit ON to turn OFF all outputs from Basic I/O Units and Special I/O Units.		Not used.	
A501	A50100 to A50115	CS/CJ-series CPU Bus Unit Restart Bits	Turn these bits ON to restart (initialize) the CS/CJ-series CPU Bus Unit with the corresponding unit number. Bits 00 to 15 correspond to unit numbers 0 to F. When a restart bit is turned ON, the corresponding CS/CJ-series CPU Bus Unit Initializing Flag (A30200 to A30215) will be turned ON. Both the restart bit and initializing flag will be turned OFF automatically when initialization is completed.	0 to 1: Restart 1 to 0: Restart completed Turned OFF by the system when the Unit has been re-started.	Not used.	
A502 to A507	A50200 to A50715	Special I/O Unit Restart Bits	Turn these bits ON to restart (initialize) the Special I/O Unit with the corresponding unit number.	0 to 1: Restart 1 to 0: Restart completed Turned OFF by the system when the Unit has been re-started.	Not used.	
A508	A50809	Differentiate Monitor Completed Flag	ON when the differentiate monitor condition has been established during execution of differentiation monitoring. (This flag will be cleared to 0 when differentiation monitoring starts.)	1: Monitor condition established 0: Not yet established	Same as CS/CJ-series PLC.	
	A50811	Trace Trigger Monitor Flag	ON when a trigger condition is established by the Trace Start Bit (A50814). OFF when the next Data Trace is started by the Sampling Start Bit (A50815).	1: Trigger condition established 0: Not yet established or not tracing	Same as CS/CJ-series PLC.	

Address		Name	CS/CJ-series PLC		CX-Simulator	
Words	Bits		Function	Settings	Function	Settings
A508	A50812	Trace Completed Flag	ON when sampling of a region of trace memory has been completed during execution of a Trace. OFF when the next time the Sampling Start Bit (A50815) is turned from OFF to ON.	1: Trace completed 0: Not tracing or trace in progress	Same as CS/CJ-series PLC.	
	A50813	Trace Busy Flag	ON when the Sampling Start Bit (A50815) is turned from OFF to ON. OFF when the trace is completed.	1: Trace in progress 0: Not tracing (not sampling)	Same as CS/CJ-series PLC.	
	A50814	Trace Start Bit	Turn this bit from OFF to ON to establish the trigger condition. The offset indicated by the delay value (positive or negative) determines which data samples are valid.	1: Trace trigger condition established 0: Not established	Same as CS/CJ-series PLC.	
	A50815	Sampling Start Bit	When a data trace is started by turning this bit from OFF to ON from a Programming Device, the PLC will begin storing data Trace Memory by one of the three following methods: 1) Data is sampled at regular intervals (10 to 2,550 ms). 2) Data is sampled when TRSM(045) is executed in the program. 3) Data is sampled at the end of every cycle.	0 to 1: Starts data trace (sampling)	Same as CS/CJ-series PLC.	
A509	A50900	SYSMAC BUS Slave Number Refresh Bit	Turn this bit ON to refresh the error information in A425 (unit number of Slave where error occurred after startup).		Not used.	
A510 to A511		Start-up Time	These words contain the time at which the power was turned ON. The contents are updated every time that the power is turned ON. The data is stored in BCD. A51000 to A51007: Second (00 to 59) A51008 to A51015: Minute (00 to 59) A51100 to A51107: Hour (00 to 23) A51108 to A51115: Day of month (01 to 31)	See Function column.	Same as CS/CJ-series PLC.	

Address		Name	CS/CJ-series PLC		CX-Simulator	
Words	Bits		Function	Settings	Function	Settings
A512 to A513		Power Interruption Time	These words contain the time at which the power was interrupted. The contents are updated every time that the power is interrupted. The data is stored in BCD. A51200 to A51207: Second (00 to 59) A51208 to A51215: Minute (00 to 59) A51300 to A51307: Hour (00 to 23) A51308 to A51315: Day of month (01 to 31) (These words are not cleared at start-up.)	See Function column.	Same as CS/CJ-series PLC.	
A514		Number of Power Interruptions	Contains the number of times that power has been interrupted since the power was first turned ON. The data is stored in binary. To reset this value, overwrite the current value with 0000. (This word is not cleared at start-up, but it is cleared when the Memory Corruption Detected Flag (A39511) goes ON.)	0000 to FFFF hexadecimal	Same as CS/CJ-series PLC.	
A523		Total Power ON Time	Contains the total time that the PLC has been on in 10-hour units. The data is stored in binary and it is updated every 10 hours. To reset this value, overwrite the current value with 0000.	0000 to FFFF hexadecimal	Not used.	
A526	A52600	RS-232C Port Restart Bit	Turn this bit ON to restart the RS-232C port. (Do not use this bit when the port is operating in peripheral bus mode.) This bit is turned OFF automatically when the restart processing is completed.	0 to 1: Restart	Not used.	
	A52601	Peripheral Port Restart Bit	Turn this bit ON to restart the peripheral port.	0 to 1: Restart	Not used.	
	A52614	SYSMAC BUS Master 1 Restart Bit	Turn this bit ON to restart SYSMAC BUS Remote I/O Master Unit 1. This bit is turned OFF automatically when the restart processing is completed.	0 to 1: Restart	Not used.	
	A52615	SYSMAC BUS Master 0 Restart Bit	Turn this bit ON to restart SYSMAC BUS Remote I/O Master Unit 0. This bit is turned OFF automatically when the restart processing is completed.	0 to 1: Restart	Not used.	

Address		Name	CS/CJ-series PLC		CX-Simulator	
Words	Bits		Function	Settings	Function	Settings
A527	A52700 to A52707	Online Editing Disable Bit Validator	The Online Editing Disable Bit (A52709) is valid only when this byte contains 5A. To disable online editing from a Programming Device, set this byte to 5A and turn ON A52709. (Online editing refers to changing or adding to the program while the PLC is operating in MONITOR mode.)	5A: A52709 enabled Other value: A52709 disabled	Same as CS/CJ-series PLC.	When valid, online editing itself is disabled. (Reflected after a password input for CS/CJ-series PLC.)
	A52709	Online Editing Disable Bit	Turn this bit ON to disable online editing. The setting of this bit is valid only when A52700 to A52707 have been set to 5A.	1: Disabled 0: Not disabled	Same as CS/CJ-series PLC.	
A528	A52800 to A52807	RS-232C Port Error Flags	These flags indicate what kind of error has occurred at the RS-232C port; they are automatically turned OFF when the RS-232C port is restarted. (These flags are not valid in peripheral bus mode and only bit 5 is valid in NT Link mode.) Bits 0 and 1: Not used. Bit 2: ON when there was a parity error. Bit 3: ON when there was a framing error. Bit 4: ON when there was an overrun error. Bit 5: ON when there was a timeout error. Bits 6 and 7: Not used.	See Function column.	Not used.	
	A52808 to A52815	Peripheral Port Error Code	These flags indicate what kind of error has occurred at the peripheral port.		Not used.	
A598	A59800	FPD Teaching Bit	Turn this bit ON to set the monitoring time automatically with the teaching function. While A59800 is ON, FPD(269) measures how long it takes for the diagnostic output to go ON after the execution condition goes ON. If the measured time exceeds the monitoring time, the measured time is multiplied by 1.5 and that value is stored as the new monitoring time. (The teaching function can be used only when a word address has been specified for the monitoring time operand.)	1: Teach monitoring time 0: Teaching function off	Same as CS/CJ-series PLC.	

Address		Name	CS/CJ-series PLC		CX-Simulator	
Words	Bits		Function	Settings	Function	Settings
A600 to A603		Macro Area Input Words	When MCRO(099) is executed, it copies the input data from the specified source words (input parameter words) to A600 through A603 and executes the specified subroutine with that input data.	Input data: 4 words	Same as CS/CJ-series PLC.	
A604 to A607		Macro Area Output Words	After the subroutine specified in MCRO(099) has been executed, the results of the subroutine are transferred from A604 through A607 to the specified destination words. (output parameter words).	Output data: 4 words	Same as CS/CJ-series PLC.	
A608	A60800	Inner Board Restart Bit	Turn the corresponding bit ON to restart (initialize) Inner Board 0 or 1. The bit is turned OFF automatically when the restart processing is completed.	---	Not used.	
A609 to A613	A60900 to A61315	Inner Board User Interface Area	The data transferred from the CPU Unit to the Inner Board is defined and used at the Inner Board. The contents of these words is retained when the power is turned ON.	---	Not used.	
A619	A61901	Peripheral Port Settings Changing Flag	ON while the peripheral port's communications settings are being changed. This flag will be turned ON when STUP(237) is executed and it will be turned OFF after the settings have been changed.	1: Changing 0: Not changing	Not used.	
	A61902	RS-232C Port Settings Changing Flag	ON while the RS-232C port's communications settings are being changed. This flag will be turned ON when STUP(237) is executed and it will be turned OFF after the settings have been changed.	1: Changing 0: Not changing	Not used.	
A620		Communications Unit 0 Settings Changing Flag	The corresponding flag will be ON when the settings for that port are being changed. The flag will be turned ON when STUP(237) is executed and it will be turned OFF by an event issued from the Serial Communications Unit after the settings have been changed.	1: Changing 0: Not changing	Not used.	
	A62001	Port 1	It is also possible for the user to indicate a change in serial port settings by turning these flags ON.			
	A62002	Port 2				
	A62003	Port 3				
	A62004	Port 4				

Address		Name	CS/CJ-series PLC		CX-Simulator	
Words	Bits		Function	Settings	Function	Settings
A620	A62100 to A63515	Communications Units 0 to 15, Ports 1 to 4 Settings Changing Flag	The corresponding flag will be ON when the settings for that port are being changed. The flag will be turned ON when STUP(237) is executed and it will be turned OFF by an event issued from the Serial Communications Unit after the settings have been changed. It is also possible for the user to indicate a change in serial port settings by turning these flags ON.	1: Changing 0: Not changing	Not used.	
A636		Communications Board Settings Changing Flag	The corresponding flag will be ON when the settings for that port are being changed. The flag will be turned ON when STUP(237) is executed and it will be turned OFF by an event issued from the Serial Communications Board after the settings have been changed. It is also possible for the user to indicate a change in serial port settings by turning these flags ON.	1: Changing 0: Not changing	Not used.	
	A63601	Port 1				
	A63602	Port 2				
	A63603	Port 3				
	A63604	Port 4				

## 9-4 Other Functions

### 9-4-1 Differences in CX-Programmer Operation

#### I/O Table

The Ladder Engine, unlike actual PLCs, does not use the I/O tables. Thus the operation related to I/O tables in the CX-Programmer can not be used. If I/O tables are downloaded from the CX-Programmer, the tables will be set to the Ladder Engine. However, the set values are not referenced by the Ladder Engine. So the Units required must be registered in the [Register PLC Unit] window of the Debugger.

### 9-4-2 Other Precautions

#### File Memory

In CS/CJ-series PLCs, the Memory Card and the specified range of the EM area can be used to store files. In the Ladder Engine, however, files are stored in the hard disk of the computer. The directory allocated to the hard disk as the EM file memory is limited by the capacity set in the PLC setup, and the one as the Memory Card is not (actually limited by the hard disk space).

In CS/CJ-series PLCs, the total length of the directory (including subdirectories) is limited to 65 characters. In the Ladder Engine, the length of the whole directory from the directory (the Card of the PLC data directory or the EM directory) allocated to the file system must be up to 65 characters.

#### Registering Alarm Display Applications

Alarm Display is given by the applications log of the event viewer in Windows NT and the system-standard Notepad.exe in Windows95/98. For Windows 95 and 98, an application for Alarm Display can be registered and used. As such an application, a general text editor and a text viewer can be used. (Where a file name must be able to be passed as an argument of the application.)

#### Operation of the Ladder Engine on Startup/Exit

If [Automatic transfer of the program at start-up] (pin 2) of the DIP switch setting is ON, the Auotexec file is read to the I/O memory area every time the Ladder Engine is started or restarted. Also, when the Ladder Engine is exited or restarted, the Power OFF Interrupt Task will not be started regardless of [Power OFF Interrupt Task Disabled/Enabled] of the PC Setup. It will be executed only when clicking the [Reset] button or starting the interrupt task from the [Task Control] window.

## **SECTION 10**

### **Troubleshooting**

10-1 Error Processing .....	229
10-1-1 CX-Programmer .....	229
10-1-2 Debugger and Ladder Engine.....	229
10-1-3 I/O Condition Tool .....	231
10-1-4 Data Replay Tool.....	232
10-1-5 Data Trace Recording Tool .....	233
10-2 Alarms and Remedies .....	234
10-3 Other Tips for Troubleshooting .....	236
10-3-1 Connection Impossible from CX-Programmer.....	236
10-3-2 If Network Communications Can Not Be Performed.....	237
10-3-3 A Compare Error Occurs when Editing Online. ....	237
10-3-4 A Cycle Time Error Occurs.....	238
10-3-5 Others .....	238



## 10-1 Error Processing

### 10-1-1 CX-Programmer

For the details of errors and remedies when operating the CX-Simulator from the CX-Programmer, refer to the *CX-Programmer User manual (W446)*.

### 10-1-2 Debugger and Ladder Engine

If an error occurs while operating the CX-Simulator, the error contents will be displayed in the dialog box. Remove the error causes referring to the remedies.

**Note** For errors relating to the execution of ladder programs, refer to the *CX-Programmer User Manual (W446)* or *CS/CJ Series Programmable Controllers Instructions Reference Manual (W474)*.

Symptoms	Causes	Remedies
A communications error has occurred with CX-Simulator Ladder Engine.	Wrong communications environment.	<ol style="list-style-type: none"> <li>1. [Disconnect] and [Connect] and then try again.</li> <li>2. Exit executing application programs excluding the CX-Simulator and try again.</li> <li>3. Uninstall and then reinstall the CX-Simulator.</li> </ol>
An error occurred while initializing Debugger startup. Start Debugger again.	Wrong execution environment.	<ol style="list-style-type: none"> <li>1. Exit executing application programs excluding the CX-Simulator and try again.</li> <li>2. Uninstall and then reinstall the CX-Simulator.</li> </ol>
Cannot open the communications with current settings. The network No. used in the routing table of FinsGateway is used in the relay node table of CX-Simulator Ladder Engine.	Setting of the routing table is wrong.	Reset the routing table of the Ladder Engine using the CX-Integrator so that it does not overlap with the network No. used by FinsGateway.
Failed to start Block Run of the selected cyclic task.		The Block Run of a task can be executed only when stopping (Program mode).
Failed to create a PLC data folder.	Low hard disk space or no access right.	Check if the folder is read-only or the user is authorized to write.
Failed to gain the access rights of CX-Simulator Ladder Engine.	Another application program is writing to the UM.	After the application program being writing is completed, try again.
Failed to read the PLC data file.	The set file is broken.	Reset the set file in the setting wizard.
Failed to read the routing table for FinsGateway. Check a routing table for it.	Wrong setting of the routing table.	Reset the routing table using the CX-Integrator.
Failed to save PLC data file.	Low hard disk space or no access right.	Check if the hard disk has enough space and the user is authorized to write.
Failed to start CX-Simulator Ladder Engine.	Wrong execution environment.	<ol style="list-style-type: none"> <li>1. Exit executing application programs excluding the CX-Simulator and try again.</li> <li>2. Uninstall and then reinstall the CX-Simulator.</li> </ol>
Failed to start Data Replay Tool.	Wrong execution environment.	<ol style="list-style-type: none"> <li>1. Exit executing application programs excluding the CX-Simulator and try again.</li> <li>2. Uninstall and then reinstall the CX-Simulator.</li> </ol>

Symptoms	Causes	Remedies
Failed to start FinsGateway. FinsGateway may have been installed incorrectly or the settings are invalid.	Wrong execution environment.	Re-install the CX-Programmer and the CX-Server, or FinsGateway.
Failed to start I/O Condition Tool.	Poor resource for executing or wrong execution environment.	<ol style="list-style-type: none"> <li>1. Exit executing application programs excluding the CX-Simulator and try again.</li> <li>2. Uninstall and then reinstall the CX-Simulator.</li> </ol>
Failed to start Log display application.	Wrong execution environment.	<ol style="list-style-type: none"> <li>1. Exit executing application programs excluding the CX-Simulator and try again.</li> <li>2. Uninstall and then reinstall the CX-Simulator.</li> </ol>
Failed to start the Alarms display application.	Wrong environment for the Alarms display application.	The event viewer is not working for Windows NT and the memo pad for Windows95/98. Change the OS settings so as to work.
Failed to start Virtual Communications Unit.	Wrong execution environment.	Uninstall and then reinstall the CX-Simulator.
Failed to switch the current UM. Failed to gain the access rights of CX-Simulator Ladder Engine.	Another application program is writing to the UM.	After the application program being writing is completed, try again.
The node address of FinsGateway -- unit is duplicated. Change the node address of FinsGateway communications unit to start.		<ol style="list-style-type: none"> <li>1. Change the FINS node address of the communications path in the [Work CX-Simulator] window.</li> <li>2. Change the duplicated node address using network communications setting.</li> </ol>
The program is running. Cannot set a start point.	Tried to set a start point while running the program.	A start point can be set only when stopping (Program mode).
Unable to allocate the network number since the number of registered network in the FinsGateway routing table is maximum. Delete the unused network then reconnect.		Reset the routing table using the CX-Integrator.
Unexecuted Cyclic task cannot be changed to WAIT mode.	Tried to change a Cyclic task in INI to WAIT mode.	Try again after executing the program.
Unit profile does not exist or the file format is invalid.	Wrong execution environment.	Uninstall and then reinstall the CX-Simulator.

### 10-1-3 I/O Condition Tool

If an error occurs while operating the I/O Condition Tool, the error contents will be displayed in the dialog box. Remove the error causes referring to the remedies.

Symptoms	Causes	Remedies
Communication error (received an error response).	Wrong address specification or range of I/O memory for I/O conditions or wrong communications environment.	<ol style="list-style-type: none"> <li>1. Check the I/O conditions settings.</li> <li>2. Exit executing application programs excluding the CX-Simulator and try again.</li> </ol>
Communications error (communications timeout).	A timeout occurred in a response from the Ladder Engine.	<ol style="list-style-type: none"> <li>1. If the cycle time of the Ladder Engine is too long, use synchronous processing in the virtual cycle time.</li> <li>2. Check if the target FINS address is the same as that of the Ladder Engine.</li> </ol>
Failed to get the current IOM.	Wrong address specification or range of I/O memory for I/O conditions.	Check the I/O conditions settings.
File format is invalid.	The specified execution file has an invalid format.	Specify the I/O condition file, which has a different file format from a Data Replay file.
I/O Condition file exceeds the limit of maximum lines.		Change the registered conditions or create another execution file.
I/O Condition file exceeds the limit of maximum lines. The maximum limit is -- lines		Change the registered conditions or create another execution file.
I/O Condition to watch does not exist.		Check the I/O conditions settings and if "D2" is set in the execution column.
The data in the clipboard is not the I/O condition format. Invalid lines have been deleted.		Copy the I/O condition expression of correct format to the clipboard and try again.
The lines with invalid I/O condition format have been deleted.	Wrong format for I/O conditions.	Check the I/O conditions settings.

### 10-1-4 Data Replay Tool

If an error occurs while operating the Data Replay Tool, the error contents will be displayed in the dialog box. Remove the error causes referring to the remedies.

Symptoms	Causes	Remedies
A communications timeout occurred. Operation exit.	A timeout occurred in a response from the Ladder Engine.	<ol style="list-style-type: none"> <li>1. If the cycle time of the Ladder Engine is too long, use synchronous processing in the virtual cycle time.</li> <li>2. Check if the target FINS address is the same as that of the Ladder Engine.</li> </ol>
An error response is received from the target PLC. Operation exit.	Wrong address/range of Replay data or Output data.	Check if wrong data are included in the Replay/Output file.
Command log data is invalid. Operation exit.	The file has a wrong format.	Specify a Command log file of a correct format.
Failed to connect to the PLC. Operation exit.	Not possible to communicate with the target PLC.	Check the FINS address for the target PLC.
Failed to open the Command log file. Operation exit.	The file does not exist or has a wrong format.	Specify a Command log file of a correct format.
Failed to open the CSV text file. Operation exit.	The file does not exist or has a wrong format.	Specify a Data Replay file (CSV text file) of a correct format, which is different from an execution file of the I/O Condition Tool.
Failed to read the Command log data. Operation exit.	The file has a wrong format.	Specify a Command log file of a correct format.
Failed to read the CSV text data. Operation exit.	A wrong format.	Specify a Data Replay file (CSV text file) of a correct format, which is different from an execution file of the I/O Condition Tool.
Failed to start/stop the timer of Windows. Operation exit.	Windows system call error.	<ol style="list-style-type: none"> <li>1. Exit the applications excluding the CX-Simulator.</li> <li>2. Restart the debugger.</li> </ol>
Failed to write the CSV text data. Operation exit.		Check the following causes: <ol style="list-style-type: none"> <li>1. Low disk space</li> <li>2. Read -only file</li> <li>3. Read-only folder</li> <li>4. User unauthorized to write.</li> </ol>
Ladder stopped because of FAL error on the target PLC. Operation exit.		Remove the causes and try again.
Synchronous operation was specified for the actual PLC. Operation exit.	Tried to execute synchronous operation for other than the Ladder Engine.	Specify synchronous operation only for the Ladder Engine.
The data in CSV text file is invalid. Operation exit.	A wrong format.	Specify a Data Replay file (CSV text file) of a correct format, which is different from an execution file of the I/O Condition Tool.
The number of I/O address settings exceeded the limit. Operation exit.	Exceeding the limit of address setting in the CSV text file.	The number of I/O address settings in the CSV text file must be less than 168.
The specified I/O address is not supported. Operation exit.	A wrong file format.	Check if I/O address data of a wrong format are included in the Replay/Output file.

Symptoms	Causes	Remedies
The specified output file could not be generated from the template file. Operation exit.	The file does not exist or has a wrong format.	Specify a Data Replay file or a template file of a correct format.
The specified output file does not exist or its data is invalid. Operation exit	The file does not exist or has a wrong format.	Specify a Data Replay file (CSV text file) of a correct format, which is different from an execution file of the I/O Condition Tool.
The target PLC was switched from CX-Simulator to an actual PLC. Operation exit.	The target PLC was changed while data replaying.	The target PLC can not be changed while replaying data.

### 10-1-5 Data Trace Recording Tool

If an error occurs while operating the Data Trace Recording Tool, the error contents will be displayed in the dialog box. Remove the error causes referring to the remedies.

Symptoms	Causes	Remedies
--: Address(**) of bit area is out of range.		Correct the address referring to Appendix: Dialog box for editing the address to be sampled.
--: Address(**) of word area is out of range.		Correct the address referring to Appendix: Dialog box for editing the address to be sampled.
Cannot connect to PLC. PLC communications error --.	The target PLC does not exist.	Check the FINS address for the target PLC.
Data Trace was started in manual mode, failed to start in auto mode.	Not possible of automatic saving by the command line.	Create the setting file again and start by the command line.
Failed to execute Data Trace. Because the parameters of the file to be added are different from setting parameters.		<ol style="list-style-type: none"> <li>1. Specify the same values as the saved parameters.</li> <li>2. Remove the check mark of "Add saving" and try again.</li> </ol>
Failed to stop Data Trace.	Communications disabled during Data Trace.	Restore to able-to-communicate state and try again.
Failed to open the destination file for adding the Trace data.	The file format is wrong when specifying "Add saving."	Specify another file name when Add saving and try again. Remove the check mark of "Add saving."
Failed to save the sampling data to --.	Wrong path name, The file being used, Read-only file, or Low disk space	<ol style="list-style-type: none"> <li>1. Check if the path name is correct.</li> <li>2. Check if another application is using the file.</li> <li>3. Check if read-only or the user is authorized to write.</li> <li>4. Check if disk space is enough.</li> </ol>
Failed to start Timer.	32 Windows timers are exhausted in the whole system.	Exit some applications and try again.
Sampling area is not specified.		Register at least one address to either of word/bit address.
Specified PLC type -- is not supported. Data Trace will not start.	The target PLC specifies other than CS/CJ/CP Series.	Specify CS/CJ/CP Series as a target PLC.
The data of the setting file -- is invalid.	The contents of the setting file are wrong.	Create the setting file by [Parameters Save] again.

## 10-2 Alarms and Remedies

The following table shows possible alarms and their remedies when executing the CX-Simulator. Remove the alarm causes referring to the remedies.

Alarms	Causes	Remedies
A fatal error occurred on CX-Simulator Ladder Engine. Restart Debugger. catch runtime error What: --	Windows system call error.	Exit some application programs and try again.
An attempt was made to operate a FINS that was not for CPU Unit.	Wrong destination address of the FINS command.	Set "0" to the FINS unit address for the destination of the application that sent the FINS command.
Command log finished because the size of log file exceeds maximum.		Create a new command log file.
CX-Simulator Communications Unit: Sending buffer overflow. FINS messages were lost.	Heavy-traffic FINS communications.	Lower the frequency of FINS command send from the Ladder Engine or the application program.
CX-Simulator Ladder Engine terminated by an error. Restart Debugger.		1. Exit the CX-Simulator. 2. Delete all erroneous Memory?.dat files in the PLC data folder.
Cycle time over. CX-Simulator Ladder Engine stop.		Correct the ladder program or change the setting of the WDT.
Failed to auto boot the data file. Autoexec.iom is invalid.	Failed to read Autoexec.iom.	Check for Autoexec.iom in the Card folder (CF folder).
Failed to create a command log file.	The specified file is read-only or the disk space is short.	Increase the disk space or change the destination for creating the log file.
Failed to create a folder for the card files.	The PLC data folder is read-only, etc.	Delete the PLC data folder and all files/folders in it and create a new PLC again.
Failed to create a folder for the EM files.	The PLC data folder is read-only, etc.	Delete the PLC data folder and all files/folders in it and create a new PLC again.
Failed to create a header of FINS response (FinsHead_composeResponse). Check the data of received header.	Wrong destination address of the FINS command.	Check the destination of the FINS command sent by the Ladder Engine or application program or settings of the routing table.
Failed to create a header of FINS response. Check the data of received header.	Wrong destination address of the FINS command.	Check the destination of the FINS command sent by the Ladder Engine or application program or settings of the routing table.
Failed to create the memory preservation file.	Failed to create the file in the PLC data folder.	1. Check for enough disk space (10 MB) in the PLC data folder. 2. Check if the PLC data folder is write-enabled or the user is authorized to write.
Failed to send a FINS command (Fins_sendData). Check the target FINS address.	Heavy-traffic FINS communications or wrong destination of the FINS command.	1. Lower the frequency of FINS command send from the Ladder Engine or application program. 2. Check the destination of the FINS command sent by the Ladder Engine or the application program or settings of the routing table.
Failed to send a FINS command. Check the target FINS address.	Wrong destination of the FINS command or Heavy-traffic FINS communications.	1. Check the destination of the FINS command sent by the Ladder Engine or the application program or settings of the routing table. 2. Lower the frequency of FINS command send from the Ladder Engine or the application program.

Alarms	Causes	Remedies
Failed to start the interrupt task (Task No. -- )	Too high frequency of starting interrupt tasks.	Lower the frequency of starting interrupt tasks.
Failed to write command log to the file.	Short disk space, etc	Increase the disk space or change the destination for creating the log file.
FINS operation was canceled.	Wrong routing information.	1. [Disconnect] and [Connect] and then try again. 2. Exit the CX-Simulator and restart.
Network communications was not executed because of setting error of it.	Wrong routing information.	1. [Disconnect] and [Connect] and then try again. 2. Exit the CX-Simulator and restart.
Routing table error: Failed to transfer because the number of local tables exceeds maximum (16).	Wrong routing information.	1. [Disconnect] and [Connect] and then try again. 2. Exit the CX-Simulator and restart.
Routing table error: Failed to transfer because the number of relay tables exceeds maximum (20).	Wrong routing information.	1. [Disconnect] and [Connect] and then try again. 2. Exit the CX-Simulator and restart.
Routing table error: The network address in the local table records must be 0x00 or over 0x80.	Wrong routing information.	1. [Disconnect] and [Connect] and then try again. 2. Exit the CX-Simulator and restart.
Routing table error: The unit address in the local table records must be under 0x10 or over 0x20.	Wrong routing information.	1. [Disconnect] and [Connect] and then try again. 2. Exit the CX-Simulator and restart.
Routing table error: The unit address in the local table records must be unique.	Wrong routing information.	1. [Disconnect] and [Connect] and then try again. 2. Exit the CX-Simulator and restart.
Serial communications were not executed because the target node was at another network.	Wrong destination FINS address of the communications instruction.	A communications instruction can not be issued to a node of other than the local network.
The size of memory preservation file is invalid.		The values on the memory (e.g. UM) of the Ladder Engine are indefinite. Initialize the I/O memory area of the Ladder Engine following the next procedure. 1. Exit the CX-Simulator.
The Value of checksum for the memory preservation file is incorrect.		2. Delete all Memory?.dat files in the PLC data folder where an error occurred. 3. Restart the CX-Simulator and specify the relevant folder to start the Ladder Engine.

## 10-3 Other Tips for Troubleshooting

### 10-3-1 Connection Impossible from CX-Programmer

**The CX-Simulator is disconnected.**

Connect to the CX-Simulator.

**Connection to the CX-Simulator does not end normally.**

Duplicate FINS address?

Check the FINS addresses for each unit in the [Network Communications Settings] and that for the communications unit of FinsGateway displayed in the [Work CX-Simulator] window to dissolve the duplication.

**The network LED for the system status does not change in color although the connection to the CX-Simulator ended normally.**

In the following cases, communications may be disabled.

- The other communications unit of FinsGateway was started after connecting the CX-Simulator.
- Read a Parameter Area File (.std) to the Ladder Engine.
- Changed the routing table by the CX-Integrator.

In the above cases, once disconnect the CX-Simulator and then connect again.

**PLC connection is impossible although the network LED for the system status changes in color.**

Check the settings of the application (e.g. the CX-Programmer) connected to the target FINS address displayed in [Guide to Connect] of [Work to CX-Simulator] is correct. For the CX-Programmer, check the communications unit for FinsGateway.

When the communications unit for FinsGateway is connected, once disconnect and then connect again.

In the following cases, communications may be disabled.

- Started the other communications unit of FinsGateway after connecting the CX-Simulator.
- Read a Parameter Area File (.std) to the Ladder Engine.
- Changed the routing table by the CX-Integrator.



**A timeout occurs in communications.**

Clicking the [Settings] button of [Change PLC] | [Network Type] will display the [Network Settings].

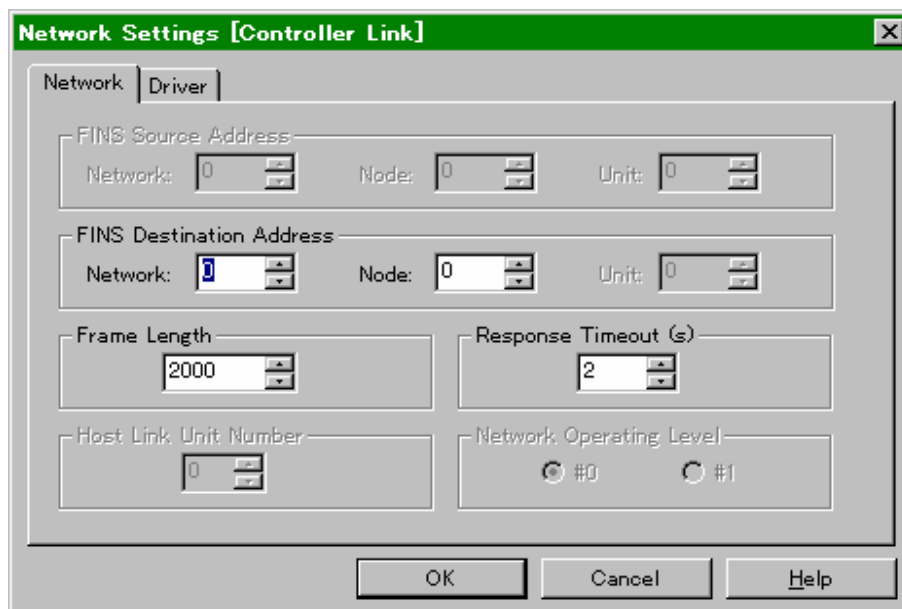

Change the [Response Timeout] so that it is greater than the average computer cycle time.

**10-3-2 If Network Communications Can Not Be Performed****Normal connection from the CX-Programmer is not possible.**

If normal connection from the CX-Programmer is not possible, refer to *When normal connection from the CX-Programmer is not possible*.

**Communications from an external network is not possible.**

Check again if the FINS address for the Ladder Engine is set correctly.

Setting a routing table is required when communicating from an external network to the Ladder Engine.

**10-3-3 A Compare Error Occurs when Editing Online.**

Check the UM's access destination in the [System Status] window.

A compare error will occur if an attempt is made to edit online the UM that is different from the one downloaded from the CX-Programmer.

For example, trying to edit online the program downloaded to the UM1 will cause a compare error if the access destination is UM2.

**Online editing takes a long time to complete.**

Online editing a program with long-time computer cycle time during [Continuous Run] may take a long time to complete. To avoid this situation, click the [Pause] button before online editing to edit in pausing.

### 10-3-4 A Cycle Time Error Occurs

**Even a short program sometimes causes a cycle time error.**

A cycle time error can occur if a program is started running in the computer cycle time mode by the CX-Simulator on the computer with a low memory capacity or with a lot of application programs activated. This is because it takes a long time to acquire memory areas. To avoid this situation, try one of the following three measures: (1) Execute in the virtual cycle time, (2) Execute the program removing the check mark of [Return to the top of the program when online editing in Step Run] of [Status] | [Settings] | [PLC Operation Settings], or (3) Check [Disable Cycle Time Monitoring].

**Change the cycle time monitoring time in PLC Setup.**

Remove the check mark of [Cycle Time Monitoring Time] (default: 1,000 ms) of the [PLC] | [PLC Setup] | [Timer/Interrupt] tab to adjust the cycle time monitoring time.

### 10-3-5 Others

**A gap occurs between the time of the Ladder Engine and that of the computer in spite of executing in the computer cycle time.**

When in Step Run and Scan Run, etc., a gap can occur between the time of the Ladder Engine and that of the computer even when executing in the computer cycle time.

To avoid this situation, use the Ladder Engine in Continuous Run and in the computer time only.

**Some files and folders are not displayed in the PLC file memory.**

The CARD folders in the PLC data folder corresponds to a memory card of each PLC. Usually the CX-Programmer's memory card component can display the contents of the CARD folder. However, it can not display files and folders with a different naming convention from that of CS/CJ Series. For CS/CJ Series naming convention, refer to *CS/CJ Series Operation Manual*.

# Appendix

## How to Use Data Trace Recording Tool

### Outline of Data Trace Recording Tool

The Data Trace Recording Tool is a tool for automatically creating multiple Data Trace files, by setting only once, instead of saving values of I/O memory areas of an actual PLC to a Data Trace file (.cdt) through manual operation using the time chart monitoring or the data tracing of the CX-Programmer.

The Data Trace Recording Tool will run only on the CX-Simulator.

The Data Trace Recording Tool has the following advantages as compared to saving by the CX-Programmer.

- Automatically save data of the data trace.
- Save long-term data to multiple files.

- Note**
1. The Data Trace Recording Tool does not support the Virtual Cycle Time mode for the Ladder Engine. When using the tool for the Ladder Engine, perform Continuous Run in the Computer Cycle Time mode.
  2. For the details of the data tracing, refer to *Trace Memory Sampling: TRSM(045) of CS/CJ Series Programming Manual*.
  3. The Data Trace Recording Tool is not available for the CJ2 CPU Units. When using a CJ2 CPU Unit, you can save long operation data with the Continuous Trace function of the CX-Programmer.

### Restrictions on Data Trace Saving

There are following restrictions because the Data Trace Recording Tool uses the data tracing function of a PLC.

#### **Number of Points to be Registered (Simultaneous Sampling Number)**

- Bits 0 to 31
- Words 0 to 6

#### **Sampling Number**

Trace memory (A maximum number of buffers able to collect once): 2000 samples

327,767 samples per one file (Data Trace file: .cdt)

#### **Restrictions by the Trace Memory**

The data to be saved by the data tracing is temporarily stored in the trace memory of the PLC (Up to 2,000 samples are stored in the trace memory.). Trace data can not be picked up between this-time data read from the trace memory and next-time set of the data trace.

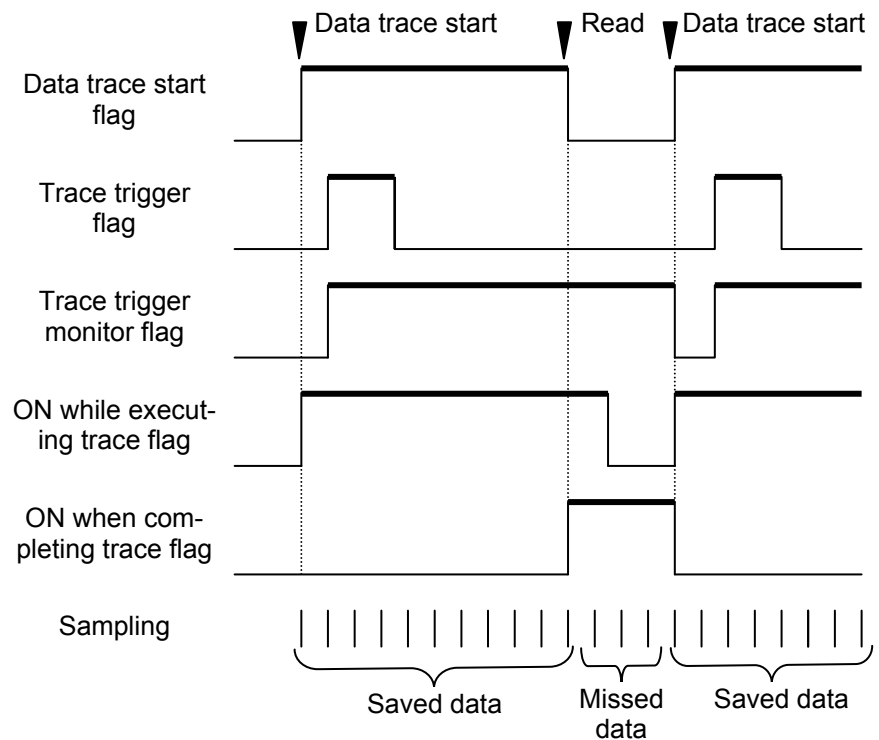

### **Restrictions on Networks to be used**

The Data Trace Recording Tool works as an application of FinsGateway, saving the following data of the SYSMAC CS/CJ/CP-series PLC connected to the computer via FinsGateway.

1. A PLC connected via Controller Link
2. A PLC connected via Ethernet
3. A PLC connected via Host Link
4. The Ladder Engine (works as synchronous process.).

**Note** The Data Trace Recording Tool, assuming that FinsGateway is used, the RUNTIME version of FinsGateway is required separately when using with Ethernet or Host Link.

## Explanation for Each Part of the Window

### Names and Functions

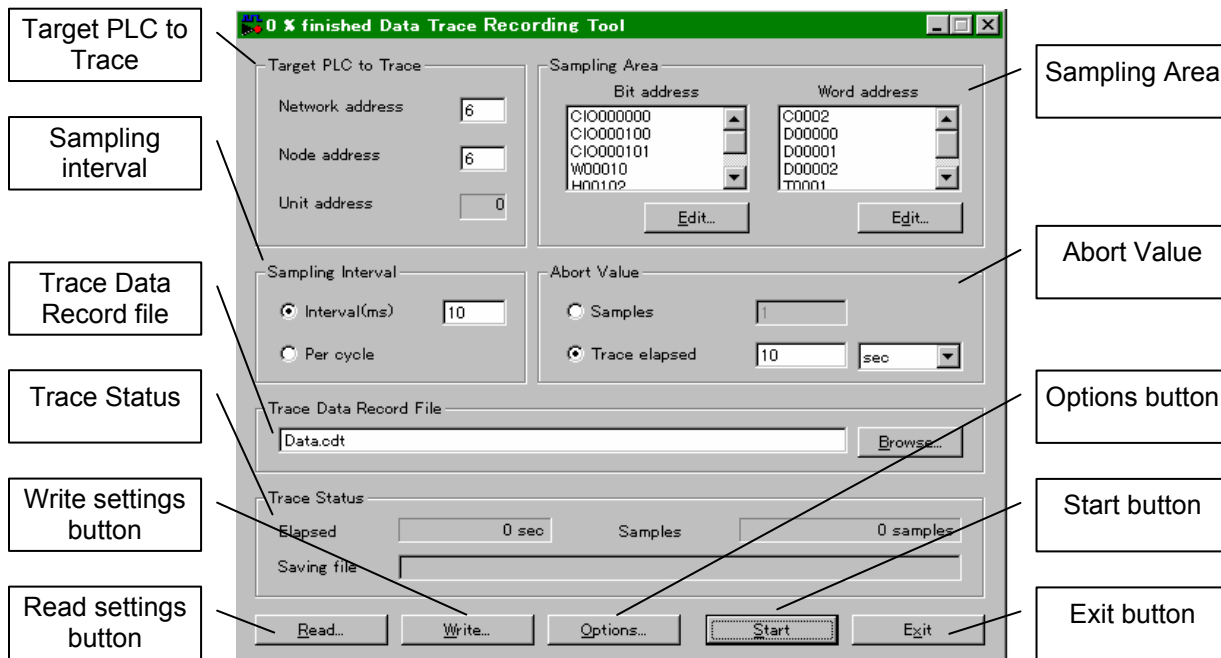

Item	Description	Limit of values
Target PLC to Trace	Specify the FINS address for the PLC where data tracing will be performed. Only network/node address can be input.	Network: 0 to 127 Node: 1 to 126 Unit: 0(fixed)
Sampling Area	Register addresses where bits and words are sampled. [Edit]: Edit bit/word addresses in the Sampling Address Setting window. Set at least one to either of bits or words within the range on the right.	Number of bits: 0 to 31 Number of words: 0 to 6
Sampling interval	Set the sampling conditions with the radio button.	
Interval	Set the sampling interval as "fixed" and enter the interval in the text box (unit: ms).	10 to 2550
Per cycle	Trace per cycle of the ladder program.	
Abort Value	Specify the value for exiting the data tracing.	
Type	Specify either of after getting specified number of samples or after specified time elapsed.	
Samples	Specify the value for exiting the data tracing.	1 to 65535
Trace elapsed	Specify the time for tracing.	1 to 65535
Unit	Specify the unit for the time above: either of second, minute, or hour.	
Trace Data Record File	Specify the file name for saving the sampling data: either in a relative path or in an absolute path.	A network name can not be specified.
Browse	Display the File Name Setting dialog.	
Options settings	Set options regarding trace data saving.	

Item	Description	Limit of values
Trace status	Display the Trace Status while tracing data.	
Elapsed	The time elapsed after execution started in the unit of hour/minute/second (e.g. 1 hour 10 minutes 30 seconds).	
Trace number of samples	Number of traced samples.	
Saving file	Current file name when Multiple Saving is set.	
Read settings button	Read settings from the existing ini file to display it in the window.	
Save settings button	Save the settings to the ini file.	
Option button	Set options regarding the trace data recording.	
Start button Stop button	Change the caption between [Start] when not tracing and [Stop] when tracing. Press the [Start] button to start tracing and the [Stop] to stop.	
Exit button	Exit the Data Trace Recording Tool. Exit the tool after the PLC completes tracing if the PLC is executing tracing.	

**Option Settings**

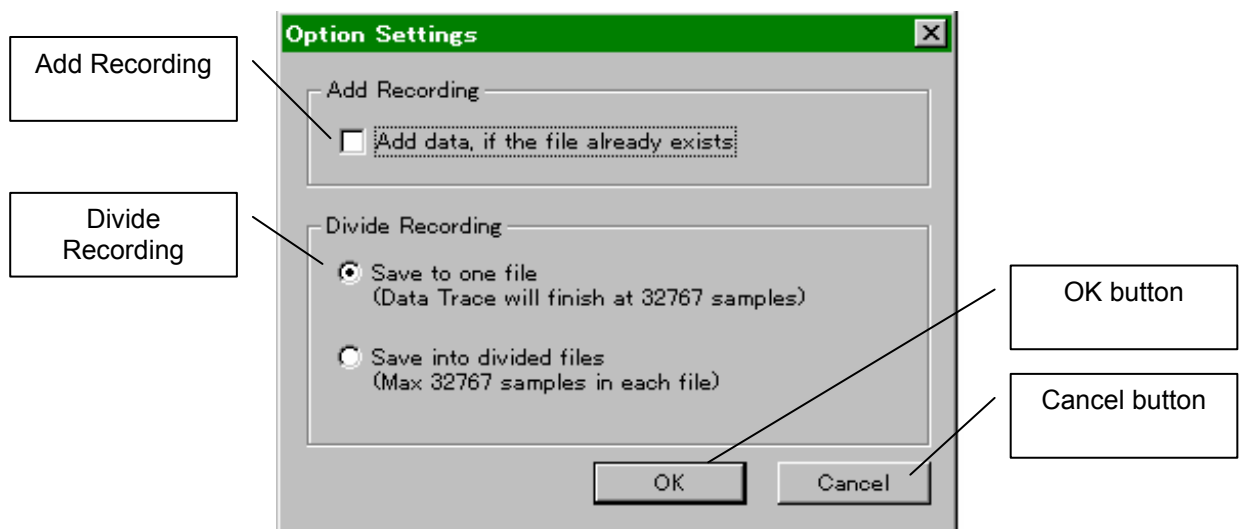

Add Recording	If the file specified by the Trace Data Record File exists, the data will be appended to the file.
Divide Recording	Specify whether the sampling data is to be saved to one file or multiple files.
Divide Recording not used	Save the sampling data to one file, where the tracing ends automatically when acquired 32,767 samples.
Divide Recording	Divide and save the sampling data to multiple files. Change automatically to the next file when acquired 32,767 samples. Serial numbers will be attached to the end (excluding an extension) of the specified file name.
OK button	Register the option settings to close the dialog box.
Cancel button	Close the dialog box without registering option settings.

The dialog box for editing the sampling address

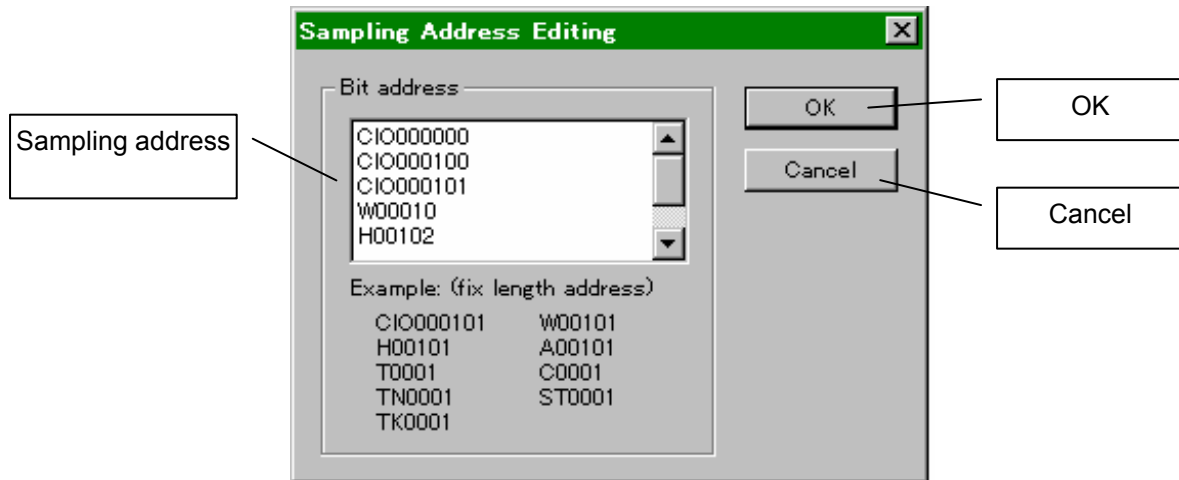

Sampling address	Enter the sampling address to be registered.
OK button	Register the sampling address to close the dialog box.
Cancel button	Close the dialog box without registering the sampling address.

**Area and Address Range Possible to Specify**

**Bit address**

Area	Area symbols	Word range (number of digit)	Bit range (number of digit)
CIO Area	CIO	0 to 6143 (4)	0 to 15 (2)
Work Area	W	0 to 511 (3)	0 to 15 (2)
Holding Area	H	0 to 511 (3)	0 to 15 (2)
Auxiliary Area	A	0 to 959 (3)	0 to 15 (2)
Timer Area	T	0 to 4095 (4)	None (0)
Counter Area	C	0 to 4095 (4)	None (0)

**Word address**

Area	Area symbols	Word range (number of digit)	Bit range (number of digit)
CIO Area	CIO	0 to 6143 (4)	0 to 15 (2)
Work Area	W	0 to 511 (3)	0 to 15 (2)
Holding Area	H	0 to 511 (3)	0 to 15 (2)
Auxiliary Area	A	0 to 959 (3)	0 to 15 (2)
Timer Area	T	0 to 4095 (4)	None (0)
Counter Area	C	0 to 4095 (4)	None (0)
DM Area	D	0 to 32767 (5)	None
Current EM Bank	E	0 to 32767 (5)	None
EM bank designation	E	0 to 32767 (5) Bank 0 to 12	None

**Input format**

Area string = Area symbol + Word range + Bit range

- Area symbol      Area symbols in the above table (Uppercase characters)
- Word range      Specify "word." (Decimal)  
Specify for the number in the table.  
(Example: 000016 for address 16 and number of digit 6)
- Bit range        Specify "bit." (Decimal)  
Specify for the number in the table.  
(Example: 08 for address 8 and number of digit 2)

Input example: CIO000101 (CIO 1word, 1 bit)

**Note** How to specify for an EM bank  
Specify with "-"(hyphen) × Number of banks (Decimal) after the EM address.  
(Example: E32767-12 for address 32767 and bank 12)

**Operation of Data Trace Recording Tool**

**Note** Before using the Data Trace Recording Tool, make sure that the FinsGateway Service Manager is started and the communications unit of the network where CPU\_UNIT and the target PLC are connected is servicing.

**Starting Procedure**

- 1,2,3... 1. Select the Data Trace Recording Tool from [Start] | [Program] | [Omron] | [CX-Simulator] to display the execution window of the Data Trace Recording Tool.

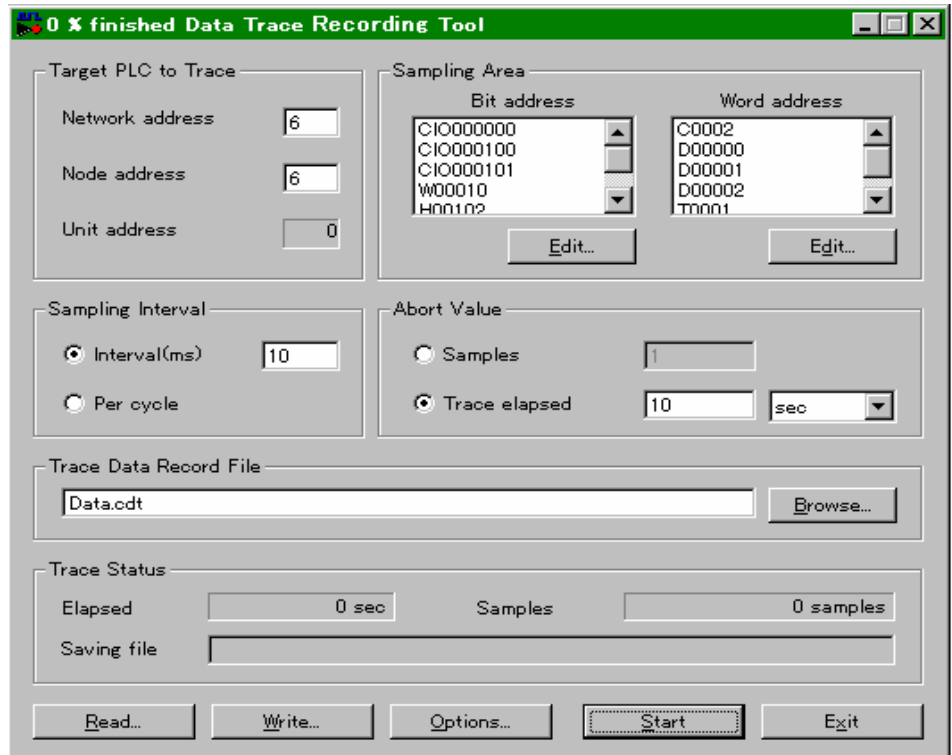



2. Confirm the FINS address (network/node address) for the target PLC is correctly set.
3. Set the sampling area. Click the [Edit] button to add/correct the sampling address. Click the [Edit] button on the Bit Address side for the bit address and on the Word Address side for the word address. The [Sampling Address Editing] window will be displayed.

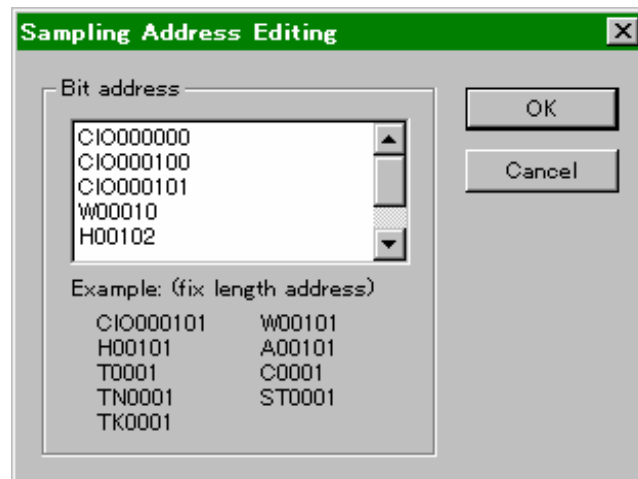

4. Click the list of [Bit address] and key-in the address of the I/O memory area to be saved.
5. Click the [OK] button when the inputting is completed to return to the execution window.
6. Set the sampling interval.
7. Set the abort value.
8. Set a file (.cdt) for saving the trace data. Pressing the [Browse] allows specifying from the [File Selection] dialog.
9. Pressing the [Option] button will display the [Option Settings] window.

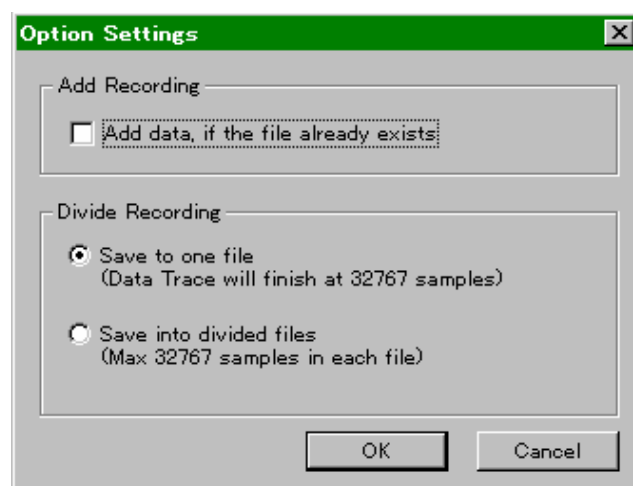

10. Set options. The following settings are available.
  - Add saving      Add data to the existing file.
  - Multiple Saving    Divide and save the data to multiple files when the number of sampling data exceeds the limit of the Data Trace file (.cdt).
11. Click the [OK] button when setting options completes to return to the execution window.
12. When tracing with the same settings, click the [Add Recording] button to save the settings to the file (.ini).
13. Click the [Start] button when setting completes to register the setting contents to the target PLC and to start tracing.
14. While tracing, the elapsed time after the execution started, the number of tracing samples, and the name of actually saved files (including serial numbers for multiple saving) will be displayed.
15. Holding of the abort value will automatically stop tracing. Click the [Stop] button to forcibly stop tracing during execution.

## Starting from the Command Line

The [Data Trace Recording Tool] can be started from the command line of the MS-DOS command prompt, etc. with the setting file (.ini) specified that has been saved by the [Add Recording] button, as well as from [Start] | [Execute by Specifying File Name]. If a setting file is specified when starting, the [Data Trace Recording Tool] will automatically start the data trace.

Follow the next procedure to start from the command line.

*Data Record* [< Name of setting file >]

Data Record	Execution command
< Name of setting file >	<Options> Specify a setting file for saving the traced data automatically. If a setting file is specified, tracing will be started according to the settings. If not or a non-existing file is specified, the data trace will not start.

## Using in Host Link

When tracing in Host Link via a Serial Communications Unit of FinsGateway, set for the Serial Communications Unit.

- Note**
1. The Data Trace Recording Tool, assuming that FinsGateway is used, the RUNTIME version of the FinsGateway Serial Communications Unit is required separately when using in Host Link.
  2. For the details of FinsGateway and FinsGateway Serial Communications Unit, refer to the manual attached to the RUNTIME version of the FinsGateway.

### Setting the Serial Communications Unit

- 1,2,3...**
1. Select the FinsGateway Service Manager in [Start] | [Program] | [Omron] | [FinsGateway]. If it is being activated, right-click the FinsGateway Service Manager in the icon tray and select the setting from the pop-up menu. The FinsGateway Service Manager will be displayed.

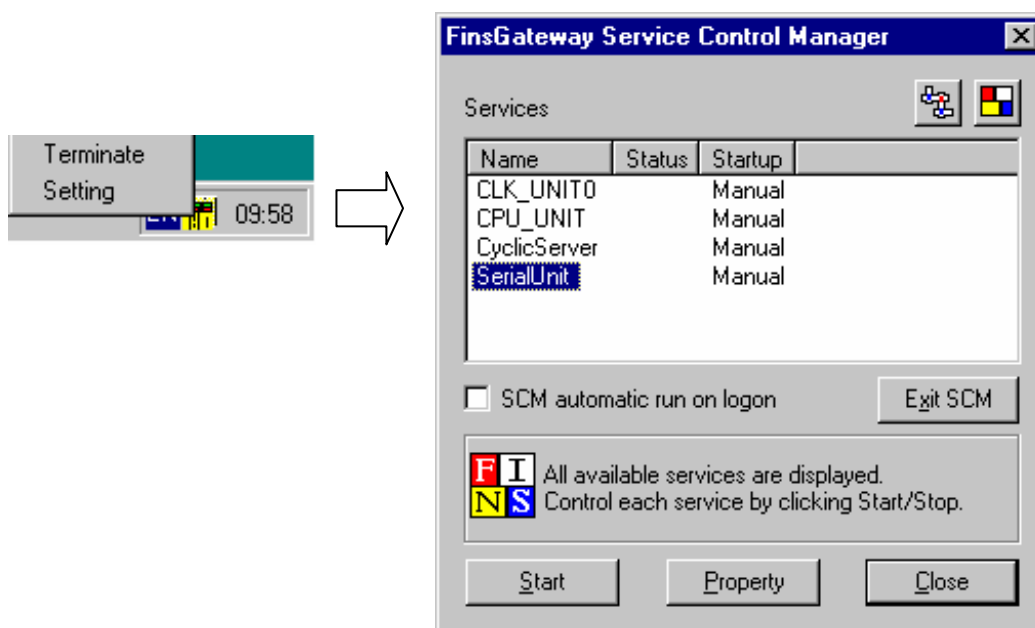

2. Select "SerialUnit" in the list of the FinsGateway Service Managers and click the [Start] button. The display will change from "List" to "Start" when "SerialUnit" starts. If the CPU Unit for FinsGateway is not started then, the CPU Unit will automatically start.

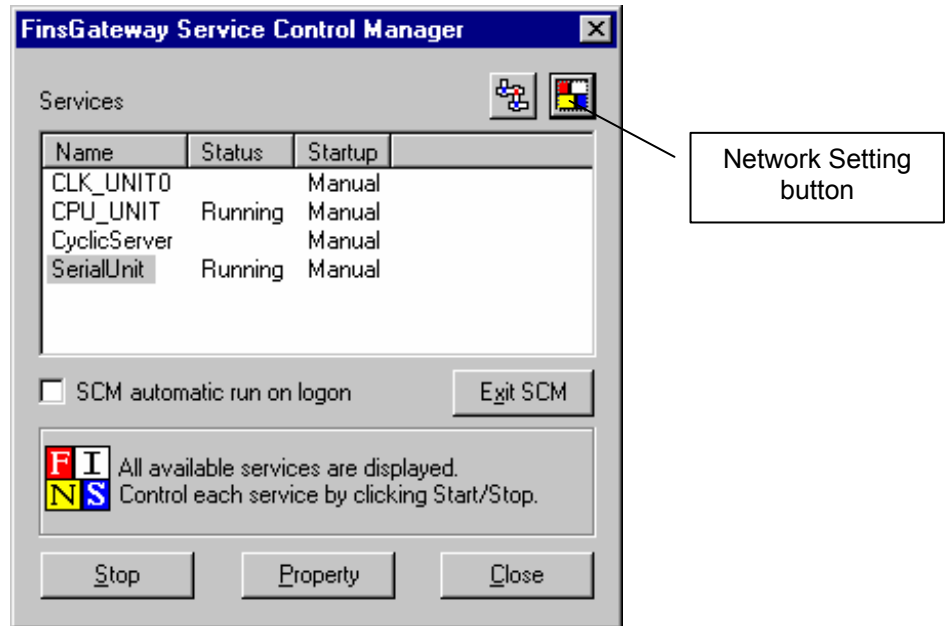

3. Click the [Network Setting] button to display the [FinsGateway Network Navigator] window.

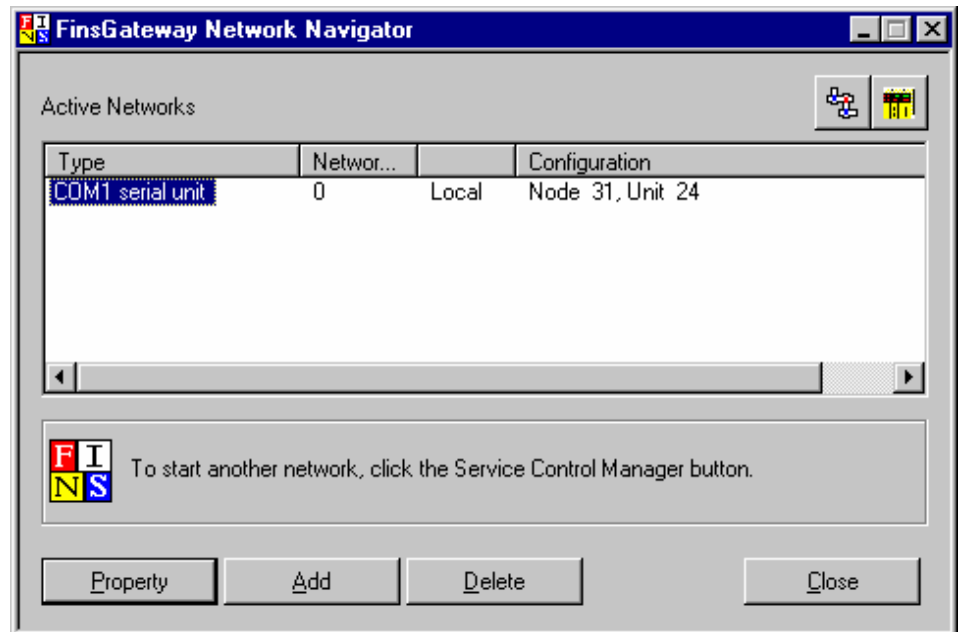

4. Select the "SerialUnit" network in the list of available networks and click the [Property] button to display the "SerialUnit" property.

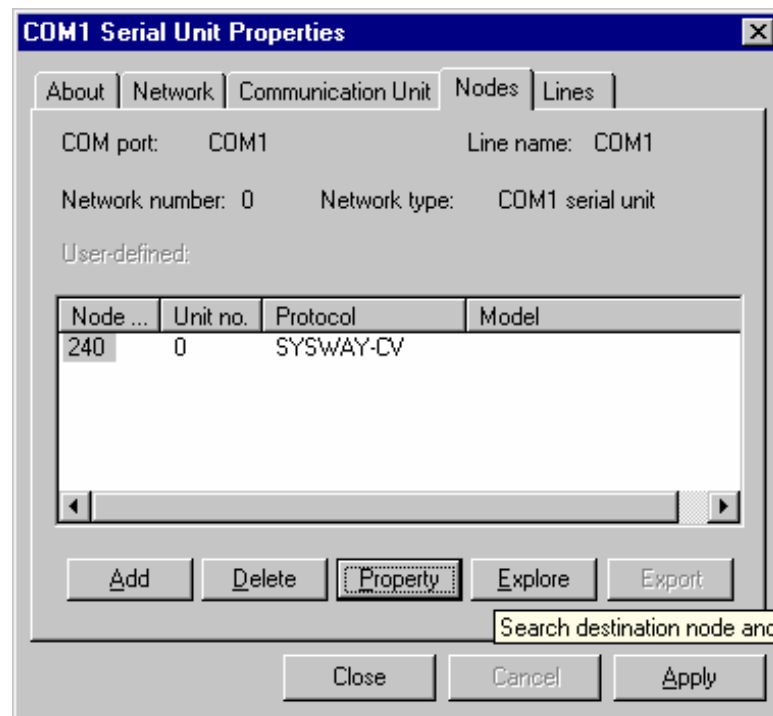

5. Select the node tab and click the property button to display the [Add/ Edit Serial Node] dialog box.

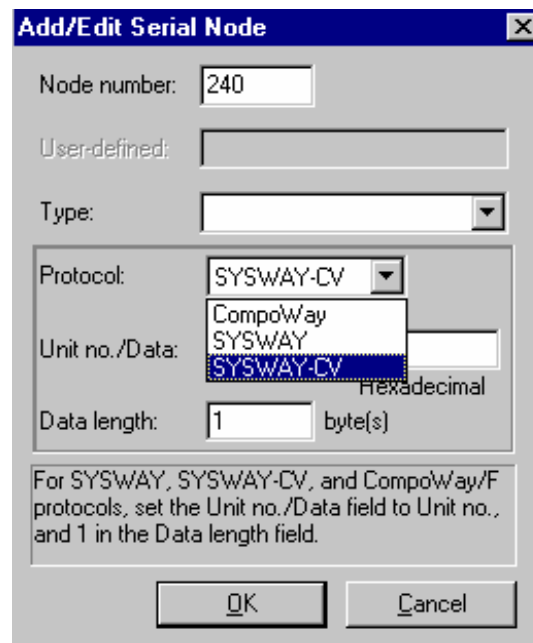

6. Select "SYSMAC WAY-CV" in the protocol of the [Add/Edit Serial Node] dialog box and click the [OK] button to return to the "SerialUnit" property.

**Note** If "CS/CJ/CP Series" is not found in the model names, select "Others."

7. Click the [Close] button to display the following message box. Selecting "Yes" to return to the [Network setting] window.

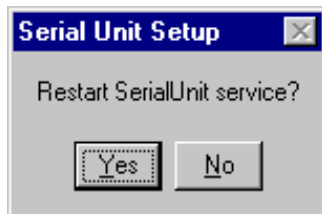

8. Click the [Exit] button to return to the FinsGateway Service Manager.

## Revision History

A manual revision code appears as a suffix to the catalog number on the front cover of the manual.

**Cat. No. W366-E1-16**

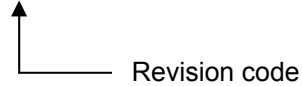

The following table outlines the changes made to the manual during each revision. Page numbers refer to the previous version.

Revision code	Date	Revised content
1	January 2000	Original production
2	October 2000	Contents revised to reflect the upgrade from version 1.0 to 1.1, as follows: WindowsMe/2000 supported, Serial Communications function (Actual serial communications and NT Link) added, Numerous-point Data Collection Tool added, License number entry on installing added Correction made throughout the manual.
03	May 2002	Contents revised to reflect the upgrade from version 1.1 to 1.2 and from version 1.2 to 1.3.
04	December 2003	Contents revised to reflect the upgrade from version 1.3 to 1.4, including the following changes. <b>Page vii:</b> Added information on upgrade from version 1.3 to 1.4. <b>Page x:</b> Revised table of related manuals. <b>Page 18:</b> Added information on program structure of CX-Simulator. <b>Page 21:</b> Changed table. <b>Page 28:</b> Changed screen capture. <b>Page 29:</b> Removed first sentence from note at top of page. <b>Page 66:</b> Changed screen capture and table details. <b>Page 89:</b> Added note. <b>Page 128:</b> Changed screen capture. <b>Page 129:</b> Added information on serial data files. <b>Page 140:</b> Changed screen capture. <b>Page 177:</b> Changed information for step 4.

## Revision History

Revision code	Date	Revised content
05	November 2005	<p>Contents revised to reflect the upgrade from Version 1.4 to Version 1.5, and from Version 1.5 to Version 1.6, including the following changes:            Added information on CP Series throughout manual.  <b>Page v:</b> Added information on DANGER and WARNING indications.  <b>Page vii:</b> Added information on upgrade from Ver. 1.4 to Ver. 1.5.  <b>Page viii:</b> Added information on CP1H CPU Unit.  <b>Page xi:</b> Changed table.  <b>Page xv:</b> Changed tables.  <b>Page xix:</b> Changed information on related manuals.  <b>Page xx:</b> Added information on warranty and limitations of liability, application considerations, and disclaimers.  <b>Page 2:</b> Added information to Note concerning CX-Simulator when using CX-Programmer Ver. 6.1 or higher.  <b>Page 5:</b> Changed table.  <b>Page 6:</b> Changed table.  <b>Page 7:</b> Changed table.  <b>Page 12:</b> Changed wording of instructions at bottom of page.  <b>Page 13:</b> Added table.  <b>Page 19:</b> Changed table.  <b>Page 20:</b> Changed table.  <b>Page 22:</b> Changed table.  <b>Page 25 to 34:</b> Thoroughly revised Section 2.  <b>Page 38:</b> Changed information for step following 3-3-1.  <b>Page 42:</b> Changed information for step 5.  <b>Page 71:</b> Added note.  <b>Page 103:</b> Changed information for 4-3.  <b>Page 118:</b> Added Cat. No. to note at top of page.  <b>Page 121:</b> Added note.  <b>Page 118:</b> Added Cat. No. to first note.  <b>Page 138:</b> Added note.  <b>Page 148:</b> Added information to note.  <b>Page 149:</b> Added information to note.  <b>Page 150:</b> Added note.  <b>Page 151:</b> Changed information in note.  <b>Page 225:</b> Changed table.  <b>Page 226:</b> Changed table.  <b>Page 232:</b> Changed table.  <b>Page 233:</b> Changed table.  <b>Page 239:</b> Changed name of CX-Net to CX-Integrator.</p>
06	July 2006	<p>Contents revised to reflect the upgrade from version 1.6 to 1.7.            CX-Programmer version updated to 7.0.  <b>Cover and page xxi:</b> NSJ Series added.  <b>Page viii:</b> CX-Simulator version 1.7 information added.  <b>Page xii:</b> Previous page removed and tables of unit versions and supported functions added.  <b>Pages xiii to xvii:</b> Information updated.  <b>Page xxi:</b> Manuals added to table.  <b>Page 2:</b> Note added.  <b>Page 15:</b> Information updated.  <b>Page 16:</b> <i>Section 1-5 removed.</i></p>
07	July 2007	<p>Contents revised to reflect the upgrade from version 1.7 to 1.8.  <b>Page ix:</b> CX-Simulator version 1.8 information added.  <b>Page x:</b> Information updated to include descriptions for CJ1-H-R and CPIH/CPIL CPU Units.  <b>Pages xiii to xx:</b> Information on unit versions and supported functions updated.  <b>Pages xxv and xxvi:</b> Manuals added to table.  <b>Page 14:</b> Information updated.  <b>Pages 14 and 26:</b> CX-One version updated.  <b>Pages 38, 40, 41, and 44:</b> Menu name changed from "PLC" to "Simulation."</p>
08	June 2008	Contents revised to reflect the upgrade from version 1.8 or 1.9.
09	February 2009	Contents revised to reflect the upgrade from version 1.9 to 1.91.
10	December 2009	Contents revised to reflect the upgrade from version 1.91 to 1.94.
11	February 2010	Contents revised to reflect the upgrade from version 1.94 to 1.95.
12	October 2010	Contents revised to reflect the upgrade from Ver.1.95 to Ver.1.98.
13	April 2012	Contents revised to reflect the upgrade from Ver.1.98 to Ver.1.991.
14	April 2016	<p>Contents revised to reflect the upgrade from version 1.991 to 1.997.            Windows 10 supported.            CX-One Package type changed.</p>
15	December 2018	<p>Contents revised to reflect the upgrade from 1.997 to 2.00.            (Supported CS1D-CPU68HA,67HA, 67SA and 44SA)</p>
16	September 2019	<p>Contents revised to reflect the upgrade from Ver.2.00 to Ver.2.01.            (Supported CP2E-Series PLC)</p>





**OMRON Corporation** Industrial Automation Company  
Kyoto, JAPAN

Contact: [www.ia.omron.com](http://www.ia.omron.com)

**Regional Headquarters**

**OMRON EUROPE B.V.**  
Wegalaan 67-69, 2132 JD Hoofddorp  
The Netherlands  
Tel: (31)2356-81-300/Fax: (31)2356-81-388

**OMRON ELECTRONICS LLC**  
2895 Greenspoint Parkway, Suite 200  
Hoffman Estates, IL 60169 U.S.A.  
Tel: (1) 847-843-7900/Fax: (1) 847-843-7787

**OMRON ASIA PACIFIC PTE. LTD.**  
No. 438A Alexandra Road # 05-05/08 (Lobby 2),  
Alexandra Technopark,  
Singapore 119967  
Tel: (65) 6835-3011/Fax: (65) 6835-2711

**OMRON (CHINA) CO., LTD.**  
Room 2211, Bank of China Tower,  
200 Yin Cheng Zhong Road,  
PuDong New Area, Shanghai, 200120, China  
Tel: (86) 21-5037-2222/Fax: (86) 21-5037-2200

**Authorized Distributor:**

© OMRON Corporation 2006-2019 All Rights Reserved.  
In the interest of product improvement,  
specifications are subject to change without notice.

**Cat. No. W366-E1-16**

0919