

**Various encoder interfaces and
high-speed multi-axis control
by analog commands
for precise machine operation**



CK3W-AX□□□□□

Features

- One CK3W-AX Unit controls up to four axes
- Analog input servo drives or DirectPWM servo drives can be connected
- Digital quadrature encoders, serial encoders, and sinusoidal encoders can be connected as encoder input
- 16 digital inputs and 16 digital outputs are built in

System Configurations

Basic System Configuration

Encoder (Digital quadrature encoder, serial encoder)

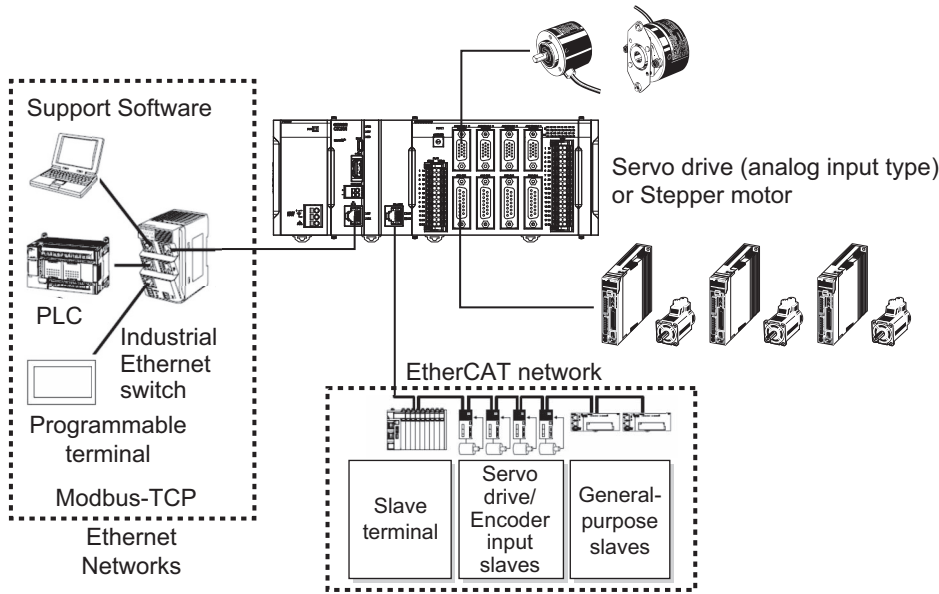

CK3W Unit Configuration (CPU Rack/Expansion Rack)

The following shows the configuration of CK3W Units.

CPU Rack

The CK3W Unit configuration in the CPU Rack consists of a Power Supply Unit, CPU Unit, CK3W-AX Unit, CK3W-MD Unit, CK3W-AD Unit, and End Cover.

Up to four CK3W Units (or up to two CK3W-AX Units) can be connected to the CPU Unit.

Expansion Rack

One Expansion Rack can be connected per CPU Unit.

To connect an Expansion Rack, use the Expansion Master Unit (CK3W-EXM01) and Expansion Slave Unit (CK3W-EXS02).

Up to four CK3W Units (or up to two CK3W-AX Units) can be installed to the Expansion Rack.

Connect the Expansion Master Unit (CK3W-EXM01) adjacent to the right side of the CPU Unit. Connect the Expansion Slave Unit (CK3W-EXS02) adjacent to the right side of the Power Supply Unit.

Unless the Expansion Master Unit (CK3W-EXM01) is connected adjacent to the right side of the CPU Unit, the Sys.Status register CK3WConfigErr becomes "5".

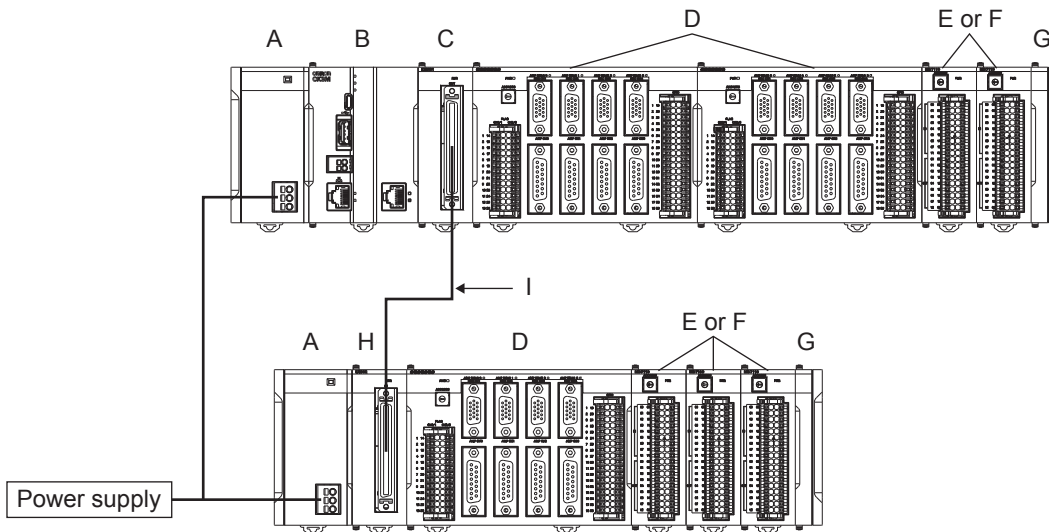

Letter	Configuration	Remarks
A	Power Supply Unit	Input the 24 V power source. Always wire the CPU Rack and Expansion Rack to the same power supply.
B	CK3M-series CPU Unit	This is the Unit at the center of the motion control, which executes the motion program.
C	CK3W-EXM01	Expansion Master Unit. Connect this Unit adjacent to the right side of the CPU Unit in the Expansion Rack.
D	CK3W-AX Unit	Axis Interface Unit. For axis control, connect this to a Servo Drive and encoder.
E	CK3W-MD Unit	Digital I/O Unit. You can add 16 digital inputs and 16 digital outputs.

Letter	Configuration	Remarks
F	CK3W-AD Unit	Analog Input Unit. You can add 4 or 8 voltage inputs.
G	End Cover	Must be connected to the right end of the CPU Rack and Expansion Rack. The CPU Unit and the Expansion Slave Unit are each provided with one End Cover.
H	CK3W-EXS02	Expansion Slave Unit. Use this in the Expansion Rack. Connect this Unit adjacent to the right side of the Power Supply Unit.
I	Expansion cable	Use this cable to connect the Expansion Master Unit and the Expansion Slave Unit. The cable length is 30 cm. Be sure to use the CK3W-CAX003A (30 cm) cable.

EtherCAT Network Configuration

The EtherCAT network configuration consists of a Power Supply Unit, CPU Unit, End Cover, and EtherCAT slaves. Use the built-in EtherCAT port on the CK3M-series CPU Unit to connect EtherCAT slaves.

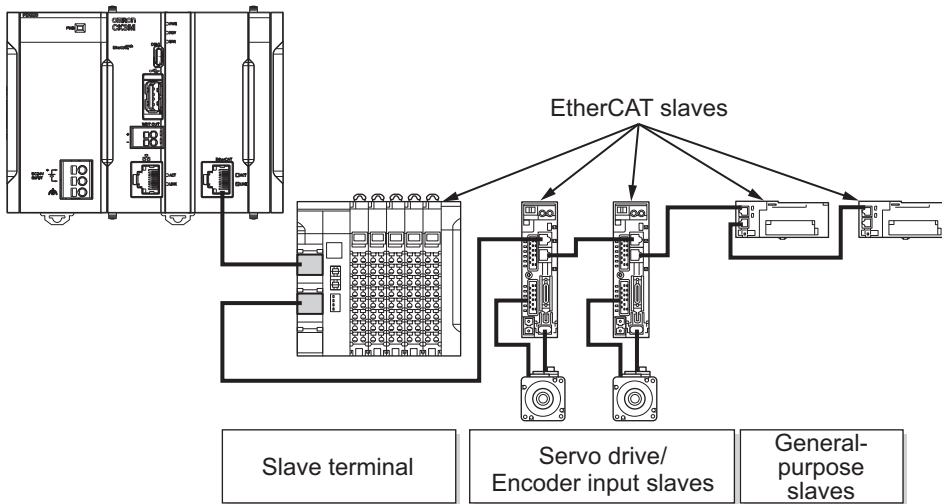

EtherCAT is synchronized with the servo cycle of the CK3M-series CPU Unit. This enables acquisition of the I/O data of slave terminals that are synchronized with the servo cycle.

Ordering Information

Axial Interface Unit

The models and outline of specifications are given below.

Product name	Amplifier interface	Encoder interface	Output type	Model
Axial Interface Unit	DirectPWM output	Digital quadrature encoder/serial encoder	NPN type	CK3W-AX1313N
	DA output (Filtered PWM)			CK3W-AX1414N
	DA output (True DAC)			CK3W-AX1515N
	DirectPWM output	Sinusoidal encoder/serial encoder		CK3W-AX2323N
	DirectPWM output	Digital quadrature encoder/serial encoder	PNP type	CK3W-AX1313P
	DA output (Filtered PWM)			CK3W-AX1414P
	DA output (True DAC)			CK3W-AX1515P
	DirectPWM output	Sinusoidal encoder/serial encoder		CK3W-AX2323P

Dedicated Cable for Wiring to Encoder Connector

Type	Cable length	Model
For digital quadrature encoder	3 m	CK3W-CAED03A
For sinusoidal encoder	3 m	CK3W-CAEA03A
For serial encoder	3 m	CK3W-CAES03A
For "digital quadrature encoder + UVW signal" or "digital quadrature encoder + serial encoder"	3 m	CK3W-CAEW03A
For "sinusoidal encoder + UVW signal" or "sinusoidal encoder + serial encoder"	3 m	CK3W-CAEAW03A

Note: The encoder connection side has discrete wires. Wire in accordance with the encoder specifications.

Dedicated Cable for Wiring to Amplifier Connector

Type	Cable length	Model
For FilteredPWM/TrueDAC type	3 m	CK3W-CAA03A
For DirectPWM type	0.9 m	CK3W-CAAD009A
	1.8 m	CK3W-CAAD018A
	3.6 m	CK3W-CAAD036A

Note: The amplifier connection side of the CK3W-CAA03A Cable has discrete wires. Wire in accordance with the servo drive specifications.

General Specifications

This section describes the Motion Controller specifications.

Item	Specification	
Enclosure	Mounted in a panel	
Grounding Method	Ground to less than 100 Ω.	
Operating Environment	Ambient Operating Temperature	0 to 55°C
	Ambient Operating Humidity	10% to 95% (with no condensation or icing)
	Atmosphere	Must be free of corrosive gases.
	Ambient Storage Temperature	-25 to 70°C (with no condensation or icing)
	Vibration Resistance	Conforms to IEC 60068-2-6. 5 to 8.4 Hz with 3.5-mm amplitude, 8.4 to 150 Hz, acceleration of 9.8 m/s ² 100 min each in X, Y, and Z directions (10 sweeps of 10 min each = 100 min total)
	Shock Resistance	Conforms to IEC 60068-2-27. 147 m/s ² , 3 times each in X, Y, and Z directions
Insulation Resistance	20 MΩ min. between isolated circuits (at 100 VDC)	
Dielectric Strength	510 VAC between isolated circuits for 1 minute with a leakage current of 5 mA max.	
Applicable Standards	cULus, EU: EN 61326, RCM, KC, EAC	

Axis Interface Unit Specifications

The main specifications for axis interface are given below.

CK3W-AX1414□/-AX1515□

Item	Specification (CK3W-)			
	AX1414N	AX1414P	AX1515N	AX1515P
Address setting range	0 to F			
Number of channels	4 channels/Unit			
Encoder power supply output	5 VDC 500 mA/channel or less However, the total output current of each Unit is 1 A or less.			
Digital quadrature encoder input	Input form	Line receiver input		
	Maximum response frequency	Phases A, B, and C: 10 MHz		
Serial encoder input	Supported protocol			
Digital Hall sensor	Contact your OMRON representative for information on the support protocols.			
Digital Hall sensor	4 points/channel (U, V, W, T)			
OUTFlagB output	1 point/channel			
Analog output	Method	FilteredPWM type	TrueDAC type	
	Number of points	1 point/channel	2 points/channel	
	Output range	Between DACA+/DACB+ and DACA-/DACB-: -20 to 20 V Between DACA+/DACB+ and AGND: -10 to 10 V		
Pulse output	Output form	Line driver output		
	Output method	Pulse output + directional output, or phase difference output		
	Maximum output frequency	10 MHz		
Amp enable output	1 point/channel			
Fault input	1 point/channel			
Flags	Digital input	4 points/channel (HOME, PLIM, NLIM, USER)		
	Digital output	1 point/channel (EQU)		
General digital I/O	Number of points	16 inputs, 16 outputs		
	Internal common	NPN	PNP	NPN PNP
Power consumption	5 VDC: 4.5 W max. 24 VDC: 10.8 W max.		5 VDC: 4.5 W max. 24 VDC: 12.5 W max.	
Dimensions (height × depth × width)	90(H)/80(D)/130(W)			
Weight	520 g max.			

CK3W-AX1313□/-AX2323□

Item	Specification (CK3W-)			
	AX1313N	AX1313P	AX2323N	AX2323P
Address setting range	0 to F			
Number of channels	4 channels/Unit			
Encoder power supply output	5 VDC 500 mA/channel or less However, the total output current of each Unit is 1 A or less.			
Digital quadrature encoder input	Input form	Line receiver input		---
	Maximum response frequency	Phases A, B, and C: 10 MHz		
Serial encoder input	Supported protocol			
	Contact your OMRON representative for information on the support protocols.			

CK3W Axial Interface Unit

Item		Specification (CK3W-)			
		AX1313N	AX1313P	AX2323N	AX2323P
Sinusoidal encoder input	Input signal	---		1-Vpp SIN/COS signal	
	Maximum input frequency	---		2 MHz	
Digital Hall sensor		4 points/channel (U, V, W, T)			
DirectPWM output		Amplifier interface unique to Delta Tau			
Amp enable output		1 point/channel (built into DirectPWM)			
Fault input		1 point/channel (built into DirectPWM)			
Flags	Digital input	4 points/channel (HOME, PLIM, NLIM, USER)			
	Digital output	1 point/channel (EQU)			
General digital I/O	Number of points	16 inputs, 16 outputs			
	Internal common	NPN	PNP	NPN	PNP
Power consumption		5 VDC: 3.4 W max. 24 VDC: 12.5 W max.		5 VDC: 3.0 W max. 24 VDC: 13.1 W max.	
Dimensions (height × depth × width)		90(H)/80(D)/130(W)			
Weight		480 g max.			490 g max.

Dedicated Cable for Wiring to Encoder Connector

The dedicated cables for wiring to the encoder connector are provided as an option.
The encoder connection side has discrete wires. Wire in accordance with the encoder specifications.

For digital quadrature encoder CK3W-CAED03A

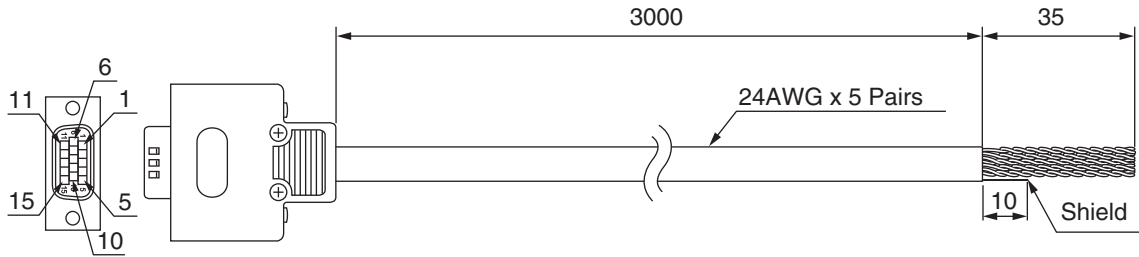

Type	Pin No.	Cable color	Mark	Signal
Pair 1	11	Blue	Black	Encoder Power Supply (+5 VDC)
	13	Blue	Red	Encoder Power Supply (GND)
Pair 2	1, 5 *1	Pink	Black	Encoder A+ Serial Encoder DAT+
	6, 10 *2	Pink	Red	Encoder A- Serial Encoder DAT-
Pair 3	2	Green	Black	Encoder B+
	7	Green	Red	Encoder B-
Pair 4	3	Orange	Black	Encoder C+
	8	Orange	Red	Encoder C-
Pair 5	15	Gray	Black	OutFlagB
	14	Gray	Red	GND

*1. Inside the connector, Pin 1 and Pin 5 are short-circuited.

*2. Inside the connector, Pin 6 and Pin 10 are short-circuited.

Note: The cable shield is connected to the connector shell of the encoder connector.

When using this cable, set to *OutFlagD* = 1, and disable the serial encoder DAT terminating resistance.

For Sinusoidal Encoder

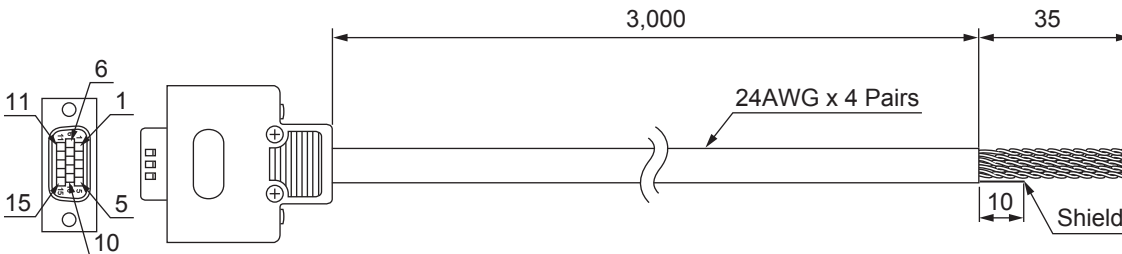

Type	Pin No.	Cable color	Signal
Pair 1	11	Black	Encoder Power Supply (+5 VDC)
	13	Blue	Encoder Power Supply (GND)
Pair 2	1	Black	SIN+
	6	Red	SIN-
Pair 3	2	Black	COS+
	7	White	COS-
Pair 4	3	Black	INDEX+
	8	Green	INDEX-

Note: The cable shield consists of an overall shield and pair shields.

The overall shield is connected to the connector shell of the encoder connector.

The pair shields are connected to the Encoder Power Supply (GND) pin.

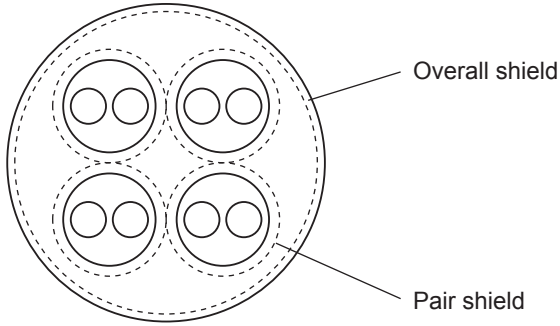

For Serial Encoder

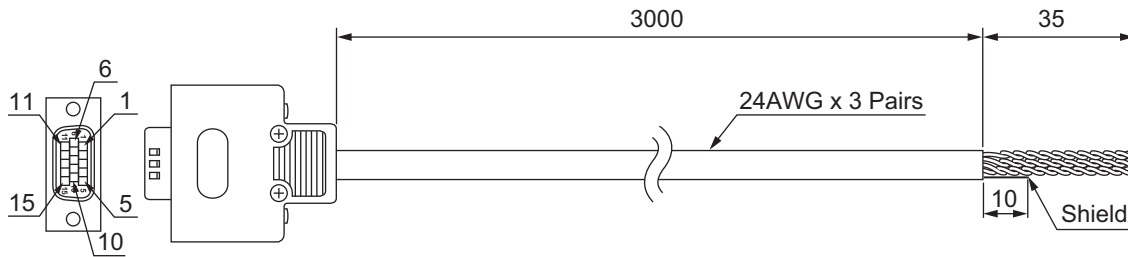

Type	Pin No.	Cable color	Mark	Signal
Pair 1	12	Blue	Black	Encoder Power Supply (+5 VDC)
	14	Blue	Red	Encoder Power Supply (GND)
Pair 2	4	Pink	Black	Encoder CLK+
	9	Pink	Red	Encoder CLK-
Pair 3	5	Green	Black	Serial Encoder DAT+
	10	Green	Red	Serial Encoder DAT-

Note: The cable shield is connected to the connector shell of the encoder connector.

For “Digital Quadrature Encoder + UVW Signal” or “Digital Quadrature Encoder + Serial Encoder”

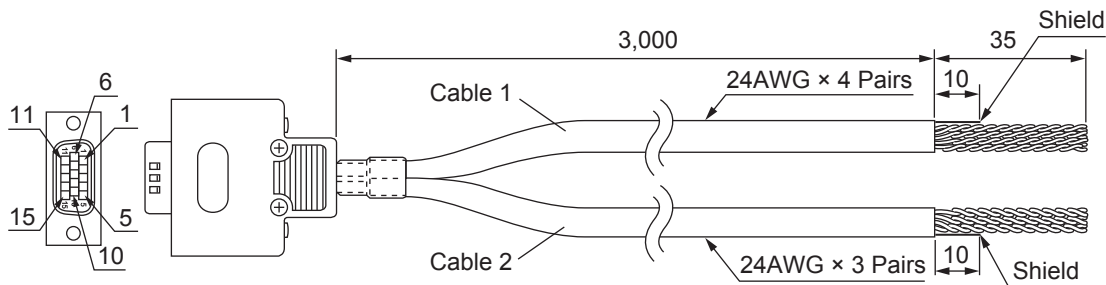

Cable 1

Type	Pin No.	Cable color	Mark	Signal
Pair 1	11	Blue	Black	Encoder Power Supply (+5 VDC)
	13	Blue	Red	Encoder Power Supply (GND)
Pair 2	1	Pink	Black	Encoder A+
	6	Pink	Red	Encoder A-
Pair 3	2	Green	Black	Encoder B+
	7	Green	Red	Encoder B-
Pair 4	3	Orange	Black	Encoder C+
	8	Orange	Red	Encoder C-

Note: The cable shield is connected to the connector shell of the encoder connector.

Cable 2

Type	Pin No.	Cable color	Mark	Signal	
				U, V, W	Serial Encoder
Pair 1	12	Blue	Black	Encoder Power Supply (+5 VDC)	
	14	Blue	Red	Encoder Power Supply (GND)	
Pair 2	4	Pink	Black	Hall sensor U	Serial Encoder CLK+
	9	Pink	Red	Hall sensor V	Serial Encoder CLK-

Type	Pin No.	Cable color	Mark	Signal	
				U, V, W	Serial Encoder
Pair 3	5	Green	Black	Hall sensor W	Serial Encoder DAT+
	10	Green	Red	Hall sensor T	Serial Encoder DAT-

Note: The cable shield is connected to the connector shell of the encoder connector.

For “Sinusoidal Encoder + UVW Signal” or “Sinusoidal Encoder + Serial Encoder”

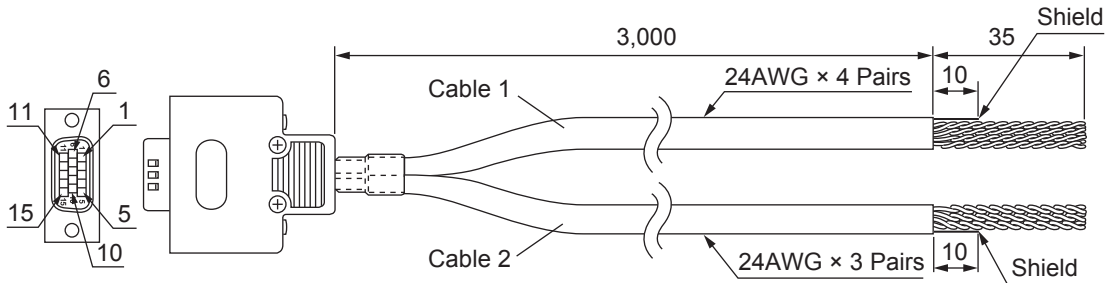

Cable 1

Type	Pin No.	Cable color	Signal
Pair 1	11	Black	Encoder Power Supply (+5 VDC)
	13	Blue	Encoder Power Supply (GND)
Pair 2	1	Black	SIN+
	6	Red	SIN-
Pair 3	2	Black	COS+
	7	White	COS-
Pair 4	3	Black	INDEX+
	8	Green	INDEX-

Note: The cable shield consists of an overall shield and pair shields.

The overall shield is connected to the connector shell of the encoder connector.
The pair shields are connected to the Encoder Power Supply (GND) pin.

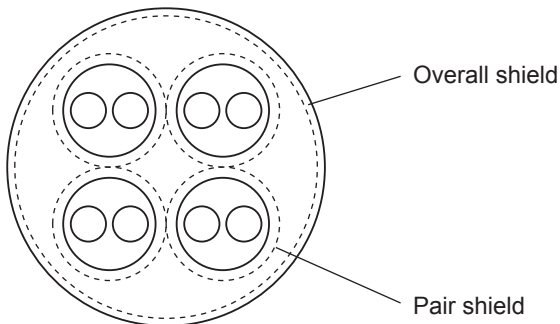

Cable 2

Type	Pin No.	Cable color	Signal	
			U, V, W	Serial Encoder
Pair 1	12	Blue	Encoder Power Supply (+5 VDC)	
	14	White	Encoder Power Supply (GND)	
Pair 2	4	Black	Hall sensor U	Serial Encoder CLK+
	9	Green	Hall sensor V	Serial Encoder CLK-
Pair 3	5	Yellow	Hall sensor W	Serial Encoder DAT+
	10	Brown	Hall sensor T	Serial Encoder DAT-

Note: The cable shield is connected to the connector shell of the encoder connector.

Dedicated Cable for Wiring to Amplifier Connector

For FilteredPWM/TrueDAC type

This section describes the cable used for the CK3W-AX1414□/-AX1515□ Units.

The dedicated cable for wiring to the FilteredPWM/TrueDAC type amplifier connector is provided as an option.

The amplifier connection side has discrete wires. Wire in accordance with the Servo Drive specifications.

The cable model is as shown below.

Type	Model	Length
For FilteredPWM/TrueDAC type	CK3W-CAA03A	3 m

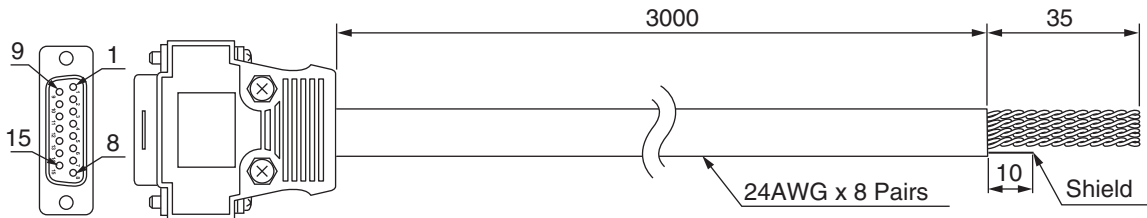

Type	Pin No.	Cable color	Mark	Signal
Pair 1	1	Blue	Black 1 dot	Analog output A+
	9	Blue	Red 1 dot	Analog output A-
Pair 2	2	Pink	Black 1 dot	Analog output B+
	10	Pink	Red 1 dot	Analog output B-
Pair 3	3	Green	Black 1 dot	Analog GND
	3	Green	Red 1 dot	Analog GND
Pair 4	5	Orange	Black 1 dot	Pulse output +
	12	Orange	Red 1 dot	Pulse output -
Pair 5	6	Gray	Black 1 dot	Directional output +
	13	Gray	Red 1 dot	Directional output -
Pair 6		Blue	Black 2 dot	Fault input +
	11	Blue	Red 2 dot	Fault input -
Pair 7	7	Pink	Black 2 dot	Amp enable NO
	15	Pink	Red 2 dot	Amp enable common
Pair 8	8	Green	Black 2 dot	Amp enable NC
	15	Green	Red 2 dot	Amp enable common

Note: The cable shield is connected to the connector shell of the amplifier connector.

For DirectPWM type

This section describes cables used for the CK3W-AX1313□/-AX2323□ Units.

Be sure to use the following cables for the DirectPWM type amplifier connector.

Type	Model	Length
For DirectPWM type	CK3W-CAAD009A	0.9 m
	CK3W-CAAD018A	1.8 m
	CK3W-CAAD036A	3.6 m

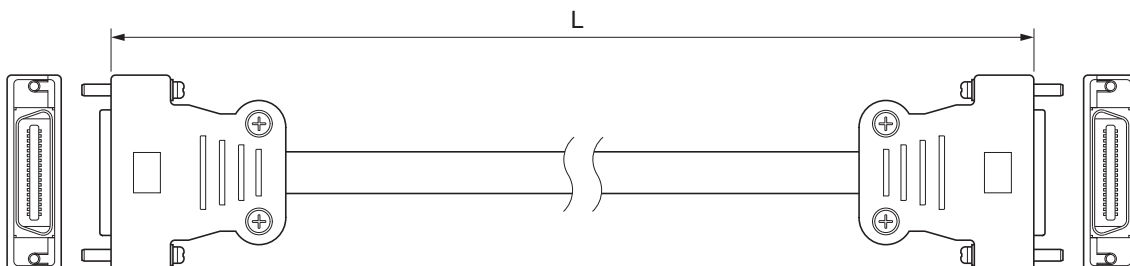

Part Names and Functions

CK3W-AX1414□/-AX1515□

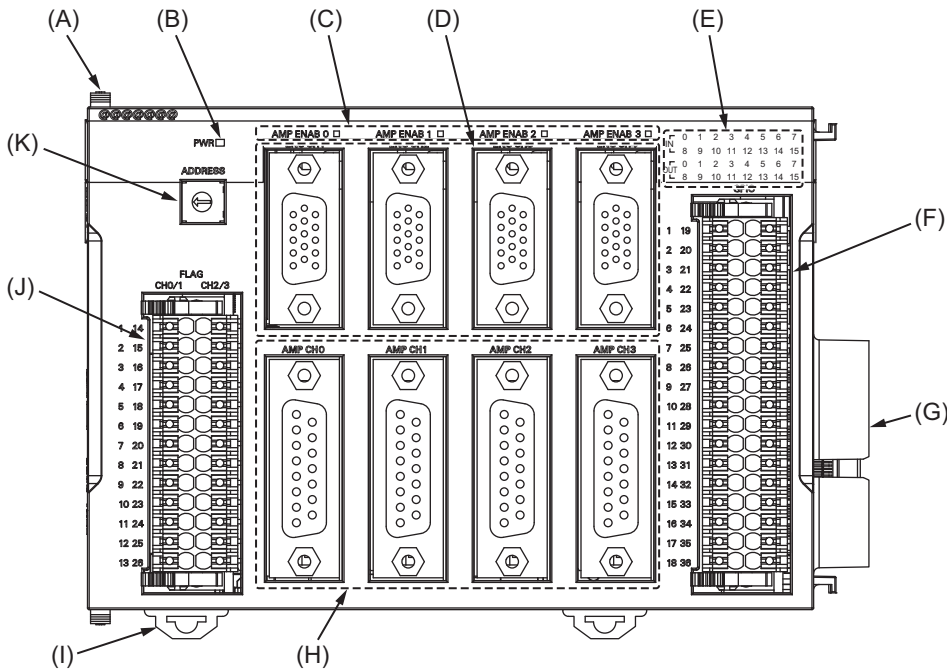

Letter	Name	Function
A	Slider	Holds the Units together.
B	Power supply status indicator	Shows the power supply status.
C	Amp enable status indicator	Shows the Amp enable status.
D	Encoder connector	Connects the encoder.
E	General digital input/output status indicator	Shows the general digital input/output status.
F	General digital I/O connection terminal block	Connects the general digital input/output.
G	Unit connector	Connector that connects to the Unit.
H	Amplifier connector	Connects the amplifier.
I	DIN Track mounting hook	Used to mount the Unit to a DIN Track.
J	Flag connection terminal block	Connects the HOME/PLIM/NLIM/USER inputs and EQU output.
K	Address switch	Sets the Gate3 Index.

CK3W-AX1313□/-AX2323□

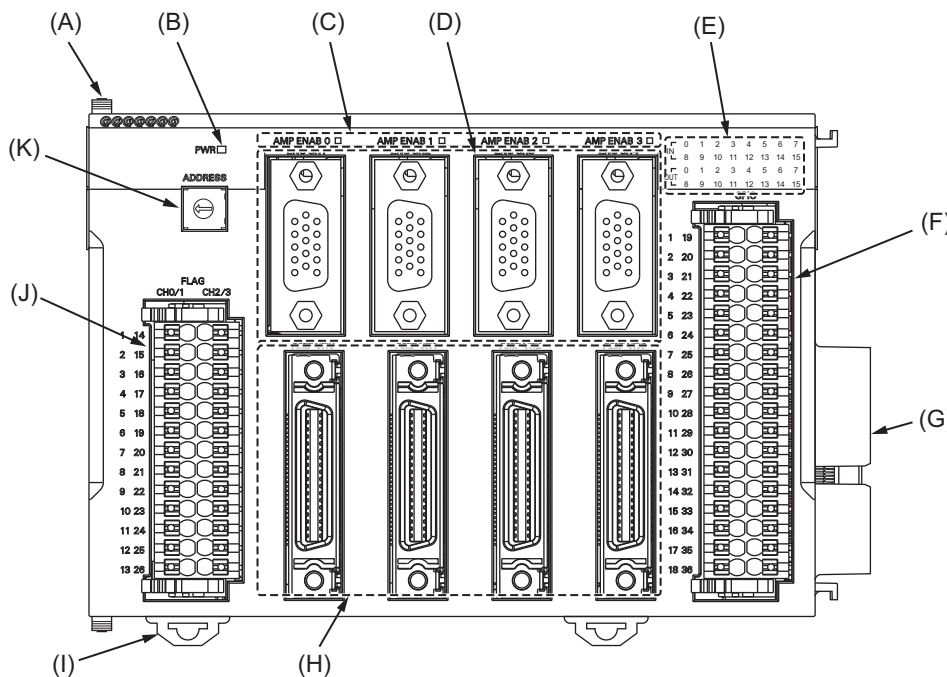

Letter	Name	Function
A	Slider	Holds the Units together.
B	Power supply status indicator	Shows the power supply status.
C	Amp enable status indicator	Shows the Amp enable status.
D	Encoder connector	Connects the encoder.
E	General digital input/output status indicator	Shows the general digital input/output status.
F	General digital I/O connection terminal block	Connects the general digital input/output.
G	Unit connector	Connector that connects to the Unit.
H	Amplifier connector	Connects the amplifier.
I	DIN Track mounting hook	Used to mount the Unit to a DIN Track.
J	Flag connection terminal block	Connects the HOME/PLIM/NLIM/USER inputs and EQU output.
K	Address switch	Sets the Gate3 Index.

Dimensions

(Unit: mm)

Axis Interface Unit

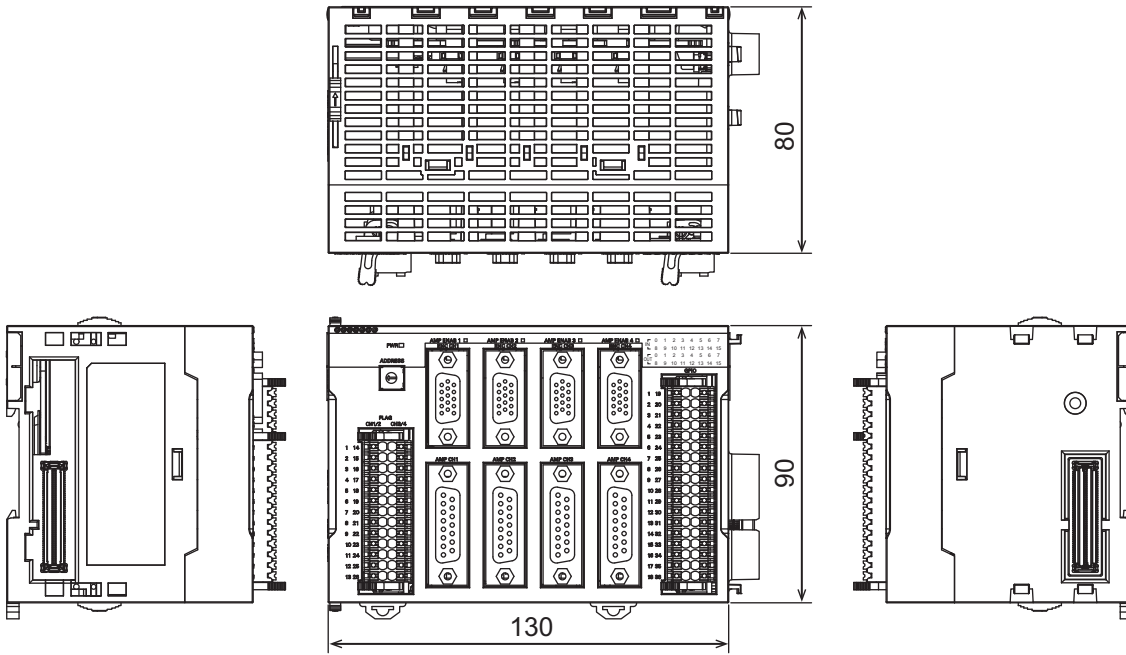

Axis Interface Unit

Model	Unit width (mm)
CK3W-AX1313N	130
CK3W-AX1414N	
CK3W-AX1515N	
CK3W-AX2323N	
CK3W-AX1313P	
CK3W-AX1414P	
CK3W-AX1515P	
CK3W-AX2323P	

Installation Height

For CK3W-AX Unit

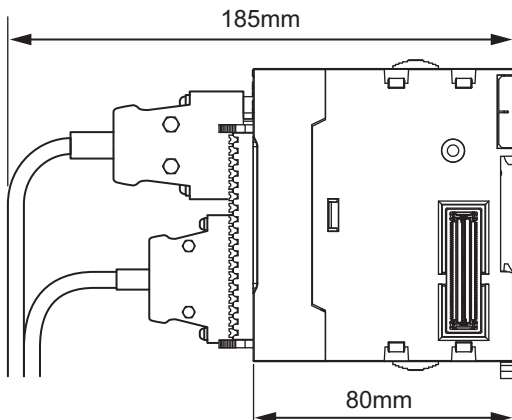

Related Manuals

The following manuals are related. Use these manuals for reference. Contact your OMRON representative for information on how to procure these manuals.

Manual name	Cat. No.	Application	Description
CK3M-series Programmable Multi-Axis Controller Hardware User's Manual	O036	Learning the basic specifications of the CK3M-series Programmable Multi-Axis Controller, including introductory information, design, installation, and maintenance. Mainly hardware information is provided.	An introduction to the entire system is provided along with the following information. <ul style="list-style-type: none"> • Features and system configuration • Introduction • Part names and functions • General specifications • Installation and wiring • Maintenance and inspection
Power PMAC User's Manual	O014	Learning the features and usage examples of the CK3M-series Programmable Multi-Axis Controller.	The following information is provided on the CK3M-series Programmable Multi-Axis Controller. <ul style="list-style-type: none"> • Basic functions • Setup examples • Programming examples
Power PMAC Software Reference Manual	O015	Learning how to program a CK3M-series Programmable Multi-Axis Controller.	The following information is provided on the CK3M-series Programmable Multi-Axis Controller. <ul style="list-style-type: none"> • Details of commands • Details of data structure
Power PMAC IDE User Manual	O016	Learning how to operate Power PMAC IDE, the integrated development environment of the Controller.	Describes the operating procedures of Power PMAC IDE, and examples of how to start the system.
Power PMAC-NC-16 Quick Start Manual	O017	Briefly understanding the basic usage of Power PMAC-NC16.	Describes the Quick setup procedure to run Power PMAC-NC16 on a desktop PC by showing some examples.
Power PMAC-NC16 .ini Configuration Manual	O018	Configuring an application for CNC devices by using Power PMAC-NC16.	Describes how to set up <i>PowerPmacNC.ini</i> , the setup data file to be loaded when Power PMAC-NC16 starts.
Power PMAC-NC16 Software User Manual	O019	Learning about usage and features of Power PMAC-NC16, Support Software required to use the Controller for CNC devices.	The following information is provided on Power PMAC-NC16. <ul style="list-style-type: none"> • How to use the software • Features included in the software • Features that can be customized
Power PMAC-NC16 Mill G-Code Manual	O020	Creating programs for CNC devices by using Power PMAC-NC16.	Describes the basic G-code set that can be used for Power PMAC-NC16, and relevant instructions.

Terms and Conditions Agreement

Read and understand this catalog.

Please read and understand this catalog before purchasing the products. Please consult your OMRON representative if you have any questions or comments.

Warranties.

(a) Exclusive Warranty. Omron's exclusive warranty is that the Products will be free from defects in materials and workmanship for a period of twelve months from the date of sale by Omron (or such other period expressed in writing by Omron). Omron disclaims all other warranties, express or implied.

(b) Limitations. OMRON MAKES NO WARRANTY OR REPRESENTATION, EXPRESS OR IMPLIED, ABOUT NON-INFRINGEMENT, MERCHANTABILITY OR FITNESS FOR A PARTICULAR PURPOSE OF THE PRODUCTS. BUYER ACKNOWLEDGES THAT IT ALONE HAS DETERMINED THAT THE PRODUCTS WILL SUITABLY MEET THE REQUIREMENTS OF THEIR INTENDED USE.

Omron further disclaims all warranties and responsibility of any type for claims or expenses based on infringement by the Products or otherwise of any intellectual property right. (c) Buyer Remedy. Omron's sole obligation hereunder shall be, at Omron's election, to (i) replace (in the form originally shipped with Buyer responsible for labor charges for removal or replacement thereof) the non-complying Product, (ii) repair the non-complying Product, or (iii) repay or credit Buyer an amount equal to the purchase price of the non-complying Product; provided that in no event shall Omron be responsible for warranty, repair, indemnity or any other claims or expenses regarding the Products unless Omron's analysis confirms that the Products were properly handled, stored, installed and maintained and not subject to contamination, abuse, misuse or inappropriate modification. Return of any Products by Buyer must be approved in writing by Omron before shipment. Omron Companies shall not be liable for the suitability or unsuitability or the results from the use of Products in combination with any electrical or electronic components, circuits, system assemblies or any other materials or substances or environments. Any advice, recommendations or information given orally or in writing, are not to be construed as an amendment or addition to the above warranty.

See <http://www.omron.com/global/> or contact your Omron representative for published information.

Limitation on Liability: Etc.

OMRON COMPANIES SHALL NOT BE LIABLE FOR SPECIAL, INDIRECT, INCIDENTAL, OR CONSEQUENTIAL DAMAGES, LOSS OF PROFITS OR PRODUCTION OR COMMERCIAL LOSS IN ANY WAY CONNECTED WITH THE PRODUCTS, WHETHER SUCH CLAIM IS BASED IN CONTRACT, WARRANTY, NEGLIGENCE OR STRICT LIABILITY.

Further, in no event shall liability of Omron Companies exceed the individual price of the Product on which liability is asserted.

Suitability of Use.

Omron Companies shall not be responsible for conformity with any standards, codes or regulations which apply to the combination of the Product in the Buyer's application or use of the Product. At Buyer's request, Omron will provide applicable third party certification documents identifying ratings and limitations of use which apply to the Product. This information by itself is not sufficient for a complete determination of the suitability of the Product in combination with the end product, machine, system, or other application or use. Buyer shall be solely responsible for determining appropriateness of the particular Product with respect to Buyer's application, product or system. Buyer shall take application responsibility in all cases.

NEVER USE THE PRODUCT FOR AN APPLICATION INVOLVING SERIOUS RISK TO LIFE OR PROPERTY OR IN LARGE QUANTITIES WITHOUT ENSURING THAT THE SYSTEM AS A WHOLE HAS BEEN DESIGNED TO ADDRESS THE RISKS, AND THAT THE OMRON PRODUCT(S) IS PROPERLY RATED AND INSTALLED FOR THE INTENDED USE WITHIN THE OVERALL EQUIPMENT OR SYSTEM.

Programmable Products.

Omron Companies shall not be responsible for the user's programming of a programmable Product, or any consequence thereof.

Performance Data.

Data presented in Omron Company websites, catalogs and other materials is provided as a guide for the user in determining suitability and does not constitute a warranty. It may represent the result of Omron's test conditions, and the user must correlate it to actual application requirements. Actual performance is subject to the Omron's Warranty and Limitations of Liability.

Change in Specifications.

Product specifications and accessories may be changed at any time based on improvements and other reasons. It is our practice to change part numbers when published ratings or features are changed, or when significant construction changes are made. However, some specifications of the Product may be changed without any notice. When in doubt, special part numbers may be assigned to fix or establish key specifications for your application. Please consult with your Omron's representative at any time to confirm actual specifications of purchased Product.

Errors and Omissions.

Information presented by Omron Companies has been checked and is believed to be accurate; however, no responsibility is assumed for clerical, typographical or proofreading errors or omissions.