

RFID System

# V600 Series

## User's Manual

Hand-held Reader Writer

V600-CHUD  
V600-CH1D-V2  
V600-CH1D-PSI

Data Carriers

V600 Series

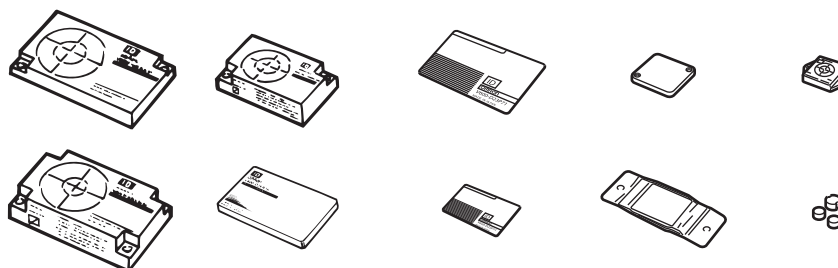
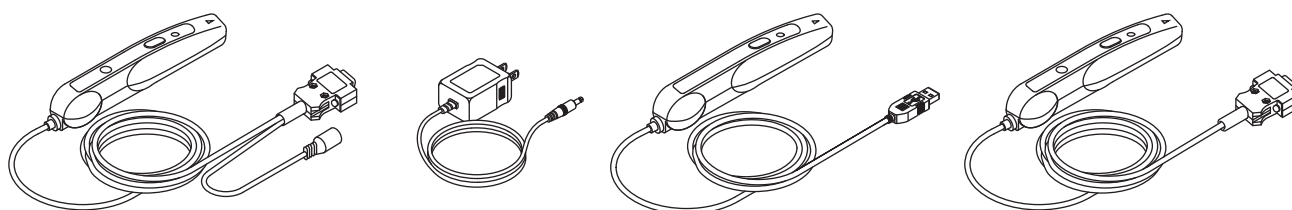



Introduction	Application Considerations (Read and understand this information first.)	Introduction
Section 1	Product Overview	Section 1
Section 2	Communications Preparations	Section 2
Section 3	Commands	Section 3
Section 4	Functions	Section 4
Section 5	Troubleshooting	Section 5
Section 6	Appendices	Section 6

## RFID System

V600-CHUD      Hand-held Reader Writer  
V600-CH1D-V2    Hand-held Reader Writer  
V600-CH1D-PSI   Hand-held Reader Writer

V600 Series      Data Carriers

## User's Manual

**READ AND UNDERSTAND THIS DOCUMENT**

Please read and understand this document before using the products. Please consult your OMRON representative if you have any questions or comments.

**WARRANTY**

OMRON's exclusive warranty is that the products are free from defects in materials and workmanship for a period of one year (or other period if specified) from date of sale by OMRON.

OMRON MAKES NO WARRANTY OR REPRESENTATION, EXPRESS OR IMPLIED, REGARDING NON-INFRINGEMENT, MERCHANTABILITY, OR FITNESS FOR PARTICULAR PURPOSE OF THE PRODUCTS. ANY BUYER OR USER ACKNOWLEDGES THAT THE BUYER OR USER ALONE HAS DETERMINED THAT THE PRODUCTS WILL SUITABLY MEET THE REQUIREMENTS OF THEIR INTENDED USE. OMRON DISCLAIMS ALL OTHER WARRANTIES, EXPRESS OR IMPLIED.

**LIMITATIONS OF LIABILITY**

OMRON SHALL NOT BE RESPONSIBLE FOR SPECIAL, INDIRECT, OR CONSEQUENTIAL DAMAGES, LOSS OF PROFITS OR COMMERCIAL LOSS IN ANY WAY CONNECTED WITH THE PRODUCTS, WHETHER SUCH CLAIM IS BASED ON CONTRACT, WARRANTY, NEGLIGENCE, OR STRICT LIABILITY.

In no event shall responsibility of OMRON for any act exceed the individual price of the product on which liability is asserted.

IN NO EVENT SHALL OMRON BE RESPONSIBLE FOR WARRANTY, REPAIR, OR OTHER CLAIMS REGARDING THE PRODUCTS UNLESS OMRON'S ANALYSIS CONFIRMS THAT THE PRODUCTS WERE PROPERLY HANDLED, STORED, INSTALLED, AND MAINTAINED AND NOT SUBJECT TO CONTAMINATION, ABUSE, MISUSE, OR INAPPROPRIATE MODIFICATION OR REPAIR.

**SUITABILITY FOR USE**

THE PRODUCTS CONTAINED IN THIS DOCUMENT ARE NOT SAFETY RATED. THEY ARE NOT DESIGNED OR RATED FOR ENSURING SAFETY OF PERSONS, AND SHOULD NOT BE RELIED UPON AS A SAFETY COMPONENT OR PROTECTIVE DEVICE FOR SUCH PURPOSES. Please refer to separate catalogs for OMRON's safety rated products.

OMRON shall not be responsible for conformity with any standards, codes, or regulations that apply to the combination of products in the customer's application or use of the product.

At the customer's request, OMRON will provide applicable third party certification documents identifying ratings and limitations of use that apply to the products. This information by itself is not sufficient for a complete determination of the suitability of the products in combination with the end product, machine, system, or other application or use.

The following are some examples of applications for which particular attention must be given. This is not intended to be an exhaustive list of all possible uses of the products, nor is it intended to imply that the uses listed may be suitable for the products:

- Outdoor use, uses involving potential chemical contamination or electrical interference, or conditions or uses not described in this document.
- Nuclear energy control systems, combustion systems, railroad systems, aviation systems, medical equipment, amusement machines, vehicles, safety equipment, and installations subject to separate industry or government regulations.
- Systems, machines, and equipment that could present a risk to life or property.

Please know and observe all prohibitions of use applicable to the products.

NEVER USE THE PRODUCTS FOR AN APPLICATION INVOLVING SERIOUS RISK TO LIFE OR PROPERTY WITHOUT ENSURING THAT THE SYSTEM AS A WHOLE HAS BEEN DESIGNED TO ADDRESS THE RISKS, AND THAT THE OMRON PRODUCT IS PROPERLY RATED AND INSTALLED FOR THE INTENDED USE WITHIN THE OVERALL EQUIPMENT OR SYSTEM.

**PERFORMANCE DATA**

Performance data given in this document is provided as a guide for the user in determining suitability and does not constitute a warranty. It may represent the result of OMRON's test conditions, and the users must correlate it to actual application requirements. Actual performance is subject to the OMRON Warranty and Limitations of Liability.

**CHANGE IN SPECIFICATIONS**

Product specifications and accessories may be changed at any time based on improvements and other reasons.

It is our practice to change model numbers when published ratings or features are changed, or when significant construction changes are made. However, some specifications of the product may be changed without any notice. When in doubt, special model numbers may be assigned to fix or establish key specifications for your application on your request. Please consult with your OMRON representative at any time to confirm actual specifications of purchased products.

**DIMENSIONS AND WEIGHTS**

Dimensions and weights are nominal and are not to be used for manufacturing purposes, even when tolerances are shown.

**ERRORS AND OMISSIONS**

The information in this document has been carefully checked and is believed to be accurate; however, no responsibility is assumed for clerical, typographical, or proofreading errors, or omissions.

**PROGRAMMABLE PRODUCTS**

OMRON shall not be responsible for the user's programming of a programmable product, or any consequence thereof.

**COPYRIGHT AND COPY PERMISSION**

This document shall not be copied for sales or promotions without permission. This document is protected by copyright and is intended solely for use in conjunction with the product. Please notify us before copying or reproducing this document in any manner, for any other purpose. If copying or transmitting this document to another, please copy or transmit it in its entirety.

## Meanings of Signal Words

The following signal words are used in this manual.



Indicates a potentially hazardous situation which, if not avoided, will result in minor or moderate injury, or may result in serious injury or death. Additionally, there may be significant property damage.



Indicates a potentially hazardous situation which, if not avoided, may result in minor or moderate injury or in property damage.

## Meanings of Alert Symbols

The following alert symbols are used in this manual.



Indicates the possibility of explosion under specific conditions.



Indicates general prohibitions for which there is no specified symbol.

## Alert Statements in This Manual

The following alert statements apply to the products in this manual. Each alert statement also appears at the locations needed in this manual to attract your attention.



This product is not designed to be used either directly or indirectly in applications that detect human presence for the purpose of maintaining safety. Do not use this product as a sensing device for protecting human lives.



A lithium battery is built into SRAM Data Carriers and may occasionally combust, explode, or burn if not treated properly. Dispose of SRAM Data Carriers as industrial waste and never disassemble, apply pressure that would deform, heat to higher than 100°C, or incinerate SRAM Data Carriers.

## Precautions for Safe Use

Observe the following precautions to ensure safe use of the product.

1. Do not use the product in environments with flammable, explosive, or corrosive gasses.
2. Do not attempt to disassemble, repair, or modify the product.
3. The USB driver must be installed in the personal computer before connecting the V600-CHUD to a personal computer.
4. Do not subject cables to excessive loads.
5. Observe all warnings and precautions given in the body of this manual.
6. Discontinue usage and turn OFF the power supply immediately if you notice any unusual odors, if the product is abnormally hot, or if the product starts smoking.
7. When disposing of the product, treat it as industrial waste.

## Precautions for Correct Use

Always observe the following precautions to prevent operation failures, malfunctions, and adverse effects on performance and equipment.

### 1. Installation Environment

Install the product in the following locations:

- Locations not subject to corrosive gas, dust, metallic powder, or salt.
- Locations within the specified operating temperature range.
- Locations not subject to rapid changes in temperature (with no condensation).
- Locations within the specified humidity range.
- Locations not subject to direct vibration or shock outside the specified ranges.
- Locations not subject to water, oil, or chemicals.

### 2. Installation

- The product communicates with Data Carriers using the 530-kHz frequency band. Some motors, inverters, switching power supplies, and other devices generate noise that can affect communications with the Data Carriers. If such devices are located near the Data Carriers, communications with the Data Carriers may be adversely affected or the Data Carriers may be destroyed. Whenever using the product near devices of this nature, always test operation in advance to confirm if the system will be affected.
- Observe the following precautions to minimize the effects of normal noise.
  - (1) Ground all metal objects in the vicinity to 100  $\Omega$  or less.
  - (2) Do not use the system near high-voltage or high-current lines.
- Connectors are not waterproof. Do not use the product where mists are present.
- Do not use chemicals that would affect the materials used in the product.
- Always be sure the USB connector is properly inserted when using the USB port.

### 3. Cleaning

- Do not clean the product with thinners, benzene, or other organic solvents. These will dissolve the resin parts and coating on the case.

# How to Read this Manual

---

## Meanings of Symbols



CHECK!

Indicates particularly important points related to a function, including precautions and application advice.



Indicates page numbers containing relevant information.



Indicates reference to helpful information and explanations for difficult terminology.

MEMO



# Table of Contents

Meanings of Signal Words	3
Meanings of Alert Symbols	3
Alert Statements in This Manual	3
Precautions for Safe Use	4
Precautions for Correct Use	4
How to Read this Manual	5
Table of Contents	7
<hr/>	
Section 1 Product Overview	9
<hr/>	
Features	10
Names and Functions of Components	11
System Configuration	14
Operation Flowchart	17
<hr/>	
Section 2 Communications Preparations	21
<hr/>	
V600-CHUD Communications Preparations	22
V600-CH1D-V2 Communications Preparation	36
V600-CH1D-PSI Communications Preparation	39
Communications Test	42
<hr/>	
Section 3 Commands	45
<hr/>	
Communications with the Data Carrier	46
Command and Response Format	50
Communications Commands	54
Communications Subcommands	94
Host Commands	95
Controller Control Commands	96
Other Commands	100
End code List	101

Section 4 Functions	103
Hand-held Reader Writer Functions	104
Data Carrier	106
Section 5 Troubleshooting	117
Error Tables	118
Troubleshooting Flowchart	119
Section 6 Appendices	121
Specifications and Dimensions	122
Data Carrier Memory Map	134
Data Carrier Memory Capacity and Data Type (V600 Series)	135
List of ASCII Characters	136
Degree of Protection	137
Revision History	140

# Section 1

## Product Overview

☒ Features	10
☒ Names and Functions of Components	11
☒ System Configuration	14
☒ Operation Flowchart	17

# Features

The V600-CHUD Hand-held Reader Writer incorporates a V600-series Antenna and Controller into a compact device conforming to USB 1.1. Data can be read from or written to the Data Carrier simply by approaching or touching the Data Carrier with the Hand-held Reader Writer.



Hand-held Terminal  
manufactured by Zebra Technologies Inc.  
Hand-held Terminal Recommended  
for the V680-CH1D-PSI: Work About Pro

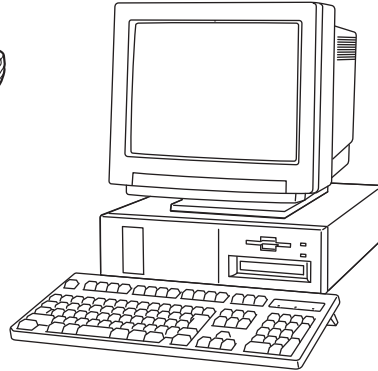

Personal computer

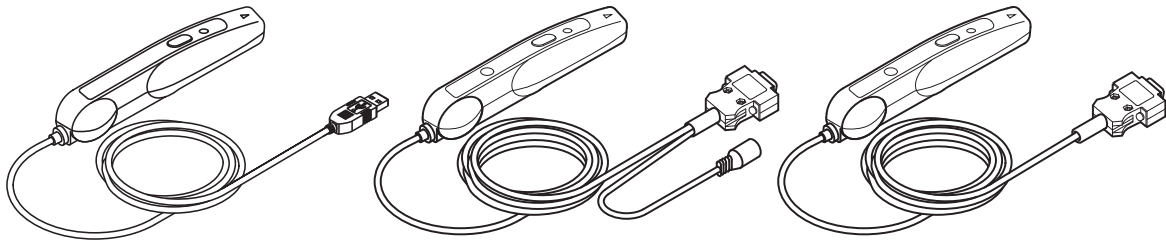

Hand-held Reader Writer

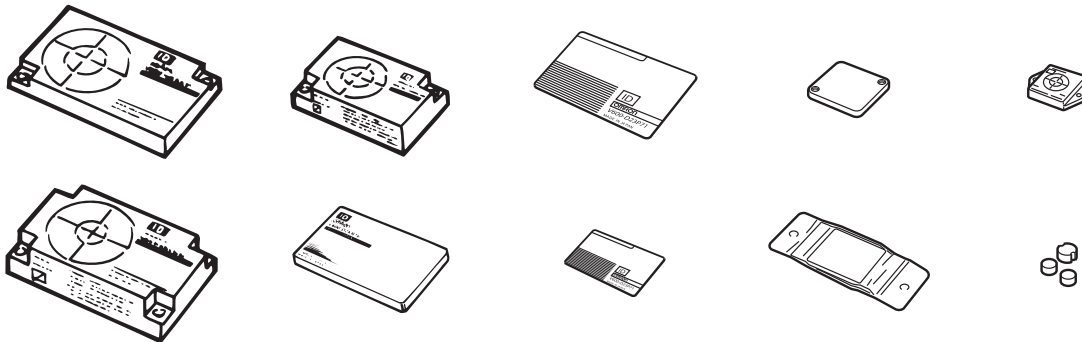

Data Carriers

- **V600-CHUD**

This Hand-held Reader/Writer provides a USB connector that conforms to the USB 1.1 standard. Connecting the Hand-held Reader/Writer to a personal computer or Hand-held Terminal gives it superior portability, and operability.

- **V600-CH1D-V2**

A built-in RS-232C interface allows this Hand-held Reader/Writer to be connected to a personal computer or programmable controller.

- **V600-CH1D-PSI**



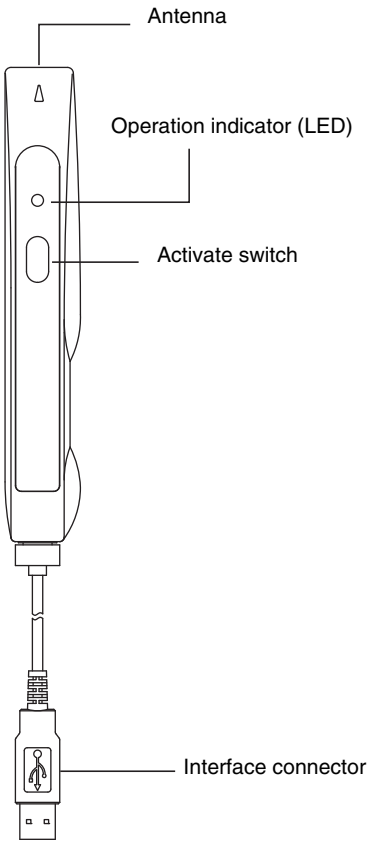

A built-in RS-232C interface allows this Hand-held Reader/Writer to be connected to a Hand-held Terminal, giving it superior portability, and operability.

# Names and Functions of Components

V600-CHUD



## •Operation Indicator (LED)

Display	Meaning
 Lit green	A command has been received from the host device.
	Communications with the Data Carrier have completed normally.
	The execution result of the noise detection command (NS) is "A" (low noise).
	The result of the error noise detection command (EN) is "0" (normal).
 Flashing green	When the power is turned ON, after initialization of the Hand-held Reader Writer is completed
	Communications with the Data Carrier are in progress.
 Lit red	A communications error with the Data Carrier has occurred.
	A CPU error has occurred.
	The battery low warning (End code: 7B) has occurred.
 Flashing red	A Data Carrier non-existent error has occurred.
	A communications error with the host device has occurred.
	The execution result of the noise detection command (NS) is "B" (high noise).
	The result of the error noise detection command (EN) is "1" (error).



After the operation indicator is lit or flashing for a certain time, it will turn OFF.

CHECK!

## •Activate Switch

When button commands (button commands, button auto commands) are used and the activate switch is pressed, communications with the Data Carrier will commence. (For details on button commands, refer to Section 3 Commands.)

## •Interface Connector

This is a USB interface with an A-series plug based on USB 1.1.



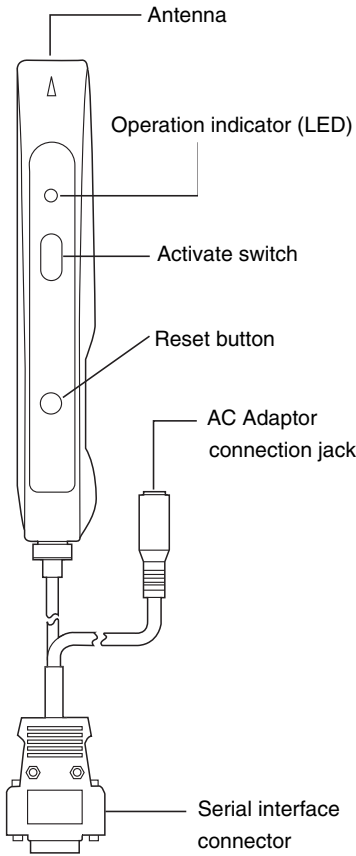

## •Antenna

To communicate with the Data Carrier, move the antenna head closer to it.

V600-CH1D-V2



•Operation Indicator (LED)

Display	Meaning
 Lit green	A command has been received from the host device.
	Communications with the Data Carrier have completed normally.
 Flashing green	<ul style="list-style-type: none"> <li>When the power is turned ON, after initialization of the Hand-held Reader Writer is completed</li> <li>When the power is turned ON and the reset button is pressed for two seconds or more (initialization stand-by mode).</li> </ul> Communications with the Data Carrier are in progress.
	A communications error with the Data Carrier has occurred.
 Lit red	A CPU error has occurred.
	The battery low warning (End code: 7B) has occurred.
	A Data Carrier non-existent error has occurred.
 Flashing red	A communications error with the host device has occurred.



After the operation indicator is lit or flashing for a certain time, it will turn OFF.

•Activate Switch

When button commands (button commands, button auto commands) are used and the activate switch is pressed, communications with the Data Carrier will commence. (For details on button commands, refer to Section 3 Commands.)

When the activate switch is pressed with the Hand-held Reader Writer in the initialization stand-by mode (with the green LED flashing) the function settings will be initialized.

•Reset Button

Press this button for two seconds or more when the power is first turned ON to put the Hand-held Reader Writer into the initialization stand-by mode.

•AC Adaptor Connection Jack

This is a connection jack for the V600-A22 AC.

•Serial Interface Connector

This is a serial interface with an RS-232C-compliant D-Sub 9-pin connector.



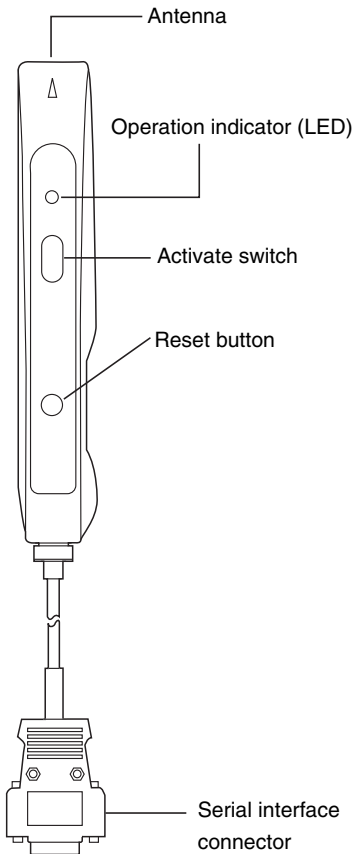

•Antenna

To communicate with the Data Carrier, move the antenna head closer to it.

V600-CH1D-PSI



•Operation Indicator (LED)

Display	Meaning
 Lit green	A command has been received from the host device.
	Communications with the Data Carrier have completed normally.
 Flashing green	<ul style="list-style-type: none"> <li>When the power is turned ON, after initialization of the Hand-held Reader Writer is completed</li> <li>When the power is turned ON and the reset button is pressed for two seconds or more (initialization stand-by mode).</li> </ul>
	Communications with the Data Carrier are in progress.
 Lit red	A communications error with the Data Carrier has occurred.
	A CPU error has occurred.
	The battery low warning (End code: 7B) has occurred.
 Flashing red	A Data Carrier non-existent error has occurred.
	A communications error with the host device has occurred.



After the operation indicator is lit or flashing for a certain time, it will turn OFF.

•Activate Switch

When button commands (button commands, button auto commands) are used and the activate switch is pressed, communications with the Data Carrier will commence. (For details on button commands, refer to Section 3 Commands.)

When the activate switch is pressed with the Hand-held Reader Writer in the initialization stand-by mode (with the green LED flashing) the function settings will be initialized.

•Reset Button

Press this button for two seconds or more when the power is first turned ON to put the Hand-held Reader Writer into the initialization stand-by mode.

•AC Adaptor Connection Jack

This is a connection jack for the V600-A22 AC.

•Serial Interface Connector

This is a serial interface with an RS-232C-compliant D-Sub 9-pin connector.

•Antenna

To communicate with the Data Carrier, move the antenna head closer to it.

# System Configuration

## V600-CHUD

The V600-CHUD Hand-held Reader Writer can communicate with host devices that have a USB interface such as personal computers.

### Host Devices

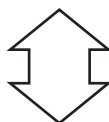
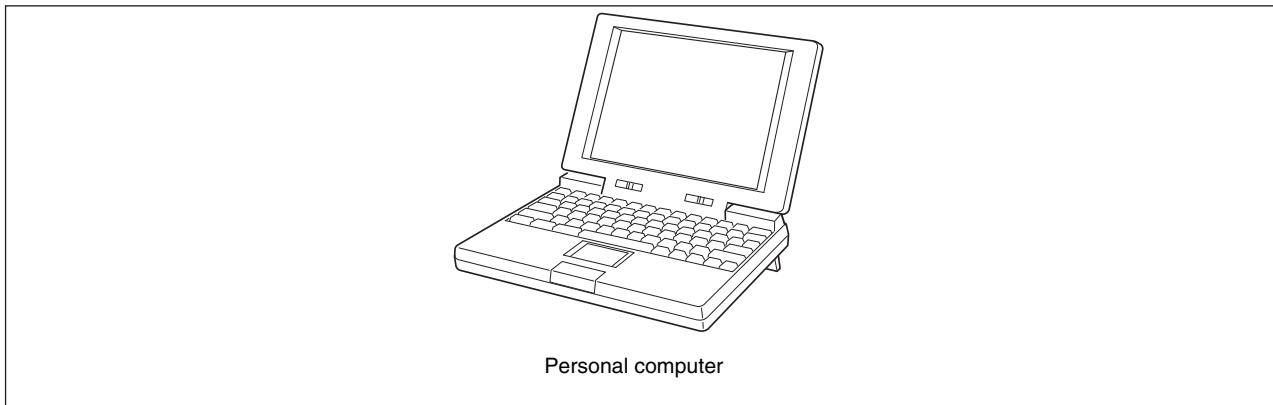

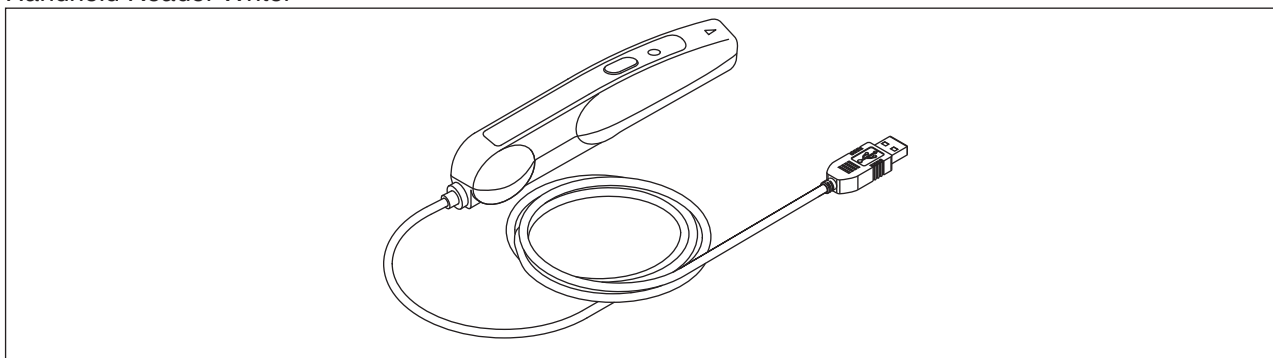

### Handheld Reader Writer

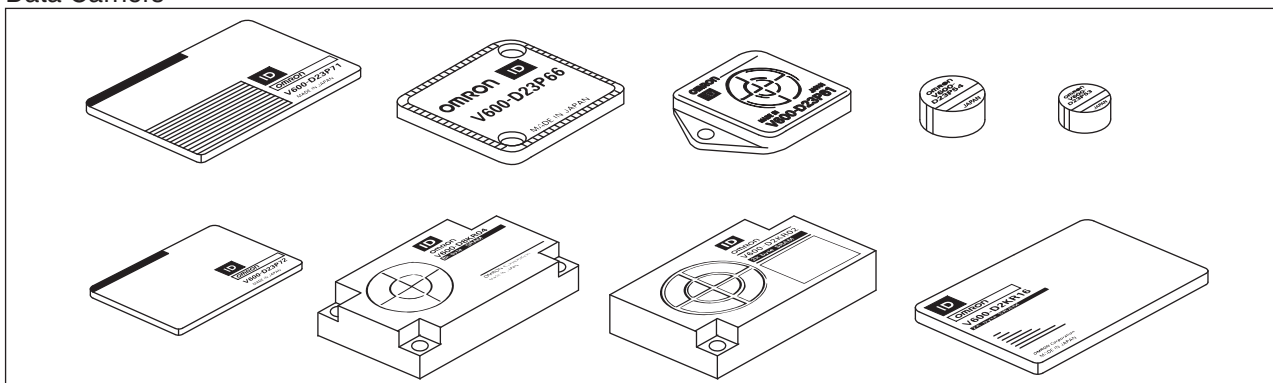

### Data Carriers



The V600-CHUD Hand-held Reader Writer can be used with any Data Carrier in the V600 Series.

 For details on Hand-held Reader Writer and Data Carrier models, refer to Section 6 Appendices.  
**CHECK!**  p.122, p.135



V600-CH1D-V2

A built-in RS-232C serial interface in the V600-CH1D-V2 Hand-held Reader Writer allows communications with personal computers and programmable controllers that are equipped with an RS-232C interface.

Host Devices

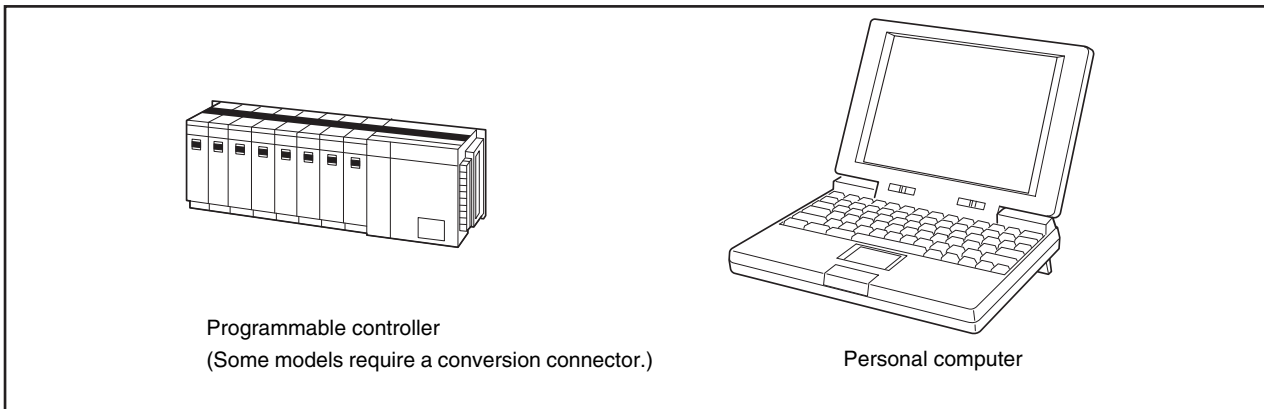

Hand-held Reader Writer

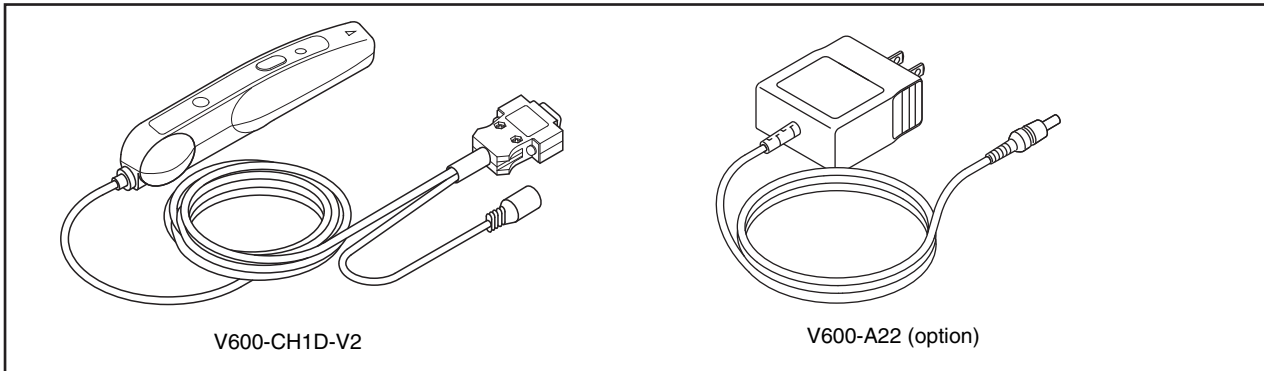

Data Carriers

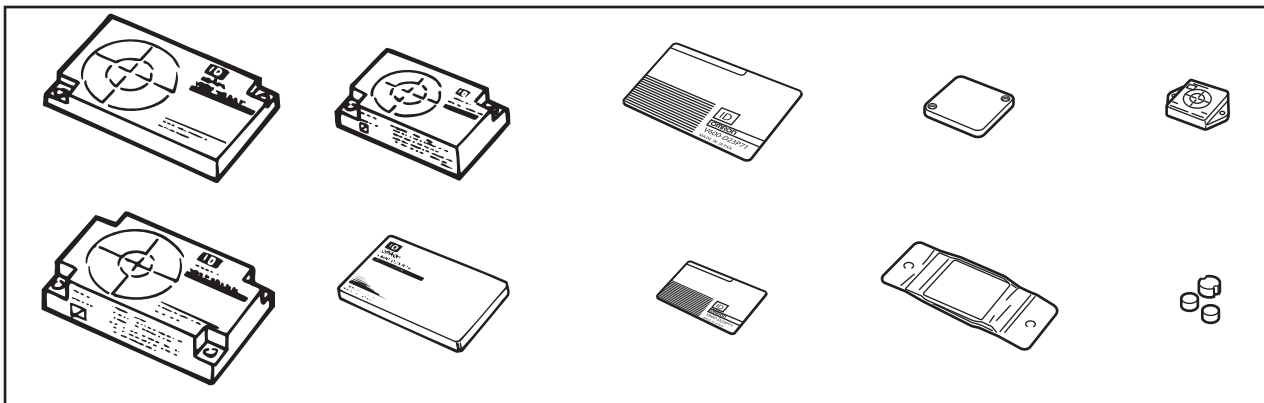

The V600-CH1D-V2 Hand-held Reader Writer can be used with any Data Carrier in the V600 Series.



For details on Hand-held Reader Writer and Data Carrier models, refer to Section 6 Appendices.



p.122, p.135

CHECK!

### V600-CH1D-PSI

A built-in RS-232C serial interface in the V600-CH1D-PSI Hand-held Reader Writer allows communications with personal computers and programmable controllers that are equipped with an RS-232C interface.

#### Host Devices

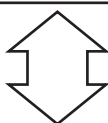
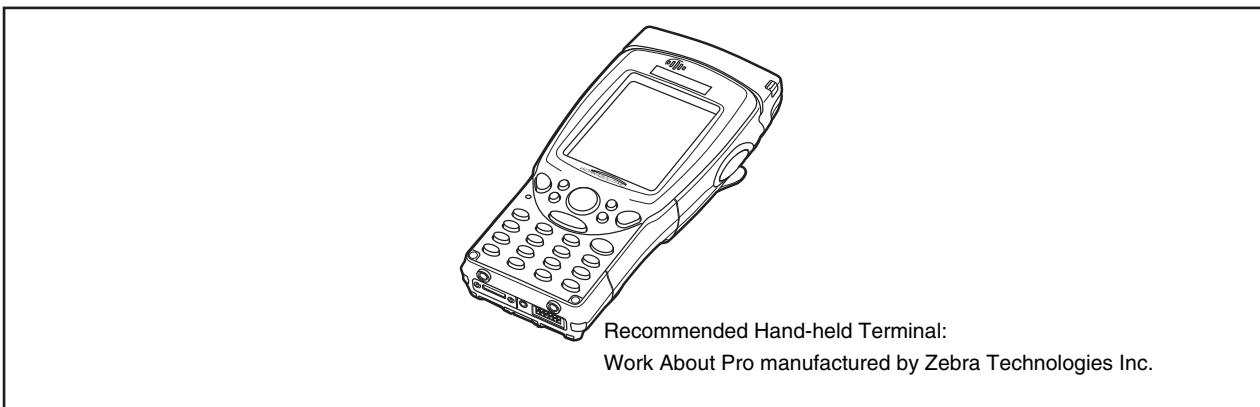

#### Hand-held Reader Writer

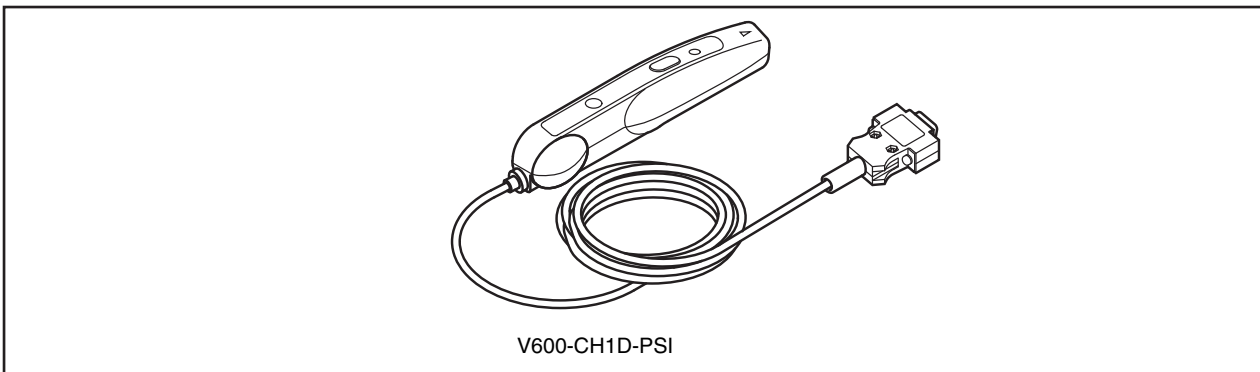

#### Data Carriers

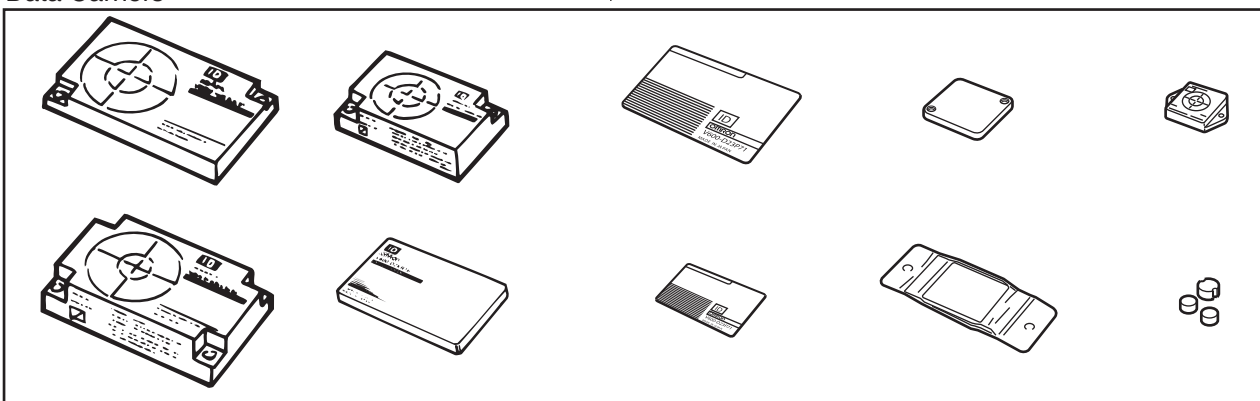

The V600-CH1D-PSI Hand-held Reader Writer can be used with any Data Carrier in the V600 Series.



For details on Hand-held Reader Writer and Data Carrier models, refer to Section 6 Appendices.

CHECK!



p.122, p.135

# Operation Flowchart

V600-CHUD

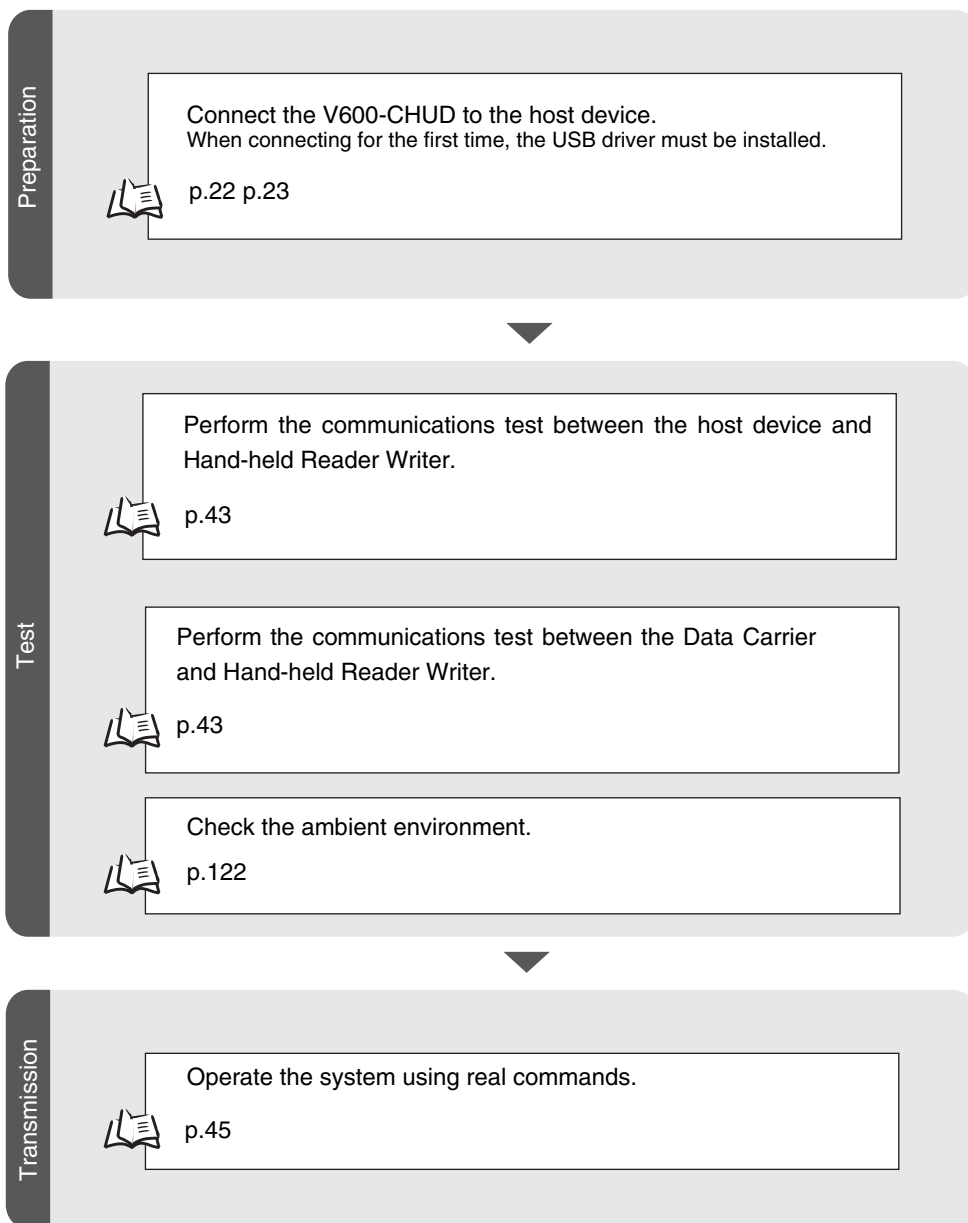

V600-CH1D-V2

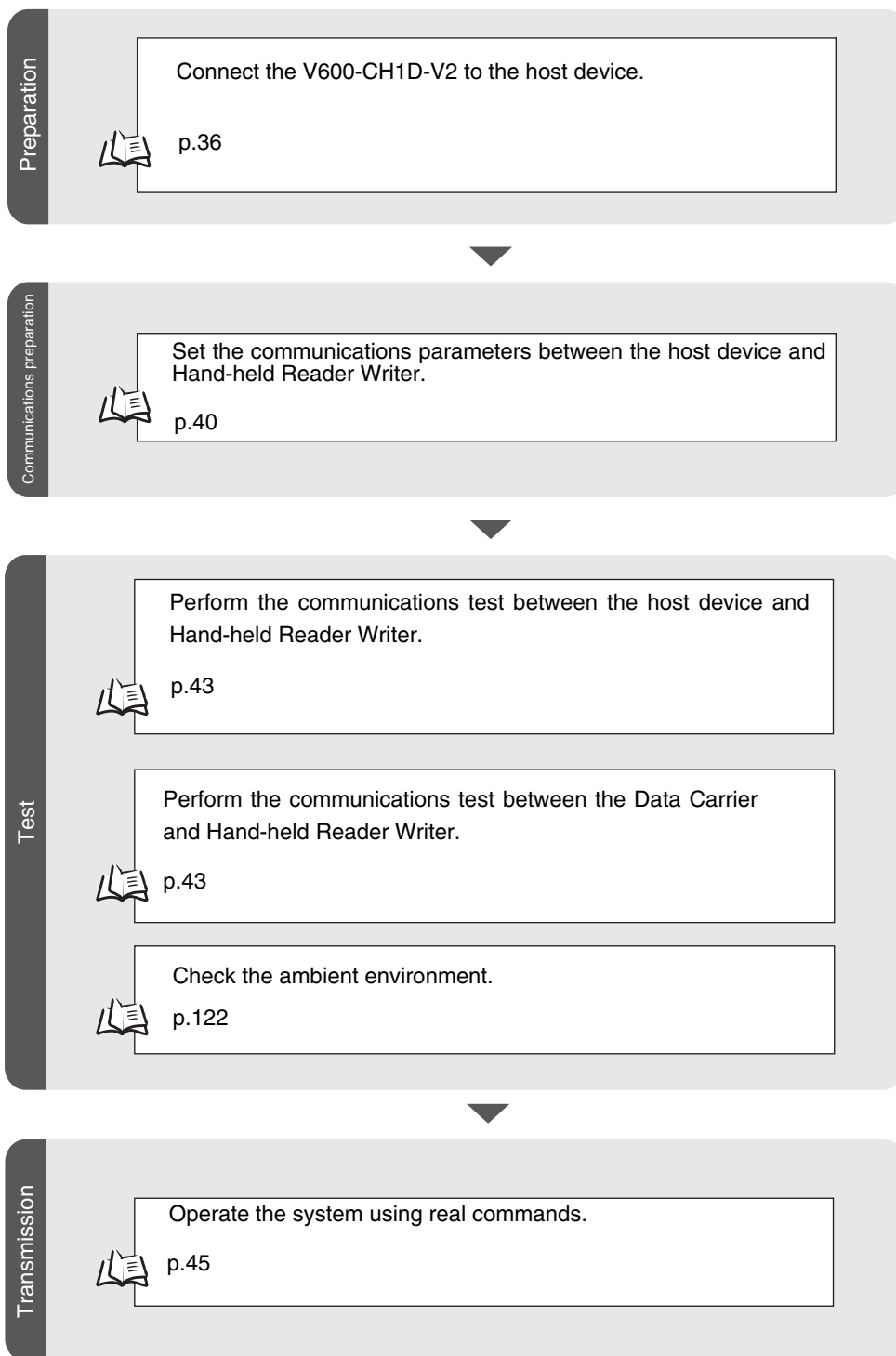

V600-CH1D-PSI

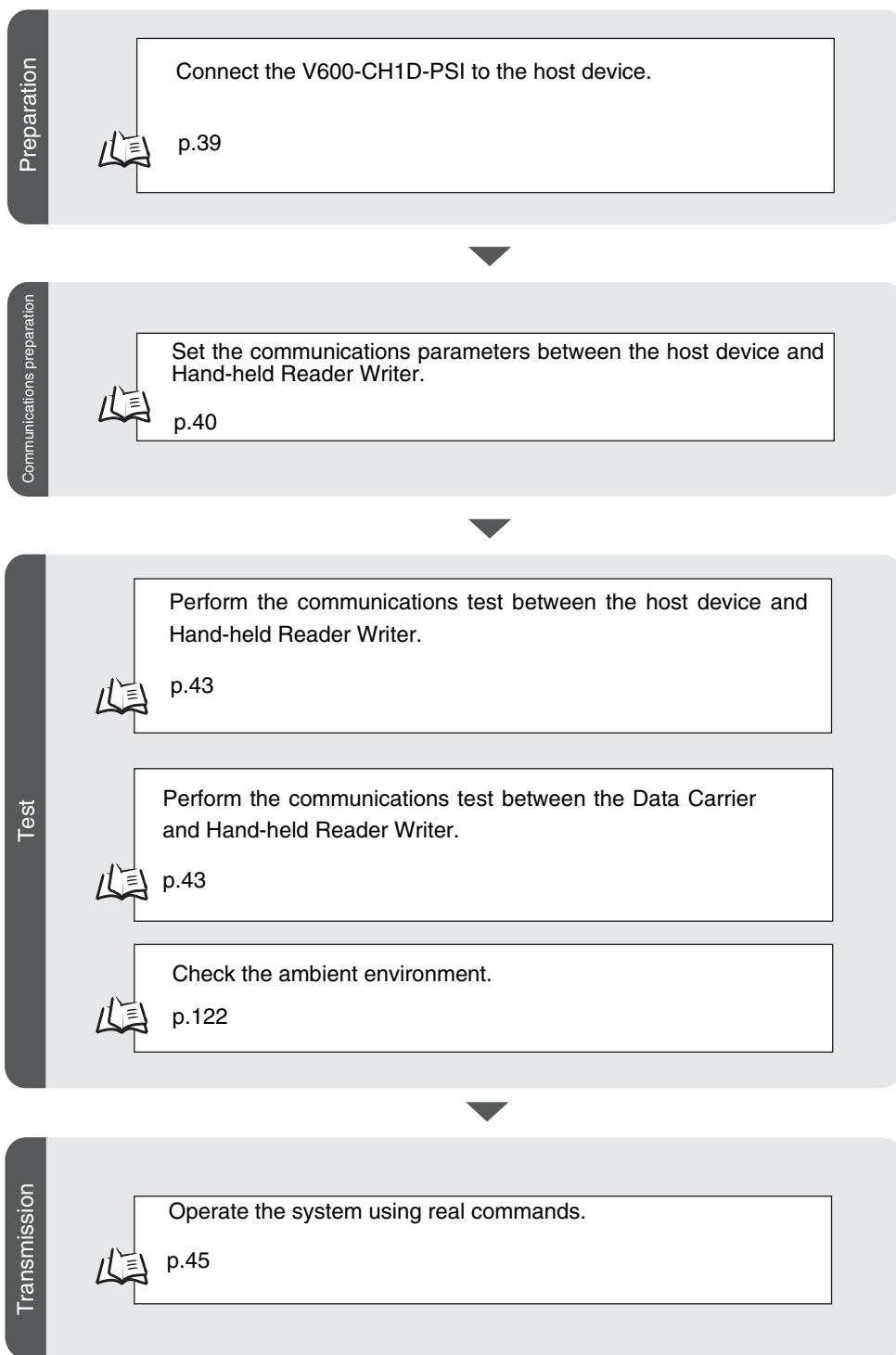

MEMO

## Section 2

# Communications Preparations

☒ V600-CHUD Communications Preparations	22
☒ V600-CH1D-V2 Communications Preparation	36
☒ V600-CH1D-PSI Communications Preparation	39
☒ Communications Test	42

# V600-CHUD Communications Preparations

## Connection

- Connecting the Cable

1. Connect the cable connector to the USB connector on the host device, making sure that the connector is oriented correctly and not inserted at an angle.

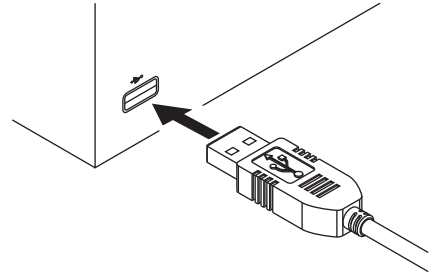

- Removing the Cable

1. Remove the cable.  
Close the software application at the host device and then pull out the connector in a straight line.



CHECK!

If the connector is removed while the software is running at the host device, operation may stop due to a software malfunction error.

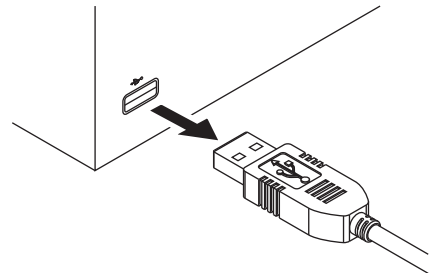



## Installing the USB Driver (V600-CHUD)

When connecting the Hand-held Reader Writer to the host device for the first time, the USB driver must be installed at the host device.

- **Downloading the USB Driver**

Download the USB Driver for the V680-CHUD from the web site.  
For details, ask your OMRON sales representative.

- **Install the USB Driver in the Personal Computer**

The V600-CHUD supports Windows 2000 and Windows XP operating systems. Install the driver in the host device following the procedure corresponding to the OS being used.  
Operation on other OS is not supported.

<Windows 2000>

1. Turn ON the power to the personal computer and start Windows 2000.

2. Connect the Hand-held Reader Writer to the personal computer.



For details on connection methods, refer to V600-CHUD Communications Preparations.

CHECK!  p.22

The following window will be displayed when the Hand-held Reader Writer is connected.



3. When the following window is displayed, click the **Next** Button.



4. Select **Search for a suitable driver for my device (recommended)** and then click the **Next** Button.



5. Select **Specify a location** and then click the **Next** Button.



6. Click the **Browse** Button, and select the folder in which the downloaded file RFID-Win2kcom.inf is saved.



7. Click the **Next** Button.



The following window will be displayed when software installation is completed.



8. Click the **Finish** Button.

## Checking Installation

Check that the driver is correctly installed.

1. Connect the Hand-held Reader Writer to the personal computer.

2. On the Start Menu, select **Settings - Control Panel - System**.

3. Select the **Device Manager** Button on the Hardware Tab Page.

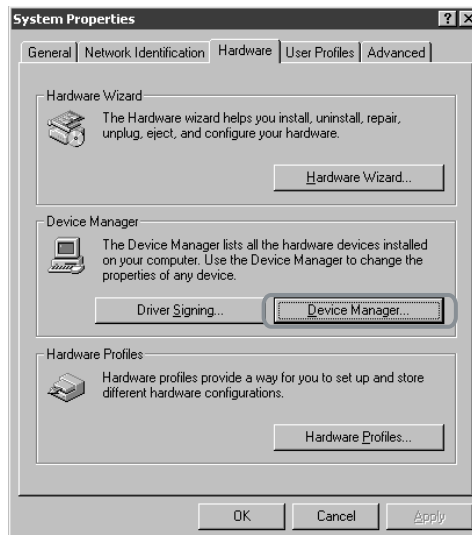

4. Select **Ports (COM & LPT)**, and check that *OMRON RFID USB COM* is displayed.  
The driver is correctly installed if this port is displayed.

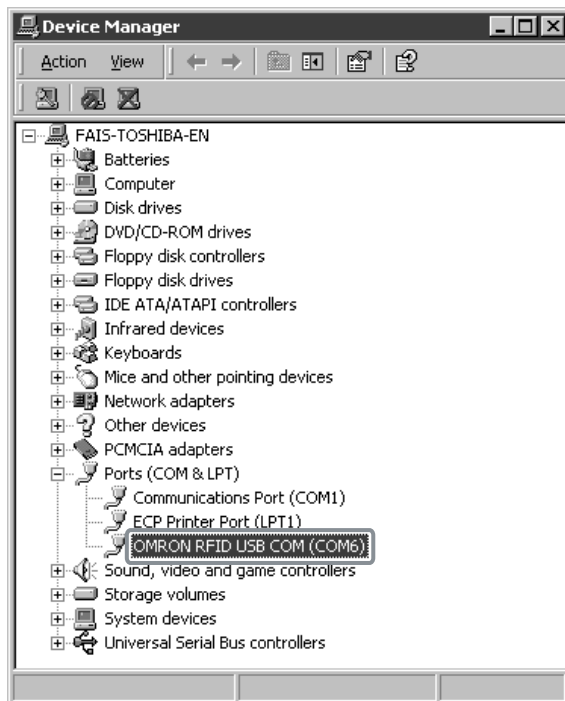

Communications with the Hand-held Reader Writer can be performed with the COM number displayed in parentheses after *OMRON RFID USB COM*.

<Windows XP>

1. Turn ON the power to the personal computer and start Windows XP.

2. Connect the Hand-held Reader Writer to the personal computer.



CHECK!



p.22

For details on connection methods, refer to V600-CHUD Communications Preparations.

Wait for the following window to be displayed.

3. When the following window is displayed, select ***Install from a list or specific location (Advanced)*** and click the **Next** Button.



- Click the **Browse** Button, and select the folder in which the downloaded file *RFID-Win2kcom.inf* is saved. Then click the **Next** Button.

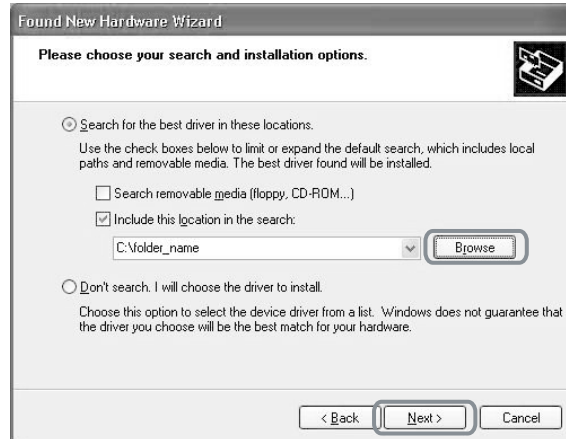

- Click the **Continue Anyway** Button.



When the following window is displayed, installation is completed.



- Click the **Finish** Button.

## Checking Installation

Check that the driver is correctly installed.

1. Connect the Hand-held Reader Writer to the personal computer.

2. On the **Start Menu**, select **Control Panel - System**.

3. Click the **Device Manager** Button in the Hardware Tab Page.

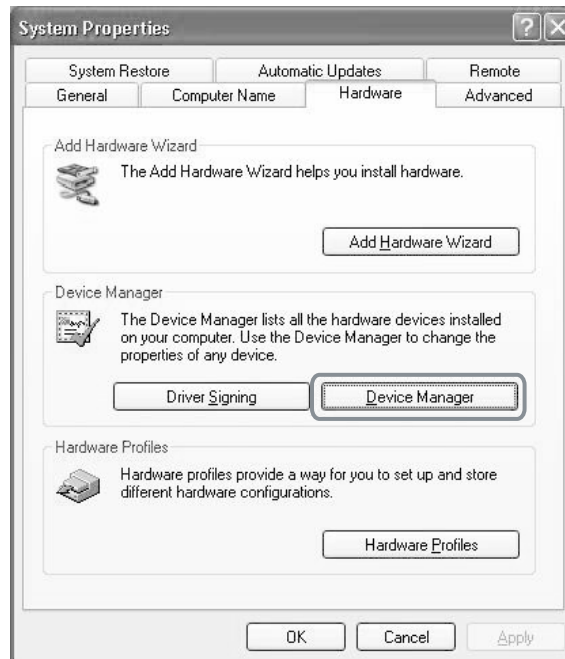



**4.** Select **Ports (COM & LPT)**, and check that **OMRON RFID USB COM** is displayed.

The driver is correctly installed if this port is displayed.

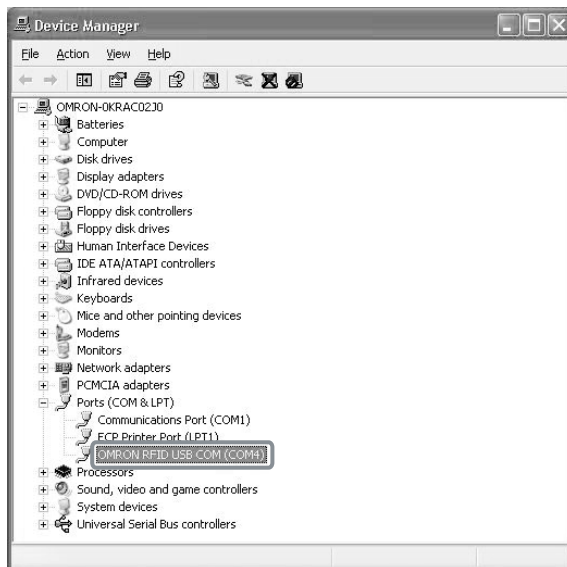

Communications with the Hand-held Reader Writer can be performed with the COM number displayed in parentheses after **OMRON RFID USB COM**.

<Windows Vista>

1. Turn ON the power to the personal computer and start Windows Vista.

2. Connect the Hand-held Reader Writer to the computer via USB.



For details on connection methods, refer to V600-CHUD Communications Preparations.

Wait for the following window to be displayed.

3. When the following window is displayed, select **Locate and install driver software (recommended)** Button.

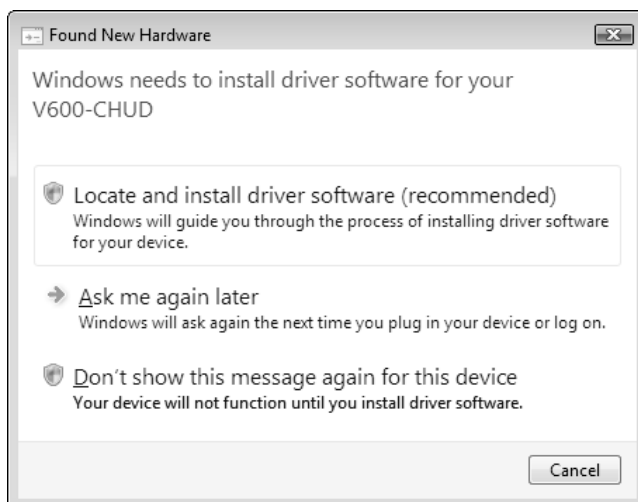

4. If the User Account Control Dialog Box is displayed, click the **Continue** Button.

5. If a dialog box appears for searching for software online, select the **Don't search online** Option. If this dialog box is not displayed, go to the next step.

6. When the following window is displayed, select ***I don't have the disc. Show me other options.*** Button.

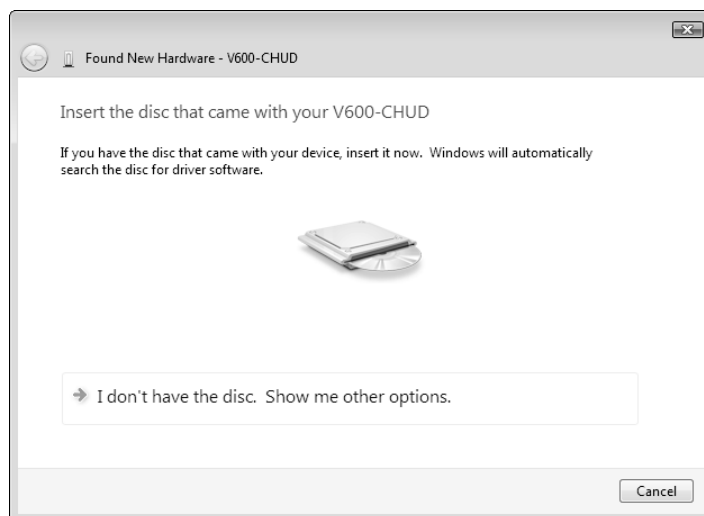

7. When the following window is displayed, select ***Browse my computer for driver software (advanced)*** Button.

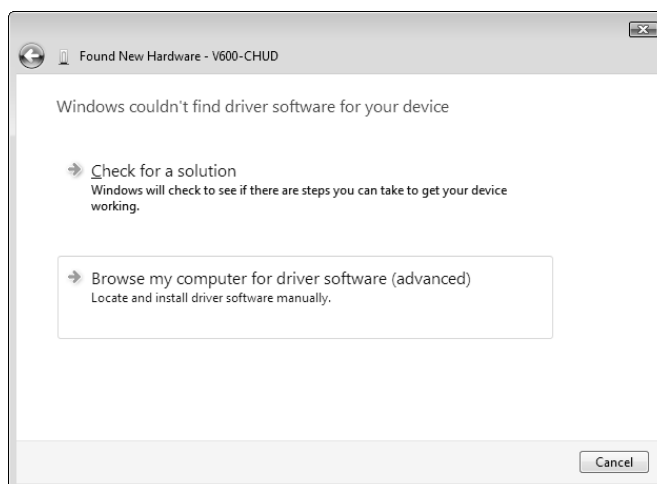

8. Click the **Browse** Button, and select the folder in which the downloaded file *V600\_CHUD\_200.inf* is saved. Then click the **Next** Button.

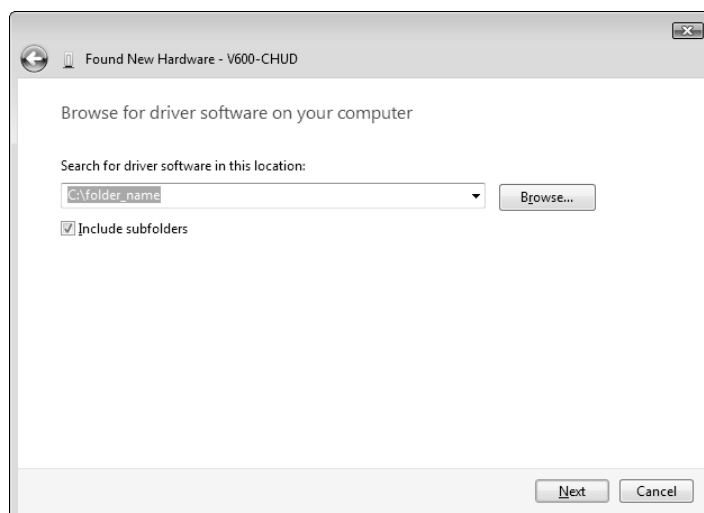

9. When the following window is displayed, select **Install this driver software anyway** Button.

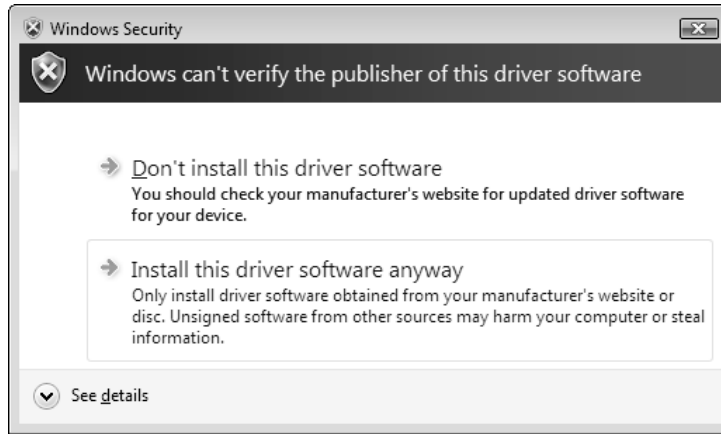

When the following window is displayed, installation is completed.

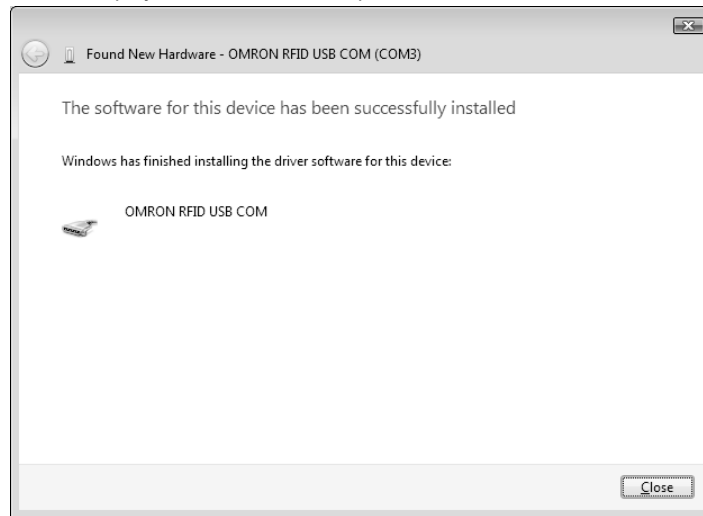

10. Click the **Close** Button.



The displays that actually appear depend on your computer environment.

## Checking Installation

Check that the driver is correctly installed.

1. Connect the Hand-held Reader Writer to the personal computer.

2. On the Start Menu, select **Control Panel - Performance and Maintenance**.

3. Click the **System** Icon.

4. Click the **Device Manager** Button.

5. Select **Ports (COM & LPT)**, and check that **OMRON RFID USB COM** is displayed.

The driver is correctly installed if this port is displayed.

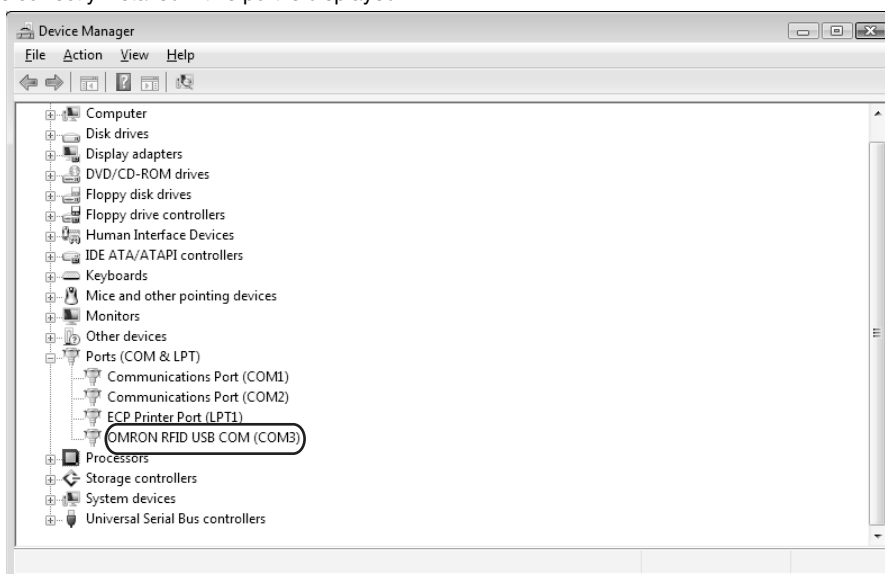

Communications with the Hand-held Reader Writer can be performed with the COM number displayed in parentheses after **OMRON RFID USB COM**.

## V600-CH1D-V2 Communications Preparation

### Pin Arrangement of the Host Device Interface Connector

V600-CH1D-V2

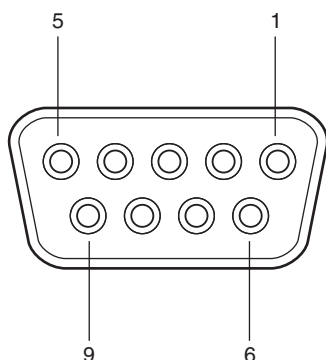

Pin No.	Signal	Code (See note.)	Signal direction
1	---		---
2	Receive data	RD	Hand-held Reader Writer to host device
3	Send data	SD	Host device to Hand-held Reader Writer
4	---	---	---
5	Signal ground	SG	---
6	Data set ready	DS	Hand-held Reader Writer to host device
7	Request send	RS	Loops inside connector
8	Enable send	CS	
9	---	---	---

**Note:** The names of signals at the host device are abbreviated with codes.

**Note:** For conversion to a 25-pin connector, the SGC-X9P/25P-2 manufactured by Sunhayato, or an equivalent, is recommended.

•Connection with the Host Device

Use the following procedure to connect the V600-CH1D-V2 to the host device.

**1.** Connect the V600-CH1D-V2 to the RS-232C interface of the host device.

•When connecting to an IBM PC/AT or compatible:

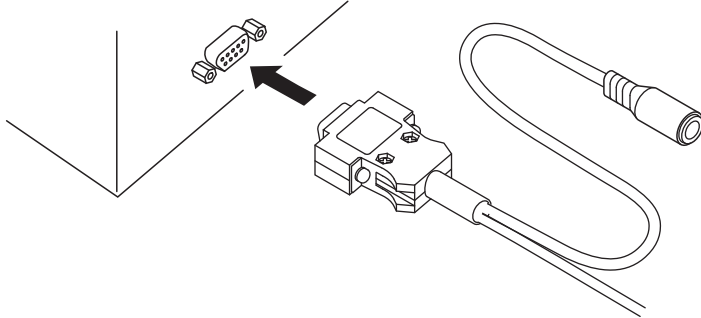

•When connecting to a PC9801 series computer (D-Sub 25-pin connector):

To convert from a 9-pin connector to a 25-pin connector, use an SGC-X9P25P-2 conversion connector manufactured by Sunhayato, or an equivalent product.

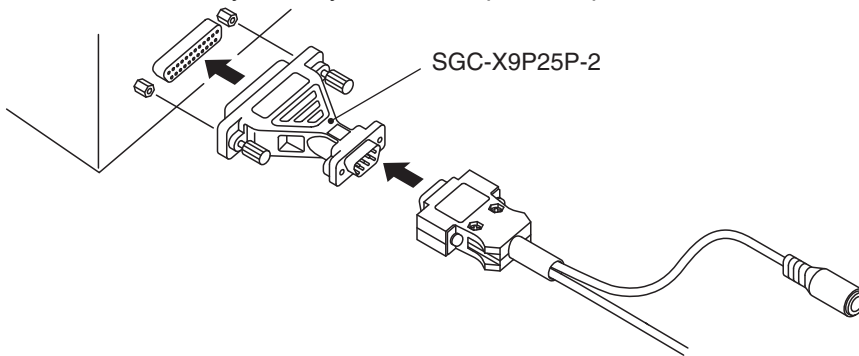

**2.** Connect the V600-A22 AC Adaptor to the V600-CH1D-V2.

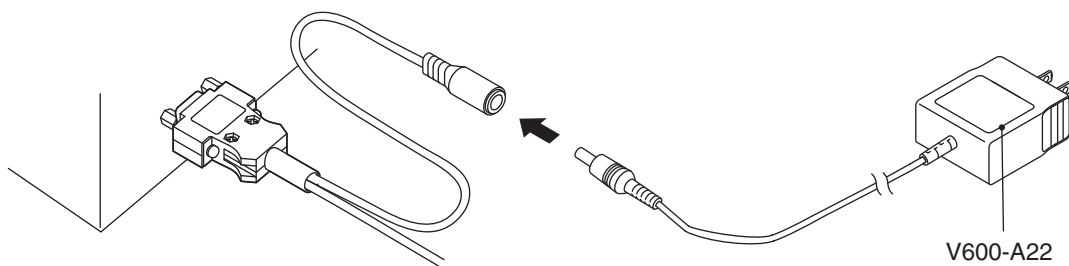

**3.** Plug the V600-A22 AC Adaptor into a 100- to 120-VAC power outlet.



- Do not use any AC adaptor other than the specified one (V600-A22).
- Using any AC adaptor other than the specified one may cause a malfunction, damage, or fire in the V600-CH1D-V2.
- Some host devices require a conversion connector.

When connecting to a CQM1, CJ1, CS1, etc.

Prepare a connection cable as shown in the connection examples below.

**Note:** Because both the V600-CH1D-V2 interface connector and the interface connector of the CQM1, CJ1, and CS1 are sockets, a conversion connector is necessary to connect them. Also, the pin arrangement of the CQM1, CJ1, and CS1 interface connector is different from the RS-232C pin arrangement of a personal computer.

V600-CH1D-V2

Pin No.	Signal
1	---
2	RD
3	SD
4	---
5	SG
6	DS
7	RS
8	CS
9	---

CQM1/CJ1/CS1

Pin No.	Signal
1	---
2	SD
3	RD
4	RS
5	CS
6	---
7	---
8	---
9	SG



# V600-CH1D-PSI Communications Preparation

## Pin Arrangement of the Host Device Interface Connector

V600-CH1D-PSI

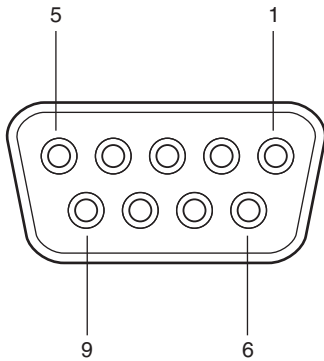

Pin No.	Signal	Code (See note.)	Signal direction
1	---		---
2	Receive data	RD	Hand-held Reader Writer to host device
3	Send data	SD	Host device to Hand-held Reader Writer
4	---	---	---
5	Signal ground	SG	---
6	Data set ready	DS	Hand-held Reader Writer to host device
7	Request send	RS	Loops inside connector
8	Enable send	CS	
9	5 VDC	---	Host device to Hand-held Reader/Writer

**Note:** The names of signals at the host device are abbreviated with codes.

### •Connection with the Host Device

Use the following procedure to connect the V600-CH1D-PSI to the host device.

1. Connect the V600-CH1D-PSI to the RS-232C interface of the host device.

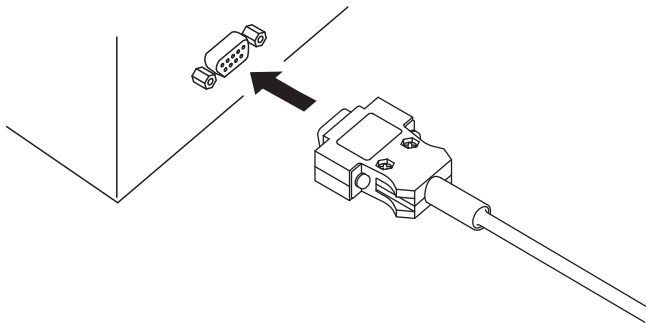

## Setting the Hand-held Reader Writer

### •Settings

The following settings are used to operate the Hand-held Reader Writer.

- Serial communications parameters (data transfer speed, parity check, stop bits).
- Basic function settings (Auto Command OFF and Normal Operation Output functions)

These settings can be changed by using a setting command from the host device. To operate the Hand-held Reader Writer with the new setting, the power must be turned OFF then ON again, or the ABORT command must be used.

### Serial Communications Parameters

The following are the settings related to serial communications. Use the COMMUNICATIONS CONDITIONS SETTING (TR) command.

Item	Contents
Baud rate (bps)	2400, 4,800, 9,600 (see note), 19,200, 38,400
Transmission code	7-unit ASCII 7* (see note) or 8-unit JIS 8
Parity check	Even parity* (see note)/odd parity/none
Stop bits	2* (see note)/1

**Note:** Items marked by an asterisk (\*) are set as the default when shipped from the factory.

### Basic Function Settings

The Auto Command OFF and Normal Operation Output functions can be set. Use the BASIC FUNCTIONS SETTING (FN) command

Item	Contents
Auto Command OFF function	Yes (1 minute)*, No
Normal Operation Output function	No*, Yes

**Note:** Items marked by an asterisk (\*) are set as the default when shipped from the factory.

### • Reading the Settings

Use the SET INFORMATION READ (UL) command to read the settings of the Hand-held Reader Writer. The information read by the SET INFORMATION READ command is set in the backup memory of the Hand-held Reader Writer. For this reason, care must be taken when the power is first turned ON after the settings have been changed because the operational settings of the Hand-held Reader Writer will be different.

### • Initializing the Settings

A setting command is used to set the Hand-held Reader Writer but if the communications parameters are not known or if the setting contents are damaged, it is possible that communications will no longer be possible with the host device. If this occurs, press both the reset button and the activate switch when turning ON the power. This will return all settings to the defaults set when the Hand-held Reader Writer was shipped from the factory, allowing communications with the host device again.

•Reset Procedure

---

- 1.** Turn ON the power while pressing the reset button.
- 2.** Keep the reset button depressed for two seconds or more. The green operation indicator will start flashing.
- 3.** With the green operation indicator flashing, remove your finger from the reset button and press the activate switch.
- 4.** When the activate switch is pressed, the operation indicator will stop flashing green. This indicates that all of the settings have been initialized.

**Note:** If the activate switch is not pressed within 30 seconds from the time that the operation indicator starts flashing green, the settings will not be initialized.

# Communications Test

## Test Run Procedure

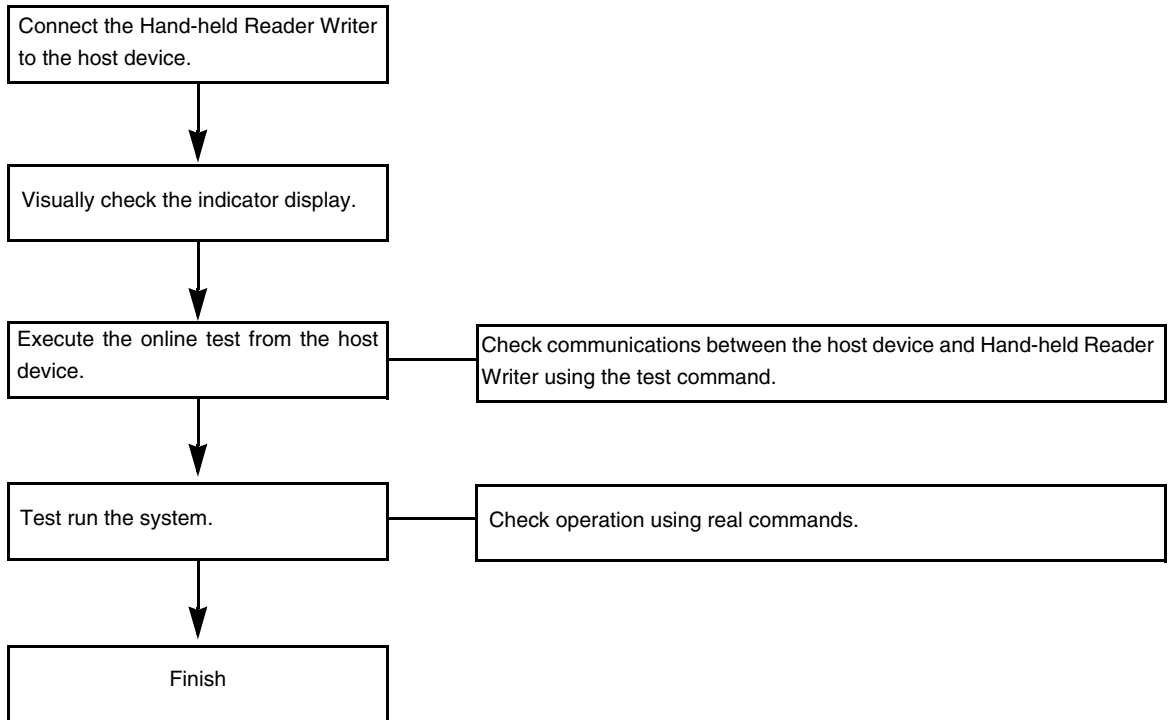

## Communications Test Between Host Device and Hand-held Reader Writer

Use the test command to test communications between the Hand-held Reader Writer and host device. Before performing communications with the Data Carrier, check the Hand-held Reader Writer connections and communications.

1. Send the test command from the host device.



For detail on the test command, refer to TEST (TS).



p.95

2. If communications is normal, the Hand-held Reader Writer will return the received data.



If a response is not returned, refer to Troubleshooting.



p.117

## Communications Test Between the Data Carrier and Hand-held Reader Writer

Use a real command to test communications between the Data Carrier and the Hand-held Reader Writer.

1. Send the auto read command (AR) from the host device.



For details on the auto read command, refer to AUTO READ (AR).



p.58

The Hand-held Reader Writer will communicate with the Data Carrier and the operation indicator will flash green.

2. Move the antenna section of the Hand-held Reader Writer close to the Data Carrier.

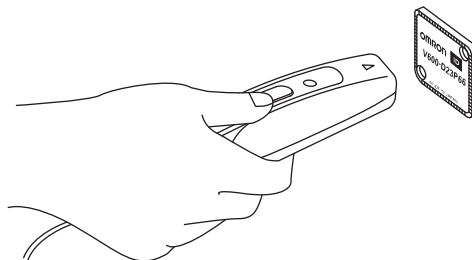

The Hand-held Reader Writer will read the data in the Data Carrier when the Hand-held Reader Writer moves within the communications range. As a result, the operation indicator will be light green and then turn OFF.

MEMO

## Section 3

# Commands

☒ Communications with the Data Carrier	46
☒ Command and Response Format	50
☒ Communications Commands	54
☒ Communications Subcommands	94
☒ Host Commands	95
☒ Controller Control Commands	96
☒ Other Commands	100
☒ End code List	101

# Communications with the Data Carrier

There are 4 types of commands for communicating with the Data Carrier using the Hand-held Reader Writer.

- Normal commands
- Button commands
- Auto commands
- Button auto commands

## Normal Commands

Normal commands are sent from the host device for communications with the Data Carrier, after the antenna end of the Hand-held Reader Writer has been moved close to the Data Carrier.

1. Move the antenna end of the Hand-held Reader Writer close to the Data Carrier.

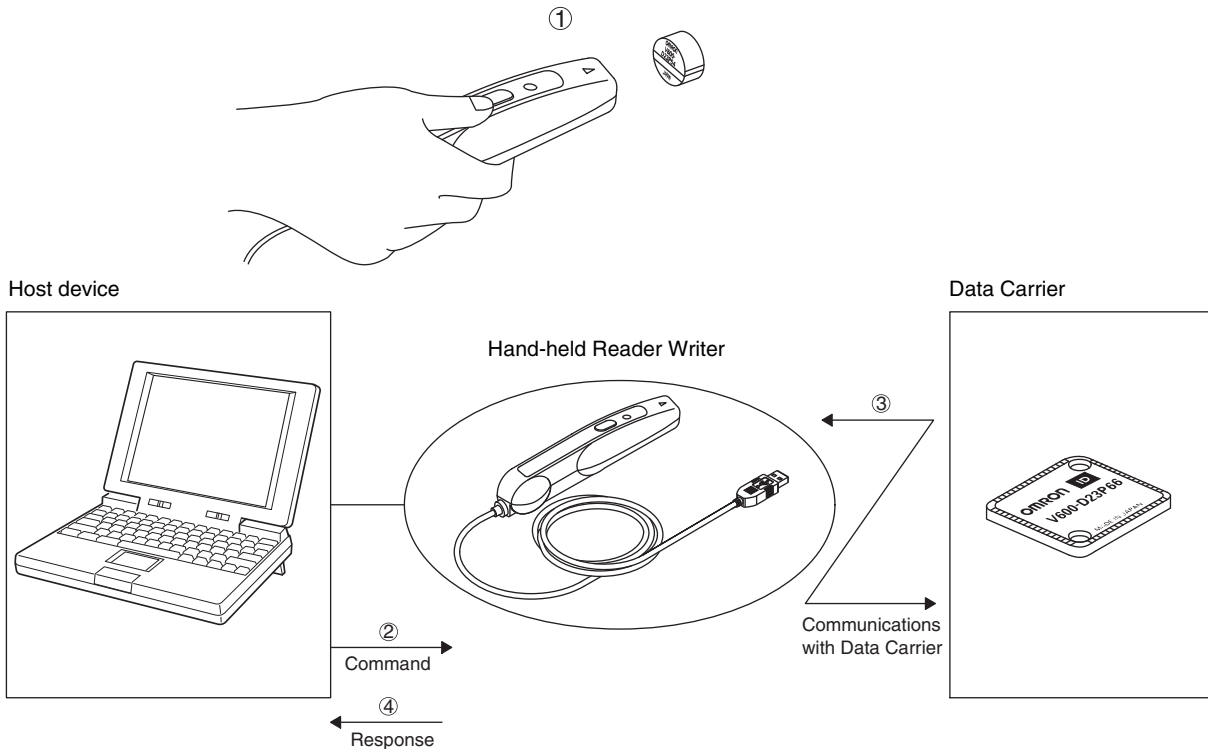

2. Commands are sent from the host device to the Hand-held Reader Writer.
3. The Hand-held Reader Writer communicates with the Data Carrier.
4. A response is returned from the Hand-held Reader Writer to the host device.

If communications are normal, the operation indicator (LED) lights green and then turns OFF.

If the Data Carrier is not detected within the Hand-held Reader Writer's communication area when the command is sent from the host device, a Data Carrier Non-existent Error will occur.

At this time, the operation indicator will flash red.



## Button Commands

Button commands used to perform communications with the Data Carrier are activated when the activate switch is pressed after commands are sent from the host device, and the antenna end of the Hand-held Reader Writer has been moved close to the Data Carrier.

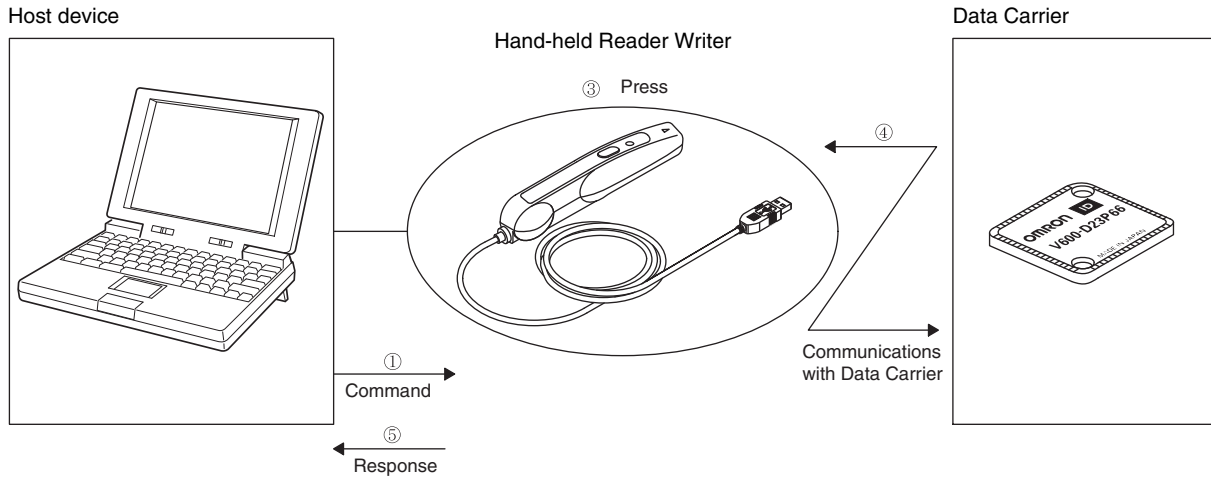

1. A command is sent from the host device to the Hand-held Reader Writer. As a result, the operation indicator will light green.
2. Move the antenna end of the Hand-held Reader Writer close to the Data Carrier.

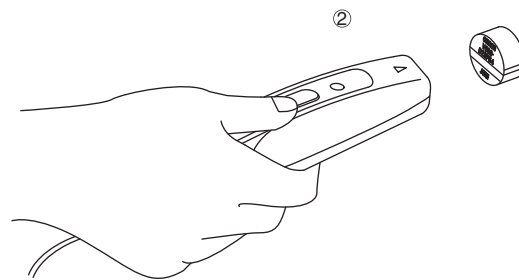

3. Press the Hand-held Reader Writer activate switch.
4. The Hand-held Reader Writer communicates with the Data Carrier.
5. A response is returned to the host device from the Hand-held Reader Writer.

If communications are normal, the operation indicator (LED) lights green and then turns OFF.

If the Data Carrier is not detected within the Hand-held Reader Writer's communication area when the activate switch is pressed, a Data Carrier Non-existent Error will occur.

At this time, the operation indicator will flash red.

## Auto Commands

Auto commands can execute communications with the Data Carrier when the antenna is moved near the front of the Data Carrier after a command is sent from the host device.

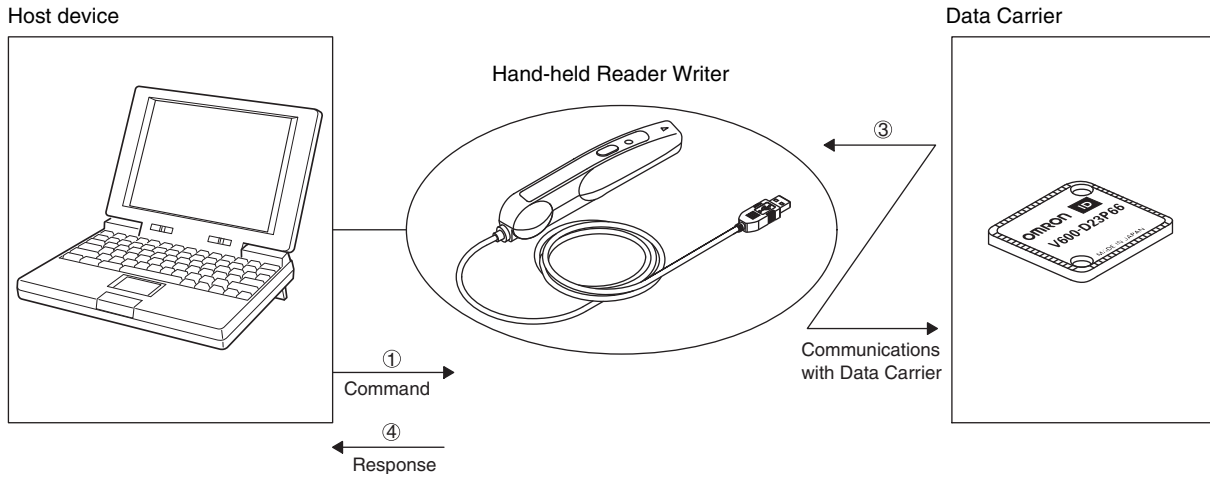

1. A command is sent from the host device to the Hand-held Reader Writer.
2. The Hand-held Reader Writer enters the communication stand-by state with the Data Carrier, and the operation indicator (LED) flashes green.



If the Data Carrier is not detected within one minute of sending the command, a timeout will occur and a Data Carrier Non-existent Error will occur. As a result, the operation indicator will flash red.

3. Communications with the Data Carrier are performed when the antenna end of the Hand-held Reader Writer is moved near the Data Carrier.

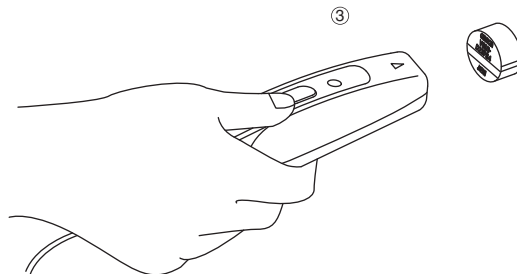

4. A response is returned from the Hand-held Reader Writer to the host device.  
If communications end normally, the operation indicator (LED) lights green and then turns OFF.

## Button Auto Commands

Button auto commands execute auto commands after a command is sent from the host device and the activate switch of the Hand-held Reader Writer is pressed.

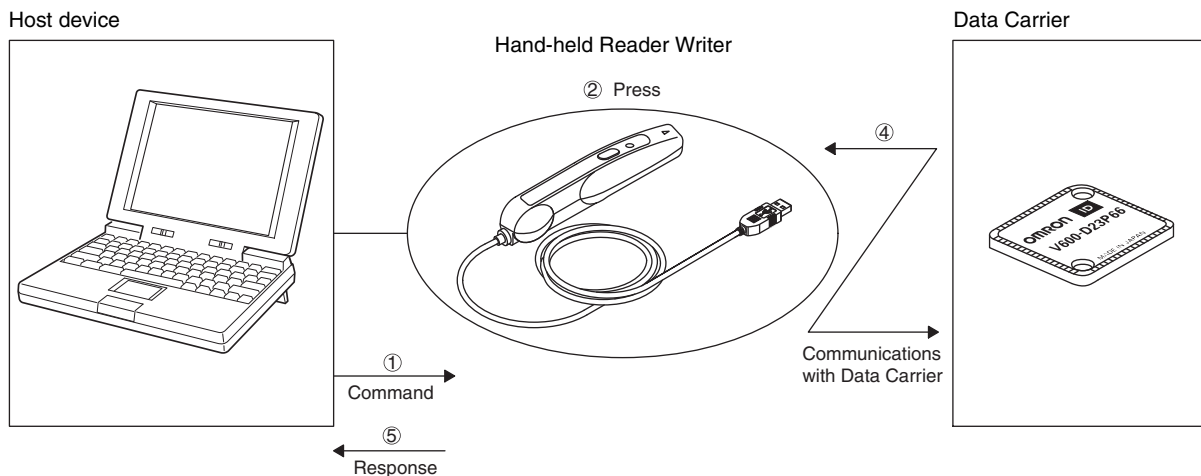

1. A command is sent from the host device to the Hand-held Reader Writer.
2. Press the Hand-held Reader Writer activate switch.
3. The Hand-held Reader Writer enters the communication stand-by state with the Data Carrier, and the operation indicator (LED) flashes green.



CHECK!

If the Data Carrier is not detected within one minute of sending the command, a timeout will occur and a Data Carrier Non-existent Error will occur. As a result, the operation indicator will flash red.

4. Communications with the Data Carrier are performed when the antenna end of the Hand-held Reader Writer is moved near the Data Carrier.

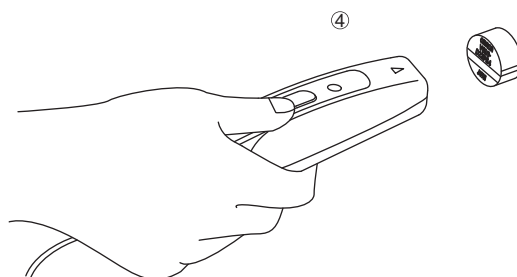

5. A response is returned from the Hand-held Reader Writer to the host device.  
If communications end normally, the operation indicator (LED) lights green and then turns OFF.

# Command and Response Format

The format of commands sent between the host computer and the Hand-held Reader Writer and responses returned from the Hand-held Reader Writer to the host computer is shown below. The command and response both consist of a single frame. The frame (including the terminator) consists of up to 4,106 characters for commands and 4,102 characters for responses.

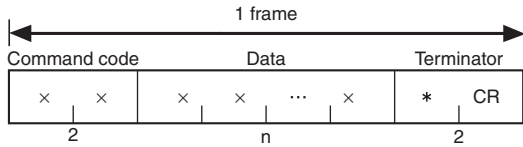

Name	Description
Command code	Command: Contains the two-character code (see page p.52). Response: Contains the same code that was sent with the command.
Data	Contains the details of the command and response, as follows: <ul style="list-style-type: none"> <li>•ASCII/hexadecimal code specification, processing specification, mode specification</li> <li>•Processing area number specification</li> <li>•Processing start address</li> <li>•Number of bytes to be read, write data</li> </ul>
Terminator	Indicates end of command/response.

## Specifying Data Code

Whether the read or write data is treated as an ASCII (or JIS 8) code or hexadecimal code is specified in a command.

### •ASCII (JIS 8 Code)

•One character of ASCII or JIS 8 code data occupies 1 byte (1 address) of the Data Carrier memory.

### •Example of Specifying ASCII Code

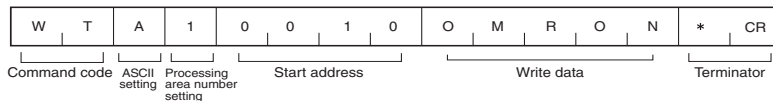

### •Data Carrier

Address			
0010	4	F	"O"
0011	4	D	"M"
0012	5	2	"R"
0013	4	F	"O"
0014	4	E	"N"

•Hexadecimal Code

- One character is treated as a hexadecimal number. Therefore, only numerals 0 through 9 and A to F can be accepted.
- Two characters of data occupy 1 byte (1 address) of the Data Carrier memory. Therefore, specify data in 2-character units (in even numbers) when using a WRITE command. If an odd number of characters is specified by mistake, an error will occur.

•Example of Specifying Hexadecimal Code

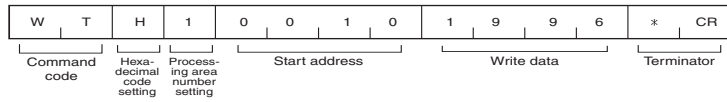

•Data Carrier

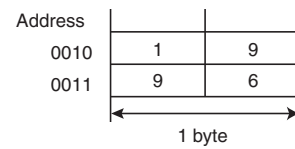

## Command List

Commands can be classified into four major types.

### •Communications Commands

The following commands are used for communications with the Data Carrier.

Command code	Command name	Function	Page
RD	READ	Reads memory data from the Data Carrier.	p.54
WT	WRITE	Writes data to the memory of the Data Carrier.	p.56
AR	AUTO READ	Reads data from the Data Carrier when the Data Carrier is within the communications area.	p.58
AW	AUTO WRITE	Writes data to the memory of the Data Carrier when the Data Carrier is within the communications area.	p.60
BR	BUTTON READ	Reads data from the memory of the Data Carrier when the activate switch is pressed.	p.62
BW	BUTTON WRITE	Writes data to the memory of the Data Carrier when the activate switch is pressed.	p.64
UR	BUTTON AUTO READ	Reads data from the Data Carrier when the Data Carrier enters the communications area after the activate switch is pressed.	p.66
UW	BUTTON AUTO WRITE	Writes data to the memory of the Data Carrier when the Data Carrier enters the communications area after the activate switch is pressed.	p.68
RC	COPY READ	Reads data to be copied using the COPY WRITE command from the Data Carrier.	p.70
WC	COPY WRITE	Writes the data read using the COPY READ command to the Data Carrier.	p.71
XR	EXPANSION DIVIDED READ	Divides and reads up to 2 Kbytes of data from the Data Carrier.	p.72
XW	EXPANSION DIVIDED WRITE	Divides and writes up to 2 Kbytes of data to the Data Carrier.	p.74
NR	EXPANSION DIVIDED AUTO READ	Divides and reads up to 2 Kbytes of data from the Data Carrier when the Data Carrier enters the communications area.	p.76
NW	EXPANSION DIVIDED AUTO WRITE	Divides and writes up to 2 Kbytes of data to the Data Carrier when the Data Carrier enters the communications area.	p.78
rd	EXPANSION BATCH READ	Reads up to 2 Kbytes of data from the Data Carrier in a batch.	p.80
wt	EXPANSION BATCH WRITE	Writes up to 2 Kbytes of data to the Data Carrier in a batch.	p.81
ar	EXPANSION BATCH AUTO READ	Reads up to 2 Kbytes of data from the Data Carrier in a batch when the Data Carrier enters the communications area.	p.82
aw	EXPANSION BATCH AUTO WRITE	Writes up to 2 Kbytes of data to the Data Carrier in a batch when the Data Carrier enters the communications area.	p.83
br	EXPANSION BATCH BUTTON READ	Reads up to 2 Kbytes of data from the Data Carrier in a batch after the activate switch is pressed.	p.84
bw	EXPANSION BATCH BUTTON WRITE	Writes up to 2 Kbytes of data to the Data Carrier in a batch after the activate switch is pressed.	p.85
ur	EXPANSION BATCH BUTTON AUTO READ	Reads up to 2 Kbytes of data from the Data Carrier in a batch when the Data Carrier enters the communications area after the activate switch is pressed.	p.86

Command code	Command name	Function	Page
uw	EXPANSION BATCH BUTTON AUTO WRITE	Writes up to 2 Kbytes of data to the Data Carrier in a batch when the Data Carrier enters the communications area after the activate switch is pressed.	p.87
CW	CALCULATION WRITE	Writes the calculation results for the memory data to the Data Carrier.	p.88
FL	FILL	Writes data for the specified number of write bytes beginning from the write start address specified in the command.	p.89
fl	EXPANSION BATCH FILL	Writes data for the specified number of write bytes beginning from the write start address specified in the command. Up to 2 Kbytes of data can be written in a batch.	p.91
MDC/K	DATA CHECK	Calculates or compares memory check codes in the Data Carrier.	p.92
MDS	OVERWRITE COUNT CONTROL	Controls the number of overwrites for EEPROM Data Carriers.	p.93

### •Communications Subcommands

These commands are used to cancel command execution.

Command code	Command name	Function	Page
AA	COMMAND PRO- CESSING TERMI- NATE	Forcedly ends communications with the Data Carrier.	p.94

### •Host Commands

These commands are used to test communications between the Hand-held Reader Writer and host device.

Command code	Command name	Function	Page
TS	TEST	Confirms the communications status between the Hand-held Reader Writer and host device. The data sent from the host device is returned as is.	p.95
VS	VERSION READ	Reads the Hand-held Reader Writer's model information, software version and software creation date.	p.95

### •Controller Control Commands

These commands are used to reset the Controller or set serial communications.

Command code	Command name	Function	Page
XZ	ABORT	Resets the Controller.	p.96
TR	COMMUNICA- TIONS CONDI- TIONS SETTING	Sets communications parameters for communications with the host device.	p.97
FN	BASIC FUNC- TIONS SETTING	Sets the Specify Auto Command OFF function and Specify Normal Operation Output function.	p.98
UL	SET INFORMA- TION READ	Reads the settings data for the Hand-held Reader Writer.	p.99

# Communications Commands

Details of communications commands used to communicate with the Data Carrier are provided here.

## READ (RD)

This command reads data from the Data Carrier. If the Data Carrier is not in the communications area, an error response (end code: 72 = Data Carrier non-existent) will be returned.

Command

Processing area number: 1

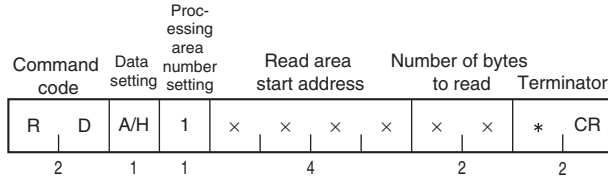

Processing area number: 2

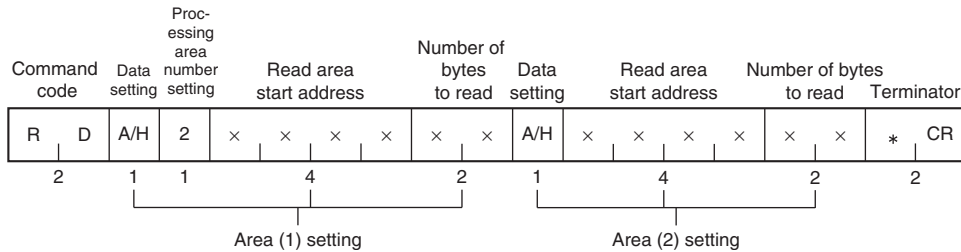

Data setting	<p>Sets the code format used to send responses for read data.</p> <p>A: ASCII H: Hexadecimal code</p> <p>When multiple processing areas are used, ASCII and hexadecimal code can be specified at the same time within a single command frame.</p>
Processing area number setting	<p>Specifies the processing area number.</p> <p>Setting range: 1 to 9, A (A = 10)</p>
Read area start address	<p>Specifies the start address of the area to be read from the Data Carrier in 4-digit hexadecimal code.</p> <p>Setting range: 0000h to 1FFFh</p> <p>When multiple processing areas are used, specify the areas in order starting from the smallest address. The same area cannot be specified twice.</p>
Number of bytes to read	<p>Specifies the number of bytes to be read from the Data Carrier in 2-digit hexadecimal code. The maximum number of bytes that can be read at one time is 256 bytes, as follows:</p> <ul style="list-style-type: none"> <li>•ASCII: 256 bytes (256 characters)</li> <li>•Hexadecimal code: 256 bytes (512 characters)</li> </ul> <p>Setting range: 00h to FFh (00 = 256 bytes)</p> <p>When multiple processing areas are used, set so that the total number of bytes from all areas to be read is within 256 bytes, as follows:</p> <p>Area (1) bytes +...+ Area (N) bytes ≤ 256 bytes</p>



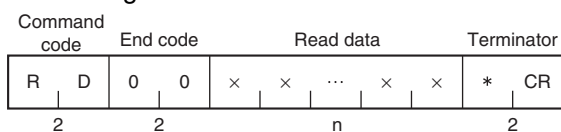

Response

Processing Area Number: 1

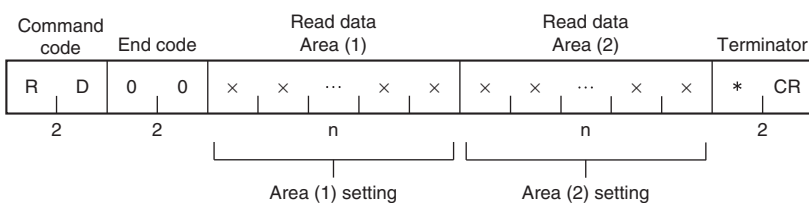

Processing Area Number: 2



End code	<p>Indicates the execution result for the command. The end code 00 indicates normal completion.</p> <p>For details on end codes, refer to <i>End code List</i>.  p.101</p>
Read data	<p>Specifies the data read from the Data Carrier. The characters in ASCII indicate the number of read bytes and the characters in hexadecimal code indicate the number of read bytes x 2.</p>

## WRITE (WT)

This command writes data to the Data Carrier. If the Data Carrier is not in the communications area, an error response (end code: 72 = Data Carrier non-existent) will be returned.

Command

Processing Area Number: 1

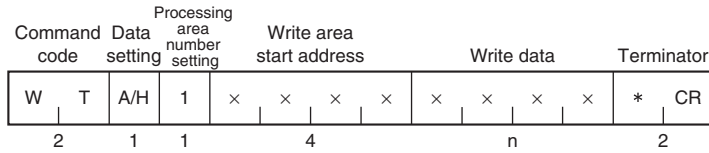

Processing Area Number: 2

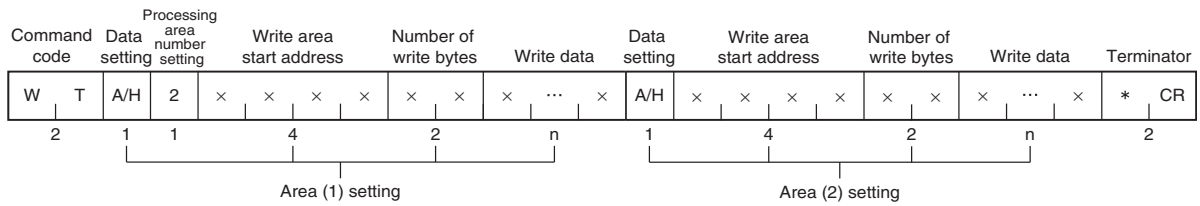

Data setting	<p>Sets the code format used to send responses for read data.</p> <p>A: ASCII H: Hexadecimal code</p> <p>When multiple processing areas are used, ASCII and hexadecimal code can be specified at the same time within a single command frame.</p>
Processing area number setting	<p>Specifies the processing area number.</p> <p>Setting range: 1 to 9, A (A = 10)</p>
Write area start address	<p>Specifies the start address of the area in the Data Carrier to be written to in 4-digit hexadecimal code.</p> <p>Setting range: 0000h to 1FFFh</p> <p>When multiple processing areas are used, specify the areas in order starting from the smallest address. The same area cannot be specified twice.</p>
Number of write bytes	<p>When multiple processing areas are used, specifies the number of bytes to be written to the Data Carrier in 2-digit hexadecimal code. The maximum number of bytes that can be written at one time is 256 bytes, as follows:</p> <ul style="list-style-type: none"> <li>• ASCII: 256 bytes (256 characters)</li> <li>• Hexadecimal code: 256 bytes (512 characters)</li> </ul> <p>Setting range: 01h to FFh</p> <p>When multiple processing areas are used, set so that the total number of bytes to be written for all areas is within 256 bytes, as follows: Area (1) bytes + ... + Area (N) bytes ≤ 256 bytes</p>
Write data	<p>Specifies the write data from the Data Carrier.</p> <p>The characters in ASCII indicate the number of write bytes and the characters in hexadecimal code indicate the number of write bytes x 2.</p>

Response

Command  
code    End code    Terminator

W	T	0	0	*	CR
2		2		2	

End code	<p>Indicates the execution result for the command. The end code 00 indicates normal completion.</p> <p>For details on end codes, refer to <i>End code List</i>.   p.101</p>
----------	--

## AUTO READ (AR)

This command reads data from the Data Carrier when the Data Carrier enters the communications area. The Hand-held Reader Writer responds when the communication between the Hand-held Reader Writer and Data Carrier has ended.

Command

### Processing Area Number: 1

Command code	Data setting	Processing area number setting	Read area start address	Number of read bytes	Terminator
A R	A/H	1	x x x x	x x	* CR
2	1	1	4	2	2

### Processing Area Number: 2

Command code	Data setting	Processing area number setting	Read area start address	Number of Data read bytes setting	Read area start address	Number of read bytes	Terminator
A R	A/H	2	x x x x	x x	A/H x x x x	x x	* CR
2	1	1	4	2	1	4	2
			Area (1) setting		Area (2) setting		

Data setting	Specifies the code format used to send responses for read data. A: ASCII H: Hexadecimal code  When multiple processing areas are used, ASCII and hexadecimal code can be specified at the same time within a single command frame.
Processing area number setting	Specifies the processing area number. Setting range: 1 to 9, A (A = 10)
Read area start address	Specifies the start address of the area in the Data Carrier to be read from in 4-digit hexadecimal code. Setting range: 0000h to 1FFFh  When multiple processing areas are used, specify the areas in order starting from the smallest address. The same area cannot be specified twice.
Number of read bytes	When multiple processing areas are used, specifies the number of bytes to be read from the Data Carrier in 2-digit hexadecimal code. The maximum number of bytes that can be read at one time is 256 bytes. •ASCII: 256 bytes (256 characters) •Hexadecimal code: 256 bytes (512 characters) Setting range: 00h to FFh (00 = 256 bytes)  When multiple processing areas are used, set so that the total number of bytes to be read for all areas is within 256 bytes, as follows: Area (1) bytes +...+ Area (N) bytes ≤ 256 bytes

Response

Processing Area Number: 1

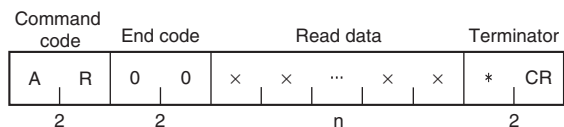

Processing Area Number: 2

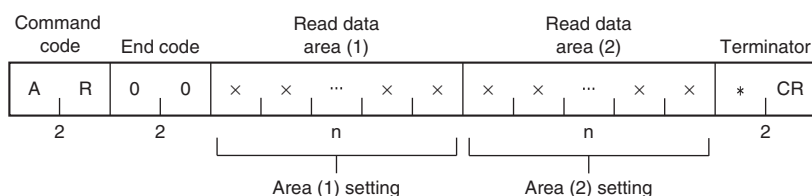

End code	Indicates the execution result for the command. The end code 00 indicates normal completion.  For details on end codes, refer to <i>End code List</i> .  p.101
Read data	Specifies the data read from the Data Carrier. The characters in ASCII indicate the number of read bytes and the characters in hexadecimal code indicate the number of read bytes x 2.

## AUTO WRITE (AW)

This command writes data to the Data Carrier when the Data Carrier enters the communications area. The Hand-held Reader Writer responds when communications between the Hand-held Reader Writer and Data Carrier have ended.

Command

### Processing Area Number: 1

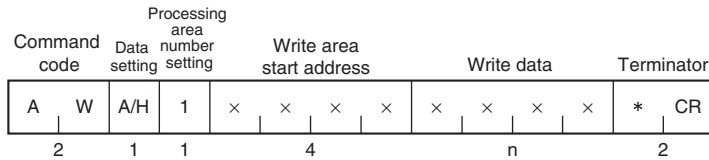

### Processing Area Number: 2

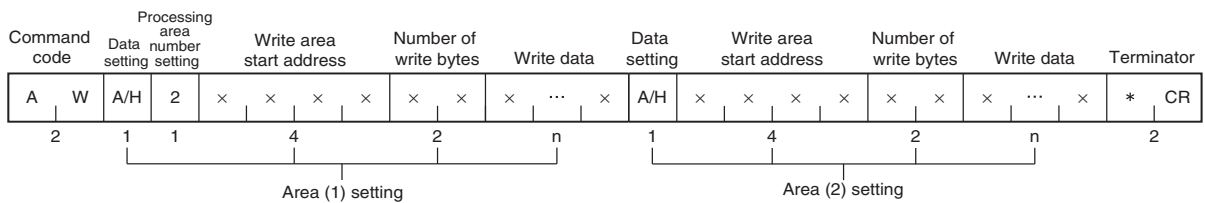

Data setting	Sets the code format used to send responses for read data. A: ASCII H: Hexadecimal code  When multiple processing areas are used, ASCII and hexadecimal code can be specified at the same time within a single command frame.
Processing area number setting	Specifies the processing area number. Setting range: 1 to 9, A (A = 10)
Write area start address	Specifies the start address of the area in the Data Carrier to be written to in 4-digit hexadecimal code. Setting range: 0000h to 1FFFh  When multiple processing areas are used, specify the areas in order starting from the smallest address. The same area cannot be specified twice.
Number of write bytes	When multiple processing areas are used, specifies the number of bytes to be written to the Data Carrier in 2-digit hexadecimal. The maximum number of bytes that can be written at one time is 256 bytes. •ASCII: 256 bytes (256 characters) •Hexadecimal code: 256 bytes (512 characters) Setting range: 01h to FFh  When multiple processing areas are used, set so that the total number of bytes to be written for all areas is within 256 bytes, 6 bytes, as follows: Area (1) bytes +...+ Area (N) bytes ≤ 256 bytes
Write data	Indicates the data to be written to the Data Carrier. The characters in ASCII indicate the number of write bytes and the characters in hexadecimal code indicate the number of write bytes × 2

Response

Command  
code    End code    Terminator

A	W	0	0	*	CR
2	2	2	2	2	2

End code	<p>Indicates the execution result for the command. The end code 00 indicates normal completion.</p> <p>For details on end codes, refer to <i>End code List</i>.   p.101</p>
----------	--

## BUTTON READ (BR)

After this command is received by the Hand-held Reader Writer, data is read from the Data Carrier by pressing the activate switch. If the activate switch is pressed and the Data Carrier is not in communications range, an error response (end code: 72 = Data Carrier non-existent) will be returned.

Command

Processing Area Number: 1

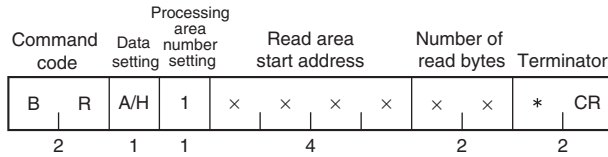

Processing Area Number: 2

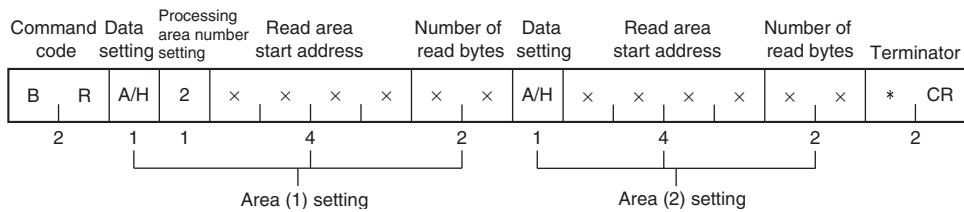

Data setting	Sets the code format used to send responses for read data. A: ASCII H: Hexadecimal code  When multiple processing areas are used, ASCII and hexadecimal code can be specified at the same time within a single command frame.
Processing area number setting	Specifies the processing area number. Setting range: 1 to 9, A (A = 10)
Read area start address	Specifies the start address of the area in the Data Carrier to be read from in 4-digit hexadecimal code. Setting range: 0000h to 1FFFh  When multiple processing areas are used, specify the areas in order starting from the smallest address. The same area cannot be specified twice.
Number of read bytes	Specifies the number of bytes to be read from the Data Carrier in 2-digit hexadecimal. The maximum number of bytes that can be read at one time is 256 bytes. •ASCII: 256 bytes (256 characters) •Hexadecimal code: 256 bytes (512 characters) Setting range: 00h to FFh (00 = 256 bytes)  When multiple processing areas are used, set so that the total number of bytes to be read for all areas is within 256 bytes, as follows: Area (1) bytes +...+ Area (N) bytes ≤ 256 bytes



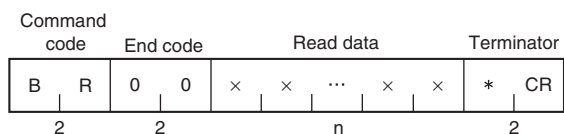

Response

Processing Area Number: 1

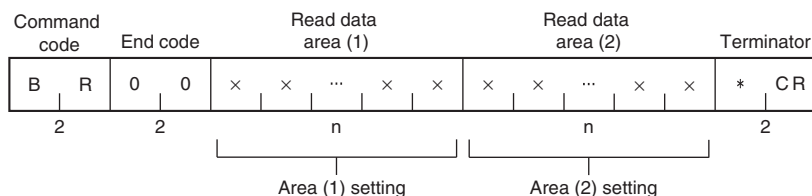

Processing Area Number: 2



End code	Indicates the execution result for the command. The end code 00 indicates normal completion.  For details on end codes, refer to <i>End code List</i> .  p.101
Read data	Indicates the data read from the Data Carrier. The characters in ASCII indicate the number of read bytes and the characters in hexadecimal code indicate the number of read bytes x 2.

## BUTTON WRITE (BW)

After this command is received by the Hand-held Reader Writer, data is written to the Data Carrier by pressing the activate switch. If the activate switch is pressed and the Data Carrier is not in communications range, an error response (end code: 72 = Data Carrier non-existent) will be returned.

Command

Processing Area Number: 1

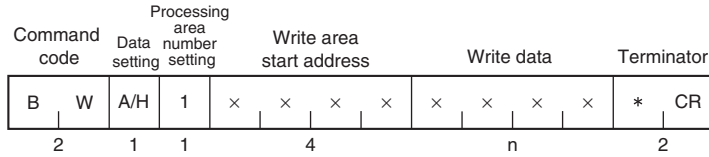

Processing Area Number: 2

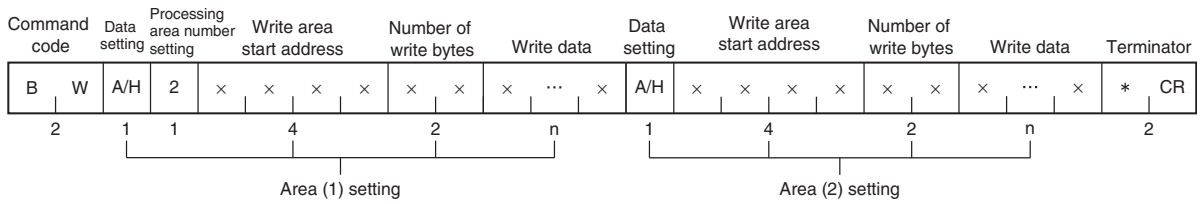

Data setting	Sets the code format used to send responses for read data. A: ASCII H: Hexadecimal code  When multiple processing areas are used, ASCII and hexadecimal code can be specified at the same time within a single command frame.
Processing area number setting	Specifies the processing area number. Setting range: 1 to 9, A (A = 10)
Write area start address	Specifies the start address of the area in the Data Carrier to be written to in 4-digit hexadecimal code. Setting range: 0000h to 1FFFh  When multiple processing areas are used, specify the areas in order starting from the smallest address. The same area cannot be specified twice.
Number of write bytes	When multiple processing areas are used, specifies the number of bytes to be written to the Data Carrier in 2-digit hexadecimal. The maximum number of bytes that can be written at one time is 256 bytes. •ASCII: 256 bytes (256 characters) •Hexadecimal code: 256 bytes (512 characters) Setting range: 01h to FFh  When multiple processing areas are used, set so that the total number of bytes to be written for all areas is within 256 bytes, as follows: Area (1) bytes +...+ Area (N) bytes ≤ 256 bytes
Write data	Indicates the data to be written to the Data Carrier. The characters in ASCII indicate the number of write bytes and the characters in hexadecimal code indicate the number of write bytes x 2.

Response

Command  
code      End code      Terminator

B	W	0	0	*	CR
2		2		2	

End code	<p>Indicates the execution result for the command. The end code 00 indicates normal completion.</p> <p>For details on end codes, refer to <i>End code List</i>.</p> <p> p.101</p>
----------	--

## BUTTON AUTO READ (UR)

After this command is received by the Hand-held Reader Writer, data will be read from the Data Carrier after the activate switch is pressed and the Hand-held Reader Writer is close to the Data Carrier. The Hand-held Reader Writer responds when communications between the Hand-held Reader Writer and Data Carrier have ended.

Command

Processing Area Number: 1

Command code	Data setting	Processing area number setting	Read area start address				Number of read bytes		Terminator	
U	R	A/H	1	x	x	x	x	x	x	* CR
2	1	1	4				2		2	

Processing Area Number: 2

Command code	Data setting	Processing area number setting	Read area start address				Number of read bytes setting	Data setting	Read area start address				Number of read bytes	Terminator		
U	R	A/H	2	x	x	x	x	x	A/H	x	x	x	x	x	x	* CR
2	1	1	4				2	1	4				2	2		
			Area (1) setting				Area (2) setting									

Data setting	<p>Sets the code format used to send responses for read data.</p> <p>A: ASCII H: Hexadecimal code</p> <p>When multiple processing areas are used, ASCII and hexadecimal code can be specified at the same time within a single command frame.</p>
Processing area number setting	<p>Specifies the processing area number.</p> <p>Setting range: 1 to 9, A (A = 10)</p>
Read area start address	<p>Specifies the start address of the area in the Data Carrier to be read from in 4-digit hexadecimal code.</p> <p>Setting range: 0000h to 1FFFh</p> <p>When multiple processing areas are used, specify the areas in order starting from the smallest address. The same area cannot be specified twice.</p>
Number of read bytes	<p>Specifies the number of bytes to be read from the Data Carrier in 2-digit hexadecimal.</p> <p>The maximum number of bytes that can be read at one time is 256 bytes.</p> <ul style="list-style-type: none"> <li>•ASCII: 256 bytes (256 characters)</li> <li>•Hexadecimal code: 256 bytes (512 characters)</li> </ul> <p>Setting range: 00h to FFh (00 = 256 bytes)</p> <p>When multiple processing areas are used, set so that the total number of bytes to be read for all areas is within 256 bytes, as follows:</p> <p style="text-align: center;">Area (1) bytes +...+ Area (N) bytes ≤ 256 bytes</p>

Response

Processing Area Number: 1

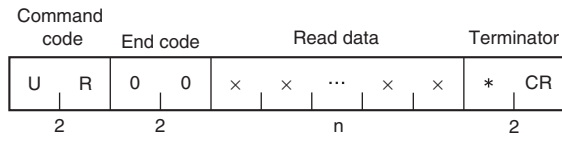

Processing Area Number: 2

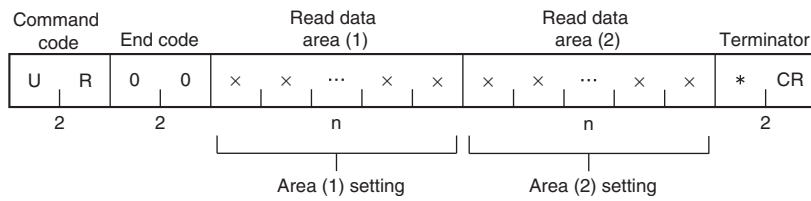

End code	Indicates the execution result for the command. The end code 00 indicates normal completion.  For details on end codes, refer to <i>End code List</i> .  p.101
Read data	Indicates the data read from the Data Carrier. The characters in ASCII indicate the number of read bytes and the characters in hexadecimal code indicate the number of read bytes x 2.

## BUTTON AUTO WRITE (UW)

After this command is received by the Hand-held Reader Writer, data will be written to the Data Carrier after the activate switch is pressed and the Hand-held Reader Writer is close to the Data Carrier. The Hand-held Reader Writer responds when communications between the Hand-held Reader Writer and Data Carrier have ended.

Command

Processing Area Number: 1

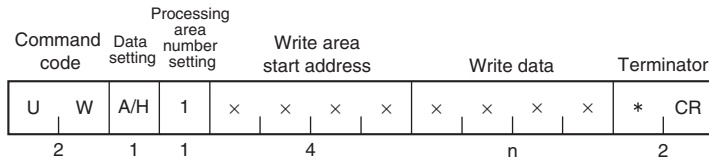

Processing Area Number: 2

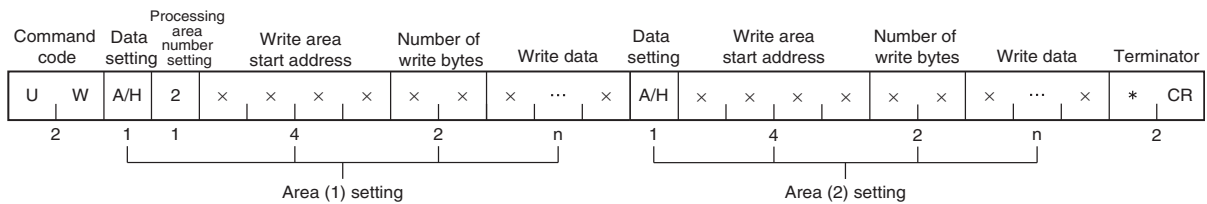

Data setting	Sets the code format used to send responses for read data. A: ASCII H: Hexadecimal code  When multiple processing areas are used, ASCII and hexadecimal code can be specified at the same time within a single command frame.
Processing area number setting	Specifies the processing area number. Setting range: 1 to 9, A (A = 10)
Write area start address	Specifies the start address of the area in the Data Carrier to be written to in 4-digit hexadecimal code. Setting range: 0000h to 1FFFh  When multiple processing areas are used, specify the areas in order starting from the smallest address. The same area cannot be specified twice.
Number of write bytes	When multiple processing areas are used, specifies the number of bytes to be written to the Data Carrier in 2-digit hexadecimal. The maximum number of bytes that can be written at one time is 256 bytes. •ASCII: 256 bytes (256 characters) •Hexadecimal code: 256 bytes (512 characters) Setting range: 01h to FFh  When multiple processing areas are used, set so that the total number of bytes to be written for all areas is within 256 bytes, as follows: Area (1) bytes +...+ Area (N) bytes ≤ 256 bytes
Write data	Indicates the data to be written to the Data Carrier. The characters in ASCII indicate the number of write bytes and the characters in hexadecimal code indicate the number of write bytes x 2.

Response

Command

code		End code		Terminator	
U	W	0	0	*	CR
2		2		2	

End code	<p>Indicates the execution result for the command. The end code 00 indicates normal completion.</p> <p>For details on end codes, refer to <i>End code List</i>.   p.101</p>
----------	--

## COPY READ (RC)

This command reads data to be copied using the COPY WRITE (WC) command.  
A response is not sent for read data.

### Command

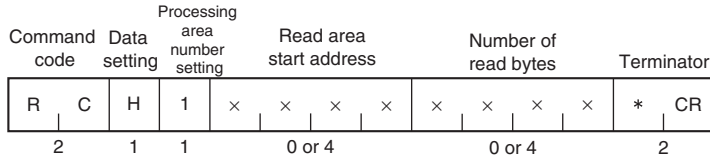

Data setting	Always H.
Processing area number setting	Always 1.
Read area start address	Specifies the start address of the area in the Data Carrier to be read from in 4-digit hexadecimal code (can be omitted). Setting range: 0000h to 1FFFh (when omitted, all areas in the Data Carrier are read)  <b>Note:</b> If omitting the start address, also omit the number of read bytes. All areas of an 8-Kbytes Data Carrier cannot be copied.
Number of read bytes	Specifies the number of bytes to be read from the Data Carrier in 4-digit hexadecimal. Setting range: 0001h to 0800h

### Response

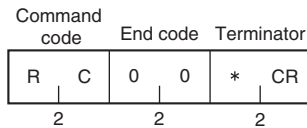

End code	Indicates the execution result for the command. The end code 00 indicates normal completion.  For details on end codes, refer to <i>End code List</i> .  p.101
----------	---



The COPY READ command can be executed more than once for data that has already been copied. If the copy operation fails, however, the copied data that was held will be deleted.



## COPY WRITE (WC)

This command writes data to the Data Carrier that was read using the COPY READ (RC) command. The Hand-held Reader Writer responds when communications between the Hand-held Reader Writer and Data Carrier have ended.

### Command

Command code	Data setting	Processing area number setting	Terminator
W	C	H	1 * CR
2	1	1	2

Data setting	Always H.
Processing area number setting	Always 1.

### Response

Command code	End code	Terminator
W	C	0 0 * CR
2	2	2

End code	<p>Indicates the execution result for the command. The end code 00 indicates normal completion.</p> <p>For details on end codes, refer to <i>End code List</i>.  p.101</p>
----------	---

## EXPANSION DIVIDED READ (XR)

This command divides and reads up to 2 Kbytes of data. If the Data Carrier is not in communications range, an error response (end code: 72 = Data Carrier non-existent) will be returned. The host device cannot send commands to the Hand-held Reader Writer until all the responses have been received.

Command

Command code		Data setting	Processing area number setting	Read area start address				Number of read bytes				Terminator	
X	R	A/H	1	x	x	x	x	x	x	x	x	*	CR
2		1	1	4				4				2	

Data setting	Sets the code format used to send responses for read data. A: ASCII H: Hexadecimal code
Processing area number setting	Always 1.
Read area start address	Specifies the start address of the area in the Data Carrier to be read from in 4-digit hexadecimal code. Setting range: 0000h to 1FFFh
Number of read bytes	Specifies the number of bytes to be read from the Data Carrier in 4-digit hexadecimal. The maximum number of bytes that can be read at one time is 2,048 bytes. Setting range: 0001h to 0800h •ASCII: 2,048 bytes (2,048 characters) •Hexadecimal code: 2,048 bytes (4,096 characters)

Response

When the read data is within 250 characters.

Command code		End code		Read data				Terminator	
X	R	0	0	x	x	...	x	x	* CR
2		2		n				2	

End code	Indicates the execution result for the command. The end code 00 indicates normal completion.  For details on end codes, refer to <i>End code List</i> .  p.101
Read data	Indicates the data read from the Data Carrier. The characters in ASCII indicate the number of read bytes and the characters in hexadecimal code indicate the number of read bytes x 2.

When the read data is 251 characters or higher.

The data received from the host device is divided into frames according to the delimiters (CR), as shown in the following diagram.

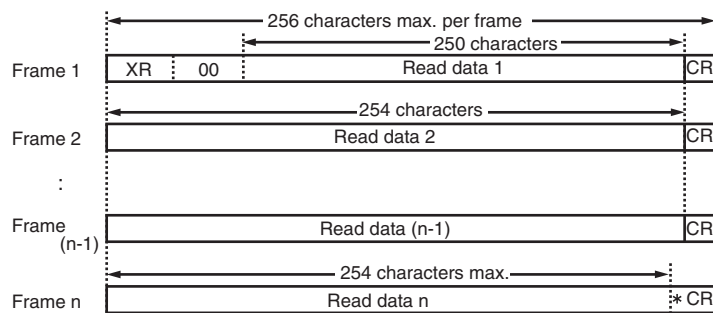

Communications Procedure

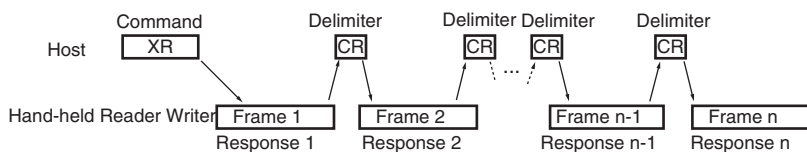

## EXPANSION DIVIDED WRITE (XW)

Divides and writes up to 2 Kbytes of data. If the Data Carrier is not in communications range, an error response (end code: 72 = Data Carrier non-existent) will be returned.

The host device cannot send commands to the Hand-held Reader Writer until all the responses have been received.

Command

Frame 1

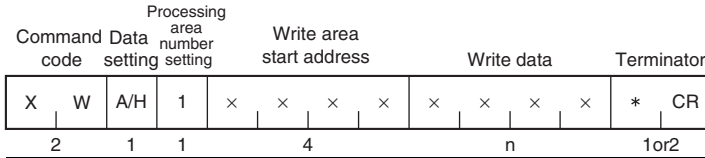

Data setting	Specifies the code format used to send write data to the Data Carrier. A: ASCII H: Hexadecimal code
Processing area number setting	Always 1.
Write area start address	Specifies the start address of the area to be written to in 4-digit hexadecimal. Setting range: 0000h to 1FFFh
Write data	Indicates the data to be written to the Data Carrier. Data can be between 0 and 257 characters.
Terminator	Indicates the end of the frame. CR: Succeeding frame *CR: No succeeding frame

Frames 2 to N

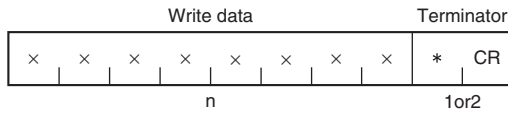

Write data	Indicates the data to be written to the Data Carrier. Data can be between 0 and 265 characters.
Terminator	Indicates the end of the frame. CR: Succeeding frame *CR: No succeeding frame

Response

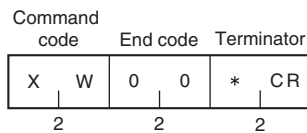

End code	Indicates the execution result for the command. The end code 00 indicates normal completion.  For details on end codes, refer to <i>End code List</i> .  p.101
----------	---

### •Frame Division Method

If the command length is longer than 266 characters, divide the data into separate frames before sending as follows:

#### Frame Division Method

1. Divide the data into frames each with 266 characters max.
2. Use the final terminator (\* CR) for the last frame (frame n) only. Use the delimiter (CR) at the end of other frames.
3. Be sure to include the command code, data setting, processing area number setting, and start address in the first frame (frame 1). If any of these parameters is omitted, a command input error will occur. The write data can be omitted.
4. Make sure that data is divided correctly without any single frames containing AA\*CR or XZ\*CR.

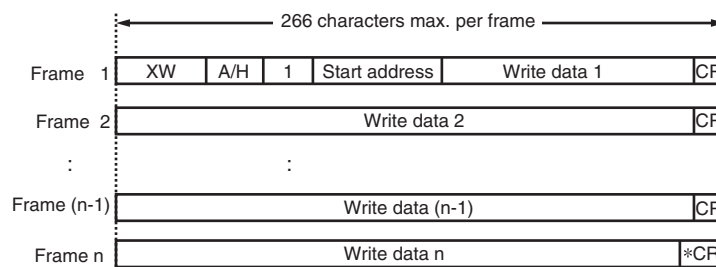

#### Communications Procedure

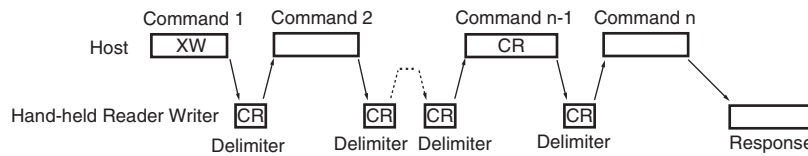

## EXPANSION DIVIDED AUTO READ (NR)

This command divides and reads up to 2 Kbytes of data from the Data Carrier when the Hand-held Reader Writer is moved close to the Data Carrier. The Hand-held Reader Writer responds when communications between the Hand-held Reader Writer and Data Carrier have ended. The host device cannot send commands to the Hand-held Reader Writer until all the responses have been received.

Command

Command code		Data setting	Processing area number setting	Read area start address				Number of read bytes				Terminator	
N	R	A/H	1	x	x	x	x	x	x	x	x	*	CR
2		1	1	4				4				2	

Data setting	Sets the code format used to send responses for read data. A: ASCII H: Hexadecimal code
Processing area number setting	Always 1.
Read area start address	Specifies the start address of the area in the Data Carrier to be read from in 4-digit hexadecimal code. Setting range: 0000h to 1FFFh
Number of read bytes	Specifies the number of bytes to be read from the Data Carrier in 4-digit hexadecimal. The maximum number of bytes that can be read at one time is 2,048 bytes. Setting range: 0001h to 0800h •ASCII: 2,048 bytes (2,048 characters) •Hexadecimal code: 2,048 bytes (4,096 characters)

Response

When the read data is within 250 characters.

Command code		End code		Read data				Terminator	
N	R	0	0	x	x	...	x	x	* CR
2		2		n				2	

End code	Indicates the execution result for the command. The end code 00 indicates normal completion.  For details on end codes, refer to <i>End code List</i> .  p.101
Read data	Indicates the data read from the Data Carrier. The characters in ASCII indicate the number of read bytes and the characters in hexadecimal code indicate the number of read bytes x 2.

When the read data is 251 characters or higher.

The data received from the host device is divided into frames according to the delimiters (CR), as shown in the following diagram.

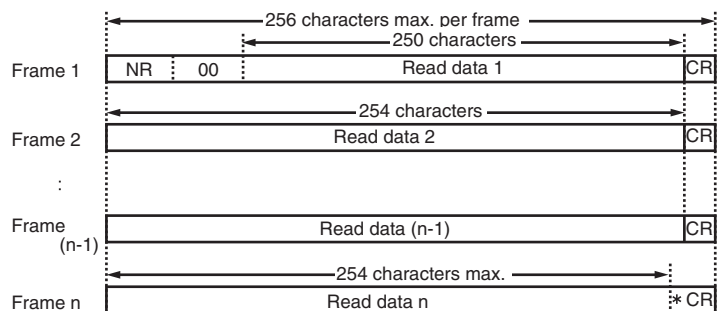

Communications Procedure

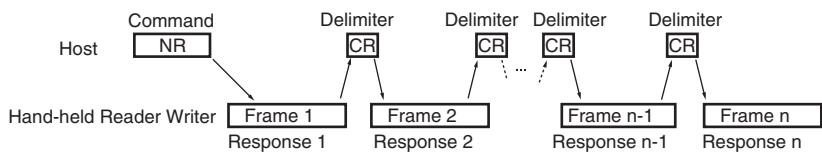

## EXPANSION DIVIDED AUTO WRITE (NW)

This command divides and writes up to 2 Kbytes of data to the Data Carrier when the Hand-held Reader Writer is moved close to the Data Carrier. The Hand-held Reader Writer responds when communications between the Hand-held Reader Writer and Data Carrier have ended. The host device cannot send commands to the Hand-held Reader Writer until all the responses have been received

Command

Frame 1

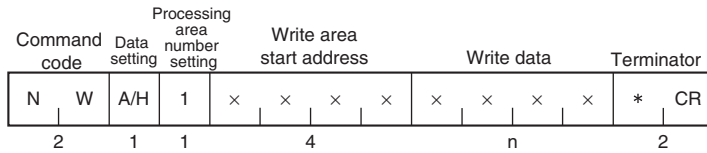

Data setting	Specifies the code format used to send write data to the Data Carrier. A: ASCII H: Hexadecimal code
Processing area number setting	Always 1.
Write area start address	Specifies the start address of the area to be written to in 4-digit hexadecimal. Setting range: 0000h to 1FFFh
Write data	Indicates the data to be written to the Data Carrier. Data can be between 0 and 257 characters.
Terminator	Indicates the end of the frame. CR: Succeeding frame *CR: No succeeding frame

Frames 2 to n

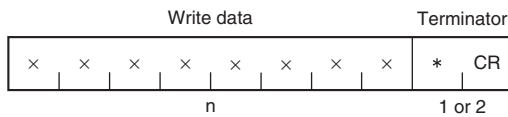

Write data	Indicates the data to be written to the Data Carrier. Data can be between 0 and 265 characters.
Terminator	Indicates the end of the frame. CR: Succeeding frame *CR: No succeeding frame

Response

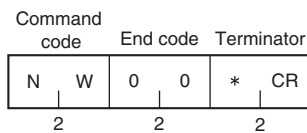

End code	Indicates the execution result for the command. The end code 00 indicates normal completion.  For details on end codes, refer to <i>End code List</i> .  p.101
----------	---



## •Frame Division Method

If the command length is longer than 266 characters, divide the data into separate frames before sending, as follows:

### Frame Division Method

1. Divide the data into frames each with 266 characters max.
2. Use the final terminator (\* CR) for the last frame (frame n) only. Use the delimiter (CR) at the end of other frames.
3. Be sure to include the command code, data setting, processing area number setting, and start address in the first frame (frame 1). If any of these parameters is omitted, a command input error will occur. The write data can be omitted.
4. Make sure that data is divided correctly without any single frames containing AA\*CR or XZ\*CR.

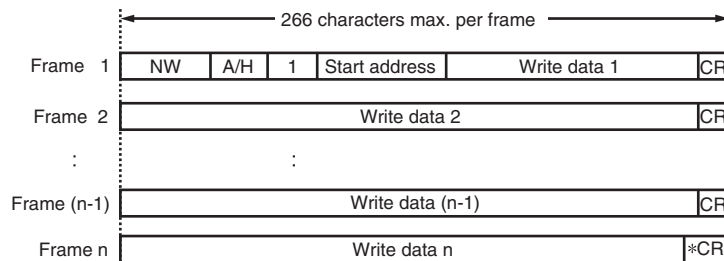

### Communications Procedure

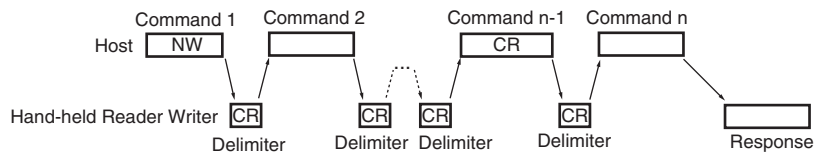

## EXPANSION BATCH READ (rd)

This command reads up to 2 Kbytes of data from the Data Carrier in a batch. If the Data Carrier is not in communications range, an error response (end code: 72 = Data Carrier non-existent) will be returned.

### Command

Command code	Data setting	Processing area number setting	Read area start address	Number of read bytes	Terminator
r	d	A/H	1	x x x x	x x x x
2	1	1	4	4	2

Data setting	Sets the code format used to send responses for read data. A: ASCII H: Hexadecimal code
Processing area number setting	Always 1.
Read area start address	Specifies the start address of the area in the Data Carrier to be read from in 4-digit hexadecimal code. Setting range: 0000h to 1FFFh
Number of read bytes	Specifies the number of bytes to be read from the Data Carrier in 4-digit hexadecimal. The maximum number of bytes that can be read at one time is 2,048 bytes. Setting range: 0001h to 0800h •ASCII: 2,048 bytes (2,048 characters) •Hexadecimal code: 2,048 bytes (4,096 characters)

### Response

Command code	End code	Read data	Terminator
r	d	0 0	x x ... x x
2	2	n	2

End code	Indicates the execution result for the command. The end code 00 indicates normal completion.  For details on end codes, refer to <i>End code List</i> .  p.101
Read data	Indicates the data read from the Data Carrier. The characters in ASCII indicate the number of read bytes and the characters in hexadecimal code indicate the number of read bytes x 2.

## EXPANSION BATCH WRITE (wt)

This command writes up to 2 Kbytes of data to the Data Carrier in a batch. If the Data Carrier is not in communications range, an error response (end code: 72 = Data Carrier non-existent) will be returned.

### Command

Command code		Data setting	Processing area number setting	Write area start address				Write data				Terminator	
w	t	A/H	1	x	x	x	x	x	x	x	x	*	CR
2		1	1	4				n				2	

Data setting	Specifies the code format used to send write data to the Data Carrier. A: ASCII H: Hexadecimal code
Processing area number setting	Always 1.
Write area start address	Specifies the start address of the area to be written to in 4-digit hexadecimal. Setting range: 0000h to 1FFFh
Write data	Indicates the data to be written to the Data Carrier. The maximum number of bytes that can be written at one time is 2,048 bytes. Setting range: 0001h to 0800h •ASCII: 2,048 bytes (2,048 characters) •Hexadecimal code: 2,048 bytes (4,096 characters)

### Response

Command code		End code	Terminator
w	t	0 0	* CR
2		2	2

End code	Indicates the execution result for the command. The end code 00 indicates normal completion.  For details on end codes, refer to <i>End code List</i> .  p.101
----------	---

## EXPANSION BATCH AUTO READ (ar)

This command reads up to 2 Kbytes of data from the Data Carrier in a batch when the Hand-held Reader Writer moves close to the Data Carrier. The Hand-held Reader Writer responds when communications between the Hand-held Reader Writer and Data Carrier have ended.

### Command

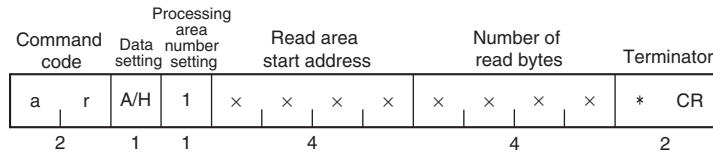

Data setting	Sets the code format used to send responses for read data. A: ASCII H: Hexadecimal code
Processing area number setting	Always 1.
Read area start address	Specifies the start address of the area in the Data Carrier to be read from in 4-digit hexadecimal code. Setting range: 0000h to 1FFFh
Number of read bytes	Specifies the number of bytes to be read from the Data Carrier in 4-digit hexadecimal. The maximum number of bytes that can be read at one time is 2,048 bytes. Setting range: 0001h to 0800h •ASCII: 2,048 bytes (2,048 characters) •Hexadecimal code: 2,048 bytes (4,096 characters)

### Response

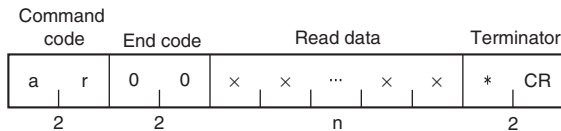

End code	Indicates the execution result for the command. The end code 00 indicates normal completion.  For details on end codes, refer to <i>End code List</i> .  p.101
Read data	Indicates the data read from the Data Carrier. The characters in ASCII indicate the number of read bytes and the characters in hexadecimal code indicate the number of read bytes x 2.

## EXPANSION BATCH AUTO WRITE (aw)

This command writes up to 2 Kbytes of data to the Data Carrier in a batch when the Hand-held Reader Writer moves close to the Data Carrier. The Hand-held Reader Writer responds when communications between the Hand-held Reader Writer and Data Carrier have ended.

### Command

Command code	Data setting	Processing area number setting	Write area start address	Write data	Terminator
a	w	A/H	1	x x x x	x x x x
2	1	1	4	n	2

Data setting	Specifies the code format used to send write data to the Data Carrier. A: ASCII H: Hexadecimal code
Processing area number setting	Always 1.
Write area start address	Specifies the start address of the area to be written to in 4-digit hexadecimal. Setting range: 0000h to 1FFFh
Write data	Indicates the data to be written to the Data Carrier. The maximum number of bytes that can be written at one time is 2,048 bytes. Setting range: 0001h to 0800h •ASCII: 2,048 bytes (2,048 characters) •Hexadecimal code: 2,048 bytes (4,096 characters)

### Response

Command code	End code	Terminator
a	w	0 0
2	2	2

End code	Indicates the execution result for the command. The end code 00 indicates normal completion.  For details on end codes, refer to <i>End code List</i> .  p.101
----------	---

## EXPANSION BATCH BUTTON READ (br)

After this command is received by the Hand-held Reader Writer, up to 2 Kbytes of data will be read from the Data Carrier in a batch when the activate switch is pressed. If the activate switch is pressed and the Data Carrier is not in communications range, an error response (end code: 72 = Data Carrier non-existent) will be returned.

### Command

Command code	Data setting	Processing area number setting	Read area start address	Number of read bytes	Terminator
b r	A/H	1	x x x x	x x x x	* CR
2	1	1	4	4	2

Data setting	Sets the code format used to send responses for read data. A: ASCII H: Hexadecimal code
Processing area number setting	Always 1.
Read area start address	Specifies the start address of the area in the Data Carrier to be read from in 4-digit hexadecimal code. Setting range: 0000h to 1FFFh
Number of read bytes	Specifies the number of bytes to be read from the Data Carrier in 4-digit hexadecimal. The maximum number of bytes that can be read at one time is 2,048 bytes. Setting range: 0001h to 0800h •ASCII: 2,048 bytes (2,048 characters) •Hexadecimal code: 2,048 bytes (4,096 characters)

### Response

Command code	End code	Read data	Terminator
b r	0 0	x x ... x x	* CR
2	2	n	2

End code	Indicates the execution result for the command. The end code 00 indicates normal completion.  For details on end codes, refer to <i>End code List</i> .  p.101
Read data	Indicates the data read from the Data Carrier. The characters in ASCII indicate the number of read bytes and the characters in hexadecimal code indicate the number of read bytes x 2.

## EXPANSION BATCH BUTTON WRITE (bw)

After this command is received by the Hand-held Reader Writer, up to 2 Kbytes of data will be written to the Data Carrier in a batch when the activate switch is pressed. If the activate switch is pressed and the Data Carrier is not in communications range, an error response (end code: 72 = Data Carrier non-existent) will be returned.

### Command

Command code	Data setting	Processing area number	Write area start address	Write data	Terminator
b	w	A/H	1	x x x x	x x x x
2	1	1	4	n	2

Data setting	Specifies the code format used to send write data to the Data Carrier. A: ASCII H: Hexadecimal code
Processing area number setting	Always 1.
Write area start address	Specifies the start address of the area to be written to in 4-digit hexadecimal. Setting range: 0000h to 1FFFh
Write data	Indicates the data to be written to the Data Carrier. The maximum number of bytes that can be written at one time is 2,048 bytes. Setting range: 0001h to 0800h •ASCII: 2,048 bytes (2,048 characters) •Hexadecimal code: 2,048 bytes (4,096 characters)

### Response

Command code	End code	Terminator
b	w	0 0
2	2	2

End code	Indicates the execution result for the command. The end code 00 indicates normal completion.  For details on end codes, refer to <i>End code List</i> .  p.101
----------	---

## EXPANSION BATCH BUTTON AUTO READ (ur)

After this command is received by the Hand-held Reader Writer, up to 2 Kbytes of data will be read from the Data Carrier in a batch when the activate switch is pressed after the Hand-held Reader Writer moves close to the Data Carrier. The Hand-held Reader Writer responds when communications between the Hand-held Reader Writer and Data Carrier have ended.

### Command

Command code	Data setting	Processing area number setting	Read area start address	Number of read bytes	Terminator
u   r	A/H	1	x   x   x   x	x   x   x   x	*   CR
2	1	1	4	4	2

Data setting	Sets the code format used to send responses for read data. A: ASCII H: Hexadecimal code
Processing area number setting	Always 1.
Read area start address	Specifies the start address of the area in the Data Carrier to be read from in 4-digit hexadecimal code. Setting range: 0000h to 1FFFh
Number of read bytes	Specifies the number of bytes to be read from the Data Carrier in 4-digit hexadecimal. The maximum number of bytes that can be read at one time is 2,048 bytes. Setting range: 0001h to 0800h •ASCII: 2,048 bytes (2,048 characters) •Hexadecimal code: 2,048 bytes (4,096 characters)

### Response

Command code	End code	Read data	Terminator
u   r	0   0	x   x   ...   x   x	*   CR
2	2	n	2

End code	Indicates the execution result for the command. The end code 00 indicates normal completion.  For details on end codes, refer to <i>End code List</i> .  p.101
Read data	Indicates the data read from the Data Carrier. The characters in ASCII indicate the number of read bytes and the characters in hexadecimal code indicate the number of read bytes x 2.



## EXPANSION BATCH BUTTON AUTO WRITE (uw)

After this command is received by the Hand-held Reader Writer, up to 2 Kbytes of data will be written to the Data Carrier in a batch when the activate switch is pressed after the Hand-held Reader Writer moves close to the Data Carrier. The Hand-held Reader Writer responds when communications between the Hand-held Reader Writer and Data Carrier have ended.

### Command

Command code	Data setting	Processing area number setting	Write area start address	Write data	Terminator
u	w	A/H	1	x x x x	x x x x
2	1	1	4	n	2

Data setting	Specifies the code format used to send write data to the Data Carrier. A: ASCII H: Hexadecimal code
Processing area number setting	Always 1.
Write area start address	Specifies the start address of the area to be written to in 4-digit hexadecimal. Setting range: 0000h to 1FFFh
Write data	Indicates the data to be written to the Data Carrier. The maximum number of bytes that can be written at one time is 2,048 bytes. Setting range: 0001h to 0800h •ASCII: 2,048 bytes (2,048 characters) •Hexadecimal code: 2,048 bytes (4,096 characters)

### Response

Command code	End code	Terminator
u	w	0 0
2	2	2

End code	Indicates the execution result for the command. The end code 00 indicates normal completion.  For details on end codes, refer to <i>End code List</i> .  p.101
----------	---

## Calculation Write (CW)

The Data Carrier's memory data and calculation data is calculated in hexadecimal and the result is written to the Data Carrier. If an overflow during addition or underflow during subtraction occurs, the data will not be written and an error response (end code: 76 = Data check error) will be returned.

### Command

Command code		Data setting	Processing area number setting	Calculation area start address				Number of calculation area bytes		Calculation data	Terminator	
C	W	A/S	1	x	x	x	x	x	x		*	CR
2		1	1	4				2		Specified number of bytes		2

Processing specification	Specifies the calculation method. A: Add hexadecimal S: Subtract hexadecimal
Processing area number setting	Always 1.
Calculation area start address	Specifies the start address of the area to be written to in 4-digit hexadecimal. Setting range: 0000h to 1FFFh
Number of calculation area bytes	Specifies the number of bytes in the area for calculating data in 2-digit hexadecimal. Setting range: 01h to 04h
Calculation data	Specifies the numerical values to be calculated in hexadecimal.

### Response

Command code		End code		Calculation data	Terminator	
C	W	0	0		*	CR
2		2		Specified number of bytes	2	

Calculation data	Returns the calculation result data written to the Data Carrier. If an overflow during addition or underflow during subtraction occurs, the end code 76 (data check error) will be returned. The data prior to the calculation will not be added to the response.
------------------	--

## FILL (FL)

This command writes one byte of specified data to the specified memory area of the Data Carrier. The write data is specified in hexadecimal.

Command

Command code		Data setting	Processing area number setting	Write area start address				Number of write bytes		Specified data		Terminator	
F	L	H	1	×	×	×	×	×	×	×	×	*	CR
2		1	1	4				2		2		2	

Data setting	Always H.
Processing area number setting	Always 1.
Write area start address	Specifies the start address of the area in the Data Carrier to be written to in 4-digit hexadecimal code. Setting range: 0000h to 1FFFh
Number of write bytes	Specifies the data to be written to the Data Carrier in 2-digit hexadecimal. Setting range: 00h to FFh (00 = 256 bytes)
Specified data	Indicates the data to be written to the Data Carrier.

Response

Command code		End code	Terminator		
F	L	0	0	*	CR
2		2		2	

End code	Indicates the execution result for the command. The end code 00 indicates normal completion.  For details on end codes, refer to <i>End code List</i> .  p.101
----------	---

•Example

Writing 01H to the 06H bytes in the memory area starting from address 0030H for a Data Carrier in which the same data and address is written.

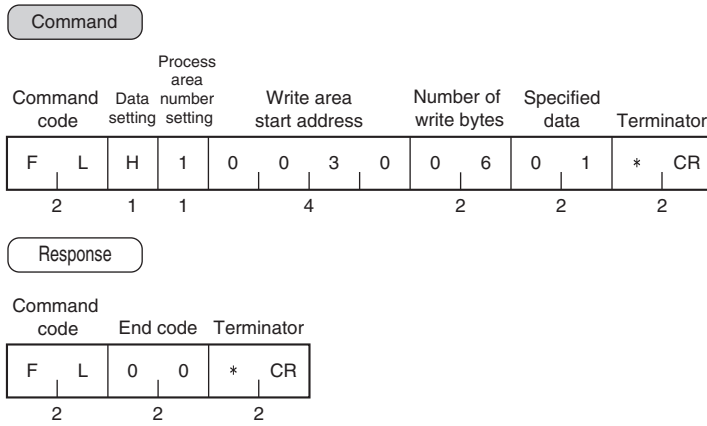

Before Writing

002FH	2	F
0030H	3	0
0031H	3	1
0032H	3	2
0033H	3	3
0034H	3	4
0035H	3	5
0036H	3	6

After Writing

002FH	2	F
0030H	0	1
0031H	0	1
0032H	0	1
0033H	0	1
0034H	0	1
0035H	0	1
0036H	3	6

## EXPANSION BATCH FILL (fl)

This command writes specified data for the number of write bytes starting from the specified write start address. Up to 2 Kbytes of data can be written in a batch.

Command

Command code	Processing area Data number setting	Write area start address	Number of write bytes	Specified data	Terminator
f   l	H   1	x   x   x   x	x   x   x   x	x   x	*   CR
2	1   1	4	4	2	2

Data setting	Always H.
Processing area number setting	Always 1.
Write area start address	Specifies the start address of the area in the Data Carrier to be written to in 4-digit hexadecimal code. Setting range: 0000h to 1FFFh
Number of write bytes	Specifies the data to be written to the Data Carrier in 4-digit hexadecimal. Setting range: 0001h to 0800h
Specified data	Indicates the data to be written to the Data Carrier.

Response

Command code	End code	Terminator
f   l	0   0	*   CR
2	2	2

End code	Indicates the execution result for the command. The end code 00 indicates normal completion.  For details on end codes, refer to <i>End code List</i> .  p.101
----------	---

## DATA CHECK (MDC/K)

This command writes or compares the CRC code using the specified check block unit. The CRC code is calculated from the generated polynomial expression  $X^{16} + X^{12} + X^5 + 1$ .

### Command

Command code		Process setting	Processing area number setting	Check block start address				Number of check block bytes		Terminator	
M	D	C/K	1	x	x	x	x	x	x	*	CR
2		1	1	4				2		2	

Process setting	Specifies the check process. K: Check code calculation C: Check code comparison
Processing area number setting	Always 1.
Check block start address	Specifies the start address of the check block in 4-digit hexadecimal. Setting range: 0000h to 1FFDh
Number of check block bytes	Specifies the number of bytes in the check block in 2-digit hexadecimal. Setting range: 00h, 03h to FFh (00 = 256 bytes)  The number of check block bytes is the check code calculation area + 2 bytes. For details, refer to Memory Check Function in Data Carrier.  p.114

### Response

Command code		End code	Terminator	
M	D	x	x	* CR
2		2		2

End code	Indicates the execution result for the command. 00: Normal completion 76: Data error warning (only during comparison control)  For details on end codes, refer to <i>End code List</i> .  p.101
----------	---



For details on the memory check, refer to *Memory Check Function in Data Carrier*.

CHECK!



p.114

## OVERWRITE COUNT CONTROL (MDS)

This command is used to control the number of overwrite operations performed by EEPROM Data Carriers. This command determines whether the EEPROM overwrite count has been exceeded when the specified number of overwrites is subtracted from the specified overwrite count control area data.

### Command

Command code		Mode setting	Processing area number setting	Area start address				Decrement count		Terminator	
M	D	S	1	×	×	×	×	×	×	*	CR
2		1	1	4				2		2	

Mode setting	Always S.
Processing area number setting	Always 1.
Area start address	Specifies the start address of the overwrite count control area in 4-digit hexadecimal. Setting range: 0000h to 1FFDh
Decrement count	Specifies the number of refresh operations in 2-digit hexadecimal. Setting range: 00h to FFh (00 = Performs overwrite count check only)  For details, refer to <i>Data Carrier Service Life Detection</i> .  p.111



Set the start address between □□□0H and □□□5H or between □□□8H and □□□DH. If the start address is set between □□□6H and □□□7H or between □□□EH and □□□FH, an address error (error code: 7A(HEX)) will be returned in the end code.

### Response

Command code		End code	Terminator	
M	D	0	0	* CR
2		2		2

End code	Indicates the execution result for the command. 00: Normal completion 76: Data error warning  For details on end codes, refer to <i>End code List</i> .  p.101
----------	--



For details on controlling the overwrite count, refer to *Data Carrier Service Life Detection*.

 p.111

# Communications Subcommands

Communications subcommands are used together with communications commands. Communications with the Data Carrier cannot be performed using only these subcommands.

## COMMAND PROCESSING TERMINATE (AA)

Terminates the processing of the communications commands and error noise detection commands, and restores the command wait status.

Command

Command code		Terminator	
A	A	*	CR
2	2	2	2

Response

Command code		Termination End code		Termination timing	Terminator
A	A	0	0	×	* CR
2	2	2	2	1	2

End code	Indicates the execution result for the command. 00: Normal completion 15: Command processing not executed.  For details on end codes, refer to <i>End code List</i> .  p.101
Termination timing	Indicates the timing for terminating command processing. 0: Terminated before Data Carrier detection. 1: Terminated during Data Carrier detection.



# Host Commands

## TEST (TS)

This command returns test messages sent from the host device without changing anything. The TEST command is used for communications tests between the host device and the Hand-held Reader Writer.

Command

Command code		Message data					Terminator	
T	S	x	x	x	...	x	*	CR
2		n					2	

Message data	Any text string for testing communications containing 514 characters max.
--------------	---

Response

Command code		End code		Message data					Terminator	
T	S	0	0	x	x	x	...	x	*	CR
2		2		n					2	

End code	Indicates the execution result for the command. 00: Normal completion  For details on end codes, refer to <i>End code List</i> .  p.101
----------	--

## VERSION READ (VS)

Reads the Hand-held Reader Writer's model information, software version, and software creation date.

Command

Command code		Terminator	
V	S	*	CR
2		2	

Response

Command code		End code		Message data					Terminator	
V	S	0	0	Model information; software version; software creation date					*	CR
2		2		34					2	

End code	Indicates the execution result for the command. 00: Normal completion  For details on end codes, refer to <i>End code List</i> .  p.101
----------	--

# Controller Control Commands

These commands are used to reset the Controller or set serial communications.

## ABORT (XZ)

This command is used to restore the Hand-held Reader Writer to command wait status when there is no response from the Hand-held Reader Writer due to some problem during communications with the host device or with a Data Carrier.



The ABORT (XZ) command can be used only with the V600-CH1D-V2.  
Do not use it with the V600-CHUD.

CHECK!

Command

Command code Terminator

X	Z	*	CR
2		2	

Response

None

## COMMUNICATIONS CONDITIONS SETTING (TR)

This command is used to set serial communications parameters. The Hand-held Reader Writer must be restarted to make the changes take effect.



The COMMUNICATIONS CONDITIONS SETTING (TR) command can be used only with the V600-CH1D-V2.  
Do not use it with the V600-CHUD.

CHECK!

### Command

Command code    Baud rate    Data length    Parity bits    Stop bits    Terminator

T	R	1	1	1	1	*	CR
2		1	1	1	1	2	

Baud rate	Sets the baud rate. 0: 9,600 bps 1: 2,400 bps 2: 4,800 bps 3: 19,200 bps 4: 38,400 bps Default setting: 9,600 bps
Data length	Sets the data length. 0: 7 bits 1: 8 bits Default setting: 7 bits
Parity	Sets the parity. 0: Even parity 1: Odd parity 2: No parity Default setting: Even parity
Stop bits	Sets the number of stop bits. 0: 2 bits 1: 1 bit Default setting: 2 bits

### Response

Command code    End code    Terminator

T	R	0	0	*	CR
2		2		2	

End code	Indicates the execution result for the command. 00: Normal completion  For details on end codes, refer to <i>End code List</i> . p.101
----------	--

## BASIC FUNCTIONS SETTING (FN)

This command is used to set the Auto Commands OFF function and Normal Operation Output function. The Hand-held Reader Writer must be restarted to make the changes take effect.



Only the Auto Command OFF function is supported by the V600-CHUD. The Normal Operation Output function is not supported by the V600-CHUD.

CHECK!

### Command

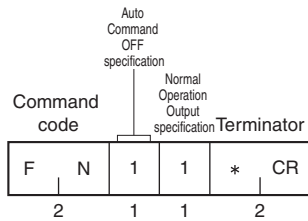

Auto Command OFF specifications	Designates whether the Auto Command OFF function is used. 0: Auto Command OFF used. 1: Auto Command OFF not used. Default setting: Auto Command OFF used.
Normal Operation Output Specification	Designates whether the Normal Operation Output is used. 0: Normal Operation Output used. 1: Normal Operation Output not used. Default setting: Normal Operation Output used.

### Response

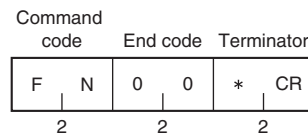

End code	Indicates the execution result for the command. 00: Normal completion  For details on end codes, refer to <i>End code List</i> . p.101
----------	--

## SET INFORMATION READ (UL)

This command is used to read the settings of the Hand-held Reader Writer.



Only the Auto Command OFF function is supported by the V600-CHUD.

The settings made with the COMMUNICATIONS CONDITIONS SETTING (TR) command are not valid for the V600-CHUD.

CHECK!

### Command

Command code	Terminator
U L	* CR
2	2

### Response

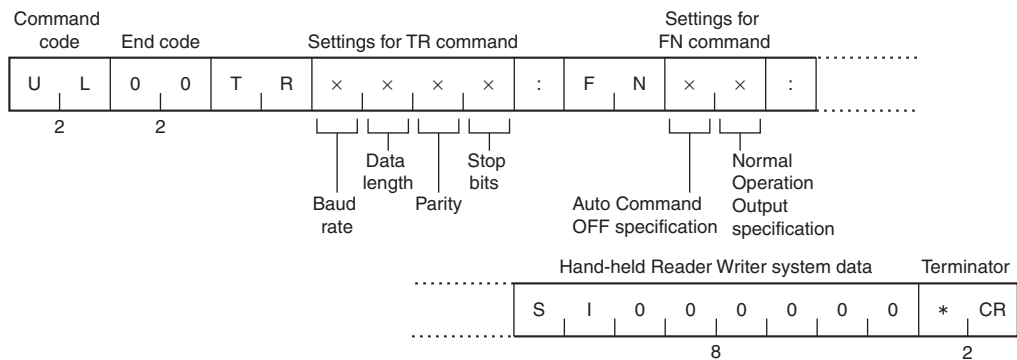

End code	Indicates the execution result for the command. 00: Normal completion  For details on end codes, refer to <i>End code List</i> . p.101	
Settings for TR command	Baud rate	0: 9,600 bps 1: 2,400 bps 2: 4,800 bps 3: 19,200 bps 4: 38,400 bps
	Data length	0: 7 bits 1: 8 bits
	Parity	0: Even parity 1: Odd parity 2: No parity
	Stop bits	0: 2 bits 1: 1 bit
Settings for FN command	Auto Command OFF Specification	0: Auto Command OFF used. 1: Auto Command OFF not used.
	Normal Operation Output Specification	0: Normal Operation Output used. 1: Normal Operation Output not used.
System data	SI000000	

## Other Commands

### UNDEFINED COMMAND RESPONSE (IC)

This command is returned as the response when the Hand-held Reader Writer cannot read the command header.

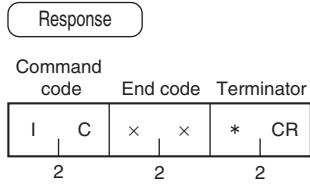

### Error Response

If an error occurs during communications with the host device, or the Data Carrier, error notification is provided in the end code.

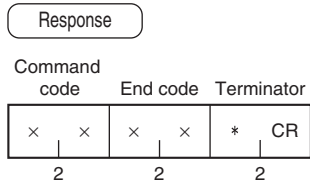

## End code List

End codes are indicated in 2-digit hexadecimal code.

Status	End code	Meaning
Normal	00	Normal completion
	7B	Battery low warning indicating that battery replacement is required (See note 1.)
Host communications error	10 (See note 2.)	Vertical parity error
	11 (See note 2.)	Framing error
	12 (See note 2.)	Overrun error
	14	Format error
	15	Execution status error
	18	Frame length error
Lower communications error	70	Data Carrier communications error
	71	Mismatch error
	72	Data Carrier non-existent error
	76	Data error
	7A	Address error
	7C	Antenna error
	7D	Write protect error
Memory error	93 (See note 2.)	EEPROM memory error

Note 1: A 7B error code response indicates that the command was completed normally, but the battery voltage is low. And the operation indicator will be lit red. If the battery voltage is so low that a response cannot be returned, an error code such as 72 will be returned.

2: Vertical parity errors, framing errors, and overrun errors do not occur for the V600-CHUD.



For details on each error, refer to *Error Tables*.

CHECK!



p.118

MEMO



# Section 4

## Functions

☒ Hand-held Reader Writer	104
Multiple Area Control	104
Auto Command OFF Function	105
Normal Operation Output Function	105
☒ Data Carrier	106
Manufacturing Date Format (Default Setting)	106
Write Protect Function	107
Data Carrier Service Life Detection	111
Memory Check Function in Data Carrier	114

# Hand-held Reader Writer Functions

## Multiple Area Control

The Hand-held Reader Writer can read and write across several non-consecutive Data Carrier memory areas (10 areas max.) at one time. To use this feature, the number of control areas is specified using the NUMBER OF CONTROL AREAS command. ASCII and hexadecimal code can be used simultaneously for the one command control, but reading and writing cannot be performed simultaneously.

Example: Data in the Following 3 Areas are Read

Area (1): Address           0010H  
           Number of bytes   05 bytes  
           Code setting       ASCII

Area (2): Address           0030H  
           Number of bytes   02 bytes  
           Code setting       Hexadecimal

Area (3): Address           0035H  
           Number of bytes   03 bytes  
           Code setting       Hexadecimal

Area (1)	0010H	4	F	"O"
	0011H	4	D	"M"
	0012H	5	2	"R"
	0013H	4	F	"O"
	0014H	4	E	"N"
Area (2)	0030H	1	2	
	0031H	3	4	
Area (3)	0035H	3	1	
	0036H	3	2	
	0037H	3	3	

Command RDA3001005H003002H003503\*CR  
 Response RD00OMRON1234313233\*CR

└───┬───┬───┘  
Area (1) Area (2) Area (3)



Refer to Command and Response Format for more details on ASCII and hexadecimal codes.

CHECK!



p.50

## Auto Command OFF Function

If communications with the Data Carrier do not begin within one minute after an auto command or button auto command is sent from the host device to the Hand-held Reader Writer after entering the Data Carrier wait status, the Auto Command OFF function automatically aborts the auto command and returns a "Data Carrier non-existent" error (error code 72) to the host device. When the Auto Command OFF function is not used, the auto command will not be aborted even if one minute passes after entering the Data Carrier wait status.

This function is set using the BASIC FUNCTIONS SETTING (FN) command.



CHECK!

Refer to the section on the BASIC FUNCTIONS SETTING (FN) command for details on the setting method.



p.98

## Normal Operation Output Function

When the Hand-held Reader Writer is operating normally, this function turns ON the Data Set Ready (DS) output to allow the host device to monitor the operating status of the Hand-held Reader Writer.

This function is set using the BASIC FUNCTIONS SETTING (FN) command.



CHECK!

The Normal Operation Output function cannot be used with the V600-CHUD.

Refer to section on the BASIC FUNCTIONS SETTING (FN) command for details on the setting method.



p.98

## Data Carrier

The memory access space available to the Hand-held Reader Writer is 0000H to 1FFFH, totaling 8 Kbytes. The available access space is determined by the Data Carrier memory capacity. The allocations for the Hand-held Reader Writer's manufacturing date area, write-protect area, and control methods for these areas depend on the type of Data Carrier memory used (SRAM or EEPROM).



For details on the Data Carrier, refer to the Appendices or the *Read/Write Head and Data Carrier Manuals* (Cat. No. Z127-E1, Z128-E1).  
p.121

### Manufacturing Date Format (Default Setting)

#### •Using SRAM (Built-in Battery) Data Carrier

The date of manufacture is registered in the first 2 bytes of the memory area, which control the Data Carrier battery life. This area can be read, but cannot be written to by the user. If a writing operation mistakenly occurs, an error (error code: 7D) will result.

Manufacturing Date Area

Address \ Bit	7	6	5	4	3	2	1	0
0000	Second digit of month				First digit of month			
0001	Second digit of year				First digit of year			

- Note 1. The year of manufacture is represented by the last two digits of the year (for example, "92" for 1992).
- The month of manufacture is represented by two digits (for example, "03" for March and "10" for October).
  - Years from 2000 onwards are represented beginning with 00 (for example, "0400" for April 2000 and "1204" for December 2004).

Example: Manufacturing Date of September 1992

Address \ Bit	7	6	5	4	3	2	1	0
0000	0	0	0	0	1	0	0	1
	0				9			
0001	1	0	0	1	0	0	1	0
	9				2			

#### •Using EEPROM (Without Battery) Data Carrier

There is no manufacturing date area. The start address is a write-protected area.

## Write Protect Function

The write protect function prevents important data stored in the Data Carrier, such as the product type and model, from being overwritten by other data and lost. Use the following methods to set write protection after writing important data.

### •EEPROM Data Carriers (without Battery)

#### Setting the Write Protect Function

The write protect function is set by writing the final address to be protected in address 0000H of the Data Carrier's memory. The area between address 0001H and the write-protect end address will be write-protected. The status of the most significant bit of address 0000H determines whether or not the write protect function is in effect.

Address \ Bit	7	6	5	4	3	2	1	0
0000	Yes/ No							

•Write-protect Bit (Most significant bit of address 0000H)

- 1: Write-protected (Yes)
- 0: Not write-protected (No)

•End address setting range

00H, 01H to 7FH

Address 0080H to 00FFH can therefore not be set as the end address. If the end address is set to 00H, however, all addresses from 0001H to 00FFH will be protected.

#### Write-protect Setting Examples (254-byte Memory Data Carrier)

**(1)The following settings would write-protect addresses 0001H through 0012H:**

Address \ Bit	7	6	5	4	3	2	1	0
0000	1	0	0	1	0	0	1	0
				9		2		



**(2)The entire memory except address 0000H is write-protected by setting the end address to 00H, as shown below.**

(Example: When the end address is 00H)

Address \ Bit	7	6	5	4	3	2	1	0
0000	1	0	0	0	0	0	0	0
				8		0		

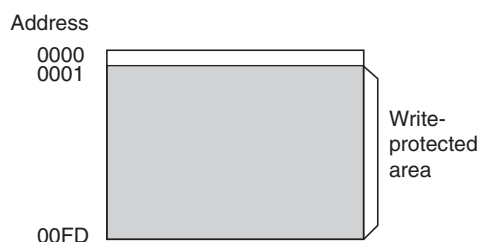

#### Canceling Write Protection

To cancel write protection, turn OFF the most significant bit of address 0000H. The write protection will be cancelled, and the address set in 0000H will be ignored.



CHECK!

Address 0000H is the write protection setting area. Therefore, always structure the data so that any data that needs to be write protected is written in addresses starting from 0001H.

**•SRAM Data Carriers (with Built-in Battery)**

**Setting Write Protect Function**

The write protect function is set in the four bytes of addresses 0002H through 0005H of the Data Carrier's memory. The status of the most significant bit of address 0002H determines whether or not the write protect function is enabled.

Address \ Bit	7	6	5	4	3	2	1	0
0002	Yes/ No	Upper two digits of start address						
0003	Lower two digits of start address							
0004	Upper two digits of end address							
0005	Lower two digits of end address							

**•Write-protect Bit (most significant bit of address 0002H)**

- 1: Data is write-protected
- 0: Data is not write-protected

**•Write Protect Setting Area**

- Start address: 0006H to 1FFFH
- End address: 0006H to 1FFFH

**Settings to write-protect addresses 0006H through 07FFH**

Address \ Bit	Upper digit				Lower digit			
	7	6	5	4	3	2	1	0
0002	1	0	0	0	0	0	0	0
	8				0			
0003	0	0	0	0	0	1	1	0
	0				6			
0004	0	0	0	0	0	1	1	1
	0				7			
0005	1	1	1	1	1	1	1	1
	F				F			

**Settings to not write-protect addresses**

Address \ Bit	Upper digit				Lower digit			
	7	6	5	4	3	2	1	0
0002	0	0	0	0	0	0	0	0
	0				0			
0003	0	0	0	0	0	1	1	0
	0				6			
0004	0	0	0	0	0	1	1	1
	0				7			
0005	1	1	1	1	1	1	1	1
	F				F			

 **WARNING**

The SRAM Data Carrier has a built-in lithium battery that can ignite, combust, or explode if mishandled, which may occasionally result in serious injury. Do not disassemble, pressurize, or deform the Data Carrier, subject it to high temperatures (of 100°C or more), or dispose of it by incineration. Dispose of the Data Carrier as industrial waste.



**Write Protect Setting Examples (2-Kbyte Memory Data Carrier)**

**(1) Settings to Write-protect Addresses 0015H to 0120H**  
(Start address < End address)

Address \ Bit	7	6	5	4	3	2	1	0
0002	1	0	0	0	0	0	0	0
	8				0			
0003	0	0	0	1	0	1	0	1
	1				5			
0004	0	0	0	0	0	0	0	1
	0				1			
0005	0	0	1	0	0	0	0	0
	2				0			

(Hexadecimal)

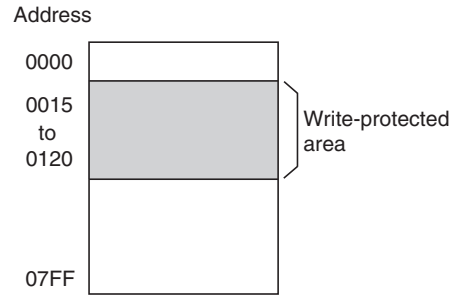

**(2) Settings to Write-protect 1 Byte**  
(Start address = End address)

Specify the same address for the start and end addresses.

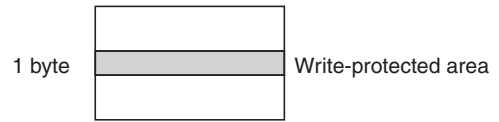

**(3) Settings when the End Address is Greater than the Final Address in the Data Carrier**  
(End address > 07FFH)

The Data Carrier memory area is allocated from address 0000H to 07FFH. Therefore, the addresses up to 07FFH will be write-protected.

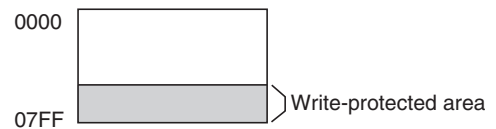

**(4) Settings when the Start Address is Greater than the End Address**  
(Start address > End address)

The area between 0006H and the end address and the area between the start address and 07FFH are write-protected.

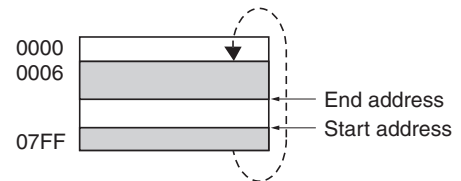

**Canceling Write Protection**

To cancel write protection, turn OFF the most significant bit of address 0002H. The write protection will be cancelled, and the start and end addresses that are set for 0002H to 0005H will be ignored.



## Data Carrier Service Life Detection

The methods used to detect the service life of the Data Carrier depend on the memory type (SRAM or EEPROM). For SRAM, a battery life check is performed, and for EEPROM, the number of overwrites is monitored.

### •SRAM Data Carriers (with Built-in Battery)

#### Checking If the Battery is Low

Built-in Battery (Not Including V600-D2KR16)

(1) A battery-low check for the Data Carrier can only be performed when special access is made. The battery-low check is performed by running a fixed current through the internal circuit of the Data Carrier. If the battery-low check is performed every time access is made, battery power is also consumed. It is recommended that this be included as a routine check, once a day, when creating system programs.

(2) The access method for performing a battery-low check can only be performed when the two bytes of data from addresses 0000H to 0001H are read. Execute one of the following commands to perform a battery-low check.

:

Battery-low Check Commands

a. READ command	RD H/A1 0000 02*CR
b. AUTO READ command	AR H/A1 0000 02*CR
c. BUTTON READ command	BR H/A1 0000 02*CR
d. BUTTON AUTO READ command	UR H/A1 0000 02*CR
e. COPY READ command	RC H/A1 0000 0002*CR
f. EXPANSION DIVIDED READ command	XR H/A1 0000 0002*CR
g. EXPANSION DIVIDED AUTO READ command	NR H/A1 0000 0002*CR
h. EXPANSION BATCH READ command	rd H/A1 0000 0002*CR
i. EXPANSION BATCH AUTO READ command	ar H/A1 0000 0002*CR
j. EXPANSION BATCH BUTTON READ command	br H/A1 0000 0002*CR
k. EXPANSION BATCH BUTTON AUTO READ command	ur H/A1 0000 0002*CR

#### (3) Response for Low Battery

When the battery is low, 7B is given in the end code section within the response format. The operation indicator will be lit red.

Example

Normal

```
RD 00 0995 *CR
AR 00 0995 *CR
Normal  |  Read data
end code |  Manufactured
         |  September 1995
```

Battery Low

```
RD 7B 0992 *CR
AR 7B 0992 *CR
Battery low |  Read data
error code  |  Manufactured
            |  September 1992
```

•A battery low check is performed for V600-D2KR16 Data Carriers with replaceable batteries when the READ/WRITE commands are executed, regardless of the addresses.

## Data Carrier Life after Low Battery Signal Occurs

After a battery-low signal is sent, the Data Carrier can be used for approximately one month in the normal operating state. The Data Carrier should be replaced, however, as soon as possible.



The SRAM Data Carrier (except the V600-D2KR16) is equipped with a thionyl chloride lithium battery. A characteristic of the thionyl chloride lithium battery is that the internal resistance of the battery increases when the battery is left unused for several months. If this occurs and a Data Carrier battery-low check is performed, a low battery response may be returned regardless of whether battery life still remains. This is a result of the increased resistance within the battery, and is not due to the battery life expiring. If a Data Carrier has been left for several months after purchase without being used, use the read operation for approx. 10 minutes to activate the battery before use. (Current will flow in the battery and resistance in the battery will return to normal as a result of activating the battery. The life of the battery will hardly be affected.)

When using V600-D2KR16 Data Carriers with replaceable batteries, the Data Carrier can be used for approximately two weeks in the normal operating state. The battery should be replaced, however, as soon as possible.

### •EEPROM Data Carrier (without Battery)

The OVERWRITE COUNT CONTROL command (MDS) can determine whether the overwrite count for the EEPROM Data Carrier has been exceeded. By executing the OVERWRITE COUNT CONTROL command, the number of overwrites is decremented from the data in the specified overwrite count control area, and whether the data has exceeded the limits is determined.

The overwrite count control area consists of 3 bytes from the start address. The decrement value from the overwrite count is written in this area, and if this value is 0 (00H) an end code 76 will be given as a warning. Therefore, to enable control of the number of overwrites, the maximum number of overwrites must be written to the overwrite count control area beforehand.

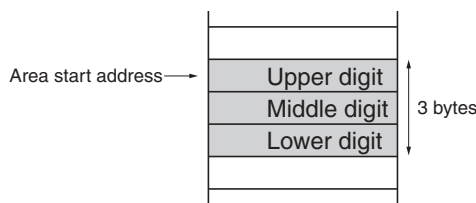

The user-specified number of overwrites can be set to up to 16,700,000. The number of overwrites in the specifications for EEPROM Data Carriers, however, is 300,000 overwrites (0493E0H) at 40°C max., so be sure to set the number of overwrites to 300,000 or lower.

The number of overwrites is controlled using hexadecimal values, and can be read using the READ command.

If the control area data is already 0, the control area value will not be refreshed, and only a warning will be returned as a response. When the refresh count is set as 00H, the count will not be updated, and only an overwrite count check will be performed.



Set the start address to between □□□0H and □□□5H or between □□□8H and □□□DH. If the start address is set between □□□6H and □□□7H or between □□□EH and □□□FH, an address error (error code: 7A hexadecimal) will be returned as the end code.



For details on command format, refer to REF OVERWRITE COUNT CONTROL (MDS).



### Using the OVERWRITE COUNT Command

Example: When the three bytes from address 0010H are used as the overwrite count area.

1. The overwrite count initial value of 100,000 times is written in the control area.  
"WTH10010"
2. Enter the overwrite count of 5.  
"MDS1001005"  
A total of 5 times will be decremented from 100,000.

0010	01H
0011	86H
0012	A0H

0010	01H
0011	86H
0012	9BH

3. The accumulated count is 100,000 times.  
When "MDS1001000" is executed, it will be "MD76" (overwrite count exceeded.)

0010	00H
0011	00H
0012	00H

## Memory Check Function in Data Carrier

A memory check can be made using the DATA CHECK command (MDC/K). A CRC (Cyclic Redundancy Check) code calculation, overwrite, and comparison are made, using the check block units specified by the user. The CRC code is calculated from the generated polynomial expression  $x^{16} + x^{12} + x^5 + 1$ .

The calculation area is the portion of the check block specified by the start address and the number of bytes excluding the last two bytes. The last two bytes are the check code area. When check code write is specified (transaction code: K), the CRC of the calculation area data is calculated and written to the check code area. When data comparison is specified (transaction code: C), the CRC of the calculation area data is calculated and a comparison made with the check code area data. If they coincide, end code 00 is returned, indicating normal transmission, and if they do not coincide, end code 76 is returned as a warning.

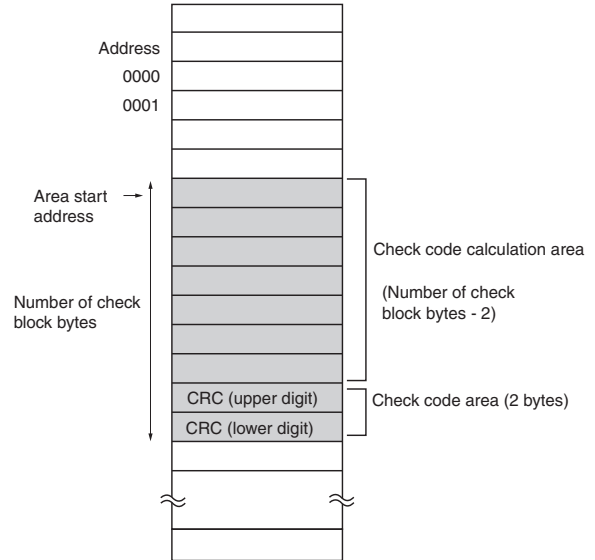

For details on the command format, refer to DATA CHECK (MDC/K).

 p.92

### Example Using the Data Carrier's DATA CHECK Command

In the following example, the data in address 0010H to 0012H is checked.

1. In this example, the following data already exists in the memory.
2. Execute MDK1001005 (calculation transaction).

The CRC code 5CD6 calculated from the data 123456 is written to addresses 0013H and 0014H.

0010	12H
0011	34H
0012	56H
0013	
0014	

0010	12H
0011	34H
0012	56H
0013	5CH
0014	D6H

3. Execute MDC1001005 (comparison transaction). The normal response MD00 will be returned if the data coincides.

0010	12H
0011	34H
0012	56H
0013	5CH
0014	D6H

If the data error occurs, MD76 (a data error warning) will be returned.

0010	00H	← Data error
0011	34H	
0012	56H	
0013	5CH	
0014	D6H	

MEMO

# Section 5

## Troubleshooting

❏ Error Tables	118
Fatal Errors (Operation Stops)	118
Non-fatal Errors (Operation Continues)	118
❏ Troubleshooting Flowchart	119

## Error Tables

If an error occurs in the Hand-held Reader Writer, the operation indicator lights or flashes red to notify the type of error.

### Fatal Errors (Operation Stops)

If a fatal error occurs, the operation indicator will be lit red and all operations of the Hand-held Reader Writer will stop until the power is turned OFF and then ON again.

Name	Operation indicator	Description
Hardware error	Lit red	Hand-held Reader Writer cannot be operated normally.
Memory error	Lit red	The contents of the backup memory in the Hand-held Reader Writer is corrupted.

### Non-fatal Errors (Operation Continues)

If a non-fatal error occurs, the operation indicator will be lit red (or flashing red) and an error code will be returned to the host device.

Name	Operation indicator	Description
Parity error	Flashing red	A parity error has occurred in communications with the host device.
Framing error	Flashing red	A framing error has occurred in communications with the host device.
Overrun error	Flashing red	An overrun error has occurred in communications with the host device.
Format error	Flashing red	The command from the host device was incorrectly formatted.
Frame length error	Flashing red	Command exceeding the maximum frame length was received.
Data Carrier communications error	Lit red	Communications with the Data Carrier could not be performed correctly.
Mismatch error	Lit red	Write control was not performed correctly.
Data Carrier non-existent error	Flashing red	A command that was not an auto command was sent when the Data Carrier was not in the communications area. A command OFF occurred with the auto command.
Address error	Lit red	An address that exceeded the Data Carrier memory area was designated.
Write protect error	Lit red	The manufacturing date area or the write protect area was designated with a WRITE command.

### Battery low warning

A 7B error code response indicates that the command was completed normally, but the battery voltage is low.

Name	Operation indicator	Description
Battery low warning	Lit red	Battery low warning indicating that battery replacement is required.



# Troubleshooting Flowchart

If an error occurs, be sure to understand the conditions thoroughly, then accurately determine the likelihood of the error re-occurring, whether the problem is related to another device, and other factors causing the error, and refer to the following flowcharts for troubleshooting.

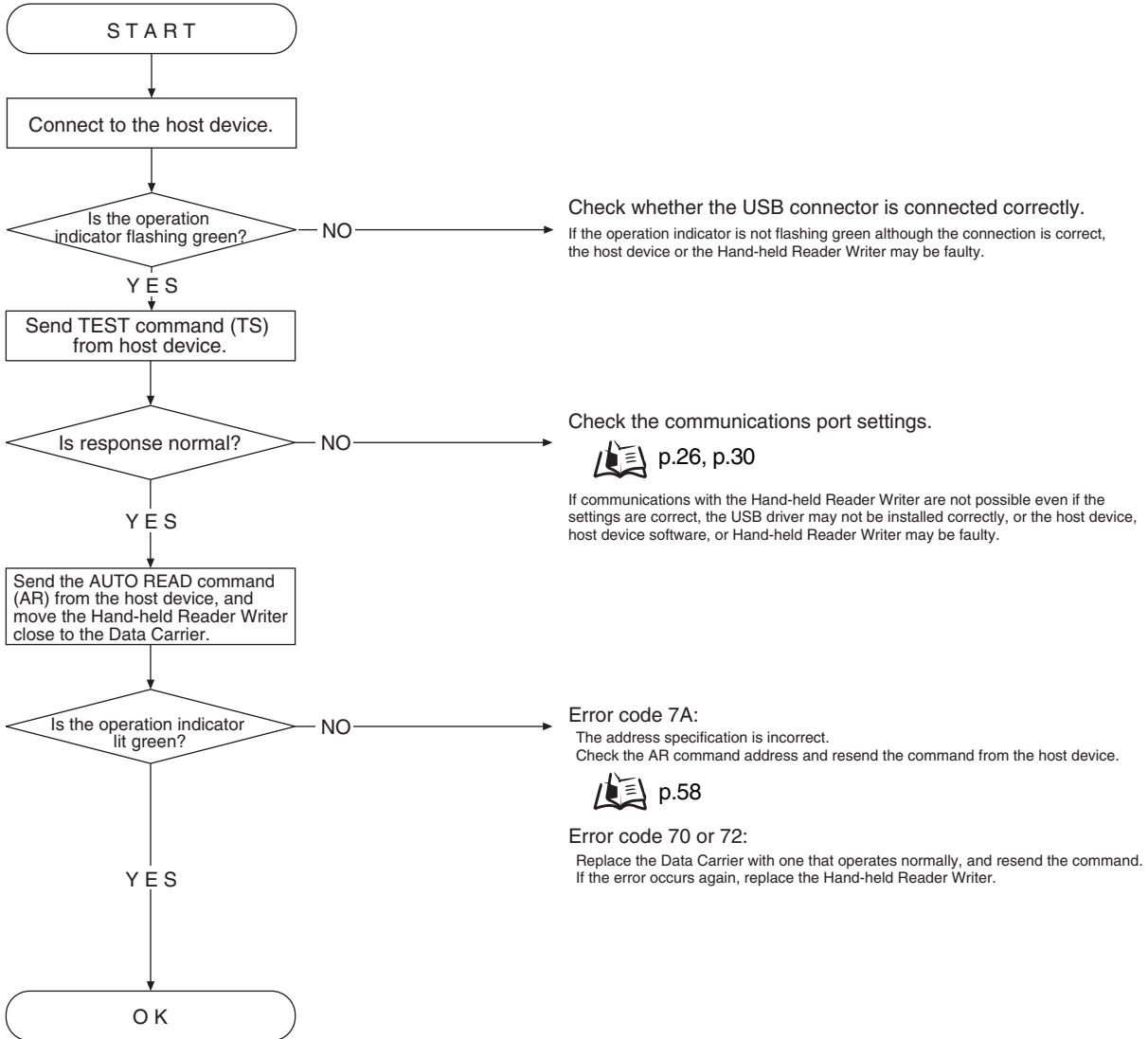

MEMO

# Section 6

## Appendices

☒ Specifications and Dimensions	122
☒ Data Carrier Memory Map	134
☒ Data Carrier Memory Capacity and Data Type (V600 Series)	135
☒ List of ASCII Characters	136
☒ Degree of Protection	137

# Specifications and Dimensions

## General Specifications

Item	Specification		
	V600-CHUD	V600-CH1D-V2	V600-CH1D-PSI
Supply voltage	5.0 VDC ±5%		
Ambient operating temperature	-10 to 55°C		
Ambient operating humidity	35% to 85% (with no condensation)		
Ambient storage temperature	-25 to 65°C		
Ambient storage humidity	35% to 85% (with no condensation)		
Degree of protection	IEC60529, IP63 (See note.)		
Weight	Approx. 120 g (with cables and connectors)	Approx. 160 g (with cables and connectors)	Approx. 110 g (with cables and connectors)
Current consumption	250 mA max. (supply voltage: 5.0 V)		
Material	Case: ABS resin; Nameplate: PET resin		
Vibration resistance	10 to 150 Hz, 0.2-mm double amplitude at 15 m/s <sup>2</sup> acceleration in 6 directions 10 times for 8 minutes each		
Shock resistance	150 m/s <sup>2</sup> (approx. 15G), 3 times each in 6 directions (up, down, right, left, forward, reverse)		
Insulation resistance	50 MΩ min. (at 500 VDC) between connector terminals and case		
Dielectric strength	1,000 VAC, 50/60 Hz for 1 min between connector terminals and case (leakage current: 1 mA max.)		
Cable length	0.8 m, 1.9 m	2.5 m	0.8 m

**Note:** This does not include the connector section. The main unit is not resistant to chemicals or oils.

## Performance Specifications

Item	Specification
Diagnostic function	Checks for CPU errors.

## V600-A22 Specifications

Item	Specification
Input voltage	100 to 120 VAC at 50/60 Hz
Input current	200 mA±20% (100 VAC) 170 mA±20% (120 VAC)
Output voltage	5 VDC±0.25 V
Ambient operating temperature	0 to 40°C
Ambient storage temperature	-40 to 70°C
Ambient storage humidity	25% to 85%
Insulation resistance	100 MΩ min. (at 500 VDC) between input terminals and output terminals
Dielectric strength	1,500 VAC for 1 min between input terminals and output terminals (leakage current: 5 mA max.)
Weight	Approx. 85 g
Applicable standards	UL and CSA

## Communications Specifications

### •Host Communications Interface Specifications

#### V600-CHUD

Item	Specification
Connectors (connector connection status)	Series A plug
USB specifications	Ver 1.1
Baud rate	Full speed (12 Mbps)
Device class	COM class
Vendor ID	Hexadecimal format [0590]
Product ID	Hexadecimal format [0048]



Use the host communications interface as the COM port for the host device.

CHECK!

#### V600-CH1D-V2, V600-CH1D-PSI

Item	Specification	
	V600-CH1D-V2	V600-CH1D-PSI
Connector	D-Sub 9-pin (applicable to IBM PC/AT or compatible) (See note 1.)	D-Sub 9-pin
Standard compliance	RS-232C	
Transmission line connection	1:1	
Communications method	Two-wire, half duplex	
Synchronization method	Asynchronous (stop bit: 1 or 2) (See note 2.)	
Baud rate	2,400, 4,800, 9,600, 19,200, 38,400 bps (See note 2.)	
Transmission code	7-unit ASCII or 8-unit JIS (See note 2.)	
Communications control	1:1	
Error detection	Vertical parity (even/odd/none) (See note 2.)	

Note 1: For conversion to a 25-pin connector, use the SGC-X9P/25P-2 manufactured by Sunhayato, or an equivalent.

Note 2: Set by a settings command.

## Dimensions

V600-CHUD

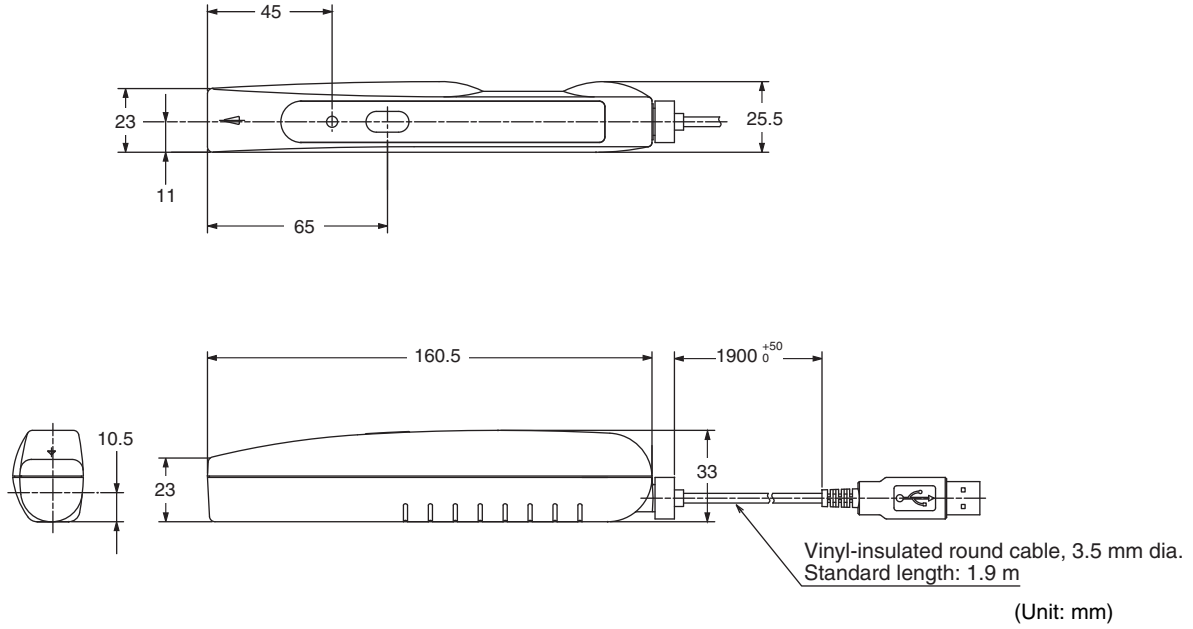

V600-CH1D-V2

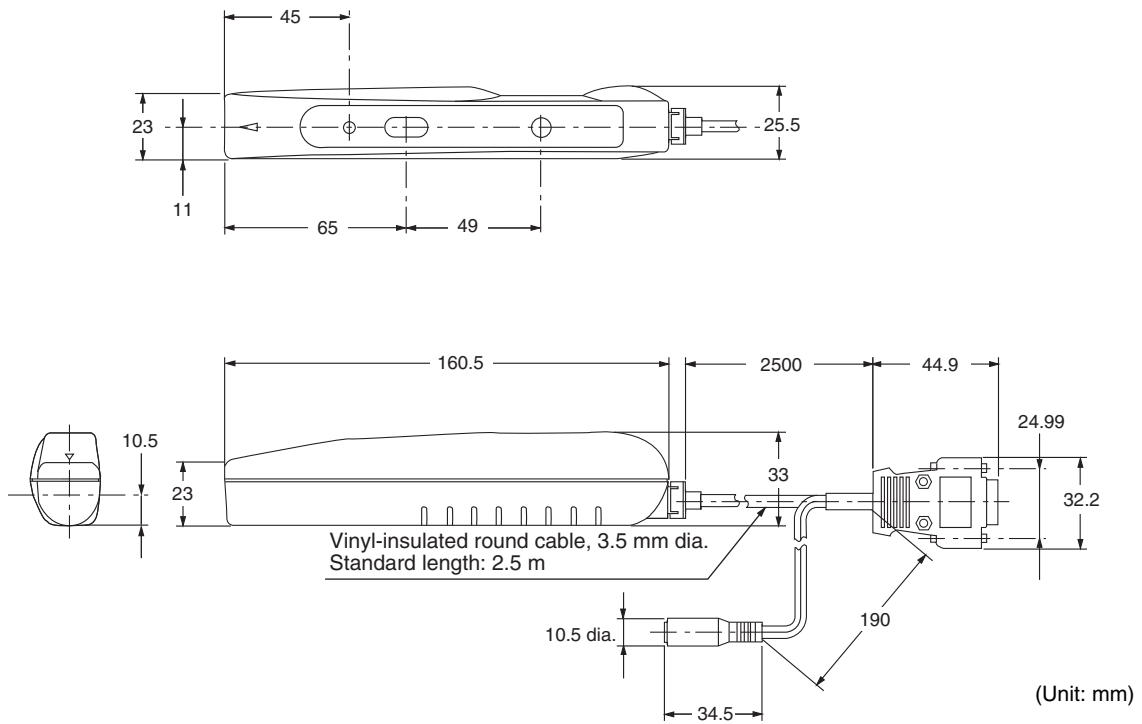

V600-CH1D-PSI

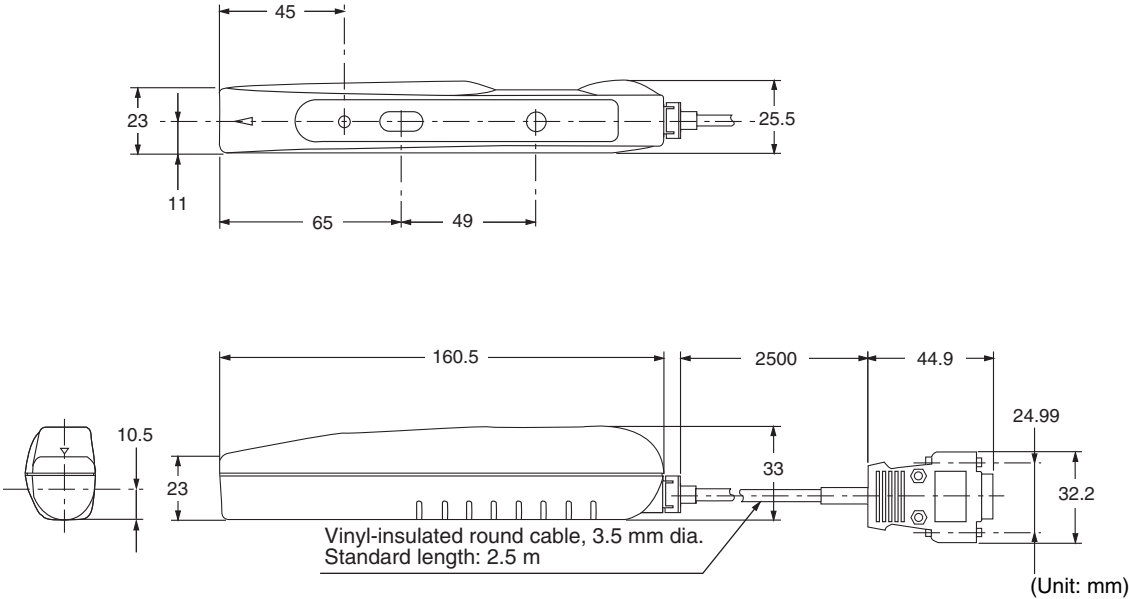

V600-A22

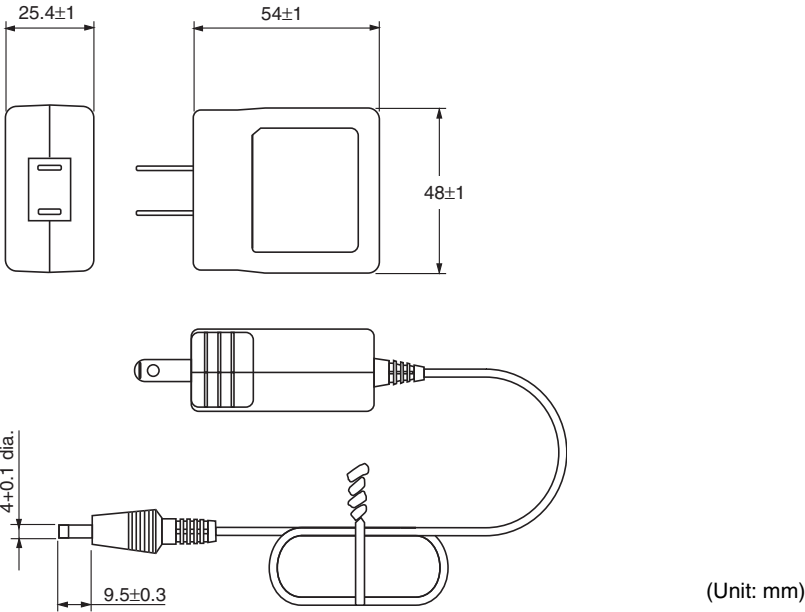

## Transmission Specifications

Transmission with the currently available V600-series Data Carriers is possible.

### •Transmission Distances

Data Carrier	Transmission distance
V600-D23P53	0 to 2.5 mm
V600-D23P54	0 to 4 mm
V600-D23P55	0 to 10 mm
V600-D23P61	0 to 11 mm
V600-D23P66N	0 to 17 mm (See note 2.)
V600-D23P66SP	0 to 12 mm
V600-D23P71	0 to 25 mm
V600-D23P72	0 to 23 mm
V600-D8KR04	0 to 35 mm
V600-D8KR12D	0 to 25 mm
V600-D8KR13	0 to 20 mm
V600-D2KR16	0 to 10 mm
V600-D8KF04	0 to 18 mm

#### Note 1: Data Carrier Installation Conditions

V600-D23P53/P54	Embedded in metal (iron).
V600-D23P55	Embedded in resin
V600-D23P61	Metal (iron) on the back surface of the Data Carrier.
V600-D23P66N/P66SP/P71/P72	Resin on the back surface of the Data Carrier. Data Carrier (no metal on back surface)
V600-D8KR04/R12D/R13/D8KF04	Metal (iron) on the back surface of the Data Carrier.
V600-D2KR16	Data Carrier installed on a bracket and attached to a metal (aluminium) plate.

Note 2: When using the V600-D23P66N at temperatures of  $-10^{\circ}\text{C}$  or lower, transmission may not be possible at the specified distance. In this case, move the Reader Writer slightly further away from the Data Carrier.



•Transmission Range (Reference)

V600-D23P53

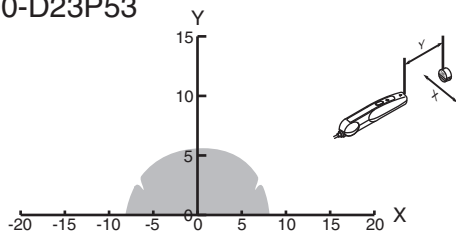

V600-D23P54

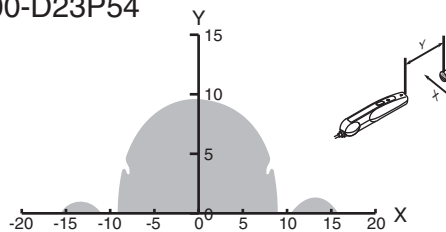

V600-D23P55

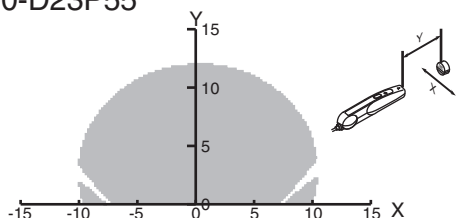

V600-D23P61

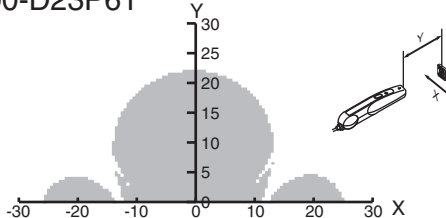

V600-D23P66N

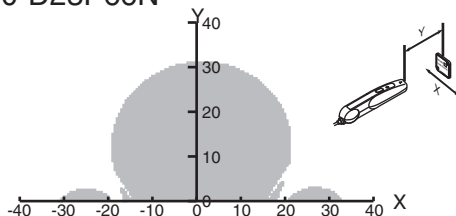

V600-D23P66SP

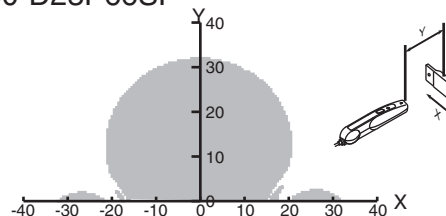

V600-D23P71

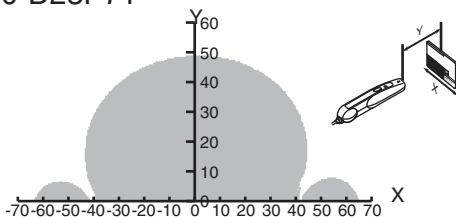

V600-D23P72

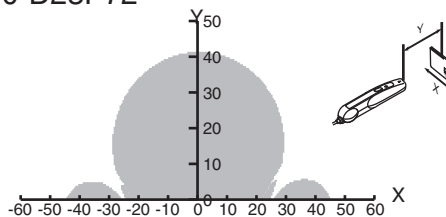

V600-D2KR16

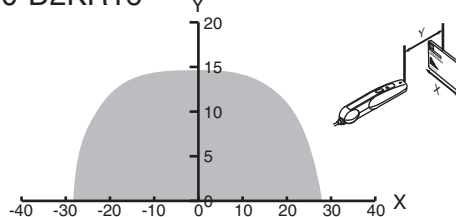

V600-D8KR04

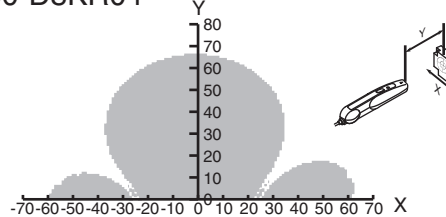

V600-D8KR12D

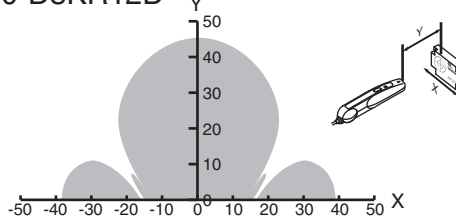

V600-D8KR13

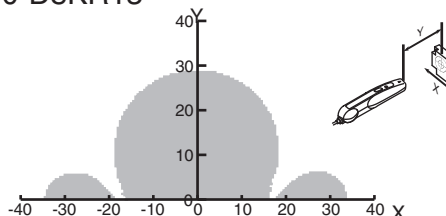

V600-D8KF04

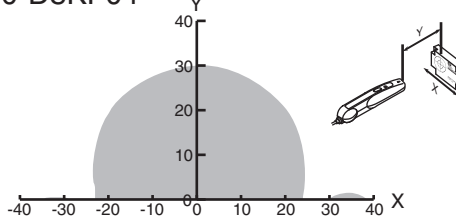

(Unit: mm)

## Communications Time

Communications time differs according to the type of Data Carrier memory (SRAM or EEPROM). TAT (Turn Around Time) and transmission time are displayed as communication times. TAT represents the total time from when a command is first sent from the host device until a response is received. The transmission time represents the time required for communications between the Hand-held Reader Writer and the Data Carrier, not including communications with the host device.

Example

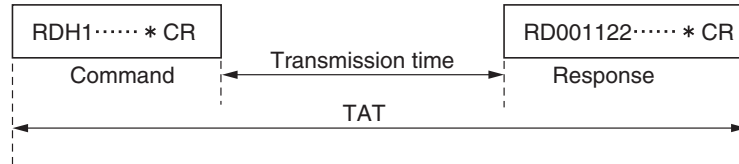

- SRAM Data Carrier (Reference)
- TAT

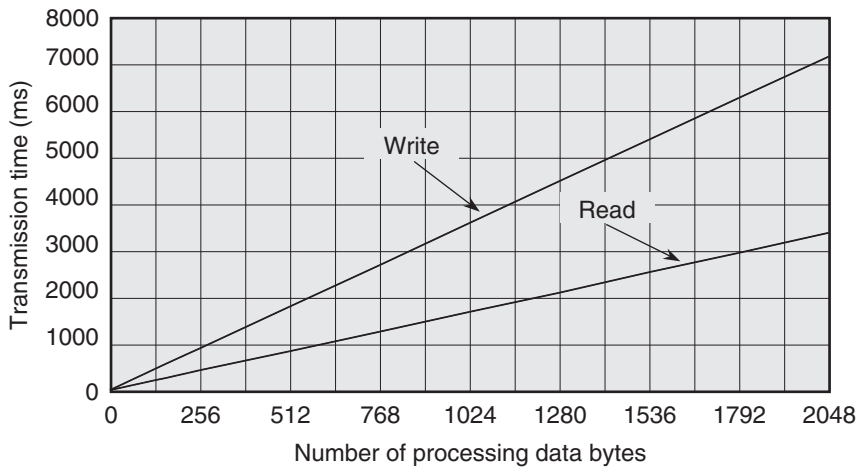

- Transmission Time

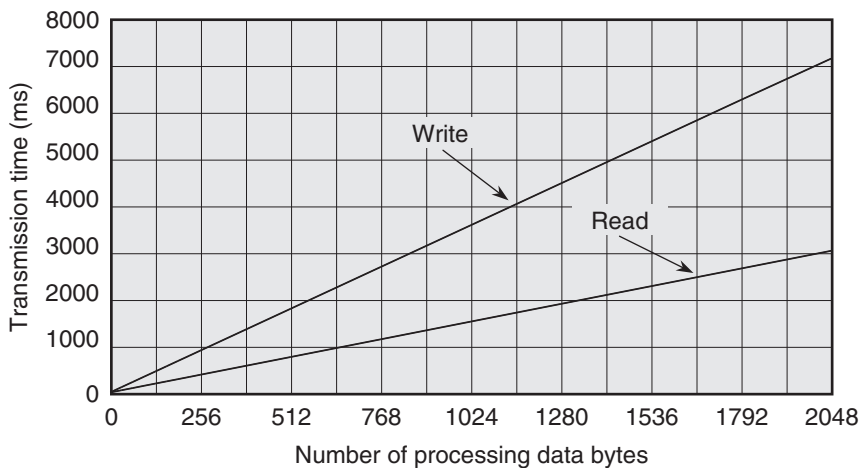

### Calculation Method

Operation	Transmission time (ms)
Read	$T=1.5N+36.7$
Write	$T=3.5N+51.2$

N: Number of processing data

- EEPROM Data Carrier (Reference)
- TAT

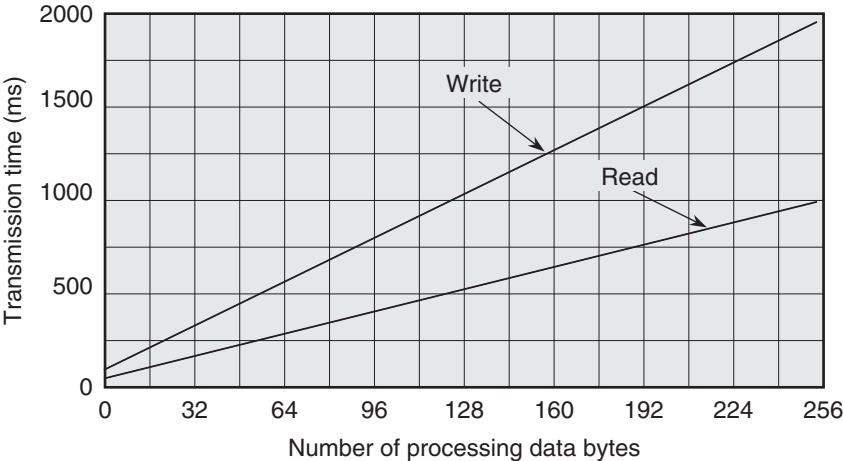

•Transmission Time

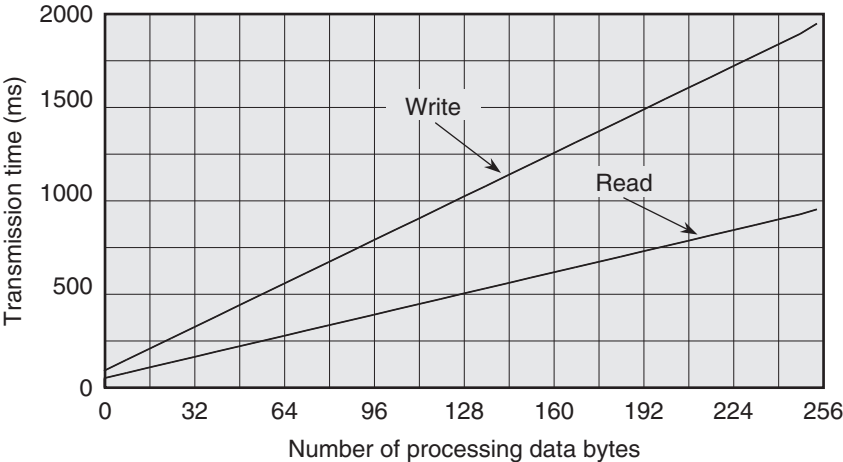

Calculation Method

Operation	Transmission time (ms)
Read	$T=3.6N+53.7$
Write	$T=7.3N+90.3$

N: Number of processing

- Fe-RAM Data Carrier (Reference)
- TAT

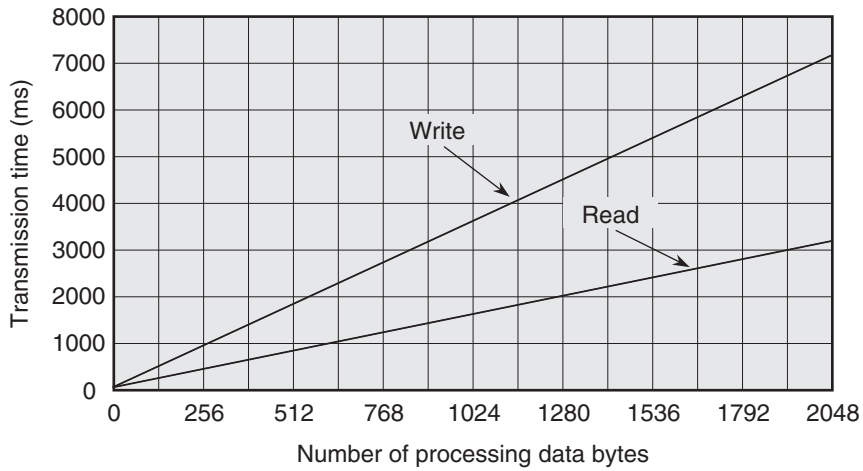

•Transmission Time

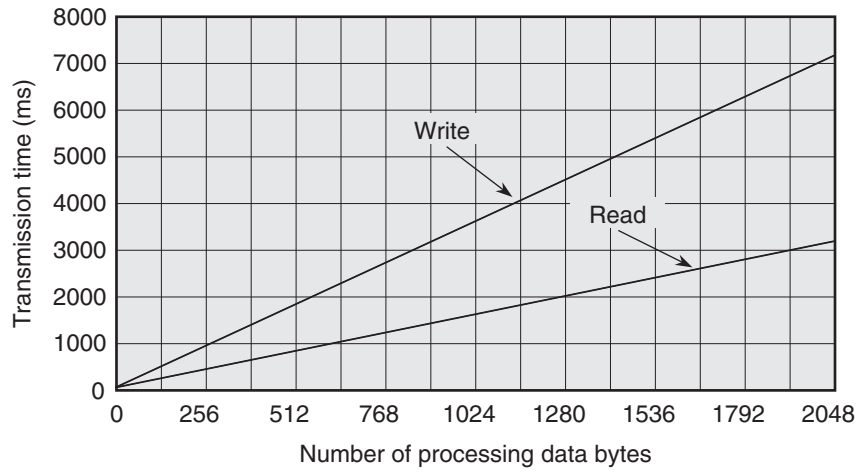

Calculation Method

Operation	Transmission time (ms)
Read	$T=1.5N+61.0$
Write	$T=3.5N+75.1$

N: Number of processing

**Note:** The number of TAT data bytes represents the number of bytes when ASCII code is specified.

V600-CH1D-V2

- SRAM Data Carrier (Reference)
- TAT

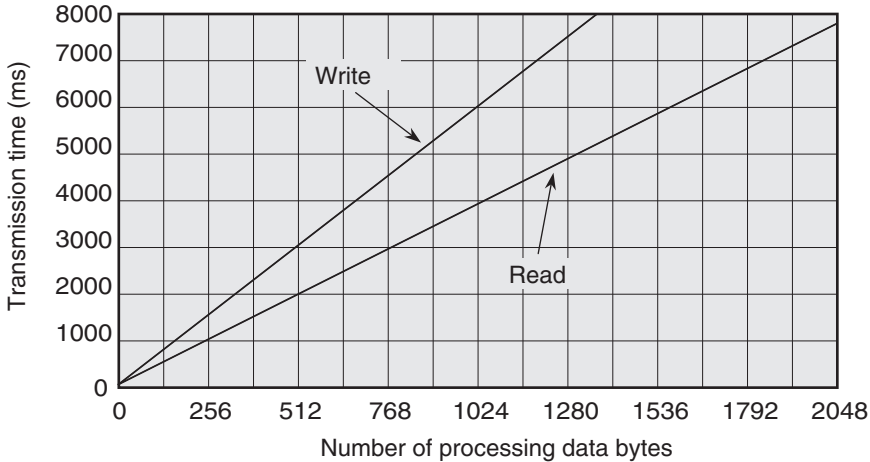

•Transmission Time

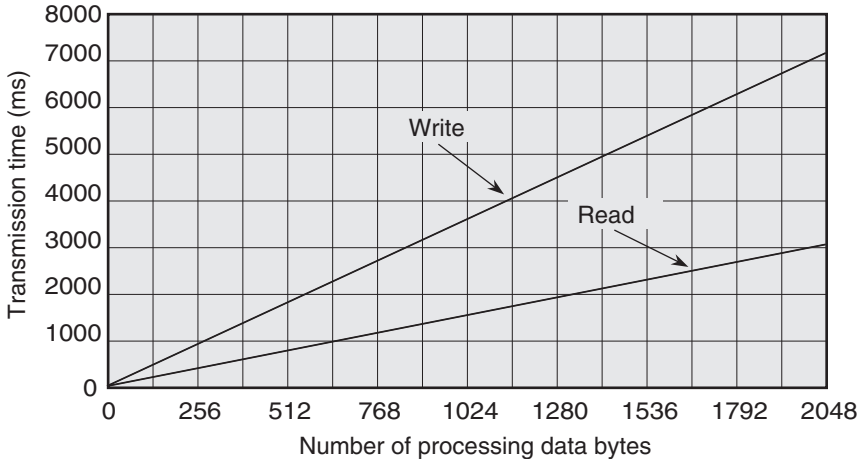

Calculation Method

Operation	Transmission time (ms)
Read	$T=1.5N+37.0$
Write	$T=3.5N+51.3$

N: Number of processing

- EEPROM Data Carrier (Reference)
- TAT

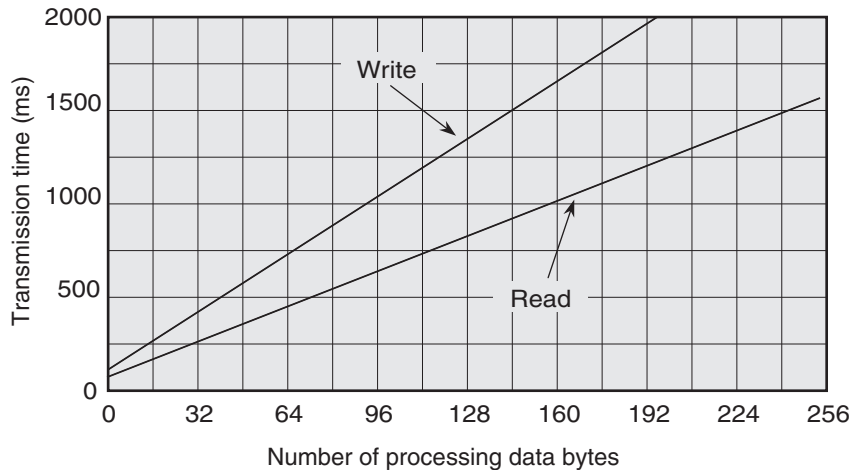

- Transmission Time

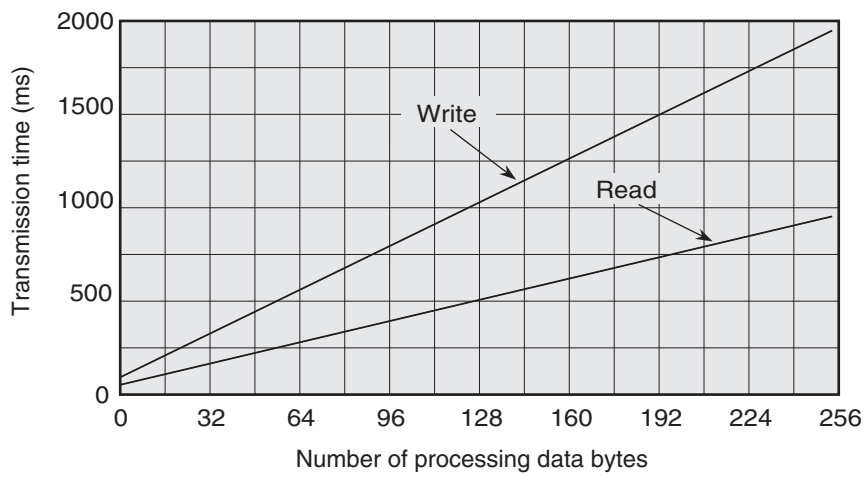

Calculation Method

Operation	Transmission time (ms)
Read	$T=3.8N+61.2$
Write	$T=5.8N+69.9$

N: Number of processing

•Fe-RAM Data Carrier (Reference)

•TAT

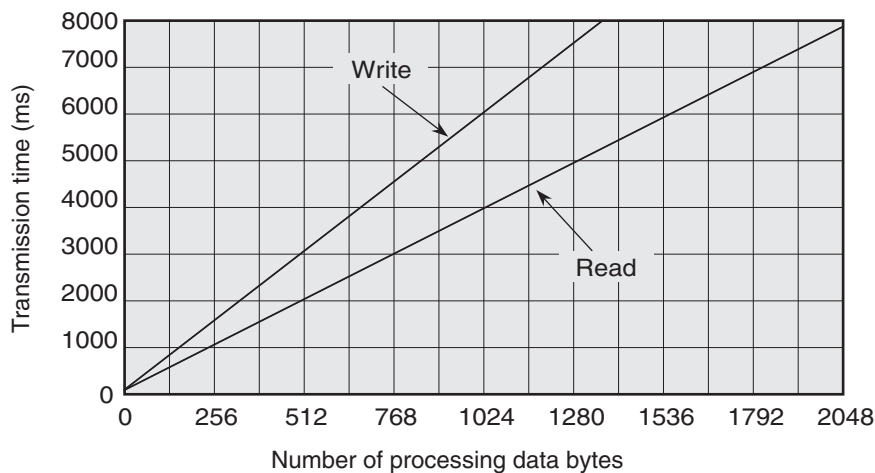

•Transmission Time

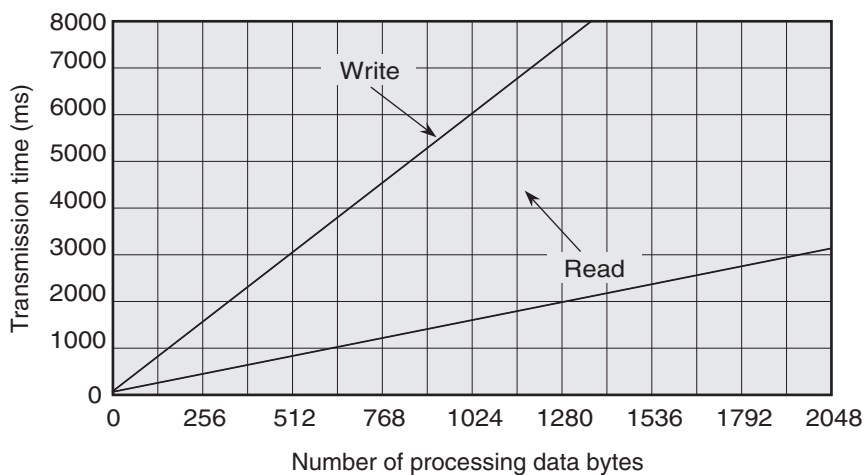

Calculation Method

Operation	Transmission time (ms)
Read	$T=1.5N+61.6$
Write	$T=3.5N+75.8$

N: Number of processing

Note 1: Communications specifications for TAT data with the host device represent values with a baud rate of 9,600 bps, a bit length of 7 bits, 2 stop bits, and even parity. In this example, characters are sent consecutively, with no spaces between them.

Note 2: The number of bytes in the TAT data is the number for ASCII encoding.

# Data Carrier Memory Map

•Data Carrier (Memory ≤ 256 Bytes)

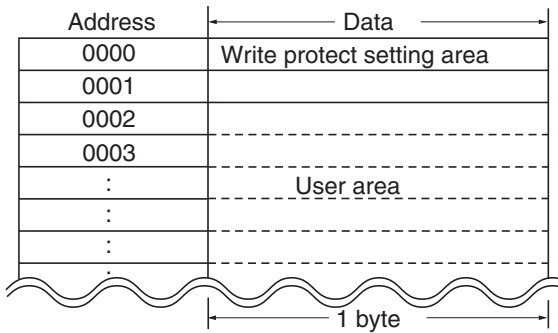

•Data Carrier (Memory > 256 Bytes)

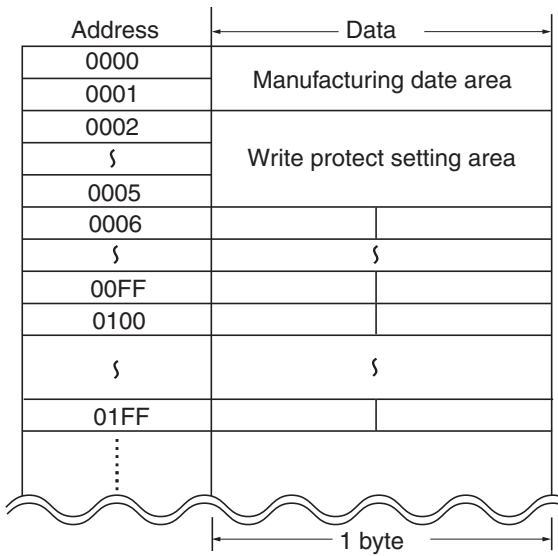

For more information on Data Carrier memory capacity and memory type, refer to Data Carrier Memory Capacity and Data Type (V600 Series).



## Data Carrier Memory Capacity and Data Type (V600 Series)

(As of June 2020)

Model	Memory capacity (user memory)	Memory type	Life expectancy
V600-D8KR12D V600-D8KR13 V600-D8KR04	2 Kbytes	S-RAM	5 years (–25 to +70°C) 8 years (–25 to +70°C)
V600-D2KR16	2 Kbytes	SRAM (replaceable battery)	2 years (+25°C)
V600-D23P53 V600-D23P54 V600-D23P55 V600-D23P61 V600-D23P71 V600-D23P72 V600-D23P66N V600-D23P66SP	254 bytes	EEPROM	<ul style="list-style-type: none"> <li>•Overwrite operations: 100,000 times (300,000 times at operating temperature between lower limit and 40 °C)</li> <li>•Data retention: 10 years</li> </ul>
V600-D8KF04	8 Kbytes	Fe-RAM	<ul style="list-style-type: none"> <li>•Overwrite operations: 1,000,000,000 times</li> <li>•Data retention: 10 years</li> </ul>

### WARNING

The SRAM Data Carrier has a built-in lithium battery that can ignite, combust, or explode if mishandled, which may occasionally result in serious injury. Do not disassemble, pressurize, or deform the Data Carrier, subject it to high temperatures (of 100°C or more), or dispose of it by incineration. Dispose of the Data Carrier as industrial waste.



# List of ASCII Characters

Left digit Right digit	b8 to b5	0000	1001	0010	0011	0100	0101	0110	0111	1000	1101	1010	1011	1100	1101	1110	1111
	b4 to b1 Col- umn Row	0	1	2	3	4	5	6	7	8	9	10	11	12	13	14	15
0000	0	NUL	TC <sub>7</sub> (DLE)	(SP)	0	@	P	`	p	Undefined	Undefined	Undefined	Undefined	Undefined	Undefined	Undefined	Undefined
0001	1	TC <sub>1</sub> (SOH)	DC <sub>1</sub>	!	1	A	Q	a	q								
0010	2	TC <sub>2</sub> (STX)	DC <sub>2</sub>	"	2	B	R	b	r								
0011	3	TC <sub>3</sub> (ETX)	DC <sub>3</sub>	#	3	C	S	c	s								
0100	4	TC <sub>4</sub> (EOT)	DC <sub>4</sub>	\$	4	D	T	d	t								
0101	5	TC <sub>5</sub> (NEQ)	TC <sub>8</sub> (NAK)	%	5	E	U	e	u								
0110	6	TC <sub>6</sub> (ACK)	TC <sub>9</sub> (SYN)	&	6	F	V	f	v								
0111	7	BEL	TC <sub>10</sub> (ETB)	'	7	G	W	g	w								
1000	8	FE <sub>0</sub> (BS)	CAN	(	8	H	X	h	x								
1001	9	FE <sub>1</sub> (HT)	EM	)	9	I	Y	i	y								
1010	10	FE <sub>2</sub> (LF)	SUB	*	:	J	Z	j	z								
1011	11	FE <sub>3</sub> (VT)	ESC	+	;	K	[	k	{								
1100	12	FE <sub>4</sub> (FF)	IS <sub>4</sub> (FS)	,	<	L	\	l									
1101	13	FE <sub>5</sub> (CR)	IS <sub>3</sub> (GS)	-	=	M	]	m	}								
1110	14	SO	IS <sub>2</sub> (RS)	.	>	N	^	n	-								
1111	15	SI	IS <sub>1</sub> (US)	/	?	O	-	o	DEL								

**Note:** Do not use the undefined areas.

# Degree of Protection

International protection degrees (IP-□□) are determined by the following tests. Be sure to check the sealing capability under the actual operating environment and conditions before actual use.

•IEC (International Electrotechnical Commission) Standards (IEC60529 November 2001)

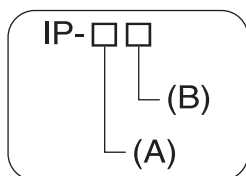







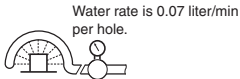

## Degree of Protection from Solid Materials

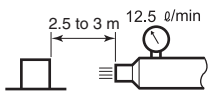
Degree	Protection	
0		No protection
1		Protects against penetration of any solid object such as a hand that is 50 mm or more in diameter.
2		Protects against penetration of any solid object, such as a finger, that is 12.5 mm or more in diameter.
3		Protects against penetration of any solid object, such as a wire, that is 2.5 mm or more in diameter.
4		Protects against penetration of any solid object, such as a wire, that is 1 mm or more in diameter.
5		Protects against penetration of dust of a quantity that may cause malfunction or obstruct the safe operation of the product.
6		Protects against penetration of all dust.

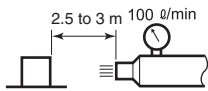
## Degree of Protection Against Water

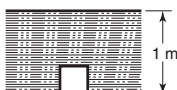
Degree	Protection		Test method (with fresh water)
0	No protection	Not protected against water.	No test
1	Protection against water drops 	Protects against vertical drops of water towards the product.	Water is dropped vertically towards the product from the test machine for 10 min. 
2	Protection against water drops 	Protects against drops of water approaching at a maximum angle of 15° to the left, right, back, and front of vertical towards the product.	Water is dropped for 2.5 min each (i.e., 10 min in total) towards the product inclined 15° to the left, right, back, and front from the test machine. 
3	Protection against sprinkled water 	Protects against sprinkled water approaching at a maximum angle of 60° from vertical towards the product.	Water is sprinkled at a maximum angle of 60° to the left and right from vertical for 10 min from the test machine.  

Degree	Protection		Test method (with fresh water)
4	Protection against water spray 	Protects against water spray approaching at any angle towards the product.	Water is sprayed at any angle towards the product for 10 min from the test machine. 
5	Protection against water jet spray 	Protects against water jet spray approaching at any angle towards the product.	Water is jet sprayed at any angle towards the product for 1 min per square meter for at least 3 min in total from the test machine. Discharging nozzle: 6.3 dia. 
6	Protection against high pressure water jet spray 	Protects against high-pressure water jet spray approaching at any angle towards the product.	Water is jet sprayed at any angle towards the product for 1 min per square meter for at least 3 min in total from the test machine. Discharging nozzle: 12.5 dia. 
7	Protection underwater 	Resists the penetration of water when the product is placed underwater at specified pressure for a specified time.	The product is placed 1 m deep in water (if the product is 850 mm max. in height) for 30 min. 
8 (See note.)	Protection underwater 	Can be used continuously underwater.	The test method is determined by the manufacturer and user.

Note: OMRON Test Method

Usage condition: 10 m or less under water in natural conditions

1. No water ingress after 1 hour under water at 2 atmospheres of pressure.
2. Sensing distance and insulation resistance specifications must be met after 100 repetitions of half hour in 5°C water and half hour in 85°C water.

About IPX9K

IPX9K is a protection standard regarding high temperature and high-pressure water which is defined by the German standard (DIN 40050 PART9).

Water is sprayed on 80 °C hot water with the water pressure of 80 to 100BAR from a nozzle to the test piece.

Amount of water is 14 to 16 liters/minute.

The distance between the test piece and a nozzle is 10 to 15 cm, and the directions of water-drainage are 0 degrees, 30 degrees, 60 degrees, and 90 degrees horizontally.

They are evaluated with the test piece is rotating on a horizontal plane by 30 seconds in each direction.

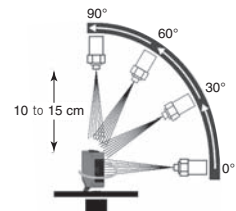

### •Oil resistance (OMRON in-house standard)

Protection	
Oil-resistant	No adverse affect from oil drops or oil spray approaching from any direction.
Oil-proof	Protects against penetration of oil drops or oil spray approaching from any direction.

**Note.** Oil resistance has been tested using a specific oil as defined in the OMRON test method. (JIS C 0920:2003, Appendix 1)

MEMO

# Revision History

---

A manual revision code appears as a suffix to the catalog number at the bottom of the front and rear pages.

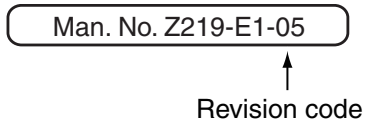

Revision code	Date	Revised contents
01	February 2005	Original production
02	September 2008	Added information on installing the USB driver for Vista. Added information on V600-CH1D-V2, V600-A22, and V600-D8KF04.
02A	April 2014	Added information on V600-CH1D-PSI. Deleted information about the Regulations and Standards. and made other minor corrections.
03	March 2015	Changed the type of Hand-held Terminal manufactured by Zebra Technologies, Inc.
04	September 2016	Minor corrections.
05	June 2020	Changes due to the end of production of V600-D8KR12 Tag



**OMRON Corporation Industrial Automation Company**  
Tokyo, JAPAN

Contact: [www.ia.omron.com](http://www.ia.omron.com)

**Regional Headquarters**

**OMRON EUROPE B.V.**

Wegalaan 67-69, 2132 JD Hoofddorp  
The Netherlands

Tel: (31)2356-81-300/Fax: (31)2356-81-388

**OMRON ELECTRONICS LLC**

2895 Greenspoint Parkway, Suite 200  
Hoffman Estates, IL 60169 U.S.A

Tel: (1) 847-843-7900/Fax: (1) 847-843-7787

**OMRON ASIA PACIFIC PTE. LTD.**

No. 438A Alexandra Road # 05-05/08 (Lobby 2),  
Alexandra Technopark,  
Singapore 119967

Tel: (65) 6835-3011/Fax: (65) 6835-2711

**OMRON (CHINA) CO., LTD.**

Room 2211, Bank of China Tower,  
200 Yin Cheng Zhong Road,  
PuDong New Area, Shanghai, 200120, China

Tel: (86) 21-5037-2222/Fax: (86) 21-5037-2200

**Authorized Distributor:**

© OMRON Corporation 2005-2020 All Rights Reserved.  
In the interest of product improvement,  
specifications are subject to change without notice.

**Man. No. Z219-E1-05**

0620(0205)