

QG

APPENDIX: APPLICATIONS

THIS MANUAL CONTAINS:

1 PROGRAMMING EXAMPLES

- 1.1 SWITCHED LIGHT FITTINGS**
- 1.2 TIMED LIGHT FITTINGS**
- 1.3 LIGHT FITTINGS USING HOLDING RELAYS**
- 1.4 LIGHT FITTINGS USING WEEKLY TIMER CLOCK**
- 1.5 AUTOMATIC STAIR LIGHTING**

2 PROGRAMMING APPLICATIONS

- 2.1 SINGLE BLINDS**
- 2.2 2 BLINDS SET WITH ANEMOMETER AND TIMER**
- 2.3 TECHNICAL ALARMS (FLOODS, GAS LEAKS AND 24V FIRES)**
- 2.4 TECHNICAL ALARMS (FLOODS, GAS LEAKS AND 230V FIRES)**
- 2.5 HEATING CONTROL**
- 2.6 STREET LIGHTING CONTROL**

1 Programming examples

1.1 Switched light fittings (teleswitch function)

With this programming model, it is possible to control a light fitting by using local switches.

Connection

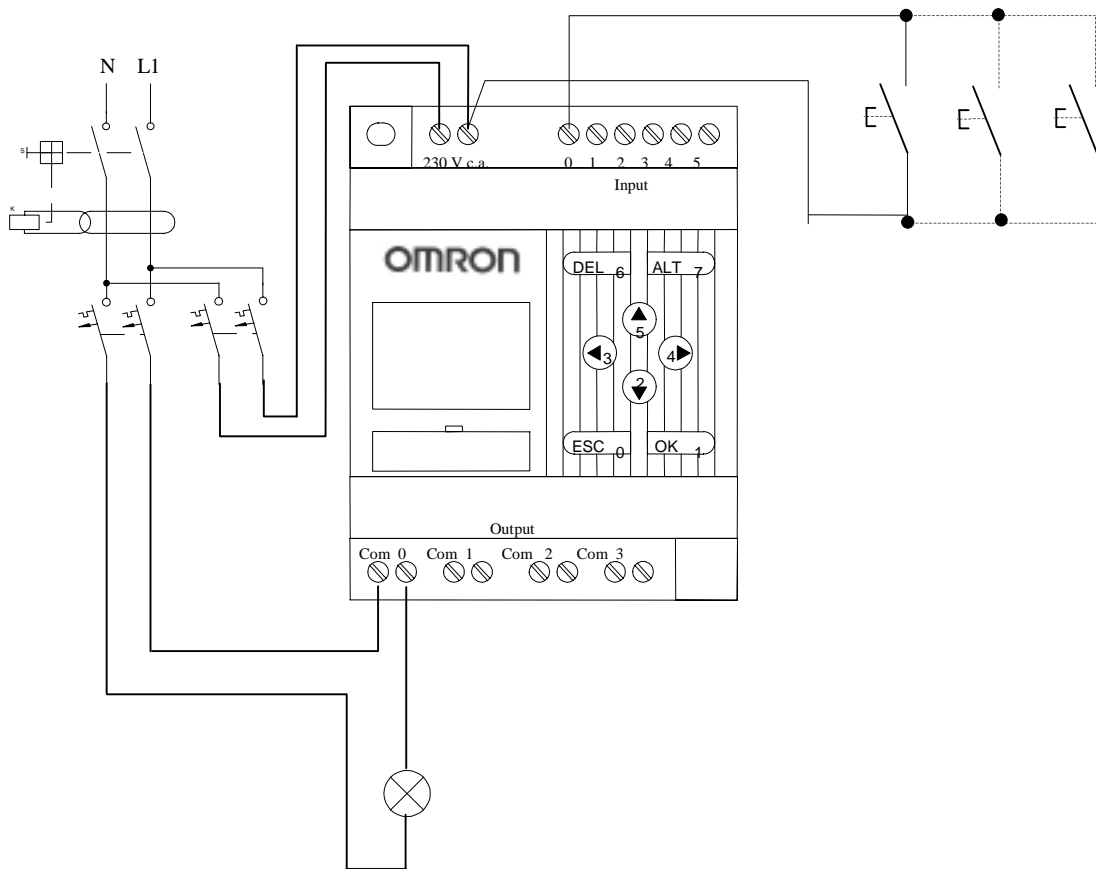

Program

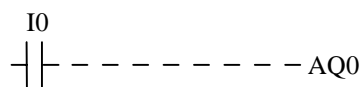

Operation

By activating the switch (or switches), the status of the light fitting can be switched. This means that if the light fitting is off, activating the switch will turn it on and if the light fitting is on, activating the switch will turn it off. This function is known as the teleswitch.

Applications

The function can be applied to all light fittings with the advantage of being able to increase the control points by simply connecting the required number of switches in parallel. Thus, there is no need to install switches and crossovers.

1.2 Timed light fittings

As well as the teleswitch function (see example 1), this program activates the automatic timed disconnection of the lamp if it remains on. This example is very useful in bathrooms.

Connection

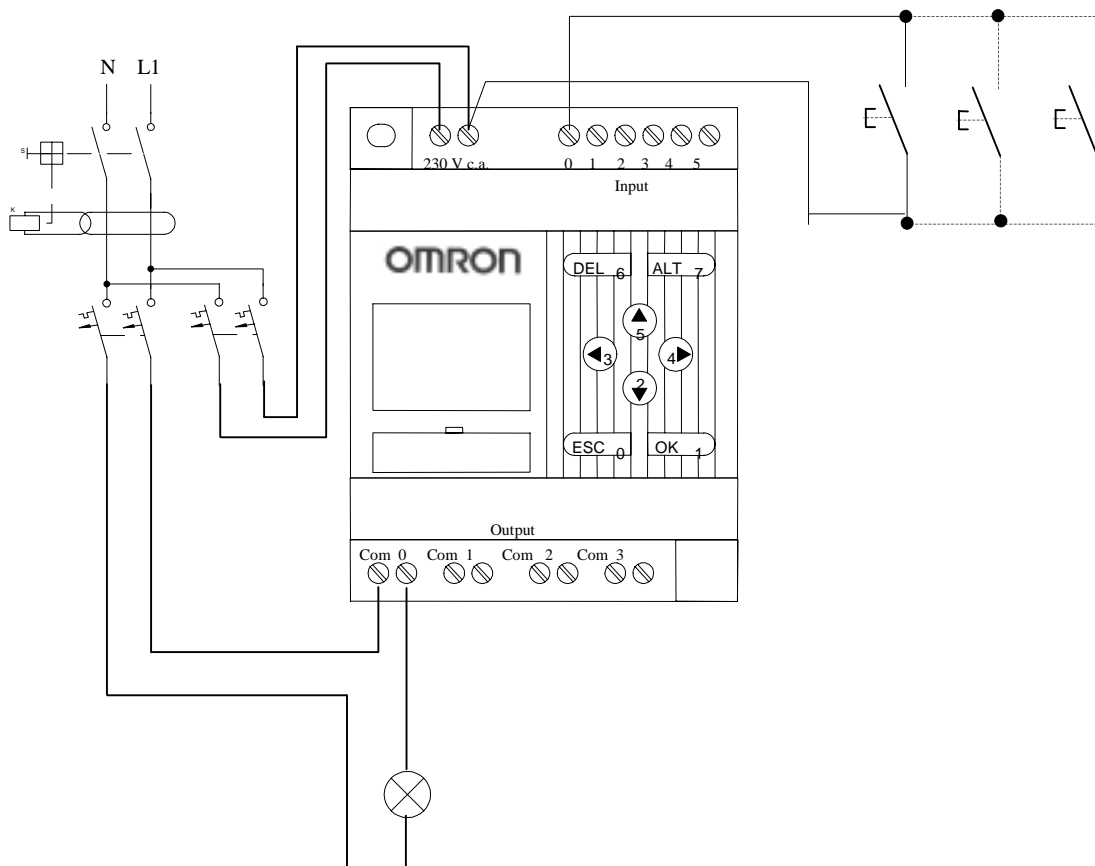

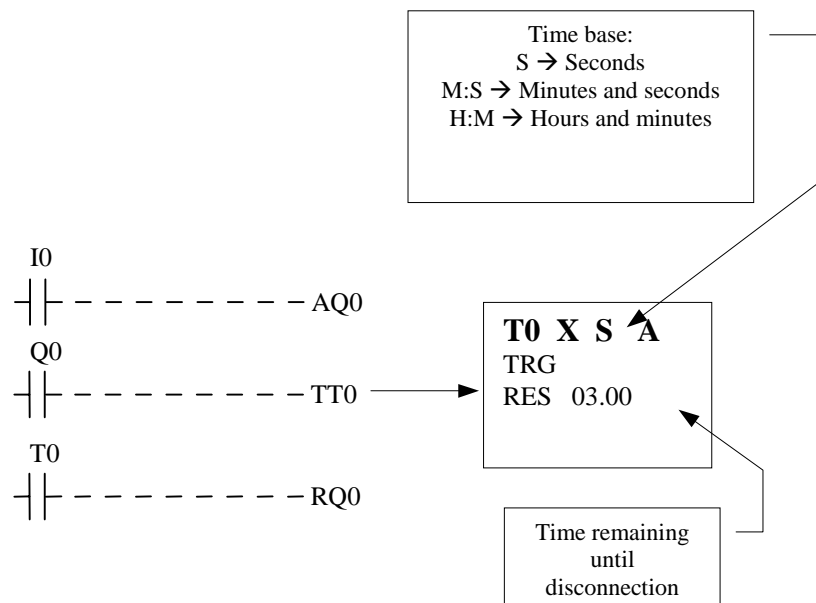
ProgramOperation

Using the switch changes the status of the light fitting. This means that if the light fitting is off, this will turn it on. If the light fitting is on, this will turn it off. If the light fitting is left on, it will be turned off when the set time elapses.

In this example, the “teleswitch”(A), “timer”(X) and “reset”(R) functions have been used.

Applications

Bathrooms, changing rooms, etc.

1.3 Light fittings using holding relays

This example is focused on that when there is a power failure and then the power is reestablished, the light fitting will stay as it was before the power failure. This means that if before the fault occurred, the supply was on, when it is reestablished it turns back on without the switch needing to be used. If before the fault, the supply was off, logically when the power supply is reestablished, the light fitting should remain off.

Connection

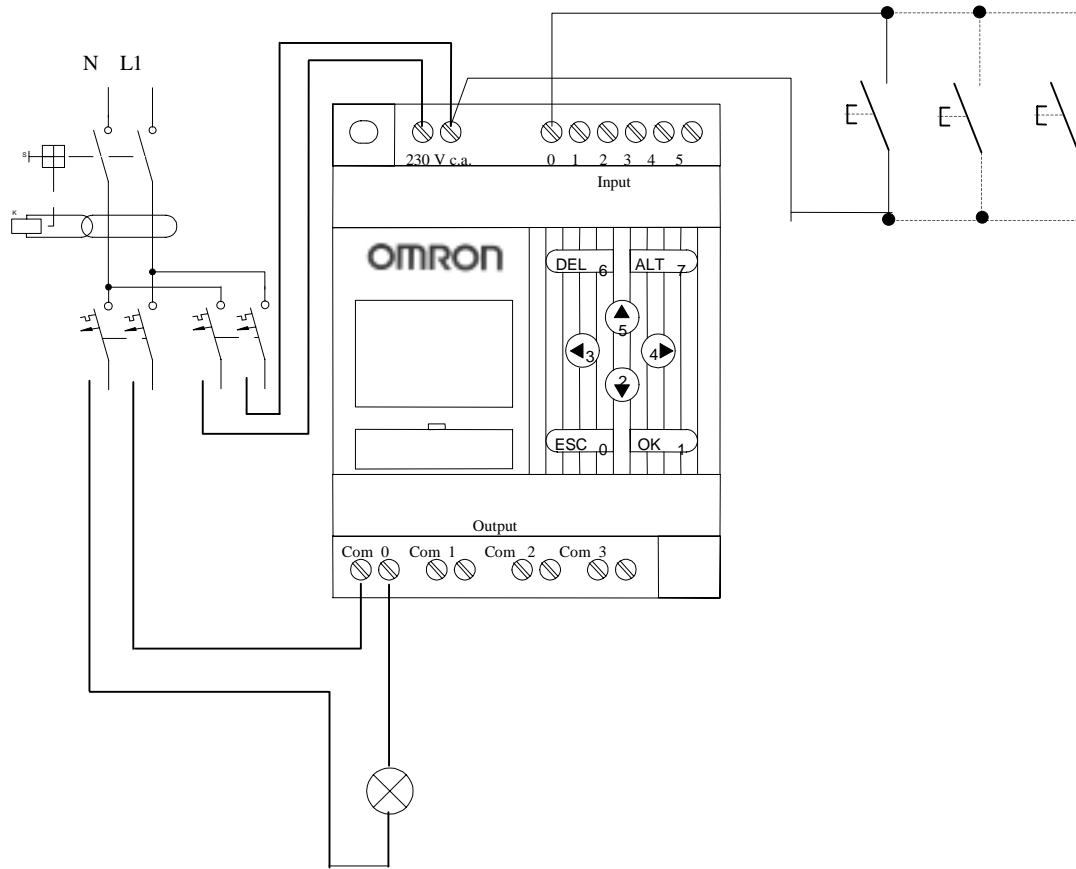

Program

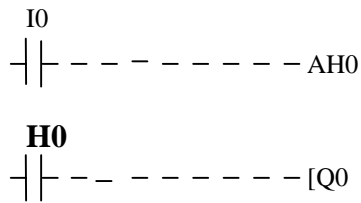

Operation

Using the switch changes the status of the light fitting. This means that if the light fitting is off, this will turn it on. If the light fitting is on, this will turn it off. If a power failure occurs, when it is reestablished, the light fitting will resume its status from before the fault.

In this example, the “teleswitch”(A) and “holding relay”(H) functions have been used.

Applications

Overall lighting.

1.4 Light fitting using weekly timer clock

In this example, it is solely used as a timer switch. This example is well-suited to external lighting, etc.

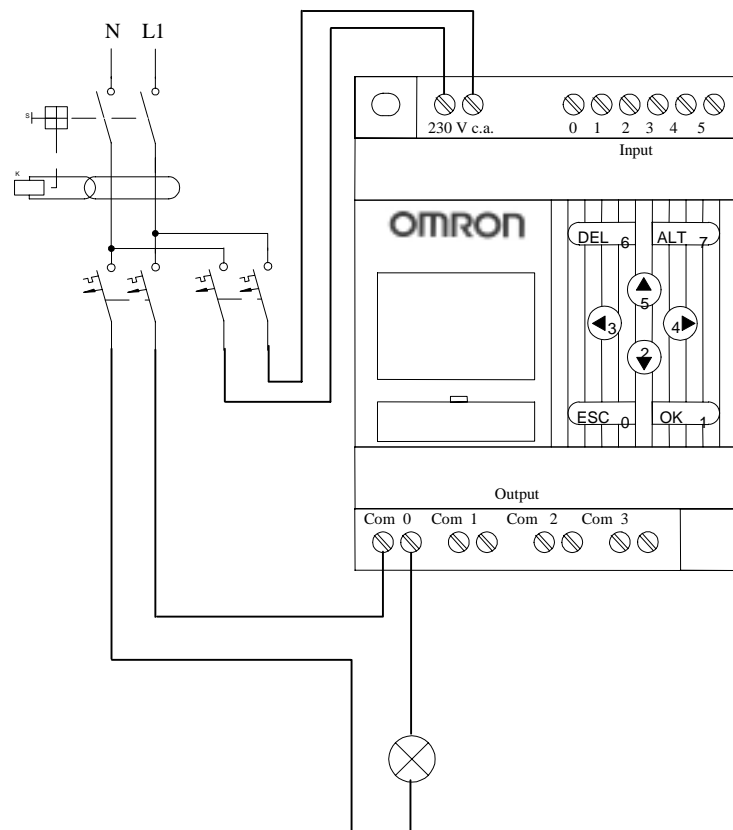
Connection

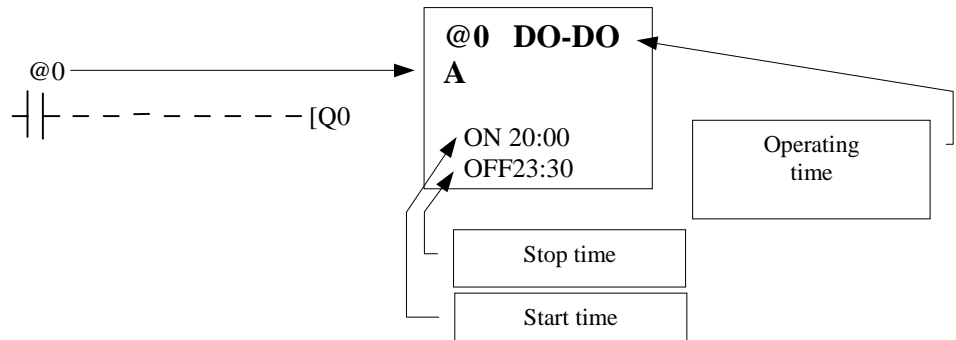
ProgramOperation

The operation is the same as for a weekly timer clock.

The “weekly timer clock” (@) has been used.

Applications

Lighting for illuminated signs, perimetric lighting and the overall external lighting.

1.5 Automatic stair lighting

In this example, ZEN is used as automatic stair lighting.

Connection

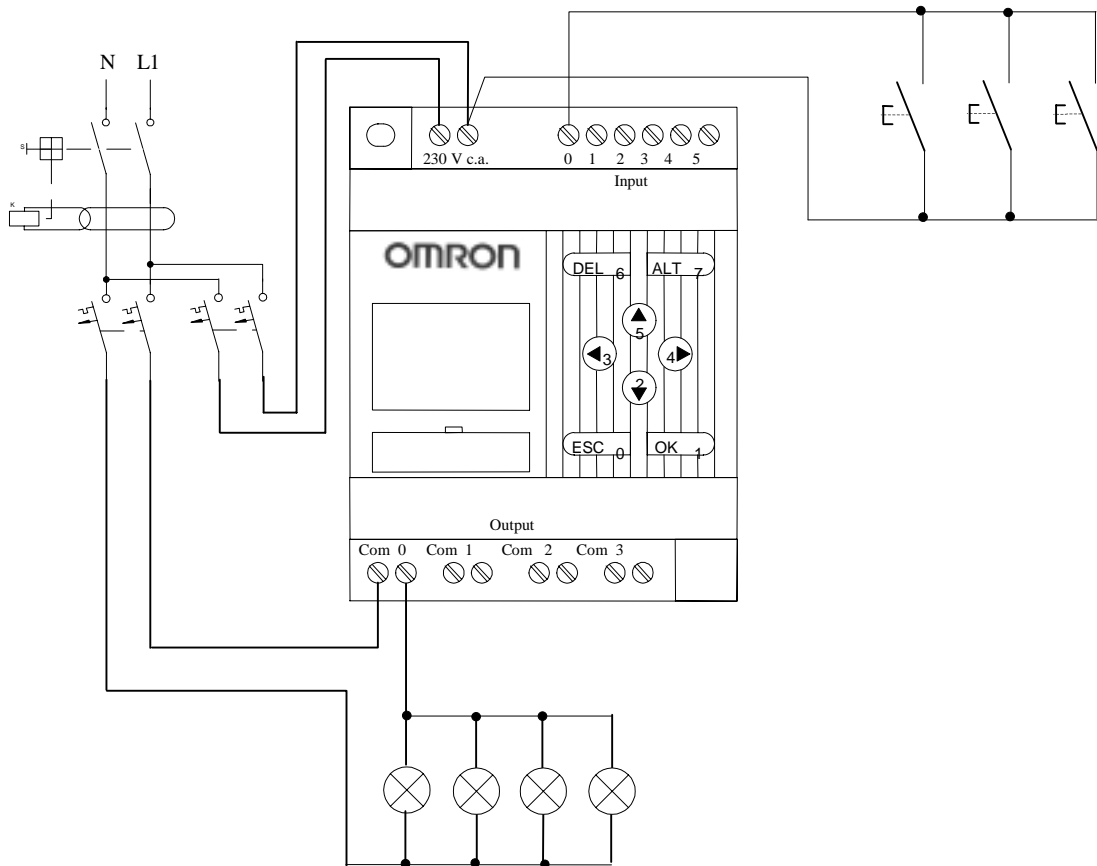

Program

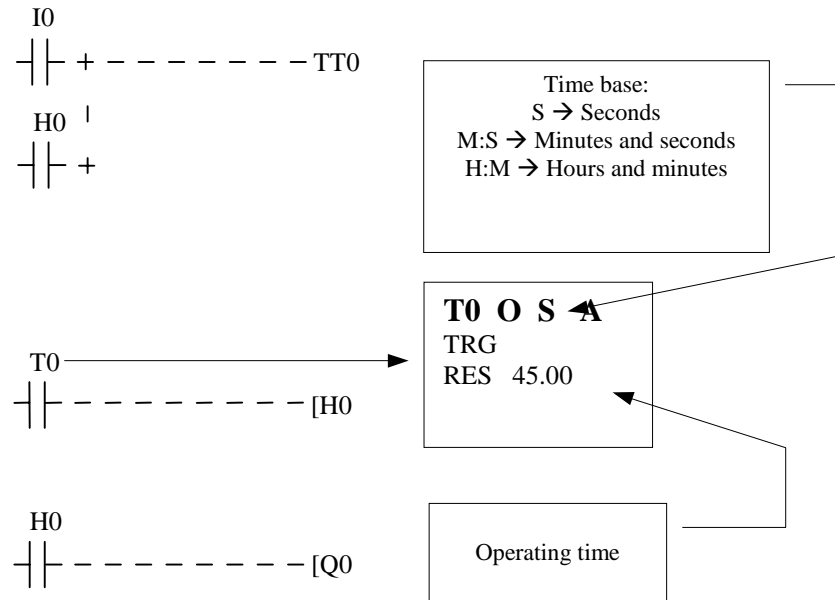

Operation

The operation is similar to that of the automatic stair lighting, with the special characteristic that it allows the set power on time to be initialized. In conventional automatic stair lighting, this is only possible after the lamps have been on for a while.

In this example, the “automatic stair lighting” (O) and “holding relay” (H) functions have been used.

Applications





The usual automatic stair lighting applications, but with the advantage of being able to maintain status during a power failure.

2 Programming applications

2.1 Single blind

With this programming model, it is possible to control a motorized blind by using local switches. Two inputs for the local switches and two outputs for raising and lowering the blind are used.

Inputs/Outputs List

Inputs			Outputs		
0	Raising switch		0	Blind up	
1	Lowering switch		1	Blind down	

Connection

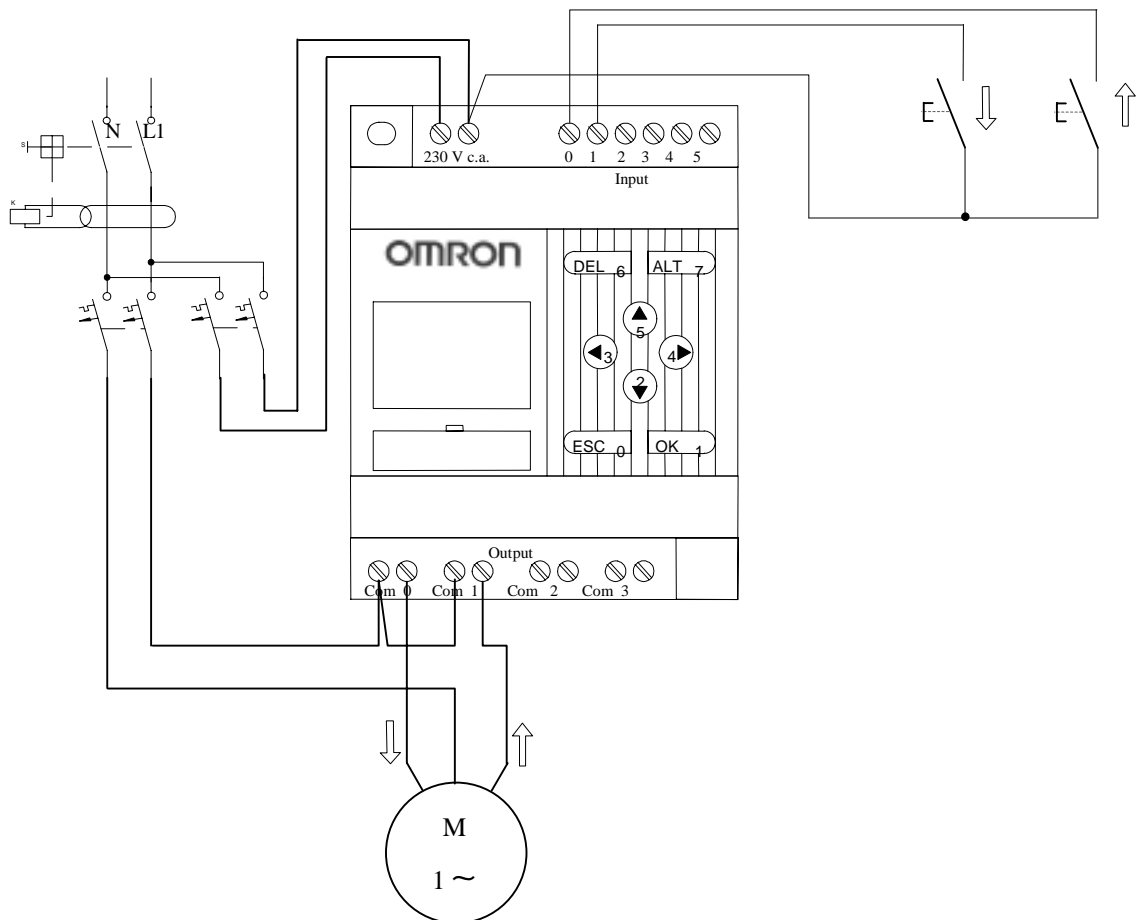











2.2 2 blinds set with anemometer and timer

Using this programming model, it is possible to control a set of two motorized blinds by means of local and centralized switches, an anemometer and a timer clock.

4 inputs are used for the local switches, 1 for the anemometer and 1 for operating the timer clock. Also, 4 outputs are used for raising and lowering the blinds.

Inputs/Outputs List

Inputs			Outputs		
0	Blind 1 raising switch		0	Blind 1 up	
1	Blind 1 lowering switch		1	Blind 1 down	
2	Blind 2 raising switch		2	Blind 2 up	
3	Blind 2 lowering switch		3	Blind 2 down	
4	Timer condition				
5	Anemometer				

Connection

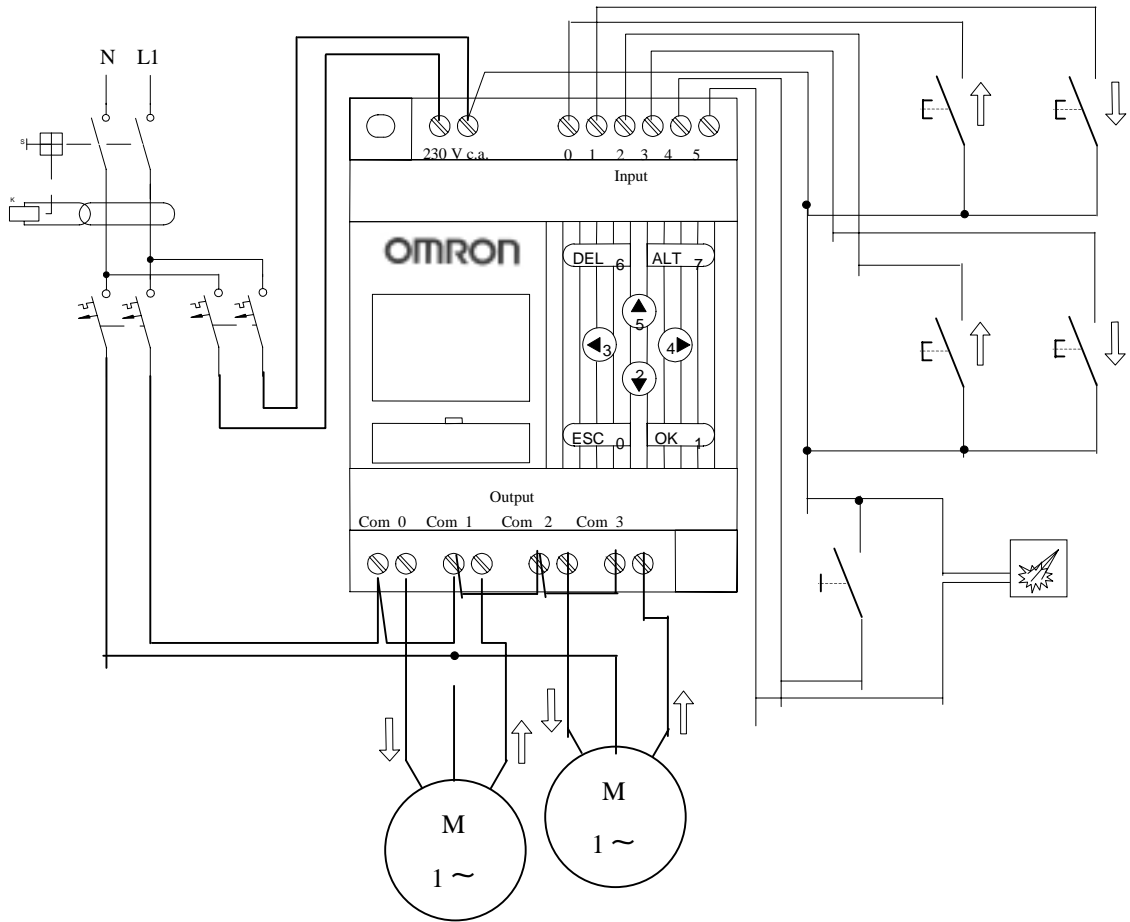

Program

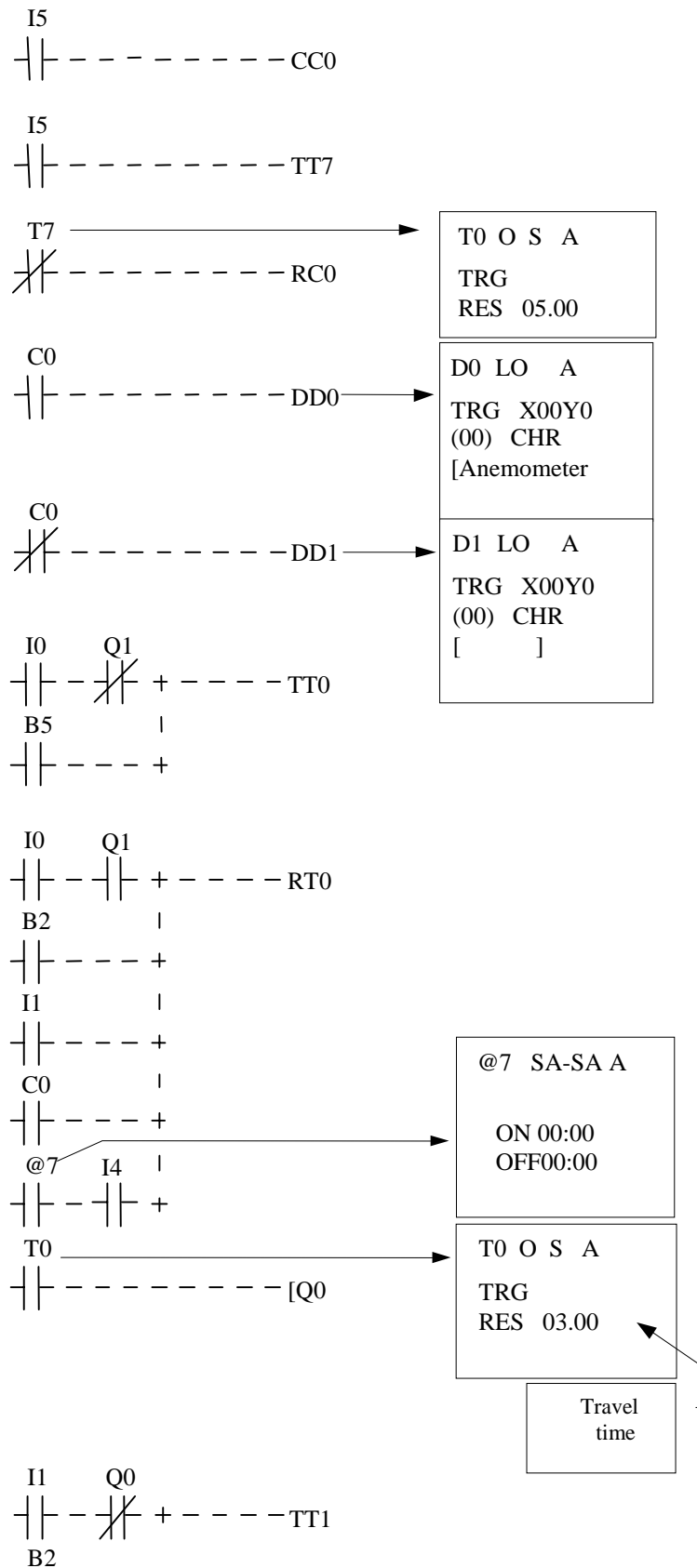

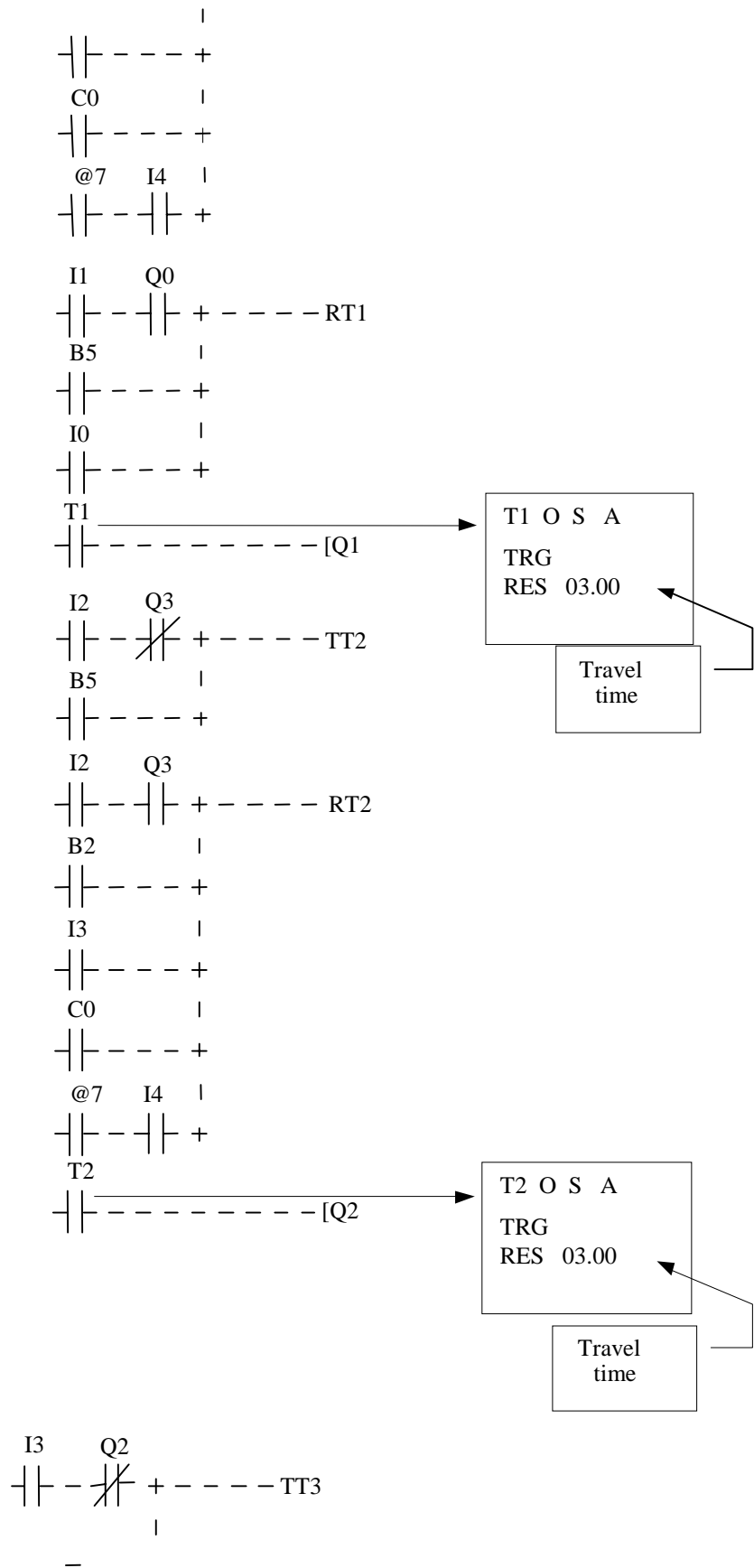

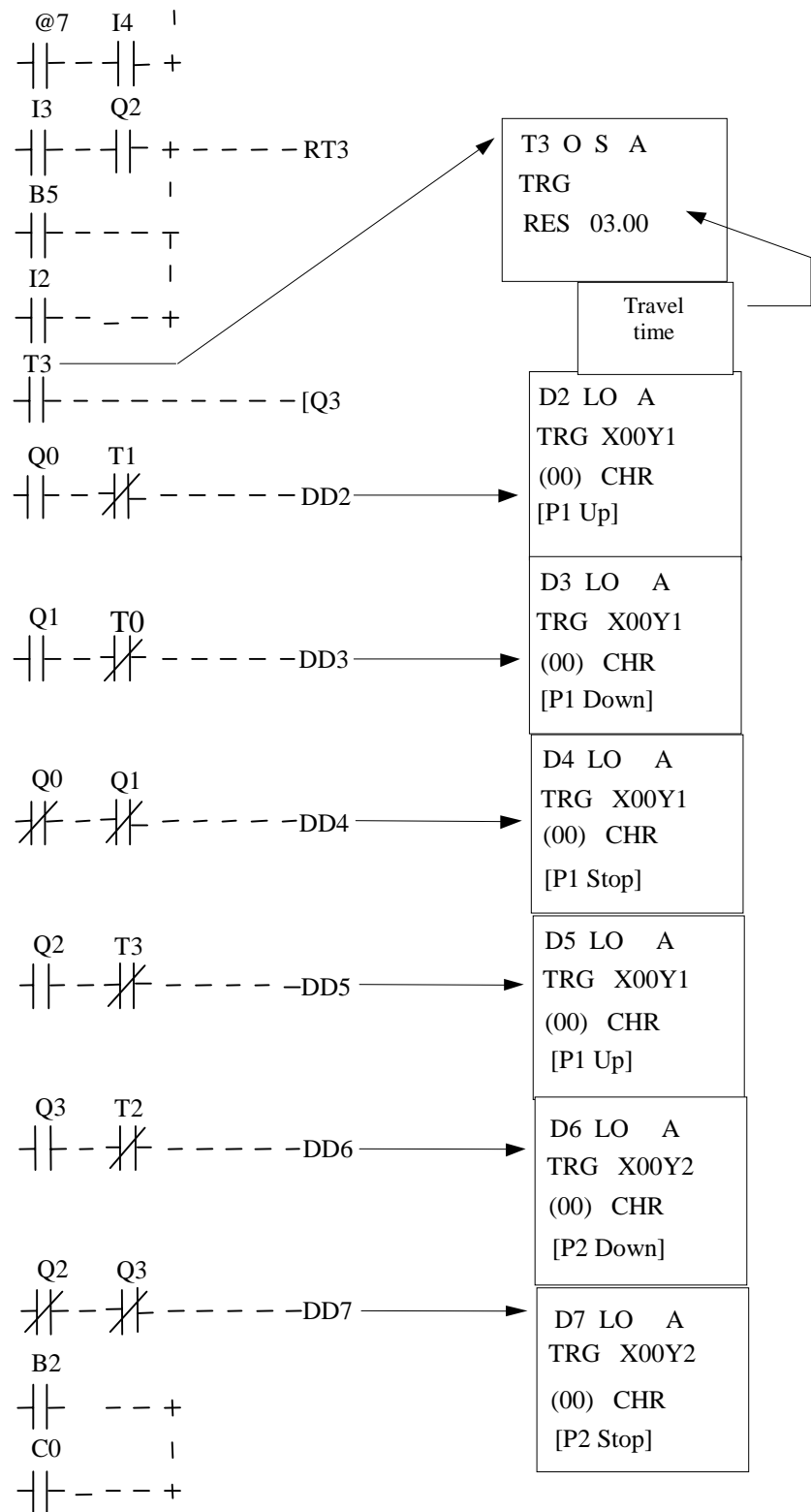

Operation

The up relay for blind 1 is enabled by pressing the raising switch for blind 1. This relay is automatically disabled when the travel time elapses. The blind can be stopped in mid stroke if the reverse switch is enabled.

The down relay for blind 2 is enabled by pressing the lowering switch for blind 2. This relay is automatically disabled when the travel time elapses. The blind can be stopped in mid stroke if the reverse switch is enabled.

Pressing the switch enables the down operation with timer clock. This timer clock switch should be programmed to operate for a minute. Please note that in this case, at the On time (activation) both blinds will be lowered and it will not be possible to raise them again until the Off time (deactivation) occurs.

The anemometer will lower both blinds when the set time speed value is exceeded.

2.3 Technical alarms (floods, gas leaks and 24v fires)

Technical security means the adaptation of measures to minimize the risk of floods, gas leaks and fires. In short, it is about detecting failures in power supplies to houses, buildings and business premises amongst others and to make containing devices operate in a way to prevent greater damages. If the system also has a modem to communicate with the outside world, technical security is completed by calling the end-users to warn them of the failure in their setup's operating function.







Operating technical security is straightforward. In the case that you wish to install flood and gas leak detection, logically flood and gas leak detectors are needed. If you also wish there to be a power supply break when the detectors are in alarm mode, you will also need two electrovalves: one for the water and the other for the gas.

Remember that in this application, electrovalves are installed and that they are NC operating type, which means they need voltage to allow the current to pass through. Also, for security reasons, the detectors should be wired with normally closed (NC) contact. For the security setup to operate correctly, both the gas leak and fire detectors should activate the same electrovalve. This means that the flood detector will activate the water electrovalve and the gas leak and fire detectors will activate the gas electrovalve.

In this example, ZEN is used as technical alarm manager and supervisor for houses, business premises, offices, etc.

Three inputs from the flood, gas and fire detectors are used and are wired with NC (normally closed contact). The ZEN "DEL" key is also used to reset the fire detectors.

Inputs/Outputs List

Inputs			Output		
0	Flood Detector		0	Water Electrovalve	
1	Gas Leak Detector		1	Sound Signals	
2	Fire Detector		2	Gas Electrovalve	
			3	Power Supply to Fire Detectors	

Connection

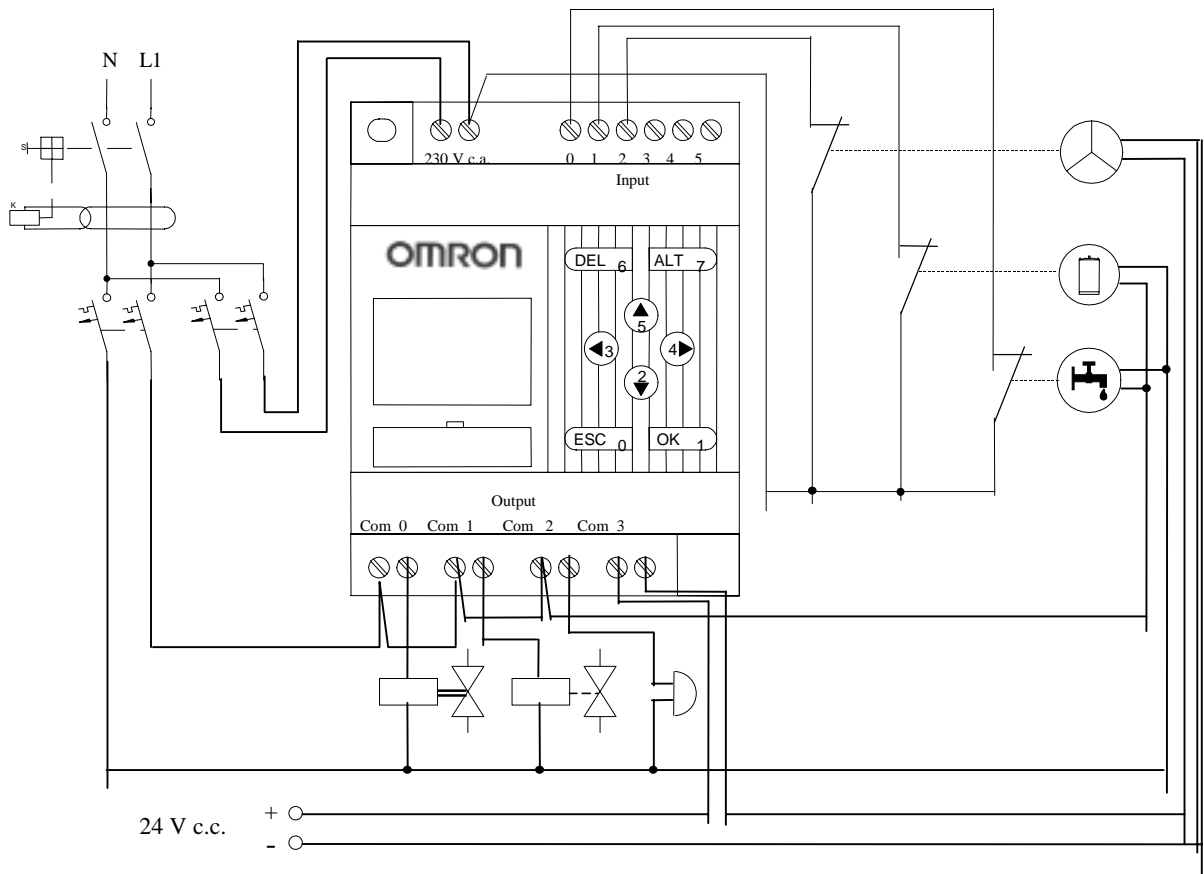

Program

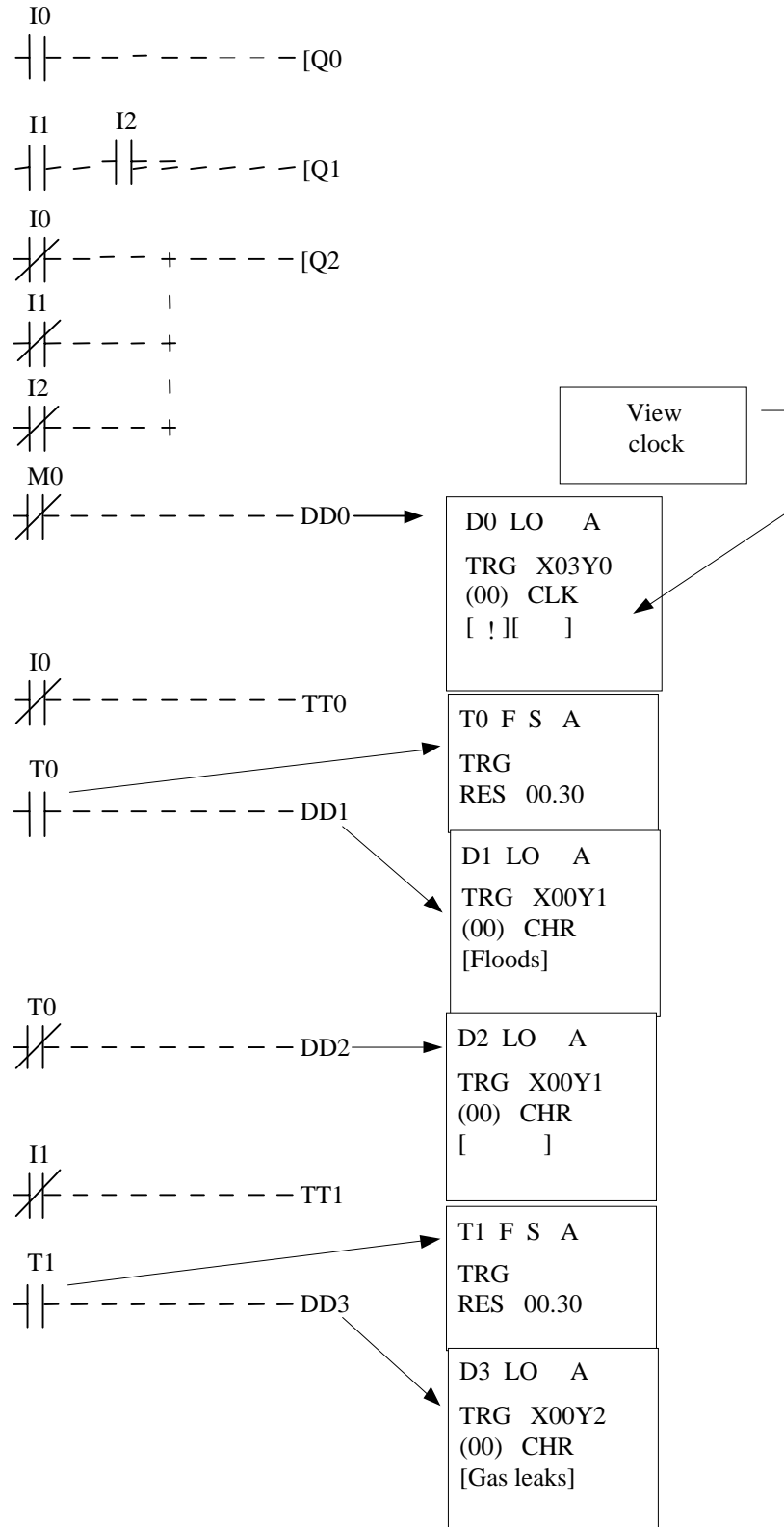

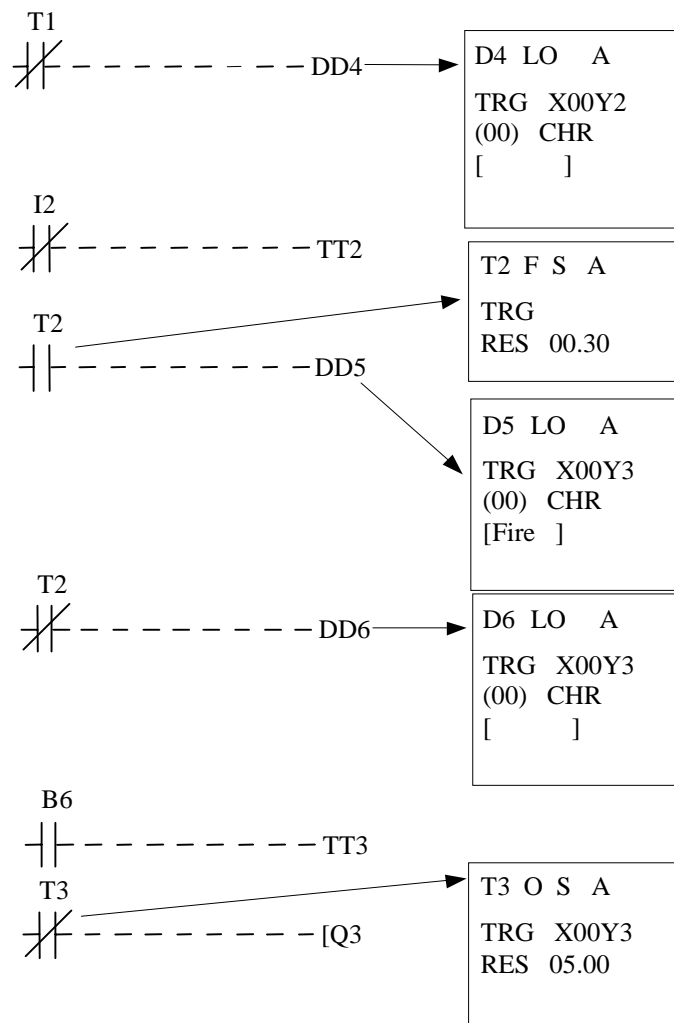

Operation

When the detectors are quiescent, the electrovalves are powered (current passes through) and the sound signals remain inactive.

If the flood detector is triggered, the water electrovalve turns off the supply, the sound signals are activated and the flashing "Flood" message can be read on the ZEN display.

If the gas leak detector is triggered, the gas electrovalve turns off the supply, the sound signals are activated and the flashing "Gas Leak" message can be read on the ZEN display.

If the fire detector is triggered, the gas electrovalve turns off the supply, the sound signals are activated and the flashing "Fire" message can be read on the ZEN display.

Also, as the fire detectors are reset by turning off the power supply, pressing the "DEL" key will also turn off the power supply for 5 seconds.

2.4 Technical alarms (floods, gas leaks and 230v fires)

Technical security means the adaptation of measures to minimize the risk of floods, gas leaks and fires. In short, it is about detecting failures in power supplies to houses, buildings and business premises amongst others and to make containing devices operate in a way to prevent greater damages. If the system also has a modem to communicate with the outside world, technical security is completed by calling the end-users to warn them of the failure in their setup's operating function.







Operating technical security is straightforward. In the case that you wish to install flood and gas leak detection, logically flood and gas leak detectors are needed. If you also wish there to be a power supply break when the detectors are in alarm mode, you will also need two electrovalves: one for the water and the other for the gas.

Remember that in this application, electrovalves are installed and that they are NC operating type, which means they need voltage to allow the current to pass through. Also, for security reasons, the detectors should be wired with normally closed (NC) contact. For the security setup to operate correctly, both the gas leak and fire detectors should activate the same electrovalve. This means that the flood detector will activate the water electrovalve and the gas leak and fire detectors will activate the gas electrovalve.

In this example, ZEN is used as technical alarm manager and supervisor for houses, business premises, offices, etc.





Three inputs from the flood, gas and fire detectors are used and are wired with NC (normally closed contact).

Inputs/Outputs List

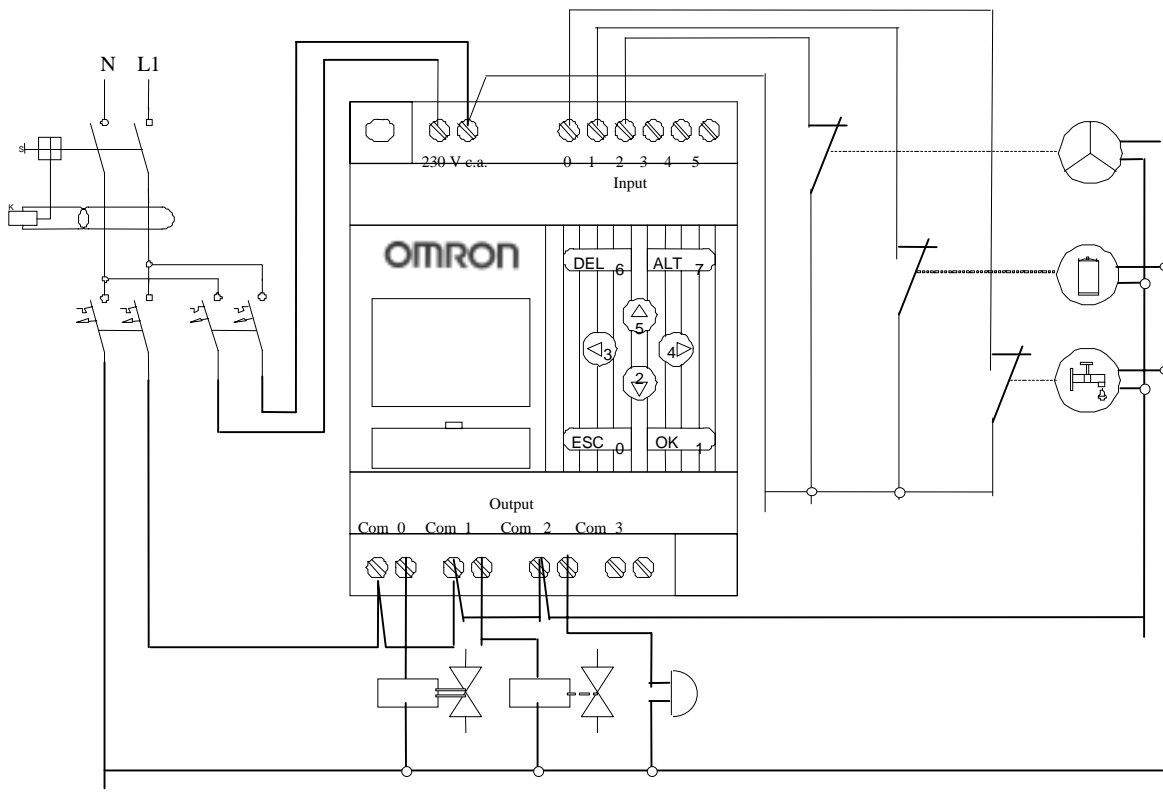
Inputs			Outputs		
0	Flood Detector		0	Water Electrovalve	
1	Gas Leak Detector		1	Sound Signals	
2	Fire Detector		2	Gas Electrovalve	

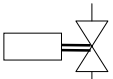
Connection

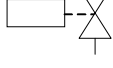

- | | | | |
|---|-------------------|--|--------------------|
|  | Fire Detector |  | Water Electrovalve |
|  | Gas Leak Detector |  | Sound Signals |
|  | Flood Detector |  | Gas Electrovalve |

Program

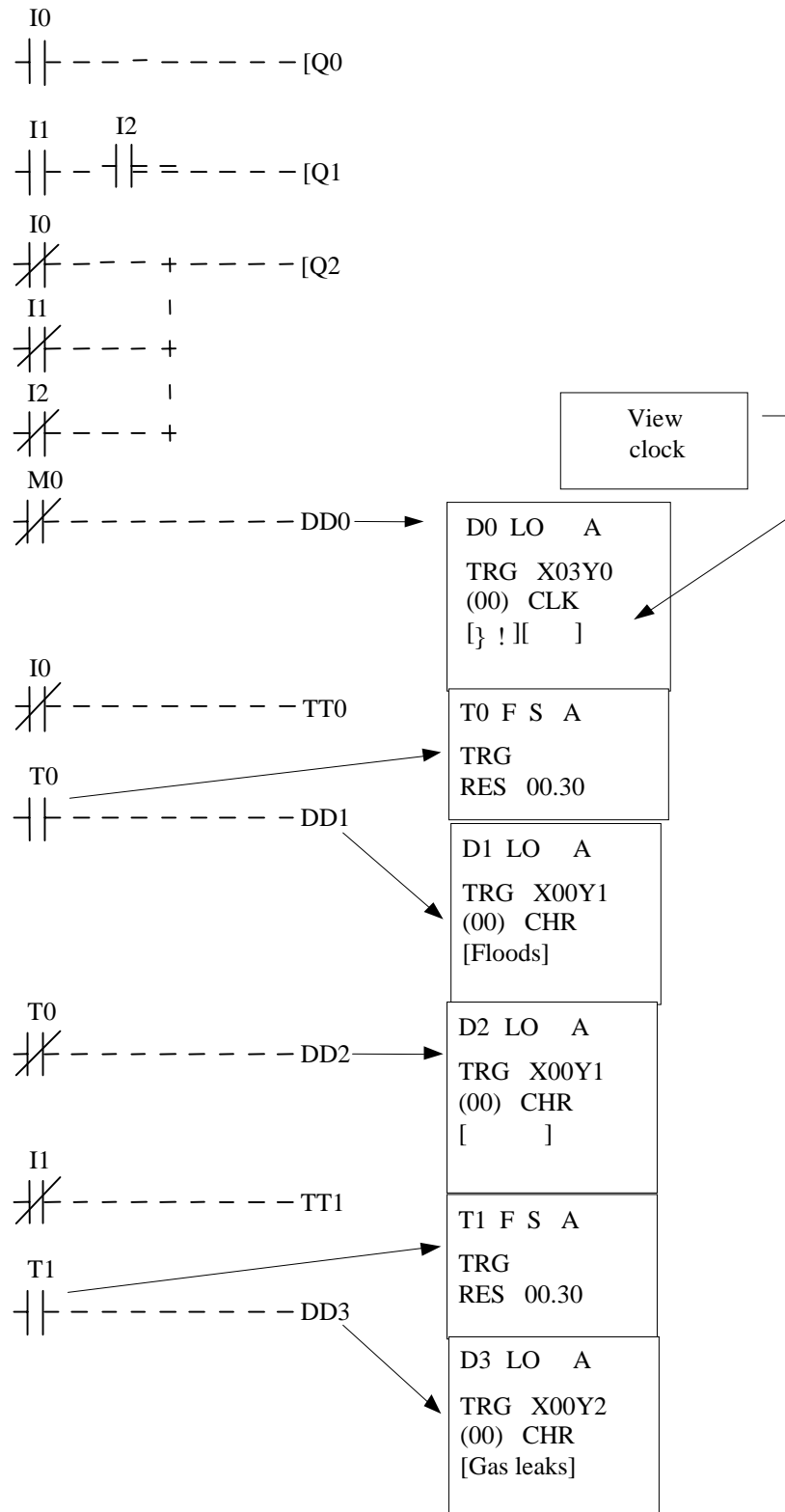

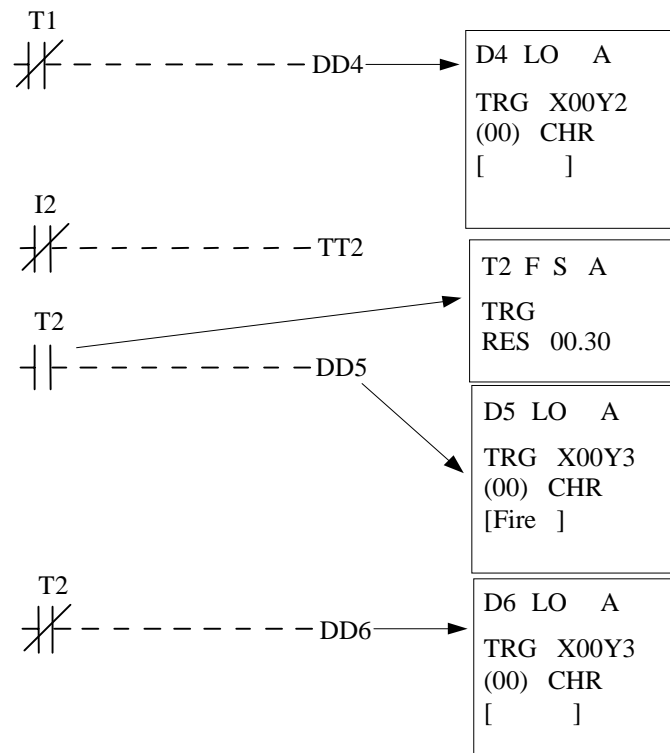

Operation

When the detectors are quiescent, the electrovalves are powered (current passes through) and the sound signals remain inactive.

If the flood detector is triggered, the water electrovalve turns off the supply, the sound signals are activated and the flashing "Flood" message can be read on the ZEN display.

If the gas leak detector is triggered, the gas electrovalve turns off the power supply, the sound signals are activated and the flashing "Gas Leak" message can be read on the ZEN display.









If the fire detector is triggered, the gas electrovalve turns off the supply, the sound signals are activated and the flashing "Fire" message can be read on the ZEN display.

2.5 Heating control

In this example, ZEN is used as manager of four independent heating areas. For this setup, four ambient thermostats connected to the first four inputs are needed. Four contactors are also required for starting or stopping the heating elements.

In addition, 4 ZEN switches are used for manual starting/stopping and for enabling or disabling the timer clock.

Inputs/Outputs List

Inputs			Outputs		
0	Thermostat 1		0	Contactor 1	
1	Thermostat 2		1	Contactor 2	
2	Thermostat 3		2	Contactor 3	
	Thermostat 4			Contactor 4	

Connection

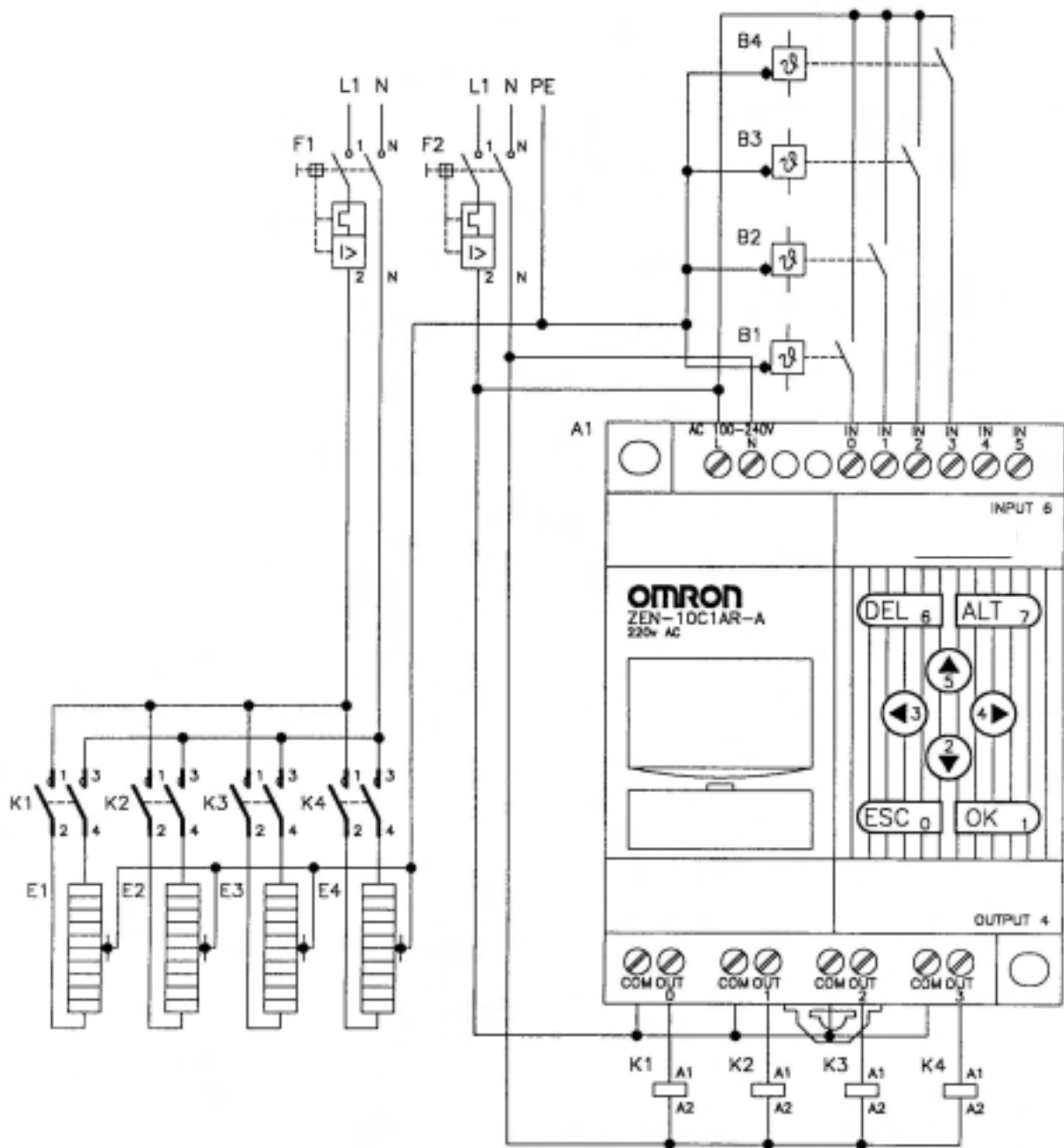

Program

The ladder diagram is shown on the following page:

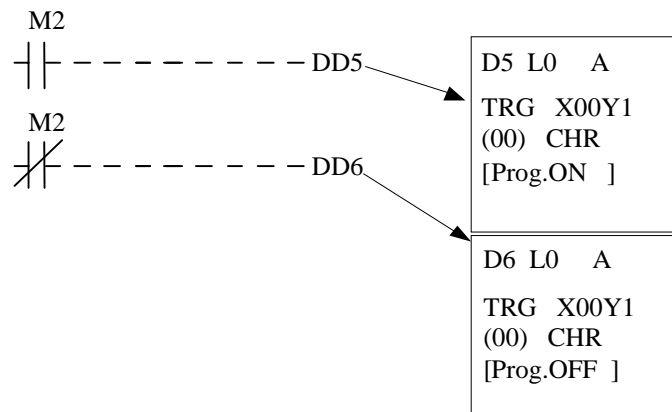

Operation

When the heating is started manually using the ZEN “5” key, the ambient thermostats requesting more temperature start the contactors which enable the heating elements. When the ambient temperature reaches the set temperature on the thermostat, the corresponding heating element is disabled.

If the heating is stopped manually overall by using the ZEN “2” key, the four heating areas stop.











The timer clock is enabled by using the ZEN “4” key. In this example, this timer clock has two programming time intervals. (Up to a total of 8 may be added, programming them parallel to the existing time intervals).

The timer clocks are disabled by pressing key “3”.

2.6 Street lighting control

ZEN is used as timer manager for this application and other street lighting operating conditions. It comprises 4 independent lighting areas that switch on using a twilight switch during an independent time block for each area, while in normal operating mode. For maintenance reasons, the switches can also turn on the independent areas or all the lighting at once.

Inputs/Outputs List

Inputs			Outputs		
0	Area 1 Lighting Forced Switch		0	Area 1 Lighting Contactor	
1	Area 2 Lighting Forced Switch		1	Area 2 Lighting Contactor	
2	Area 3 Lighting Forced Switch		2	Area 3 Lighting Contactor	
3	Area 4 Lighting Forced Switch		3	Area 4 Lighting Contactor	
4	Overall Lighting Forced Switch				
5	Twilight Switch				

Connection

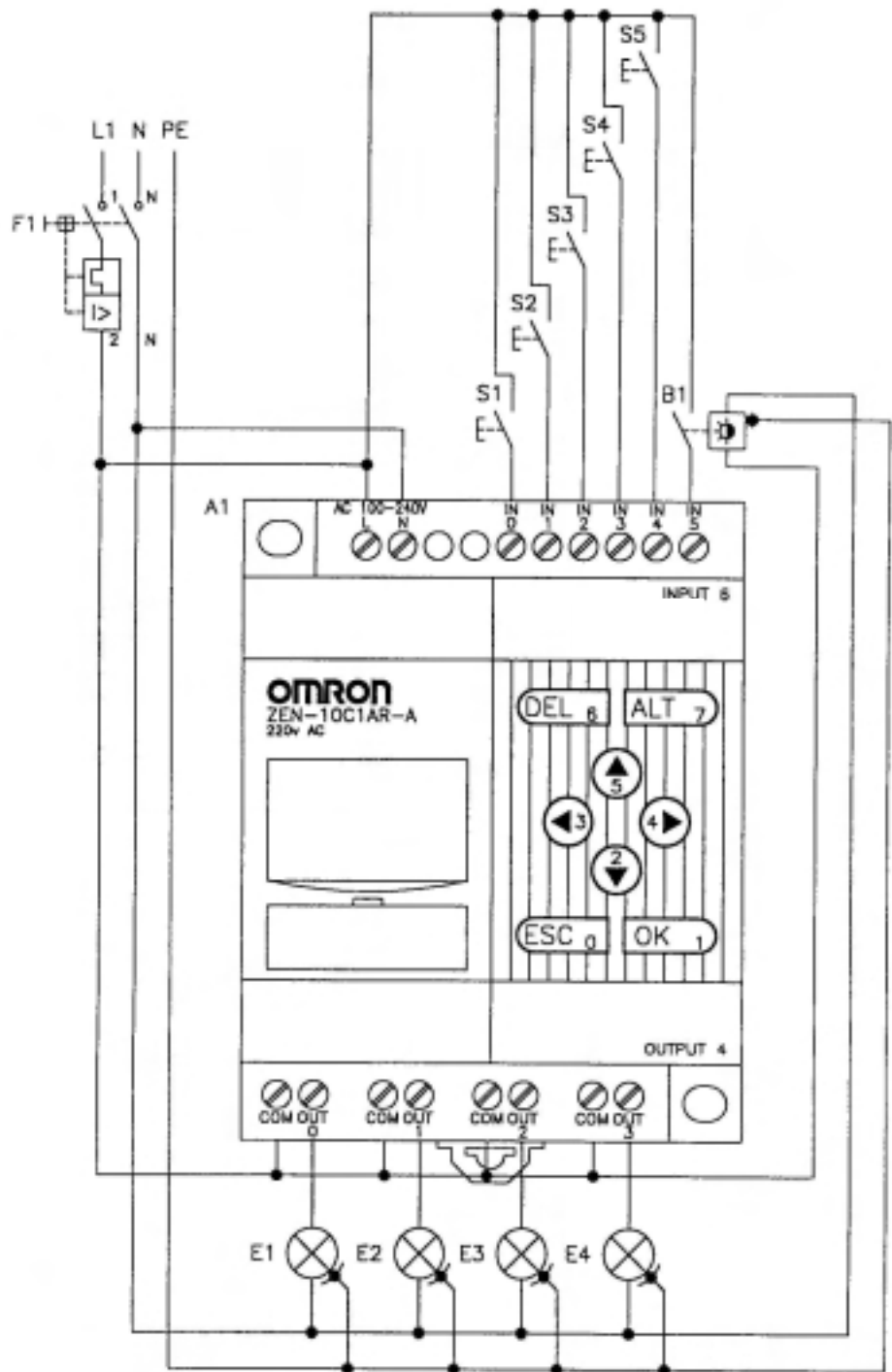

Program

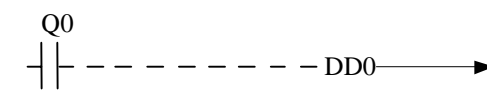
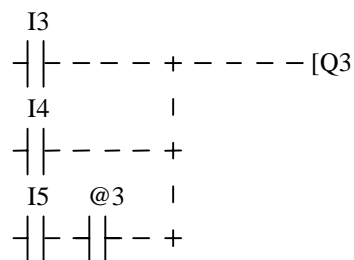
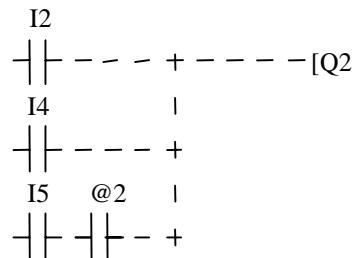
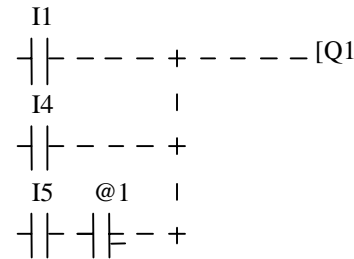
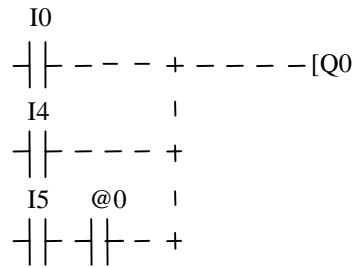

D0 L0 A
TRG X00Y0
(00) CHR

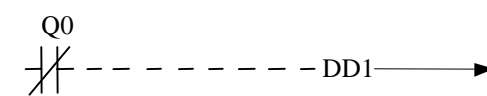

D1 L0 A
TRG X00Y0
(00) CHR
[Z1->OFF]

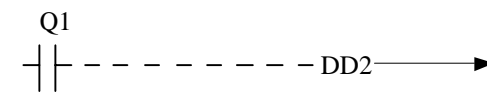

D2 L0 A
TRG X00Y1
(00) CLK
[Z2->ON]



D3 L0 A
TRG X00Y1
(00) CHR
[Z2->OFF]

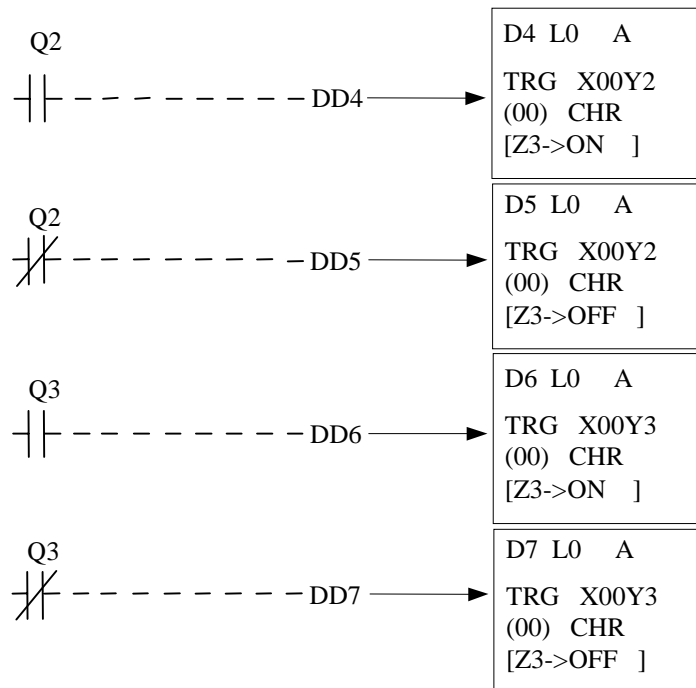

Operation

Normal lighting is achieved by means of input no. 5 (twilight switch) and the timer clock, so that when it is night time or there is little natural light, the lighting areas will turn on, providing they are within the operation time margin (@0, @1, @2 and @3).

If for maintenance and cleaning reasons it is necessary for the lighting to be turned on during the day, inputs no. 0, 1, 2 and 3 will be enabled. By enabling each one, lighting areas no. 0, 1, 2 and 3 will be forced on, respectively.

Forced daytime global lighting can be achieved by enabling input no. 4.

The status of each lighting area appears on the ZEN display screen.