

# Switching Mode Power Supply ZEN-PA03024

Please read and understand this catalog before purchasing the products. Please consult your OMRON representative if you have any questions or comments. Refer to *Warranty and Application Considerations* (page 8), and *Safety Precautions* (page 6)

## New Compact Power Supply (30 W) for ZEN Programmable Relays

- Slim size with a depth of 56 mm (W × H × D: 70 × 90 × 56 mm).
- EMI: Conforms to EN61000-6-3 (Class B).
- Allows parallel operation.
- Output voltage: 24 VDC; Output current: 1.3 A; Capacity: 30 W
- Safety standards: UL508/60950/1604, CSA C22.2 No. 14/60950/213, EN60950(VDE0806), EN50178(VDE0160)
- Uses lead-free soldering.
- Six-language instruction manual provided.



## Model Number Structure

### Model Number Legend

ZEN-PA 030 24  
1 2 3

- Unit**  
PA: Power supply unit
- Power Ratings**  
030: 30 W
- Output voltage**  
24: 24 V

## Ordering Information

### List of Models

Power ratings	Input voltage	Output voltage	Output current	Model number
30 W	100 to 240 VAC	24 VDC	1.3 A	ZEN-PA03024

### Accessories (Order Separately)

Name	Models
Mounting Track	50 cm (l) × 7.3 mm (t) PFP-50N
	1 m (l) × 7.3 mm (t) PFP-100N
	1 m (l) × 16 mm (t) PFP-100N2
End Plate	PFP-M
Spacer	PFP-S

# Specifications

## ■ Ratings/Characteristics

Efficiency (typical)		80% min.	
Input	Voltage	100 to 240 VAC (85 to 264 VAC), 95 to 350 VDC (See note 1.)	
	Frequency	50/60 Hz (47 to 450 Hz)	
	Current	100 VAC input	0.8 A max.
		200 VAC input	0.45 A max.
	Leakage current	100 VAC input	0.4 mA max.
		200 VAC input	0.75 mA max.
Inrush current (See note 2.)	100 VAC input	25 A max.	
	200 VAC input	50 A max.	
Output	Voltage adjustment range (See note 3.)	-10 to 15% (with V.ADJ) of rated output voltage	
	Ripple	2% (p-p) max. (-25 to -10°C: 4% max.)	
	Input variation influence	0.5% max.	
	Load variation influence (rated input voltage)	1.5% max.	
	Temperature variation influence	0.05%/°C max.	
	Start up time (See note 2.)	1,000 ms max. (100 VAC or 200 VAC, at rated output voltage)	
	Hold time (See note 2.)	15 ms min., 20 ms (typical) (100 VAC or 200 VAC, at rated output voltage)	
Additional functions	Overload protection (See note 2.)	105% to 135% of rated load current, inverted L drop, intermittent, automatic reset	
	Parallel operation	Yes (2 units max. For details, refer to the derating curve in <i>Engineering Data</i> . For DC input, parallel operation is possible only for 110 to 350 VDC.)	
	Series operation	No	
Others	Ambient temperature	Operating: Refer to the derating curve in <i>Engineering Data</i> . (with no icing or condensation) Storage: -25 to 75°C (with no icing or condensation)	
	Ambient humidity	Operating: 10 to 90% Storage: 10 to 90%	
	Mounting method	DIN track mounting, surface mounting	
	Dielectric strength	2.0 kVAC for 1 min. (between all inputs and exposed non-current-carrying metal parts; detection current: 10 mA max.) 3.0 kVAC for 1 min. (between all inputs and all outputs; detection current: 20 mA max.) 1.0 kVAC for 1 min. (between all outputs and non-current-carrying metal parts; detection current: 10 mA max.)	
	Insulation resistance	100 MΩ min. (between all outputs and all inputs/exposed non-current-carrying metal parts) at 500 VDC	
	Vibration resistance	10 to 55 Hz, 0.375-mm single amplitude for 2 h each in X, Y, and Z direction	
	Shock resistance	300 m/s <sup>2</sup> , 3 times each in ±X, ±Y, ±Z directions	
	Output indicator	Yes (color: green)	
	EMI	Conducted emissions	Conforms to EN61000-6-3 (Class B)
		Radiated emissions	Conforms to EN61000-6-3 (Class B)
	Approved standards	UL: UL508 Listing Class 2, 60950, 1604 (Class I/Division 2) cUL: CSA C22.2 No. 14 Class 2, No. 60950, No. 213 (Class I/Division 2) EN/VDE: EN60950 (=VDE0805), EN50178 (=VDE0160) Conforms to VDE0106/P100 (Finger protection)	
	Weight	240 g max.	

- Note:**
1. This product has been approved for safety standards only when an AC input is used. It has not been approved when a DC input is used.
  2. Refer to the Engineering Data section on page 4 for details.
  3. If the V. ADJ adjuster is turned, the voltage will increase by more than 15% of the voltage adjustment range.  
Check the output voltage of the power supply when converting the output voltage, and make sure that the load will not be damaged.

# Connections

## ■ Block Diagram

ZEN-PA03024

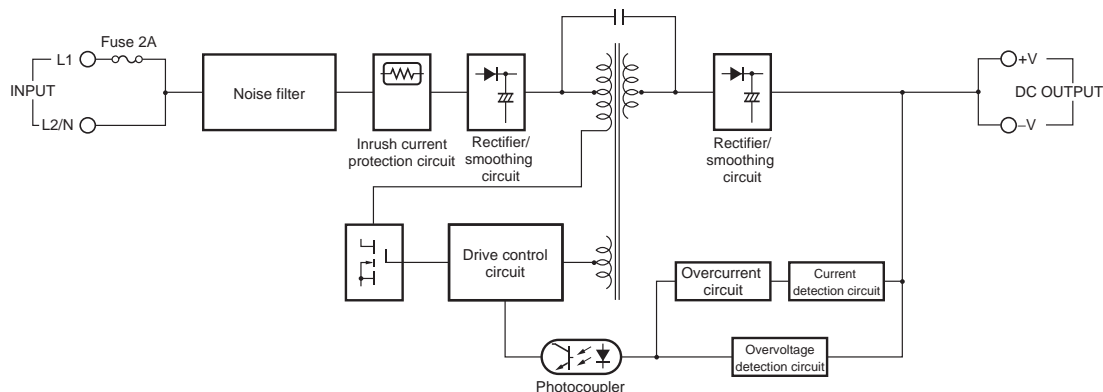

**Note:** The Power Supply is provided with reinforced insulation between the input and output terminals.

## ■ Installation

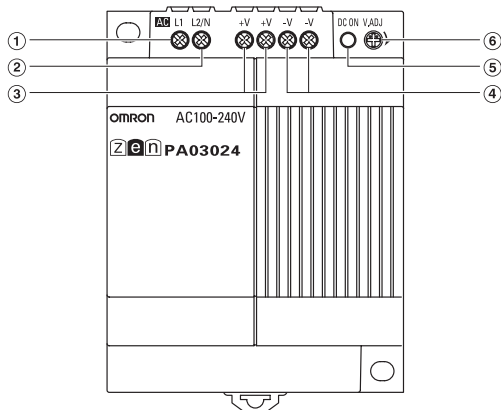

No.	Name	Function
1	AC input terminal (L1)	Connect the input line to this terminal. A fuse is included in the circuit.
2	AC input terminal (L2/N)	Connect the input line to this terminal. Negative pole for DC input.
3	DC output terminals (+V)	Connect the load lines to these terminals.
4	DC output terminals (-V)	Connect the load lines to these terminals.
5	Output indicator (DC ON: Green)	Lights while a direct current (DC) output is ON.
6	Output voltage adjuster (V.ADJ)	Use to adjust the voltage.

# Engineering Data

## Derating Curve

### 85 to 264 VAC or 110 to 350 VDC input

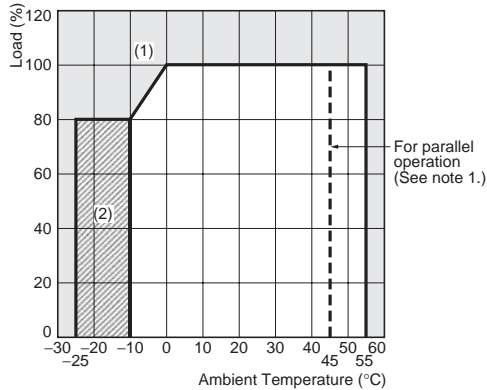

### 95 to 110 VDC input

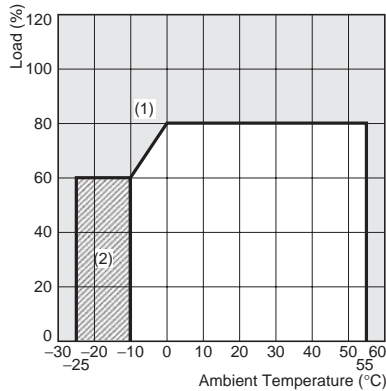

- Note:**
1. The maximum ambient temperature for parallel operation is 45°C.
  2. Parallel operation is not possible for an input of 95 to 110 VDC.
  3. Although operation is possible in the (2) portion of the derating curve, performance may be adversely affected, i.e., ripple noise may increase.
  4. Internal parts may occasionally deteriorate or be damaged. Do not use the Power Supply in areas outside the derating curve (i.e., the area shown by shading (1) in the above graph).

## Installation

Correct

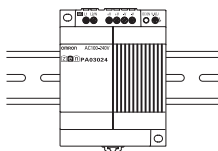

Incorrect



Standard mounting

Face-up mounting

- Note:**
1. Improper mounting will interfere with heat dissipation and may occasionally result in deterioration or damage of internal parts. Use the standard mounting.
  2. If there is a derating problem, use forced air-cooling. The ambient temperature is specified for a point 50 mm below the Power Supply.

## Overload Protection

The Power Supply is provided with an overload protection function that protects the load and the power supply from possible damage by overcurrent. When the output current rises above 105% min. of the rated current, the protection function is triggered, decreasing the output voltage. When the output current falls within the rated range, the overload protection function is automatically cleared.

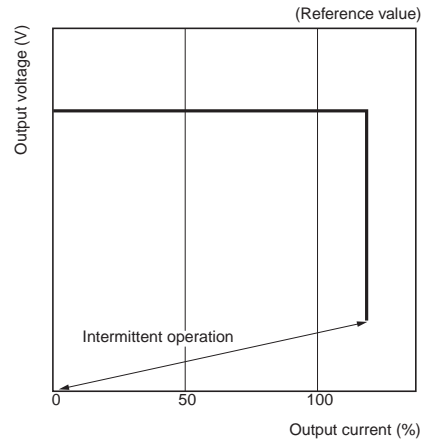

The values shown in the above diagrams are for reference only.

- Note:**
1. Internal parts may occasionally deteriorate or be damaged if a short-circuited or overcurrent state continues during operation.
  2. Internal parts may possibly deteriorate or be damaged if the Power Supply is used for applications with frequent inrush current or overloading at the load end. Do not use the Power Supply for such applications.

## Inrush Current, Start Up Time, Hold Time

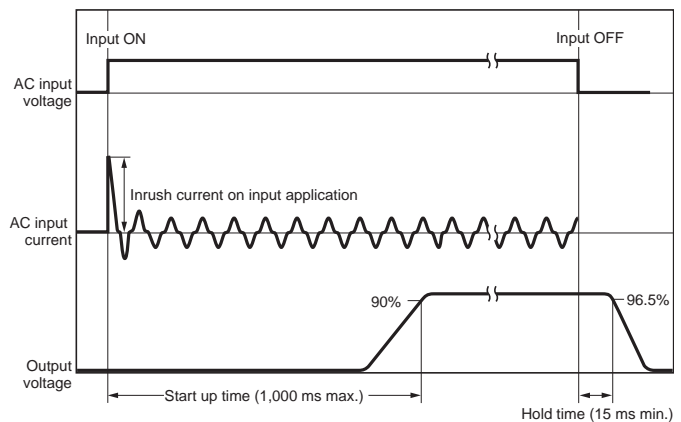

# Dimensions

Note: All units are in millimeters unless otherwise indicated.

## ZEN-PA03024

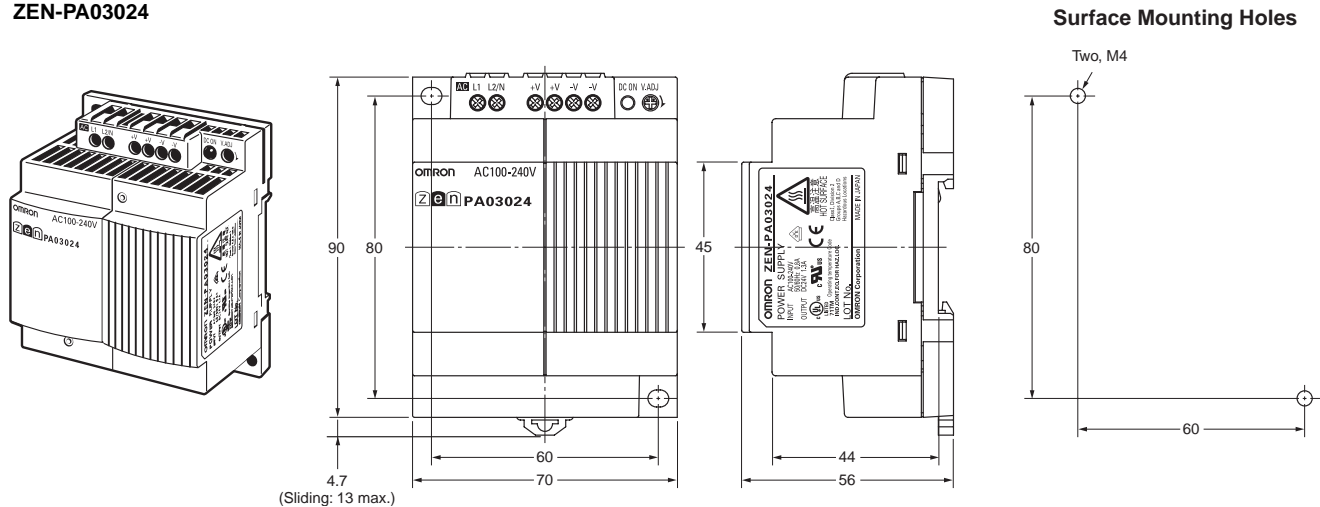

## Accessories (Order Separately)

### Mounting Track

#### PFP-100N, PFP-50N

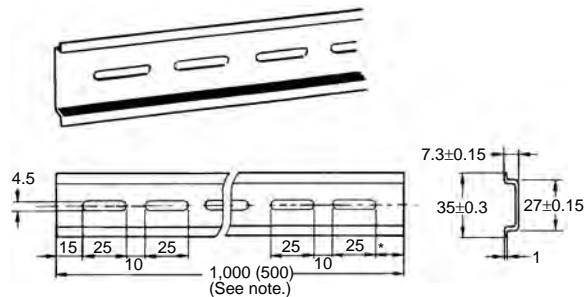

#### PFP-100N2

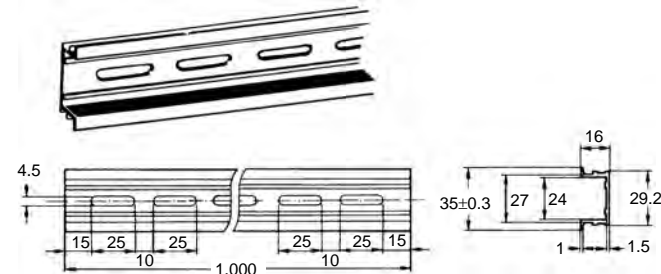

Note: The values shown in parentheses are for the PFP-50N.

### End Plate

#### PFP-M

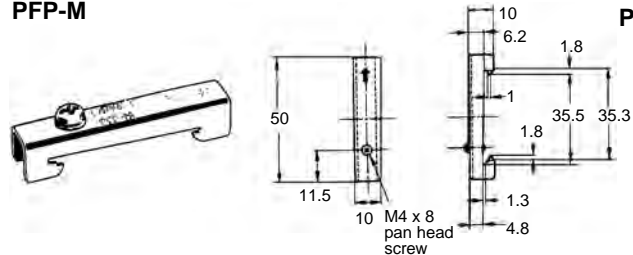

### Spacer

#### PFP-S

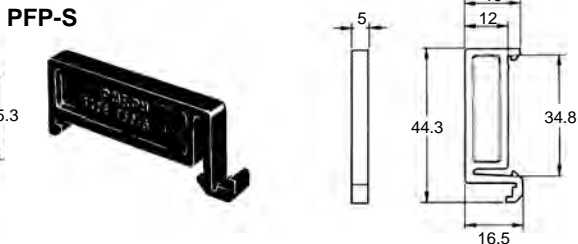

# Safety Precautions

## CAUTION

Minor electric shock may occasionally occur. Do not disassemble the product or touch internal parts.

Minor fires may occasionally occur. Do not attempt to repair or modify the product.

Minor burns may occasionally occur. Do not touch the product while power is being supplied or immediately after power is turned OFF.

Minor fires may occasionally occur. Tighten terminal screws to a torque of 0.5 to 0.6 N·m so that they do not become loose.

Minor electric shock may occasionally occur during operation. Do not touch the input and output terminals while power is being supplied.

The product may occasionally be damaged. Do not allow any clippings or cuttings to enter the product during installation work.

Working voltage can be 350 V max. inside. This voltage can be also available 10 s after the switch off.

## Precautions for Safe Use

The following precautions must be observed to ensure safety.

### Mounting

- Mounting Direction  
(Refer to *Installation in Engineering Data* on page 4.)

Standard Mounting	Valid
Horizontal Mounting	Invalid
Other Mounting	Invalid

The internal parts may occasionally deteriorate or be broken due to adverse heat dissipation depending on the mounting status. Do not use the product in any way other than the standard mounting direction.

- Mounting Space

Make sure that sufficient heat dissipation is provided when installing the Power Supply to increase its long-term reliability. Install the product in a location that allows a natural airflow to occur around the Power Supply.

We recommend using End Plates (PFP-M) to secure the Power Supply and to ensure that a space of at least 10 mm is maintained between Power Supplies.

If the installation space above and below the Power Supply is less than 50 mm, reduce the ambient temperature by 5°C. A minimum space of 20 mm is required.

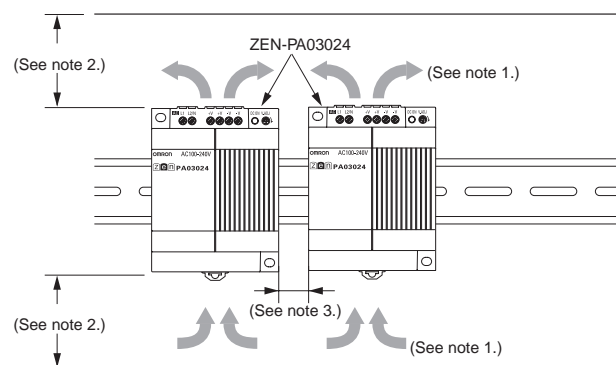

- Note:**
1. Convection of air
  2. 50 mm min.
  3. 10 mm min.

## Wiring

- Minor fire may possibly occur. Ensure that input and output terminals are wired correctly.
- Use the following material for the wires to be connected to the Power Supply to prevent smoking or ignition caused by abnormal loads.

Use solid wires. Always attach pin crimp terminals when using stranded wire. The stripping distance should be 6.5 mm.

## Recommended Wire Type

Solid wire	Cross section 0.5 to 2.5 mm <sup>2</sup> (Equivalent to AWG20 to AWG14)
Stranded wire	Cross section 0.5 to 2.5 mm <sup>2</sup> (Equivalent to AWG20 to AWG14)
Pin crimp terminals	Dia.: 1.1 to 2.3 mm

- Do not apply more than 100 N force to the terminal block when tightening the terminals.
- Be sure to remove the sheet covering the product before turning ON the Power Supply and confirm that nothing is interfering with heat dissipation.

## Installation Environment

- Do not use the Power Supply in locations subject to shocks or vibrations. In particular, install the Power Supply as far away as possible from contactors or other devices that are a vibration source.
- Install the Power Supply well away from any sources of strong, high-frequency noise.

## Operating and Storage Conditions

- When installing the Power Supply, check for any signs that the product or packaging has been struck. If internal parts have been damaged, overvoltages may be output depending on the location of the damage.
- Internal parts may occasionally deteriorate or be damaged. Store the Power Supply at a temperature of -25 to 65°C and a humidity of 10% to 90%.
- Internal parts may occasionally deteriorate or be damaged. Do not use the Power Supply in areas outside the derating curve (i.e., the area shown by shading (1) in the graph on page 4). For UL508 Listing, the surrounding air temperature should be 40°C.
- Use the Power Supply at a humidity of 10% to 90%.
- Do not use the Power Supply in locations where condensation may occur due to high humidity or where temperature changes are severe.
- Do not use the Power Supply in locations subject to direct sunlight.
- Do not use the Power Supply in locations where liquids, foreign matter, or corrosive gases may enter the interior of products.

## Overload Protection

- Internal parts may possibly deteriorate or be damaged if a short-circuited or overcurrent state continues during operation.
- Internal parts may possibly deteriorate or be damaged if the Power Supply is used for applications with frequent inrush current or overloading at the load end. Do not use the Power Supply for such applications.

## Charging the Battery

- This product is not intended to function as a battery charger. If a battery is to be connected as the load, mount an overcurrent limiting circuit and an overvoltage protection circuit.

## Output Voltage Adjuster

- The output voltage adjuster (V.ADJ) may possibly be damaged if it is turned with unnecessary force. Do not turn the adjuster with excessive force.
- After changing the setting of the adjuster, make sure that the output capacity and output current do not exceed the rated output capacity and rated output current.
- Output voltage is adjustable with the output voltage adjuster (V.ADJ) on the front surface of the product from -10% to +15% of the rated output voltage.  
Do not increase the output voltage by more than 10% when connected to a ZEN CPU Unit rated for 24 VDC.

## DIN Track Mounting

To mount the Power Supply on a DIN track, hook portion (A) of the Power Supply onto the track and press the Power Supply in direction (B).

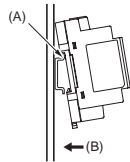

To dismount the Power Supply, pull down portion (C) with a flat-blade screwdriver and pull out the Power Supply.

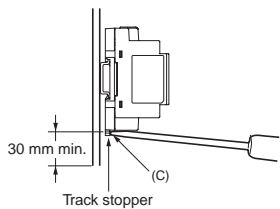

## Series Operation

The Power Supply is not designed for series operation.

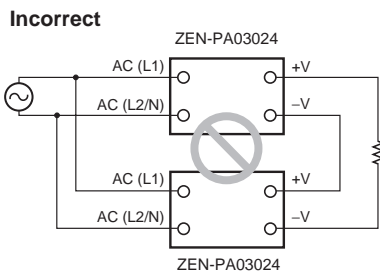

## Output voltage ( $\pm$ )

Two Power Supplies can be used to create a  $\pm$  output.

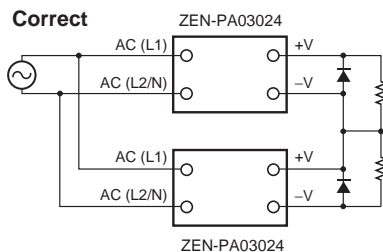

**Note:** When the load is an operational amplifier or other device allowing series operation, a startup failure may occur when the Power Supply is turned ON and internal circuits may be damaged. Connect a diode as shown in the figure to prevent this.

Use the following guidelines to select the diode.

Type	Schottky Barrier diode
Dielectric strength ( $V_{RRM}$ )	Twice the rated output voltage or above
Forward current ( $I_F$ )	Twice the rated output voltage or above

## Parallel Operation

Two Power Supplies can be operated in parallel.

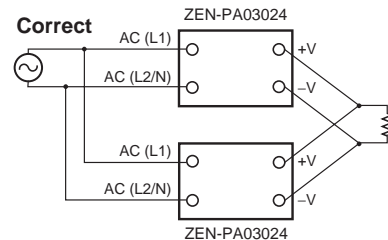

- Note:**
1. For parallel operation, a maximum of two Power Supplies of the same model can be connected.
  2. For a DC input, parallel operation is possible only for 110 to 350 VDC.
  3. To ensure that the voltage drop between each Power Supply and the load is the same, use the same wire length and thickness to connect the load.
  4. The load current will become imbalanced if the output voltages are different, possibly causing a serious reduction in the life of one of the Power Supplies. Adjust the output voltages of the Power Supplies to the same value.

## In Case there is No Output Voltage

The possible cause for no output voltage may be the presence of an overload or overvoltage condition, or may be due to the functioning of a latching protective device. The latching protection may operate if a large amount of surge voltage such as a lightning surge occurs while turning ON the Power Supply.

In case there is no output voltage, please check the following points before contacting us:

- Check the overload protected status: Check whether the load is in overload status or is short-circuited. Remove wires to load when checking.
- Attempt to clear the latching protection function: Turn the power supply OFF once, and leave it OFF for at least 1 minute. Then turn it on again to see if this clears the condition.

## Insulation Resistance Test

When performing the test, be sure to short-circuit all the output terminals to protect them from damage.

## Dielectric Strength Test

- When a high voltage is applied between the input terminals and the output terminals, electric energy builds up across the inductor L and capacitor C of the internal noise filter. This energy may generate a voltage surge when a high voltage is applied to the Power Supply by a switch or timer, and as a result, the internal parts of the Power Supply may possibly be damaged. To prevent voltage impulses when testing, decrease the applied voltage using the variable resistor on the dielectric strength testing equipment, or apply the voltage so that it crosses the zero point when it rises or falls.
- When performing the test, be sure to short-circuit all the output terminals to protect them from damage.

# Warranty and Application Considerations

## Warranty and Limitations of Liability

### WARRANTY

OMRON's exclusive warranty is that the products are free from defects in materials and workmanship for a period of one year (or other period if specified) from date of sale by OMRON.

OMRON MAKES NO WARRANTY OR REPRESENTATION, EXPRESS OR IMPLIED, REGARDING NON-INFRINGEMENT, MERCHANTABILITY, OR FITNESS FOR PARTICULAR PURPOSE OF THE PRODUCTS. ANY BUYER OR USER ACKNOWLEDGES THAT THE BUYER OR USER ALONE HAS DETERMINED THAT THE PRODUCTS WILL SUITABLY MEET THE REQUIREMENTS OF THEIR INTENDED USE. OMRON DISCLAIMS ALL OTHER WARRANTIES, EXPRESS OR IMPLIED.

### LIMITATIONS OF LIABILITY

OMRON SHALL NOT BE RESPONSIBLE FOR SPECIAL, INDIRECT, OR CONSEQUENTIAL DAMAGES, LOSS OF PROFITS, OR COMMERCIAL LOSS IN ANY WAY CONNECTED WITH THE PRODUCTS, WHETHER SUCH CLAIM IS BASED ON CONTRACT, WARRANTY, NEGLIGENCE, OR STRICT LIABILITY.

In no event shall the responsibility of OMRON for any act exceed the individual price of the product on which liability is asserted.

IN NO EVENT SHALL OMRON BE RESPONSIBLE FOR WARRANTY, REPAIR, OR OTHER CLAIMS REGARDING THE PRODUCTS UNLESS OMRON'S ANALYSIS CONFIRMS THAT THE PRODUCTS WERE PROPERLY HANDLED, STORED, INSTALLED, AND MAINTAINED AND NOT SUBJECT TO CONTAMINATION, ABUSE, MISUSE, OR INAPPROPRIATE MODIFICATION OR REPAIR.

## Application Considerations

### SUITABILITY FOR USE

OMRON shall not be responsible for conformity with any standards, codes, or regulations that apply to the combination of products in the customer's application or use of the products.

Take all necessary steps to determine the suitability of the product for the systems, machines, and equipment with which it will be used.

Know and observe all prohibitions of use applicable to this product.

NEVER USE THE PRODUCTS FOR AN APPLICATION INVOLVING SERIOUS RISK TO LIFE OR PROPERTY WITHOUT ENSURING THAT THE SYSTEM AS A WHOLE HAS BEEN DESIGNED TO ADDRESS THE RISKS, AND THAT THE OMRON PRODUCTS ARE PROPERLY RATED AND INSTALLED FOR THE INTENDED USE WITHIN THE OVERALL EQUIPMENT OR SYSTEM.

## Disclaimers

### CHANGE IN SPECIFICATIONS

Product specifications and accessories may be changed at any time based on improvements and other reasons. Consult with your OMRON representative at any time to confirm actual specifications of purchased product.

### DIMENSIONS AND WEIGHTS

Dimensions and weights are nominal and are not to be used for manufacturing purposes, even when tolerances are shown.

**ALL DIMENSIONS SHOWN ARE IN MILLIMETERS.**

To convert millimeters into inches, multiply by 0.03937. To convert grams into ounces, multiply by 0.03527.

Cat. No. L103-E1-01 **In the interest of product improvement, specifications are subject to change without notice.**

## OMRON Corporation

Industrial Automation Company

Industrial Devices and Components Division H.Q.

Industrial Control Components Department

Shiokoji Horikawa, Shimogyo-ku,

Kyoto, 600-8530 Japan

Tel: (81)75-344-7119/Fax: (81)75-344-7149

Printed in Japan

0903-3M (0903) (O)