

C500-LDP01-V1

Ladder Program I/O Unit

Operation Manual

Revised January 1992

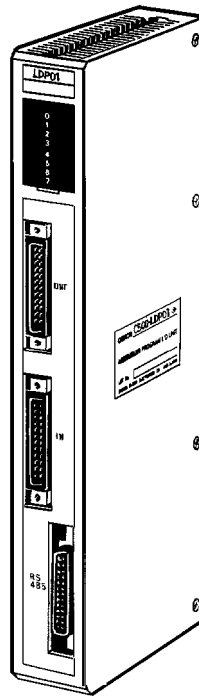

Notice:

OMRON products are manufactured for use according to proper procedures by a qualified operator and only for the purposes described in this manual.

The following conventions are used to indicate and classify warnings in this manual. Always heed the information provided with them.

Caution Indicates information that, if not heeded, could result in minor injury or damage to the product.

DANGER! Indicates information that, if not heeded, could result in loss of life or serious injury.

OMRON Product References

All OMRON products are capitalized in this manual. The word "Unit" is also capitalized when it refers to an OMRON product, regardless of whether or not it appears in the proper name of the product.

The abbreviation "Ch," which appears in some displays and on some OMRON products, often means "word" and is abbreviated "Wd" in documentation in this sense.

The abbreviation "PC" means Programmable Controller and is not used as an abbreviation for anything else.

Visual Aids

The following headings appear in the left column of the manual to help you locate different types of information.

Note Indicates information of particular interest for efficient and convenient operation of the product.

1, 2, 3... 1. Indicates lists of one sort or another, such as procedures, checklists, etc.

© OMRON, 1992

All rights reserved. No part of this publication may be reproduced, stored in a retrieval system, or transmitted, in any form, or by any means, mechanical, electronic, photocopying, recording, or otherwise, without the prior written permission of OMRON.

No patent liability is assumed with respect to the use of the information contained herein. Moreover, because OMRON is constantly striving to improve its high-quality products, the information contained in this manual is subject to change without notice. Every precaution has been taken in the preparation of this manual. Nevertheless, OMRON assumes no responsibility for errors or omissions. Neither is any liability assumed for damages resulting from the use of the information contained in this publication.

TABLE OF CONTENTS

SECTION 1

Introduction	1
1-1 Features	2
1-2 System Configuration	2
1-3 Comparing the C500-LDP01 and the C500-LDP01-V1	3
1-4 Nomenclature	4

SECTION 2

Preparations	5
2-1 Front Panel Switches and Selectors	6
2-2 Back Panel DIP Switch	11

SECTION 3

Data Areas	13
3-1 IR (Internal Relay) Area	14
3-2 Work Bits	17
3-3 SR (Special Relay) Area	18
3-4 TR (Temporary Relay) Bits	18
3-5 TC (Timer/Counter) Area	18
3-6 DM (Data Memory) Area	18

SECTION 4

Programming	21
4-1 Program Addresses and Memory Capacity	22
4-2 Operating Modes	22
4-3 Changing the Operating Mode	22
4-4 Programming Devices	23
4-5 Online Operations	24

SECTION 5

Program Execution Timing	27
5-1 Operation in RUN and MONITOR Modes	28
5-2 Scan Time	28
5-3 Instruction Execution Times	29
5-4 I/O Response Time	32

SECTION 6

Maintenance and Troubleshooting	35
6-1 Error Messages and Troubleshooting	36
6-2 Maintenance	37

Appendices

A Standard Models	39
B Specifications	41
C Programming Instructions	45
D Error and Arithmetic Flag Operation	55

Index	57
--------------------	-----------

OMRON Sales Offices	59
----------------------------------	-----------

Revision History	63
-------------------------------	-----------

About this Manual:

This manual describes the installation and operation of the C500-LD01-V1 Ladder Program I/O Unit and includes the sections described below.

Please read this manual completely and be sure you understand the information provide before attempting to install and operation the Ladder Program I/O Unit.

Section 1 introduces the Unit and describes its components and the way it fits into a PC system. A comparison of the C500-LD01-V1 and the C500-LD01 is also provided.

Section 2 provides information on switch settings and how certain switch settings affect indicator operation. These switch must be set before mounting and operating the Unit.

Section 3 describes the data areas available for use in programming the Unit.

Section 4 provides information related to programming and operating the Unit. A list of programming instructions is provided in *Appendix C Programming Instructions*. Details on programming can be found in the *C500 Operation Manual*.

Section 5 describes the scan of the Unit and how the operating mode affects it. It also describes scan time and I/O response time calculations and provides tables of instruction execution times.

Section 6 provides basic troubleshooting steps, error messages provided by the indicators, and the fuse replacement procedure.

SECTION 1

Introduction

This section introduces the main features and applications of the Ladder Program I/O Unit and describes how it relates to I/O devices and Programming Devices. It also provides a table that describes additions made to the V1 version of the Unit and provides the names and locations of the various parts of the Unit.

1-1	Features	2
1-2	System Configuration	2
1-3	Comparing the C500-LDP01 and the C500-LDP01-V1	3
1-4	Nomenclature	4

1-1 Features

The C500-LDP01-V1 Ladder Program I/O Unit executes a ladder program to control external I/O independently of the PC. The ladder program contained in the Unit is written by the user.

The C500-LDP01-V1 Ladder Program I/O Unit can be used with the following SYSMAC C-series PCs: C500, C1000H, C2000H.

Applications Examples

- External I/O can be controlled by the Ladder Program I/O Unit instead of the PC.
- The Ladder Program I/O Unit can be used as a timer.
- The Ladder Program I/O Unit can be used as a high-speed input unit.
- By controlling external inputs and outputs, the Ladder Program I/O Unit can reduce the processing load handled by the PC.

C500 Instructions

The Ladder Program I/O Unit uses the same instructions as the C500, so ladder programs can be constructed in the same way. A total of 49 different instructions is available. (Not all C500 instructions are supported.)

External I/O Points: 16 Input/16 Output

The 16 DC inputs and 16 transistor outputs can be connected to external I/O devices so the Unit can be used as for normal I/O operation. Of the 16 DC inputs, 8 inputs (2 groups of 4) can be set for high-speed inputs with a minimum pulse width of 0.5 ms, so inputs shorter than the scan time can be detected.

PC I/O Points: 16 Input and 16 Output

The Unit connects to the PC through 16 input points and 16 output points, so control signals can be passed back and forth between the PC and the Unit. Furthermore, when the I/O WRITE and I/O READ (WRIT(87)/READ(88)) instructions are executed in the PC program, up to 32 words of data can be transferred to or from the Unit.

Built-in Realtime Clock

A realtime clock is built into the Unit, so it can act as a timer and manage I/O timing.

1-2 System Configuration

The following figure shows a typical system configuration:

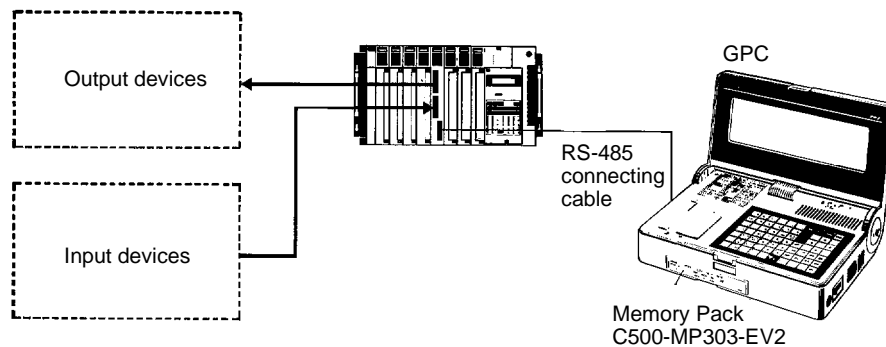

The Unit can be programmed through the GPC with Memory Pack C500-MP303-EV2, through the FIT, or through LSS running on an IBM AT/XT compatible computer. Refer to *Appendix C Programming Instructions* for a list of instructions. Online operations between the Unit and the GPC/FIT/LSS are possible in PROGRAM or MONITOR mode. They are not possible in RUN mode.

1-3 Comparing the C500-LDP01 and the C500-LDP01-V1

The following table shows the improvements that have been made to create the C500-LDP01-V1.

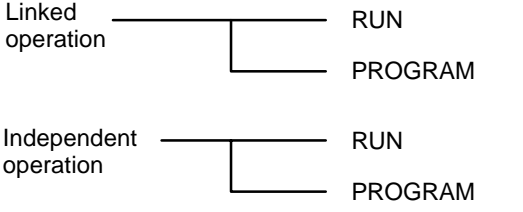
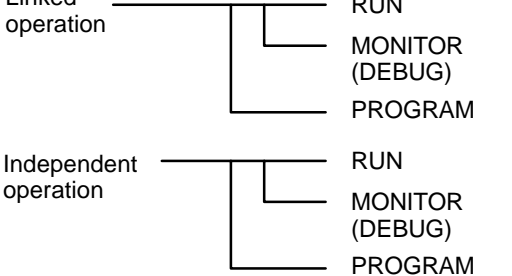
Item	C500-LDP01	C500-LDP01-V1
Instruction set	40 instructions	The following instructions were added to make a total of 49 instructions. ASL(25): ARITHMETIC SHIFT LEFT ASR(26): ARITHMETIC SHIFT RIGHT ROL(27): ROTATE LEFT ROR(28): ROTATE RIGHT COM(29): COMPLEMENT INC(38): INCREMENT DEC(39): DECREMENT SLD(74): ONE DIGIT SHIFT LEFT SRD(75): ONE DIGIT SHIFT RIGHT
Number of words allocated	2 words 16 PC output bits (0000 through 0015) 16 PC input bits (0100 through 0115) The PC cannot access the Unit using the I/O WRITE and the I/O READ (WRIT(87)/READ(88)) instructions.	2 words 16 PC output bits (0000 through 0015) 16 PC input bits (0100 through 0115) With the proper switch settings, the PC can control the Unit using the I/O WRITE and I/O READ (WRIT(87)/READ(88)) instructions. (Up to 32 words are written or read.)
Operating modes	 <p>The GPC/FIT/LSS* can operate with the Unit in PROGRAM mode only.</p>	 <p>The GPC/FIT/LSS* can operate with the Unit in either PROGRAM or MONITOR (debug) mode.</p>

*GPC: Graphic Programming Console
 FIT: Factory Intelligent Terminal
 LSS: Ladder Support Software

1-4 Nomenclature

Front Panel

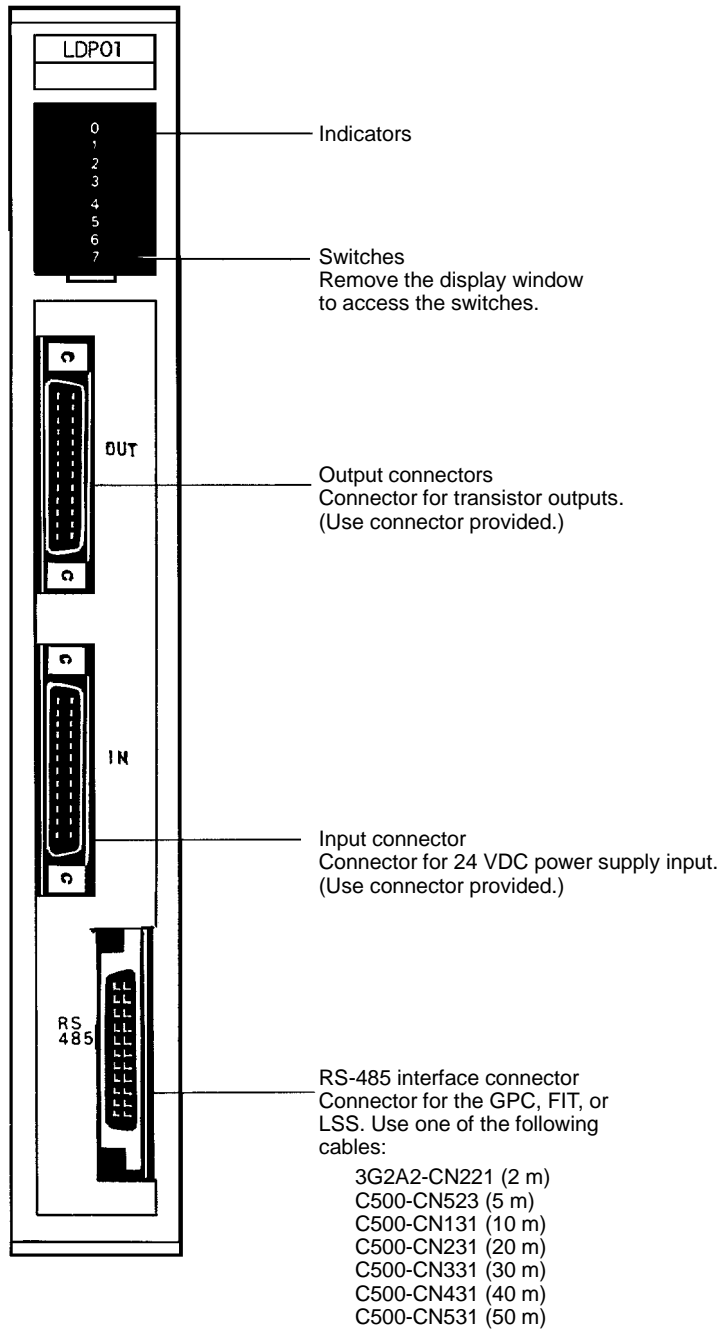

Back Panel

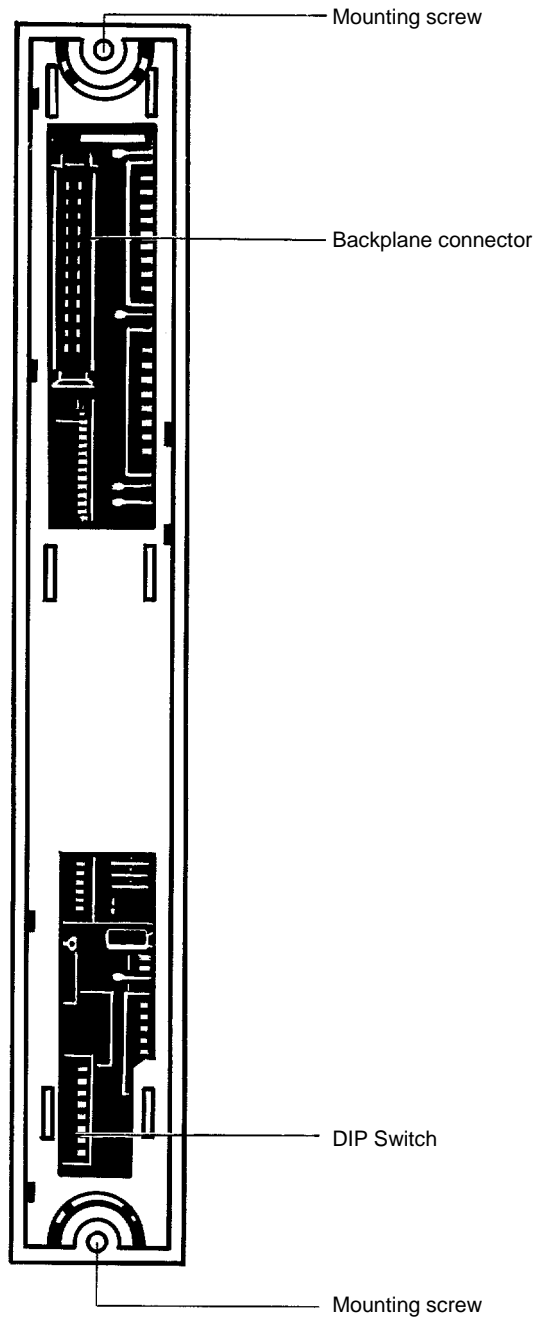

SECTION 2

Preparations

This section describes the switch settings required prior to operation. The operation of Unit indicators, which are controlled by a switch setting, is also described.

2-1	Front Panel Switches and Selectors	6
2-2	Back Panel DIP Switch	11

2-1 Front Panel Switches and Selectors

Switch/Selector Location Remove the display window using a standard screwdriver to access the switches and selectors shown below.

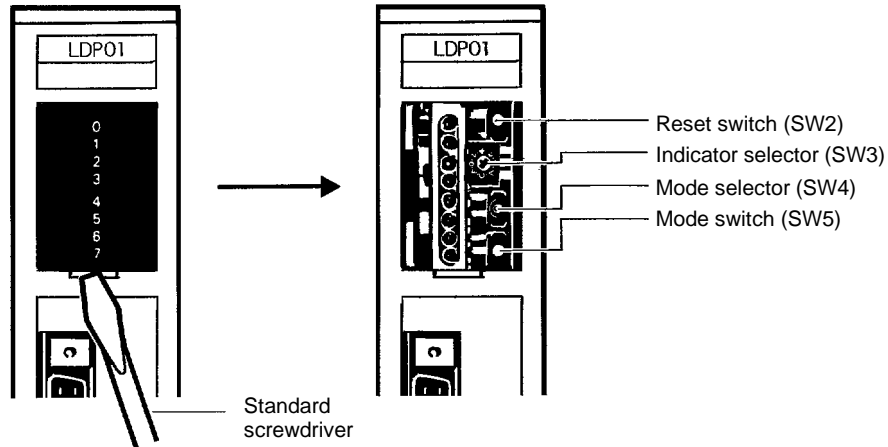

Switch/Selector Functions

Switch No.	Designation	Function
SW 2	Reset switch	The Unit can be reset and restarted by pressing the reset switch. Note Resetting the Unit completely clears I/O bit status and data memory. If the back panel DIP switch is set for PC-linked operation, the Unit will enter RUN or PROGRAM mode after resetting, depending on the status of the PC. If the back panel DIP switch is set for independent operation, the Unit will enter RUN, MONITOR (debug), or PROGRAM mode, depending on the setting of SW4. The same process occurs when the power is turned on.
SW 3	Display selector	Select indicator operation with this selector. Refer to the following pages for details.
SW 4	Mode selector	Changing this selector followed by pressing and releasing SW5 will alter the operating mode as shown below. This switch also determines the mode entered when power is turned on or the Unit is reset. SW 4 set to up position RUN SW 4 set to center MONITOR (debug) SW 4 set to down position PROGRAM
SW 5	Mode switch	When this switch is pressed and released, the Unit will enter the mode set on SW4. The operation of this switch is enabled by turning on pin 5 of the back panel DIP switch, and disabled by turning off pin 5. The Unit cannot be switched to RUN or MONITOR mode when the program is being transferred from a Programming Device or an error has occurred.

Display Selector

Switching the display selector (SW3) alters the indicator operation as follows:

SW3	Description	Indicator	Function
0	Indicate operating mode	0	RUN Lit during operation. Not lit in PROGRAM mode.
		1	MONITOR (debug) Lit in MONITOR (debug) mode. Not lit in RUN or PROGRAM mode.
		2	PROGRAM Lit in PROGRAM mode. Not lit during operation.
		3	PC stop Lit while the PC is not in operation (either in PROGRAM mode or in case of error).
		4	Error Lit to indicate an error during operation. Refer to 6-1 Error Messages and Troubleshooting for details.
		5	High-speed input 1 is set. Lit when external input bits 0200 through 0203 are set for high-speed inputs (Pin 3 of the DIP switch is turned on).
		6	High-speed input 2 is set. Lit when external input bits 0204 through 0207 are set for high-speed inputs (Pin 4 of the DIP switch is turned on).
		7	Communicating Lit when the Unit is communicating with the GPC, FIT, or LSS.
1	Indicate the status of output bits 0000 to 0007	0	0000 Lit while corresponding output is ON.
		1	0001
		2	0002
		3	0003
		4	0004
		5	0005
		6	0006
		7	0007
2	Indicate the status of output bits 0008 to 0015	0	0008 Lit while corresponding output is ON.
		1	0009
		2	0010
		3	0011
		4	0012
		5	0013
		6	0014
		7	0015
3	Indicate the status of input bits 0100 to 0107	0	0100 Lit while corresponding input is ON.
		1	0101
		2	0102
		3	0103
		4	0104
		5	0105
		6	0106
		7	0107

SW3	Description	Indicator	Function	
4	Indicate the status of input bits 0108 to 0115	0	0108	Lit while corresponding input is ON.
		1	0109	
		2	0110	
		3	0111	
		4	0112	
		5	0113	
		6	0114	
		7	0115	
5	Indicate the status of external input bits 0200 to 0207	0	0200	Lit while corresponding input is ON.
		1	0201	
		2	0202	
		3	0203	
		4	0204	
		5	0205	
		6	0206	
		7	0207	
6	Indicate the status of external input bits 0208 to 0215	0	0208	Lit while corresponding input is ON.
		1	0209	
		2	0210	
		3	0211	
		4	0212	
		5	0213	
		6	0214	
		7	0215	
7	Indicate the status of external output bits 0300 to 0307	0	0300	Lit while corresponding output is ON.
		1	0301	
		2	0302	
		3	0303	
		4	0304	
		5	0305	
		6	0306	
		7	0307	

SW3	Description	Indicator	Function	
8	Indicate the status of external output bits 0308 to 0315	0	0308	
		1	0309	
		2	0310	
		3	0311	
		4	0312	
		5	0313	
		6	0314	
		7	0315	
Lit while corresponding output is ON.				
9	Indicate the year of the clock	0	8	$\times 10^1$
		1	4	
		2	2	
		3	1	
		4	8	$\times 10^0$
		5	4	
		6	2	
		7	1	
The last two digits of the calendar year are displayed. Data: 00 to 99				
A	Indicate the month of the clock	0	---	
		1	---	
		2	---	
		3	1	$\times 10^1$
		4	8	
		5	4	$\times 10^0$
		6	2	
		7	1	
Data: 01 to 12 Indicators 0 through 2 are always OFF.				
B	Indicate the date of the clock	0	---	
		1	---	
		2	2	$\times 10^1$
		3	1	
		4	8	$\times 10^0$
		5	4	
		6	2	
		7	1	
Data: 01 to 31 Indicators 0 and 1 are always OFF.				

SW3	Description	Indicator	Function	
C	Indicate the hour of the clock	0	----	
		1	----	
		2	2	x 10 ¹
		3	1	
		4	8	x 10 ⁰
		5	4	
		6	2	
		7	1	
D	Indicate the minutes of the clock	0	----	
		1	4	x 10 ¹
		2	2	
		3	1	
		4	8	x 10 ⁰
		5	4	
		6	2	
		7	1	
E	Indicate the seconds of the clock	0	----	
		1	4	x 10 ¹
		2	2	
		3	1	
		4	8	x 10 ⁰
		5	4	
		6	2	
		7	1	
F	Indicate the day of the week	0	----	
		1	----	
		2	----	
		3	----	
		4	----	
		5	4	x 10 ⁰
		6	2	
		7	1	
		Data: 00 to 23 (24-hour clock) Indicators 0 and 1 are always OFF.		
		Data: 00 to 59 (minutes) Indicator 0 is always OFF.		
		Data: 00 to 59 (seconds) Indicator 0 is always OFF.		
		Data: 00 to 06 Indicators 0 through 4 are always OFF. 00: Sunday; 01: Monday; 02: Tuesday; 03: Wednesday; 04: Thursday; 05: Friday; 06: Saturday		

2-2 Back Panel DIP Switch

The DIP switch on the back panel sets the operating conditions of the Unit. All pins are OFF at the time of delivery.

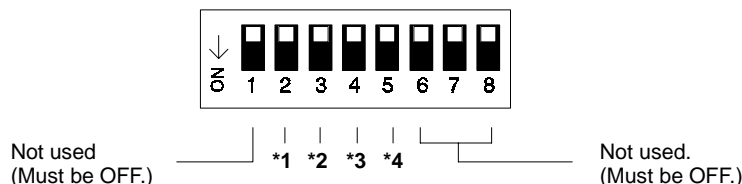

*1. PC Data Transfer

2	Function
OFF	Data transfer between the PC and this Unit is the same as that for a standard 16-point I/O Unit.
ON	Data transfer between the PC and this Unit is carried out automatically via the I/O WRITE and I/O READ (WRIT(87)/READ(88)) instructions.

*2. High-speed Inputs 1

3	Function
OFF	Sets external input bits 0200 to 0203 for standard inputs.
ON	Sets external input bits 0200 to 0203 for high-speed inputs. A pulse width of 0.5 ms or longer can be received.

*3. High-speed Inputs 2

4	Function
OFF	Sets external input bits 0204 to 0207 for standard inputs.
ON	Sets external input bits 0204 to 0207 for high-speed inputs. A pulse width of 0.5 ms or longer can be received.

*4. Independent Operation/Linked Operation

5	Function
OFF	Operates in the same mode as the PC when the PC is in RUN or PROGRAM mode, but won't enter MONITOR mode. The Unit will be in RUN mode if the PC is in MONITOR mode. Front panel switches 4 and 5 are disabled.
ON	Operating mode switched independently of PC operating mode. Switches 4 and 5 (front panel) determine operating mode.

- Note**
1. Refer to *Section 3 Data Areas* for information about PC data transfer.
 2. Refer to *Section 5 Program Execution Timing* for information about high-speed inputs 1 and 2.
 3. Refer to *Section 4 Programming* and *Appendix C Programming Instructions* for information about linked operation with the PC.

Caution If power is applied to the PC when pin 5 is OFF and the PC is set for RUN or MONITOR mode, the Ladder Program I/O Unit will automatically switch to RUN mode. If the Unit is communicating with the GPC, FIT, or LSS it will switch to RUN mode when the operation is completed.

SECTION 3

Data Areas

This section describes the data areas available for use in programming. The use of the I/O READ and I/O WRITE instructions are also described.

3-1	IR (Internal Relay) Area	14
3-1-1	Normal I/O Operation	15
3-1-2	Operation via WRIT(87)/READ(88)	16
3-2	Work Bits	17
3-3	SR (Special Relay) Area	18
3-4	TR (Temporary Relay) Bits	18
3-5	TC (Timer/Counter) Area	18
3-6	DM (Data Memory) Area	18

3-1 IR (Internal Relay) Area

Data	Word/bit address		
16 bits (0000 to 0015) Output bits as seen from the PC	IR 00		Input bits as seen from the Unit. Cannot be used as work bits. The use of these bits depends on the setting of pin 2 of the back panel DIP switch. Refer to following subsections for details.
	00	08	
	01	09	
	02	10	
	03	11	
	04	12	
	05	13	
	06	14	
07	15		
16 bits (0100 to 0115) Input bits as seen from the PC	IR 01		Output bits as seen from the Unit. Cannot be used as work bits. The use of these bits depends on the setting of pin 2 of the back panel DIP switch. Refer to following subsections for details.
	00	08	
	01	09	
	02	10	
	03	11	
	04	12	
	05	13	
	06	14	
07	15		
16 external input bits (0200 to 0215)	IR 02		Bits 0200 to 0207 can be set for high-speed inputs. Cannot be used as work bits.
	00	08	
	01	09	
	02	10	
	03	11	
	04	12	
	05	13	
	06	14	
07	15		
16 external output bits (0300 to 0315)	IR 03		Cannot be used as work bits.
	00	08	
	01	09	
	02	10	
	03	11	
	04	12	
	05	13	
	06	14	
07	15		

3-1-1 Normal I/O Operation

When pin 2 of the back panel DIP switch is OFF, data is transferred through 2 words allocated for I/O. If pin 2 is OFF, data cannot be not transferred to and from the Ladder Program I/O Unit using the I/O WRITE and I/O READ (WRIT(87)/READ(88)) instructions from the PC.

The output bit data in PC word n (the first word allocated to the Unit by the PC) is input to word 00 in the Ladder Program I/O Unit. The bits of word 00 are treated as input bits when programming the Ladder Program I/O Unit.

The input bit data in PC word n+1 is output from word 01 in the Ladder Program I/O Unit. The bits of word 01 are treated as output bits when programming the Ladder Program I/O Unit.

PC Word Allocation			Unit Word Allocation		
Bit No.	IR n	IR n+1	Bit No.	Word 00	Word 01
	Output	Input		Input	Output
00	Output bit 00	Input bit 00	00	Input bit 00	Output bit 00
01	Output bit 01	Input bit 01	01	Input bit 01	Output bit 01
02	Output bit 02	Input bit 02	02	Input bit 02	Output bit 02
03	Output bit 03	Input bit 03	03	Input bit 03	Output bit 03
04	Output bit 04	Input bit 04	04	Input bit 04	Output bit 04
05	Output bit 05	Input bit 05	05	Input bit 05	Output bit 05
06	Output bit 06	Input bit 06	06	Input bit 06	Output bit 06
07	Output bit 07	Input bit 07	07	Input bit 07	Output bit 07
08	Output bit 08	Input bit 08	08	Input bit 08	Output bit 08
09	Output bit 09	Input bit 09	09	Input bit 09	Output bit 09
10	Output bit 10	Input bit 10	10	Input bit 10	Output bit 10
11	Output bit 11	Input bit 11	11	Input bit 11	Output bit 11
12	Output bit 12	Input bit 12	12	Input bit 12	Output bit 12
13	Output bit 13	Input bit 13	13	Input bit 13	Output bit 13
14	Output bit 14	Input bit 14	14	Input bit 14	Output bit 14
15	Output bit 15	Input bit 15	15	Input bit 15	Output bit 15

3-1-2 Operation via WRIT(87)/READ(88)

When pin 2 of the back panel DIP switch is ON, data can be transferred to and from the Ladder Program I/O Unit using the I/O WRITE and I/O READ (WRIT(87)/READ(88)) instructions from the PC. WRIT(87) and READ(88) are used automatically for this data transfer in the Ladder Program I/O Unit and are not available for user programming except in the PC. The Ladder Program I/O Unit must be mounted to the CPU Rack or Expansion I/O Rack of a PC that supports WRIT(87)/READ(88).

Data written by the WRIT(87) instruction in the PC program is stored in DM 064 through DM 095 in the Unit. A maximum of 32 words can be transferred. Data read by the READ(88) instruction in the PC is stored in DM 096 through DM 127. A maximum of 32 words of data can be read. The bits in parentheses are controlled automatically (as described below) when WRIT(87)/READ(88) are enabled. Treat these as read-only bits. The other input and output bits shown below can be used as normal I/O bits.

Do not output to word n with the MOV(21) instruction in the PC program. When outputting to word n, set the PC Busy, PC Write Completed, and PC Read Completed Flags to 0 (OFF). Also, do not output to word 01 with the MOV(21) instruction in the Ladder Program I/O Unit program. When outputting to word 01, set the I/O Busy, I/O Read End, I/O Write End, I/O Read OK, and I/O Write OK Flags to 0 (OFF).

Bit 0103 (the I/O Read OK Flag) is turned ON when data has been transferred correctly with the WRIT(87) instruction. It remains ON until the WRIT(87) instruction is executed again. Bit 0104 (the I/O Write OK Flag) is turned ON when data has been written from the Ladder Program I/O Unit. It is turned OFF when the READ(88) instruction is executed in the PC.

PC Word Allocation			Unit Word Allocation		
Bit No.	IR n	IR n+1	Bit No.	Word 00	Word 01
	Output	Input		Input	Output
00	(PC Busy)	(I/O Busy)	00	(PC Busy)	(I/O Busy)
01	(PC Write Complete)	(I/O Read End)	01	(PC Write Complete)	(I/O Read End)
02	(PC Read Complete)	(I/O Write End)	02	(PC Read Complete)	(I/O Write End)
03	Output bit 03	(I/O Read Ok)	03	Input bit 03	(I/O Read Ok)
04	Output bit 04	(I/O Write Ok)	04	Input bit 04	(I/O Write Ok)
05	Output bit 05	Input bit 05	05	Input bit 05	Output bit 05
06	Output bit 06	Input bit 06	06	Input bit 06	Output bit 06
07	Output bit 07	Input bit 07	07	Input bit 07	Output bit 07
08	Output bit 08	Input bit 08	08	Input bit 08	Output bit 08
09	Output bit 09	Input bit 09	09	Input bit 09	Output bit 09
10	Output bit 10	Input bit 10	10	Input bit 10	Output bit 10
11	Output bit 11	Input bit 11	11	Input bit 11	Output bit 11
12	Output bit 12	Input bit 12	12	Input bit 12	Output bit 12
13	Output bit 13	Input bit 13	13	Input bit 13	Output bit 13
14	Output bit 14	Input bit 14	14	Input bit 14	Output bit 14
15	Output bit 15	Input bit 15	15	Input bit 15	Output bit 15

3-2 Work Bits

Works bits are available for use in programming as required by the user. In the Ladder Program I/O Unit, work bits run from word 04 to word 12 and from bit 0400 to bit 1207, as shown below.

Word/bit address							
Word 04		Word 05		Word 06		Word 07	
00	08	00	08	00	08	00	08
01	09	01	09	01	09	01	09
02	10	02	10	02	10	02	10
03	11	03	11	03	11	03	11
04	12	04	12	04	12	04	12
05	13	05	13	05	13	05	13
06	14	06	14	06	14	06	14
07	15	07	15	07	15	07	15
Word 08		Word 09		Word 10		Word 11	
00	08	00	08	00	08	00	08
01	09	01	09	01	09	01	09
02	10	02	10	02	10	02	10
03	11	03	11	03	11	03	11
04	12	04	12	04	12	04	12
05	13	05	13	05	13	05	13
06	14	06	14	06	14	06	14
07	15	07	15	07	15	07	15
Word 12							
00	Not usable.						
01							
02							
03							
04							
05							
06							
07							

3-3 SR (Special Relay) Area

The following 16 bits are available for use in programming. Most of these are flags that can be read to determine program execution status or results. Bit 1304, the Carry Flag, is also manipulated by the user with STC(40) and CLC(41). Refer to descriptions of similar bits in the C500 Operation Manual for details.

Bit address	Description
1208	Always OFF
1209	Turns ON for scans over 100 ms
1210	Always OFF
1211	
1212	
1213	Always ON
1214	Always OFF
1215	Turns ON for one scan time at the beginning of operation.
1300	0.1 sec clock pulse
1301	0.2 sec clock pulse
1302	1.0 sec clock pulse
1303	Turns ON when the operational data is not BCD (ER flag).
1304	Turns ON if the operational result produces a carry (CY flag).
1305	Turns ON if the operational result is greater (GR flag).
1306	Turns ON if the operational result is equal to zero (EQ flag).
1307	Turns On if the operational result is less (LE flag).

3-4 TR (Temporary Relay) Bits

TR 0 through TR 7 can be used to store execution conditions at branches in ladder-diagram programs.

3-5 TC (Timer/Counter) Area

TC 00 through TC 15 can be used to define timers and counters in the program. Each TC number can be used only once to define a timer or counter.

3-6 DM (Data Memory) Area

The DM area contains 128 words between DM 000 and DM 127 and is used for storage of data by word. Although each word contains 16 bits, the DM area is accessible in word units only.

Clock data is assigned to DM 60 to 63; these words cannot be used for standard data. The clock can be set by writing data to these addresses in PROGRAM or MONITOR mode from a Programming Device or from the program. The clock is factory set to Sunday, January 1, year 00, 00:00:00. When power is applied, the clock starts at this time, and will continue timing for up to 10 days even if the power is cut off.

DM 064 through DM 127 are used for data transfer when pin 2 of the back panel DIP switch is turned ON (i.e., data transfer by the WRIT(87) and READ(88) instructions is enabled), and this region of the DM area cannot be used as normal DM words.

DM address							
000	016	032	048	064	080	096	112
001	017	033	049	065	081	097	113
002	018	034	050	066	082	098	114
003	019	035	051	067	083	099	115
004	020	036	052	068	084	100	116
005	021	037	053	069	085	101	117
006	022	038	054	070	086	102	118
007	023	039	055	071	087	103	119
008	024	040	056	072	088	104	120
009	025	041	057	073	089	105	121
010	026	042	058	074	090	106	122
011	027	043	059	075	091	107	123
012	028	044	060	076	092	108	124
013	029	045	061	077	093	109	125
014	030	046	062	078	094	110	126
015	031	047	063	079	095	111	127

DM 000	15	14	13	12	11	10	09	08	07	06	05	04	03	02	01	00
DM 001	15	14	13	12	11	10	09	08	07	06	05	04	03	02	01	00
...
DM 126	15	14	13	12	11	10	09	08	07	06	05	04	03	02	01	00
DM 127	15	14	13	12	11	10	09	08	07	06	05	04	03	02	01	00

Data Configuration in DM 060 to DM 127

Word	Bits 8 to 15	Bits 0 to 7
DM 060	Minutes (0 to 59)	Seconds (0 to 59)
DM 061	Date (1 to 31)	Hour (0 to 23)
DM 062	Calendar year (last two digits: 00 to 99)	Month (1 to 12)
DM 063	---	Day of the week (Sunday [00] to Saturday [06])
DM 064 to DM 095	Back panel DIP switch pin 2 OFF: Used as normal DM words. Back panel DIP switch pin 2 ON: Used to store data transferred by the WRIT(87) instruction in the PC, and therefore cannot be used as normal DM words.	
DM 096 to DM 127	Back panel DIP switch pin 2 OFF: Used as normal DM words. Back panel DIP switch pin 2 ON: Used as normal DM words, but the data stored here will be read out by READ(88) in the PC.	

- Note**
1. If incorrect data is written to words DM 060 through DM 063, a clock data write error will occur, and indicator 3 will flash.
 2. DM 064 through DM 095, which contain the data written from the PC in the WRIT(87) instruction, should be read only and not written to from the program.

SECTION 4 Programming

This section describes the programming operations possible from the Programming Devices and the operating modes. Writing the program is basically the same as writing a program for the PC, except that the instruction set is a bit smaller and the data areas differ. Refer to the *C500 Operation Manual* for details on writing the program and to *Appendix C Programming Instructions* for the instruction set that can be used with the Unit.

4-1 Program Addresses and Memory Capacity

Instructions vary in length from 1 to 17 bytes. Since each instruction requires one address, the maximum number of addresses available in a program also varies. The instructions along with the corresponding number of bytes required for each are listed in *Appendix C Programming instructions*.

The memory capacity available for the program is 4K and hence the approximate maximum number of instructions which can be programmed is 524 (based on an average length of 8 bytes per instruction).

4-2 Operating Modes

Any one of three modes, RUN mode, MONITOR (debug) mode, or PROGRAM mode, can be selected in this Unit.

RUN Mode

Only executes the program. Programming Devices cannot be connected in this mode, and the Unit scans and processes the program at high-speed. Select this mode for normal operation.

MONITOR Mode

Executes the program. Execution of the program is possible while Programming Devices are connected. The processing time is longer than that in RUN mode, because of the time required to process transmissions to and from the Programming Device. MONITOR mode is mainly used to debug new programs. Refer to the following pages in this section for information about operations that can be performed online in MONITOR mode.

PROGRAM Mode

Does not execute the program. Normally used to transfer or compare the program. Refer to the following pages in this section for information about operations that can be performed online in PROGRAM mode.

4-3 Changing the Operating Mode

The program can be transferred to the Ladder Program I/O Unit only when it is in PROGRAM mode. The table below shows the mode which the Unit will enter when the Unit is turned on or reset. The operating mode is controlled by the settings of pin 5 of the back panel DIP switch, switch 4 on the front of the Unit, and the status of the PC.

SW4	PC in RUN or MONITOR mode		PC in PROGRAM mode	
	Pin 5 ON: Independent Operation	Pin 5 OFF: Linked Operation	Pin 5 ON: Independent Operation	Pin 5 OFF: Linked Operation
Up	RUN	RUN	RUN	PROGRAM
Center	MONITOR	MONITOR	MONITOR	PROGRAM
Down	PROGRAM	RUN	PROGRAM	PROGRAM

4-3-1 Linked Operation

The operating mode of the Unit is linked to the operating mode of the PC. After the operating mode shown above is entered when the Unit is turned on or reset,

the operating mode of the Unit can be changed to RUN or MONITOR mode as long as the PC is in RUN or MONITOR mode. The operating mode cannot be changed to PROGRAM mode or when the PC is in PROGRAM mode. When the PC mode is changed, the operating mode is determined by switch 4.

Switching to RUN Mode First set switch 4 to the up position, then press and release switch 5. The Unit will enter RUN mode. (If switch 3 is set to 0, indicator 0 will light.)

Switching to MONITOR Mode First set switch 4 to the center position, then press and release switch 5. The Unit will enter MONITOR mode. (If switch 3 is set to 0, indicator 1 will light.)

4-3-2 Independent Operation

The operating mode can be changed arbitrarily. After the operating mode determined by switch 4 is entered when the Unit is turned on or reset, the operating mode can be changed as explained below.

Switching to RUN Mode First set switch 4 to the up position, then press and release switch 5. The Unit will enter RUN mode. (If switch 3 is set to 0, indicator 0 will light.)

Switching to MONITOR Mode First set switch 4 to the center position, then press and release switch 5. The Unit will enter MONITOR mode. (If switch 3 is set to 0, indicator 1 will light.)

Switching to PROGRAM Mode First set switch 4 to the down position, then press and release switch 5. The Unit will enter PROGRAM mode. (If switch 3 is set to 0, indicator 2 will light.)

- Note**
1. The operating mode cannot be changed from PROGRAM mode to MONITOR mode or RUN mode while the program is being transferred from a Programming Device. The operating mode can be changed when the program transfer has been completed.
 2. If an error occurs that stops the Unit, the operating mode will be switched to PROGRAM mode regardless of the setting of pin 5 of the back panel DIP switch. Refer to *6-1 Error Messages and Troubleshooting* regarding errors that stop operation.
 3. When switching from PROGRAM mode to MONITOR or RUN mode, or from MONITOR or RUN mode to PROGRAM mode, the I/O bits and work bits will be reset completely. The DM area will not be affected.

4-4 Programming Devices

Please use the GPC, FIT, or LSS for programming. The programming procedure for the Ladder Program I/O Unit is identical to that for C-series PCs. Refer to the *GPC, FIT, or LSS Operation Manual* for details.

GPC	Main unit	3G2C5-GPC03-E/3G2C5-GPC04-E
	System Memory Cassette	C500-MP303-EV2
	Operation Manual	Catalog No. W84
FIT	Main unit	FIT10-SET11-E
	Operation Manual	Catalog No. W150
LSS	Main unit	C500-SF312-EV2/C500-SF711-EV2
	Operation Manual	Catalog No. W113

4-5 Online Operations

Online operations between the Unit and the GPC/FIT/LSS are possible only in PROGRAM or MONITOR mode. They are not possible in RUN mode. Only those operations listed below are possible online.

4-5-1 Online Operations with the GPC

Menu No.	Operation		MONITOR	PROGRAM
—	Connect/disconnect PC		Yes	Yes
	Mode changes		No	No
0	Monitoring	Error readout	Yes	Yes
		Error clear	Yes	Yes
		Monitoring bit status	Yes	Yes
		Monitoring I/O status	Yes	Yes
		Force set/reset	Yes	Yes
		Change PV1	Yes	Yes
		Change PV2	Yes	Yes
		Change ASCII	Yes	Yes
		Multipoint I/O monitor	Yes	Yes
		Word monitor	Yes	Yes
		Change TC PV	Yes	Yes
		Change TC SV1	No	No
		Change TC SV2	No	No
		Pause monitor display	Yes	Yes
		Time chart monitoring	Yes	Yes
1	I/O Table	Generating	No	No
		Comparing	No	No
		Reading	No	No
2	User program transfer	PC memory clear	No	Yes
		Transfer (GPC to Unit)	No	Yes
		Transfer (Unit to GPC)/Compare	Yes	Yes
3	DM area transfer	Transfer (GPC to Unit)	Yes	Yes
		Transfer (Unit to GPC)/Compare	Yes	Yes
4	Comment	Transfer (GPC to factory computer)	No	No
	memory	Transfer (factory computer to GPC)	No	No
	transfer	Compare	No	No

4-5-2 Online Operations with the FIT/LSS

The online operations that can be performed between the FIT/LSS and the Ladder Program I/O Unit are limited to monitoring and DM processes. Set the FIT/LSS as if connecting to a C500 PC. A "yes" indicates that the operation can be performed in this mode.

Monitoring

Operation	Application	MONITOR	PROGRAM
Monitor I/O status		Yes	Yes
Program transfer	Ladder Program I/O Unit to FIT/LSS	Yes	Yes
	FIT/LSS to Ladder Program I/O Unit	Yes	Yes
	Compare	Yes	Yes
Ladder diagram (without comments)		Yes	Yes
Ladder diagram (with comments)		Yes	Yes
Online editing	Line connection	No	No
	I/O comments	No	No
	Line comments	No	No
Scan time read		No	No
Data area clear		No	Yes
Search		Yes	Yes
I/O comments		Yes	Yes
Line comments		Yes	Yes
Memory display		Yes	Yes

I/O Monitor Operations

Operation	MONITOR	PROGRAM
Force Set/Reset	Yes	Yes

Basic Screen Function Keys

Function	MONITOR	PROGRAM
Release	Yes	Yes
Set value	No	No
Stop	Yes	Yes

Function Keys for Monitoring I/O

Function	MONITOR mode	PROGRAM mode
HEX:A	Yes	Yes
Release	No	No
Forced Release	No	No
Clear	Yes	Yes
Change	Yes	Yes
Stop	Yes	Yes

Note When checking TIM and TIMH(15) instructions with the ladder diagram monitor operation while in MONITOR mode, the observed timing might be longer than expected.

SECTION 5

Program Execution Timing

This section describes the internal processing of the CPU, include the program execution cycle, the instruction execution times, and the I/O response times. It also describes the operation of the high-speed inputs.

5-1	Operation in RUN and MONITOR Modes	28
5-2	Scan Time	28
5-3	Instruction Execution Times	29
5-4	I/O Response Time	32
5-4-1	Normal I/O Timing	33
5-4-2	High-speed Inputs	34

5-1 Operation in RUN and MONITOR Modes

In RUN mode, the overseeing processes, program execution, and I/O refresh are repeated cyclically, as shown on the left below.

MONITOR mode processing is identical to RUN mode processing, but Programming Device servicing is performed after program execution, as shown in the flowchart on the right below. The processing time in MONITOR mode is much longer than that in RUN mode, because of the Programming Device servicing.

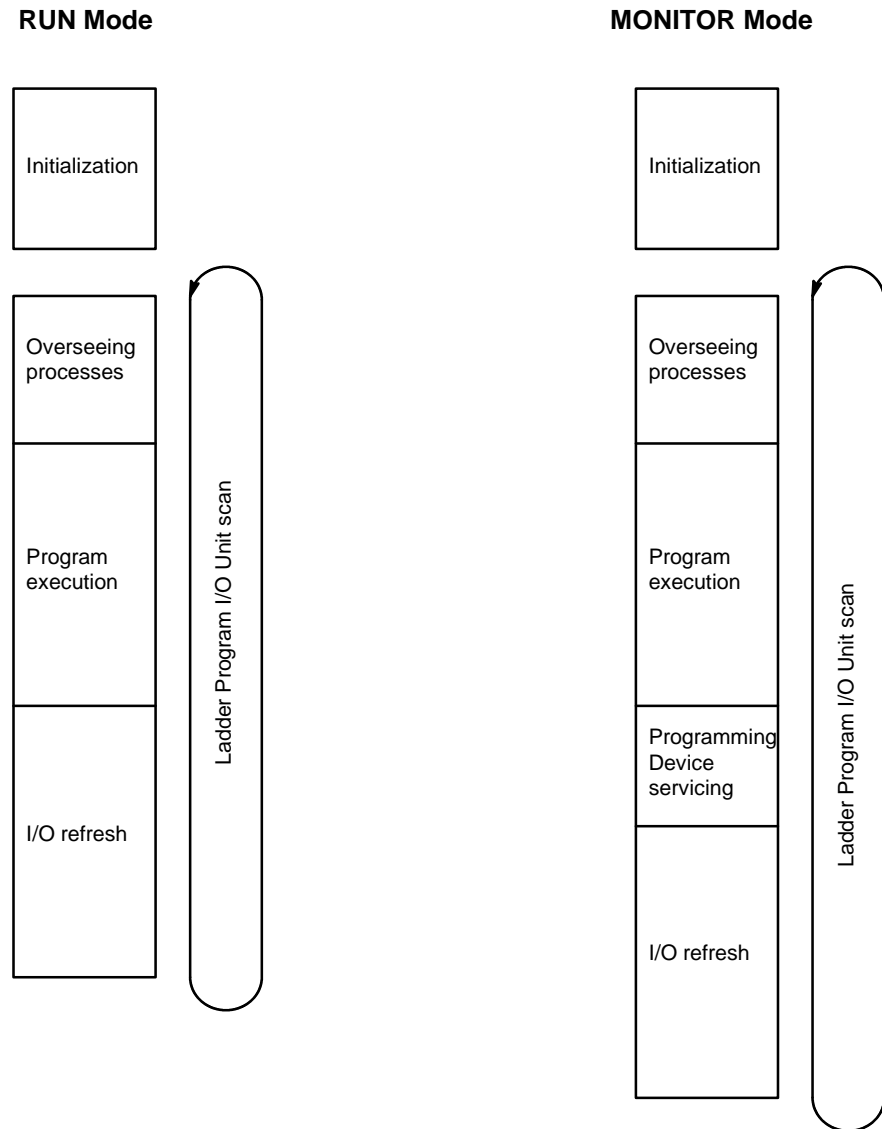

Note In MONITOR mode, data is transferred between the Ladder Program I/O Unit and the Programming Device during Programming Device servicing. The time required for Programming Device servicing varies depending on the processes performed, but the minimum time required is 20 ms.

5-2 Scan Time

It is important to know the scan time of the Unit in order to determine whether or not the program is operating correctly and to determine if I/O processing is timed properly.

The explanation below is for the scan time in RUN mode. The scan time will vary depending on the setting of pin 2 of the back panel DIP switch.

Pin 2 ON (WRIT(87)/READ(88) Operation)

Data is transferred to and from the PC using the I/O WRITE/READ (WRIT(87)/READ(88)) instructions.

Pin 2 OFF (Normal I/O Operation)

Data is transferred to and from the PC through 2 words allocated for I/O.

Process	Content		Time requirements
Overseeing	Watchdog timer set; indicators set, etc.		177 ms
Program execution	Program executed.		Total execution time for all instructions varies with program size, the instructions used, and execution conditions. Refer to <i>Instruction Execution Times</i> for details.
I/O refresh	Pin 2 ON	Pin 2 OFF	Varies with the method of data transfer to/from the PC. Input refresh: 47.50 ms WRIT(87): 1.361 ms Clock read/store: 192.50 ms READ(88): 753.75 ms Output refresh: 35.00 ms
	Input refresh WRIT(87) execution (see Note 2 below) Clock read/store READ(88) execution (see Note 2 below) Output refresh	Input refresh Clock read/store Output refresh	

Scan time = Overseeing time + Program execution time + I/O refresh time

- Note**
- The method of data transfer between the Unit and the PC is determined by the setting of pin 2 of the back panel DIP switch.
The scan time is longer when pin 2 is ON, because of the time required to execute WRIT(87) and READ(88), but these instructions allow a large amount of data to be transferred all at once.
 - When WRIT(87) is executed during the I/O refresh, the data written from the PC is stored in DM 064 through DM 095 in the Unit.
When READ(88) is executed, the data stored in DM 096 through DM 127 in the Unit is transferred to the PC.
 - The processing times given for the execution of WRIT(87) and READ(88) are the times required for the transfer of the maximum 32 words of data.

Long Scan Times

Scan time (ms)	Possible adverse affects
10 or greater	TIMH(15) inaccurate
100 or greater	A watchdog timer error occurs, operation stops, and the Unit is automatically switched to PROGRAM mode.

Note If the scan time exceeds 100 ms, operation of the Unit is stopped and the Unit is automatically switched to PROGRAM mode. It is necessary to recheck the program at this point.

5-3 Instruction Execution Times

This following table lists the execution times for all instructions that are available for the Ladder Program I/O Unit. The maximum and minimum execution times and the conditions which cause them are given where relevant. When "word" is referred to in the Conditions column, it implies the content of PC I/O bits, external I/O bits, or work bits.

Execution times for instructions depend on whether they are executed with an ON or an OFF execution condition. The OFF execution time for an instruction can also vary depending on the circumstances, i.e., whether it is in an interlocked program section and the execution condition for IL is OFF or whether it is reset by an OFF execution condition. “When interlocked” and “When reset” are used to indicate these two times.

Instruction	No. of bytes	Conditions	ON execution time (μs)* Top: Min.; Bottom: Max.	OFF execution time (μs)* Top: Min.; Bottom: Max.	
LD	8	---	6.875	5.625	
LD NOT	8	---	6.875	5.625	
AND	7	---	6.250	5.000	
AND NOT	7	---	6.250	5.000	
OR	7	---	6.250	5.000	
OR NOT	7	---	6.250	5.000	
AND LD	5	---	2.500	3.750	
OR LD	5	---	3.750	2.500	
OUT	14	---	11.250	6.875	
OUT NOT	14	---	6.875	11.250	
TIM	6	Min: Constant for SV Max: Word for SV	126.875	When reset	When interlocked
				112.500	145.000
				148.750	
CNT	6	Min: Constant for SV Max: Word for SV	111.875	When reset	When interlocked
				105.625	60.000
				140.000	
NOP(00)	1	---	0.625	-	
END(01)	6	---	1.875	-	
IL(02)	5	---	2.500	3.750	
ILC(03)	2	---	1.250	1.250	
JMP(04)	3	---	15.625	24.375	
JME(05)	3	Min: JMP(04) is not executed.	12.500	---	
		Max: JMP(04) is executed.	48.750		
SFT(10)	6	Min: With 1-word shift register Max: With 10-word shift register	100.625	When reset	When interlocked
				71.875	13.125
				230.000	145.000
KEEP(11)	17	---	13.750	2.500	
CNTR(12)	6	Min: Constant for SV Max: Word for SV	139.375	When reset	When interlocked
			221.875	105.000	56.875
DIFU(13)	6	---	61.250	With no OFF to ON transition	When interlocked
				69.375	47.500
DIFD(14)	6	---	63.250	With no ON to OFF transition	When interlocked
				71.250	49.375

Instruction	No. of bytes	Conditions	ON execution time (μs)* Top: Min.; Bottom: Max.	OFF execution time (μs)*	
				Top: Min.;	Bottom: Max.
TIMH(15)	6	Min: Constant for SV Max: Word for SV	128.125	When reset	When interlocked
				113.750	146.250
				150.000	
WSFT(16)	10	Min: When shifting 1 word	110.000	When reset	When interlocked
		Max: When shifting 128 words using DM	1.511 ms	29.375	26.875
CMP(20)	10	Min: When comparing a constant to a word	98.750	When reset	When interlocked
		Max: When comparing two TC	195.625	29.375	26.875
MOV(21)	10	Min: When transferring a constant to a word	86.875	When reset	When interlocked
		Max: When transferring TC to DM	148.125	29.375	26.875
MVN(22)	10	Min: When transferring a constant to a word	88.125	When reset	When interlocked
		Max: When transferring TC to DM	149.375	29.375	26.875
BIN(23)	10	Min: When converting a word to a word	116.875	When reset	When interlocked
		Max: When converting TC to DM	136.250	29.375	26.875
BCD(24)	10	Min: When converting a word to a word	110.000	When reset	When interlocked
		Max: When converting TC to DM	149.375	29.375	26.875
ASL(25)	10	Min: When shifting a word	85.625	When reset	When interlocked
		Max: When shifting DM	89.375	29.375	26.875
ASR(26)	10	Min: When shifting a word	85.625	When reset	When interlocked
		Max: When shifting DM	89.375	29.375	26.875
ROL(27)	10	Min: When rotating a word	93.750	When reset	When interlocked
		Max: When rotating DM	97.500	29.375	26.875
ROR(28)	10	Min: When rotating a word	93.750	When reset	When interlocked
		Max: When rotating DM	97.500	29.375	26.875
COM(29)	10	Min: When inverting a word	78.125	When reset	When interlocked
		Max: When inverting DM	81.875	29.375	26.875
ADD(30)	10	Min: Constant + word to word	211.875	When reset	When interlocked
		Max: TC + TC to DM	291.875	29.375	26.875
SUB(31)	10	Min: Constant – word to word	217.500	When reset	When interlocked
		Max: TC – TC to DM	297.500	29.375	26.875
ANDW(34)	10	Min: Constant AND word to word	123.125	When reset	When interlocked
		Max: TC AND TC to DM	231.250	29.375	26.875
ORW(35)	10	Min: Constant OR word to word	123.125	When reset	When interlocked
		Max: TC OR TC to DM	231.250	29.375	26.875
XORW(36)	10	Min: Constant XOR word to word	123.125	When reset	When interlocked
		Max: TC XOR TC to DM	231.250	29.375	26.875
XNRW(37)	10	Min: Constant XNOR word to word	124.375	When reset	When interlocked
		Max: TC XNOR TC to DM	232.500	29.375	26.875

Instruction	No. of bytes	Conditions	ON execution time (μs)* Top: Min.; Bottom: Max.	OFF execution time (μs)*	
				Top: Min.;	Bottom: Max.
INC(38)	10	Min: When incrementing a word	112.500	When reset	When interlocked
		Max: When incrementing DM	116.250	29.375	26.875
DEC(39)	10	Min: When decrementing a word	125.625	When reset	When interlocked
		Max: When decrementing DM	129.375	29.375	26.875
STC(40)	9	----	9.375	5.000	
CLC(41)	9	----	9.375	5.000	
SLD(74)	10	Min: When shifting 1 word	75.000	When reset	When interlocked
		Max: When shifting 128 DM words	5.276 ms	29.375	26.875
SRD(75)	10	Min: When shifting 1 word	73.750	When reset	When interlocked
		Max: When shifting 128 DM words	5.274 ms	29.375	26.875
MLPX(76)	10	Min: When decoding a word to a word	228.125	When reset	When interlocked
		Max: When decoding TC to DM	495.000	29.375	26.875
DMPX(77)	10	Min: When encoding a word to a word	300.625	When reset	When interlocked
		Max: When encoding TC to DM	718.750	29.375	26.875

5-4 I/O Response Time

The Ladder Program I/O Unit reads input signals during the I/O refresh period, and then executes the program. The results from the program execution are then output at the next I/O refresh. The I/O response time thus depends upon the scan time, input ON delay, and output ON delay. Normally, only those high-speed inputs that occur during the I/O refresh are read.

When the high-speed inputs (I/O bits 0200 through 0207) are activated by turning on pins 3 and 4 of the back panel DIP switch, high-speed inputs that occur during the I/O refresh can also be read.

An explanation of normal I/O timing and high-speed input timing follows.

5-4-1 Normal I/O Timing

Minimum I/O Response Time The Unit responds most quickly when it receives an input signal just prior to I/O the refresh.

$$\text{Minimum I/O response time} = \text{input ON delay} + \text{scan time} + \text{output ON delay}$$

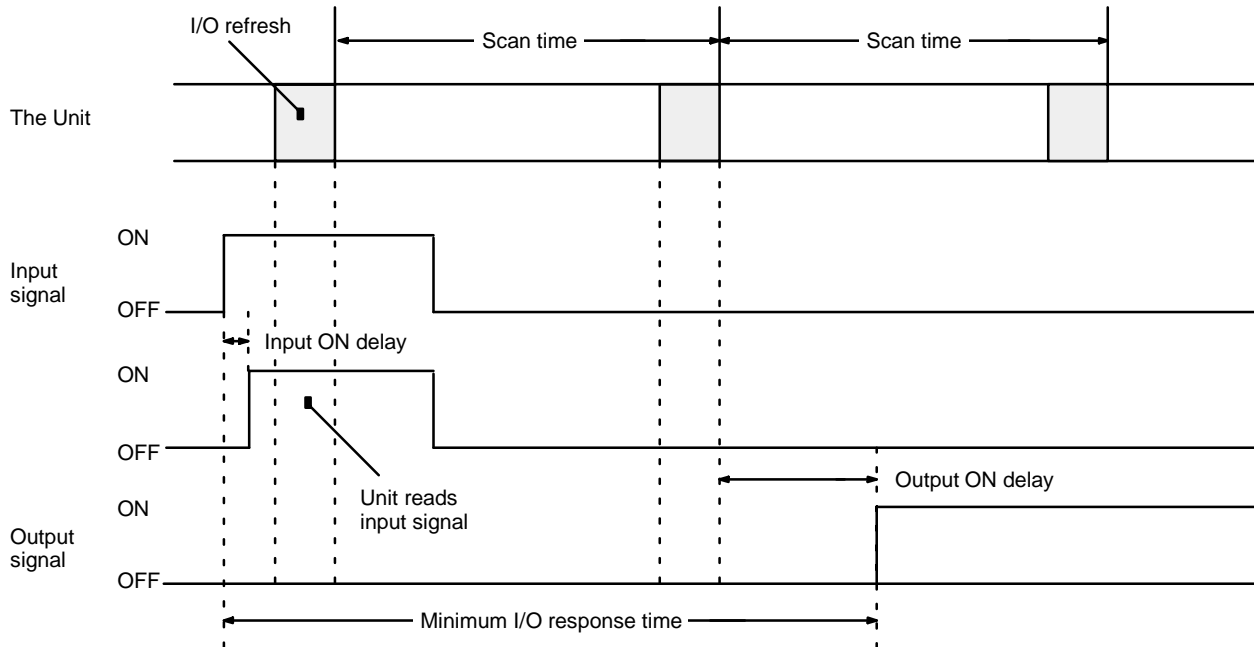

Maximum I/O Response Time The Unit takes the longest to respond when it receives an input signal just after the I/O refresh.

$$\text{Maximum I/O response time} = \text{input ON delay} + (\text{scan time} \times 2) + \text{output ON delay}$$

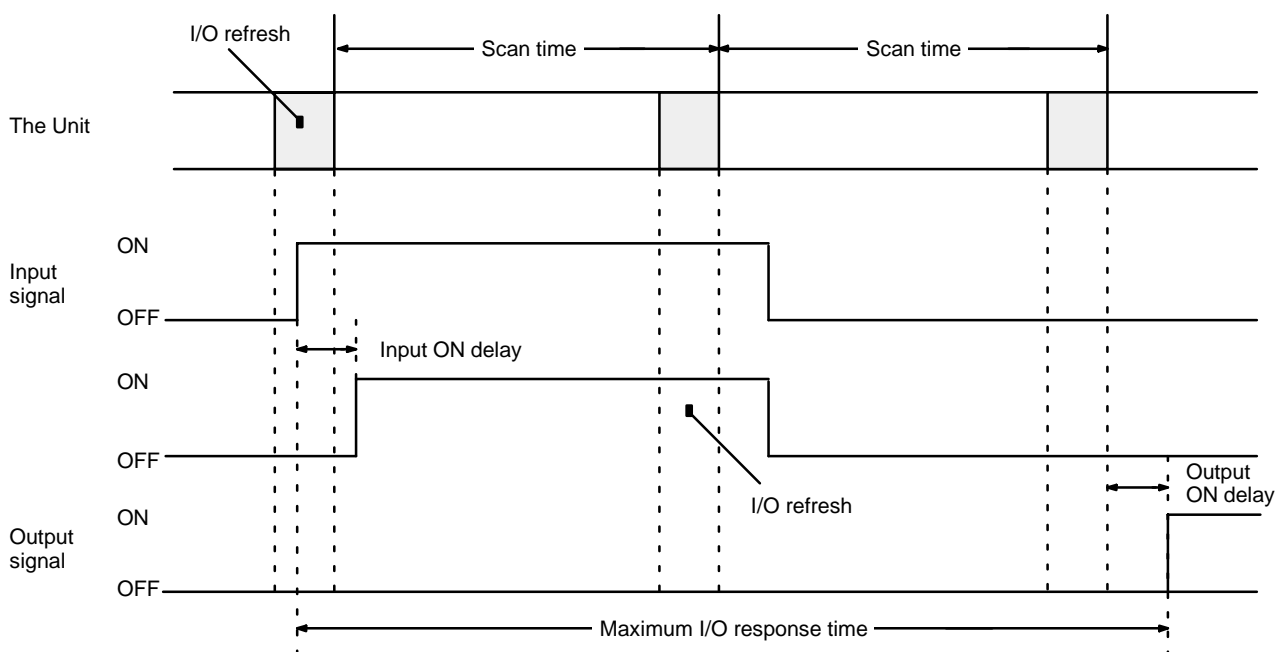

5-4-2 High-speed Inputs

High-speed inputs can be used by turning on pin 3 and/or pin 4 on the back panel DIP switch. Pin 3 enables high-speed inputs on IR 0200 through IR 0203; pin 4 on IR 0204 through IR 0207. When high-speed inputs are enabled, any pulse of 0.5 ms or longer will be acknowledged regardless of when it occurs, as shown below. The numbers in the following diagrams indicate processing as follows:

- 1, 2, 3...**
1. When a pulse is received that is 0.5 ms or longer, the high-speed input buffer is turned ON. The ON status is maintained until the next refresh period regardless of whether or not the input remains ON.
 2. When the next I/O refresh period is reached, the bit status is read from the high-speed input buffer to the input bit.
 3. If the input is OFF during the I/O refresh period, the high-speed input buffer is turned OFF after status has been read. If the input is still ON, the high-speed input buffer remains ON at least until the next I/O refresh period.
 4. Because the high-speed input buffer is reset if the input is OFF after reading status, the input bit is reset during the next I/O refresh period (unless the input has again come ON to activate the high-speed input buffer).

High-speed Inputs Between I/O Refresh Periods

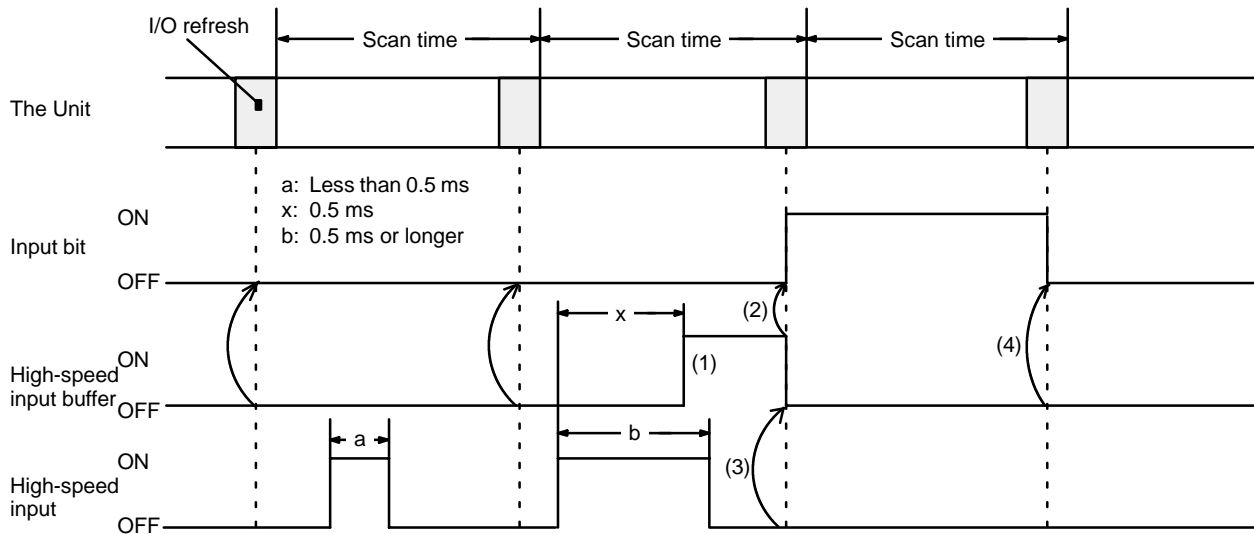

High-speed Input Continuing after I/O Refresh Period

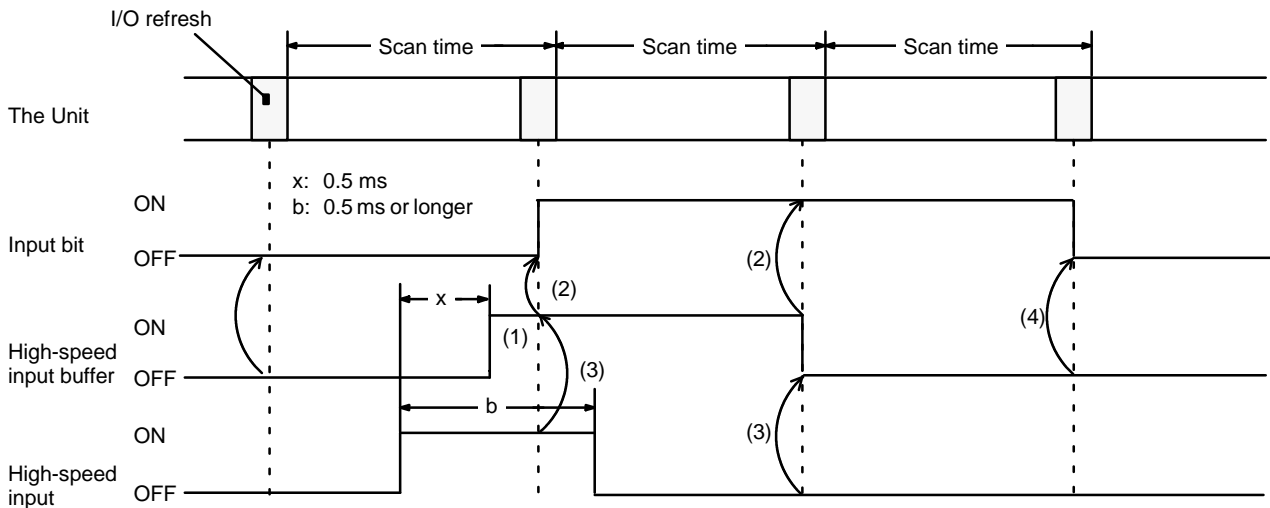

SECTION 6

Maintenance and Troubleshooting

This section provides error messages indicated by Unit indicators and troubleshooting steps. The procedure to replace the fuse inside the Unit is also provided.

6-1	Error Messages and Troubleshooting	36
6-2	Maintenance	37

6-1 Error Messages and Troubleshooting

Error	Possible Cause	Correction
Indicators do not light	PC power is OFF	Apply power to PC
	Unit is not mounted securely	Mount Unit and tighten mounting screws
Indicator 4 lights during PROGRAM or MONITOR when SW 3 is set to 0 (GPC/FIT/LSS connection error)	GPC/FIT/LSS power is OFF	Apply power to the GPC/FIT/LSS
	Cable to GPC/FIT/LSS is disconnected	Reconnect the cable properly and secure with screws
	Broken cable or poor contact to GPC/FIT/LSS	Repair or replace the cable
Indicator 4 lights during RUN or MONITOR mode when SW 3 is set to 0 (operation continues)	JMP(04) and JME(05) are not used in pairs	Rewrite the program to use JMP(04) and JME(05) in pairs
	Clock data read error	Reset clock data in PROGRAM mode

Fatal Errors

If an error occurs that stops the Unit, the indicator indicated in the following table will flash regardless of the setting of SW 3. Possible errors vary depending on which indicator flashes.

Indicator	Error	Possible Cause	Correction
0	Incorrect RAM (verified when power is connected or at reset time)	Failed RAM	Replace Unit
	Incorrect EEPROM write	Unable to write program to Unit	Replace Unit
	Pin 1, 6, 7, or 8 set incorrectly	Pin 1, 6, 7, or 8 set to ON	Turn OFF pins 1, 6, 7, and 8
1	Program error	Program within Unit has been corrupted	Rewrite program. If error persists, replace Unit. Transfer data to the entire user program area. If transmission is interrupted after sending END(01), the write will be invalid; always write completely to end of program memory area.
2	No END instruction	END(01) is missing in program	Insert END(01) and retransfer the program
3	Clock data write error	Incorrect clock data written to DM 60 DM to 63	Write correct clock data
4	Program conversion error	Program contains an instruction which cannot be used in the Unit	Review program
		Program is too long and cannot be written to the Unit	
5	Too many jumps	Program contains 10 or more JMP(04) instructions	Reduce jumps to 9 or less
6	Too many DIFU(13)/DIFD(14)s	Program contains 17 or more DIFU(13)/DIFD(14)s	Reduce DIFU(13)/DIFD(14)s to 16 or less
7	CPU error	Watchdog timer error has occurred	Review and correct program to limit scan time to 100 ms maximum

6-2 Maintenance

Stand-by Unit

It is recommended to keep a stand-by Unit on hand at all times.

Fuse Replacement

The Ladder Program I/O Unit uses two fuses; one for each eight outputs. Replace blown fuses, after eliminating the cause, with fuses of the following specifications:

125 V, 2 A (5.2 mm dia. x 20 mm)

Replace fuses according to the following procedure.

- 1, 2, 3... 1. Disconnect the PC power supply.
2. Remove input and output connectors.
3. Remove the Unit from the Backplane.
4. Remove the 8 cover mounting screws (4 on each side).
5. Remove the cover and circuit boards.
6. Replace the fuses.
7. To re-assemble, reverse the above procedure.

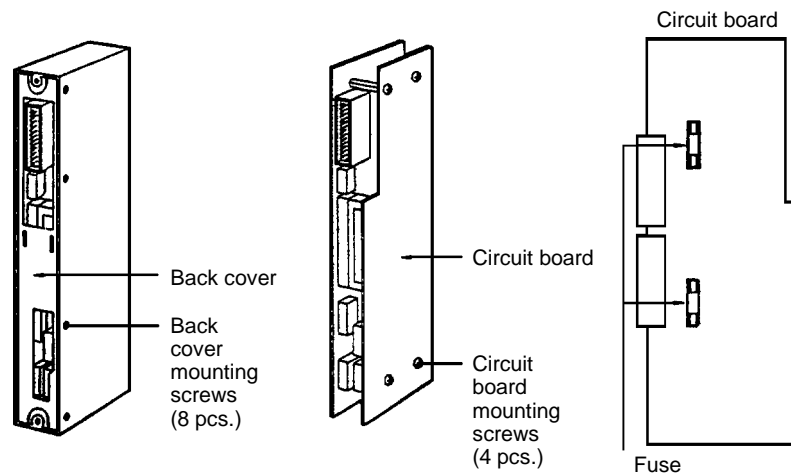

Appendix A Standard Models

Product Name		Model No.
Ladder Program I/O Unit		C500-LDP01-V1
GPC	Main unit	3G2C5-GPC03-E/3G2C5-GPC04-E
	System Memory Cassette	C500-MP303-EV2
FIT		FIT10-SET11-E
LSS	3 1/2" FD 720 KB (4 floppy disks)	C500-SF312-EV2
	5 1/4" FD 360 KB (8 floppy disks)	C500-SF711-EV2

Appendix B Specifications

Item	Specification
Words allocated in the PC	2 words The I/O WRITE and I/O READ (WRIT(87)/READ(88)) instructions can be used when enabled via a switch setting.
Control method	Stored program
Main control element	MPU, C-MOS
Programming	Ladder diagram
Instruction Length	1 to 17 bytes/instruction
Instructions	49 (basic instruction: 12/advanced instruction: 37)
Processing time	Typically 7 ms/step
Program memory	EEPROM 4 Kbytes
Program length	Approximately 524 addresses (variable depending on instructions used)
I/O bits	64 16 PC output bits (0000 to 0015) 16 PC input bits (0100 to 0115) 16 external input bits (0200 to 0215) 16 external output bits (0300 to 0315) External I/O bits 0200 to 0207 can be set as high-speed inputs in 2 groups of 4 each.
Work bits	136 total (0400 to 1207)
Timers/counters	16 total Timer: 0 to 999.9 s, accuracy $+0/-0.1$ s TC 00 to TC 15 Counter: 0 to 9999 counts
TR bits	8 total (TR 0 to TR 7)
SR flags and bits	16 total (1208 to 1307)
Data memory	128 words (DM 000 through DM 127) DM 060 through DM 063 are allocated for clock data. DM 064 through DM 127 are dedicated to the I/O WRITE/READ (WRIT(87)/READ(88)) instructions when they are enabled.
Power failure back-up functions	When power fails, the I/O bits, work bits, timers, counters, and the DM area will be cleared. The clock is backed up by a capacitor for approximately 10 days. Clock data is stored in the DM area from DM 60 to DM 63 when power is supplied.
Block transfer capacity (via WRIT(87)/READ(88))	Read/write area: 32 words This function can be enabled or disabled with a switch setting.
Diagnostic functions	CPU error (watchdog timer) Memory error, etc. Program Check No END instruction JMP-JME error Too many DIFU/DIFD
Internal current consumption	Maximum 800 mA 5 VDC
Weight	Maximum 600 g
External dimensions (mm)	34.5 x 250 x 93 mm (WxHxD)

External Input/Output Specifications

DC inputs

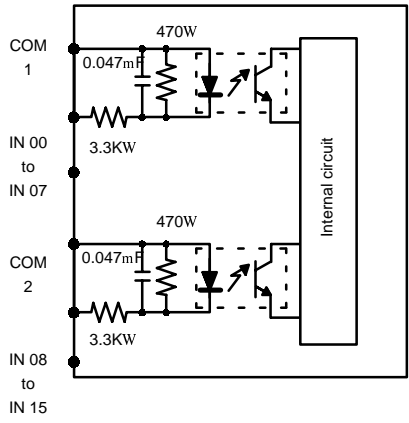
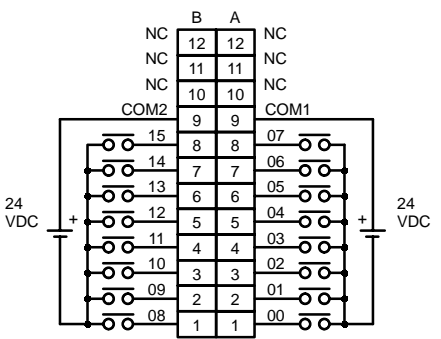
Item	Specification
Input voltage	24 VDC +10%/-15%
Input impedance	3.3 kW
Input current	7 mA typical (at 24 VDC)
ON voltage	Minimum 16.0 VDC
OFF voltage	Maximum 5.0 VDC
ON response time	Maximum 0.5 ms
OFF response time	Maximum 0.5 ms
Number of circuits	16 points (8/common, 2 circuits)
High-speed input	8 (input bits 0200 to 0207 when pins 3 and 4 of the DIP switch are set to ON) 0.5 ms minimum pulse width
Circuit configuration	
Wiring diagram	

Transistor Output

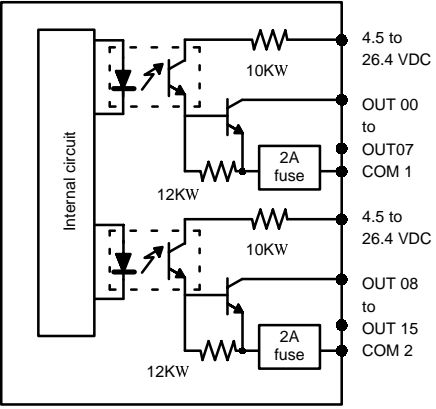
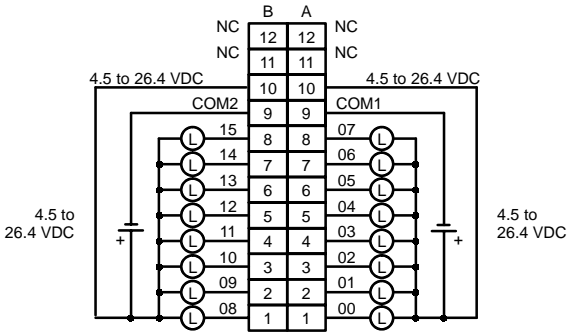
Item	Specification
Maximum switching capacity	16 mA/4.5 VDC to 100 mA/26.4 VDC
Current leakage	Maximum 0.1 mA
Residual voltage	Maximum 0.4 V
ON response time	Maximum 0.2 ms
OFF response time	Maximum 0.3 ms
Number of circuits	16 points (8/common, 2 circuits)
Fuse	2 A, 125 V (5.2 mm (dia.) x 20 mm) GG92
External power supply	4.5 to 26.4 VDC, minimum 50 mA
Circuit configuration	
Wiring diagram	

Maximum Switching Capacity of Transistor Outputs

The maximum switching capacity of transistor outputs, relative to the voltage of external output power supply, is shown below.

Special characteristics between maximum switching capacity and power supply voltage

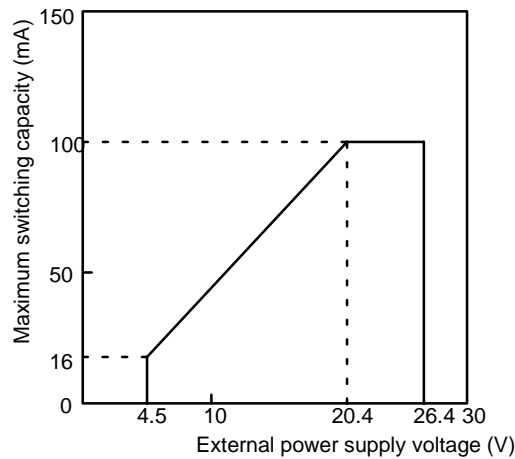

I/O Connectors

During assembly, connect external inputs and outputs using the connectors included.

Although I/O connectors are identical in shape, the connections differ. Be certain to follow the labels when connecting.

Connectors on the Unit (Fujitsu)
FCN-365P024-AU

- (1) FCN-361J024-AU (soldered) } 2 pieces
- FCN-360C024-B (connected cover) }
- (2) FCN-363J024 (solderless housing) } 2 sets each
- FCN-363J-AU (contact) }
- FCN-360C024-B (Connector cover) }
- (3) FCN-367J024-AU/F (pressure welded) 2 pieces

OMRON Connectors (OMRON supplies each as a set)

C500-CE241 (soldered)

C500-CE242 (solderless crimp type)

C500-CE243 (pressure-welded)

Appendix C

Programming Instructions

A PC instruction is input either by inputting the corresponding Programming Device key(s) (e.g., LD, AND, OR, NOT) or by using function codes. To input an instruction via its function code, press FUN, the function code, and then WRITE.

Function Code	Name	Mnemonic	No. of bytes
--	AND	AND	7
--	AND LOAD	AND LD	5
--	AND NOT	AND NOT	7
--	COUNTER	CNT	6
--	LOAD	LD	8
--	LOAD NOT	LD NOT	8
--	OR	OR	7
--	OR NOT	OR NOT	7
--	OR LOAD	OR LD	5
--	OUTPUT	OUT	14
--	OUTPUT NOT	OUT NOT	14
--	TIMER	TIM	6
00	NO OPERATION	NOP	1
01	END	END	6
02	INTERLOCK	IL	5
03	INTERLOCK CLEAR	ILC	2
04	JUMP	JMP	3
05	JUMP END	JME	3
10	SHIFT REGISTER	SFT	6
11	KEEP	KEEP	17
12	REVERSIBLE COUNTER	CNTR	6
13	DIFFERENTIATE UP	DIFU	6
14	DIFFERENTIATE DOWN	DIFD	6
15	HIGH-SPEED TIMER	TIMH	6
16	WORD SHIFT	WSFT	10
20	COMPARE	CMP	10
21	MOVE	MOV	10
22	MOVE NOT	MVN	10
23	BCD-TO-BINARY	BIN	10
24	BINARY-TO-BCD	BCD	10
25	ARITHMETIC SHIFT LEFT	ASL	10
26	ARITHMETIC SHIFT RIGHT	ASR	10
27	ROTATE LEFT	ROL	10
28	ROTATE RIGHT	ROR	10
29	COMPLEMENT	COM	10
30	BCD ADD	ADD	10
31	BCD SUBTRACT	SUB	10
34	AND WORD	ANDW	10

Function Code	Name	Mnemonic	No. of bytes
35	OR WORD	ORW	10
36	EXCLUSIVE OR	XORW	10
37	EXCLUSIVE NOR	XNRW	10
38	INCREMENT	INC	10
39	DECREMENT	DEC	10
40	SET CARRY	STC	9
41	CLEAR CARRY	CLC	9
74	ONE DIGIT SHIFT LEFT	SLD	10
75	ONE DIGIT SHIFT RIGHT	SRD	10
76	4-TO-16 DECODER	MLPX	10
77	16-TO-4 ENCODER	DMPX	10

Applicable Data Areas

The following table shows the addresses that can be used in each data area when programming. These are listed in the instruction tables by area. Any word/bit in the applicable areas can be designated as long as the end of the area is not exceeded, i.e., if two words are required for an operand, the last word in an area cannot be designated. In this respect, the IR, work bit, and SR area are considered as one consecutive area. Refer to the *C500 Operation Manual* for details. Indirect addressing is not possible for the Ladder Program I/O Unit.

Prefix	Item	Word address	Bit address
None (indicated with IR prefix)	PC output bits	IR 00	IR 0000 to IR 0015
	PC input bits	IR 01	IR 0100 to IR 0115
	External input bits	IR 02	IR 0200 to IR 0215
	External output bits	IR 03	IR 0300 to IR 0315
None	Work bits	04 to 12	0400 to 1207
None (indicated with SR prefix)	SR bits	12 to 13	SR 1208 to SR 1307
TR	Temporary bits	---	TR 0 to TR 7
TIM/CNT (indicated as TC)	Timer/counter numbers	TC 00 to TC 15 (PV)	TC 00 to TC 15 (defining or Completion Flag)
DM	Data memory	DM 000 to DM 127	---
#	Constants	#0000 to 9999 #0000 to FFFF	---

Note Data transferred by WRIT(87) and READ(88) instructions is stored in DM 064 through DM 127 when pin 2 of the back panel DIP switch is turned ON. If data will be transferred by the WRIT(87) and READ(88) instructions, DM 064 through DM 095 should be treated as read-only in the program. Refer to *3-6 DM Area* for details on the use of DM 060 through DM 127.

Instruction Tables

The following tables list all of the ladder diagram programming instructions for the Ladder Program I/O Unit. These are all the same as corresponding instructions for the C500, except that data areas differ and not all C500 instructions are supported (see table at the end of this appendix). Refer to the *C500 Operation Manual* for details.

Basic Instructions

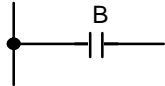
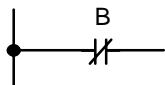
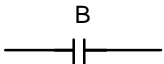
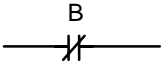
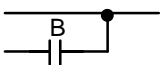
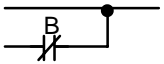
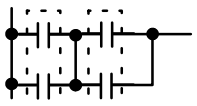
Name and Mnemonic	Symbol	Function	Operand Data Areas
LOAD LD		Defines the status of bit B as the execution condition for subsequent operations in the instruction line.	B: IR SR Work bits TC TR
LOAD NOT LD NOT		Defines the status of the inverse of bit B as the execution condition for subsequent operations in the instruction line.	B: IR SR Work bits TC
AND AND		Logically ANDs the status of the designated bit with the current execution condition.	B: IR SR Work bits TC
AND NOT AND NOT		Logically ANDs the inverse of the designated bit with the current execution condition.	B: IR SR Work bits TC
OR OR		Logically ORs the status of the designated bit with the current execution condition.	B: IR SR Work bits TC
OR NOT OR NOT		Logically ORs the inverse of the designated bit with the execution condition.	B: IR SR Work bits TC
AND LOAD AND LD		Logically ANDs the resultant execution conditions of the preceding logic blocks.	None

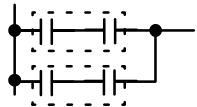
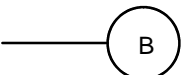
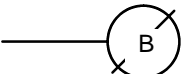
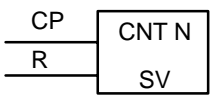
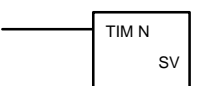

Name and Mnemonic	Symbol	Function	Operand Data Areas
OR LOAD OR LD		Logically ORs the resultant execution conditions of the preceding logic blocks.	None
OUTPUT OUT		Turns ON B for an ON execution condition; turns OFF B for an OFF execution condition.	B: IR (except IR 00 and IR 02) Work bits TR
OUTPUT NOT OUT NOT		Turns OFF B for an ON execution condition; turns ON B for an OFF execution condition.	B: IR (except IR 00 and IR 02) Work bits
COUNTER CNT		A decrementing counter. SV: 0 to 9999; CP: count pulse; R: reset input. The TC bit is entered as a constant.	N: TC SV: IR SR Work bits #
TIMER TIM		ON-delay (decrementing) timer operation. Set value: 000.0 to 999.9 s. The same TC bit cannot be assigned to more than one timer/counter. The TC bit is entered as a constant.	N: TC SV: IR SR Work bits #

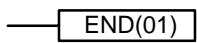
Special Instructions

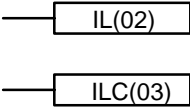
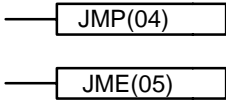
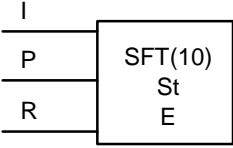
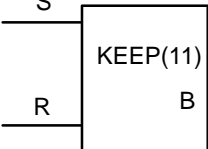
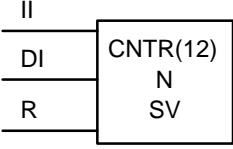
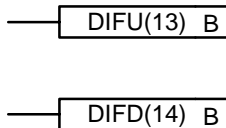
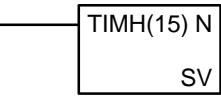
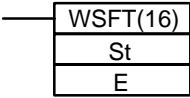
Name Mnemonic	Symbol	Function	Operand Data Areas
NO OPERATION NOP(00)	None	Nothing is executed and program operation moves to the next instruction.	None
END END(01)		Required at the end of each program. Instructions located after END(01) will not be executed.	None

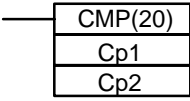
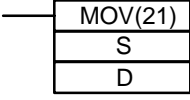
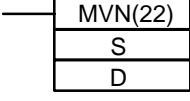
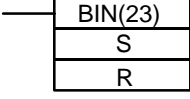
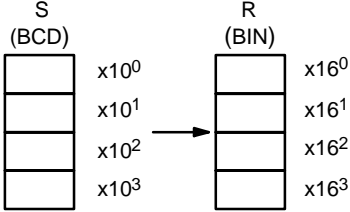
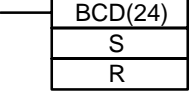
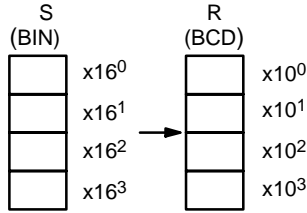
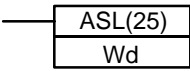
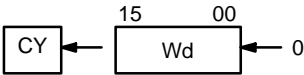
Name Mnemonic	Symbol	Function	Operand Data Areas
INTERLOCK IL(02) INTERLOCK CLEAR ILC(03)		If an interlock condition is OFF, all outputs and all timer PVs between the current IL(02) and the next ILC(03) are turned OFF or reset, respectively. Other instructions are treated as NOP. Counter PVs are maintained. If the execution condition is ON, execution continues normally.	None
JUMP JMP(04) JUMP END JME(05)		When the execution condition for the JMP(04) instruction is ON, all instructions between JMP(04) and the next JME(05) are ignored or treated as NOP(00)	None
SHIFT REGISTER SFT(10)		Creates a bit shift register for data from the starting word (St) through to the ending word (E). I: input bit; P: shift pulse; R: reset input. St must be less than or equal to E. St and E must be in the same data area.	St/E: IR (except IR00 and IR02) Work bits (except word 12)
KEEP KEEP(11)		Defines a bit (B) as a latch, controlled by the set (S) and reset (R) inputs.	B: IR (except IR00 and IR02) Work bits
REVERSIBLE COUNTER CNTR (12)		Increases or decreases the PV by one whenever the increment input (II) or decrement input (DI) signals, respectively, go from OFF to ON. SV: 0 to 9999; R: reset input. Each TC bit can be used for one timer/counter only. The TC bit is entered as a constant.	N: TC SV: IR SR Work bits #
DIFFERENTIATE UP DIFU(13) DIFFERENTIATE DOWN DIFD(14)		DIFU(13) turns ON the designated bit (B) for one scan on reception of the leading (rising) edge of the input signal; DIFD(14) turns ON the bit for one scan on reception of the trailing (falling) edge. A maximum of 16 DIFFERENTIATE UP/DOWN instructions can be used	B: IR (except IR00 and IR02) Work bits
HIGH-SPEED TIMER TIMH(15)		A high-speed, ON-delay (decrementing) timer. SV: 00.02 to 99.99 s. Each TC bit can be assigned to only one timer or counter. The TC bit is entered as a constant.	N: TC SV: IR SR Work bits #
WORD SHIFT WSFT(16)		The data in the words from the starting word (St) through to the ending word (E), is shifted left in word units, writing all zeros into the starting word. St must be less than or equal to E, and St and E must be in the same data area.	St/E: IR Work bits (except word 12)

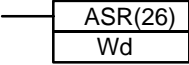
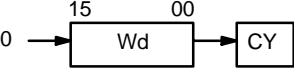
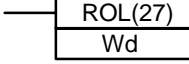
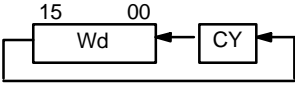
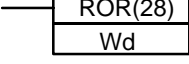
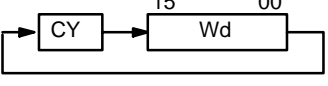
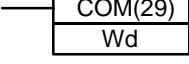
Name Mnemonic	Symbol	Function	Operand Data Areas	
COMPARE CMP(20)		Compares the data in two 4-digit hexadecimal words (Cp1 and Cp2) and outputs result to the GR, EQ, or LE Flags.	Cp1/Cp2: IR SR Work bits TC DM #	
MOVE MOV(21)		Transfers data from source word, (S) to destination word (D).	S: IR SR Work bits TC DM #	D: IR Work bits (except word 12) DM
MOVE NOT MVN(22)		Transfers the inverse of the data in the source word (S) to destination word (D).	S: IR SR Work bits TC DM #	D: IR Work bits (except word 12) DM
BCD TO BINARY BIN(23)		Converts 4-digit, BCD data in source word (S) into 16-bit binary data, and outputs converted data to result word (R). 	S: IR SR Work bits TC DM	R: IR Work bits (except word 12) DM
BINARY TO BCD BCD(24)		Converts binary data in source word (S) into BCD, and outputs converted data to result word (R). 	S: IR SR Work bits DM	R: IR Work bits (except word 12) DM
ARITHMETIC SHIFT LEFT ASL(25)		Each bit within a single word of data (Wd) is shifted one bit to the left, with zero written to bit 00 and bit 15 moving to CY. 	Wd: IR Work bits (except word 12) DM	

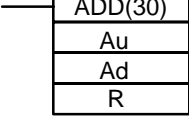
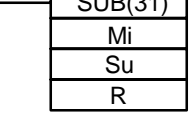
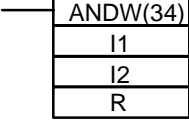
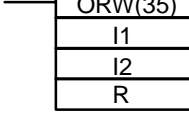
Name Mnemonic	Symbol	Function	Operand Data Areas
ARITHMETIC SHIFT RIGHT ASR(26)		Each bit within a single word of data (Wd) is shifted one bit to the right, with zero written to bit 15 and bit 00 moving to CY. 	Wd: IR Work bits (except word 12) DM
ROTATE LEFT ROL(27)		Each bit within a single word of data (Wd) is moved one bit to the left, with bit 15 moving to carry (CY), and CY moving to bit 00. 	Wd: IR Work bits (except word 12) DM
ROTATE RIGHT ROR(28)		Each bit within a single word of data (Wd) is moved one bit to the right, with bit 00 moving to carry (CY), and CY moving to bit 15. 	Wd: IR Work bits (except word 12) DM
COMPLEMENT COM(29)		Inverts bit status of one word (Wd) of data, changing 0s to 1s, and vice versa. 	Wd: IR Work bits (except word 12) DM
BCD ADD ADD(30)		Adds two 4-digit BCD values (Au and Ad) and content of CY, and outputs the result to the specified result word (R). $Au + Ad + \boxed{CY} \rightarrow R \quad \boxed{CY}$	Au/Ad: IR SR Work bits TC DM # R: IR Work bits (except word 12) DM
BCD SUBTRACT SUB(31)		Subtracts both the 4-digit BCD subtrahend (Su) and content of CY, from the 4-digit BCD minuend (Mi) and outputs the result to the specified result word (R). $Mi - Su - \boxed{CY} \rightarrow R \quad \boxed{CY}$	Mi/Su: IR SR Work bits TC DM # R: IR Work bits (except word 12) DM
AND WORD ANDW(34)		Logically ANDs two 16-bit input words (I1 and I2) and sets the bits in the result word (R) if the corresponding bits in the input words are both ON.	I1/I2: IR SR Work bits TC DM # R: IR Work bits (except word 12) DM
OR WORD ORW(35)		Logically ORs two 16-bit input words (I1 and I2) and sets the bits in the result word (R) when one or both of the corresponding bits in the input words is/are ON.	I1/I2: IR SR Work bits TC DM # R: IR Work bits (except word 12) DM

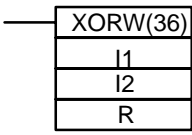
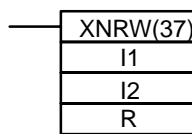
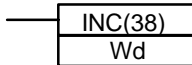
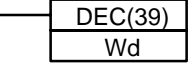
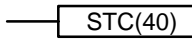
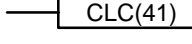
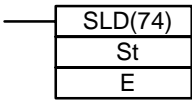
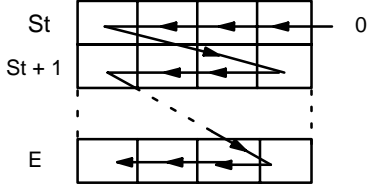
Name Mnemonic	Symbol	Function	Operand Data Areas
EXCLUSIVE OR XORW(36)		Exclusively ORs two 16-bit input words (I1 and I2) and sets the bits in the result word (R) when the corresponding bits in input words differ in status.	I1/I2: IR SR Work bits TC DM # R: IR Work bits (except word 12) DM
EXCLUSIVE NOR XNRW(37)		Exclusively NORs two 16-bit input words (I1 and I2) and sets the bits in the result word (R) when the corresponding bits in both input words have the same status.	I1/I2: IR SR Work bits TC DM # R: IR Work bits (except word 12) DM
INCREMENT INC(38)		Increments the value of a 4-digit BCD word (Wd) by one, without affecting carry (CY).	Wd: IR Work bits (except word 12) DM
DECREMENT DEC(39)		Decrements the value of a 4-digit BCD word by 1, without affecting carry (CY).	Wd: IR Work bits (except word 12) DM
SET CARRY STC(40)		Sets the Carry Flag (i.e., turns CY ON).	None
CLEAR CARRY CLC(41)		Clears the Carry Flag (i.e, turns CY OFF).	None
ONE DIGIT SHIFT LEFT SLD(74)		Shifts all data, between the starting word (St) and ending word (E), one digit (four bits) to the left, writing zero into the rightmost digit of the starting word. St and E must be in the same data area. 	St/E: IR Work bits (except word 12) DM

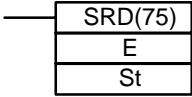
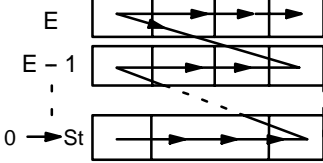
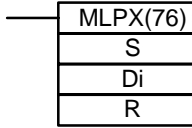
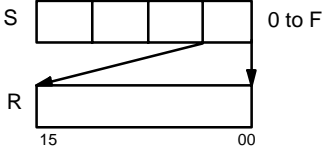
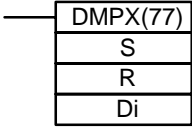
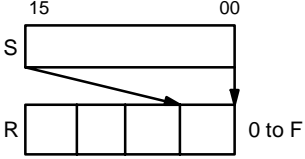
Name Mnemonic	Symbol	Function	Operand Data Areas
ONE DIGIT SHIFT RIGHT SRD(75)		<p>Shifts all data, between starting word (St) and ending word (E), one digit (four bits) to the right, writing zero into the leftmost digit of the ending word. St and E must be in the same data area.</p> 	St/E: IR Work bits (except word 12) DM
4-TO-16 DECODER MLPX(76)		<p>Converts up to four hexadecimal digits in the source word (S), into decimal values from 0 to 15, and turns ON the corresponding bit(s) in the result word(s) (R). There is one result word for each converted digit. Digits to be converted are designated by Di. (The rightmost digit specifies the first digit. The next digit to the left gives the number of digits to be converted minus 1. The two leftmost digits are not used.)</p> 	S: IR SR Work bits TC DM Di: IR Work bits (except word 12) TC DM # R: IR Work bits (except word 12) TC DM
16-TO-4 ENCODER DMPX(77)		<p>Determines the position of the leftmost ON bit in the source word(s) (starting word: S) and turns ON the corresponding bit(s) in the specified digit of the result word (R). One digit is used for each source word. Digits to receive the converted values are designated by Di. (The rightmost digit specifies the first digit. The next digit to left gives the number of words to be converted minus 1. The two leftmost digits are not used.)</p> 	S: IR SR Work bits TC DM R: IR Work bits (except word 12) DM Di: IR Work bits (except word 12) TC DM #

Unsupported Instructions

The following C500 instructions are not supported by the Ladder Programming I/O Unit and will be treated as NOP if used. WRIT(87) and READ(88) are used internally only and cannot be programmed by the user in the Ladder Program I/O Unit.

Name	Mnemonic
FAILURE ALARM	FAL(06)
SEVERE FAILURE ALARM	FALS(07)
BCD MULTIPLY	MUL(32)
BCD DIVIDE	DIV(33)
BLOCK TRANSFER	XFER(70)
BLOCK SET	BSET(71)
SQUARE ROOT	ROOT(72)
DATA EXCHANGE	XCHG(73)
7-SEGMENT DECODER	SDEC(78)
FLOATING POINT DIVIDE	FDIV(79)
SINGLE WORD DISTRIBUTE	DIST(80)
DATA COLLECT	COLL(81)
MOVE BIT	MOVB(82)
MOVE DIGIT	MOVD(83)
REVERSIBLE SHIFT REGISTER	SFTR(84)
TABLE COMPARE	TCMP(85)
I/O WRITE	WRIT(87)
I/O READ	READ(88)
NETWORK SEND	SEND(90)
SUBROUTINE START	SBN(92)
WATCHDOG TIMER REFRESH	WDT(94)
I/O REFRESH	IORF(97)
NETWORK RECEIVE	RECV(98)

Appendix D

Error and Arithmetic Flag Operation

The following table shows the instructions that affect the Error (ER), Carry (CY), Greater Than (GT), Equals (EQ), and Less Than (LT) Flags. Vertical arrows in the table indicate the flags that are turned ON and OFF according to the result of the instruction. Instructions not shown do not affect any of the flags in the table.

In general, ER indicates that operand data is not within requirements. CY indicates arithmetic or data shift results. GT indicates that a compared value is larger than some standard, LT that it is smaller, and EQ, that it is the same. The status of these flags is maintained until another instruction that affects the flag is executed.

Although ladder diagram instructions, TIM, TIMH(15), CNT, and CNTR(12) are executed when ER is ON, other instructions with a vertical arrow under the ER column are not executed if ER is ON. All of the other flags in the following table will also not operate when ER is ON.

The status of these flags cannot be monitored from the Programming Device, because the flags are turned OFF when the END(01) instruction is executed.

Instructions	1303 (ER)	1304 (CY)	1305 (GR)	1306 (EQ)	1307 (LE)
TIM	↕	Unaffected	Unaffected	Unaffected	Unaffected
CNT					
END(01)	OFF	OFF	OFF	OFF	OFF
CNTR(12)	↕	Unaffected	Unaffected	Unaffected	Unaffected
TIMH(15)					
CMP(20)	Unaffected	Unaffected	↕	↕	↕
MOV(21)	Unaffected	Unaffected	Unaffected	↕	Unaffected
MVN(22)					
BIN(23)	↕	Unaffected	Unaffected	↕	Unaffected
BCD(24)					
ASL(25)	Unaffected	↕	Unaffected	↕	Unaffected
ASR(26)					
ROL(27)					
ROR(28)					
COM(29)	Unaffected	Unaffected	Unaffected	↕	Unaffected
ADD(30)	↕	↕	Unaffected	↕	Unaffected
SUB(31)					
ANDW(34)	Unaffected	Unaffected	Unaffected	↕	Unaffected
ORW(35)					
XORW(36)					
XNRW(37)					
INC(38)	↕	Unaffected	Unaffected	↕	Unaffected
DEC(39)					
STC(40)	Unaffected	ON	Unaffected	Unaffected	Unaffected
CLC(41)	Unaffected	OFF	Unaffected	Unaffected	Unaffected
SLD(74)	↕	Unaffected	Unaffected	Unaffected	Unaffected
SRD(75)					
MLPX(76)					
DMPX(77)					

Index

C

clock data, DM area, 18
configuration, example, 2
connectors
 GPC/FIT/LSS, 4
 installation, 44
counters. *See* data areas

D

data areas
 DM, 18—19
 IR, 14
 special relay area
 arithmetic flags, operation, 55
 error flag, operation, 55
 SR area, 18
 TC, 18
 TR bits, 18
 work bits, 17
data transfer, DIP switch setting, 11
DIP switch
 I/O operation settings, 15
 settings, 6, 11
DM area. *See* data areas

E

errors
 long scan time, 29
 troubleshooting, 36

F

features, 2
 comparison with C500-LDP01, 3
FIT, 23
fuse, 37

G

GPC, 23

H

high-speed inputs, 34
high-speed input, DIP switch setting, 11

I

I/O
 normal operation, 15
 operation via WRIT(87)/READ(88), 16
I/O refresh, 28
I/O refresh period, 32
I/O response time, 32
independent operation, 23
indicators
 error messages, 36
 selecting operation, 7—10
input OFF delay, I/O response time, 33
input ON delay, I/O response time, 33
installation, connectors, 44
instruction set
 READ(88), I/O operation, 16
 relation with C500, 2
 WRIT(87), I/O operation, 16
instructions, execution times, 29
IR area. *See* data areas

L

linked operation, 22
 DIP switch setting, 11
LSS, 23

M

maintenance, 37
memory capacity, 22
modes, changing selectors, 6
MONITOR mode, 22

N

nomenclature, 4

O

online operations. *See* Programming Devices
operating modes, 22, 28
 changing, 22
 independent operation, 23
 linked operation, 22
operation, CPU processing, 28
outputs, external, switching capacity, 44

P

program addresses, 22
program capacity, 22
PROGRAM mode, 22
Programming Devices, 23
 online operation, precautions, 26
 online operations
 FIT/LSS, 25
 GPC, 24
 servicing, 28

R

reset switch, 6
RS-485. *See* connectors

RUN mode, 22

S

scan, 28
scan time, 28
 errors, 29
 I/O response time, 33
 instruction execution times, 29
selectors, setting, 6
specification, external I/O, 42
specifications, 41
SR area. *See* data areas

T

TC area. *See* data areas
timers. *See* data areas
TR bits. *See* data areas

W

work bits. *See* data areas
WRIT(87)/READ(88)
 See also instruction set
 effect on scan time, 29

Revision History

A manual revision code appears as a suffix to the catalog number on the front cover of the manual.

Cat. No. W151-E1-3

↑
Revision code

The following table outlines the changes made to the manual during each revision. Page numbers refer to the previous version.

Revision code	Date	Revised content
1	February 1989	Original production (C500-LDP01)
2	June 1989	Corrections to pages 18, 22 to 26
3	January 1992	Revision for new model (C500-LDP01-V1). For a list of the differences between the C500-LDP01 and the C500-LDP01-V1 refer to <i>Section 1-3 Comparing the C500-LDP01 and the C500-LDP01-V1</i> .