

EtherNet/IP™ Safety I/O Terminal

GI-S series

Safety I/O Terminal

User's Manual

GI-S□□□□□□



Safety I/O Terminal



NOTE

- (1) All rights reserved. No part of this publication may be reproduced, stored in a retrieval system, or transmitted, in any form, or by any means, mechanical, electronic, photocopying, recording, or otherwise, without the prior written permission of OMRON.
- (2) No patent liability is assumed with respect to the use of the information contained herein. Moreover, because OMRON is constantly striving to improve its high-quality products, the information contained in this manual is subject to change without notice.
- (3) Every precaution has been taken in the preparation of this manual. Nevertheless, OMRON assumes no responsibility for errors or omissions. Neither is any liability assumed for damages resulting from the use of the information contained in this publication.

Trademarks

- Sysmac and SYSMAC are trademarks or registered trademarks of OMRON Corporation in Japan and other countries for OMRON factory automation products.
- Microsoft, Windows, Excel, and Visual Basic are either registered trademarks or trademarks of Microsoft Corporation in the United States and other countries.
- EtherCAT® is registered trademark and patented technology, licensed by Beckhoff Automation GmbH, Germany.
- Safety over EtherCAT® is a registered trademark and a patented technology licensed by Beckhoff Automation GmbH, Germany.
- ODVA, CIP, CompoNet, DeviceNet, EtherNet/IP, and CIP Safety are trademarks of ODVA.
- The SD and SDHC logos are trademarks of SD-3C, LLC.  

Other company names and product names in this document are the trademarks or registered trademarks of their respective companies.

Copyrights

- Microsoft product screen shots reprinted with permission from Microsoft Corporation.
- This product incorporates certain third party software. The license and copyright information associated with this software is available at http://www.fa.omron.co.jp/nj_info_e/.

Introduction

Thank you for purchasing a GI-S-series safety I/O terminal.

This manual contains information that is necessary to use the GI-S-series safety I/O terminal.

Please read this manual and make sure you understand the functionality and performance of the Unit before you attempt to use it in a control system.

Keep this manual in a safe place where it will be available for reference during operation.

Intended Audience

This manual is intended for the following personnel, who must also have knowledge of electrical systems (an electrical engineer or the equivalent).

- Personnel in charge of introducing FA systems.
- Personnel in charge of designing FA systems.
- Personnel in charge of installing and maintaining FA systems.
- Personnel in charge of managing FA systems and facilities.
- Personnel with the qualifications, authority, and responsibility for providing safety at each phase of the lifecycle of the machine: design, installation, operation, maintenance, and disposal.
- Personnel with a knowledge of functional safety.

For programming, this manual is intended for personnel who understand the programming language specifications in international standard IEC 61131-3 or Japanese standard JIS B 3503.

Applicable Products

This manual covers the following products.

- GI-S-Series Safety I/O Terminal
 - GI-SMD1624
 - GI-SID1224

CONTENTS

Introduction	1
Intended Audience.....	1
Applicable Products	1
CONTENTS.....	2
Relevant Manuals	6
Manual Structure	7
Page Structure.....	7
Special Information	8
Precaution on Terminology	8
Terms and Conditions Agreement	9
Warranties	9
Limitation on Liability; Etc	9
Suitability of Use	10
Programmable Products	10
Performance Data.....	10
Change in Specifications	10
Errors and Omissions	10
Terms and Conditions Agreement (Software)	11
WARRANTY	11
LIMITATION OF LIABILITY.....	11
APPLICABLE CONDITIONS	11
CHANGE IN SPECIFICATION	11
ERRORS AND OMISSIONS	11
Safety Precautions	12
Definition of Precautionary Information.....	12
Symbols.....	12
Alert Statements	13
Precautions for Safe Use	17
Precautions for Correct Use.....	20
Regulations and Standards	21
Conformance to EU Directives	21
Conformance to EN ISO 13849-1 and EN 62061.....	22
Conformance to UL and CSA Standards	22
Conformance to KC Standards	23
Unit Versions	24
Unit Versions.....	24
Unit Versions of safety I/O terminals and Sysmac Studio Versions	25
Related Manuals	26
Terminology	27
Revision History	30
Sections in this Manual	31

Section 1 Overview

1-1	Safety I/O Terminal Overview	1-2
1-1-1	Feature	1-2
1-1-2	System Configuration Overview	1-3
1-2	Procedure	1-4
1-2-1	Procedure Overview	1-4
1-2-2	Procedure Details	1-6

Section 2 System Configuration and Configuration Devices

2-1	Basic Configuration	2-2
2-1-1	EtherNet/IP Field Network Configuration	2-2
2-1-2	Configuration Device	2-3
2-2	EtherNet/IP Network Connection Configurations	2-4
2-2-1	Star Topology	2-4
2-2-2	Daisy-Chain Topology	2-5
2-2-3	Combined Star and Daisy-Chain Topology	2-6
2-2-4	Ring Topology	2-7
2-3	Connecting to Support Software	2-8

Section 3 Specifications of Configuration Units

3-1	Specifications	3-2
3-1-1	Models and Specifications	3-2
3-1-2	Built-in EtherNet/IP port specifications	3-6
3-1-3	Component and Functions	3-7
3-1-4	Terminal Block	3-8
3-1-5	Indication Block	3-11
3-1-6	ID Information Indication	3-15
3-2	Memory Cassette	3-16
3-2-1	Outline	3-16
3-2-2	Use	3-16
3-3	Sysmac Studio	3-17
3-3-1	Product Type	3-17
3-3-2	Connection Method	3-18
3-4	PFH	3-19

Section 4 Installation and Wiring

4-1	Installing the I/O Terminal	4-2
4-1-1	Installation in a Control Panel	4-3
4-1-2	Preparations for Installation	4-6
4-1-3	Installing the Safety I/O Terminal	4-8
4-1-4	Mounting the End Plates	4-10
4-1-5	Removing the Safety I/O Terminal	4-11
4-1-6	Assembled Appearance and Dimensions	4-12
4-2	Wiring	4-14
4-2-1	Power Supply and Source Type	4-14
4-2-2	Unit Power Supply Wiring	4-16
4-2-3	Selecting Power Supplies	4-17
4-2-4	Selecting and Wring Protective Equipment	4-18
4-2-5	Earthing	4-20
4-2-6	Connecting the Built-in EtherNet/IP Port	4-21
4-2-7	Wiring to the Terminal Block of the Safety I/O Terminal	4-29

4-2-8	Removing the Memory Cassette	4-40
4-3	Control Panel Installation	4-42
4-3-1	Temperature	4-42
4-3-2	Humidity	4-44
4-3-3	Vibration and Shock	4-44
4-3-4	Atmosphere	4-44
4-3-5	Electrical Environment	4-45
4-3-6	Earthing	4-49

Section 5 Safety I/O Terminal Operation

5-1	Overview of CIP Safety Communications and Tag Data Link Operation.....	5-2
5-1-1	Overview of CIP Safety Communication	5-2
5-1-2	Introduction to Tag Data Links.....	5-4
5-2	Input/Output Mechanism	5-10
5-2-1	Relation between Signal Types and Communication Types	5-10
5-2-2	Variable Data Type	5-10
5-3	Safety I/O Functions	5-11
5-3-1	Safety Input Function	5-11
5-3-2	Safety Output Function	5-25

Section 6 Settings

6-1	Configuration and Setup Procedures	6-2
6-2	Part Names and Functions of the Sysmac Studio Window6-3	
6-3	Connection Settings and I/O Settings	6-4
6-3-1	Creating a Project File.....	6-4
6-3-2	Registering a Safety Connection.....	6-6
6-3-3	Setting the IP Address	6-8
6-3-4	Registering the I/O Assembly.....	6-9
6-3-5	Configuring the Safety I/O Functions	6-14
6-3-6	Registering the Device Variables	6-20
6-3-7	Creating the Safety Programs.....	6-22
6-3-8	Debugging/Commissioning	6-23
6-4	Configuring and Setting Up the EtherNet/IP Network6-24	
6-4-1	Setting the IP Address	6-24
6-4-2	CIP Safety Connection Settings.....	6-34
6-4-3	Memory Clear.....	6-38
6-4-4	Restart.....	6-40
6-5	Exporting/Importing Settings Data	6-42
6-5-1	Exporting/Importing Safety I/O Terminal Settings	6-42

Section 7 Safety Reaction Time Calculation

7-1	Safety Reaction Time	7-2
7-1-1	How to Calculate Safety Reaction Time.....	7-2
7-1-2	How to Verify Safety Reaction Time.....	7-4
7-1-3	Safety Task.....	7-4
7-2	EPI (Expected Packet Interval)	7-5
7-2-1	Changing EPI.....	7-5
7-2-2	EPI Constraint.....	7-5

Section 8 Troubleshooting

8-1	How to Check for Errors	8-2
8-1-1	Safe State	8-2
8-2	Checking for Errors with the Indicators	8-3
8-3	Checking for Errors with the Sysmac Studio	8-6
8-3-1	Checking with Troubleshooting	8-6
8-3-2	Checking with the CIP Safety Monitor function	8-6
8-3-3	Error Descriptions and Corrections	8-13
8-4	Checking Communications Status with the Network Configurator	8-15
8-5	Error Detection by User Program	8-16

Section 9 Inspection and Maintenance

9-1	Cleaning and Maintenance	9-2
9-1-1	Cleaning	9-3
9-1-2	Periodic Inspection	9-3
9-2	Maintenance	9-5
9-2-1	Replacing Safety I/O Terminal	9-6

Appendices

A-1	External Dimensions	A-2
A-1-1	Safety I/O Terminal	A-2
A-2	Safety I/O Assembly Data	A-3
A-2-1	Safety Input Assembly	A-3
A-2-2	Safety Output Assembly	A-7
A-2-3	Configuration Data	A-8
A-3	EtherNet/IP Object Classes	A-11
A-3-1	Identity (0x01)	A-11
A-3-2	Message Router (0x02)	A-12
A-3-3	Assembly (0x04)	A-12
A-3-4	Connection Manager (0x06)	A-13
A-3-5	TCP/IP Interface (0xF5)	A-14
A-3-6	Ethernet Link (0xF6)	A-15
A-3-7	DLR (0x47)	A-15
A-3-8	QoS (0x48)	A-16
A-4	Application Examples	A-17
A-4-1	Emergency Stop Pushbutton Switch	A-17
A-4-2	Safety Doors	A-20
A-4-3	Safety Laser Scanners	A-23
A-4-4	Safety Door Switches with Magnetic Locks and Key Selector Switches	A-26
A-4-5	Enable Switches	A-30
A-4-6	Two-hand Switches	A-34
A-4-7	Safety Light Curtain	A-37
A-5	I/O Assemblies and I/O Ports for Safety I/O Terminal	A-40
A-5-1	Safety I/O Terminal (GI-SMD1624)	A-40
A-5-2	Safety I/O Terminal (GI-SID1224)	A-41
A-6	Version Information	A-42

Relevant Manuals

The following table provides the relevant manuals for the GI-S-series safety I/O terminals. Read all of the manuals that are relevant to your system configuration and application before you use the product.

Most operations are performed from the Sysmac Studio Automation Software. ☐☐ Refer to the *Sysmac Studio Version 1 Operation Manual* (Cat. No. W504) for information on the Sysmac Studio.

Purpose of use	Manual		
	Basic information		
	GI-S-Series Safety I/O Terminal User's Manual	NX-series Safety Control Unit / Communication Control Unit User's Manual	Sysmac Studio Version 1 Operation Manual
Understanding overview of the safety I/O terminal	•		
Setting devices and hardware	•		
Safety I/O terminal GI-S☐☐☐☐☐☐☐☐			
Software settings	•	•	•
Safety I/O terminal GI-S☐☐☐☐☐☐☐☐	•		•
NX-SL5☐☐☐☐ Safety CPU Unit			•
NX-CSG☐☐☐☐ Communication Control Unit		•	•
Creating safety programs		•	•
Testing operation and debugging	•	•	•
Safety programs		•	•
CIP Safety communications	•		•
Safety I/O functions	•		•
Tag data links	•	•	
Learning about error corrections	•	•	
Maintenance	•		

Manual Structure

Page Structure

The following page structure is used in this manual.

The diagram illustrates the structure of a manual page with the following components and annotations:

- Level 1 heading:** 4 Installation and Wiring
- Level 2 heading:** 4-3 Mounting Units
- Level 3 heading:** 4-3-1 Connecting Controller Components
- A step in a procedure:** 1 Join the Units so that the connectors fit exactly. Indicates a procedure.
- Special information:** Precautions for Correct Use. Icons indicate precautions, additional information, or reference information.
- Manual name:** NJ-series CPU Unit Hardware User's Manual (W500)
- Page tab:** 4. Gives the number of the main section.

Additional labels on the right side of the diagram include:

- Level 1 heading
- Level 2 heading
- Level 3 heading
- Gives the current headings.
- Page tab
- Gives the number of the main section.

This illustration is provided only as a sample. It may not literally appear in this manual.

Special Information

Special information in this manual is classified as follows:



Precautions for Safe Use

Precautions on what to do and what not to do to ensure safe usage of the product.



Precautions for Correct Use

Precautions on what to do or avoid doing, to prevent failure to operate or undesirable effect on product performance.



Additional Information

Additional information to read as required.

This information is provided to increase understanding or make operation easier.



Version Information

Information on differences in specifications and functionality for safety I/O terminals with different unit versions and for different versions of the Sysmac Studio is given.



References are provided to more detailed or related information.

Precaution on Terminology

This user's manual expresses directions for the figure as the front view of the safety I/O terminal shown below.

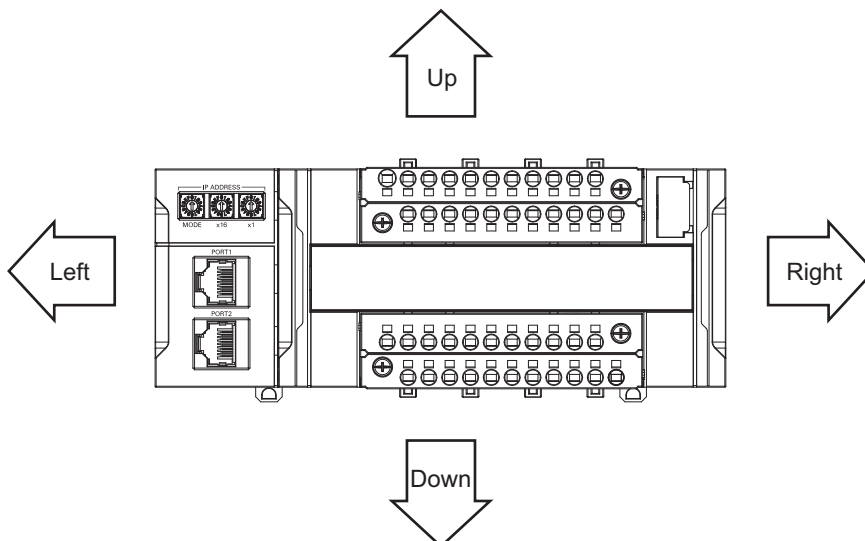

Terms and Conditions Agreement

Warranties

● Exclusive Warranty

Omron's exclusive warranty is that the Products will be free from defects in materials and workmanship for a period of twelve months from the date of sale by Omron (or such other period expressed in writing by Omron). Omron disclaims all other warranties, express or implied.

● Limitations

OMRON MAKES NO WARRANTY OR REPRESENTATION, EXPRESS OR IMPLIED, ABOUT NON-INFRINGEMENT, MERCHANTABILITY OR FITNESS FOR A PARTICULAR PURPOSE OF THE PRODUCTS. BUYER ACKNOWLEDGES THAT IT ALONE HAS DETERMINED THAT THE PRODUCTS WILL SUITABLY MEET THE REQUIREMENTS OF THEIR INTENDED USE.

Omron further disclaims all warranties and responsibility of any type for claims or expenses based on infringement by the Products or otherwise of any intellectual property right.

● Buyer Remedy

Omron's sole obligation hereunder shall be, at Omron's election, to (i) replace (in the form originally shipped with Buyer responsible for labor charges for removal or replacement thereof) the non-complying Product, (ii) repair the non-complying Product, or (iii) repay or credit Buyer an amount equal to the purchase price of the non-complying Product; provided that in no event shall Omron be responsible for warranty, repair, indemnity or any other claims or expenses regarding the Products unless Omron's analysis confirms that the Products were properly handled, stored, installed and maintained and not subject to contamination, abuse, misuse or inappropriate modification. Return of any Products by Buyer must be approved in writing by Omron before shipment. Omron Companies shall not be liable for the suitability or unsuitability or the results from the use of Products in combination with any electrical or electronic components, circuits, system assemblies or any other materials or substances or environments. Any advice, recommendations or information given orally or in writing, are not to be construed as an amendment or addition to the above warranty.

See <http://www.omron.com/global/> or contact your Omron representative for published information.

Limitation on Liability; Etc

OMRON COMPANIES SHALL NOT BE LIABLE FOR SPECIAL, INDIRECT, INCIDENTAL, OR CONSEQUENTIAL DAMAGES, LOSS OF PROFITS OR PRODUCTION OR COMMERCIAL LOSS IN ANY WAY CONNECTED WITH THE PRODUCTS, WHETHER SUCH CLAIM IS BASED IN CONTRACT, WARRANTY, NEGLIGENCE OR STRICT LIABILITY.

Further, in no event shall liability of Omron Companies exceed the individual price of the Product on which liability is asserted.

Suitability of Use

Omron Companies shall not be responsible for conformity with any standards, codes or regulations which apply to the combination of the Product in the Buyer's application or use of the Product. At Buyer's request, Omron will provide applicable third party certification documents identifying ratings and limitations of use which apply to the Product. This information by itself is not sufficient for a complete determination of the suitability of the Product in combination with the end product, machine, system, or other application or use. Buyer shall be solely responsible for determining appropriateness of the particular Product with respect to Buyer's application, product or system. Buyer shall take application responsibility in all cases.

NEVER USE THE PRODUCT FOR AN APPLICATION INVOLVING SERIOUS RISK TO LIFE OR PROPERTY OR IN LARGE QUANTITIES WITHOUT ENSURING THAT THE SYSTEM AS A WHOLE HAS BEEN DESIGNED TO ADDRESS THE RISKS, AND THAT THE OMRON PRODUCT(S) IS PROPERLY RATED AND INSTALLED FOR THE INTENDED USE WITHIN THE OVERALL EQUIPMENT OR SYSTEM.

Programmable Products

Omron Companies shall not be responsible for the user's programming of a programmable Product, or any consequence thereof.

Performance Data

Data presented in Omron Company websites, catalogs and other materials is provided as a guide for the user in determining suitability and does not constitute a warranty. It may represent the result of Omron's test conditions, and the user must correlate it to actual application requirements. Actual performance is subject to the Omron's Warranty and Limitations of Liability.

Change in Specifications

Product specifications and accessories may be changed at any time based on improvements and other reasons. It is our practice to change part numbers when published ratings or features are changed, or when significant construction changes are made. However, some specifications of the Product may be changed without any notice. When in doubt, special part numbers may be assigned to fix or establish key specifications for your application. Please consult with your Omron's representative at any time to confirm actual specifications of purchased Product.

Errors and Omissions

Information presented by Omron Companies has been checked and is believed to be accurate; however, no responsibility is assumed for clerical, typographical or proofreading errors or omissions.

Terms and Conditions Agreement (Software)

WARRANTY

- (1) The warranty period for the Software is one year from the date of purchase, unless otherwise specifically agreed.
- (2) If the User discovers defect of the Software (substantial non-conformity with the manual), and return it to OMRON within the above warranty period, OMRON will replace the Software without charge by offering media or download from OMRON's website. And if the User discovers defect of media which is attributable to OMRON and return it to OMRON within the above warranty period, OMRON will replace defective media without charge. If OMRON is unable to replace defective media or correct the Software, the liability of OMRON and the User's remedy shall be limited to the refund of the license fee paid to OMRON for the Software.

LIMITATION OF LIABILITY

- (1) THE ABOVE WARRANTY SHALL CONSTITUTE THE USER'S SOLE AND EXCLUSIVE REMEDIES AGAINST OMRON AND THERE ARE NO OTHER WARRANTIES, EXPRESSED OR IMPLIED, INCLUDING BUT NOT LIMITED TO, WARRANTY OF MERCHANTABILITY OR FITNESS FOR PARTICULAR PURPOSE. IN NO EVENT, OMRON WILL BE LIABLE FOR ANY LOST PROFITS OR OTHER INDIRECT, INCIDENTAL, SPECIAL OR CONSEQUENTIAL DAMAGES ARISING OUT OF USE OF THE SOFTWARE.
- (2) OMRON SHALL HAVE NO LIABILITY FOR DEFECT OF THE SOFTWARE BASED ON MODIFICATION OR ALTERNATION TO THE SOFTWARE BY THE USER OR ANY THIRD PARTY. OMRON SHALL NOT BE RESPONSIBLE AND/OR LIABLE FOR ANY LOSS, DAMAGE, OR EXPENSES DIRECTLY OR INDIRECTLY RESULTING FROM THE INFECTION OF OMRON PRODUCTS, ANY SOFTWARE INSTALLED THEREON OR ANY COMPUTER EQUIPMENT, COMPUTER PROGRAMS, NETWORKS, DATABASES OR OTHER PROPRIETARY MATERIAL CONNECTED THERETO BY DISTRIBUTED DENIAL OF SERVICE ATTACK, COMPUTER VIRUSES, OTHER TECHNOLOGICALLY HARMFUL MATERIAL AND/OR UNAUTHORIZED ACCESS.
- (3) OMRON SHALL HAVE NO LIABILITY FOR SOFTWARE DEVELOPED BY THE USER OR ANY THIRD PARTY BASED ON THE SOFTWARE OR ANY CONSEQUENCE THEREOF.

APPLICABLE CONDITIONS

USER SHALL NOT USE THE SOFTWARE FOR THE PURPOSE THAT IS NOT PROVIDED IN THE ATTACHED USER MANUAL.

CHANGE IN SPECIFICATION

The software specifications and accessories may be changed at any time based on improvements and other reasons.

ERRORS AND OMISSIONS



The information in this manual has been carefully checked and is believed to be accurate; however, no responsibility is assumed for clerical, typographical, or proofreading errors, or omissions.

Safety Precautions





Definition of Precautionary Information

The following notation is used in this manual to provide precautions required to ensure safe usage of a GI-S-series safety I/O terminal. The safety precautions that are provided are extremely important to safety. Always read and heed the information provided in all safety precautions.

The following notation is used.

 WARNING	Indicates a potentially hazardous situation which, if not avoided, could result in death or serious injury. Additionally, there may be severe property damage.
 CAUTION	Indicates a potentially hazardous situation which, if not avoided, may result in minor or moderate injury, or property damage.

Symbols

	The circle and slash symbol indicates operations that you must not do.
	The triangle symbol indicates precautions (including warnings). The specific operation is shown in the triangle and explained in text. This example indicates a precaution for ignition.
	The triangle symbol indicates precautions (including warnings). The specific operation is shown in the triangle and explained in text. This example indicates a precaution for high temperatures.
	The filled circle symbol indicates operations that you must do. The specific operation is shown in the circle and explained in text. This example shows a general precaution for something that you must do.

Alert Statements

WARNING

Required safety functions will be lost, and death due to injury may possibly occur. When building the system, observe the following warnings to ensure the integrity of the safety-related components.



Setting Up a Risk Assessment System

The process of selecting these products should include the development and execution of a risk assessment system early in the design development stage to help identify potential dangers in your equipment and optimize safety product selection.

Related International Standards:

- ISO 12100 General Principles for Design - Risk Assessment and Risk Reduction



Protective Measure

When developing a safety system for the equipment and devices that use safety products, make every effort to understand and conform to the entire series of international and industry standards available, such as the examples given below.

Related International Standards:

- ISO 12100 General Principles for Design - Risk Assessment and Risk Reduction
- IEC 60204-1 Electrical Equipment of Machines - Part 1: General Requirements
- ISO 13849-1, -2 Safety-related Parts of Control Systems
- ISO 14119 Interlocking Devices Associated with Guards - Principles for Design and Selection
- IEC/TS 62046 Application of Protective Equipment to Detect the Presence of Persons
- IEC 62061 Functional Safety of Safety-related Electrical, Electronic and Programmable Electronic Control Systems
- IEC 61508 Functional Safety of Electrical/Electronic/Programmable Electronic Safety-related Systems



Role of Safety Products

Safety products incorporate standardized safety functions and mechanisms, but the benefits of these functions and mechanisms are designed to attain their full potential only within properly designed safety-related systems. Make sure you fully understand all functions and mechanisms, and use that understanding to develop systems that will ensure optimal usage.

Related International Standards:

- ISO 14119 Interlocking Devices Associated with Guards - Principles for Design and Selection
- ISO 13857 Safety Distances to Prevent Hazard Zones being Reached by Upper and Lower Limbs



Installing Safety Products

Qualified engineers must develop your safety-related system and install safety products in devices and equipment. Prior to machine commissioning verify through testing that the safety products works as expected.

Related International Standards:

- ISO 12100 General Principles for Design - Risk Assessment and Risk Reduction
- IEC 60204-1 Electrical Equipment of Machines - Part 1: General Requirements
- ISO 13849-1, -2 Safety-related Parts of Control Systems
- ISO 14119 Interlocking Devices Associated with Guards - Principles for Design and Selection
- IEC 62061 Functional Safety of Safety-related Electrical, Electronic and Programmable Electronic Control Systems
- IEC 61508 Functional Safety of Electrical/Electronic/Programmable Electronic Safety-related Systems



Observing Laws and Regulations

Safety products must conform to pertinent laws, regulations, and standards. Make sure that they are installed and used in accordance with the laws, regulations, and standards of the country where the devices and equipment incorporating these products are distributed.



Observing Usage Precautions

Carefully read the specifications and precautions as well as all items in the Instruction Manual for your safety product to learn appropriate usage procedures. Any deviation from instructions will lead to unexpected device or equipment failure not anticipated by the safety-related system.



Transferring Devices and Equipment

When transferring devices and equipment, be sure to retain one copy of the Instruction Manual and supply another copy with the device or equipment so the person receiving it will have no problems with operation and maintenance.

Related International Standards:

- ISO 12100 General Principles for Design - Risk Assessment and Risk Reduction
- IEC 60204-1 Electrical Equipment of Machines - Part 1: General Requirements
- ISO 13849-1, -2 Safety-related Parts of Control Systems
- IEC 62061 Functional Safety of Safety-related Electrical, Electronic and Programmable Electronic Control Systems
- IEC 61508 Functional Safety of Electrical/Electronic/Programmable Electronic Safety-related Systems



Design

Required safety functions will be lost, and death due to injury may possibly occur. Verify the calculated reaction times for all safety chains to confirm that they satisfy the required specifications.



LEDs are NOT reliable indicators and cannot be guaranteed to provide accurate information. They should ONLY be used for general diagnostics during commissioning or troubleshooting. Do not attempt to use LEDs as operational indicators.



Required safety functions will be lost, and death due to injury may possibly occur. Do not use non-safety signals, including tag data links, explicit messages and exposed variables, as safety signals.



Death due to injury may possibly occur. Clear the memory to delete the previous configuration data stored in the Safety I/O Terminal unit before installing the Safety I/O Terminal to the equipment or device, or connecting to a network.



Death due to injury may possibly occur. Before connecting a Safety I/O Terminal to the network, set a suitable IP address and communications speed.



Required safety functions will be lost, and death due to injury may possibly occur. Make sure that the originator and target have the proper configuration if you want to set the Open type as "Open only".



Required safety functions will be lost, and death due to injury may possibly occur. In debugging safety I/O terminals, check that the safety I/O terminals and the external devices operate properly as programmed by the CPU Unit which is an originator device.



Death due to injury may possibly occur. Take appropriate and sufficient countermeasures during installation in the following locations.

- a) Locations near devices that produce strong, high-frequency noise
- b) Locations subject to static electricity or other forms of noise
- c) Locations subject to strong electromagnetic fields
- d) Locations subject to possible exposure to radioactivity
- e) Locations close to power lines



Testing Operation

Death due to injury may possibly occur. Before you start the system, perform user testing to make sure that the configuration data of all devices are correct and they operate correctly.



Wiring

Death due to injury may possibly occur. Never earth the +24-V side of the power supply. Safety functions may not operate correctly due to earth faults.



Required safety functions will be lost, and death due to injury may possibly occur. Do not use GI-S-series' test output as the safety output line.



Maintenance

Required safety functions will be lost, and death due to injury may possibly occur. Do not disassemble, repair, or modify the product.



 **CAUTION**

Maintenance

Fire or malfunction may possibly occur if screws loosen.
Tighten terminal block fixing screws to the torques specified in this manual.



Moderate burn injury may possibly occur. Do not touch any device when power is being supplied or immediately after the power supply is turned OFF.



Precautions for Safe Use

Transporting

- Do not drop any product or subject it to abnormal vibration or shock. Doing so may result in injury, product malfunction or burning.

Installation

- This is a Class A product (for industrial environments). In a residential environment, it may cause radio interference. If radio interference occurs, the user may be required to take appropriate measures.
- Do not operate or store the product in the following locations. Doing so may result in burning, in operation stopping, or in malfunction.
 - a) Locations subject to direct sunlight
 - b) Locations subject to temperatures or humidity outside the range specified in the specifications
 - c) Locations subject to condensation as the result of severe changes in temperature
 - d) Locations subject to corrosive or flammable gases
 - e) Locations subject to dust (especially iron dust) or salts
 - f) Locations subject to exposure to water, oil, or chemicals
 - g) Locations subject to shock or vibration
 - h) Locations subject to noise due to static electricity
- Use the GI-S Series in the enclosure complying with IP54 (IEC/EN 60529) or higher.
- In installing to the control panel, use DIN Tracks (TH35-7.5/TH35-15: IEC60715). In order to prevent drops due to vibration, fix the GI-S Series to the DIN Tracks using End Plates (sold separately).
- Install the product in a well-ventilated area. Avoid installing the product near heating elements. Doing so may result in malfunction, in operation stopping, or in burning.

Wiring

- Follow the instructions in this manual to correctly perform installation and wiring.
- Use the methods that are specified in this manual for wiring the terminal blocks.
- Use the correct wire size, wiring parts and tools when you wire the system. Otherwise, cables may be disconnected to cause short-circuit or wire breakage.
- When you install wiring, be sure to turn off the power beforehand. Otherwise, the external devices connected with the GI-S Series may operate unexpectedly.
- Do not pull on the cables or bend the cables beyond their natural limit. Do not place any heavy objects on the cables or other wiring lines. Doing so may sever the cables.
- Make sure that foreign material or metal dust should not come into the Safety I/O Terminal while wiring and/or installation. Doing so may result in product burning, electric shock, or failure.
- Mount terminal blocks and connectors only after checking the mounting location carefully. During this time, be careful not to pinch your fingers.
- Be sure that the terminal blocks and Ethernet communications cables with tightening screws or locking devices are properly tightened to or locked into place.
- When you insert a flat-blade screwdriver into a release hole on the screwless clamping terminal block, press the screwdriver down with an appropriate angle and a force of 30 N or less. Applying excessive force may damage the terminal block.

- Do not tilt or twist the flat-blade screwdriver while it is pressed into the release hole of the screwless clamping terminal block. Doing so may break the terminal block.

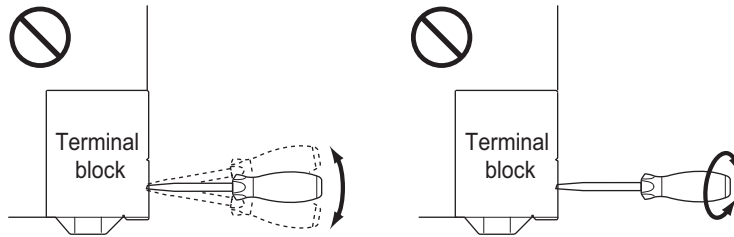

On Power Supply Design/Power ON

- DC power supplies must meet the following items:
 - a) Use reinforced insulation or double insulation.
 - b) Ensure an output hold time of 20 ms min.
 - c) Use an SELV power supply that meets the requirements of IEC/EN 60950-1 and EN 50178.
- Select a unit power and output power supply with sufficient capacity by considering the power supply capacity or inrush current when the power is turned ON that is specified in this manual. Otherwise, the external power supply may not be turned ON or malfunction due to unstable power supply voltage.
- Use the unit power supply and output power supply within the operating power supply voltage range specified on this manual.
- Do not apply voltages that exceed the rated value or connect loads to the GI-S Series Terminals.
- Surge current occurs when the power supply is turned ON. When selecting fuses or breakers for external circuits, consider the fusing and sensing characteristics to select fuses or breakers with appropriate specification. Refer to this manual for surge current specifications.
- Make sure that the current capacity of the wire is sufficient. Otherwise, excessive heat may be generated. When cross-wiring terminals, the total current for all the terminals will flow in the wire. When wiring cross-overs, make sure that the current capacity of each of the wires is not exceeded.

Turning OFF the Power Supply

- Always confirm safety before you transfer data or setting values from the Sysmac Studio. During transfer, do not disconnect the cable or turn OFF the power supply to the Safety I/O Terminal.
- Always turn OFF the power supply to the Safety I/O Terminal before you attempt any of the following.
 - 1) Assembling the Units
 - 2) Setting rotary switches
 - 3) Connecting cables or wiring the system
 - 4) Connecting or disconnecting the terminal blocks or connectors
 - 5) Attaching or removing the memory cassette

The V0 indicator for the controller remains lit for several seconds after power is turned off. Make sure that the V0 indicator is not lit before you perform any of the above operations.

Operation

- Avoid applying excessive force when you change the rotary switch settings.

EtherNet/IP Communications

- Make sure to use the communications distance, number of nodes connected, and method of connection for EtherNet/IP within specifications. Do not connect EtherNet/IP communications to Ether-CAT or other networks. An overload may cause the network to fail or malfunction.
- If EtherNet/IP tag data links (cyclic communications) are used with a repeating hub, the communications load on the network will increase. This will increase collisions and may prevent stable communications. Do not use repeating hubs on networks where tag data links are used. Use an Ethernet switch instead.

Maintenance

- Insert the memory cassette all the way. Do not remove the memory cassette while the power is being supplied. Data may become corrupted, and the product will not operate correctly if it uses corrupted data.

Disposal

- Dispose of the product in accordance with the relevant rules and regulations of the country or area where the product is used.

Precautions for Correct Use

Wiring

- For EtherNet/IP, use the connection methods and cables that are specified in this manual. Otherwise, communications may be faulty.

EtherNet/IP Communications

- When constructing an intranet via a global address, take into account setting up a firewall after consulting network experts for network security.
Some communication applications may not perform communications due to firewall settings by a carrier. Contact the carrier for information.

On Replacing Safety I/O Terminal

- If you replace a safety I/O terminal,  refer to *Section 9 Inspection and Maintenance* in this manual and redo the necessary settings.

Regulations and Standards

GI-S-series safety I/O terminals have been authenticated for the following standards.

Certification body	Standards
TÜV Rheinland	<ul style="list-style-type: none"> • EN ISO 13849-1: 2015 • IEC 61508 parts 1-7: 2010 • IEC/EN 62061:2005+A1: 2013+A2:2015 • IEC/EN 61131-2: 2017
UL	<ul style="list-style-type: none"> • NRAG (UL 61010-1, UL 61010-2-201 and UL 121201) • NRAG7 (CSA C22.2 No. 61010-1, CSA C22.2 No. 61010-2-201 and CSA C22.2 No.213)

By using GI-S-series safety I/O terminals, you can build a safety control system that meets the followings.

- Requirements for SIL 3 (Safety Integrity Level 3) in IEC 61508, IEC/EN 62061, (Functional Safety of Electrical/Electronic/Programmable Electronic Safety-related Systems)
- Requirements for PLe (Performance Level e) and for safety category 4 in EN ISO13849-1

Also, GI-S-series safety I/O terminals have been registered for conformity to RCM, EAC, and KC (Korean radio regulation).

Conformance to EU Directives

Applicable Directives

- EMC Directives
- Machinery Directive

Concepts

● EMC Directives

OMRON devices that comply with EU Directives also conform to the related EMC standards so that they can be more easily built into other devices or the overall machine. The actual products have been checked for conformity to EMC standards.*1

Whether the products conform to the standards in the system used by the customer, however, must be checked by the customer. EMC-related performance of the OMRON devices that comply with EU Directives will vary depending on the configuration, wiring, and other conditions of the equipment or control panel on which the OMRON devices are installed. The customer must, therefore, perform the final check to confirm that devices and the overall machine conform to EMC standards.

*1. Applicable EMC (Electromagnetic Compatibility) standards are as follows: EMS (Electromagnetic Susceptibility): EN 61131-2 EMI (Electromagnetic Interference): EN 61131-2 (Radiated emission: 10-m regulations).

● Machinery Directive

The Machinery Directive requires ensuring the required safety for safety components used for machinery safety.

Applicable standards: EN ISO 13849-1 and EN 62061.

● Conformance to EU Directives

The GI-S-series Units comply with EU Directives. To ensure that the machine or device in which the GI-S-series Units are used complies with EU Directives, the following precautions must be observed.

- The GI-S-series Units must be installed within a metallic control cabinet.
- DC power supplies to be connected to a GI-S-series product as unit power supplies or I/O power supplies must meet the following items.

a) Use reinforced insulation or double insulation.

b) Ensure an output hold time of 20 ms min.

c) Use an SELV power supply that meets the requirements of IEC/EN 60950-1 and EN 50178.

We recommend that you use the OMRON S8VS-series Power Supplies. EMC standard compliance was confirmed for the recommended Power Supplies.

- GI-S-series Units that comply with EU Directives also conform to the Common Emission Standard. Radiated emission characteristics (10-m regulations) may vary depending on the configuration of the control panel used, other devices connected to the control panel, wiring, and other conditions. You must therefore confirm that the overall machine or equipment in which the GI-S-series Units are used complies with EU Directives.
- This is a Class A product (for industrial environments). In a residential environment, it may cause radio interference. If radio interference occurs, the user may be required to take appropriate measures.

Conformance to EN ISO 13849-1 and EN 62061

EN ISO 13849-1 and EN 62061 require process management to avoid system interference and to simplify reading, understanding, testing, and maintaining software. This is required in all phases of the life cycle of software programming and software design (e.g., basic software design, safety circuit system design, and software upgrades) in safety control systems to be developed using safety controllers.

Therefore, process management is required for design and development of software for facilities and equipment that use the function blocks provided in the Safety Controller.

The customer must implement measures to ensure compliance with these standards.

You can download the reliability data for safety of machinery that is required to verify the safety performance of your equipment from the following URL:

<http://www.ia.omron.com/support/sistemalibrary/index.html>.

Conformance to UL and CSA Standards

The GI-S-series Safety Control Units comply with the following UL and CSA standards. The application conditions for standard compliance are defined. Refer to the Instruction Sheet that is provided with each Unit before application.

Conformance to KC Standards

Observe the following precaution if you use GI-S-series Units in Korea.

사 용 자 안 내 문
이 기기는 업무용 환경에서 사용할 목적으로 적합성평가를 받은 기기로서 가정용 환경에서 사용하는 경우 전파간섭의 우려가 있습니다.

This product meets the electromagnetic compatibility requirements for business use. There is a risk of radio interference when this product is used in home.

Usage Conditions for KC Certification

Take the same measures as those described in *Conformance to EU Directives* on page 21. In addition, attach a clamp core to the port side of the EtherNet/IP cable.

The recommended clamp core is given below.

Recommended Clamp Core

Manufacturer	Product	Model	Turns of cable
NEC TOKIN	Clamp core	ESD-SR-250	1 turn

Unit Versions

This section describes the notation that is used for unit versions, the confirmation method for unit versions, and the relationship between unit versions and Sysmac Studio versions.

Unit Versions

A "unit version" has been introduced to manage the safety I/O terminal according to differences in functionality accompanying Unit upgrades.

Notation of Unit Versions on Products

You can check the "Unit Version" in the specification label on the side of the product.

ID information is given on the ID information and/or specification labels on the side of the product.

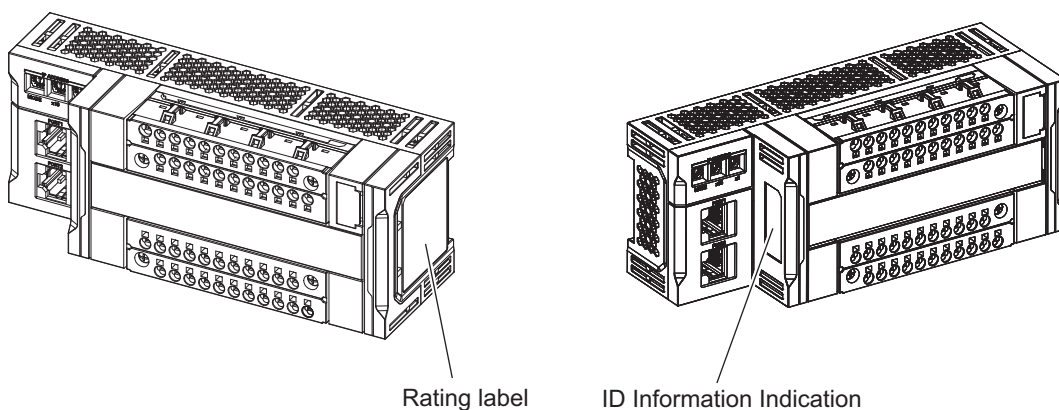

● Rating label

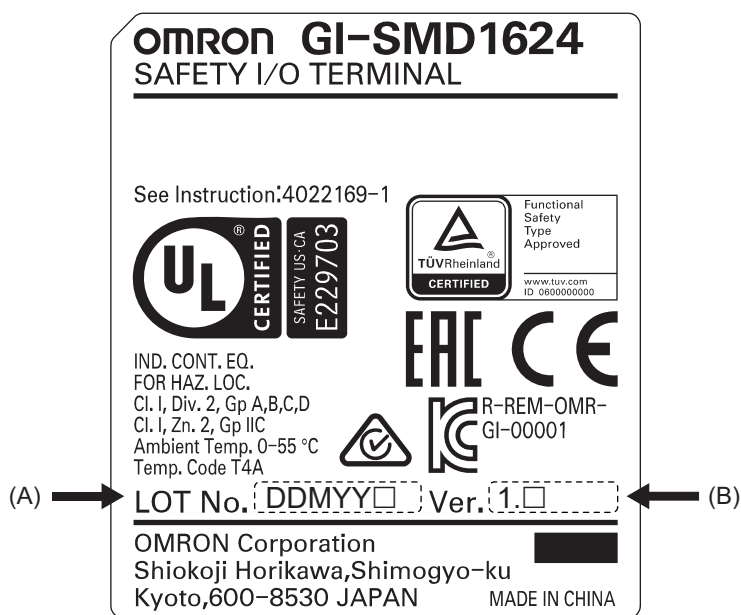

Symbol	Name	Description
A	Lot number	Shows the lot number of the Unit. DDMY: Lot number, □: Used by Omron, M is 1 to 9 for January to September, X for October, Y for November, and Z for December.
B	Unit version	Shows the unit version of the Unit.

● ID information indication

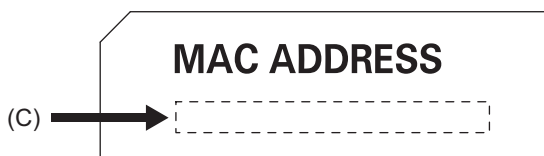

Symbol	Name	Description
C	MAC address	Shows the MAC addresses of the built-in EtherNet/IP ports (PORT1 and PORT2) on the CPU Unit.

Unit Versions of safety I/O terminals and Sysmac Studio Versions

The functions that are supported depend on the unit version of the GI-S-series safety I/O terminal. The version of Sysmac Studio that supports the functions that were added for an upgrade is required to use those functions. To use a safety I/O terminal GI-S□□□□□□□□, you need Sysmac Studio Ver 1.24 or later.

□□ Refer to *Version Information* on page A-42 for the relationship between the unit versions of the safety I/O terminals and the Sysmac Studio versions, and for the functions that are supported by each unit version.

Related Manuals

The followings are the manuals related. Use these manuals for reference.

Manual name	Cat. No.	Model numbers	Application	Description
GI-S-Series Safety I/O Terminal User's Manual	Z400	GI-S□□□□□□	Learning how to use the GI-S-series safety I/O terminals.	Describes the hardware, setup methods, and functions of the GI-S Series Safety I/O Terminals.
NX-series Safety Control Unit / Communication Control Unit User's Manual	Z395	NX-SL5□□□□ NX-SI□□□□□ NX-SO□□□□□ NX-CSG□□□□	Learning how to use the NX-series Safety Control Units and Communications Control Units.	Describes the hardware, setup methods, and functions of the NX-series Safety Control Units and Communication Control Units.
NX-series NX102 CPU Unit Hardware User's Manual	W593	NX102-□□□□□	Learning the basic specifications of the NX102 CPU Units, including introductory information, designing, installation, and maintenance. Mainly hardware information is provided.	An introduction to the entire NX102 system is provided along with the following information on the CPU Unit. <ul style="list-style-type: none"> • Features and system configuration • Introduction • Part names and functions • General specifications • Installation and wiring • Maintenance and Inspection
Sysmac Studio Version 1 Operation Manual	W504	SYSMAC-SE2□□□□	Learning about the operating procedures and functions of the Sysmac Studio.	Describes the operating procedures of the Sysmac Studio.

Terminology

Term	Description
standard	The generic term for devices, functions, and data that are used for general control purposes as opposed to those that are used for safety measures.
safety function	This function is executed by the safety control system to materialize the safe state against hazards from a machine.
safe state	The status of a device or piece of equipment when the risk of danger to humans has been reduced to an acceptable level.
safety signal	A signal that is used for safety controls. In this safety control system, the data type of a variable determines whether a signal is related to the safety controls. Broadly speaking, there are two data types: safety data types and standard data types.
standard signal	A signal or data that is used for general control purposes.
Safety data type	The data type for a safety signal.
Standard data type	The data type for a standard signal.
safety reaction time	The time required for the system to enter a safe state in a worst-case scenario after the occurrence of a safety-related input (press of an emergency stop pushbutton switch, interruption of a light curtain, opening of a safety door, etc.) or device failure. The reaction time of the system includes the reaction times of sensors and actuators, just like the reaction time for a Controller or network.
safety control	A type of control that uses devices, functions, and data that are designed with special safety measures.
standard control	A type of control that use devices, functions, and data that are designed for general control purposes. This term is used to differentiate from a safety control.
safety process data communications	A type of I/O data communications that is used for safety control purposes. A type of I/O data communications using Class 0 communications for the safety I/O terminal.
standard process data communications	A type of I/O data communications that is used for standard control purposes. A type of I/O data communications using Class 1 communications for the safety I/O terminal.
Safety I/O connection	A type of connections that is used for safety process data communications.
CIP Safety connection	Safety I/O connection that is used to transmit safety process data by the communication protocol called CIP Safety. CIP Safety originator connection and CIP Safety target connection are available depending on the roles of communications.
Safety I/O terminal	I/O terminal used for safety control.
Safety Control Unit	The generic term for a Unit that is used in safety controls.
Safety CPU Unit	A CPU Unit that is used for safety controls. This is a type of NX Unit.
Safety I/O Unit	An I/O Unit that is used for safety controls. This is a type of NX Unit.
safety input device	An input device that is designed with special safety measures for use in safety controls. The generic term for safety input devices, such as emergency stop pushbutton switches and safety switches.
safety output device	An output device that is designed with special safety measures for use in safety controls. The generic term for safety output devices, such as safety relays.
Communication Control Unit	The generic term for the interface units to have CIP Safety communications on a network between the Safety CPU Unit and CIP Safety on EtherNet/IP devices.
Safety Network Controller	The generic term for the building-block type safety controllers that have mounted the Safety Control Unit with the Communication Control Unit.
Safety program	User programming for safety controls in the Safety CPU Unit. This term is used to differentiate from the user program of the standard controller. Safety programs are programmed in the FBD language.

Term	Description
FBD language	<p>The abbreviation for the function block diagram programming language. This is a graphical language used to program algorithms with connecting lines that represent the flow of inputs and data, and rectangular boxes that represent functions or function blocks. Unlike the ladder diagram language, the FBD language does not have bus bars, and the connecting lines represent the flow of inputs and data rather than the power flow. Algorithms are executed in order from top to bottom in units that are called networks. A network consists of configuration elements that use connecting lines to connect inputs to outputs. The FBD language does not have an END instruction. Execution for the task period ends when the last network is executed.</p> <p>You use the FBD language to write safety programs for the Safety CPU Unit.</p>
user program	<p>All of the programs that are created by the user. User program refers to the programs for standard controls in the standard controller and to the safety program for the Safety CPU Unit.</p>
operating mode	<p>The status of the Safety CPU Unit, when it is in normal operation, that the user changes to run or check the operation of the Safety CPU Unit.</p> <p>There are the three modes: PROGRAM mode, DEBUG mode, and RUN mode.</p> <p>You can use DEBUG mode only when the Sysmac Studio is online with the Safety CPU Unit.</p>
safety validation	<p>The process of appending confirmation information to the safety application data if safety validation testing demonstrates that the safety controls meet the required specifications of a safety system.</p> <p>You execute the safety validation from the Sysmac Studio when the Safety CPU Unit is in DEBUG mode. The validated safety programs are automatically transferred to the non-volatile memory of the Safety CPU Unit.</p>
DEBUG mode	<p>The mode that is used to debug unvalidated safety programs. DEBUG mode is only available when the Sysmac Studio is online with the Safety CPU Unit.</p> <p>Use this mode to check that the safety programs and external devices operate correctly. After you confirm that the system meets the required specifications, perform the safety validation. This will enable you to change to RUN mode.</p> <p>When you change from PROGRAM mode to DEBUG mode, the unvalidated safety programs are automatically transferred to the main memory of the Safety CPU Unit.</p>
PROGRAM mode	<p>A mode indicates that execution of the safety program is stopped. You cannot control BOOL variables, use forced refreshing, or change present values.</p>
RUN mode	<p>A mode that indicates that execution of the validated safety programs is in progress. Unlike DEBUG mode (RUN), the validated safety programs in the non-volatile memory of the Safety CPU Unit are executed. You cannot control BOOL variables, use forced refreshing, or change present values.</p>
CPU rack	<p>A CPU unit or communication control unit is attached to this rack. In case of an NX-series CPU unit that can connect to an NX unit, it has an end cover attached to the CPU unit. In case of an NX-series communication control unit, it has an NX unit and an end cover attached to the communication control unit.</p>
safety application data	<p>The data that contains the settings that are used to operate the NX-series Safety Control Units.</p> <p>It consists of the safety programs, safety task, and variables. You use the Sysmac Studio to create this data, and then transfer and execute it on the Safety CPU Unit. On the Sysmac Studio, this data is shown as the slave parameters.</p> <p>The location where the safety application data is stored on the Safety CPU Unit depends on whether the safety programs have been validated. (Unvalidated safety programs are stored in the main memory, while validated safety programs are stored in the non-volatile memory.)</p>

Term	Description
safety input function	A function that evaluates whether the signals that are input on a safety input terminal are normal or abnormal. Specific safety evaluation functions include test pulse evaluation and dual channel evaluation. When the evaluation result shows an abnormality, the safety input data is made inactive (OFF).
safety output function	A function that evaluates whether the values of safety output data and the output signals on safety output terminals are normal or abnormal. Specific safety evaluation functions include test pulse evaluation and dual channel evaluation. When the evaluation result shows an abnormality, the output signal on the safety output terminal is turned OFF.
dual channel evaluation	This function uses a pair of safety input or safety output terminals as redundant terminals that are checked for consistency to evaluate the status of the safety input or safety output.
single channel	The input or output is used as a single point.
dual channels	Two inputs or outputs are used as a pair of points for redundancy.
test pulse evaluation	This function outputs a test pulse that is used to evaluate a safety input or safety output for failures or wiring errors with the connected external device.
Assembly	Collection of data held in a device to allow access from outside.
Connection	A logical communication path for inter-device communications.
Configuration	Setup configured for a device or a network.
Device Level Ring (DLR)	Data-link layer protocol that provides single-fault tolerance defined by EtherNet/IP standards.
Ring Supervisor	The Ring Supervisor is responsible for verifying the integrity of the ring; reconfiguring the ring to recover from faults and collecting diagnostic information for the ring.
Ring Node (Beacon-based)	Joins the DLR network to implement the ring topology. Notifies the ring supervisor of the fault. It also handles the Beacon frame to determine the state of the ring topology from the ring supervisor.

Revision History

A manual revision code appears as a suffix to the catalog number on the front and back covers of the manual.



Revision code	Date	Revised content
01	August 2018	Original production
02	September 2018	Addition of troubleshooting information
03	October 2018	Introduction, Regulations and Standards: Correction of the information of the "Standards" Introduction, Addition of "Terms and Conditions Agreement (Software)" Section 6, Creating the Safety Program Addition of "Precautions for Correct Use"
04	July 2019	Chapter 6, addition of description about the switch [MODE] Chapter 8, update of troubleshooting information due to addition of CIP Safety monitor function
05	December 2019	Chapter 2, addition of ring connection Chapter 3, update of the ID information (MAC address) display location Update of the number of cascade connections Chapter 5, addition of tag data link Chapter 6, update of the expression of I/O assembly and IP address settings Correction of other errors

Sections in this Manual

Introduction to GI-S-series Safety I/O Terminal

		1
1	Introduction	2
2	System Configuration and Configuration Devices	3
3	Specifications of Configuration Units	4
4	Installation and Wiring	5
5	Safety I/O Terminal Operation	6
6	Settings	7
7	Safety Reaction Time Calculation	8
8	Troubleshooting	9
9	Inspection and Maintenance	A
A	Appendices	



1

Overview

This chapter provides overview of the safety I/O terminal.

1-1	Safety I/O Terminal Overview	1-2
1-1-1	Feature	1-2
1-1-2	System Configuration Overview	1-3
1-2	Procedure	1-4
1-2-1	Procedure Overview	1-4
1-2-2	Procedure Details	1-6

1-1 Safety I/O Terminal Overview

1-1-1 Feature

The safety I/O terminal is a CIP Safety on EtherNet/IP device supporting the CIP Safety, which can materialize safety control via a network by combining with an NX-series Safety Control Unit.

To construct a safety control system, configure a safety I/O terminal, Safety CPU Unit, and/or Communication Control Unit, or perform programming and debugging, use the Sysmac Studio Automation Software as the integrated development environment.

CIP Safety on EtherNet/IP

A safety I/O terminal can be combined with a Communication Control Unit (NX-CSG□□□□) or a Machine Automation Unit (NX102-□□□□) and a Safety CPU Unit (NX-SL5□□□□) to construct a system using CIP Safety on EtherNet/IP communications onto a field network. CIP Safety communications are available between a safety I/O terminal supporting CIP Safety on EtherNet/IP and a Safety CPU Unit.

Standard-feature EtherNet/IP Communications Port

The Safety I/O Terminals I (GI-SMD1624 and GI-SID1224) provide an EtherNet/IP communications port. In addition to CIP Safety on EtherNet/IP, you can use tag data links and CIP message communications as a interface with the standard controllers.

Main Features of Input/Output & Test Output

Safety I/O devices can be used by being connected to the input, test output, and output terminals on a safety I/O terminal.

● Safety input

- You can connect safety input devices such as an emergency stop switch, door switch, and light curtain.
- It is possible to check for a short circuit in external wiring by using safety input terminals and test output terminals in combination.
- Either single channel or dual channel mode is available.
- Under the dual channel mode, a short circuit between two input terminal lines and discrepancy time for the signals can be detected.
The discrepancy time can be set in the range from 10 to 30000 ms.
- Delay time (OFF->ON / ON->OFF delay) can be set.

● Test output

- Making the "Test Output" setting will allow you to detect external short circuit of safety input.
- Making the "Power Supply" setting will allow you to use the power supply terminal (24 V) for input and output devices.
- Making the "Standard Output" setting will allow you to use it as a non-safety output.
- Making the "Muting Lamp" setting will allow you to use it as an output for detecting muting lamp disconnection. (Only T3 and T7 terminals are available for the purpose.)

● Safety output

- The safety output rating is up to 0.5 A.
- The dual channel mode allows detection of a short circuit between two output terminal lines and discrepancy in the signals.

1-1-2 System Configuration Overview

Described below are system configurations of safety network controllers and safety I/O terminals.

Basic Configuration

The basic configuration of a safety network controller include NX-series unit configuration, EtherNet/IP field network configuration, and the Support Software.

● NX-series Unit Configuration

- The Safety CPU Unit NX-SL5□□□, which is a type of NX-series unit, configures a safety network controller by being mounted on the CPU rack of the Communication Control Unit (NX-CSG□□□) or the Machine Automation Controller (NX102-□□□□).

● EtherNet/IP field network configuration

- Connection of the built-in EtherNet/IP port of the Communication Control Unit (NX-CSG□□□) or the Machine Automation Controller (NX102-□□□□) to the EtherNet/IP network allows communications with safety I/O terminals via CIP Safety on EtherNet/IP. You can also communicate with standard controllers via tag data links or CIP message communications at the same time.

For the system configuration which can be built with the Communication Control Unit, □ refer to *NX-series Safety Control Unit/Communication Control Unit User's Manual* (Cat. No. Z395)

- For an NX unit configuration which allows communications with safety I/O terminals via CIP Safety on EtherNet/IP, the Communication Control Unit (NX-CSG□□□) or the Machine Automation Controller (NX102-□□□□) can be selected. This manual hereafter uses the Communication Control Unit (NX-CSG□□□) to give an explanation.



Precautions for Correct Use

The safety I/O terminal cannot be connected to the EtherCAT port on the Machine Automation Controller (NX102-□□□□).

● Support Software

- Connect an Ethernet cable to the built-in EtherNet/IP port of the communication control unit.
- □ Refer to *Connection Method* on page 3-18 for details on the connection configuration of the Support Software.

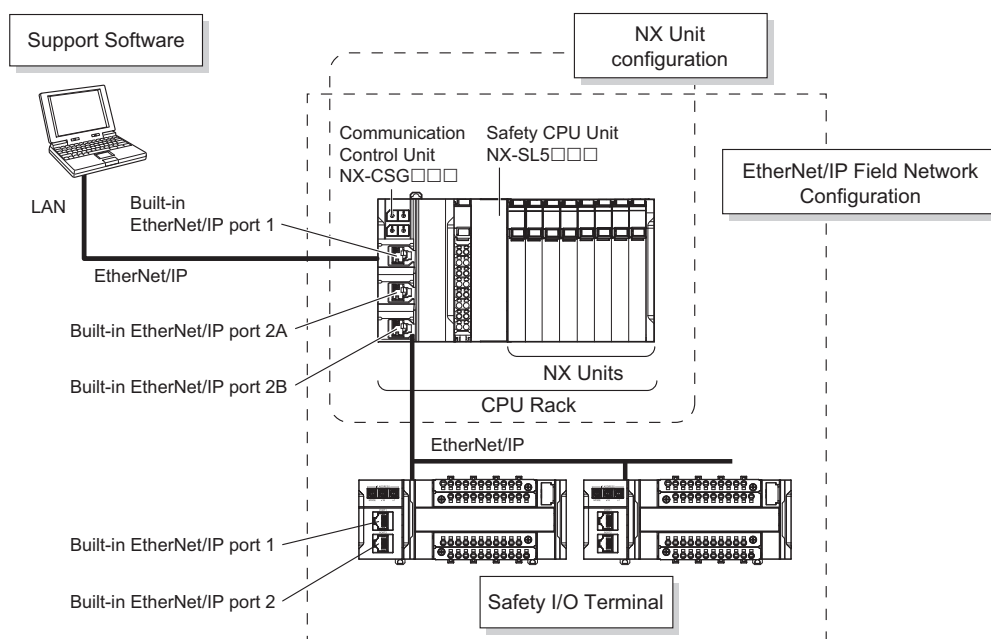

1-2 Procedure

1-2-1 Procedure Overview

You can construct a safety control system using the following procedure

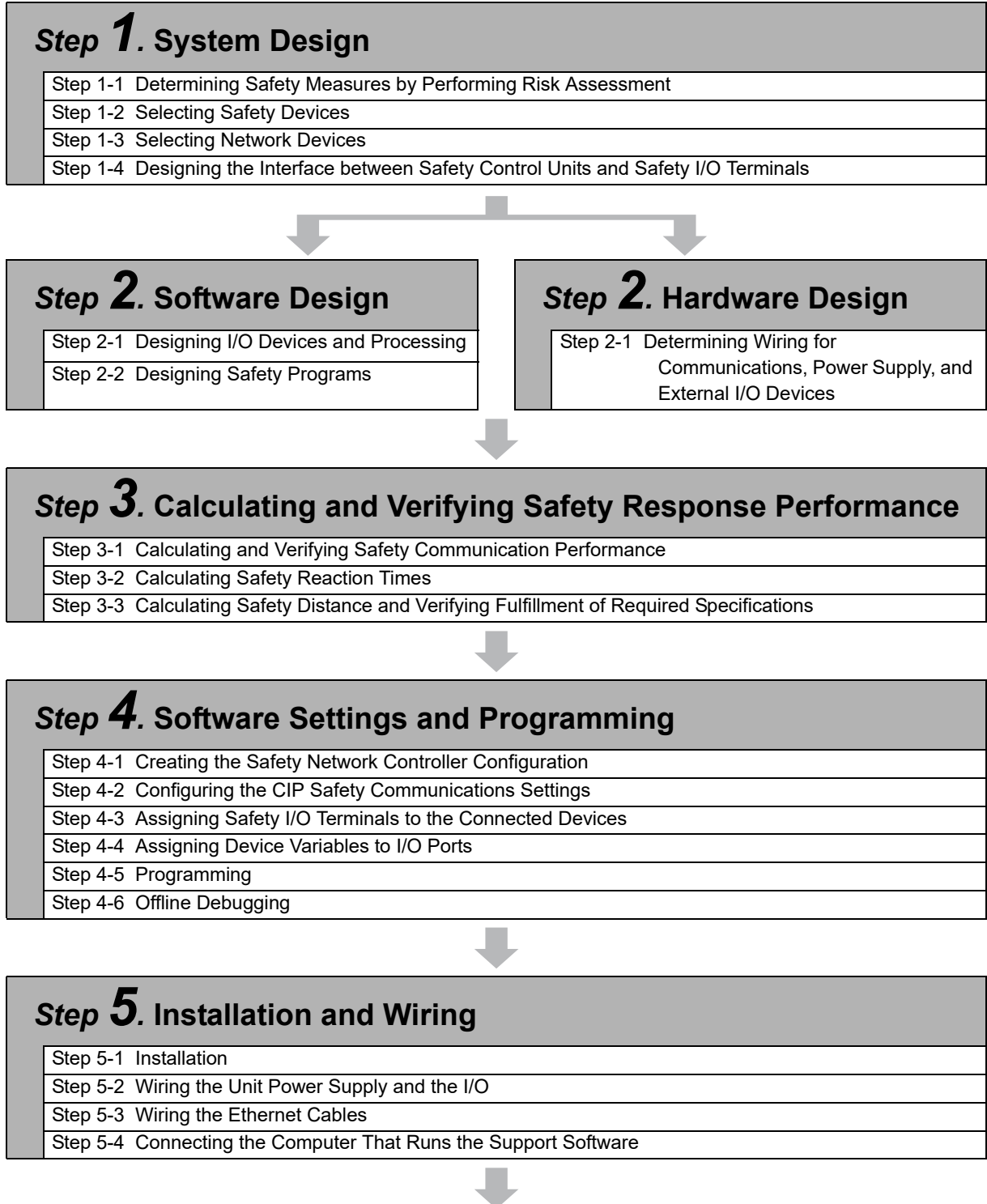

Step 6. Checking Operation

- | |
|---|
| Step 6-1 Transferring Data to the Controller |
| Step 6-2 Checking Operation Using the Controller |
| Step 6-3 Performing Safety Validation Testing |
| Step 6-4 Validating Safety from the Sysmac Studio |



Step 7. Operation, Maintenance, and Inspection

- | |
|---|
| Step 7-1 Operation |
| Step 7-2 Troubleshooting Errors If They Occur |
| Step 7-3 Inspection and Replacement |

1-2-2 Procedure Details

Step 1. System Design

Procedure	Description	Reference
Step 1-1 Determining Safety Measures by Performing Risk Assessment	<ul style="list-style-type: none"> Identify potential danger factors and perform risk assessment. Study and decide on measures to reduce risks. 	---
↓		
Step 1-2 Selecting Safety Devices	Select the safety devices for inputs, logic, and outputs of the safety controls.	<ul style="list-style-type: none"> ☐ <i>Section 2 System Configuration and Configuration Devices</i> on page 2-1 ☐ <i>Section 3 Specifications of Configuration Units</i> on page 3-1
↓		
Step 1-3 Selecting Network Devices	In consideration of the network bandwidth, select an Ethernet switch, a twisted-pair cable, and a connector to configure the Ethernet network.	☐ <i>4-2-6 Connecting the Built-in EtherNet/IP Port</i> on page 4-21
↓		
Step 1-4 Designing the Interface between Safety Control Units and Safety I/O Terminals	Design the interface between the safety control units and safety I/O terminals.	☐ Refer to <i>NX-series Safety Control Unit/Communication Control Unit User's Manual</i> (Cat. No. Z395)

Step 2. Software Design

Procedure	Description	Reference
Step 2-1 Designing I/O Device and Processing	Design the configuration of the I/O devices and I/O Units. <ul style="list-style-type: none"> • Safety I/O devices • Standard I/O devices • Program contents 	☐ 5-3 <i>Safety I/O Functions</i> on page 5-11







Step 2-2 Designing Safety Programs	Design the POUs (Program Organization Units). <ul style="list-style-type: none"> • Programs • Function blocks <p>Design of Variables:</p> <ul style="list-style-type: none"> • Design the data types of the variables (particularly the design of safety data types and standard data types). • Define the variables that you will use in more than one POU and variables that you will use in only specific POUs. • Define the variable names for the device variables that you use to access Safety I/O Units. • Define the attributes of variables, such as the Name attribute. • Design the variables to expose to other user program for the safety controls. <p>Design of Data Protection:</p> <ul style="list-style-type: none"> • Design POUs to protect and access restrictions. 	☐ Refer to <i>NX-series Safety Control Unit/Communication Control Unit User's Manual</i> (Cat. No. Z395)
---	---	--

Step 2. Hardware Design

Procedure	Description	Reference
Step 2-1 Determining Wiring for Communications, Power Supply, and External I/O Devices	Determine the wiring for the communications network, power supply, and safety I/O devices.	☐ <i>Section 3 Specifications of Configuration Units</i> on page 3-1 ☐ <i>4-2-1 Power Supply and Source Type</i> on page 4-14 ☐ <i>5-3 Safety I/O Functions</i> on page 5-11 ☐ <i>Section 4 Installation and Wiring</i> on page 4-1





Step 3. Calculating and Verifying Safety Response Performance

Procedure	Description	Reference
Step 3-1 Calculating Safety Communications Performance	Calculate safety task period, EPI and verify the bandwidth usage.	 <i>Section 7 Safety Reaction Time Calculation</i> on page 7-1
		
Step 3-2 Calculating Safety Reaction Times	Calculate the safety reaction time.	 <i>Section 7 Safety Reaction Time Calculation</i> on page 7-1
		
Step 3-3 Calculating Safety Distance and Verifying Fulfillment of Required Specifications	Calculate the safety distances from the safety reaction times. Check to see if the safety distances meet the requirements. If requirements are not met, reconsider the designs again starting with the system design.	---

Step 4. Software Settings and Programming

For the programming method,  refer to *NX-series Safety Control Unit/Communication Control Unit User's Manual* (Cat. No. Z395).

 Refer to *5-1-2 Introduction to Tag Data Links* on page 5-4 for Step 4-5 Configuring Tag Data Links.

Procedure	Description
Step 4-1 Creating the Safety Network Controller Configuration	On the Sysmac Studio, configure the Communication Control Unit, Safety CPU Units, Safety I/O Units, and the other NX Units.
	
Step 4-2 Configuring the CIP Safety Communications Settings	Configure the CIP Safety communications settings.
	
Step 4-3 Assigning Safety I/O Terminals to the Connected Devices	On the parameter setting page for the Safety I/O Terminals, select the safety I/O devices that are connected to the safety I/O terminals.
	
Step 4-4 Assigning Device Variables to I/O Ports	Register the device variables in the global variable table.
	

Step 4-5 Programming	<p>Variable Registration:</p> <ul style="list-style-type: none"> • Register the variables that are used by more than one POU in the global variable table with the Sysmac Studio. • Register the variables that are used in only a specific program in the local variable table for that program. • Register the variables that are used in only a specific function block in the local variable table for that function block. • Register tags and tag sets as needed, and configure the tag data link connection settings. <p>Writing Algorithms for POUs: Write the algorithms for the POUs (programs and function blocks) using the FBD language.</p>
↓	
Step 4-6 Offline Debugging	<p>The Simulator is used to debug the program.</p>

Step 5. Installation and Wiring

Procedure	Description	Reference
Step 5-1 Installation	<p>Mount the Units on a DIN Track and connect the Units to each other.</p>	<p>☞ <i>Section 4 Installation and Wiring</i> on page 4-1</p>
↓		
Step 5-2 Wiring the Unit Power Supply and the I/O	<p>Wire cables and connectors of the Safety I/O Terminal.</p>	<p>☞ <i>Section 4 Installation and Wiring</i> on page 4-1</p>
↓		
Step 5-3 Wiring the Ethernet Cables	<p>Connect the Safety I / O Terminal to the Ethernet Network.</p>	<p>☞ <i>Section 4 Installation and Wiring</i> on page 4-1</p>
↓		
Step 5-4 Connecting the Computer That Runs the Support Software	<p>Connect the Computer to the built-in Ethernet/IP port on the Communication Control Unit with an Ethernet cable.</p>	<p>☞ <i>2-3 Connecting to Support Software</i> on page 2-8</p> <p>☞ <i>Sysmac Studio Operation Manual</i> (Cat. No. W504)</p>

Step 6. Checking Operation

For the operation check method, ☐ refer to *NX-series Safety Control Unit/Communication Control Unit User's Manual* (Cat. No. Z395).

Procedure	Description	Reference
Step 6-1 Transferring Data to the Controller	Place the Sysmac Studio online with the Communication Control Unit and transfer the configuration information from a computer to the Controller. Next, configure the CIP Safety connection settings (TUNID settings) of the safety I/O terminal. Then, change the Safety CPU Unit to DEBUG mode from the Safety CPU Unit Setup and Programming View. This transfers the safety application data to the Safety CPU Unit and enables debugging.	☐ 6-4-2 CIP Safety Connection Settings on page 6-34
Step 6-2 Checking Operation Using the Controller	Check all wiring and the operation of the program to check that the Safety Control Unit operates as intended.	
Step 6-3 Performing Safety Validation Testing	Test all safety functions to see if they operate according to designs.	
Step 6-4 Validating Safety from Sysmac Studio	After the safety validation testing has been passed, execute the Safety Validation operation from the Sysmac Studio. This transfers the safety application data to the non-volatile memory in the Safety CPU Unit and enables operation.	

Step 7. Operation, Maintenance, and Inspection

Procedure	Description	Reference
Step 7-1 Operation	Restart the Safety CPU Unit. If the Safety CPU Unit has a validated user program, the Safety CPU Unit will automatically start in RUN mode.	☐ Refer to <i>NX-series Safety Control Unit/Communication Control Unit User's Manual</i> (Cat. No. Z395)
Step 7-2 Troubleshooting Errors If They Occur	If an error occurs, use the troubleshooting function of the Sysmac Studio to check the error and determine the cause. Then, remove the error.	☐ Section 8 Troubleshooting on page 8-1
Step 7-3 Inspection and Replacement	Perform periodic maintenance. If you find any defects or problems during the inspection, replace the affected devices.	☐ Section 9 Inspection and Maintenance on page 9-1

2

System Configuration and Configuration Devices

This chapter provides description of system configuration and components of a safety I/O terminal.

2-1 Basic Configuration	2-2
2-1-1 EtherNet/IP Field Network Configuration	2-2
2-1-2 Configuration Device	2-3
2-2 EtherNet/IP Network Connection Configurations	2-4
2-2-1 Star Topology	2-4
2-2-2 Daisy-Chain Topology	2-5
2-2-3 Combined Star and Daisy-Chain Topology	2-6
2-2-4 Ring Topology	2-7
2-3 Connecting to Support Software	2-8

2-1 Basic Configuration

This chapter describes the EtherNet/IP field network configuration that includes the safety I/O terminal, Safety CPU Unit, communication control unit, and standard controller.

2-1-1 EtherNet/IP Field Network Configuration

The EtherNet/IP field network configuration includes the originator devices (Communication Control Unit and Safety CPU Unit) and the target devices (safety I/O terminal and standard controller).

Connection of the built-in EtherNet/IP port of the communication control unit to the EtherNet/IP network allows communications with safety I/O terminals and standard controllers supporting CIP Safety on EtherNet/IP.

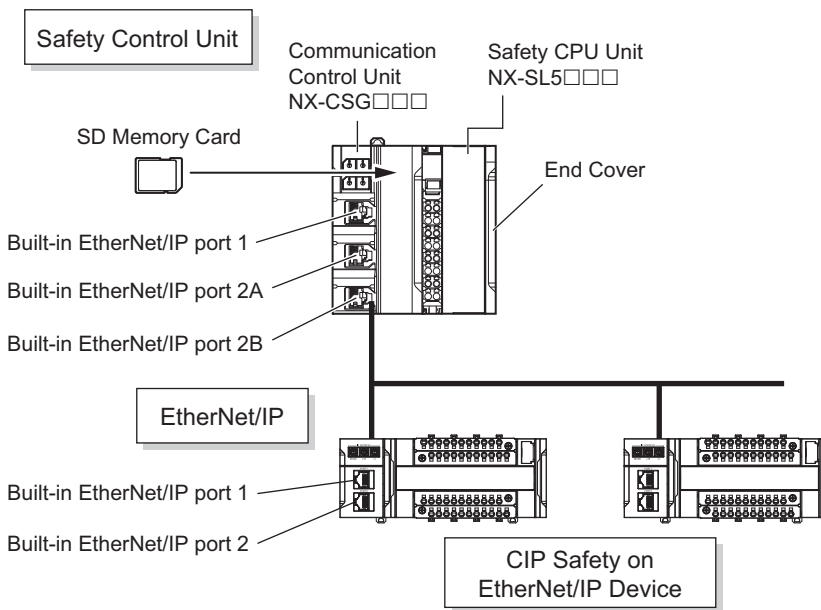

Configuration		Remarks
Originator device	Communication Control Unit NX-CSG□□□□	One unit is required on the CPU rack.
	Safety CPU Unit NX-SL5□□□□	One unit is required on the CPU rack
	Other unit	☐ Refer to <i>NX-series Safety Control Unit/Communication Control Unit User's Manual</i> (Cat. No. Z395) for details about other unit configuration.
Target device	Safety I/O Terminal GI-SMD1624/GI-SID1224	Connected to the EtherNet/IP network where the originator devices (Safety CPU Unit and Communication Control Unit) are connected.

2-1-2 Configuration Device

● Communication Control Unit

The unit includes the EtherNet/IP port to relay the safety I/O communications between the Safety CPU Unit and the safety I/O terminal. It also supports tag data link communications with standard controllers.

☐ Refer to *NX-series Safety Control Unit/Communication Control Unit User's Manual* (Cat. No. Z395) for the models and specifications of communication control units.

● Safety CPU Unit

This is an NX-series unit which serves as the center of control for a safety network controller, and the unit executes safety programs and safety process data communications.

For the models and specifications of the Safety CPU Unit, ☐ refer to *NX-series Safety Control Unit/Communication Control Unit User's Manual* (Cat. No. Z395)."

● Safety I/O Terminal

This is an I/O terminal supporting CIP Safety on EtherNet/IP, which performs safety I/O processing. The Safety CPU Unit performs safety control of the safety I/O terminal.

For the models and specifications of safety I/O terminals, ☐ refer to *3-1 Specifications* on page 3-2.

2-2 EtherNet/IP Network Connection Configurations

Combination of the NX-series Safety Control Unit and the NX-series Communication Control Unit allows you to construct a safety network system using CIP Safety on EtherNet/IP communications. You can also communicate with standard controllers via tag data links or CIP message communications at the same time.

Connection of the two built-in EtherNet/IP ports of the safety I/O terminal to the EtherNet/IP network allows you to build various connection configurations of networks.

2-2-1 Star Topology

This is used to connect multiple safety I/O terminals or other devices.

Even if you remove a network cable from a single safety I/O terminal or interrupt the power supply to it, communications between other safety I/O terminals and originator devices will not be affected.

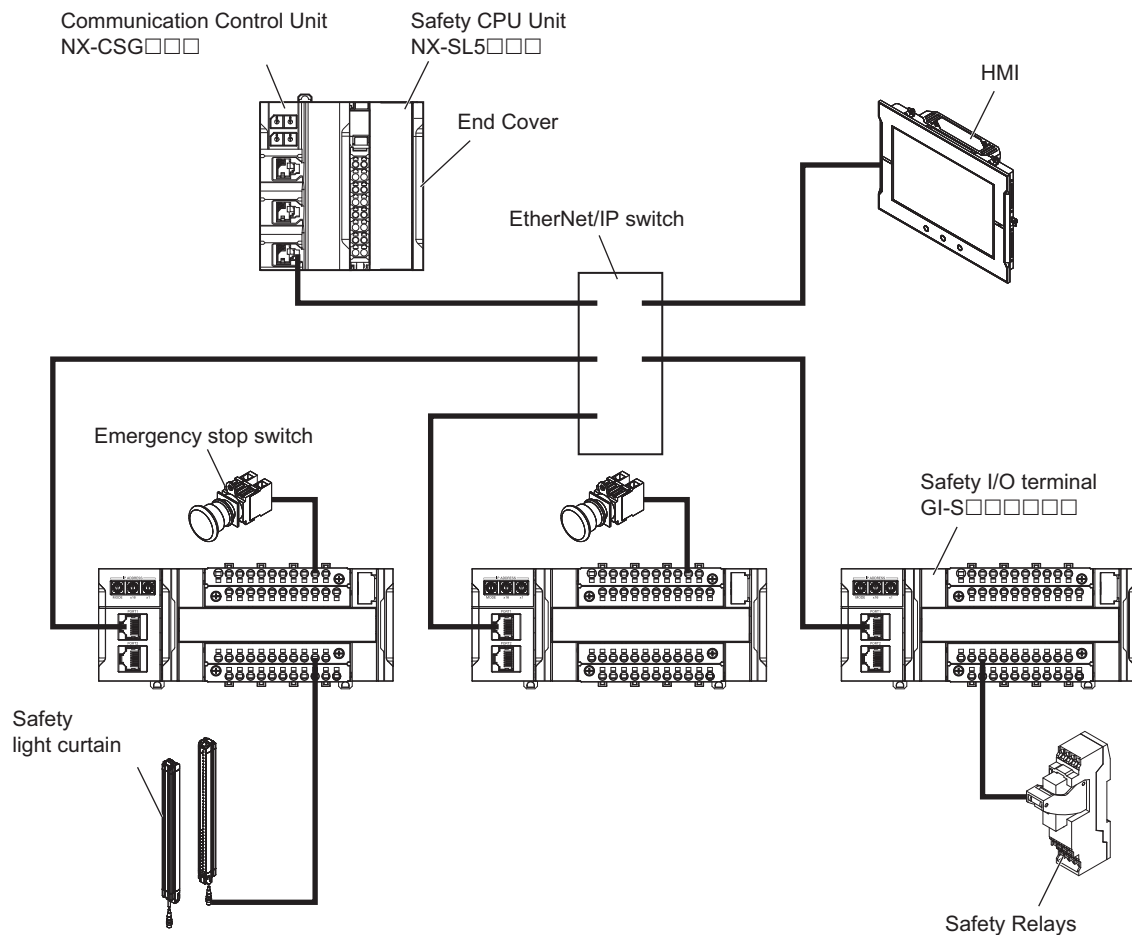

2-2-2 Daisy-Chain Topology

The daisy-chain topology allows you to easily connect many safety I/O terminals or daisy-chained additional devices.

It also allows connected external devices to be connected in series easily.

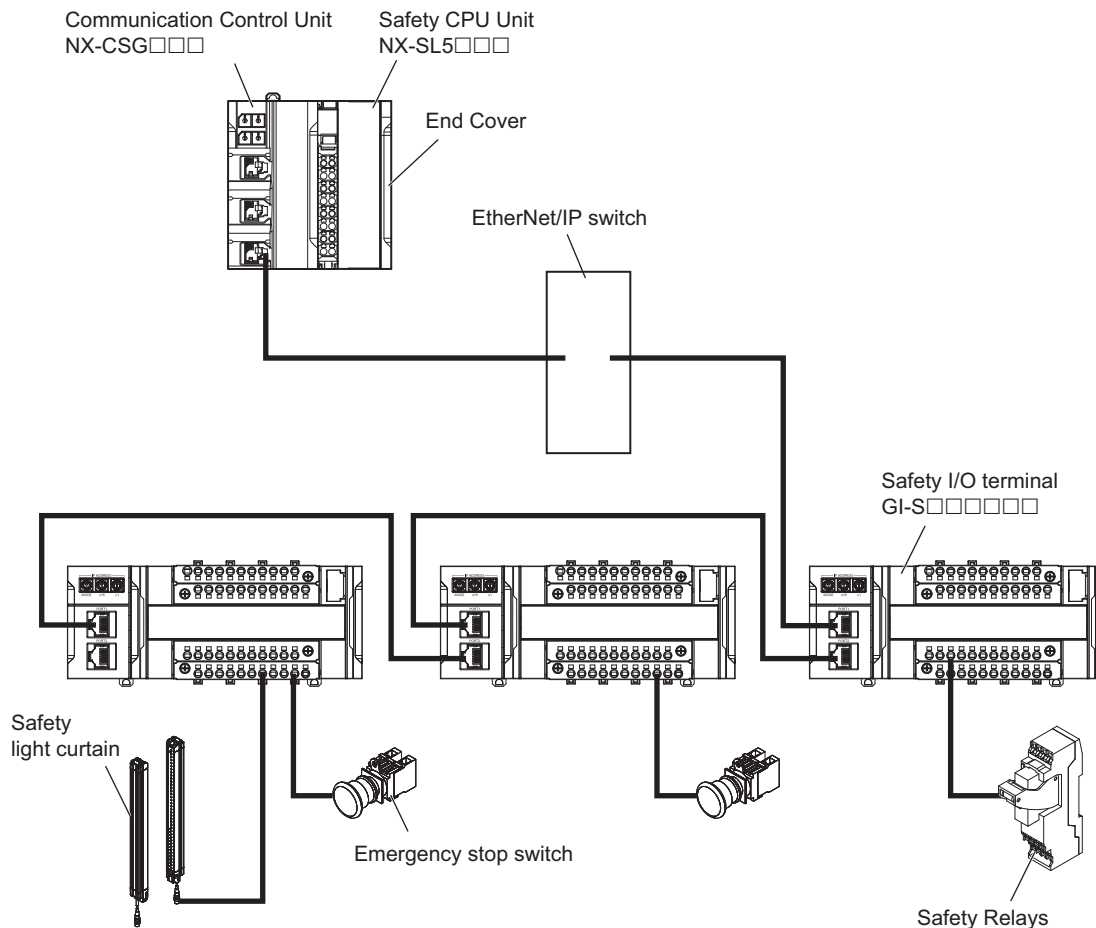

Precautions for Correct Use

Note the following when you use the daisy-chain topology.

- 1) If, during maintenance etc., you remove a network cable from a safety I/O terminal or interrupt the power supply to it, the operation of coupled safety I/O terminals will be affected.
- 2) It is not possible to connect an additional EtherNet/IP switch to between coupled safety I/O terminals.

2-2-3 Combined Star and Daisy-Chain Topology

The combined star and daisy-chain topology allows you to connect not only daisy-chained safety I/O terminals but also other safety I/O terminals and additional devices in a star topology.

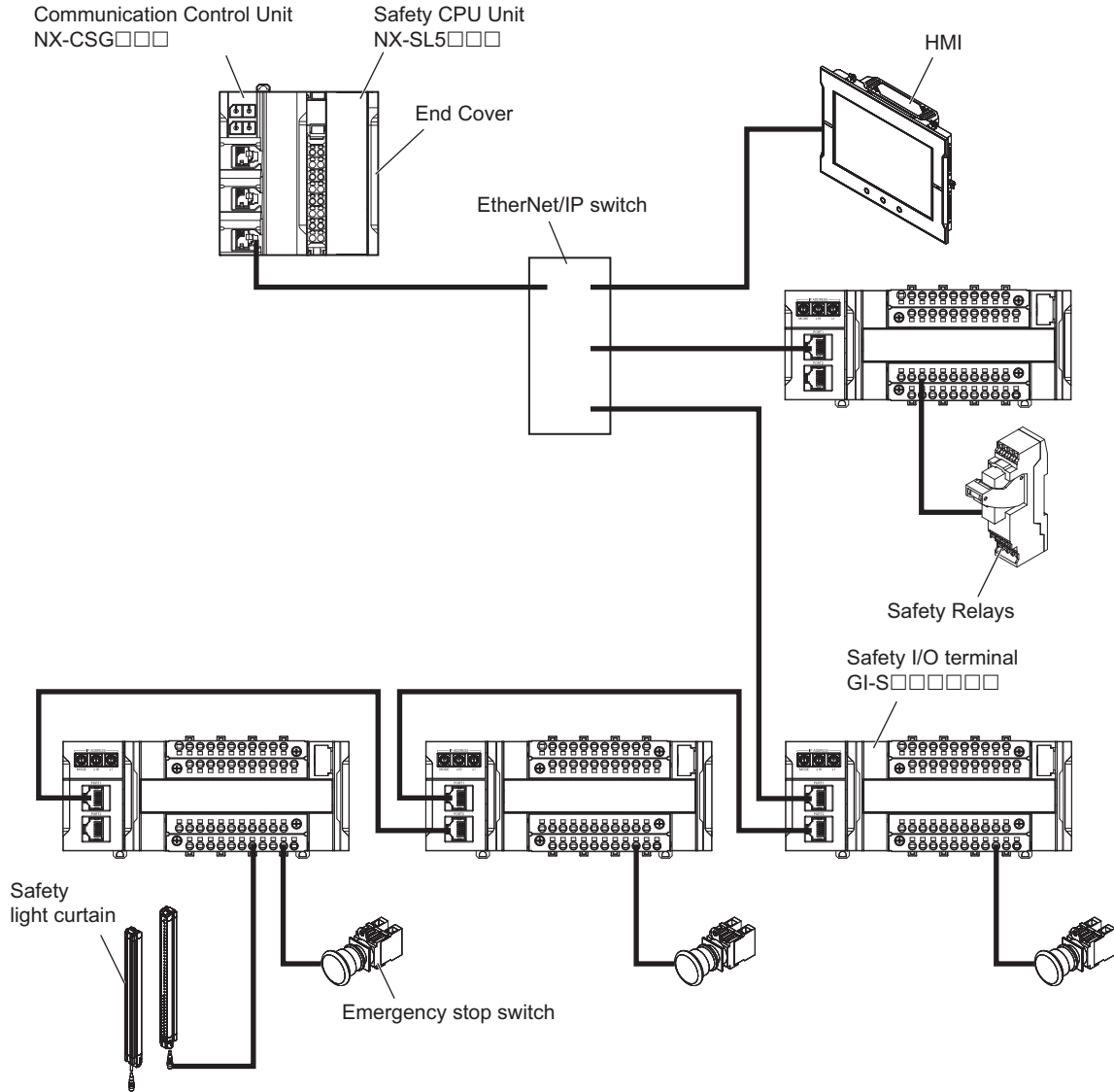

2-2-4 Ring Topology

The safety I/O terminal supports DLR (Device Level Ring). A ring connection is available using one or more ring supervisor and safety I/O terminal.

Communication can be continued even if one Ethernet cable is broken on the DLR network ring. For information on the specifications of the DLR network, refer to the user's manual of the ring supervisor.

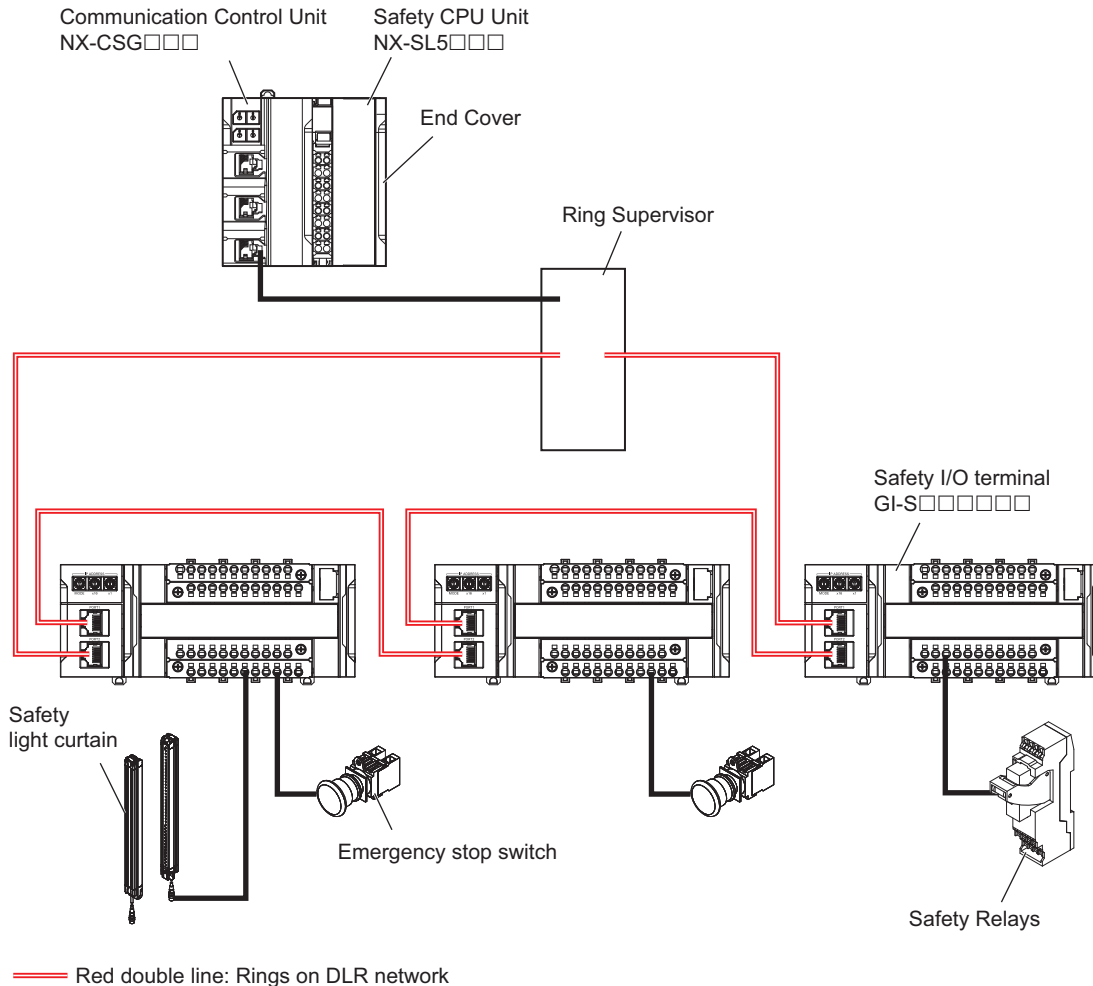

The following products are recommended for the ring supervisor.

Recommended ring supervisors

Manufacturer	Model
Rockwell Automation	1783-ETAP
Phoenix Contact	FL SWITCH 7008-EIP

2-3 Connecting to Support Software

The safety I/O terminal and Support Software must be connected via the built-in EtherNet/IP port of the communication control unit. □ Refer to *3-3-2 Connection Method* on page 3-18 for details on the connection with the safety I/O terminal and Support Software.

3

Specifications of Configuration Units

This section provides the specifications of the configuration units.

3-1 Specifications	3-2
3-1-1 Models and Specifications	3-2
3-1-2 Built-in EtherNet/IP port specifications	3-6
3-1-3 Component and Functions	3-7
3-1-4 Terminal Block	3-8
3-1-5 Indication Block	3-11
3-1-6 ID Information Indication	3-15
3-2 Memory Cassette	3-16
3-2-1 Outline	3-16
3-2-2 Use	3-16
3-3 Sysmac Studio	3-17
3-3-1 Product Type	3-17
3-3-2 Connection Method	3-18
3-4 PFH	3-19

3-1 Specifications

This section describes the models and specifications of the safety I/O terminal as well as the names and functions of the parts.

3-1-1 Models and Specifications

This section provides specifications of the safety I/O terminal.

Overall Specifications

This section describes the overall specifications of the safety I/O terminal.

Corresponding communication protocol	Number of connectors	Number of networks
EtherNet/IP	2	1 *1

*1. PORT1 and PORT2 are ports with switching hub.

General Specifications

This section describes the general specifications of the safety I/O terminal.

Item		Specification
Enclosure		Mounted in a panel (open type)
Operating environment	Ambient operating temperature	0 to 55°C
	Ambient operating humidity	10% to 95% (with no condensation or icing)
	Atmosphere	Must be free from corrosive gases
	Ambient storage temperature	-25 to 70°C (with no condensation or icing)
	Altitude	2,000 m max.
	Pollution degree	2
	Insulation class	CLASS III (SELV)
	Overvoltage category	II
	EMC immunity level	Zone B: IEC 61131-2
	Vibration resistance	Conforms to IEC 60068-2-6 5 to 8.4 Hz with amplitude of 3.5 mm 8.4 to 150 Hz, acceleration of 9.8 m/s ² 100 min. in each X, Y, and Z directions (10 sweeps of 10 min. each = 100 min. total)
	Shock resistance	Conforms to IEC 60068-2-27 147 m/s ² 3 times in each X, Y, and Z directions
Insulation resistance	20 MΩ between isolated circuits (at 100 VDC)	
Dielectric strength	500 VAC between isolated circuits for 1 minute at a leakage current of 10 mA max.	
Installation method		DIN Track mounting (IEC 60715 TH35-7.5/TH35-15)
Degree of protection		IP20

Individual Specifications

This section describes the individual specifications of the safety I/O terminal.

● Description of datasheet items of safety I/O terminal

Described below are meanings of datasheet items of safety I/O terminal.

Item	Spec	
Number of safety input points	The number of safety input points of the safety I/O terminal.	
Number of test output points	The number of test output points of this safety I/O terminal, used with a combination of safety input terminals.	
OMRON special safety input device	Indicates connectivity with OMRON special safety input devices (e.g. D40A non-contact door switch).	
LED indication	Types and layout of the LED Indications of this safety I/O terminal.	
Hardware switch setting	Types and layout of the hardware switches of this safety I/O terminal.	
Safety input type	Type of safety inputs of this safety I/O terminal (designated by IEC61131-2).	
Safety input current	Input current of this safety I/O terminal on its safety input under the normal rated voltage.	
Safety input ON voltage	Input voltage that turns ON the safety input of this safety I/O terminal.	
Safety input OFF voltage/OFF current	Input voltage and input current that turns ON the safety input of this safety I/O terminal.	
Safety output type	Polarity of the device to connect to this safety I/O terminal.	
Safety output rated current	Maximum load current for one safety output of this safety I/O terminal.	
Maximum total safety output current	Sum of maximum load current for safety output of this safety I/O terminal. The inrush current of an external load must be under this value.	
Safety output ON residual voltage	Residual voltage at safety output ON of this safety I/O terminal.	
Safety output OFF residual voltage	Residual voltage at safety output OFF of this safety I/O terminal.	
Safety output leakage current	Leakage current at safety output OFF of this safety I/O terminal.	
Test output type	Polarity of the device to connect to this safety I/O terminal.	
Test output rated current	Maximum load current for one test output of this safety I/O terminal.	
Maximum total test output current	Sum of maximum load current for test output of this safety I/O terminal.	
Test output ON residual voltage	Residual voltage at test output ON of this safety I/O terminal.	
Test output leakage current	Leakage current at test output OFF of this safety I/O terminal.	
External dimensions	External dimensions of this safety I/O terminal, indicated as W x H x D, in "mm" unit.	
Weight	Weight of this safety I/O terminal.	
Unit power supplies	Power supply voltage	Unit power supply voltage of this safety I/O terminal.
	Current consumption	Unit current consumption of this safety I/O terminal.
	Inrush current	Inrush current occurred upon power-on of the unit power supply.
	Power supply terminal current carrying capacity	Current carrying capacity of the unit power supply terminal (V0/G0) of this safety I/O terminal. This safety I/O terminal cannot supply power to external devices with the current larger than this value.
	Insulation type	Insulation type between the input circuit and internal circuit of this safety I/O terminal.
Output power supply	Power supply voltage	Output power supply voltage of this safety I/O terminal.
	Current consumption	Output power supply consumption current of this safety I/O terminal.
	Inrush current	Inrush current occurred upon power-on of the output power supply.
	Power supply terminal current carrying capacity	Current carrying capacity of the output power supply terminal (V1/G1) of this safety I/O terminal. This safety I/O terminal cannot supply power to external devices with the current larger than this value.
	Insulation type	Insulation type between the output circuit and internal circuit of this safety I/O terminal.
External connection terminal	Types of terminal blocks and connectors for wiring of this safety I/O terminal. The number of terminals is indicated for screwless clamp terminal block.	
Inter-terminal connection diagram	Connection diagram for this safety I/O terminal and external devices.	
Installation direction and restriction	Installation direction for this safety I/O terminal, as well as the restriction of the direction if it is restricted by the specification.	
Protective function	Protective function of this safety I/O terminal.	

● GI-SMD1624/GI-SID1224

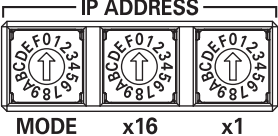
Item	Spec		
	GI-SMD1624	GI-SID1224	
Number of safety input points	12		
Number of safety output points	4	---	
Number of test output points	12		
OMRON special safety input device *1	Connection unavailable		
LED indication	[V0] LED, [IN□] LED x 12, [V1] LED, [OUT□] LED x 4, [MS] LED, [NS] LED, [PORT□ LINK] LED x 2	[V0] LED, [IN□] LED x 12, [V1] LED, [MS] LED, [NS] LED, [PORT□ LINK] LED x 2	
Hardware switch setting	[IP ADDRESS] switch x3 (MODE, x16, x1) <div style="text-align: center;">  <p>MODE x16 x1</p> </div> Factory setting GI-SMD1624: 192.168.250.2 [IP ADDRESS] switch = [002] GI-SID1224: 192.168.250.3 [IP ADDRESS] switch = [003]		
Safety input type	IEC61131-2 type3 Sinking inputs (PNP)		
Safety input current	6 mA max.		
Safety input ON voltage	11 VDC min.		
Safety input OFF voltage/OFF current	5 VDC max./1 mA max.		
Safety output type	Source output (for PNP)	*2	
Safety output rated current	0.5 A max.		
Maximum total safety output current	2.0 A		
Safety output ON residual voltage	1.2 V max. (between V1 and each output terminal)		
Safety output OFF residual voltage	2.0 V max. (between G1 and each output terminal)		
Safety output leakage current	0.1 mA max.		
Test output type	Source output (for PNP)		
Test output rated current	0.7 A max.		
Maximum total test output current	5.0 A		
Test output ON residual voltage	1.2 V max. (between V0 and each output terminal)		
Test output leakage current	0.1 mA max.		
External dimensions *3	170 (W) x 65 (H) x 55 (D)		
Weight	400 g		
Unit power supplies	Power supply voltage	24 VDC (20.4 to 28.8 VDC)	
	Current consumption	250 mA max.	
	Inrush current *4	On cold start at normal temperature 50 A max., 0.1 ms max.	
	Power supply terminal current carrying capacity *5	5 A	
	Insulation type	No insulation: Between unit power supply terminal and internal circuit	
Output power supply	Power supply voltage	24 VDC (20.4 to 28.8 VDC)	
	Current consumption	50 mA max.	
	Inrush current *4	On cold start at normal temperature 50 A max., 0.1 ms max.	
	Power supply terminal current carrying capacity *5	5 A	
	Insulation type	Photocoupler insulation	

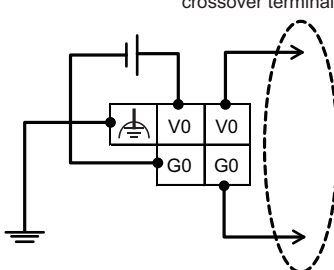
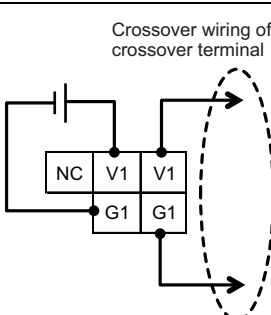
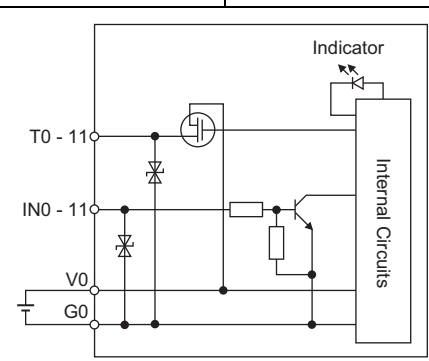
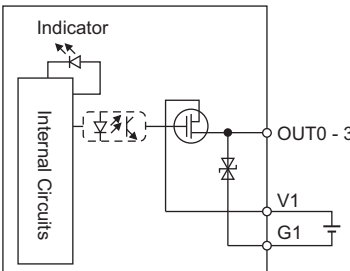
Item		Spec	
		GI-SMD1624	GI-SID1224
External connection terminal	Communication connector	EtherNet/IP communication RJ45 x 2	
	Screwless clamp terminal block	Top terminal block Functional earthing Unit power supply Input/Test output Bottom terminal block Output power supply Output/Input/Test output	Top terminal block Functional earthing Unit power supply Input/Test output Bottom terminal block Input/Test output
Inter-terminal connection diagram	V0/G0 Unit power supply	 <p>Crossover wiring of crossover terminal</p> <p>Unit power supply terminal (Top terminal block)</p>	
	V1/G1 Output power supply	 <p>Crossover wiring of crossover terminal</p> <p>Output power supply terminal (Bottom terminal block)</p>	*2
Circuit layout	Input circuit		
	Output circuit		*2
Installation direction and restriction		No restriction	
Protective function		Overvoltage protection, overcurrent protection	

- *1. OMRON special safety input devices are the following input devices:
 - Safety mat UMA/UM
 - Safety edge SGE
 - Single-beam safety sensor E3ZS
 - Non-contact door switch D40A/D40Z
- *2. GI-SID1224 has no output signal terminal and no output power supply is connected.
- *3. Projections are not included.
- *4. Inrush current when the supply power is turned ON from the static power-OFF state.
Inrush current value may vary depending on conditions. For your selection of fuses, breakers, and external power supply units, take into account the conditions to be used to select those that have a margin in characteristics and capacity.
- *5. Current-carrying capacity allowed to continuously flow through the terminal. This current must not be exceeded in case crossover wiring is done for the unit power supply.

3-1-2 Built-in EtherNet/IP port specifications

This section describes the built-in EtherNet/IP port specifications of the safety I/O terminal.

Item		Specifications	
		GI-SMD1624 / GI-SID1224	
Communications protocol		TCP/IP, UDP/IP	
Support services		Sysmac Studio connection, tag data links, CIP message communication, DHCP (client)	
Number of logical ports		1	
Physical layer		100BASE-TX	
Transmission specifications	Media access method	CSMA/CD	
	Modulation	Baseband	
	Transmission path	Star, daisy chain, mixed (star and daisy chain), ring (DLR)	
	Transmission rate	100M bit/s (100BASE-TX)	
	Transmission media	Twisted-pair cable (shielded: STP): category 5/5e or higher	
	Transmission distance	100m max. (distance between hub and node)	
Number of cascaded connections		50 nodes or less recommended	
CIP messaging service: Explicit message UCMM (non-connection type)		Maximum number of clients that can communicate simultaneously: 8/Logical ports	
Safety process data communications	Exclusive Owner (EO)	Input	1
		Output	1
Standard process data communications	Input Only	1 (Point to Point)	
	Listen Only	7 (Multi-Cast)	
EtherNet/IP conformance test		CT9 compliant	
Ethernet interface		100BASE-TX Auto Negotiation Auto-MDI	
DLR (Device Level Ring)		Ring Node (Beacon-based)	

3-1-3 Component and Functions

This section describes the names and functions of the parts of the safety I/O terminal.

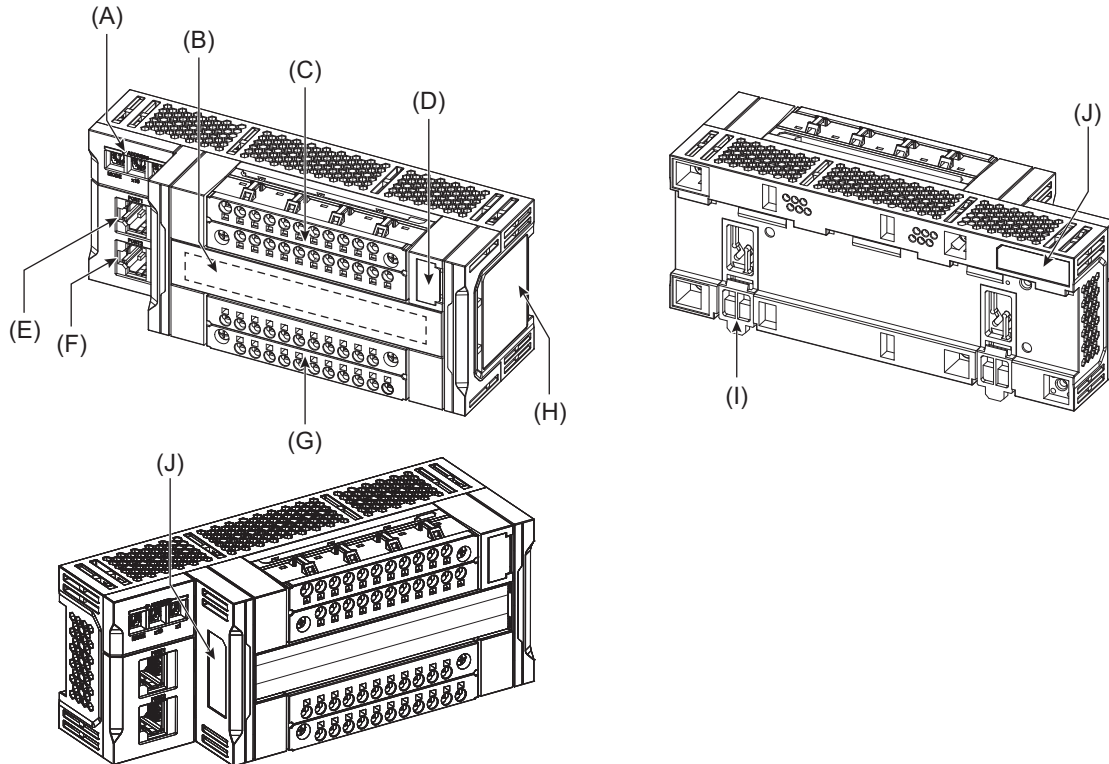

Symbol	Name	Description
A	Rotary switch	Used to set the mode switching and IP address of the built-in EtherNet/IP ports (PORT1/PORT2), in hexadecimal expression. For details, refer to <i>Built-in EtherNet/IP Port IP Address Settings</i> on page 6-26.
B	LED indicator	Shows the operation, signal, power supply and statuses of the safety I/O terminal itself by LED.
C	Top terminal block	Terminal block to connect unit power supply, earthing, and input devices.
D	Memory cassette slot	A memory cassette is set on delivery. The memory cassette allows a user to inherit the settings when replacing GI-S-series.
E	Built-in EtherNet/IP port (PORT1)	Connects the built-in EtherNet/IP with an Ethernet cable.
F	Built-in EtherNet/IP port (PORT2)	Connects the built-in EtherNet/IP with an Ethernet cable.
G	Bottom terminal block	Terminal block to connect output power supply and input/output devices.
H	Rating label	Shows the product information, standards marking, and ID information (lot number/unit version) of the safety I/O terminal.
I	DIN Track mounting hooks	These hooks are used to mount the Unit to a DIN Track.
J	ID information indication	Shows the ID information (MAC address) of the safety I/O terminal.

3-1-4 Terminal Block

Terminal blocks of the safety I/O terminal are screwless clamp type that allows easier connection and disconnection of wires.

There are top and bottom terminal blocks.

Connections to the screwless clamp terminal blocks include power supply, earthing, safety input devices, and safety output devices.

☐ Refer to 4-2 *Wiring* on page 4-14 for wiring details.

Names and functions of terminal block

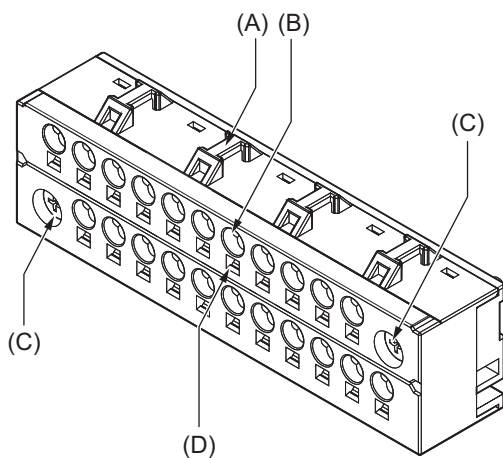

Symbol	Name	Description
A	Hole for securing wires	Pass a cable tie through this hole for securing the wires.
B	Terminal hole	The wire is inserted into this hole.
C	Screw for securing	Screw for securing the terminal block on the safety I/O terminal.
D	Release hole	Insert a flat-blade screwdriver into this hole to connect and remove the wire.

Top terminal block

● Terminal arrangement

Arrangement differs for safety I/O terminal models.

a) GI-SMD1624

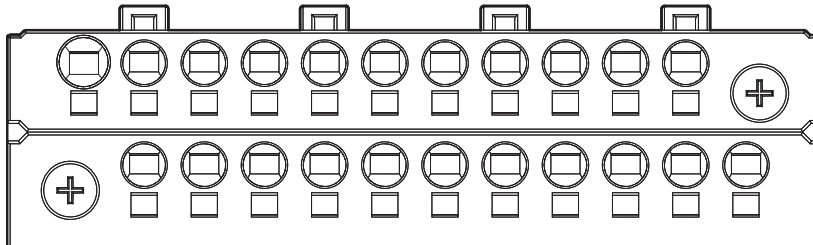

	V0	V0	IN0	IN1	IN2	IN3	IN4	IN5	IN6	IN7	
	G0	G0	T0	T1	T2	T3	T4	T5	T6	T7	NC

Symbol	Terminal name	Description	Reference
	Functional earthing	Functional earthing terminal to connect the earthing wire.	4-2-5 Earthing on page 4-20
V0, G0	Unit power supply terminal	Terminal to connect the safety I/O terminal's power supply and to supply power to external devices. Power supply 24VDC is connected to V0 and 0VDC to G0, respectively. V0 and G0 terminals are internally connected.	4-2-2 Unit Power Supply Wiring on page 4-16
IN0 - IN7	Input terminal	Terminal to connect a safety input device.	5-3-1 Safety Input Function on page 5-11
T0 - T7	Test output terminal	Terminal for test output.	5-3-1 Safety Input Function on page 5-11

b) GI-SID1224

The top terminal block is the same as a).

Bottom terminal block

● Terminal arrangement

Arrangement differs for safety I/O terminal models.

a) GI-SMD1624

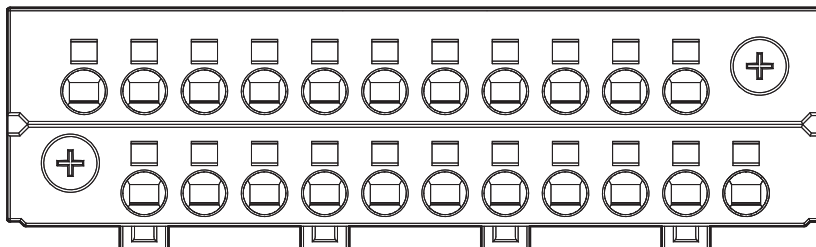

NC	V1	V1	G1	OUT0	OUT1	G1	IN8	IN9	IN10	IN11	
	G1	G1	G1	OUT2	OUT3	G1	T8	T9	T10	T11	NC

Symbol	Terminal name	Description	Reference
V1, G1	Output power supply terminal	Terminal to supply power to internal output control circuit and external devices. V1 and G1 terminals are internally connected.	☐ 4-2-2 Unit Power Supply Wiring on page 4-16
OUT0 - OUT3	Output terminal	Terminal to connect a safety output device.	☐ 5-3-2 Safety Output Function on page 5-25
IN8 - IN11	Input terminal	Terminal to connect a safety input device.	☐ 5-3-1 Safety Input Function on page 5-11
T8 - T11	Test output terminal	Terminal for test output.	☐ 5-3-1 Safety Input Function on page 5-11

b) GI-SID1224

The terminal block form is same as a).

NC	V1	V1	G1	NC	NC	G1	IN8	IN9	IN10	IN11	
	G1	G1	G1	NC	NC	G1	T8	T9	T10	T11	NC

Symbol	Terminal name	Description	Reference
V1, G1	Output power supply terminal	V1 and G1 terminals are internally connected. GI-SID1224 is not connected to an output device and must not be wired.	☐ 4-2-5 Earthing on page 4-20
NC	NC	Do not connect.	---
IN8 - IN11	Input terminal	Terminal to connect a safety input device.	☐ 5-3-1 Safety Input Function on page 5-11
T8 - T11	Test output terminal	Terminal for test output.	☐ 5-3-1 Safety Input Function on page 5-11

3-1-5 Indication Block

This section provides description of the indication block of the safety I/O terminal.

a) GI-SMD1624

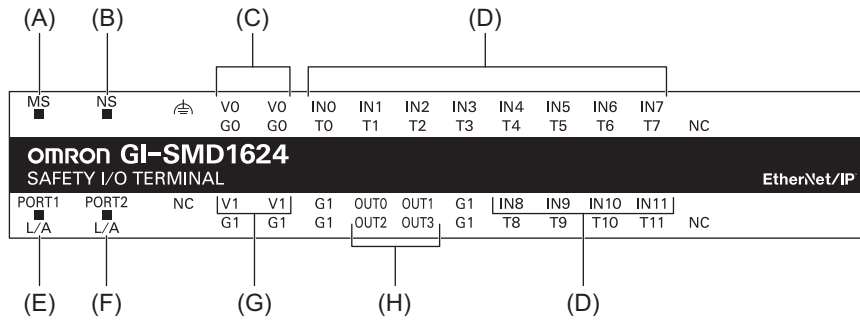

Symbol	Name	Description
A	Safety I/O terminal status indicator	Shows the operation status of this safety I/O terminal itself.
B	Network status indicator	Shows the EtherNet/IP network connection status of this safety I/O terminal.
C	Unit power supply indicators	Shows the unit power supply status of this safety I/O terminal.
D	Safety input status indicators	Shows the signal status of the safety input terminal.
E	Built-in EtherNet/IP status indicator (PORT1)	Indicates the communication status of the built-in EtherNet/IP port (PORT1).
F	Built-in EtherNet/IP status indicator (PORT2)	Indicates the communication status of the built-in EtherNet/IP port (PORT2).
G	Output power supply indicators	Shows the output power supply status by LED.
H	Safety output status indicators	Shows the signal status of the safety output terminal.

b) GI-SID1224

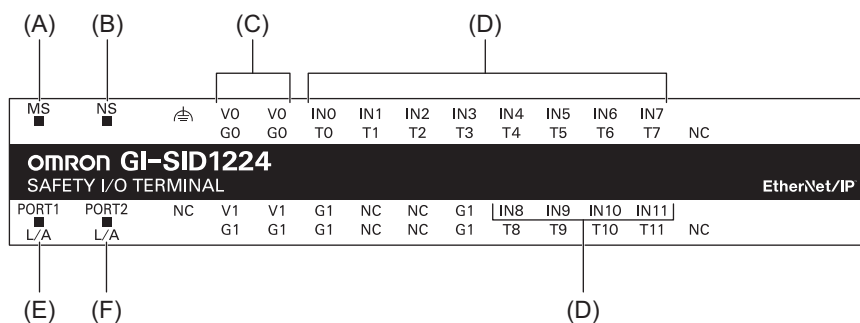

Symbol	Name	Description
A	Safety I/O terminal status indicator	Shows the operation status of this safety I/O terminal.
B	Network status indicator	Shows the EtherNet/IP network connection status of this safety I/O terminal.
C	Unit power supply indicators	Shows the unit power supply status of this safety I/O terminal.
D	Safety input status indicators	Shows the signal status of the safety input terminal.
E	Built-in EtherNet/IP status indicator (PORT1)	Indicates the communication status of the built-in EtherNet/IP port (PORT1).
F	Built-in EtherNet/IP status indicator (PORT2)	Indicates the communication status of the built-in EtherNet/IP port (PORT2).

Safety I/O terminal status indicator

WARNING

LEDs are NOT reliable indicators and cannot be guaranteed to provide accurate information. They should ONLY be used for general diagnostics during commissioning or troubleshooting. Do not attempt to use LEDs as operational indicators.









You can check the operation status of the I/O terminal by the module status indicator LED (MS LED) and network status indicator LED (NS LED).

☐ Refer to 8-1 *How to Check for Errors* on page 8-2 for details on the operation status of the I/O terminal.

● [MS] LED

The lamp status has the following meanings:







Color	State	Meanings
Green		Flashing Idle or standby state.
		Lit Running normally.
Red		Flashing An error was detected by self-test. Or A serious problem occurred such as a hardware failure. Turn the power OFF and ON again. If the problem cannot be solved by the power cycle, replace the unit.
		Lit A serious problem occurred such as a hardware failure. Turn the power OFF and ON again. If the problem cannot be solved by the power cycle, replace the unit.
Red/ Green		Flashing Either of the followings: - Under self-diagnosis - Setting or TUNID is incorrect, requiring you to set it again. - The memory cassette is not set.
---		Not lit Power is OFF or reset status.

Network status indicator

Shows the EtherNet/IP network connection status of this safety I/O terminal.
The following table describes the indicator.

● [NS] LED

The lamp status has the following meanings:

Color	State	Meanings
Green		Flashing CIP connection has not been established. (IDLE mode)
		Lit CIP connection has been established. (EXECUTING mode)
Red		Flashing Connection timeout occurred.
		Lit A communication error occurred.
Red/ Green		Flashing A specific communication error occurred. System restart is required.
---		Not lit Power is OFF or reset status.



Built-in EtherNet/IP status indicators (PORT1/PORT2)

Shows the communication status of the built-in EtherNet/IP ports (PORT1/PORT2) of the safety I/O terminal by LED.

The following table describes the indicator.

● [PORT1 L/A] LED / [PORT2 L/A] LED

The lamp status has the following meanings:

Color	State	Meanings
Green		Flashing Link has been established and data is being transmitted.
		Lit Link has been established.
---		Not lit Link has not been established. - Cable is not connected. - Power is OFF or reset status.



Unit power supply indicators

Shows the power supply status to the safety I/O terminal's unit power supply terminal by LED.

The following table describes the indicator.

● [V0] LED

The lamp status has the following meanings:

Color	State	Meanings
Green		Lit Unit power is supplied.
---		Not lit Unit power is not supplied.



Output power supply indicators

Shows the power supply status to the safety I/O terminal's output power supply terminal by LED.

The following table describes the indicator.

● [V1] LED *

The lamp status has the following meanings:

Color	State	Meanings
Green		Lit Output power is supplied.
---		Not lit Output power is not supplied.





* Applicable to GI-SMD1624 only.

Safety input status indicators

Shows the signal status of the safety input terminal.
The following table describes the indicator.

● [IN□] LED

The lamp status has the following meanings:





Color	State	Meanings
Yellow	 Lit	Safety input is ON without an error.
Red	 Flashing	An error occurred in the safety input circuit of the counterpart of the dual channel. or A serious failure occurred.
	 Lit	An error occurred in the safety input circuit. or A discrepancy time error occurred in the safety input of the dual channel.
---	 Not lit	Safety input terminal is OFF.

Safety output status indicators

Shows the signal output status of the safety output terminal.
The following table describes the indicator.

● [OUT□] LED ^{*1}

The lamp status has the following meanings:

Color	State	Meanings
Yellow	 Lit	Safety output is ON without an error.
Red	 Flashing	An error occurred in the safety output circuit of the counterpart of the adjacent two outputs ^{*2} . or A serious failure occurred
	 Lit	An error occurred in the safety output circuit. or Signals from originator devices for the two safety outputs of the dual channel differ.
---	 Not lit	Safety output is OFF.

*1. Applicable to GI-SMD1624 only.

*2. OUT0-OUT1 or OUT2-OUT3 should be a pair.

3-1-6 ID Information Indication

You can check the ID information of the safety I/O terminal on the rating label attached to the left side of the safety I/O terminal and the ID information indication on the right side.

● Rating label

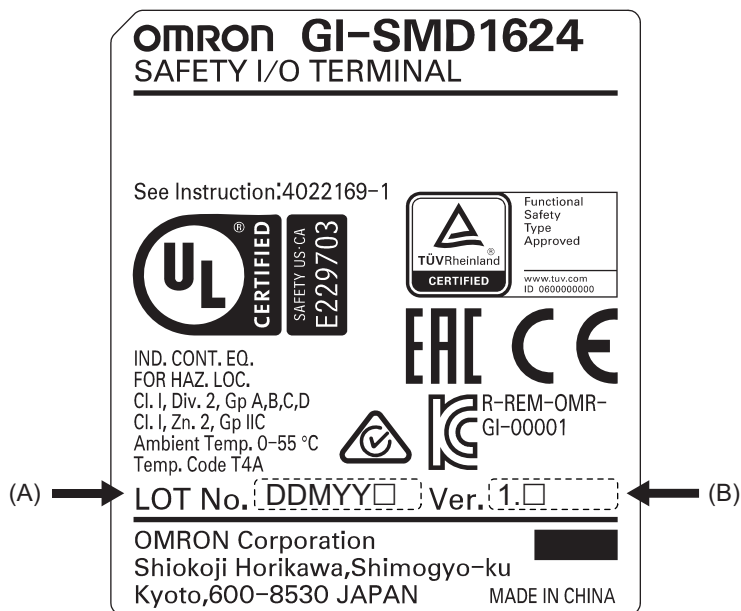

Symbol	Name	Description
A	Lot number	Shows the lot number of the Unit. DDMY: Lot number, □: Used by Omron, M is 1 to 9 for January to September, X for October, Y for November, and Z for December.
B	Unit version	Shows the unit version of the Unit.

● ID information indication

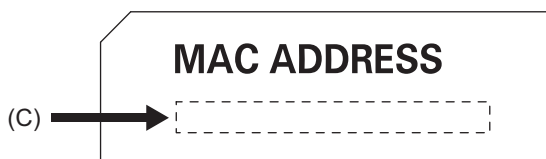

Symbol	Name	Description
C	MAC address	Shows the MAC addresses of the built-in EtherNet/IP ports (PORT1 and PORT2) on the CPU Unit.

3-2 Memory Cassette

This section describes the memory cassette.

3-2-1 Outline

The memory cassette can record the settings of the safety I/O terminal. By configuring TUNID setting, the same settings as the safety I/O terminal are stored in the memory cassette. The settings stored in the memory cassette are erased by performing a memory clear.

3-2-2 Use

It allows a user to inherit the settings by replacing a memory cassette when replacing a safety I/O terminal.

 Refer to *9-2-1 Replacing Safety I/O Terminal* on page 9-6 for details about GI-S-series replacement procedure.



Additional Information

To inherit the memory cassette settings, the new safety I/O unit for replacement must be in the default status. If you are not sure if it is in the default status or not, perform a memory clear on the new safety I/O terminal before replacement. Refer to *6-4-3 Memory Clear* on page 6-38 for detailed procedures.

3-3 Sysmac Studio

The Sysmac Studio is a Support Software package that provides an integrated development environment to design, program, debug, and maintain the safety I/O terminal.

This section describes the models and connecting methods of the Sysmac Studio.

3-3-1 Product Type

Sysmac Studio product consists of the DVD media and license.

When purchasing for the first time, you must purchase both DVD media and license. Each license has common media. When purchasing additionally, you can purchase license only.

The license version does not include the DVD media.

DVD media

Product	Media	Model
Sysmac Studio Standard Edition Ver.1.□□	DVD	SYSMAC-SE200D

Licenses

Product	Configuration software	Number of licenses	Model
Sysmac Studio Standard Edition *1 Ver.1.□□	Sysmac Studio The following Support Software is also included. Network Configurator CX-Integrator CX-Protocol CX-Designer CX-ConfiguratorFDT □□ Refer to the Sysmac Studio Version 1 Operation Manual (Cat. No. W504) for information on other software.	1	SYSMAC-SE201L
		3	SYSMAC-SE203L
		10	SYSMAC-SE210L
		30	SYSMAC-SE230L
		50	SYSMAC-SE250L
Sysmac Studio Safety Edition *2 Ver.1.□□		1	SYSMAC-FE001L

*1. You can design, program, debug, and maintain the NJ/NX-series Controllers and NY-series Industrial computers in addition to NX-series Safety Network Controllers.

*2. You can design, program, debug, and maintain NX-series Safety Network Controllers and EtherNet/IP Slave Terminals.

For the system requirements of the Sysmac Studio, □□ refer to *Sysmac Studio Version 1 Operation Manual* (Cat. No. W504).

3-3-2 Connection Method

Configuration

- **Connecting with EtherNet/IP**

You can configure settings of the safety I/O terminal via communication control unit NX-CSG□□□ with Safety CPU Unit NX-SL5□□□ connected. Refer to 6-4-1 *Setting the IP Address* on page 6-24 for details about connection between Sysmac Studio and safety I/O terminal.

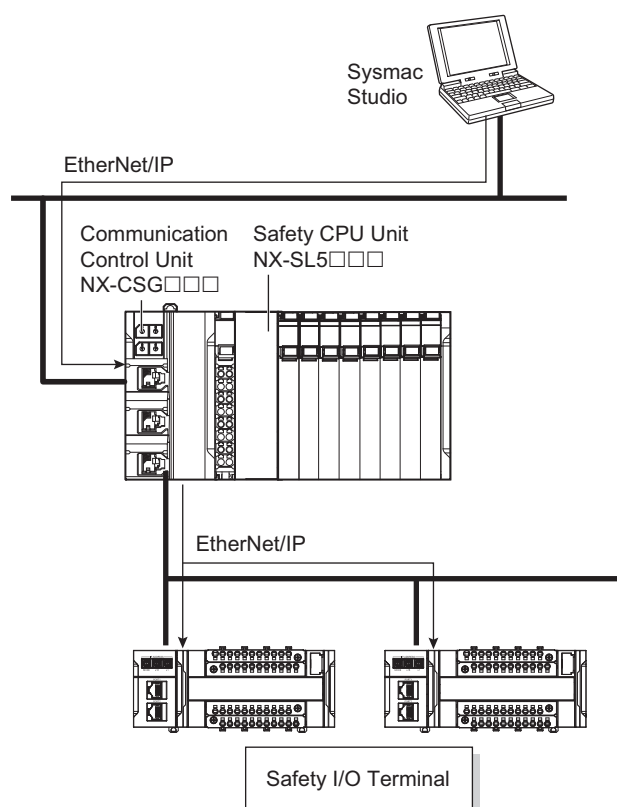

3-4 PFH

This section describes PFH of the safety I/O terminal.



Precautions for Correct Use

Go to the following URL for the most recent PFH values: http://www.ia.omron.com/support/sistemalibrary/index_jp.html



Additional Information

The safety I/O terminal is a Type B subsystem that is defined by IEC 61508 with HFT = 1 and SFF > 90%.

● Safety I/O terminal PFH

Model	PFH
GI-SMD1624	1.3E-9
GI-SID1224	8.5E-11

4

Installation and Wiring

This chapter describes how to install and wire the safety I/O terminal as well as details on installation locations.

4

4-1	Installing the I/O Terminal	4-2
4-1-1	Installation in a Control Panel	4-3
4-1-2	Preparations for Installation	4-6
4-1-3	Installing the Safety I/O Terminal	4-8
4-1-4	Mounting the End Plates	4-10
4-1-5	Removing the Safety I/O Terminal	4-11
4-1-6	Assembled Appearance and Dimensions	4-12
4-2	Wiring	4-14
4-2-1	Power Supply and Source Type	4-14
4-2-2	Unit Power Supply Wiring	4-16
4-2-3	Selecting Power Supplies	4-17
4-2-4	Selecting and Wiring Protective Equipment	4-18
4-2-5	Earthing	4-20
4-2-6	Connecting the Built-in EtherNet/IP Port	4-21
4-2-7	Wiring to the Terminal Block of the Safety I/O Terminal	4-29
4-2-8	Removing the Memory Cassette	4-40
4-3	Control Panel Installation	4-42
4-3-1	Temperature	4-42
4-3-2	Humidity	4-44
4-3-3	Vibration and Shock	4-44
4-3-4	Atmosphere	4-44
4-3-5	Electrical Environment	4-45
4-3-6	Earthing	4-49

4-1 Installing the I/O Terminal

WARNING

Required safety functions will be lost, and death due to injury may possibly occur. When building the system, observe the following warnings to ensure the integrity of the safety-related components.



Death due to injury may possibly occur.

Take appropriate and sufficient countermeasures during installation in the following locations.

- a) Locations near devices that produce strong, high-frequency noise
- b) Locations subject to static electricity or other forms of noise
- c) Locations subject to strong electromagnetic fields
- d) Locations subject to possible exposure to radioactivity
- e) Locations close to power lines



Precautions for Safe Use

- Do not drop any Unit or subject it to abnormal vibration or shock. Doing so may result in injury, Unit malfunction, or burning.
- Do not operate or store the Units in the following locations. Doing so may result in burning, in operation stopping, or in malfunction.
 - a) Locations subject to direct sunlight
 - b) Locations subject to temperatures or humidity outside the range specified in the specifications
 - c) Locations subject to condensation as the result of severe changes in temperature
 - d) Locations subject to corrosive or flammable gases
 - e) Locations subject to dust (especially iron dust) or salts
 - f) Locations subject to exposure to water, oil, or chemicals
 - g) Locations subject to shock or vibration
 - h) Locations subject to noise due to static electricity
- Install the Units in a well-ventilated area. Avoid installing the Units near heating elements. Doing so may result in malfunction, in operation stopping, or in burning.
- Follow the instructions in this manual to correctly perform wiring.
- Always turn OFF the power supply to the safety I/O terminal before you attempt any of the following.
 - 1) Assembling the Units
 - 2) Setting rotary switches
 - 3) Connecting cables or wiring the system
 - 4) Connecting or disconnecting the terminal blocks or connectors
 - 5) Attaching or removing the memory cassette

The Power Supply Unit may continue to supply power to the safety I/O terminal for a few seconds after the power supply turns OFF. The V0 indicator is lit during this time. Make sure that the V0 indicator is not lit before you perform any of the above operations.
- Use the GI-S Series in the enclosure complying with IP54 (IEC/EN 60529) or higher.
- In installing to the control panel, use DIN Tracks (TH35-7.5/TH35-15: IEC60715). In order to prevent drops due to vibration, fix the GI-S Series to the DIN Tracks using End Plates (sold separately).

4-1-1 Installation in a Control Panel

Installation in Cabinets or Control Panels

When the safety I/O terminal is being installed in a cabinet or control panel, be sure to provide proper ambient conditions as well as access for operation and maintenance.

● Temperature Control

Operating ambient temperature for the safety I/O terminal is from 0 to 55°C. When necessary, take the following steps to maintain the proper temperature.

- Provide enough space for good air flow.
- Do not install the product above equipment that generates a large amount of heat, such as heaters, transformers, or high-capacity resistors.
- If the ambient temperature exceeds 55°C, install a cooling fan or air conditioner.

● Accessibility for Operation and Maintenance

- To ensure safe access for operation and maintenance, separate the product as much as possible from high-voltage equipment and power machinery.
- It will be easy to operate the product if it is mounted at a height of 1.0 to 1.6m above the floor.

● Improving Noise Resistance

- Do not mount the product in a control panel containing high-voltage equipment.
- Install the product at least 200 mm away from power lines.

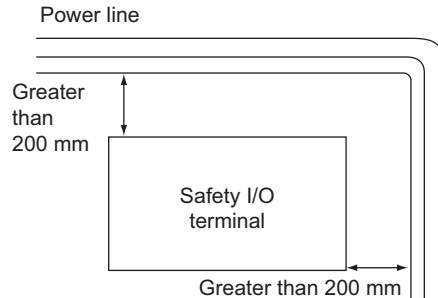

- Earth the mounting plate.

Installation Method in Control Panels

The product must be mounted inside a control panel on DIN Track.

Consider the width of wiring ducts, wiring, ventilation, and Unit replacement when determining the space between the safety I/O terminal and other devices.

There is no constraint on direction for mounting. You can install the product in any of the six directions shown below.

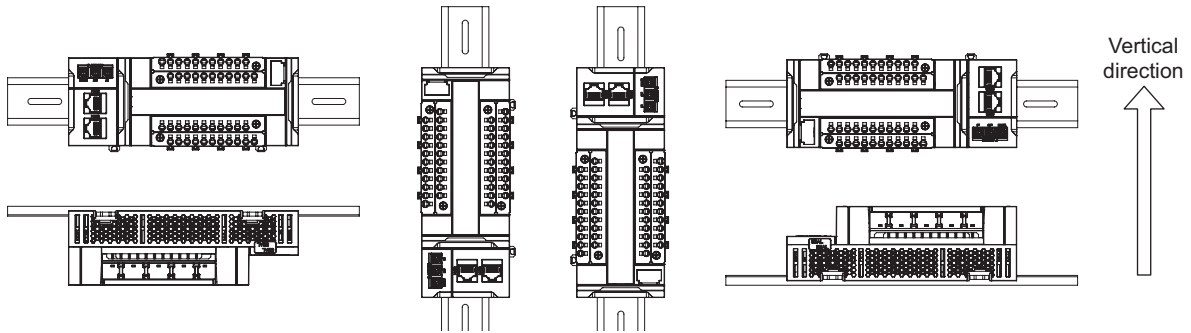

Additional Information

A Controller must be mounted on DIN Track.

It cannot be mounted with screws.

● Wiring Ducts

- Whenever possible, route I/O wiring through wiring ducts.
- Install mounting bracket for easier wiring through the duct. It is handy to have the duct at the same height as the CPU Rack.

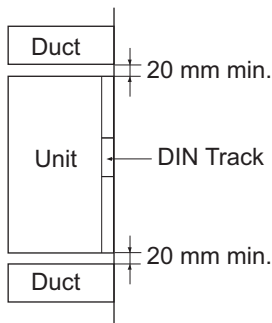

● Wiring Duct Example

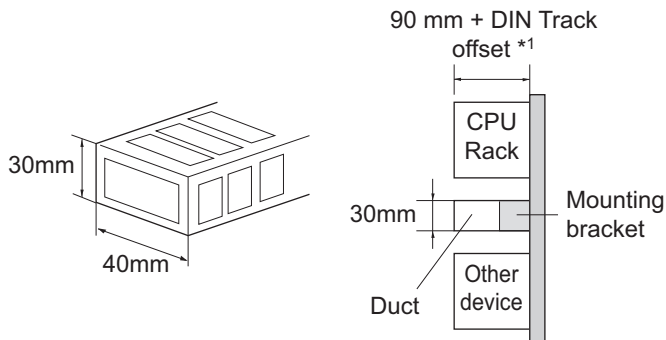

*1. It varies depending on the DIN Track to be used. Refer to *Installation Dimensions* under 4-1-6 *Assembled Appearance and Dimensions* on page 4-12 for details. It corresponds to the dimension (B).

● **Routing Wiring Ducts**

Install the wiring ducts at least 20 mm away from the tops of the Rack and any other objects (e.g., ceiling, wiring ducts, structural supports, devices, etc.) to provide enough space for air circulation and replacement of Units.

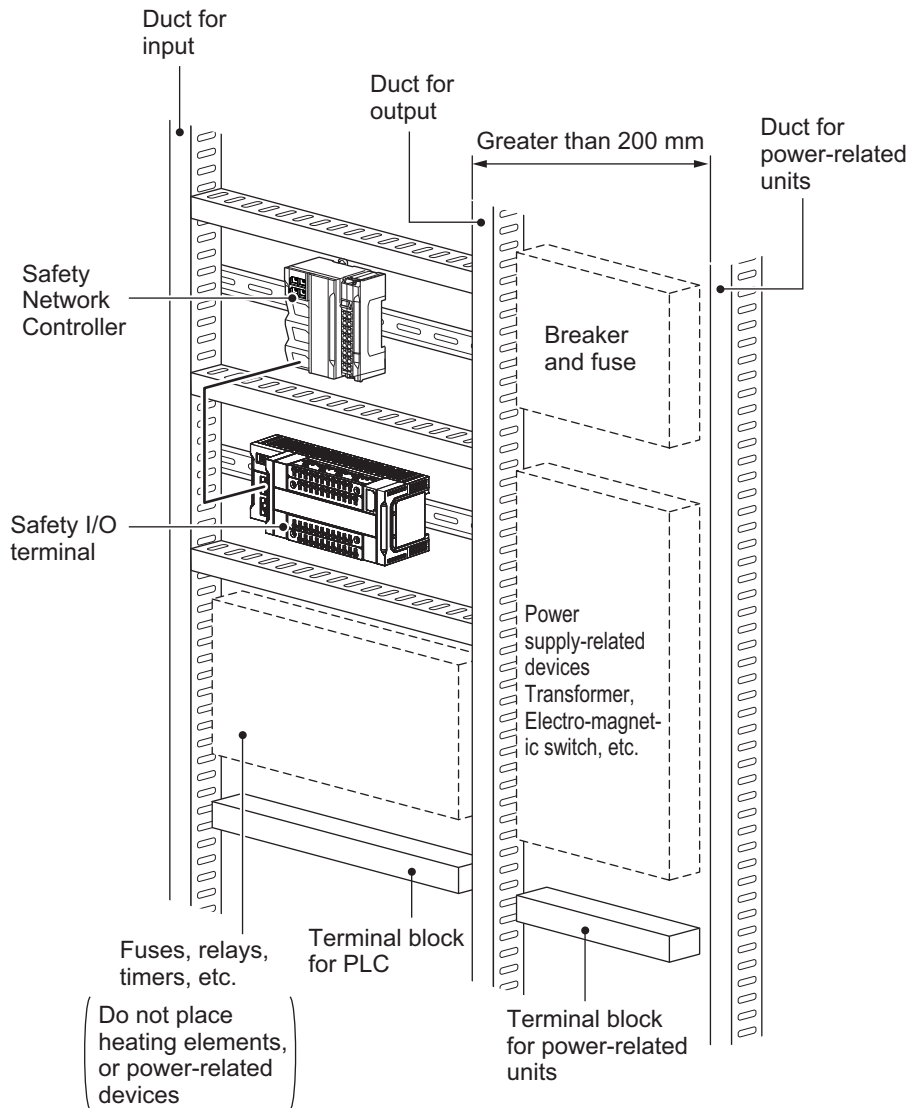

4-1-2 Preparations for Installation

We recommend using the following products to install the Unit on a DIN Track.

Name	Model	Manufacturer	Remarks
35-mm DIN Track	PFP-50N	OMRON Corporation	<ul style="list-style-type: none"> Length: 50 cm Material: Aluminum Surface treatment: Insulated
	PFP-100N	OMRON Corporation	<ul style="list-style-type: none"> Length: 100 cm Material: Aluminum Surface treatment: Insulated
	NS 35/7,5PERF	Phoenix Contact	<ul style="list-style-type: none"> Length: 75.5, 95.5, 115.5, or 200 cm Material: Steel Surface treatment: Conductive
	NS 35/15PERF	Phoenix Contact	<ul style="list-style-type: none"> Length: 75.5, 95.5, 115.5, or 200 cm Material: Steel Surface treatment: Conductive
End Plate	PFP-M	OMRON Corporation	Two End Plates are required for each safety I/O terminal.
	CLIPFIX 35	Phoenix Contact	Two End Plates are required for each safety I/O terminal.

Not all of the combinations of the DIN Tracks and End Plates listed above are possible.

Confirm applicability of the combinations in the following table.

DIN Track model	PFP-M (OMRON)	CLIPFIX 35 (Phoenix Contact)
PFP-50N	Possible	Possible
PFP-100N	Possible	Possible
NS 35/ 7,5 PERF	Possible	Possible
NS 35/ 15 PERF	Not possible	Possible

Also, use screws and washers of the following sizes to fix the DIN Tracks.

(a): Dimensions from the screw head to the fastening surface

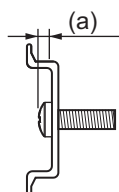

DIN Track model	Applicable screw size	(a)
PFP-50N	M4	4.1 mm max.
NS35/ 7,5 PERF	M6	4.6 mm max.
NS35/ 15 PERF	M6	10 mm max.

- If you use any DIN Track other than those listed in the table above, refer to the dimensions shown in *Installation Dimensions* on page 4-12 and use proper screws and washers.

● **DIN Track**

PFP-100N/50N

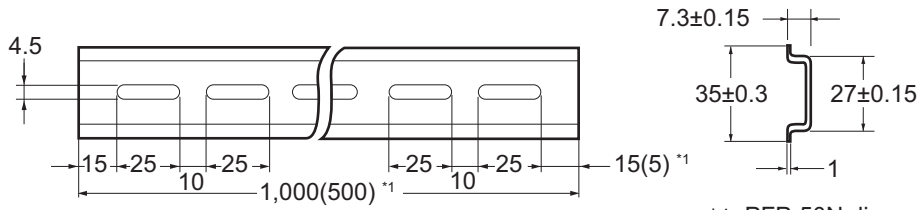

*1. PFP-50N dimensions are given in parentheses.

NS 35/7,5PERF

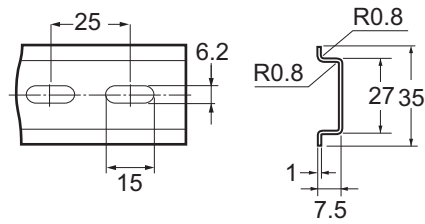

NS 35/15PERF

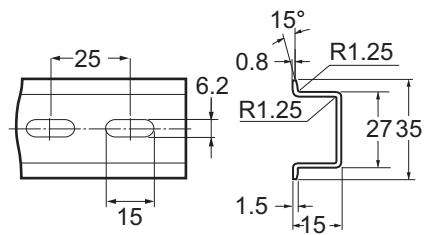

● **End Plate**

PFP-M (Two)

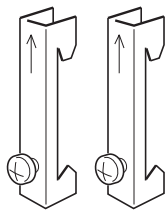

CLIPFIX 35 (Two)

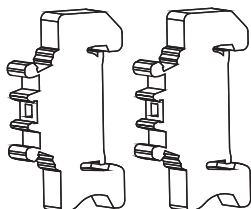

4-1-3 Installing the Safety I/O Terminal

1 Install the DIN Track.

- Using a PFP-50N/100N DIN Track

Use one M4 screw for each three holes in the DIN Track. There must be a screw for each interval of 105 mm or less. The screw tightening torque is 1.2 N•m.

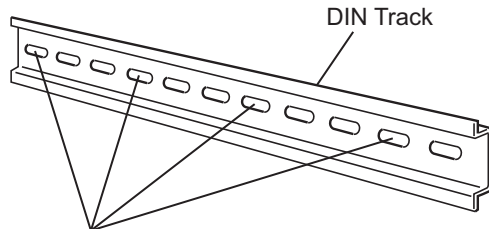

Use one screw for each three holes.

- Using an NS 35/7,5 PERF or NS 35/155 PERF DIN Track

Use one M6 screw for each four holes in the DIN Track. There must be a screw for each interval of 100 mm or less. The screw tightening torque is 5.2N•m.

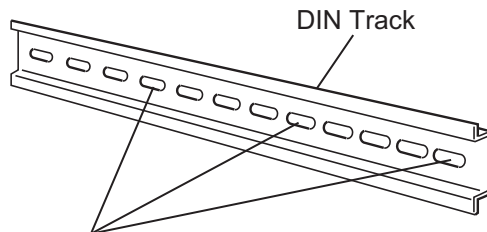

Use one screw for each four holes.

2 Make sure that the DIN Track mounting hooks on the safety I/O terminal are in the unlocked position.

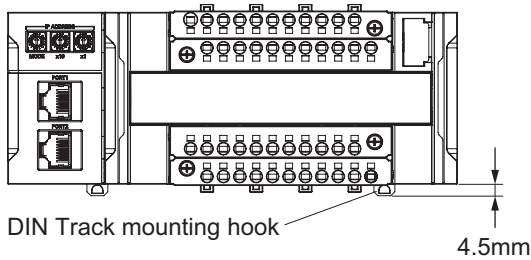

DIN Track mounting hook

Locked position of DIN Track mounting hook

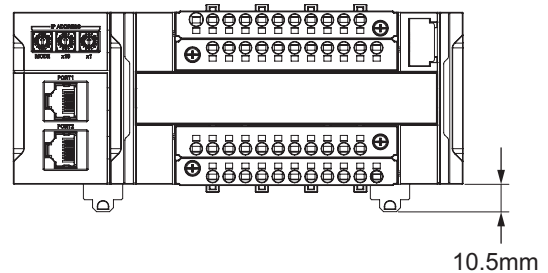

Unlocked position of DIN Track mounting hook

If the DIN Track mounting hooks are pulled up, they are in the unlocked position.

If the DIN Track mounting hooks are pressed down, they are in the locked position.

Use a flat-blade screwdriver to pull up the DIN Track mounting hook on the Unit to release the locked position.

- 3** Mount the safety I/O terminal on the DIN Track.
Hook the part 1 to the DIN Track, and push it in toward 2.

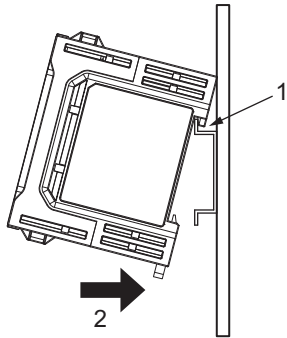

- 4** Press the DIN Track mounting hooks down to the locked position.
After you mount the safety I/O terminal, check to be sure that it is securely mounted on the DIN Track.

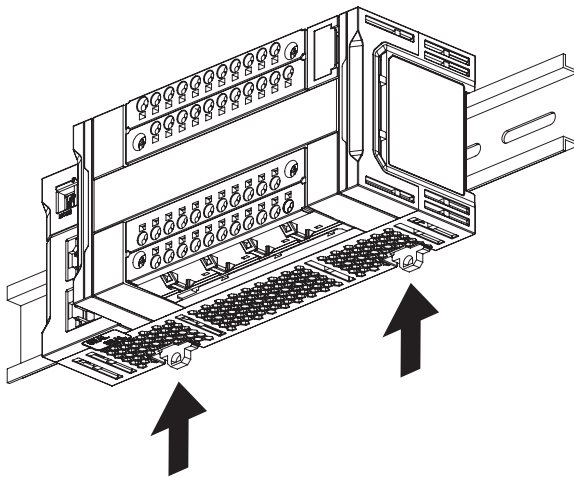

4-1-4 Mounting the End Plates

After you mount the safety I/O terminal, always secure the Unit with End Plates at both sides.



Precautions for Safe Use

In installing to the control panel, use DIN Tracks (TH35-7.5/TH35-15: IEC60715). In order to prevent drops due to vibration, fix the GI-S Series to the DIN Tracks using End Plates (sold separately).

● Using PFP-M (OMRON)

To mount an End Plate, 1) hook the bottom of it on the bottom of the DIN Track and 2) rotate the End Plate to hook the top of it on the top of the DIN Track.

Then tighten the screw to lock the End Plate in place.

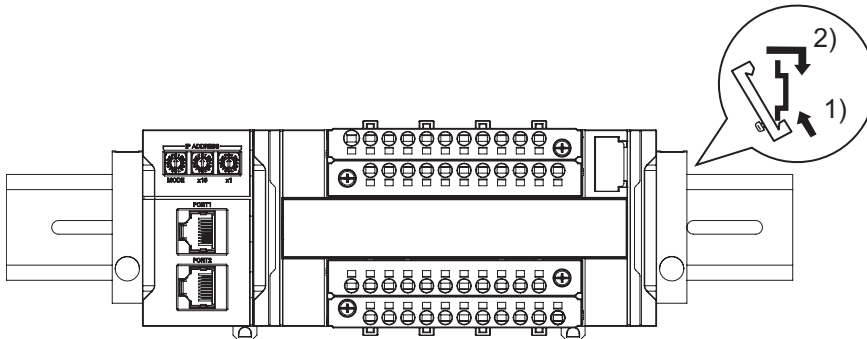

● Using CLIPFIX 35 (Phoenix Contact)

To mount an End Plate, 1) hook the top of it on the top of the DIN Track and 2) rotate the Plate to hook the bottom of it on the bottom of the DIN Track. Press in until you hear the End Plate lock into place.

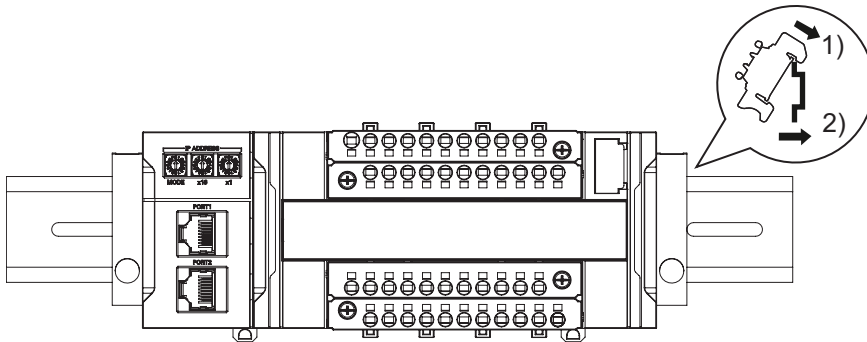

To remove an End Plate 1) insert the tip of a flat-blade screwdriver into groove "a" and 2) use "b" as a fulcrum and lift the end of the screwdriver, as shown in the following diagram.

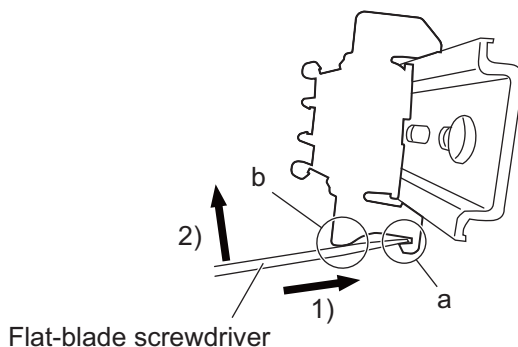

Flat-blade screwdriver

4-1-5 Removing the Safety I/O Terminal

This section provides description of removal of the safety I/O terminal.

- 1** Unlock the DIN Track mounting hook.

Use a flat-blade screwdriver to pull up the DIN Track mounting hook on the CPU Module to unlocked position.

At this point, be sure not to drop the safety I/O terminal.

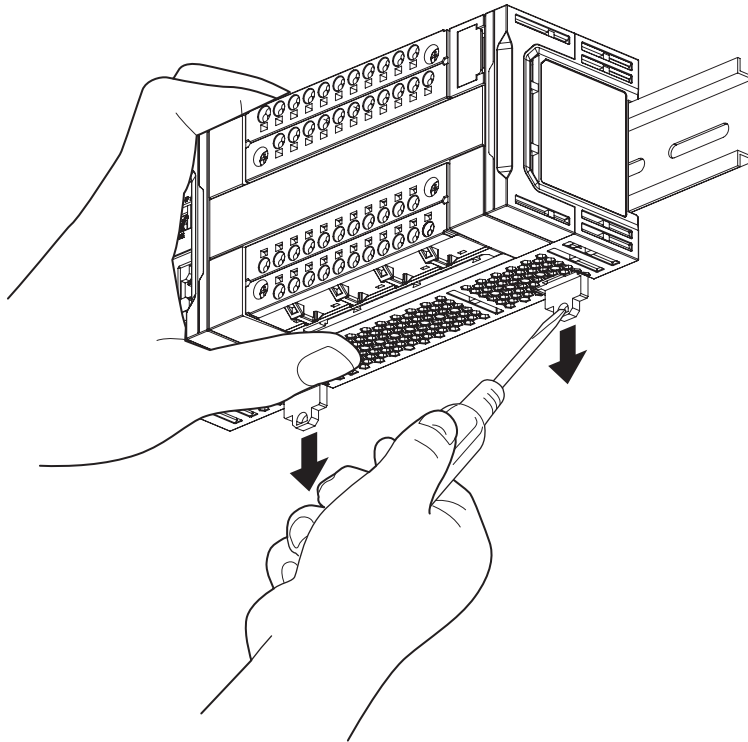

- 2** Remove the safety I/O terminal from the DIN Track.

Pull up the unit obliquely upward to remove it, being careful not to drop it.

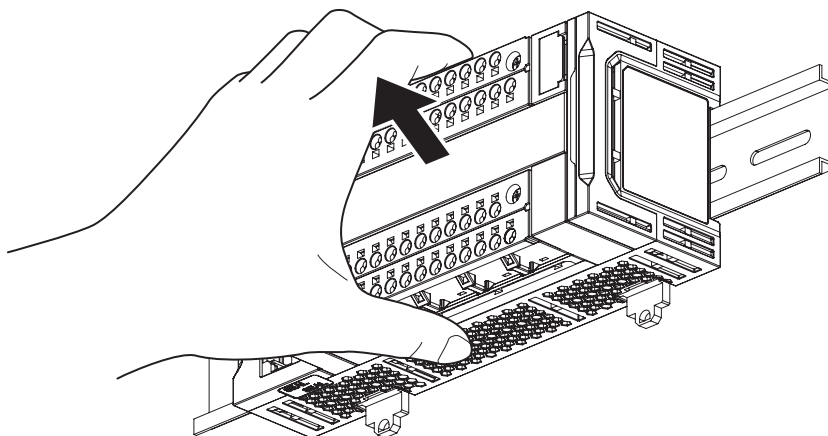

4-1-6 Assembled Appearance and Dimensions

Installation Dimensions

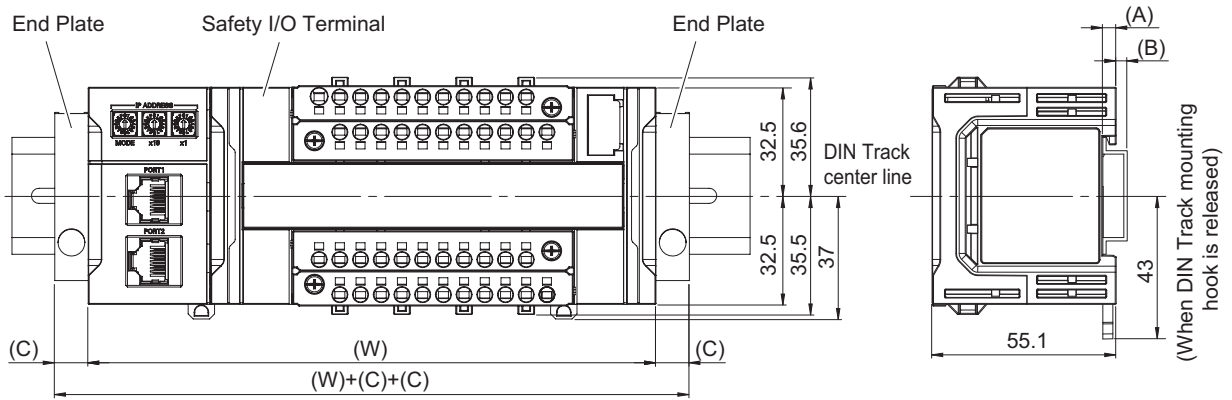

Unit: mm

- Safety I/O terminal width

Model	(W) Unit width
GI-SMD1624 / GI-SID1224	170 mm

- DIN Track dimension

DIN Track model	(A) DIN Track dimension	(B) Dimension from the back of the Unit to the back of the DIN Track
PFP-100N	7.3 mm	1.5 mm
PFP-50N	7.3 mm	1.5 mm
NS 35/7,5 PERF	7.5 mm	1.7 mm
NS 35/15 PERF	15 mm	9.2 mm

- End Plate dimension

End Plate model	(C) End Plate dimension
PFP-M	10 mm
CLIPFIX 35	9.5 mm

Installation Height

The installation height for the safety I/O terminal depends on DIN Track type as well as NX Unit to connect.

Also, the safety I/O terminal may require more installation space depending on the cable to connect to it. Allow sufficient depth in the control panel containing the terminal.

The following figure shows the dimensions from the cables connected to the safety I/O terminal to the back of the Unit. The unit of dimension is millimeter.

Refer to *Installation Dimensions* on page 4-12 for the height of individual DIN Track type.

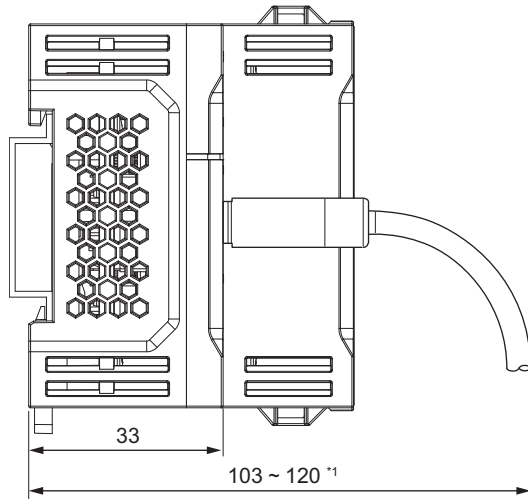

Unit: mm

*1. This is the dimension from the back of the Unit to the communications cables.

Approx. 103 mm: When an MPS588-C Connector is used.

Approx. 120 mm: When an XS6G-T421-1 Connector is used.



Precautions for Safe Use

Do not bend or pull a cable forcibly. Do not place any heavy objects on the cable. Doing so may break the cable.

4-2 Wiring

CAUTION

The loose screws might result in fire or malfunction.
Tighten terminal block fixing screws to the torques specified in this manual.



There might be a fear of moderate burns.
Do not touch devices while power is supplied or immediately after the power supply is turned OFF.



Precautions for Safe Use

- Follow the instructions in this manual to correctly perform wiring.
- Use the methods that are specified in this manual for wiring the terminal blocks.
- Use the correct wire size, wiring parts and tools when you wire the system. Otherwise, cables may be disconnected to cause short-circuit or wire breakage.
- When you install wiring, be sure to turn off the power beforehand. Otherwise, the external devices connected with the GI-S Series may operate unexpectedly.
- Make sure that foreign matters and metal dust should not come into the safety I/O terminal during wiring and/or installation. Doing so may result in Unit burning, electric shock, or failure.

4-2-1 Power Supply and Source Type

Power Supply Configuration

Shown below is the power supply configuration of the safety I/O terminal.

- GI-SMD1624

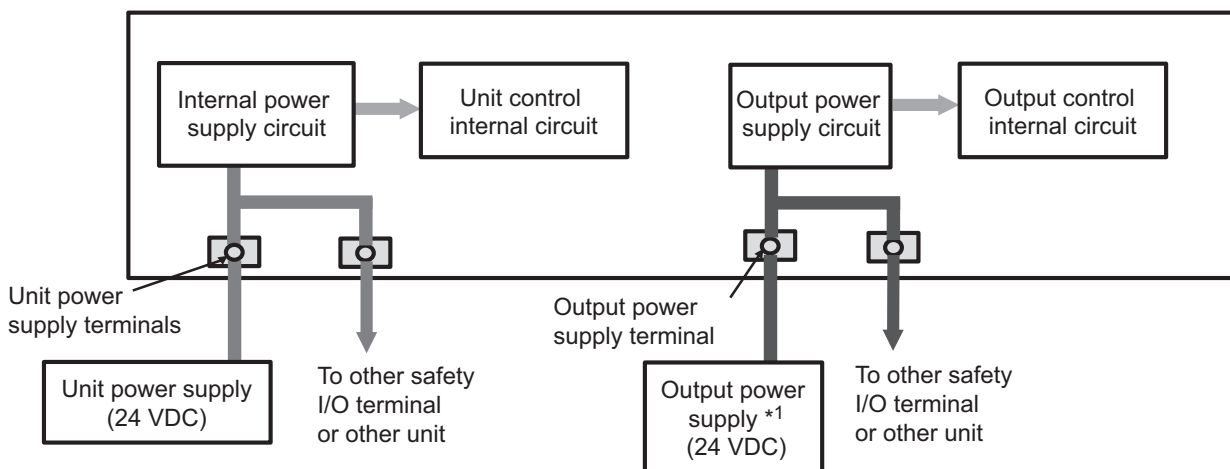

- GI-SID1224*1

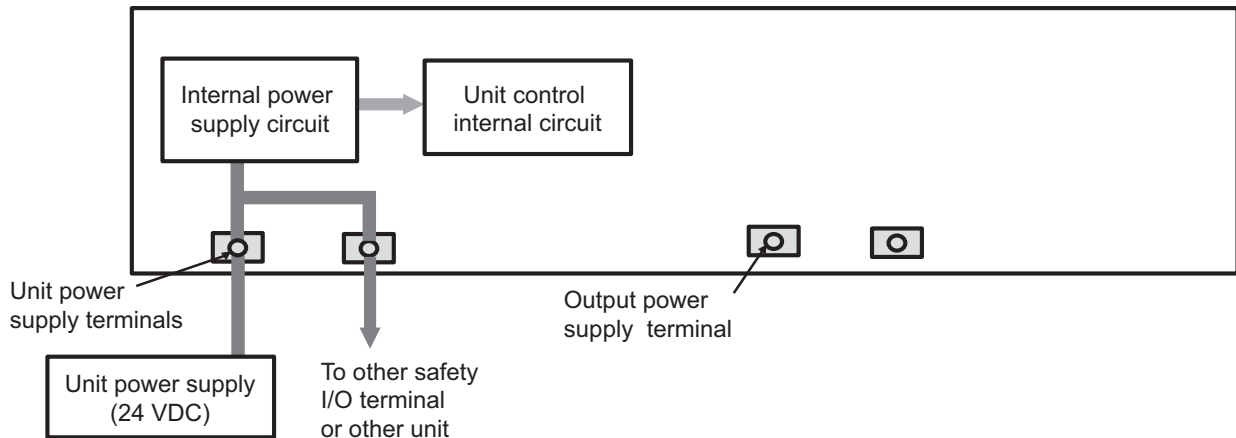

*1.GI-SID1224 has no output control circuit and no output power supply nor output device can be connected.

Power Supply Types

There are two (2) types of power source for GI-SMD1624/GI-SID1224 as shown below.

Power supply types	Description
Unit power supplies	<p>Power supply for internal circuit required for safety I/O terminal operation.</p> <p>It is connected to the unit power supply terminals (V0, G0) of the safety I/O terminal. V0 and G0 terminals are internally connected respectively.</p> <p>The internal power supply circuit of the safety I/O terminal generates the power supply for unit control internal circuit from the unit power supply.</p>
Output power supply	<p>Power supply for output control circuit of the safety I/O terminal.</p> <p>It is connected to the output power supply terminals (V1, G1) of the safety I/O terminal. V1 and G1 terminals are internally connected respectively.</p> <p>The output power supply circuit of the safety I/O terminal generates the power supply for output control circuit from the output power supply.</p>

GI-SMD1624 requires the unit power supply and output power supply. Use two individual power supplies for the unit power supply and output power supply.

GI-SID1224 requires the unit power supply. As it has no safety output circuit, the output power supply terminals (V1, G1) must not be wired.

4-2-2 Unit Power Supply Wiring

Shown below are the power supply wirings to the power supply terminals of the safety I/O terminal. The G0 and G1 terminals are isolated inside the unit.

● Top terminal block

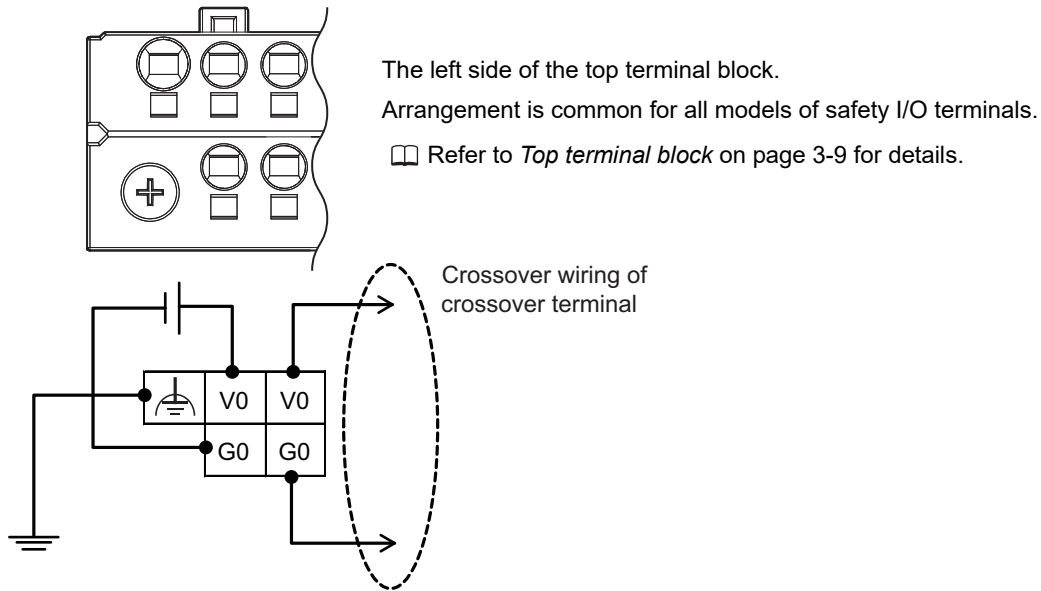

Unit power supply terminal (Top terminal block)

● Bottom terminal block (GI-SMD1624 only)

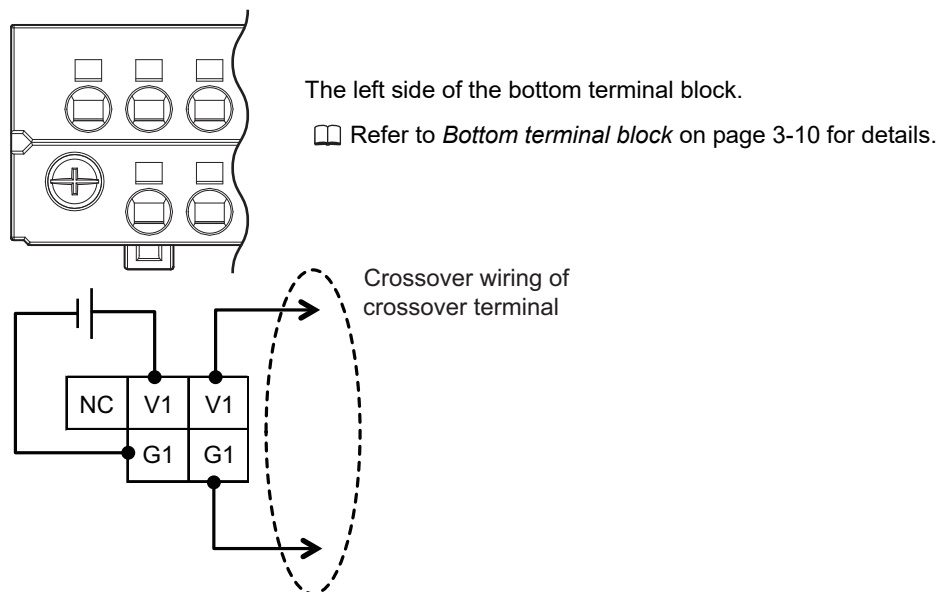

Output power supply terminal (Bottom terminal block)



Precautions for Safe Use

When wiring the power supply, make sure that the current capacity of the wire is sufficient. Otherwise, excessive heat may be generated. When cross-wiring terminals, the total current for all the terminals will flow in the wire. In wiring cross-overs, make sure that the current capacity of each of the wires is not exceeded.

● Unit power supply terminal

Terminal to connect the unit power supply. Used to connect the DC power supply to the left-side unit power supply terminal on the top terminal block. See below for details.

Terminal name	Description
V0	Connect the positive electrode (24VDC) of the power supply to V0.
G0	Connect the negative electrode (0VDC) of the power supply to G0.

V0 and G0 terminals are internally connected respectively.

● Terminal for output power supply

Terminal to connect an output power supply. Used to connect the DC power supply to the left-side output power supply terminal on the bottom terminal block. See below for details.

Terminal name	Description
V1	Connect the positive electrode (24VDC) of the power supply to V1.
G1	Connect the negative electrode (0VDC) of the power supply to G1.

V1 and G1 terminals are internally connected respectively.

You can use the unwired terminals for through-wiring to the power supply terminals of other safety I/O terminals or Units. Make the current supplied from the unwired terminals meet the following condition.
 Current supplied from unwired terminals \leq Current capacity of power supply terminals – Current consumption of other safety I/O terminals and/or units

For the current consumption of safety I/O terminals,  refer to *3-1-1 Models and Specifications* on page 3-2.

For that of other units, refer to the user's manual for the connected Unit.

When you supply the Unit power through the unwired terminals, be careful not to exceed 5 A, the current capacity of power supply terminals.

4-2-3 Selecting Power Supplies

This section describes how to select unit power supply and output power supply for the safety I/O terminal.



Precautions for Safe Use

- Make sure that the DC power supply devices meet the following conditions.
 - a) Double or reinforced insulation
 - b) Output hold time of at least 20 ms
 - c) SELV power supply that meets the requirements of IEC/EN 60950-1 and EN 50178
- Select a unit power and output power supply with sufficient capacity by considering the power supply capacity or inrush current when the power is turned ON that is specified in this manual. Otherwise, the external power supply may not be turned ON or malfunction due to unstable power supply voltage.
- The unit power supply and output power supply must be used within the power supply voltage range specified in this manual.

Recommended Power Supply

Use the SELV power supply that satisfies the following conditions as the unit power supply and output power supply.

- Equipped with overcurrent protection function
- Duplexed or reinforced insulation between input and output
- Output voltage of 24VDC (20.4 to 28.8VDC)

Recommended power supply: S8VS series (OMRON)

4-2-4 Selecting and Wring Protective Equipment

This section describes how to select protective equipment (e.g. breaker and fuse) against short circuit and/or overcurrent of external circuit.

Overcurrent is the current exceeding the following rated value that flows in the circuit due to too much load connected to the circuit.

Unit	Rated item	Rated value
Safety I/O terminal	Current that can be supplied by the safety I/O terminal power supply	5A max.
	Power supply terminal current carrying capacity	



Precautions for Safe Use

Surge current occurs when the power supply is turned ON. When selecting fuses or breakers for external circuits, consider the fusing and sensing characteristics to select fuses or breakers with appropriate specification. Refer to this manual for surge current specifications.



Precautions for Correct Use

Use the current supplied from the Unit power supply terminal and output power supply terminal of the safety I/O terminal at 5A or less. Using the currents that are outside of the specifications may cause failure or damage.

How to Select Protective Equipment

Select protective equipment taking into account the followings.

- Specifications of protective equipment (e.g. interruption, blowout, detection characteristics, stationary current value)
- Inrush current on power startup

Use a fast speed type or a medium speed type. If you use the instantaneous type of protective device, inrush current may trip the protective device.

Installation Location of Protective Equipment

Install the protective equipment for unit power supply and output power supply at the location shown below.

● GI-SMD1624

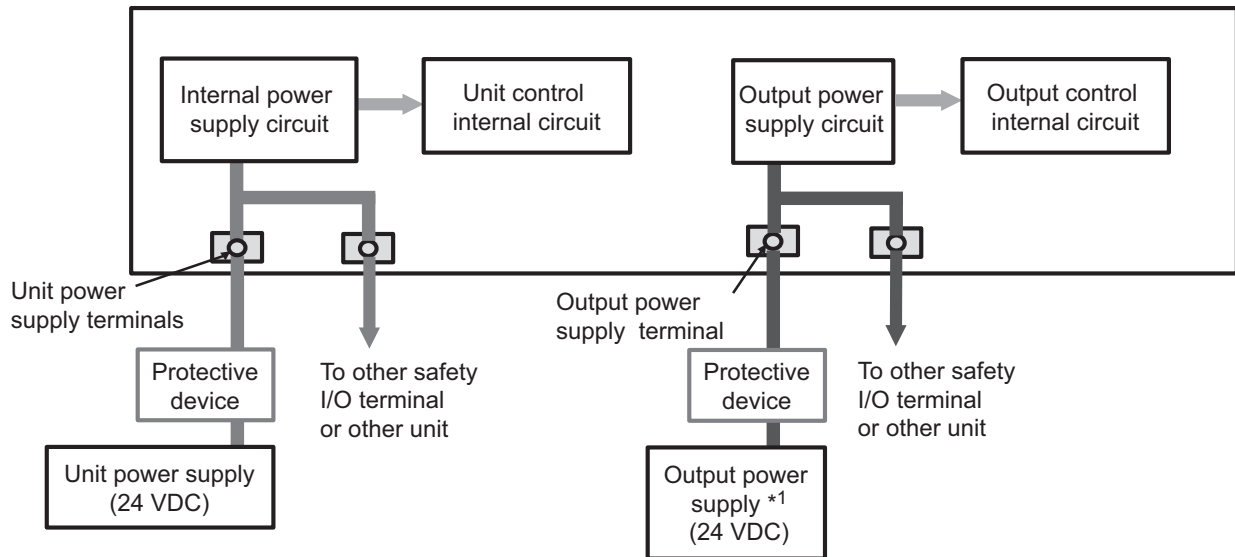

● GI-SID1224*1

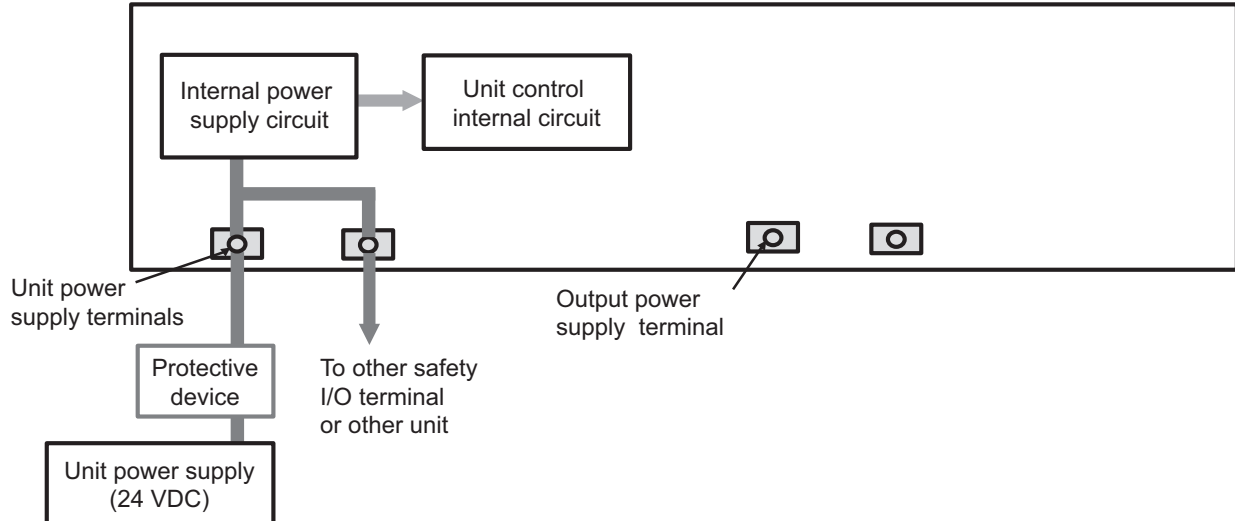

*1.GI-SID1224 has no output control circuit and no output power supply nor output device can be connected.

4-2-5 Earthing

This section provides description of the earthing for the safety I/O terminal.

⚠ WARNING

Death due to injury may possibly occur.
 Never earth the +24-V side of the power supply. Otherwise, safety functions may be lost by a earth fault on the safety output.



Earthing Terminal Type

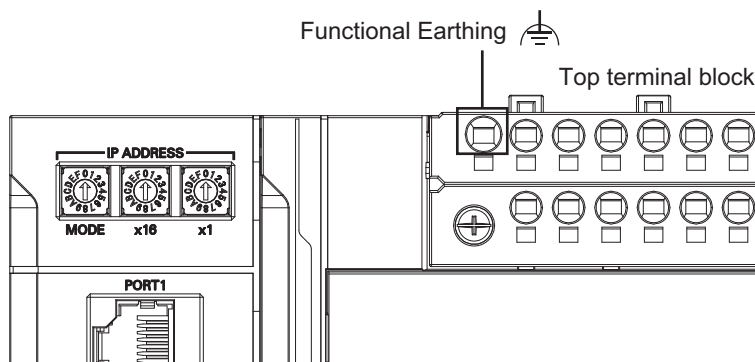

● **Earth terminal**

Earthing type	Symbol	Function
Functional Earthing		Functional earthing is done to protect device and system functions, including prevention of noise from external sources, or prevention of noise from devices or equipment that could have harmful effects on other devices or equipment.

Earthing for Safety I/O Terminal

This section describes how to wire the earthing for the safety I/O terminal.

Earthing must be wired to the functional earth terminal.

- The earth wire should not be more than 20 m long.
- Refer to *4-2-7 Wiring to the Terminal Block of the Safety I/O Terminal* on page 4-29 for details on the earthing wire suitable for functional earthing of the safety I/O terminal.

Earthing for Safety I/O Terminal with Peripheral Devices and/or Control Panel

Refer to *4-3-6 Earthing* on page 4-49 for details on earthing for the safety I/O terminal with peripheral devices and/or control panel.

4-2-6 Connecting the Built-in EtherNet/IP Port

Selecting the Network Devices

- **Recommended Ethernet switch**

Recommended products are those that passed the conformance test of ODVA's Managed Ethernet Switch Device Profile.

Contact ODVA for detailed information.

ODVA's site: <http://www.odva.org>

Recommended Twisted-Pair Cable And Connector

Cables and connectors to use depend on the transmission speed to use.

For 100BASE-TX, use an STP (shielded twisted-pair) cable of Ethernet category 5 or higher. You can use either a cross cable or a straight cable.

The following table lists wiring materials used for the EtherNet/IP communications cables.

	Product name		Manufacturer	Model
For 1000Base-T and 100Base-TX	Size and conductor pairs: AWG 24 × 4 pairs *1	Cables	Hitachi Metals, Ltd.	NETSTAR-C5E SAB 0.5 × 4P
			Kuramo Electric Co., Ltd.	KETH-SB
			SWCC Showa Cable Systems Co., Ltd.	FAE-5004
			JMACS Japan Co., Ltd.	IETP-SB
		RJ45 Connectors	Panduit Corporation	MPS588-C
For 100Base-TX	Size and conductor pairs: AWG 22 × 2 pairs *1	Cables	Kuramo Electric Co., Ltd.	KETH-PSB-OMR
			JMACS Japan Co., Ltd.	PNET/B
		RJ45 Assembly Connectors	OMRON	XS6G-T421-1



*1. We recommend that you use cables and connectors in above combinations.

● Ethernet switch functions

This section describes overview of Ethernet switch used for EtherNet/IP network. You must select an Ethernet switch based on the following two functions when using the built-in EtherNet/IP port.

- Multicast filter function

This function forwards multicast packets to specific node(s) only. It is implemented as IGMP Snooping or GMRP in the Ethernet switch.

The "specific nodes" means those that have the IGMP client function and ask for transfer request for the Ethernet switch (OMRON's built-in EtherNet/IP port has the IGMP client function). Without this function, multicast packets are transferred to all nodes as with broadcast packets, resulting in increase in network traffic.

To enable this function, you need to configure the Ethernet switch setting. There must be enough multicast filters for the network.

- TCP/UDP port number (L4) QoS (Quality of Service) function

This function performs priority control of packet forwarding such as prioritized forwarding of packets for specific IP address(es)/TCP (UDP) port(s). As the TCP and UDP protocols are transport protocols, it is called Layer 4 (L4) QoS function.

When executing tag data link and message communication on the same network, prioritized transfer of tag data link packets allows to avoid problems such as transfer delay due to message communication traffic and packet discard due to buffer overflow. To enable this function for prioritized transfer of tag data link packets, you need to configure the Ethernet switch setting.



Precautions for Safe Use

- If EtherNet/IP tag data links (cyclic communications) are used with a repeating hub, the communications load on the network will increase. This will increase collisions and may prevent stable communications. Do not use repeating hubs on networks where tag data links are used. Use an Ethernet switch instead.
 - Make sure that the communications distance and method of connection for EtherNet/IP are within specifications. Do not connect EtherNet/IP communications to Ether-CAT or other networks. An overload may cause the network to fail or malfunction.
-



Additional Information

If the Sysmac Studio is used to set the connection type to **Multi-cast connection** in the connection settings, multicast packets are used. If the connection type is set to **Point to Point connection**, multicast packets are not used.

● Ethernet switches selection precautions

Functions supported by the Ethernet switch can cause transfer delay of CIP Safety I/O communications and tag data links and changes in safety I/O terminal settings.

If the Ethernet switch supports other advanced functions, you need to configure the settings for them.

You must select an Ethernet switch based on what kind of communications are used on and how much load on the network.

Select an Ethernet switch taking into account the followings.

☐ Refer to *NX-series Safety Control Unit/Communication Control Unit User's Manual (SGFM-723)* for how to estimate tag data link communication loads.

- Case: Executing CIP Safety I/O communications and tag data links only
Recommended is an L2 Ethernet switch with or without multicast filter.
Those that have multicast filter can prevent increase in traffic due to unnecessary multicast packets, allowing faster CIP Safety I/O communications and tag data links.
If any of the following conditions applies, however, there is no difference in traffic for those with or without multicast filter.
 - a) Configured with CIP Safety I/O communications or tag data links that share the same data among all nodes on the network (multicast packets are transferred to all nodes as with broadcast)
 - b) If CIP Safety I/O communications and tag data link settings are configured as 1:1 (unicast), if multicast packets are not used, and if the multicast filter function is used, you need to configure the Ethernet switch settings.

- Case: Executing CIP Safety I/O communications or tag data links with message communications
Recommended is an L2 Ethernet switch with multicast filter and L4 QoS.
Configuring prioritized transfer of CIP Safety I/O communications or tag data link packets allows you to avoid problems such as transfer delay due to message communication traffic and packet discard due to buffer overflow.
To enable the multicast filter and L4 QoS functions, you need to configure the Ethernet switch settings.



Precautions for Correct Use

- Ask the Ethernet switch manufacturer for setting procedures for the Ethernet switch.
- Install the Ethernet switch so that its environmental resistance specifications are not exceeded. Ask the Ethernet switch manufacturer for information on the environmental resistance of the Ethernet switch.

Constructing the Network

☐ Refer to *Selecting the Network Devices* on page 4-21 for the network devices recommended for use with the built-in EtherNet/IP port.



Precautions for Safe Use

- Mount terminal blocks and connectors only after checking the mounting location carefully. During this time, be careful not to pinch your fingers.
- Be sure that the terminal blocks and Ethernet communications cables with tightening screws or locking devices are properly tightened to or locked into place.



Precautions for Correct Use

Basic installation precautions are given below.

- Take the greatest care when you install the Ethernet System. Be sure to follow ISO/IEC/IEEE 8802-3 specifications. Be sure you understand them before attempting to install an Ethernet System.
- Unless you are already experienced in installation of communications systems, we strongly recommend that you employ a professional to install your system.
- Do not install Ethernet equipment near sources of noise. If a noisy environment is unavoidable, take adequate measures against noise interference, such as installation of network components in metal cases or the use of optical cable in the system.
- When using a shielded cable with the shields on both ends of the cable connected to connector hoods, earth loops induced by improper earthing methods may decrease noise immunity and cause device damage. To prevent earth loops caused by differences in potential between device earthing points, the reference potential between the devices must be stabilized. Design earthing appropriately so that noise current does not flow to earth lines between the devices. ☐ Refer to *Installation and Wiring* on page 4-1 for earthing methods.
- To obtain information on installing EtherNet/IP cable, contact ODVA. ODVA web site: <http://www.odva.org>
- When you install an EtherNet/IP network that combines an information network with the control system, and the communications load may be heavy due to tag data links, we recommend that you set up a network where the load does not affect communications. For example, install the tag data links in a segment that is separate from the information network.

● Precautions When Laying the Twisted-pair Cable

- To attach a connector to the Ethernet switch and built-in EtherNet/IP port, firmly insert the connector until it locks into place.
- Do not lay the twisted-pair cables together with high-voltage lines.
- Do not lay the communications cable near devices that generate noise.
- Do not lay the communications cables in locations subject to high temperatures or high humidity.
- Do not lay the communications cables in locations subject to excessive dirt and dust or to oil mist or other contaminants.

Connection of shield wire to the connector hood: Between EtherNet/IP port and Ethernet switch

The shield wire must be connected to the connector hood as shown below.

- Connect both ends
- or
- Connect the Ethernet switch side only. A clamp core must be attached to the EtherNet/IP port side of the cable.

Connection of the shield wire to the connector hood must be either (1) or (2) below.

(1) Connect both ends

Connect the cable shield to the connector hood at both ends of the cable.

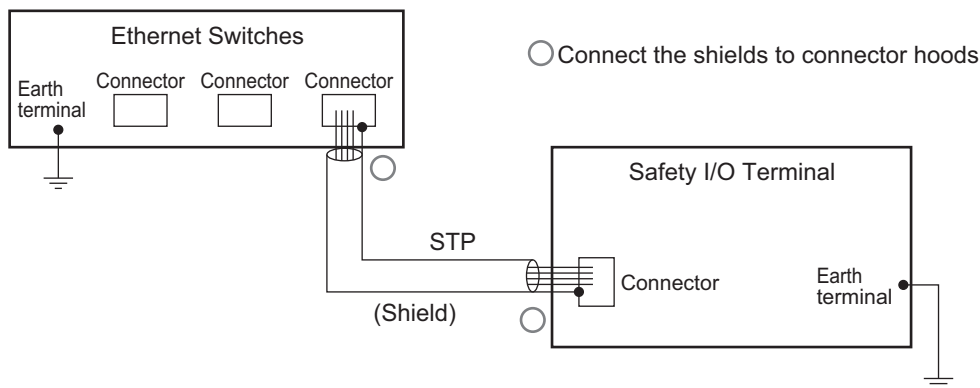
**(2) Connect Ethernet switch side only**

Attach the clamp core to the root of the cable on the EtherNet/IP port end. For the recommended clamp core and attachment method, refer to "Recommended Clamp Core and Attachment Method" described later.

To comply with EMC standards, it is mandatory that a clamp core be attached when connecting the shield only to the connector hood on the Ethernet switch side.

Connect the cable shield to the connector hood only at the Ethernet switch end of the cable.

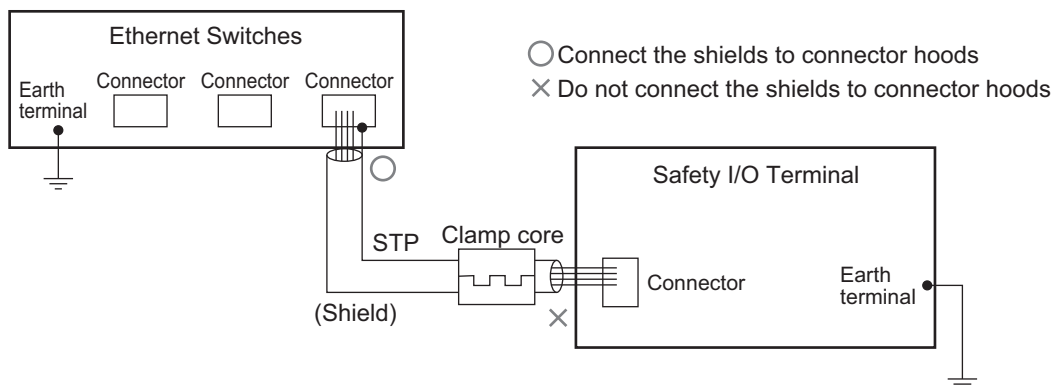
**Additional Information**

Noise immunity may be reduced and device damage may occur due to earth loops, which can occur due to improper shield connections and earthing methods.

When using a baud rate of 100 Mbps or less, it may be possible to alleviate this problem by connecting only the Ethernet switch side as described in (2), rather than connecting both ends as described in (1).

Connection of shield wire to the connector hood: Between Ethernet switch and Ethernet switch

Regardless of which baud rate is used, check with the Ethernet switch manufacturers for information about installing the network between Ethernet switches, and in particular whether or not it is necessary to connect the cable shields to the connector hoods.

Recommended Clamp Core and Attachment Method

If you connect a shielded cable with the Ethernet switch end connected to the connector hood, you must attach a clamp core to the EtherNet/IP port side of the safety I/O terminal.

Shown below is the recommended clamp core and attachment method.

Recommended Clamp Core:

Manufacturer	Product	Model
NEC TOKIN	Clamp core	ESD-SR-250

ESD-SR-250 dimensions

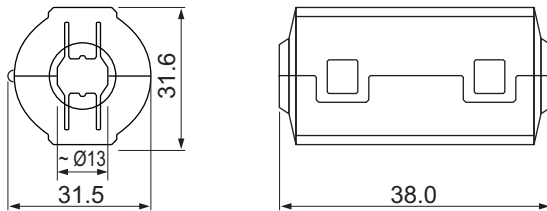

Recommended Attachment Method:

- Attaching the clamp core to the communication cable

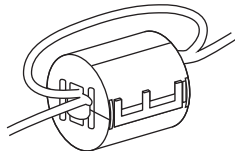

Make two loops with the cable as shown.

- Attachment method of communication cable

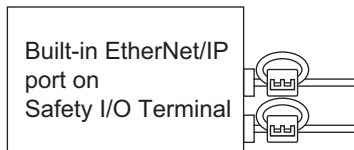

Attach to the base of the communications cable, as illustrated in the figure.

● Installation Precautions for Ethernet Switch

- Do not install the Ethernet switch in the same location as a drive-system component, such as an inverter.
- Power supply of the Ethernet switch must be dedicated one. Do not share the same power supply with that for I/O, motor, nor control.
- Take fully into account the environmental performance specifications of the Ethernet switch so that it should be suitable for the use environment. For details of the environmental performance specifications of the Ethernet switch, contact its manufacturer.

● Ethernet Switch Connection Procedure

- Use a straight cable between MDI and MDI-X ports to connect a twisted-pair cable between the Ethernet switches. Use a crossing cable between MDI and MDI ports or MDI-X and MDI-X ports.

Note It is difficult to discriminate crossing and straight cables by appearance. Using a wrong cable will cause communication errors. In principle use of a straight cable is recommended.

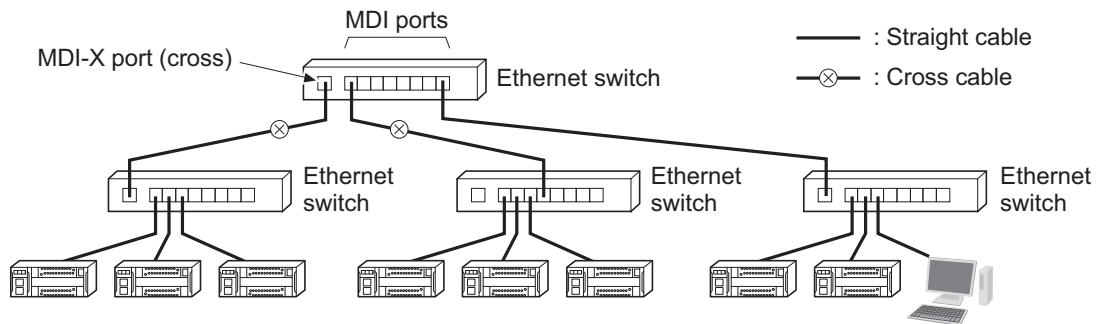

- Some Ethernet switches automatically detect MDI/MDI-X. If it applies, you can use a straight cable between Ethernet switches.



Precautions for Correct Use

Adjust the built-in EtherNet/IP port's link settings to match the communications mode settings of the connected Ethernet switch. If the settings do not match, the link will be unstable and prevent normal communications. The following table shows the allowed settings for each Ethernet switch communications mode.

Ethernet Switches		Built-in EtherNet/IP Port		
		AUTO-Nego ^{*1}	100 Mbps (fixed)	
			full	half
AUTO-Nego		Best	---	OK
10 Mbps (fixed)	full	---	---	---
	half	OK	---	---
100 Mbps (fixed)	full	---	OK	---
	half	OK	---	OK
1,000 Mbps (fixed)	full	---	---	---

*1. AUTO-Nego: Auto-negotiation, full: Full-duplex, half: Half-duplex.

(Best = Recommended; OK = Allowed; --- = Not allowed.)

Connecting to Network

● Ethernet connector

Connects to the Ethernet twisted-pair cable.

- Electrical characteristics: Conforms to IEEE 802.3 standards.
- Connector structure: RJ45 8-pin modular connector (Conforms to ISO 8877)
-  Refer to *Precautions When Laying the Twisted-pair Cable* on page 4-24 for connection between the cable shield and connector hood.

10BASE-T and 100BASE-TX:

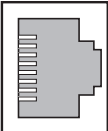
	Connector pin	Signal name	Abbreviation	Signal direction
	1	Transmission data +	TD+	Output
	2	Transmission data-	TD-	Output
	3	Reception data +	RD+	Input
	4	Not used.	---	---
	5	Not used.	---	---
	6	Reception data -	RD-	Input
	7	Not used.	---	---
	8	Not used.	---	---

1000BASE-T:

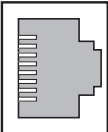
	Connector pin	Signal name	Abbreviation	Signal direction
	1	Communication data DA+	BI_DA+	Input/output
	2	Communication data DA-	BI_DA-	Input/output
	3	Communication data DB+	BI_DB+	Input/output
	4	Communication data DC+	BI_DC+	Input/output
	5	Communication data DC-	BI_DC-	Input/output
	6	Communication data DB-	BI_DB-	Input/output
	7	Communication data DD+	BI_DD+	Input/output
	8	Communication data DD-	BI_DD-	Input/output

● Cable Connection Procedure



Precautions for Correct Use

- Turn OFF the safety I/O terminal's power supply before connecting or disconnecting Ethernet communications cable.
- Allow extra space for the bending radius of the communications cable.
For the dimensions when the communications cable is connected to the safety I/O terminal,  refer to *Installation and Wiring* on page 4-1. The required space depends on the communications cable and connector that are used. Consult the manufacturer or sales agent.

- 1** Lay the twisted-pair cable.
- 2** Connect the twisted-pair cable to the Ethernet switch.
- 3** Attach the twisted-pair cable to the built-in EtherCAT/IP port connector.

To attach a connector to the Ethernet switch and Ethernet, firmly insert the connector until it locks into place.

4-2-7 Wiring to the Terminal Block of the Safety I/O Terminal

This section describes how to wire to the screwless clamp terminal block of the safety I/O terminal as well as how to attach, detach, and prevent incorrect plugging.

You can connect a rod terminal attached to a stranded wire and/or stranded wire and solid wire to the screwless clamp terminal block. A rod terminal can be wired easily, only by inserting the terminal into the terminal hole on the terminal block.



Precautions for Safe Use

- Use the correct wire size, wiring parts and tools when you wire the system. Otherwise, cables may be disconnected to cause short-circuit or wire breakage.
- When you install wiring, be sure to turn off the power beforehand. Otherwise, the external devices connected with the GI-S Series may operate unexpectedly.
- The unit power supply and output power supply must be used within the power supply voltage range specified in this manual.
- Do not apply voltages or connect loads to the GI-S Series in excess of the ratings.

Applicable Wire

Wires that can be connected to the screwless clamp terminal block include a rod terminal attached to a stranded wire and/or stranded wire as well as solid wire. Described below are dimensions and process method for applicable wires.

● Dimensions of wire to connect to terminal block

Shown below in the diagram are sizes of wires that can be connected to the holes of the screwless clamp terminal block.

Wires designated later must be processed to fit the dimensions.

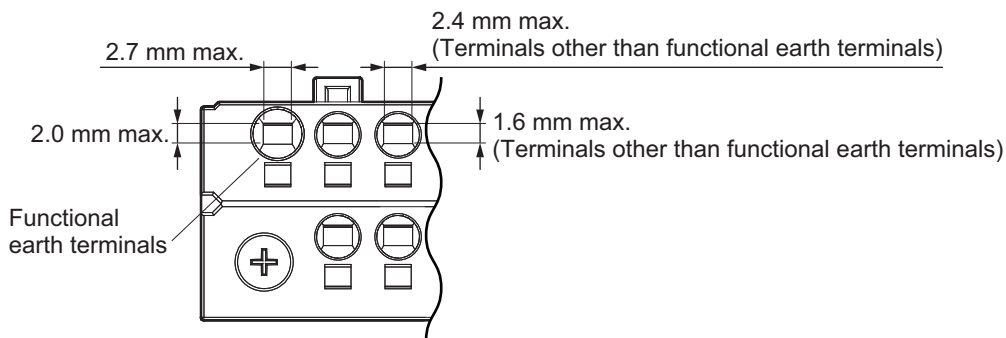

● **Using rod terminal**

A rod terminal must be used with stranded wire attached.

The strip length of the stranded wire to attach to the rod terminal must be based on the usage of the rod terminal.

The rod terminal must be one with single rod with plating. You cannot use a rod terminal without plating nor a terminal with two rods.

Described below are applicable rod terminals, wires, and crimping tools.

Terminal type	Manufacturer	Ferrule model *1	Applicable wire (mm ² (AWG))	Crimping tool (Applicable wire sizes are given in parentheses.)
Functional earth terminals, and the other terminals	Phoenix Contact	AI0,25-8	0.25 (#24)	Phoenix Contact CRIMPFOX 6 (0.25 to 6mm ² ? AWG24 to 10)
		AI0,5-8	0.5 (#20)	
		AI0,5-10		
		AI0,75-8	0.75 (#18)	
		AI0,75-10		
		AI1,0-8	1.0 (#18)	
		AI1,0-10		
		AI1,5-8	1.5 (#16)	
		AI1,5-10		
		Functional earth terminals		
		AI2,5-10		
Functional earth terminals, and the other terminals	Weidmuller	H0.14/12	0.14 (#26)	Weidmuller PZ 6 Roto (0.14 to 6mm ² ?AWG26 to 10)
		H0.25/12	0.25 (#24)	
		H0.34/12	0.34 (#22)	
		H0.5/14	0.5 (#20)	
		H0.5/16		
		H0.75/14	0.75 (#18)	
		H0.75/16		
		H1.0/14	1.0 (#18)	
		H1.0/16		
		H1.5/14	1.5 (#16)	
Functional earth terminals		H2.5/15D	2.5 (#14)	
		H2.5/16DS		
Functional earth terminals, and the other terminals	Wago	FE-0.25-8N	0.25 (#24)	Wago Variocrimp 4 (0.25 to 4mm ² ? AWG24 to 12)
		FE-0.34-8N	0.34 (#22)	
		FE-0.5-8N	0.5 (#20)	
		FE-0.5-10N		
		FE-0.75-8N	0.75 (#18)	
		FE-0.75-10N		
		FE-1.0-8N	1.0 (#18)	
		FE-1.0-10N		
		FE-1.5-8N	1.5 (#16)	
		FE-1.5-10N		
Functional earth terminals		FE-2.5-8N	2.5 (#14)	
		FE-2.5-10N		

*1. This represents a typical model. Actually, it is added with color code and other information.

If you wish to use a rod terminal other than the above, crimp the stranded wire and rod terminal so that the terminal should be in the processed dimensions as shown below.

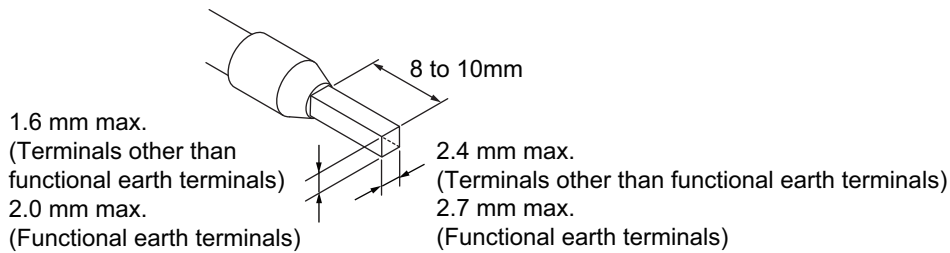

● **Using stranded wire/solid wire**

Use the following wires in case stranded wires/solid wires are used.

Terminals		Wire type				Wire size	Conductor length (stripping length)
		Twisted wires		Solid wire			
Classification	Current capacity	Plated	Unplated	Plated	Unplated		
Functional earth terminals, and the other terminals	2 A max.	Possible	Possible	Possible	Possible	0.08 to 1.5 mm ² AWG 28 to 16	8 to 10 mm
	Greater than 2 A and 5 A or less		Not possible	Possible *1	Not possible		
Functional earth terminals	---	Possible	Possible	Possible	Possible	0.08 to 2.0 mm ² AWG 28 to 14	10 to 12 mm

*1. Secure wires to the screwless clamping terminal block. Refer to *Securing the wires* on page 4-34 for how to secure wires.

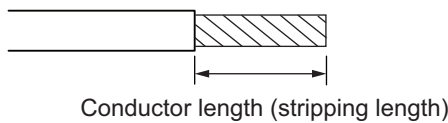

Precautions for Correct Use

- Use cables with suitable wire sizes for the carrying current. There are also restrictions on the current due to the ambient temperature. Refer to the manuals for the cables and use the cables correctly for the operating environment.
- For twisted wires, strip the sheath and twist the conductor portion. Do not unravel or bend the conductor portion of twisted wires or solid wires.

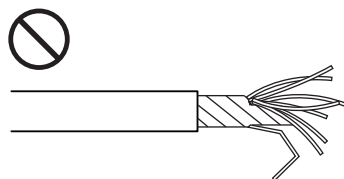

Unravel wires

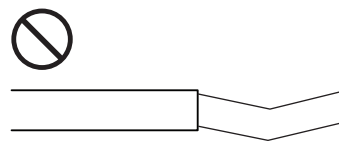

Bend wires

Additional Information

If more than 2 A will flow on the wires, use plated wires or use ferrules.

Attaching/Detaching Wires

This section describes how to attach and detach wires.

● Terminal Block Parts and Names

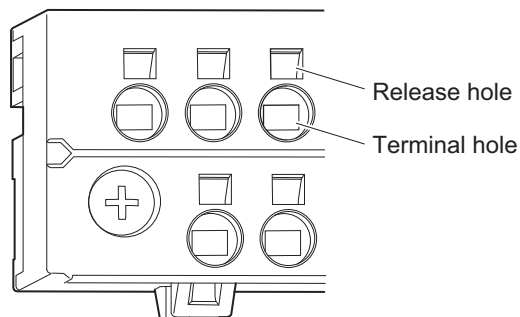

Shown above is the bottom terminal block. Layout of the top terminal block is upside down of this.

● Tools to Use

A flathead screwdriver is used to attach and detach wires.

The flathead screwdriver must satisfy the following specifications.

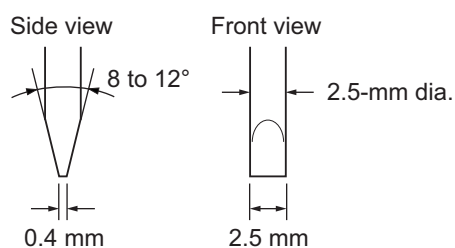

Recommended screwdriver model

Model	Manufacturer
SZS 0,4×2,5	Phoenix Contact
SZF 0-0,4×2,5 *1	
ESD 0.40×2.5	Wera
0,4×2,5×75 302	Wiha
AEF.2,5×75	Facom
210-719	Wago
SDI 0.4×2.5×75	Weidmuller

*1. You can purchase the SZF 0-0,4×2,5 screwdriver (manufactured by Phoenix Contact) from OMRON by specifying the OMRON's model number (XW4Z-00B).

● Connecting a Rod Terminal

Insert the rod terminal to the terminal hole straight.

You don't need to press the flathead screwdriver into the release hole.

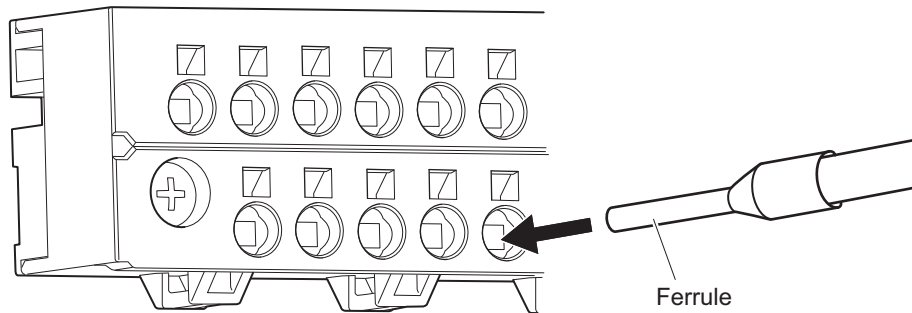

After attaching, make sure that the rod terminal is secured on the terminal block.

● Attaching stranded wire/solid wire

To attach a stranded/solid wire to the terminal block, perform the following steps.

- 1 Press the flathead screwdriver into the release hole straight from the front part of the terminal block.

When properly pressing, you should feel the repulsive force of the spring in the release hole, then the screwdriver should be slanted.

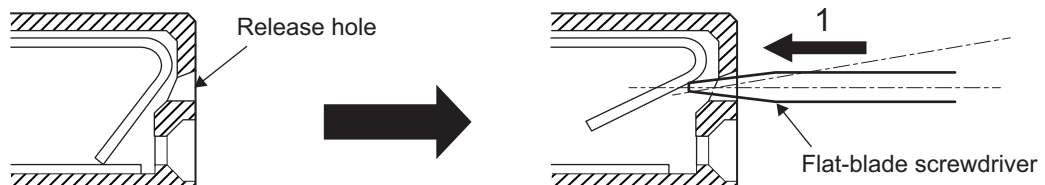

- 2 While the flathead screwdriver is still inside the release hole, insert the stranded/solid wire into the terminal hole.

To prevent short circuit, insert the stranded/solid wire so that the stripped part of the wire should be hidden in the terminal hole.

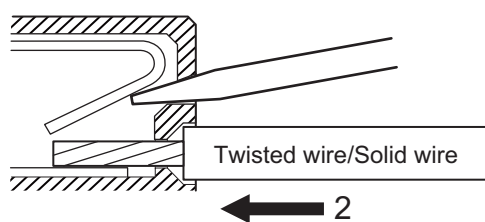

- 3 Pull out the flathead screwdriver from the release hole.

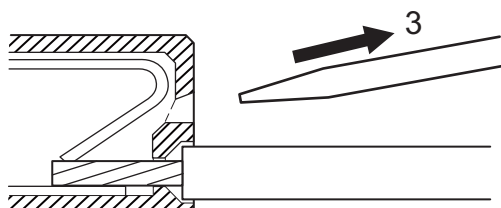

After attaching, make sure that the stranded/solid wire is secured on the terminal block.



Precautions for Safe Use

- When you insert a flat-blade screwdriver into a release hole on the screwless clamping terminal block, press the screwdriver down with an appropriate angle and a force of 30 N or less. Applying excessive force may damage the terminal block.
- Do not tilt or twist the flat-blade screwdriver while it is pressed into the release hole of the screwless clamping terminal block. Doing so may break the terminal block.

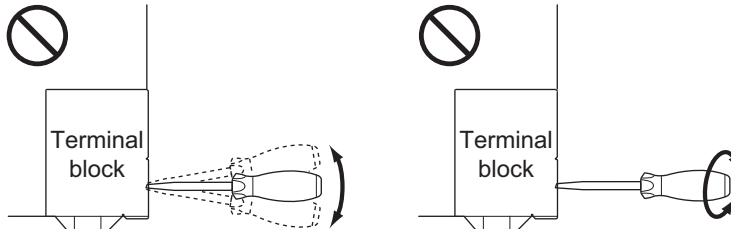

- Do not bend or pull a cable forcibly. Do not place any heavy objects on the cable. Doing so may break the cable.

● **Securing the wires**

Depending on a wire type and current to flow, you may need to secure the wire on the screwless clamp terminal block.

The table shown below indicates the conditions for securing the wire.

Terminals		Wire type				
		Ferrule	Twisted wires		Solid wire	
Classification	Current capacity		Plated	Unplated	Plated	Unplated
Terminals other than functional earth terminals	2 A max.	No	No	No	No	No
	Greater than 2 A and 5 A or less			---	Yes	---
Functional earth terminals	---		No	No	No	No

Secure the wire following the description below.

1 Prepare cable ties.

You can use cable ties with a width ranging from 4mm to 1.5mm.

Use proper cable ties based on the use environment.

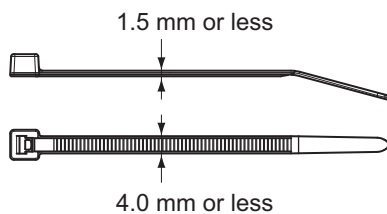

- 2** Run the cable tie through the wire securing hole on the top/bottom of the screwless clamp terminal block.

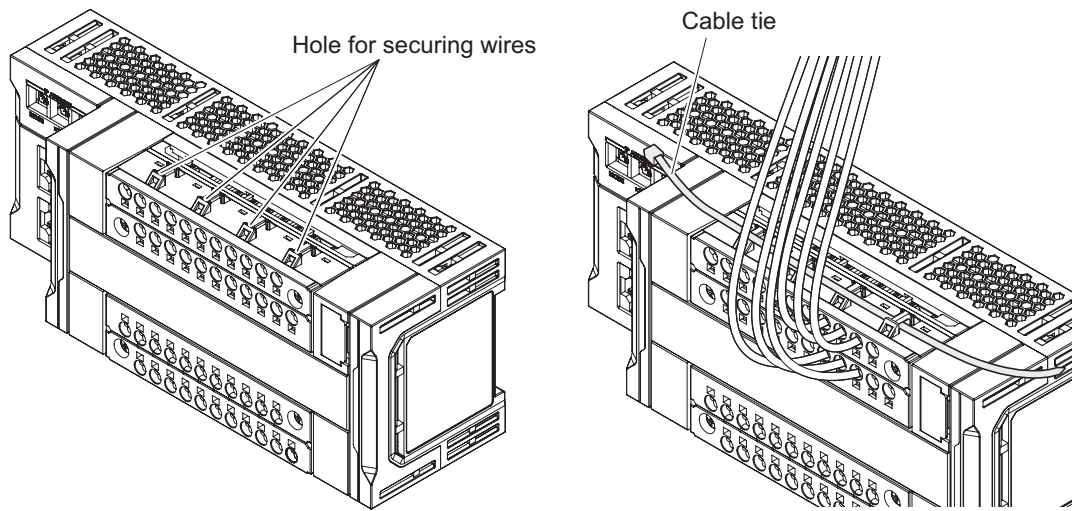

- 3** Bundle five to six wires by the cable ties and secure them on the screwless clamp terminal block.

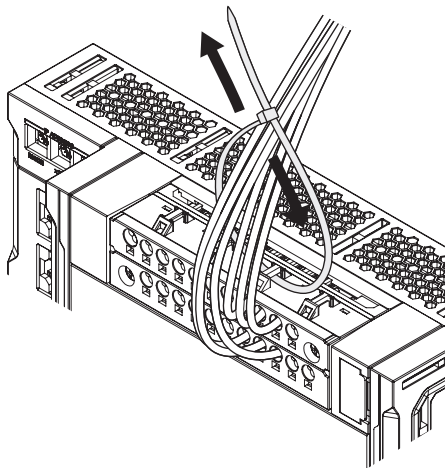

Wires must be secured so that they should be within 30mm from the screwless clamp terminal block. Also, ventilation must be ensured for above and below the CPU rack as shown below.

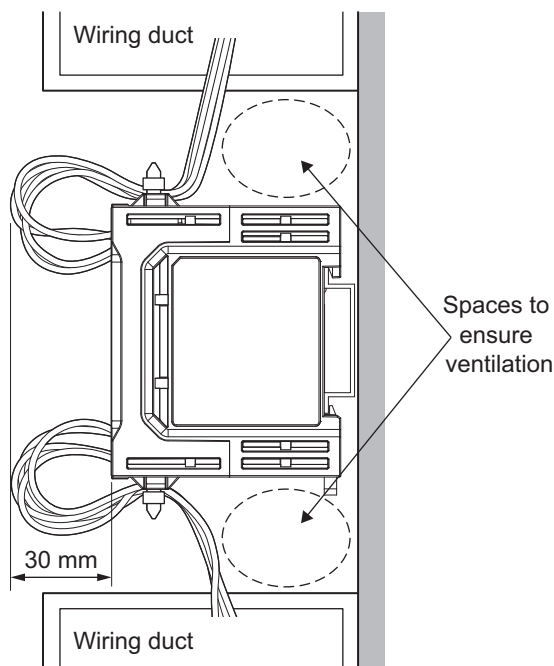

● Detaching the wires

To detach a wire from the terminal block, perform the following steps.

The steps are common for rod terminals and stranded/solid wires.

If the wire is secured on the terminal block, unsecure the wire.

- 1 Press the flathead screwdriver into the release hole straight from the front part of the terminal block.

When properly pressing, you should feel the repulsive force of the spring in the release hole, then the screwdriver should be slanted.

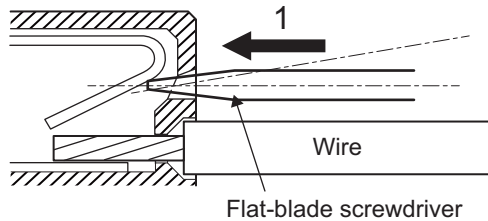

- 2 While the flathead screwdriver is still inside the release hole, pull out the wire from the terminal hole.

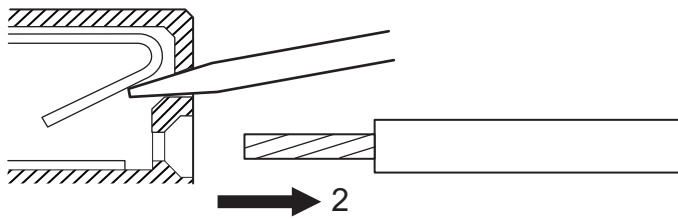

- 3 Pull out the flathead screwdriver from the release hole.

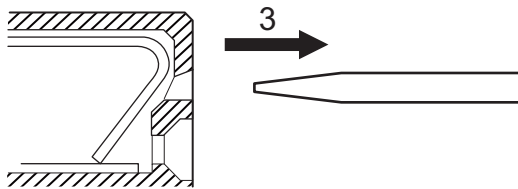

Precautions for Safe Use

- When you insert a flat-blade screwdriver into a release hole on the screwless clamping terminal block, press the screwdriver down with an appropriate angle and a force of 30 N or less. Applying excessive force may damage the terminal block.
- Do not tilt or twist the flat-blade screwdriver while it is pressed into the release hole of the screwless clamping terminal block. Doing so may break the terminal block.

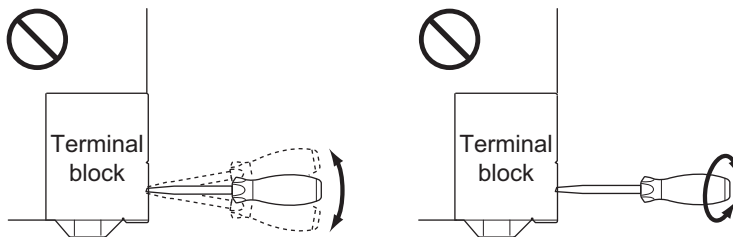

- Do not bend or pull a cable forcibly. Do not place any heavy objects on the cable. Doing so may break the cable.

Detaching the Terminal Block

- 1 Loosen and remove the M3 screws on the left and right of the terminal block. They are captive screws and loosening them lifts the terminal itself. If it is difficult to loosen, alternately loosen them.

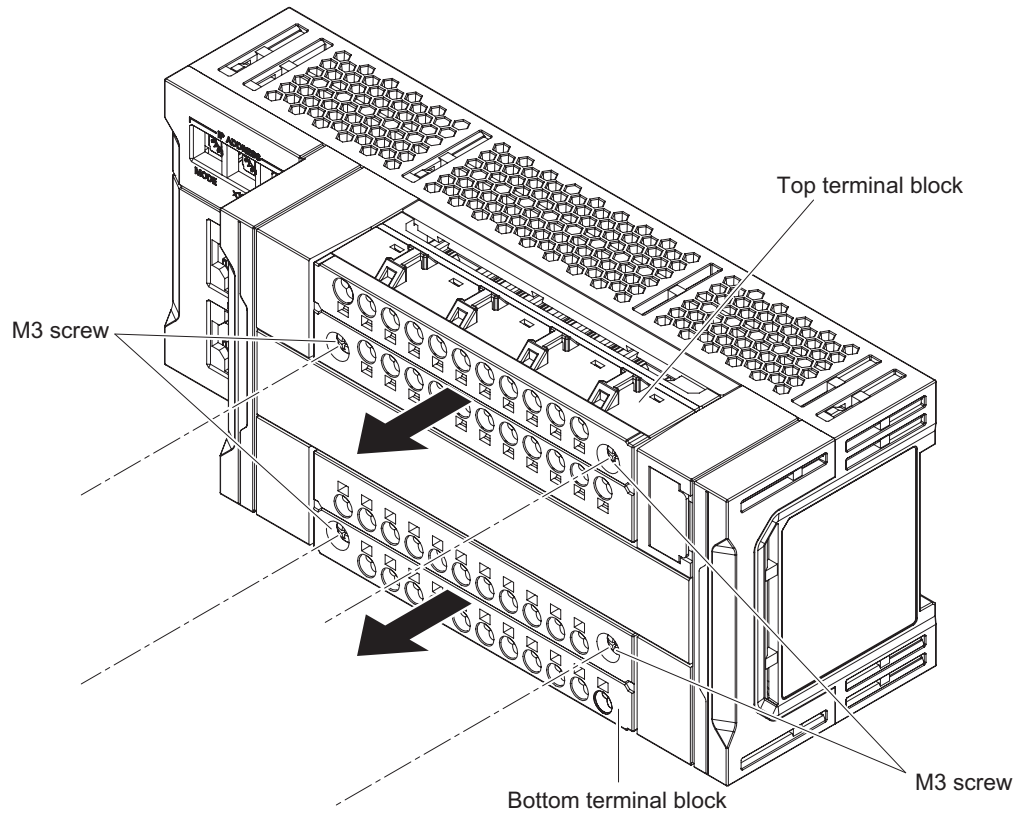

Attaching the Terminal Block

⚠ CAUTION

Fire or malfunction may possibly occur if screws loosen.
Tighten terminal block fixing screws to the torques specified in this manual.



Precautions for Safe Use

- Mount terminal blocks and connectors only after checking the mounting location carefully. During this time, be careful not to pinch your fingers.
- Be sure that the terminal blocks and Ethernet communications cables with tightening screws or locking devices are properly tightened to or locked into place.

- 1 Attach the terminal block to the safety I/O terminal and use M3 screws on the left and right of the terminal block to secure.

They are captive screws and tightening them secures the terminal block.

If it is difficult to tighten, alternately tighten them.

Attaching the terminal block does not fix it and does not ensure electrical connection. Make sure that both of the left and right screws are tightened.

Tighten the screws to the torque of $0.5\text{N}\cdot\text{m}$.

After you attach the terminal block, check to be sure that it is securely mounted on the unit.

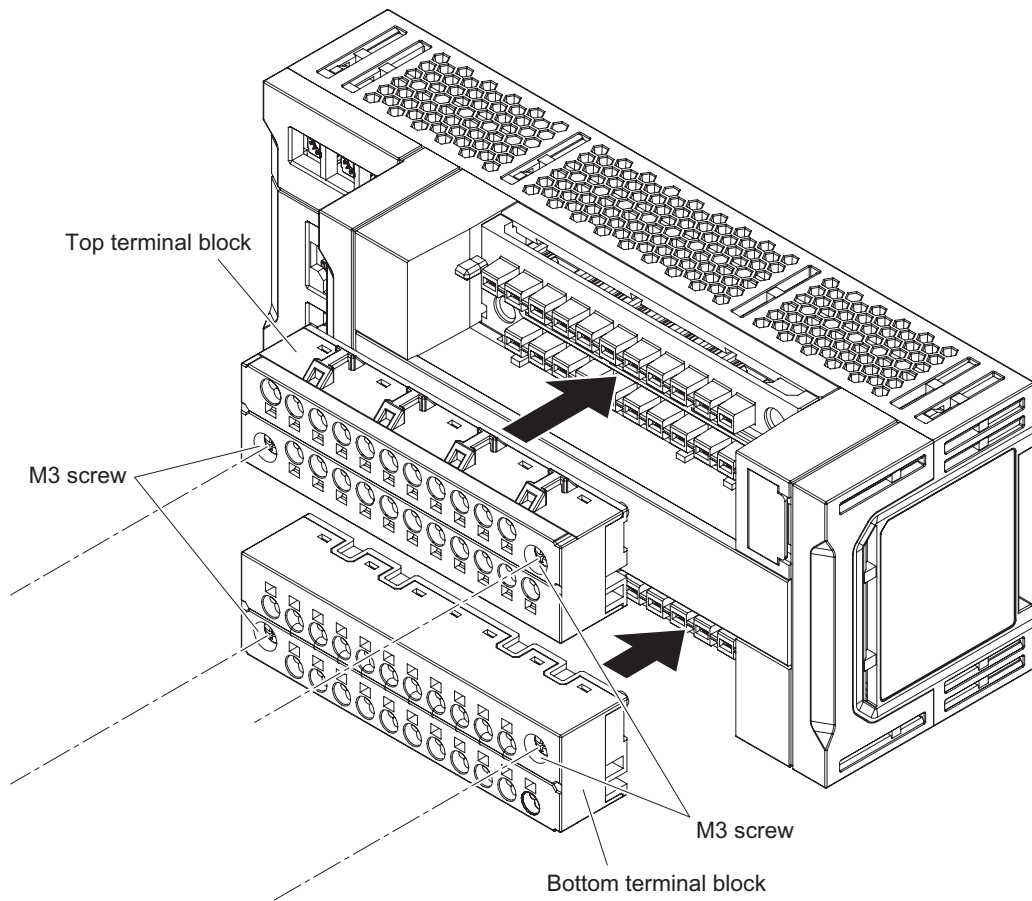

Incorrect Insertion Prevention Function of Terminal Block

This function prevents incorrect insertion of terminals into top/bottom terminal blocks for the safety I/O terminal with 22 holes for terminals.

You cannot attach top and bottom terminal blocks the other way around. This should prevent a user to incorrectly attach a wired terminal block.

Be careful not to attach the top and bottom terminal blocks the other way around when performing wiring while the terminal blocks are detached from the safety I/O terminal.

See below for how to discriminate the top and bottom terminal blocks.

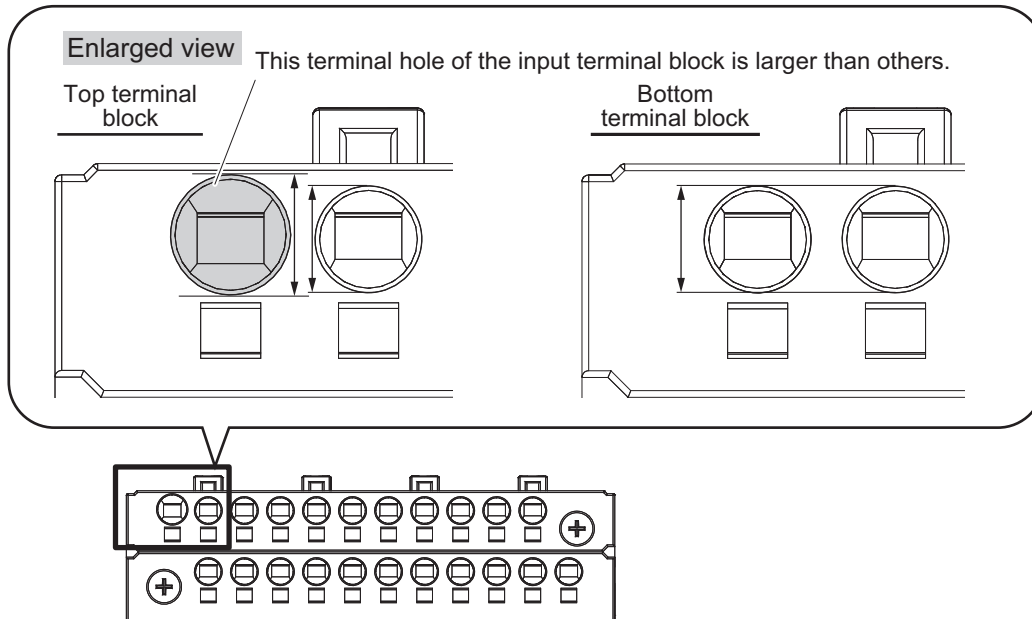

Additional Information

As shown below, wrong insertion of the terminal blocks is prevented by the ribs. Do not insert the terminal block forcefully.

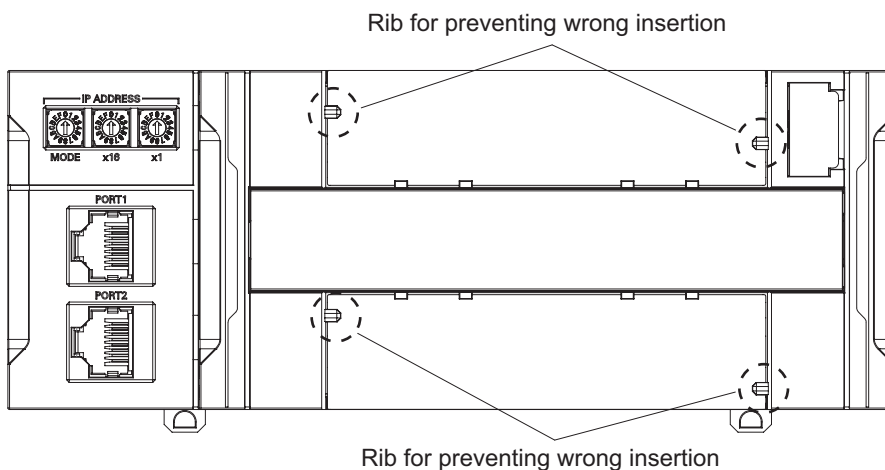

4-2-8 Removing the Memory Cassette



Precautions for Safe Use

Insert the memory cassette all the way. In addition, do not remove the memory cassette while the power is ON. Data may become corrupted, and the product will not operate correctly if it uses corrupted data.

Removing the Memory Cassette

- 1** Check that the unit power supply indicator [V0] and output power supply indicator [V1] of the safety I/O terminal have gone out, and that the power supply is OFF.
- 2** Insert a flat-blade screwdriver into a gap in the memory cassette slot, and push the screwdriver in the direction of the arrow so as to pull out the memory cassette forward.

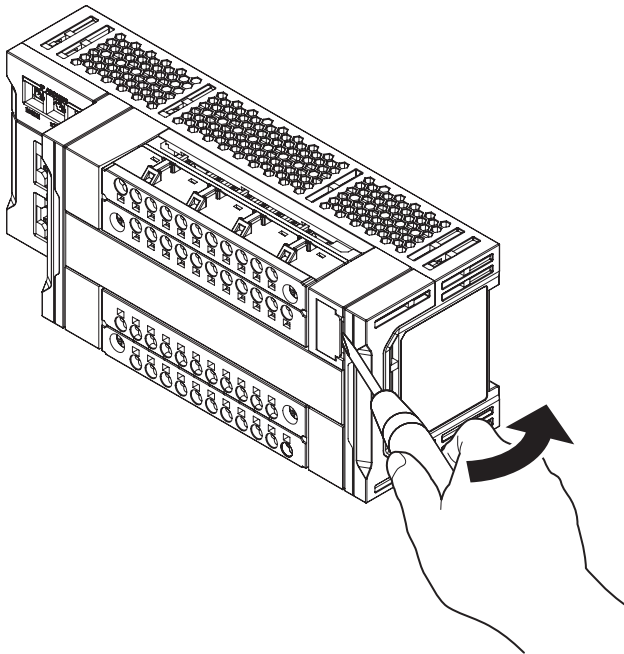

- 3** When the memory cassette is pulled out forward, remove it from the safety I/O terminal body.

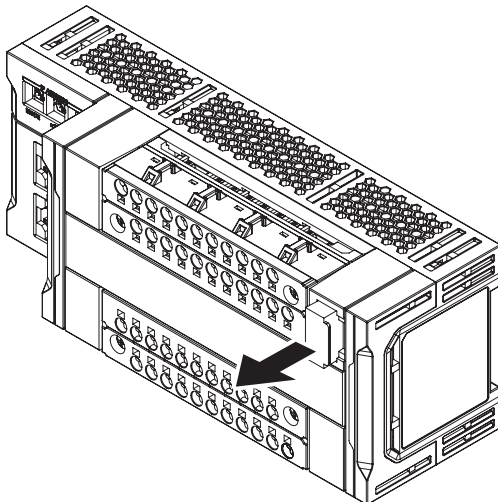

Installing the Memory Cassette

- 1 Check that the unit power supply indicator (V0) and output power supply indicator (V1) of the safety I/O terminal have gone out, and that the power supply is OFF.
- 2 Insert the memory cassette into the memory cassette slot, and push it in all the way.

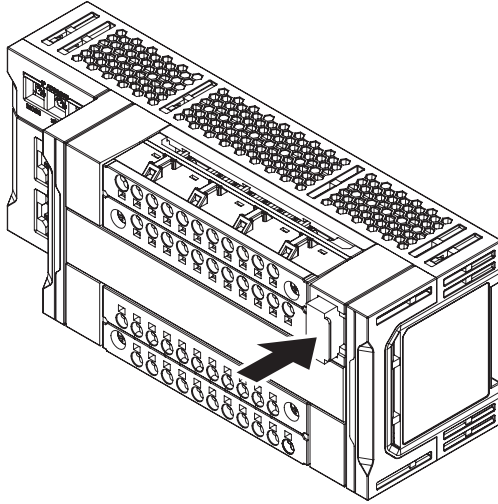

4-3 Control Panel Installation

To ensure system reliability and safety, the system must be designed and configured according to the installation environment (temperature, humidity, vibration, shock, corrosive gases, overcurrent, noise, etc.).



Precautions for Safe Use

Install the Units in a well-ventilated area. Avoid installing the Units near heating elements. Doing so may result in malfunction, in operation stopping, or in burning.

4-3-1 Temperature

Panels have been reduced in size due to space-saving and miniaturization in devices and systems, and the temperature inside the panel may be at least 10 to 15°C higher than outside the panel. Implement the following measures against overheating at the installation site and in the panel, and allow a sufficient margin for the temperature before use.

High Temperatures

Use the following cooling methods as required, taking into account the ambient temperature and the amount of heating inside the panel.

● Natural Cooling

- Natural cooling relies on natural ventilation through slits in the panel, rather than using cooling devices such as fans or coolers. When using this method, observe the following points.
- Do not install the Controller at the top of the panel, where hot air tends to stagnate.
- To provide ventilation space above and below the Controller, leave sufficient distance from other devices, wiring ducts, etc.
- Do not install the Controller directly above any heat-generating equipment, such as heaters, transformers, and devices with high resistance.
- Do not install the Controller in a location exposed to direct sunlight.

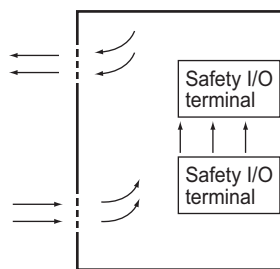

Natural Cooling

● Forced Ventilation (by Fan at Top of Panel)

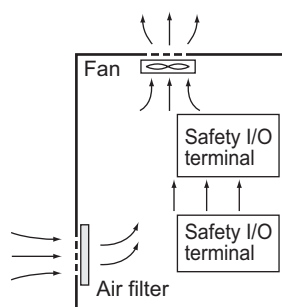

Forced Ventilation Method

- **Forced Air Circulation (by Fan in Closed Panel)**

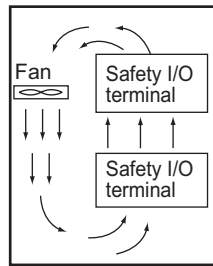

Forced Air Circulation

- **Room Cooling (Cooling the Entire Room Where the Control Panel Is Located)**

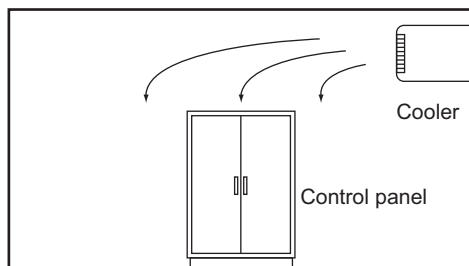

Room Cooling

Low Temperatures

The safety I/O terminal may not start normally if the temperature is below 0°C when the power is turned ON.

Maintain an air temperature of at least approximately 5°C inside the panel, by implementing measures such as installing a low-capacity space heater in the panel.

Alternatively, leave the safety I/O terminal power ON to keep it warm.

4-3-2 Humidity

Rapid temperature changes can cause condensation to occur, resulting in malfunctioning due to short-circuiting.

When there is a possibility of this occurring, take measures against condensation, such as leaving the Controller power ON at night or installing a heater in the control panel to keep it warmer.

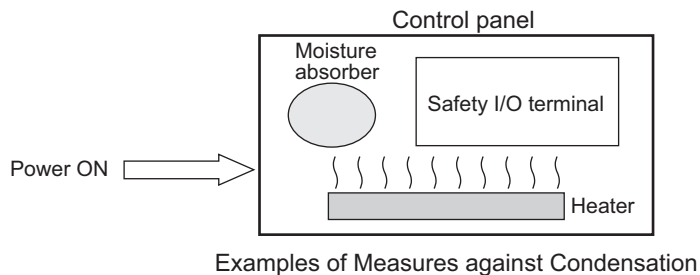

4-3-3 Vibration and Shock

The safety I/O terminal is tested for conformity with the sine wave vibration test method (IEC 60068-2-6) and the shock test method (IEC 60068-2-27) of the Environmental Testing for Electrotechnical Products. It is designed so that malfunctioning will not occur within the specifications for vibration and shock.

If, however, the Controller is to be used in a location in which it will be directly subjected to regular vibration or shock, then implement the following countermeasures:

- Separate the control panel from the source of the vibration or shock.
Or secure the safety I/O terminal and the panel with rubber padding to prevent vibration.
- Make the building or the floor vibration-resistant.
- To prevent shock when other devices in the panel such as electromagnetic contactors operate, secure either the source of the shock or the safety I/O terminal with rubber padding.

4-3-4 Atmosphere

Using the Controller in any of the following locations can cause defective contact with connectors and corrosion of components. Implement countermeasures such as purging the air as required.

- In locations exposed to dust, dirt, salt, metal powder, soot, or organic solvents, use a panel with an airtight structure. Be careful of temperature increases inside the panel.
- In locations exposed to corrosive gas, purge the air inside the panel to clear the gas and then pressurize the inside of the panel to prevent gas from entering from outside.
- In locations where flammable gas is present, either use an explosion-protected construction or do not use the Controller.

4-3-5 Electrical Environment

When installing or wiring devices, make sure that there will be no danger to people and that noise will not interfere with electrical signals.

Safety I/O Terminal Installation Location

Install the Controller as far away as possible from high-voltage (600 V or higher) and power devices to ensure safe operation and maintenance.

Example of Recommended Equipment Arrangement

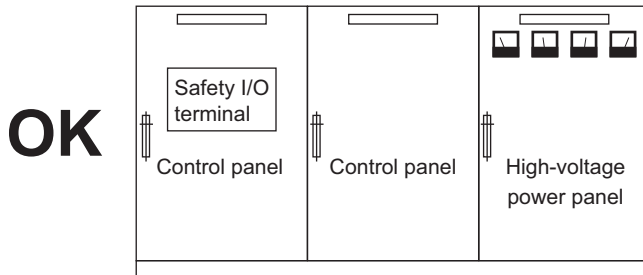

Example of Poor Equipment Arrangement

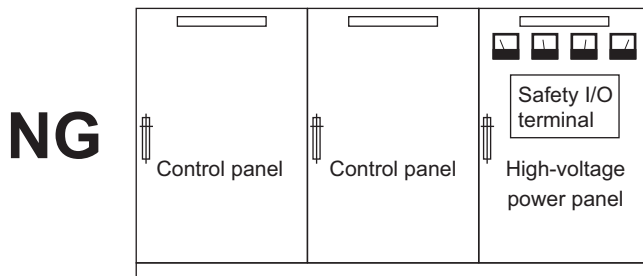

Examples of Equipment Arrangement in Panel with High-voltage Devices

Arrangement of Safety I/O Terminal and Units

The coils and contacts in electromagnetic contacts and relays in an external circuit are sources of noise. Do not install them close to the safety I/O terminal. Locate them at least 100 mm away from the product.

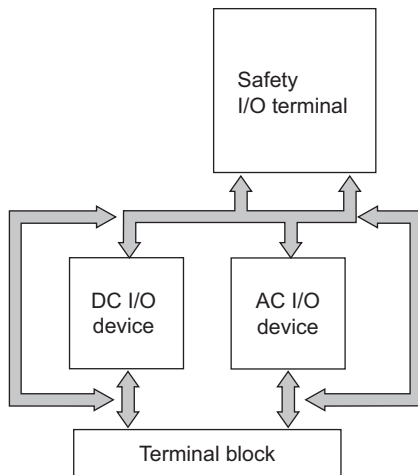

Example of Arrangement in Panel

Wire Layout for the Power Supply System

Observe the following points when wiring the power supply system.

- Install a noise filter near the safety I/O terminal power supply feed section.
- Use an isolating transformer to significantly reduce noise between the product and the earth. Install the isolating transformer between the safety I/O terminal power supply and the noise filter, and do not earth the secondary coil of the transformer.
- Keep the wiring between the transformer and the safety I/O terminal as short as possible, twist the wires well, and keep the wiring separate from high-voltage and power lines.

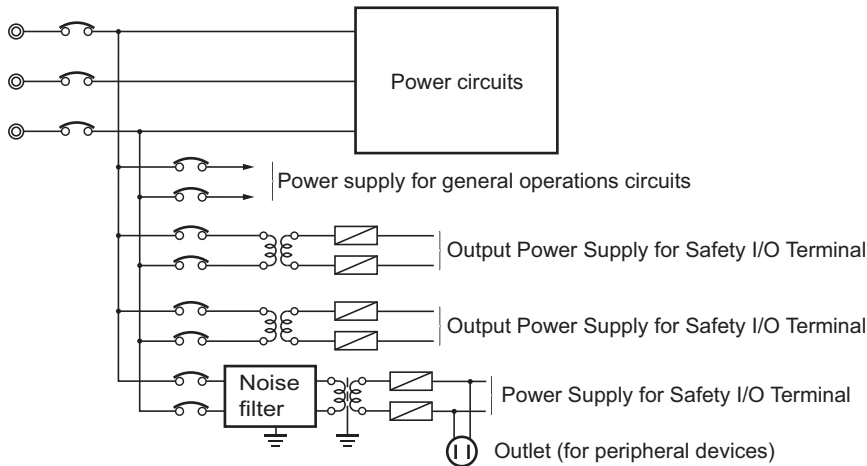

Power Supply System Diagram

Wiring External I/O Signal Lines

Observe the following points when wiring external I/O signal lines.

- To absorb reverse electromotive force when an inductive load is connected to an output signal, connect a diode near the inductive load in a DC circuit.

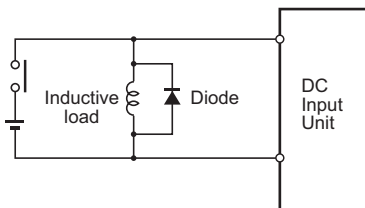

Connect a diode in a DC circuit.

Input Signal Noise Countermeasures

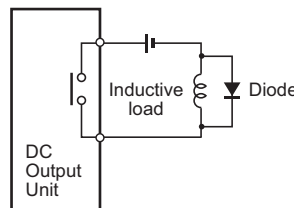

Connect a diode in a DC circuit.

Output Signal Noise Countermeasures

- Never bundle output signal lines with high-voltage or power lines, and do not route them in close proximity or parallel to such lines.

If output signal lines must be routed in close proximity to such lines, place them in separate ducts or conduits. Be sure to earth the ducts or conduits.

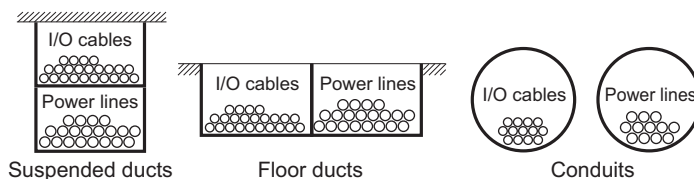

I/O Cable Arrangement

- If the signal lines and power lines cannot be routed in separate ducts, use shielded cable. Connect the shield to the earth terminal at the safety I/O terminal, and leave it unconnected at the input device.
- Wire the lines so that common impedance does not occur.
Such wiring will increase the number of wires, so use common return circuits.
Use thick wires with sufficient allowance for the return circuits, and bundle them with lines of the same signal level.
- For long I/O lines, wire the input and output signal lines separately.
- Use twisted-pair wires for pilot lamps (and particularly lamps with filaments).
- Use countermeasures, such as CR surge absorbers and diodes, for input device and output load device noise sources, as required.

External Wiring

Wiring, and noise countermeasures in particular, are based on experience, and it is necessary to closely manage wiring based on experience and information in the manuals.

● Wiring Routes

Each of the following combinations includes different signal types, properties, or levels. They will cause the signal-to-noise ratio to drop due to factors such as electrical induction. As a general rule when wiring, either use separate cables or separate wiring routes for these items. Future maintenance operations and changes to the system will also be made easier by carefully organizing the wiring from the start.

- Power lines and signal lines
- Input signals and output signals
- Analog signals and digital signals
- High-level signals and low-level signals
- Communications lines and power lines
- DC signals and AC signals
- High-frequency devices (such as Inverters) and signal lines (communications)

● Wiring

Observe the following points when wiring power supply and signal cables.

- When routing signal cables with differing characteristics through the same duct, always keep them separated.
- As much as possible, avoid routing multiple power supply lines through the same duct.
If it cannot be avoided, then construct a partition between them in the duct and earth the partition.

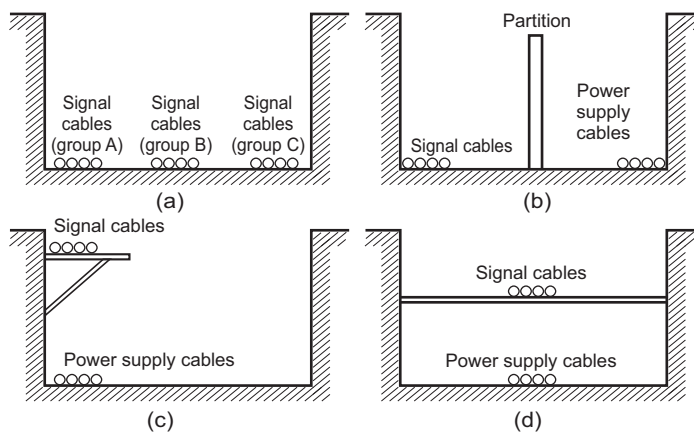

Partitioning Methods for Signal and Power Supply Cables

- To avoid overheating the conduits when using conduits for wiring, do not place wires for a single circuit in separate conduits.

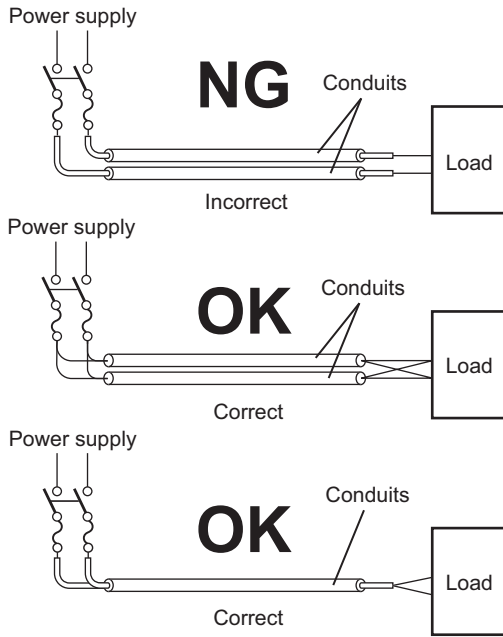

Parallel Wiring (Single Phase)

- Power cables and signal cables adversely affect each other. Do not wire them in parallel.
- Noise induction may occur if the Controller is installed in a panel that includes high-voltage devices. Wire and install them as far apart as possible. (Refer to *Safety I/O Terminal Installation Location* on page 4-45.)
- Either install the safety I/O terminal a minimum of 200 mm away from high-voltage lines or power lines, or place the high-voltage lines or power lines in metal tubing and earth the metal tubing.

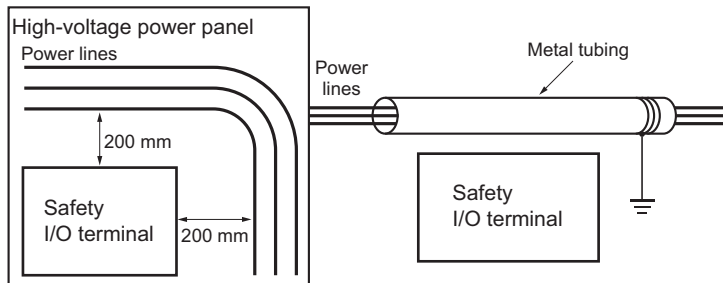

Example: Separating safety I/O terminal from Power Lines

4-3-6 Earthing

This section describes the earthing methods and precautions.

Considerations for Earthing Methods

Local potential fluctuations due to lightning or noise occurred by power devices will cause potential fluctuations between earth terminals of devices. This potential fluctuation may result in device malfunction or damage. To prevent this, it is necessary to suppress the occurrence of a difference in electrical potential between earth terminals of devices. You need to consider the earthing methods to achieve this objective.

The recommended earthing methods for each usage condition are given in the following table.

Specification of communications cables for EtherCAT and EtherNet/IP	Earthing methods			
	Equipoten- tial bonding system	Star earthing		Daisy chain
		Connecting devices and noise sources to separate earth elec- trodes	Connecting devices and noise sources to a common earth electrode	
The cable shield connected to the connector hood at both ends of the communications cable	Recom- mended	Recommended	Not recom- mended	Not recom- mended



Additional Information

- In a country or region where the earthing method is regulated, you must comply with the regulations. Refer to the applicable local and national ordinances of the place where you install the system, or other international laws and regulations.
- Ethernet switches are used with the EtherNet/IP. For information on the environmental resistance of the Ethernet switch to use, the earthing between Ethernet switches, or the specifications of cables, ask the Ethernet switch manufacturer.

● Equipotential Bonding System

Equipotential bonding is an earthing method in which steel frames and building structures, metal ducts and pipes, and metal structures in floors are connected together and make connections to the earth trunk line to achieve a uniform potential everywhere across the entire building. We recommend this earthing method.

The following figure shows an example of an equipotential bonding system.

Connect the main earthing terminal and building structures together with equipotential bonding conductors and embed the mesh earth line in each floor.

Connect the earth line of each control panel to the equipotential bonding system.

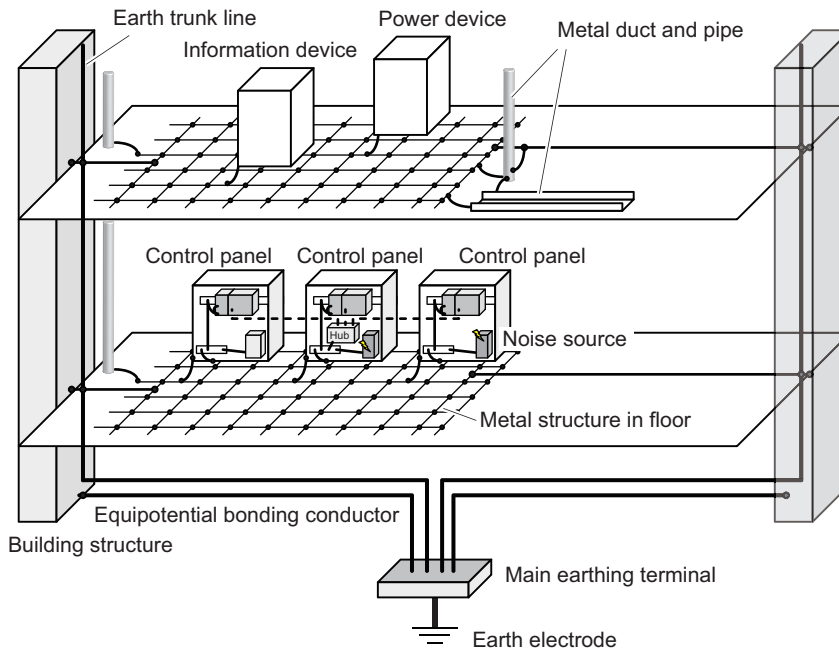

● Star Earthing

If the earthing method used for the building is not equipotential bonding or the earthing system is unknown, choose a) from among the earthing methods given below.

a) Connecting devices and noise sources to separate earth electrodes

This is an earthing method to separately earth an earth electrode of the device that is connected with a communications cable or other devices and an earth electrode of a high-power device that could be a noise source, such as a motor or inverter.

Connect the earth lines of the device that is connected with a communications cable and other devices as a bundle to a single earth electrode. Be sure that the earth electrode is separated by a minimum of 10 m from any other earth electrode of a device that could be a noise source.

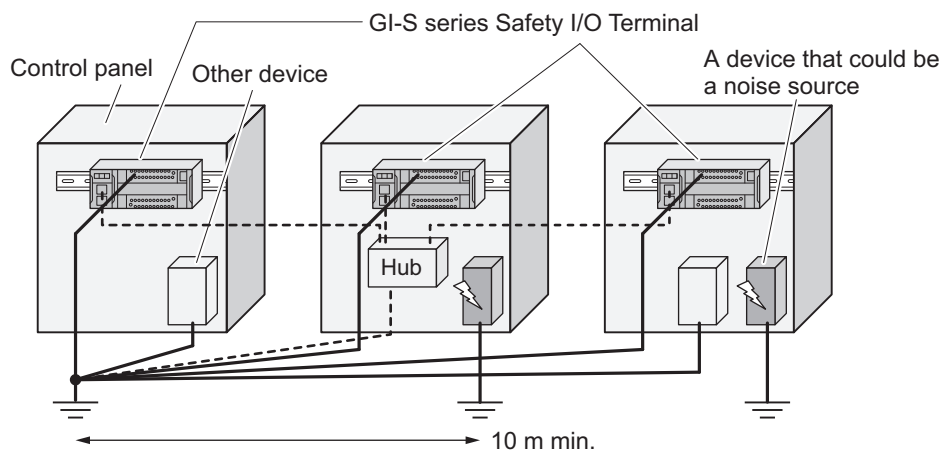

b) Connecting devices and noise sources to a common earth electrode

This is an earthing method to connect the device that is connected with a communications cable, other devices, and a device that could be a noise source, to a common earth electrode.

This earthing method is not recommended because the device that could be a noise source may interfere electromagnetically with other devices.

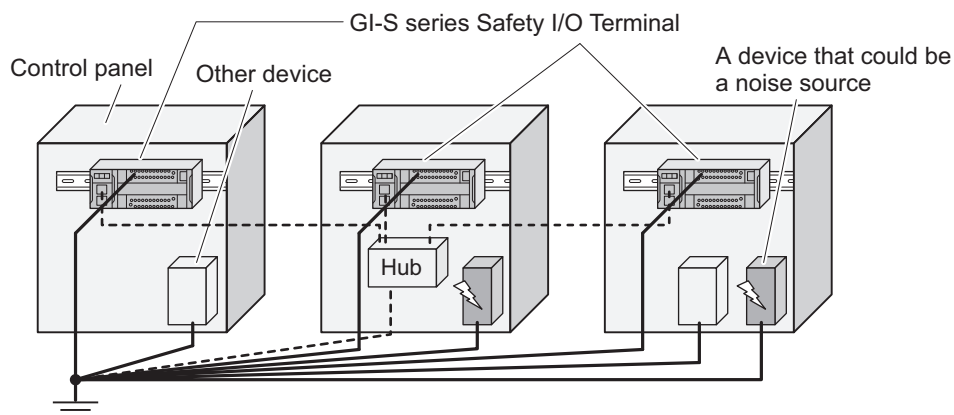

● **Daisy Chain**

This is an earthing method to connect the device that is connected with a communications cable, other devices, and a device that could be a noise source using a daisy-chain topology to a common earth electrode.

This earthing method is not recommended because the device that could be a noise source may interfere electromagnetically with other devices.

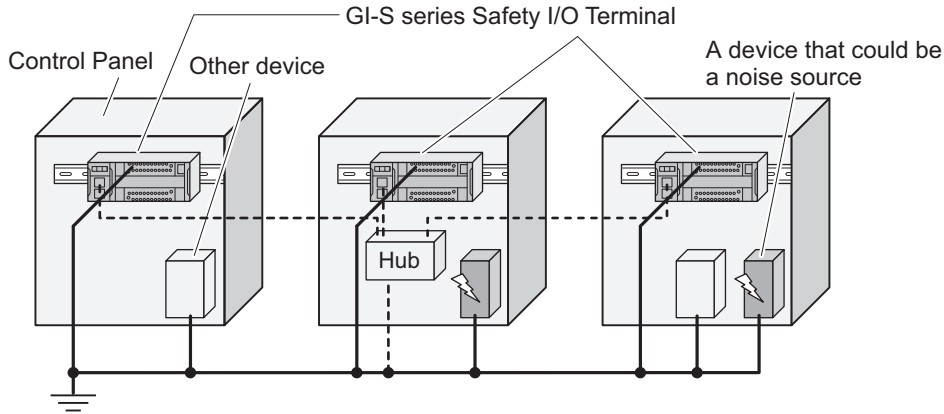

Precautions for Earthing

● **General Precautions**

- To prevent electrical shock, do not connect devices to earth poles (or steel frames) with non-equalized potential to which multiple devices are connected.
- Use a earth pole as close to the safety I/O terminal as possible and keep the earth line as short as possible.
- If high-frequency equipment is present, then earth not only the high-frequency equipment but also the panel itself in which the safety I/O terminal is housed.
- As shown in the following diagram, when using shielded cable for I/O wiring, connect the shield near the safety I/O terminal to the enclosure earth terminal. Follow the instructions in the Communications Unit manual for preparing shielded communications cable.

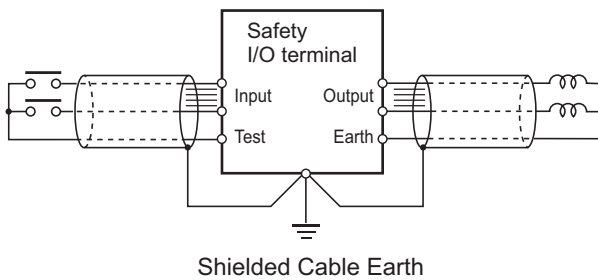

● **Safety I/O Terminal Earth Terminals**

The safety I/O terminal has the following earth terminal.

Earthing type	Symbol	Connection
Functional Earthing		Earth this terminal when power supply noise causes malfunctioning.

When the functional earth terminal is correctly earthed, it is generally effective in suppressing power supply common noise. Occasionally, however, earthing this terminal will result in picking up more noise, so be careful when using it.

5

Safety I/O Terminal Operation

This chapter provides information that is necessary to use the safety I/O terminal, including how the safety network controller and safety I/O terminal work.

5-1 Overview of CIP Safety Communications and Tag Data Link Operation	5-2
5-1-1 Overview of CIP Safety Communication	5-2
5-1-2 Introduction to Tag Data Links	5-4
5-2 Input/Output Mechanism	5-10
5-2-1 Relation between Signal Types and Communication Types	5-10
5-2-2 Variable Data Type	5-10
5-3 Safety I/O Functions	5-11
5-3-1 Safety Input Function	5-11
5-3-2 Safety Output Function	5-25

5-1 Overview of CIP Safety Communications and Tag Data Link Operation

This section provides operational overview of safety I/O unit and safety I/O terminal. The safety I/O unit materializes safety control by executing safety programs and I/O refresh. The Safety CPU Unit accesses target data for I/O refresh via variables and executes safety programs. Also, it uses "safety process data communications" and "standard process data communications" to perform I/O refresh.

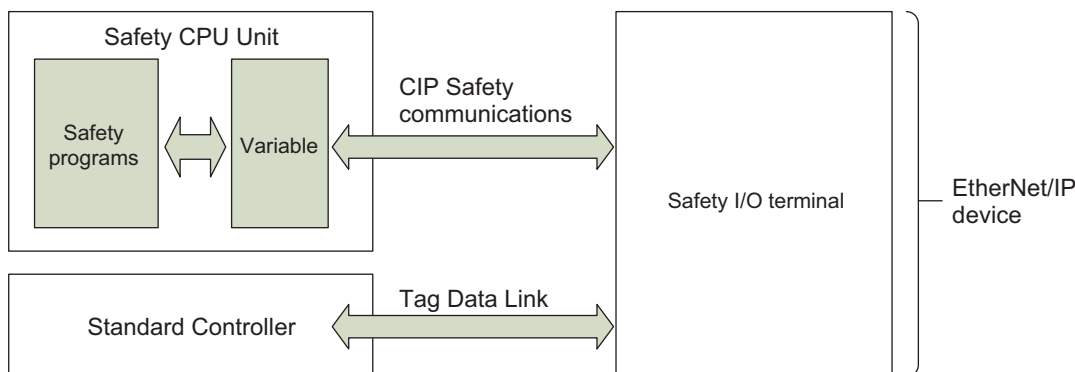

Communication type		Description
Safety process data communications	CIP Safety Communications	Safety communications with CIP Safety devices on the EtherNet/IP network, used for communications with the safety I/O terminal and other safety network controllers.
Standard process data communications	Tag Data Link	Standard communications with EtherNet/IP devices on the EtherNet/IP network. It is used for communications with the standard controller.

5-1-1 Overview of CIP Safety Communication

CIP Safety communications is a function to cyclically exchange data between Safety CPU Unit and safety I/O terminal or between Safety CPU Units. The Safety CPU Unit acts as the CIP Safety originator and requests establishment of CIP Safety connection to the safety I/O terminal as the CIP Safety target. Also, the Safety CPU Unit can act as the CIP Safety target and publish its own dataset to other Safety CPU Units. The communication control unit relays CIP Safety communications between Safety CPU Unit and safety I/O terminal or between Safety CPU Units.

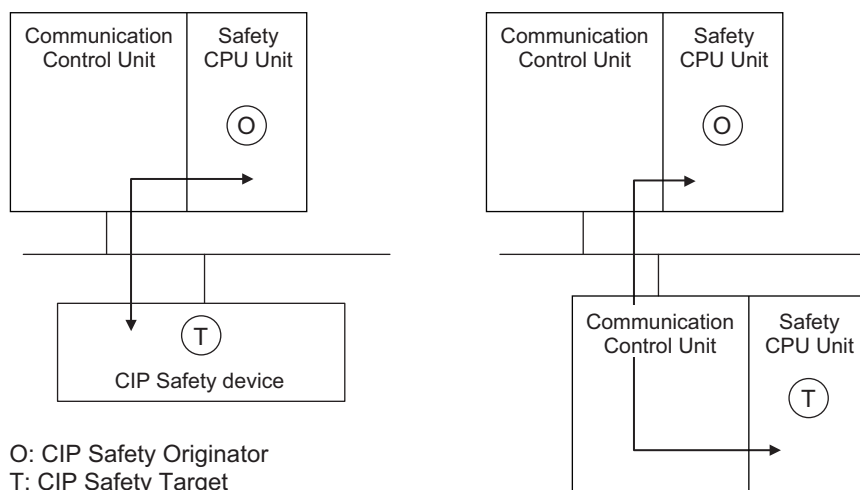

Connection Setting Parameters

The connection setup involves the following setting parameters.

- **Data packet interval (EPI) setting**
Data packet interval (EPI: Expected Packet Interval) is a cycle of input/output data update on the Ethernet line for CIP Safety. EtherNet/IP exchanges data on a communication line with the EPI configured for each connection, not depending on the number of nodes. With the built-in EtherNet/IP port, you can set EPI for each connection. EPI affects safety reaction time.
- **Setting Multi-cast and Unicast Communications**
You can select a multi-cast connection or single-cast (point-to-point) connection as the connection type in the CIP Safety connection settings.
The multi-cast connection allows transmission of one input assembly per packet to multiple originator devices.
The single-cast connection sends one input assembly to one originator device individually. Therefore, multi-cast connections can decrease the communications load if one input assembly is sent to multiple originator devices.
Note that transmission of one input assembly per packet to multiple originator devices using multi-cast connection is available only if the type of each connection is multi-cast with the same values of all of the connection I/O type, data packet interval (EPI), and timeout.



Precautions for Correct Use

- The performance of communications devices is limited to some extent by the limitations of each product's specifications. Consequently, there are limits to the data packet interval (EPI) settings.
 - Refer to *NX-series Safety Control Unit/Communication Control Unit User's Manual* (Cat. No. Z395), and set an appropriate data packet interval (EPI).
- If multi-cast connections are used, however, use an Ethernet switch that has multi-cast filtering, unless tag set is received by all nodes in the network. If an Ethernet switch without multi-cast filtering is used, multi-cast packets are broadcast to the entire network, and so the packets are sent to nodes that do not require them, which will cause the communications load on those nodes to increase.



Additional Information

If the maximum number of connections is exceeded, you must review the number of connections for the built-in EtherNet/IP port, or the number of nodes.

5-1-2 Introduction to Tag Data Links

Tag Data Links

Tag data links enable cyclic tag data exchanges on an EtherNet/IP network between Controllers or between Controllers and other devices. Variables are assigned to tags. The settings for tag data links are made with the Sysmac Studio or Network Configurator. For the details on the settings, refer to *NX-series Safety Control Unit/Communication Control Unit User's Manual (SGFM-723)*. With a tag data link, one node requests the connection of a communications line to exchange data with another node. The node that requests the connection is called the originator, and the node that receives the request is called the target.

Configuring Safety I/O Terminal Tag Data Links

This section describes how to configure the tag data link of the safety I/O terminal using the Sysmac Studio.

I/O assembly data of the safety I/O terminal available for the tag data link is Input Data (Assembly 768 - 300 Hex), Size: 13 byte(s).



Precautions for Correct Use

To use the tag data link, select the I/O assembly other than [Safety Global Input - [13Bytes]] for CIP Safety I/O communications.

You cannot use the tag data link and the I/O assembly [Safety Global Input - [13Bytes]] for CIP Safety I/O communications at the same time.

- 1 Register variables of 13 bytes to the global variable and set [Network Publish] to [Input].

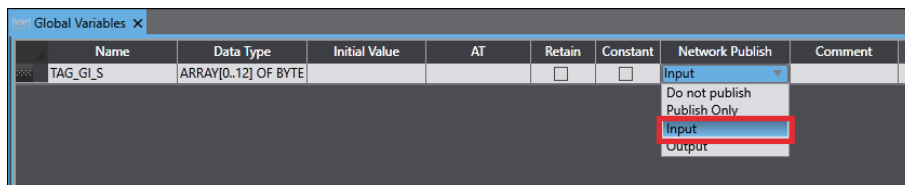

- 2 Select the standard PLC (initially displayed as new_Controller_0) in [Multiview Explorer] and select [Tools] - [EtherNet/IP Connection Settings] from the menu bar at the top of the screen.

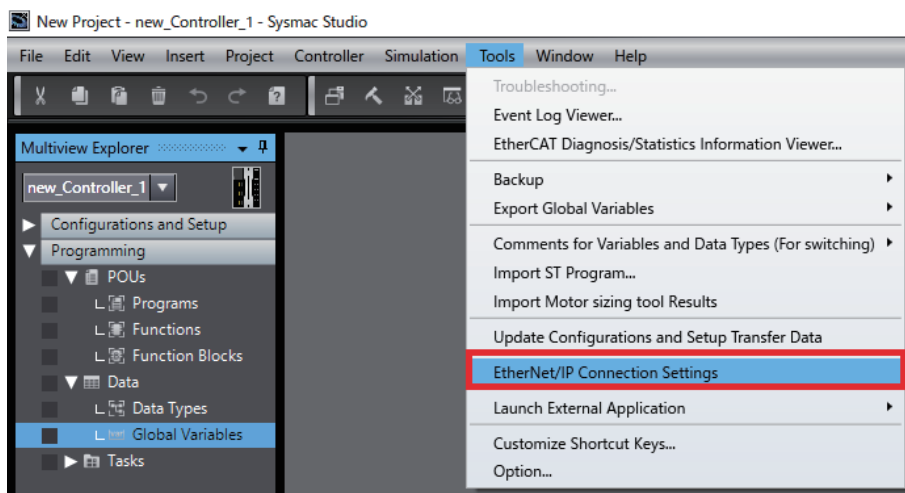

- 3 Double-click the network you want to configure the tag data link, or right-click on the network and select [Edit] from the menu.

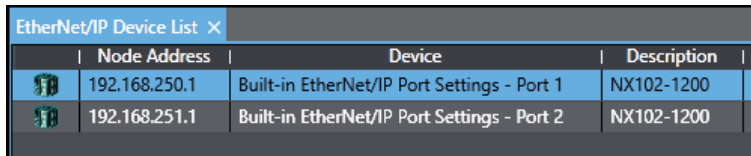

Node Address	Device	Description
192.168.250.1	Built-in EtherNet/IP Port Settings - Port 1	NX102-1200
192.168.251.1	Built-in EtherNet/IP Port Settings - Port 2	NX102-1200

- 4 The following window is displayed. Make sure that the [Input] tab is selected, and click [Resig-
stration All].

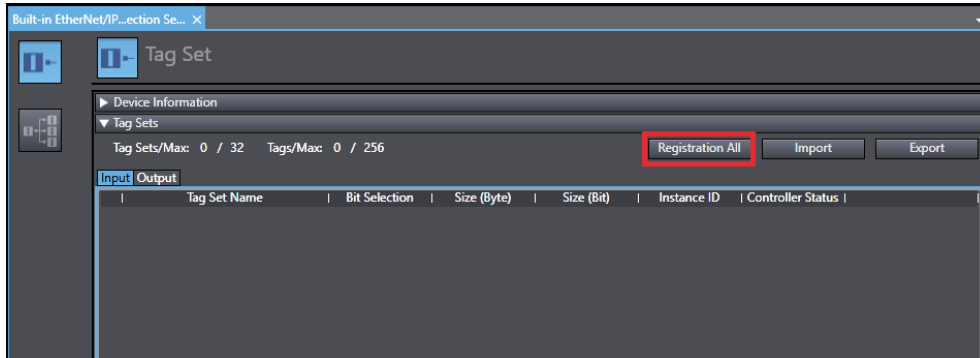

- 5 The following window is displayed. Make sure that the variables registered in Step 1 and config-
ured to Input for Network Publish are displayed, and click [Register].

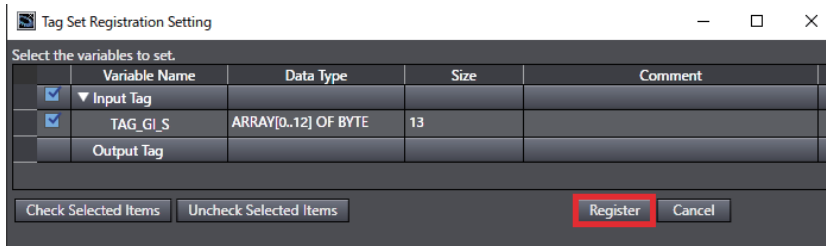

- 6 The tag set is registered as shown below.

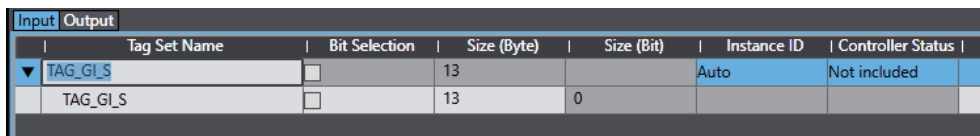

Tag Set Name	Bit Selection	Size (Byte)	Size (Bit)	Instance ID	Controller Status
TAG_GI_S	[]	13	[]	Auto	Not included
TAG_GI_S	[]	13	0	[]	[]

- 7 Click the [+] button on the [Target Device] screen, enter the IP address, model name, and revision of the target, and click the [Add] button.

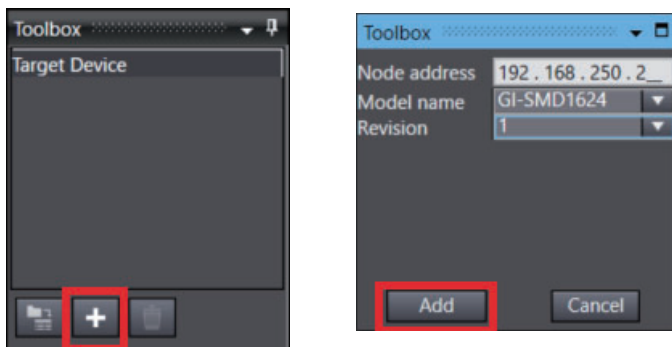

If the model name is not in the pull-down list, install the EDS file using the following steps from 1 to 4.

- Step 1. Get the EDS file of the safety I/O terminal.
To get the EDS file, please visit our site
(<https://www.fa.omron.co.jp/products/family/3735/download/software.html>).
- Step 2. Right-click on the [Target Device] screen and click [Display EDS Library].

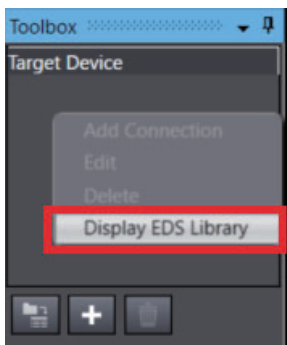

- Step 3. On the window shown below, click [Install].



- Step 4. Select the EDS file of the safety I/O terminal acquired in the Step 1 and start installation.

- Click [Connection] and the Connection Settings screen is displayed. The target information added above is displayed in the Target Device field. Drag and drop it to the Connection window.

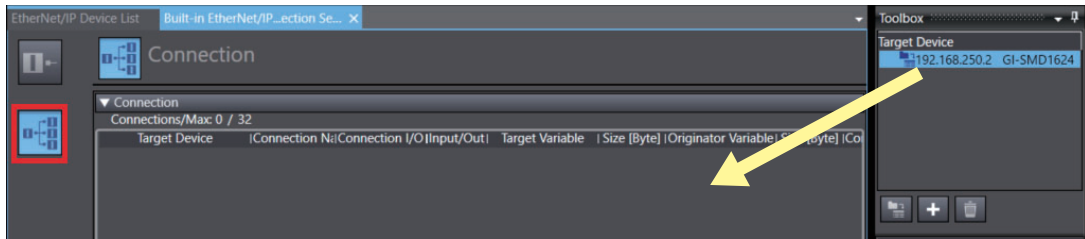

- The Connection screen is displayed as shown below. Enter the target and originator variables.

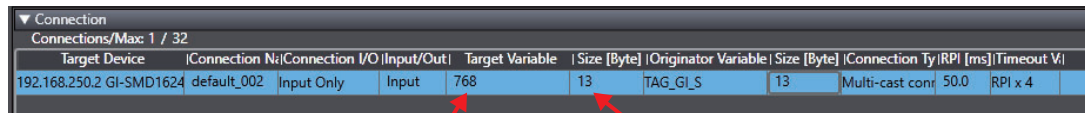

- Input Data (Assembly **768** - 300 Hex), Size: **13 byte(s)**

	Byte Offset	Bit 15	Bit 14	Bit 13	Bit 12	Bit 11	Bit 10	Bit 9	Bit 8	Bit 7	Bit 6	Bit 5	Bit 4	Bit 3	Bit 2	Bit 1	Bit 0
Safety Inputs	00	n/u	n/u	n/u	n/u	Safety Input I ₁₁	Safety Input I ₁₀	Safety Input I ₉	Safety Input I ₈	Safety Input I ₇	Safety Input I ₆	Safety Input I ₅	Safety Input I ₄	Safety Input I ₃	Safety Input I ₂	Safety Input I ₁	Safety Input I ₀
Safety Input Status	02	n/u	n/u	n/u	n/u	Safety Input Status I ₁₁	Safety Input Status I ₁₀	Safety Input Status I ₉	Safety Input Status I ₈	Safety Input Status I ₇	Safety Input Status I ₆	Safety Input Status I ₅	Safety Input Status I ₄	Safety Input Status I ₃	Safety Input Status I ₂	Safety Input Status I ₁	Safety Input Status I ₀
Test Output Value	04	n/u	n/u	n/u	n/u	Test Output TO ₁₁	Test Output TO ₁₀	Test Output TO ₉	Test Output TO ₈	Test Output TO ₇	Test Output TO ₆	Test Output TO ₅	Test Output TO ₄	Test Output TO ₃	Test Output TO ₂	Test Output TO ₁	Test Output TO ₀
Test Output Status	06	n/u	n/u	n/u	n/u	Test Output Status TOS ₁₁	Test Output Status TOS ₁₀	Test Output Status TOS ₉	Test Output Status TOS ₈	Test Output Status TOS ₇	Test Output Status TOS ₆	Test Output Status TOS ₅	Test Output Status TOS ₄	Test Output Status TOS ₃	Test Output Status TOS ₂	Test Output Status TOS ₁	Test Output Status TOS ₀
Safety Output Monitoring	08	n/u	n/u	n/u	n/u	n/u	n/u	n/u	n/u	n/u	n/u	n/u	n/u	Safety Output Monitoring O ₃	Safety Output Monitoring O ₂	Safety Output Monitoring O ₁	Safety Output Monitoring O ₀
Safety Output Status	10	n/u	n/u	n/u	n/u	n/u	n/u	n/u	n/u	n/u	n/u	n/u	n/u	Safety Output Status O ₃	Safety Output Status O ₂	Safety Output Status O ₁	Safety Output Status O ₀
Miscellaneous	12									Input Over Current Error UB	Output Over Current Error UL	Muting Lamp Status TO ₇	Muting Lamp Status TO ₃	Global Safety Input Status CIS	Global Safety Output Status COS	Input Power Error UB	Output Power Error UL

The target variable and its size must be Assembly and Size values listed in the [A-2 Safety I/O Assembly Data](#) on page A-3.

Select the originator value from the pull-down list as the tag set name configured in Step 6.

Configure [Connection I/O Type], [Connection Type], [RPI], and [Timeout Value] as necessary.

10 Write the tag set and connection settings to the device.

- To transfer tag data link settings only

In the following screen, click [Transfer to Controller].

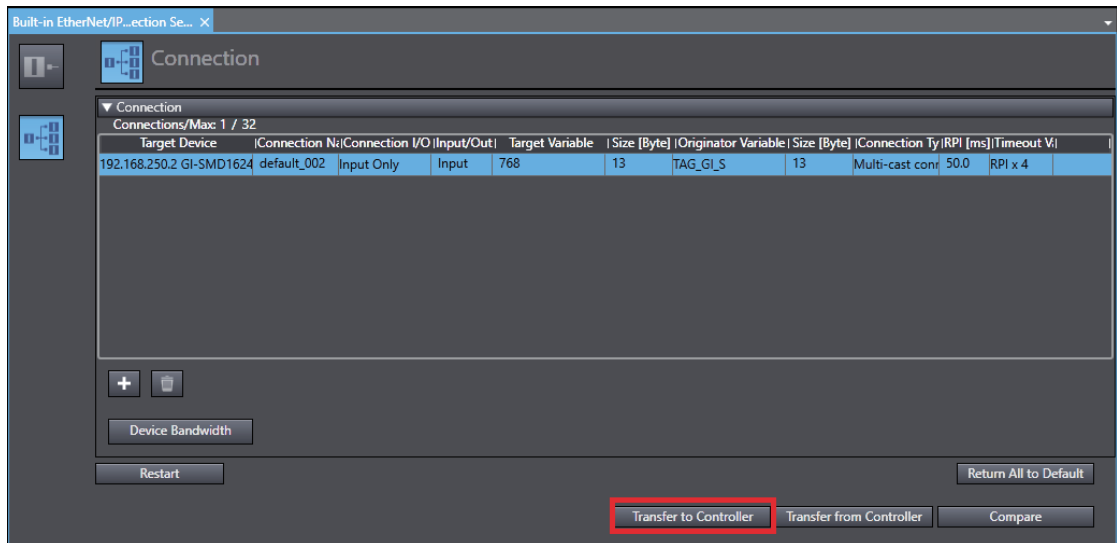

- To synchronize all including program

In the following screen, unselect the [Do not transfer the EtherNet/IP connection settings (i.e., tag data link settings)] check box and then click [Transfer to Controller].

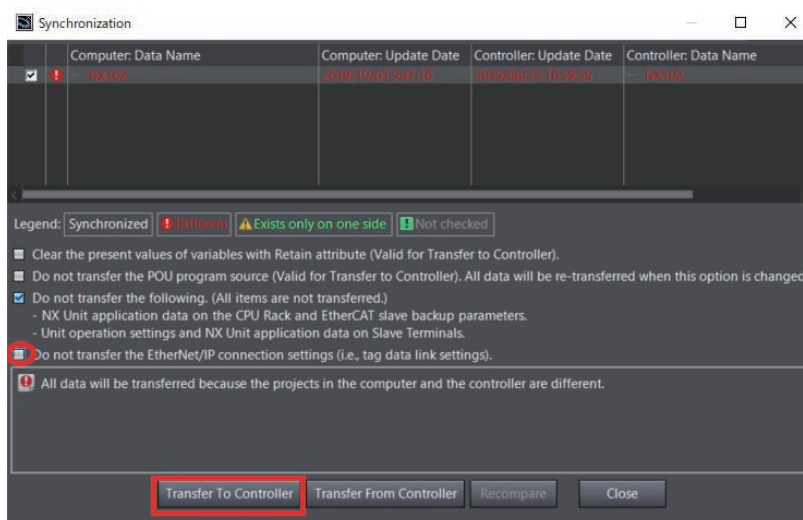

Connection I/O Type (Input Only, Listen Only)

Connection I/O Type	Description
Input Only	You can monitor the safety I/O assembly data from a single originator device using the Input Only connection.
Listen Only	If you want to monitor from multiple originator devices, use the Listen Only connection for originator devices other than the Input Only one. You can monitor from up to 7 originator devices.

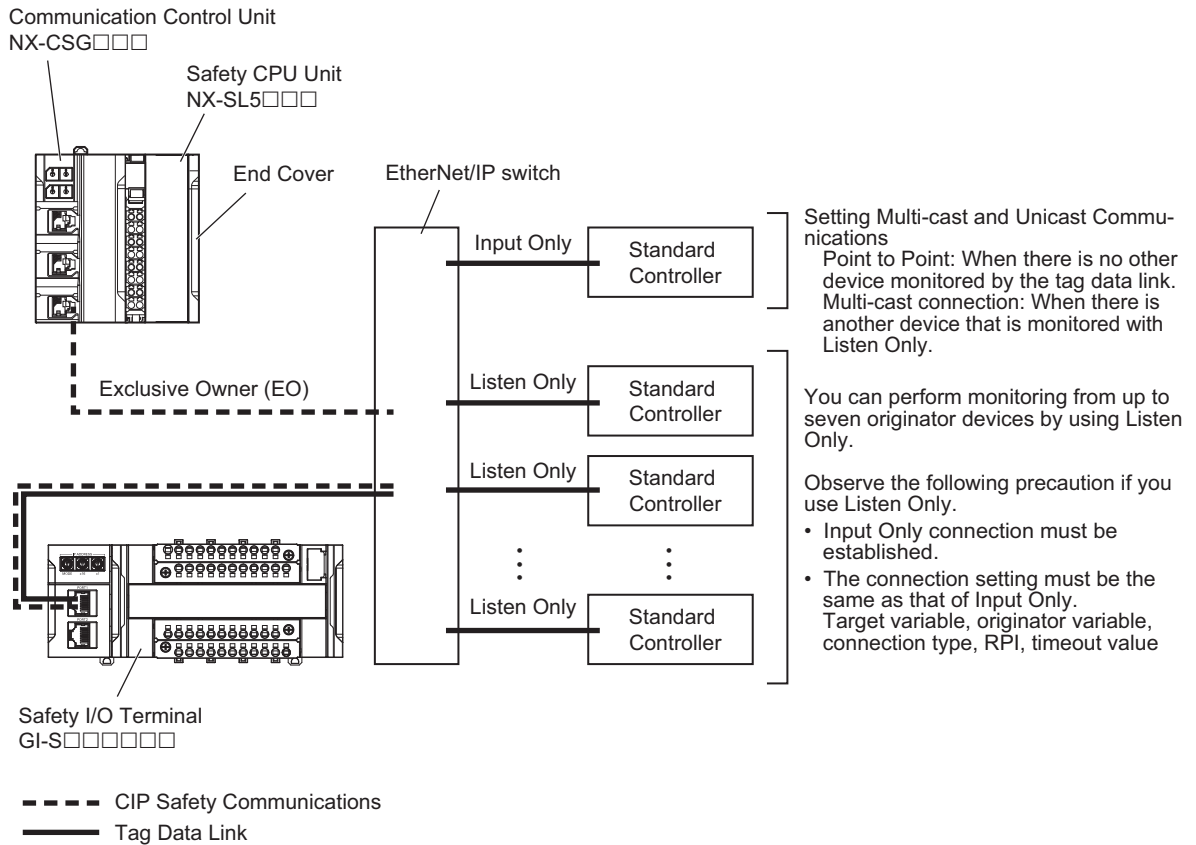

5-2 Input/Output Mechanism

This section describes how the Safety CPU Unit processes I/O with external devices such as Safety I/O Terminal

When the Safety CPU Unit exchanges signals with Safety I/O Terminal and other external devices, it does so through logical interfaces that are called "I/O Ports".

I/O Ports are created automatically when you create the control configuration for safety controls on the Sysmac Studio and set up the safety process data communications.

You assign device variables to I/O Ports to gain access to the external devices from the safety programs.

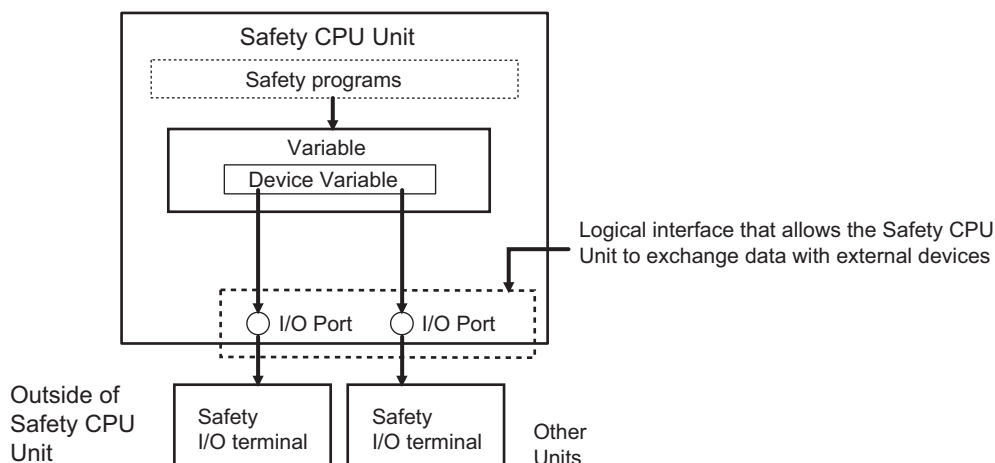

You can check the I/O Ports in the I/O Map of the Sysmac Studio.

5-2-1 Relation between Signal Types and Communication Types

☐ Refer to *NX-series Safety Control Unit/Communication Control Unit User's Manual* (Cat. No. Z395) for input/output signal exchange and relationship between communication types.

5-2-2 Variable Data Type

☐ Refer to *NX-series Safety Control Unit/Communication Control Unit User's Manual* (Cat. No. Z395) for data types of variables.

5-3 Safety I/O Functions

This section provides description of safety input/output functions of the safety I/O terminal.

5-3-1 Safety Input Function

Available Input Device

The safety I/O terminal performs diagnosis of connected external devices using the safety input terminals.

Shown below are safety input devices and standard input devices that can be connected to the safety input terminals of the safety I/O terminal.

Input device name	Input device type	Contact type
Emergency stop pushbutton switch	Mechanical contact	Single channel Dual-channel equivalent input
Safety door switch	Mechanical contact	Single channel Dual-channel equivalent input Dual-channel complementary input
Safety limit switch	Mechanical contact	Single channel Dual-channel equivalent input Dual-channel complementary input
2-hand switch	Mechanical contact	Dual-channel complementary input
Safety key selector switch	Mechanical contact	Single channel Dual-channel equivalent input Dual-channel complementary input
Enable switch	Mechanical contact	Dual-channel equivalent input
EDM feedback	Mechanical contact	Single channel
Reset switch	Mechanical contact (standard input)	Single channel (w/ test pulse) Single channel (w/o test pulse)
Safety light curtain	Semiconductor output type	Dual-channel equivalent input
Safety laser scanner	Semiconductor output type	Dual-channel equivalent input

Above settings can be configured as the following general-purpose input devices.

Type	Possible settings
Safety input devices with mechanical contacts <ul style="list-style-type: none"> Mechanical Contact for Single Channel Mechanical Contact for Dual Channel Equivalent Mechanical Contact for Dual Channel Complementary 	Emergency stop switch, safety door switch, safety limit switch, two-hand switches, safety key selector switch, Enabling switch, and EDM feedback
Safety input device with semiconductor output <ul style="list-style-type: none"> Semiconductor Output for Single Channel Semiconductor Output for Dual Channel Equivalent Semiconductor Output for Dual Channel Complementary 	Safety light curtain and safety laser scanner

How to Configure Safety Functions

Safety functions of safety input terminals can be easily configured by selecting an external device type to connect using Sysmac Studio. For external devices, refer to *5-3 Safety I/O Functions* on page 5-11. For the setup procedure with the Sysmac Studio, refer to *Section 6 Settings* on page 6-1.

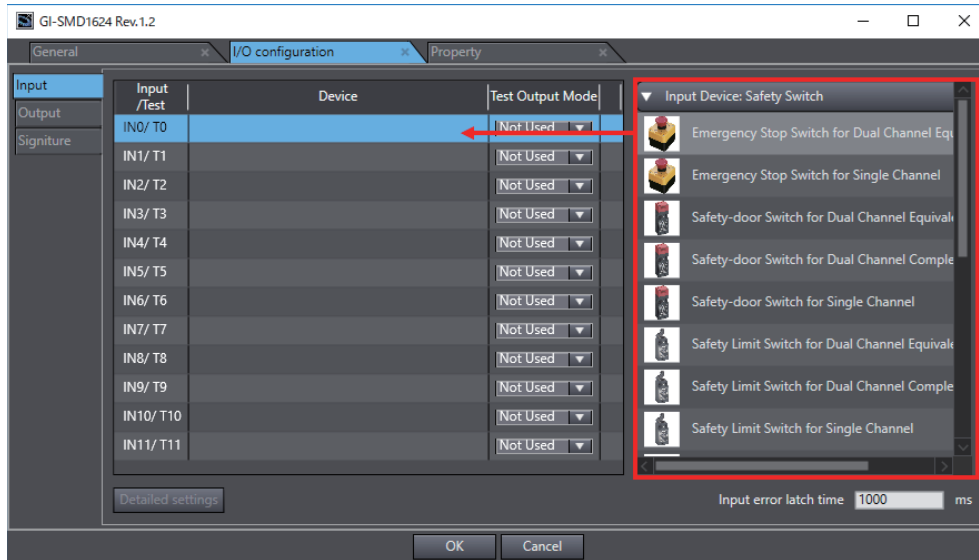

How to Connect Input Device

This section describes how to connect input devices. Each terminal has a label with a number from 0 to 11 indicating the terminal place. Use the same number for input terminal and test output terminal to use.

☐ Refer to *Test Output Terminal Channel Mode Setting* on page 5-18 for details on test output terminal.

● Mechanical contact device

Devices with a mechanical contact such as emergency stop pushbutton switches and safety limit switches are used combining a safety input terminal ((IN☐) with a test output terminal (T☐).

- Single-channel input

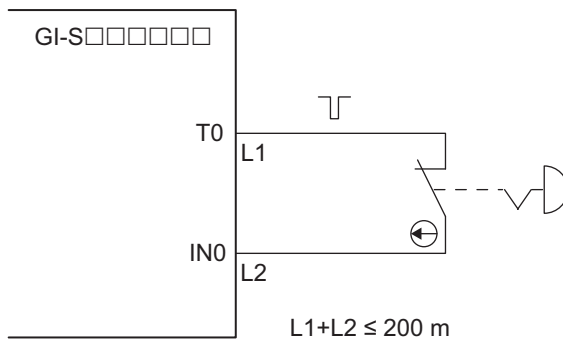

Sysmac Studio setting example:

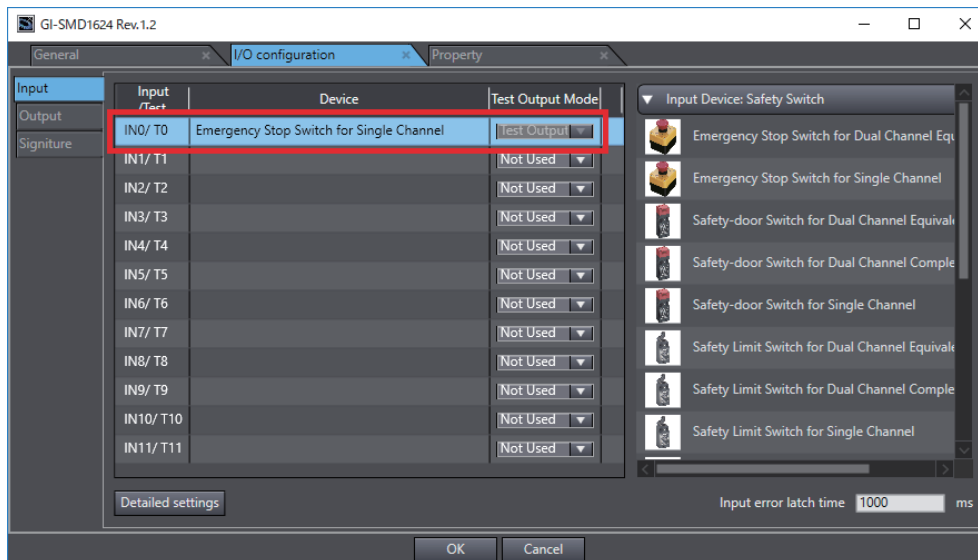

Precautions for Correct Use

The total wiring length of cable that can be connected from the test output terminal to the input device ($L1 + L2$) is 200 m max.

- Dual-channel input

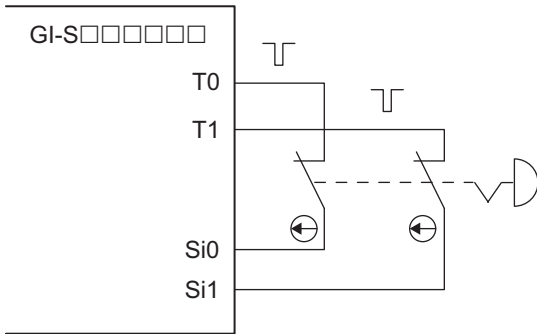

Sysmac Studio setting example:

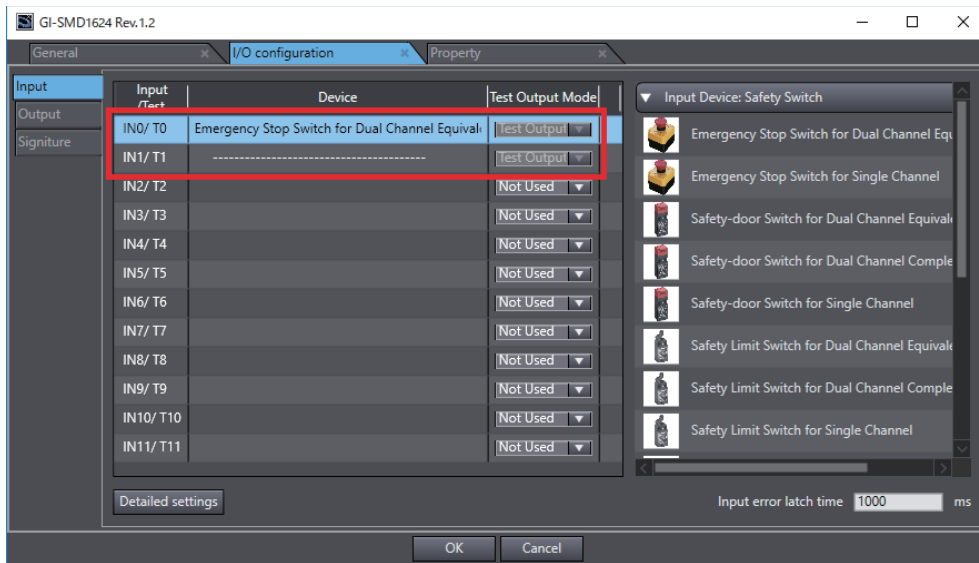

- Semiconductor output device
 Signals from a semiconductor output device, such as a safety light curtain, are input to safety input terminals (IN□).
 If a safety sensor or a semiconductor output type is set for the input device, Test Output Mode of the corresponding test output terminals (T□) will be Power Supply.

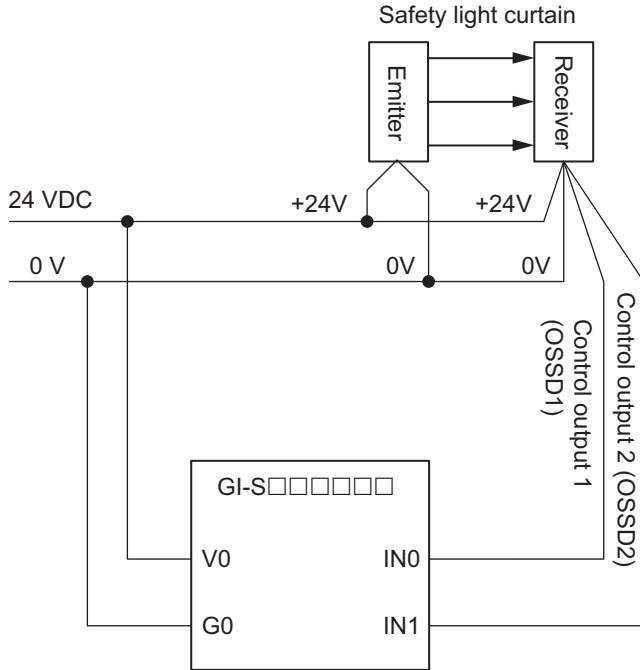

Sysmac Studio setting example:

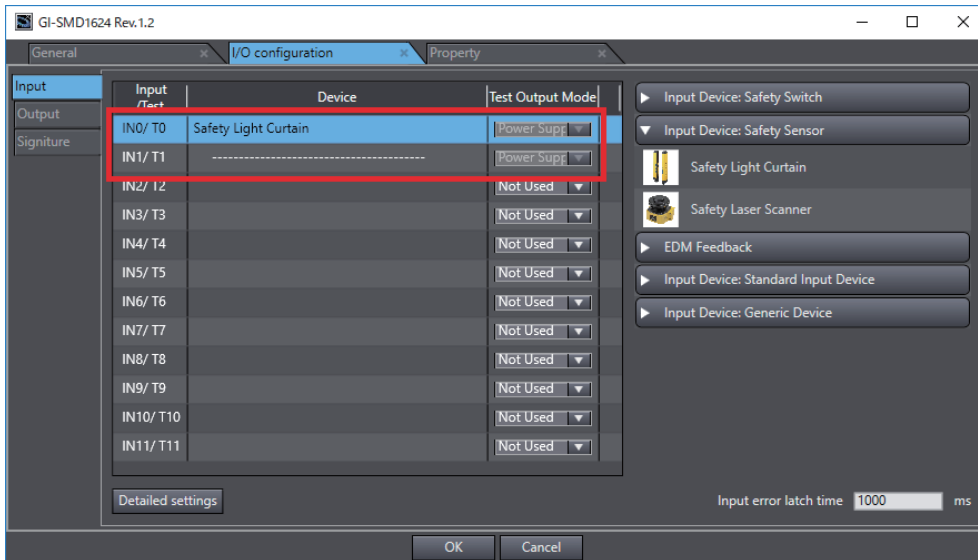



Precautions for Correct Use

Safety devices with semiconductor outputs, such as safety light curtains, sometimes provide a pulse output that is used to detect wiring errors. If the ON/OFF pulse width of a safety device to connect does not meet the following, set a delay time more than the ON/OFF pulse width of the safety device to connect.

☐ Refer to 6-3-5 *Configuring the Safety I/O Functions* on page 6-14 for how to set the delay time.

- OFF pulse width when semiconductor output is ON: 60 μ s max.

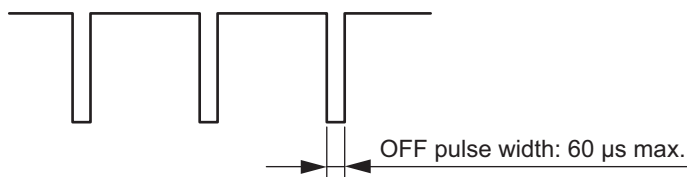

- ON pulse width when semiconductor output is OFF: 10 μ s max.

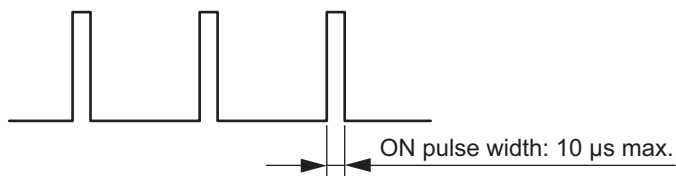

Check the specifications of the connected device for the maximum cable length.

Safety Input Function Types

This section describes types of safety input functions of safety I/O terminal.

Safety input functions perform evaluation of safety signal provided for safety input terminals and generation of safety input data available for safety programs.

The safety input functions consist of the following functions.

The value provided for the safety input terminal is evaluated by the safety input functions and passed to a safety program.

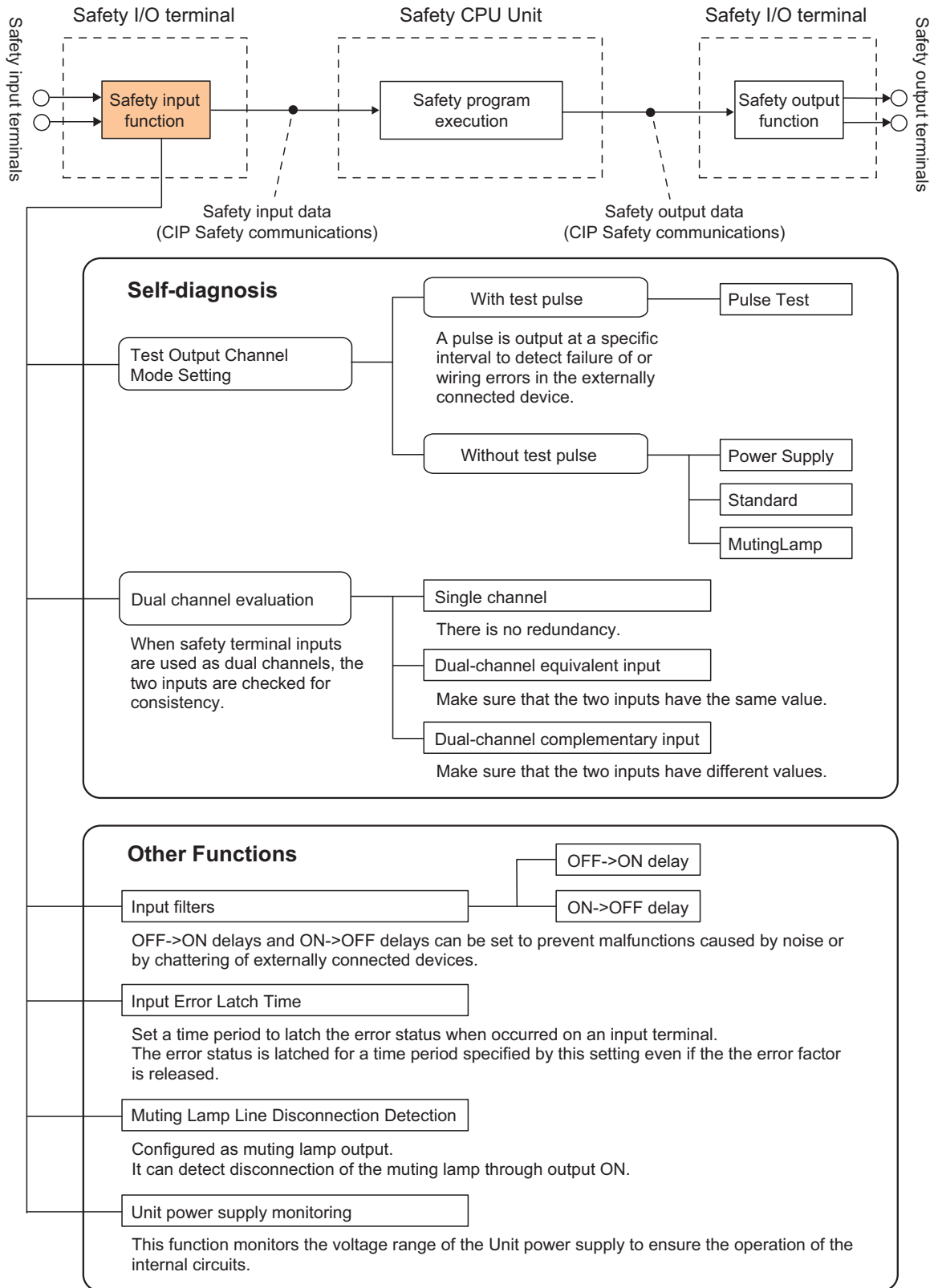

Details of each safety input function is described in the following pages.

Test Output Terminal Channel Mode Setting

⚠ WARNING

Required safety functions will be lost, and death due to injury may possibly occur. Do not use GI-S Series' test output as the safety output line.



This function outputs 24 VDC signal with regular test pulse from the test output terminal to detect fault of the device or bad hard wiring. The following items are available as test output terminal channel mode setting.

With or without test pulse	Test output terminal Channel mode setting	Description
W/ test pulse	Test Output	Used to connect an input device with a mechanical contact. The test output signal (test pulse) is input to the safety input terminal through the contact. The following can be detected: Contact of the input signal line with the positive side of the power supply line and short-circuits to the other input signal lines.
W/o test pulse	Power Supply	To be used as power for connected external devices. It provides voltage (24VDC) output supplied from the test output terminal to the unit power supply terminal.
	Standard	Used as non-safety digital signal output terminal. For instance, it is connected to an indicator or PLC input for monitor output.
	Muting Lamp	Configured as muting lamp output. It can detect disconnection of the muting lamp through output ON. (Only T3 and T7 terminals are available for the purpose)

Test Pulse Width/Frequency

This section provides test pulse conditions.

Item	Condition
Test pulse width	2 ms (fixed value)
Test pulse frequency	12 ms (fixed value)

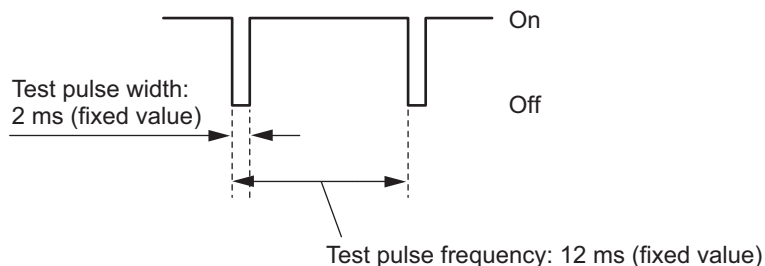

Dual Channel Evaluation

Safety input terminals can be used as dual channels (one pair). The dual channel evaluation evaluates the data for two inputs to check for discrepancy.

- Single Channel



- Dual-channel input (with using test pulse diagnosis)

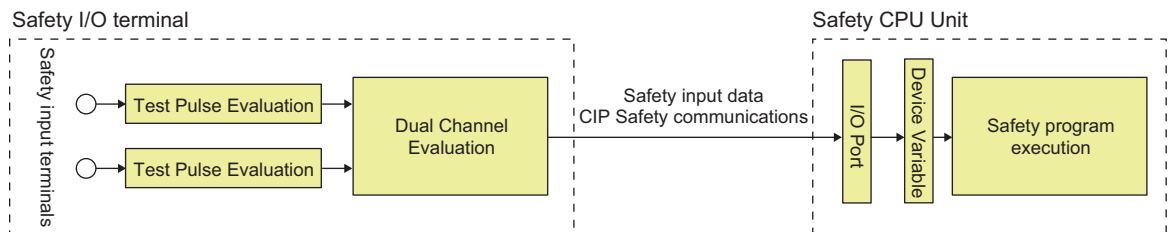

The following parameters are also used.

- Single/Dual
- Discrepancy Time

Setting	Description
Single Channel	The safety input terminals are used as independent safety input terminals.
Dual Channel Equivalent	The safety input terminals are used as dual-channel-equivalent inputs.
Dual Channel Complementary	The safety input terminals are used as dual-channel-complementary inputs.

● Dual-channel monitoring time

A time period while the input logic of two inputs configured for dual channel setting is inconsistent is monitored.

If the input logic remains inconsistent beyond the set time, it will be judged as an error.

This monitoring time ranges from 10 ms to 30 s and can be set in 10 ms steps.





If configured as the single channel, this monitoring time cannot be set.

● **Relation between single/dual setting and safety input data**

A signal inputted to a safety input terminal is evaluated as shown below. This safety input data can be used by safety programs of the Safety CPU Unit.

● **Relation between input signal of safety input terminal and safety input data (in case of single channel setting)**

The error detection status based on input signals and test pulses is evaluated; if an error occurs, the I/O Port value will become FALSE.













Input signal from safety input device	Support for error detection by test pulse *1	Value of I/O Port *1		LED indication on safety I/O terminal body		
		Safety Input Process Value	Safety Input Status	Color	Status	
OFF	Not supported	FALSE	TRUE	---		Not lit
ON	Not supported	TRUE	TRUE	Yellow		Lit
OFF	Supported	FALSE *2	FALSE	Red		Lit
ON	Supported	FALSE	FALSE	Red		Lit

*1 For the value of I/O Port,  refer to 6-3-4 Registering the I/O Assembly on page 6-9.

*2 Contact with a power line (positive) on the input terminal side can be detected.

● **Relation between input signal of safety input terminal and safety input data (in case of dual channel equivalent input)**

The error detection status based on input signals and test pulses is evaluated; if an error occurs or the input logic is mismatched (not equivalent), the I/O Port value will become FALSE.

Input signal from safety input device		Support for error detection by test pulse		Value of I/O Port *1				LED indication on safety I/O terminal body					
				Safety Input Process Value		Safety Input Status		Color	Status		Color	Status	
IN n	IN n+1	IN n	IN n+1	IN n	IN n+1	IN n	IN n+1	IN n			IN n+1		
OFF	OFF	Not supported	Not supported	FALSE	TRUE	TRUE	---		Not lit	---		Not lit	
OFF	ON	Not supported	Not supported	FALSE *2	FALSE *2	FALSE *2	Red		Lit	Red		Lit	
ON	OFF	Not supported	Not supported	FALSE *2	FALSE *2	FALSE *2	Red		Lit	Red		Lit	
ON	ON	Not supported	Not supported	TRUE	TRUE	TRUE	Yellow		Lit	Yellow		Lit	
---	---	Supported	---	FALSE	FALSE	FALSE	Red		Lit	Red		Flashing	
---	---	---	Supported	FALSE	FALSE	FALSE	Red		Flashing	Red		Lit	













*1 For the value of I/O Port,  refer to 6-3-4 Registering the I/O Assembly on page 6-9.

*2 It enters an error state due to input signal logic mismatch.

• **Relation between input signal of safety input terminal and safety input data (in case of dual channel complementary input)**

The error detection status based on input signals and test pulses is evaluated; if an error occurs or the input logic is mismatched (not inverted), the I/O Port value will become FALSE.

(n = Even number)

Input signal from safety input device		Support for error detection by test pulse		Value of I/O Port ^{*1}				LED indication on safety I/O terminal body					
				Safety Input Process Value		Safety Input Status		Color	Status		Color	Status	
IN n	IN n+1	IN n	IN n+1	IN n	IN n+1	IN n	IN n+1	IN n			IN n+1		
OFF	OFF	Not supported	Not supported	FALSE	FALSE	FALSE	FALSE	Red		Lit	Red		Lit
OFF	ON	Not supported	Not supported	FALSE	TRUE	TRUE	---	---		Not lit	Yellow		Lit
ON	OFF	Not supported	Not supported	TRUE	TRUE	TRUE	Yellow		Lit	---		Not lit	
ON	ON	Not supported	Not supported	FALSE	FALSE	FALSE	Red		Lit	Red		Lit	
---	---	Supported	---	FALSE	FALSE	FALSE	Red		Lit	Red		Flashing	
---	---	---	Supported	FALSE	FALSE	FALSE	Red		Flashing	Red		Lit	

*1 For the value of I/O Port,  refer to 6-3-4 Registering the I/O Assembly on page 6-9.

*2 It enters an error state due to input signal logic mismatch.

Errors Detectable by Self-Diagnosis Function

Detectable errors of safety input terminals depend on the settings.

Shown below are detectable errors for each parameter setting.

Settings				Error detection		
Single/Dual	Mechanical contact / Semiconductor	Test pulse	Contact with positive side of power line	Disconnection	Short circuits in input wiring	
Single	Mechanical contact	Supported	Detectable	Not detectable	---	
		Not supported	Not detectable	Not detectable	---	
	Semiconductor	Not supported	Not detectable	Not detectable	---	
Dual	Equivalent input	Mechanical contact	Supported	Detectable	Detectable when input turns ON	Detectable when input turns ON
		Semiconductor	Not supported	Detectable when input turns OFF	Detectable when input turns ON	Not detectable
	Complementary input	Mechanical contact	Supported	Detectable	Detectable when input turns ON or OFF	
		Semiconductor	Not supported	Detectable when input turns ON or OFF	Detectable when input turns ON or OFF	

Input Filter Function

The input filter function prevents malfunction due to chattering and/or noise from an external device connected to safety input terminals.

It allows filtering of chattering and noise from external devices with a range configured by OFF->ON / ON->OFF delay time.

OFF->ON / ON->OFF delay time can be selected ranging from 0 to 1000 ms in 1 ms steps for each safety input terminal. (Initial value is 0 ms.)

The larger the delay time is, the higher the chattering- and noise-immunity becomes, while the slower the response to input signals becomes.

Note that the input filter function can be used being combined with the dual channel evaluation function.

*1. When [Safety Light Curtain] or [Safety Laser Scanner] is set to an input device, the initial value of ON->OFF Delay Time is 1 ms.



Precautions for Correct Use

The ON->OFF delay time affects the safety reaction time. Add the OFF delay time to the safety reaction time. (Refer to *Safety Reaction Time Calculation* on page 7-1.)

● Operation with OFF->ON Delay

You can filter out ON pulses for the width that is set with the OFF->ON delay time.

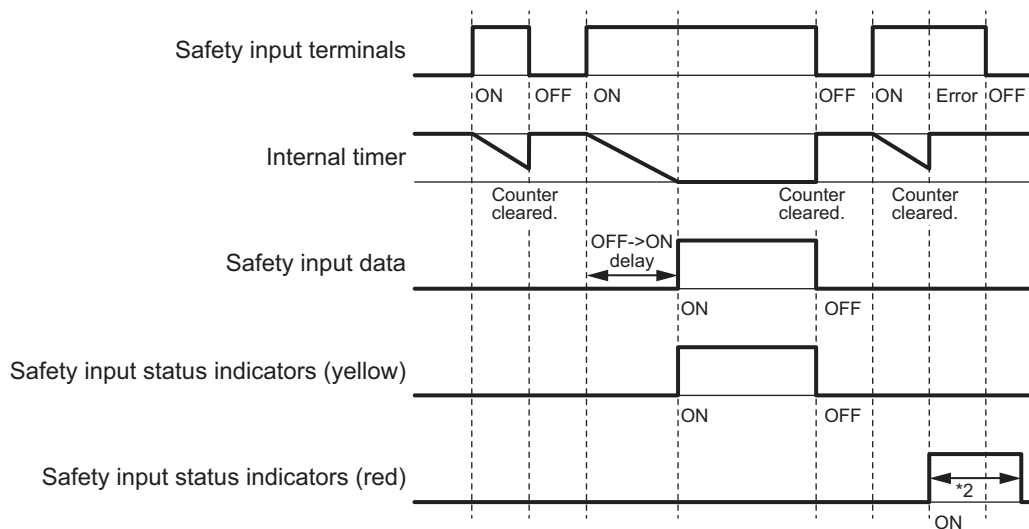

*2. This is the time that the error status (control data, status data, and indicator status) is held (Configured by input error latch time).

● **Operation with ON->OFF Delay**

You can filter out OFF pulses for the width that is set with the ON->OFF delay time.

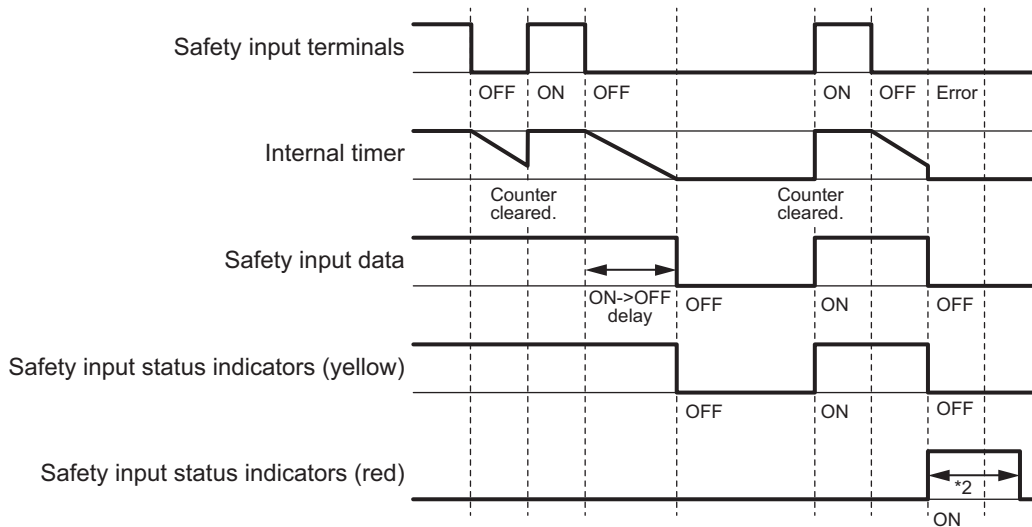

*2. This is the time that the error status (control data, status data, and indicator status) is held (Configured by input error latch time).

● **Operation with Both OFF->ON Delay and ON->OFF Delay**

You can filter out ON pulses for the width that is set with the OFF->ON delay time and filter out OFF pulses for the width that is set with the ON->OFF delay time.

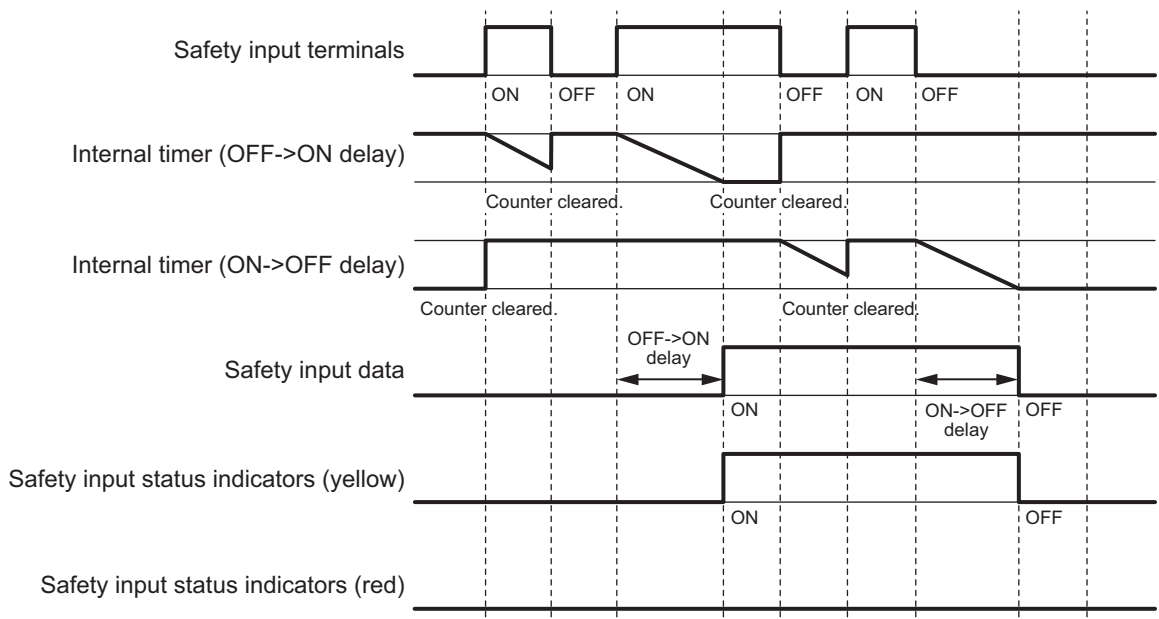

Input Error Latch Time

Input error latch time is a parameter applied to all input terminals.

Set a time period to latch the error status when occurred on an input terminal. The error status is latched for a time period specified by this setting even if the the error factor is released.

Set a minimum latch time so that errors that occur intermittently can be detected by the safety I/O terminal.

You can specify the input error latch time from 0 to 65,530ms in 10ms step.

Initial value is 1000ms.

For the error latch time, set the most suitable value for error detection, taking into account the network response time between safety I/O terminals and originator devices.

Muting Lamp Line Disconnection Detection

Connecting a muting lamp to test terminal T3 or T7 allows detection of a failure or breaking of wire of the muting lamp.

Configuring the test terminal setting as "Muting Lamp" allows monitoring of output current to the muting lamp. If the current is less than 5 mA, an error will be detected and the Muting Lamp Status will be 0 (False). If it is 25 mA or higher, Muting Lamp Status will be 1 (True).

Shown below are detection conditions of failure and disconnection of the muting lamp.

If the muting output is OFF, failure and/or disconnection of the muting lamp cannot be detected. Once, while the muting output is ON, an error is detected (STEP 2 in the table below), even if the muting output is OFF, the Muting Lamp Status will remain 0 (False) until the muting lamp is replaced.

Disconnection detection is performed in a 3-second cycle. The Muting Lamp Status will not become 0 (False) until the disconnections are detected twice in a row. Thus it takes a maximum of 6 s before the error is detected.

For the I/O Port setting of Muting Lamp Status, refer to 6-3-4 *Registering the I/O Assembly* on page 6-9.

STEP	State of Muting Lamp Connection	Value of I/O Port	
		TO <input type="checkbox"/> (Test Output Process Value)	Muting Lamp Status <input type="checkbox"/>
STEP 1	Not disconnected	TRUE (ON)	TRUE
STEP 2	Disconnected	TRUE (ON)	FALSE (error)
STEP 3	Disconnected	FALSE (OFF)	FALSE (error)
STEP 4	Not disconnected after muting lamp is replaced	FALSE (OFF)	TRUE

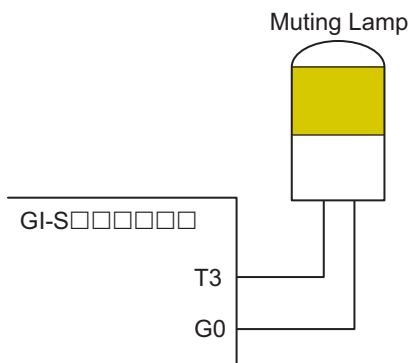

Sysmac Studio setting example:

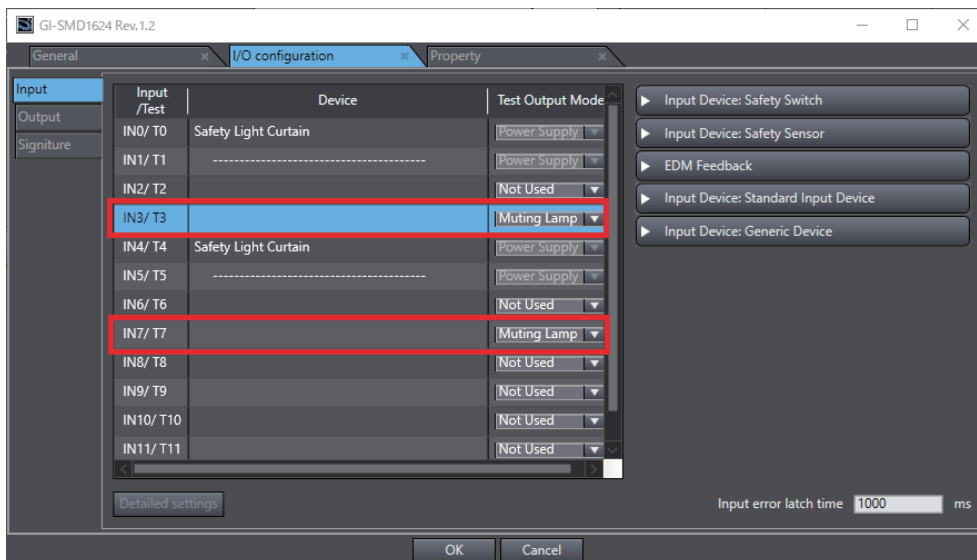

Unit Power Supply Monitoring Function

Unit power supply monitoring function monitors the voltage range of the unit power supply.

If any voltage outside the specifications is detected, both the I/O data of the safety I/O terminal will enter the safe state, and the [Input Power Error] flag will become FALSE.

For details on the safe state, ☐ refer to *8-1-1 Safe State* on page 8-2.

At the same time, the [Safety Input Status] flag is set.

For the I/O Port setting of [Safety Input Status], ☐ refer to *6-3-4 Registering the I/O Assembly* on page 6-9.

5-3-2 Safety Output Function

Available Output Device

The safety I/O terminal performs diagnosis of connected external devices using the output terminals. Shown below are standard safety output devices that can be connected to the safety output terminals of GI-SMD1624.

GI-SID1224 has no output terminal.

Output device		Test pulse	Description
Relays with Forcibly Guided Contacts	Relays with Forcibly Guided Contacts for Dual Channel	Supported	Test pulse is output when output is ON.
	Relays with Forcibly Guided Contacts for Single Channel	Supported	
Generic Device	Dual Output with Test Pulse	Supported	Test pulse is output when output is ON.
	Dual Output without Test Pulse	Not supported	Test pulse is not output when output is ON.
	Single Channel with Test Pulse	Supported	Test pulse is output when output is ON.
	Single Channel without Test Pulse	Not supported	Test pulse is not output when output is ON.



Precautions for Correct Use

Output devices with Test Pulse and output devices without Test Pulse cannot be used in combination for four output terminals. Set only the output devices with Test Pulse or only those without test pulse to the output terminals.



Additional Information

The connection of incandescent lamps is not supported. Connect them to an NX-series Digital Output Unit.

How to Configure Safety Functions for Safety Output Terminal

Safety functions of safety output terminals can be easily configured by selecting an external device type to connect using Sysmac Studio.

For the setup procedure with the Sysmac Studio, ☐ refer to *Section 6 Settings* on page 6-1.

How to Connect Output Device

This section describes how to connect output devices.

● Safety relay/contactors

Safety relays and contactors are connected as shown below.

- Single-channel output (with using test pulse diagnosis)

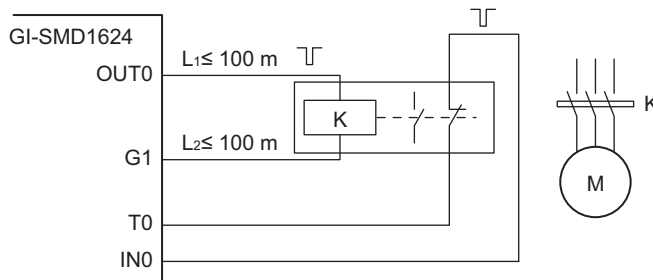

Sysmac Studio setting example:

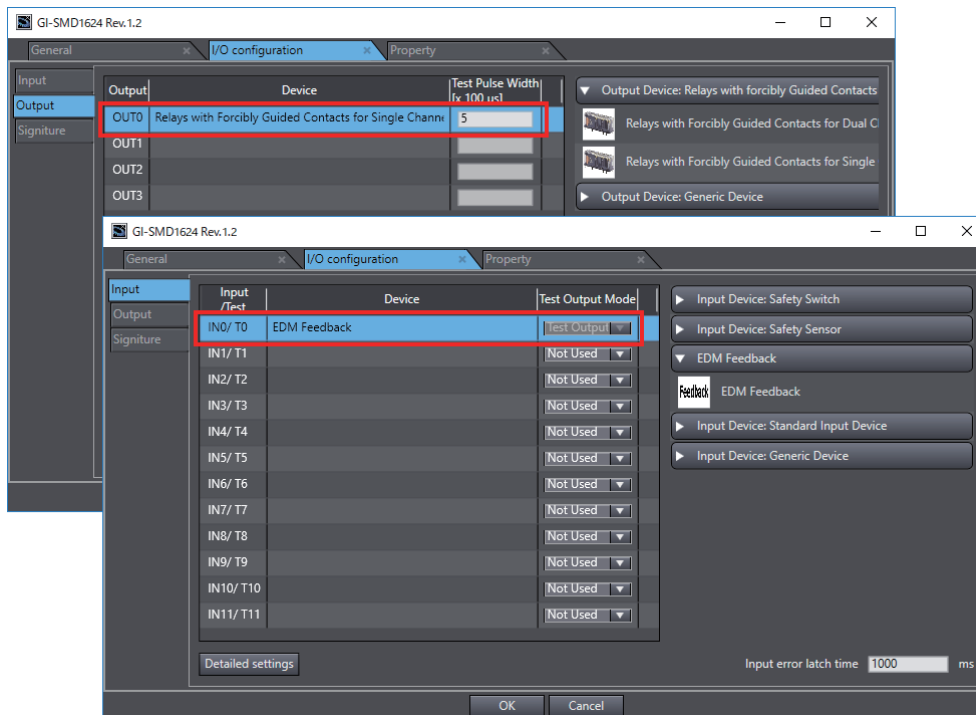

- Dual-channel output (with using test pulse diagnosis)

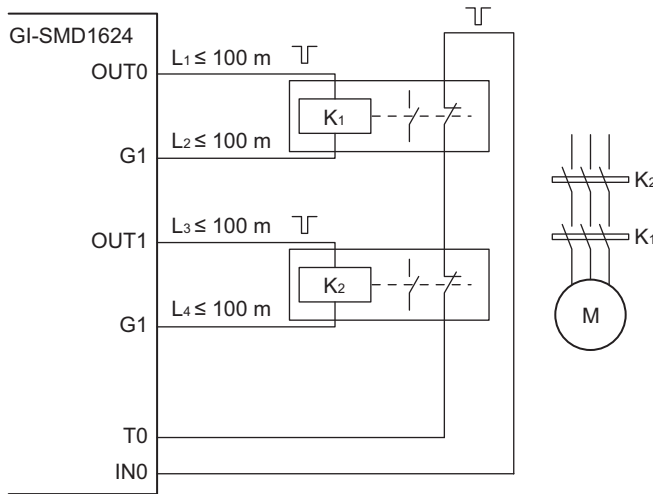

Sysmac Studio setting example:

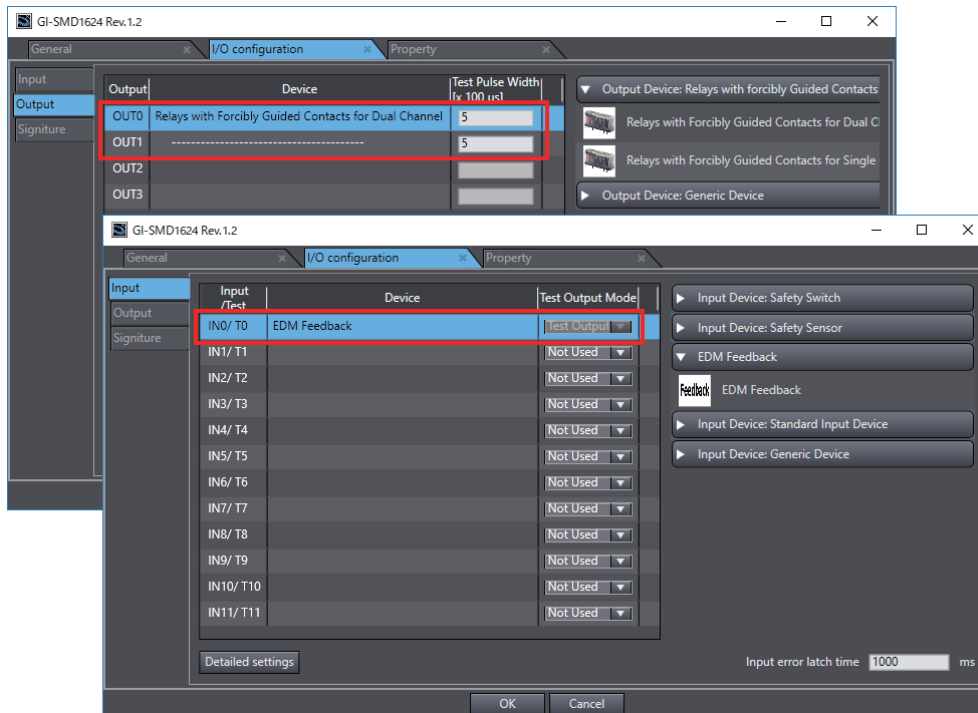

Precautions for Correct Use

The line length from the safety output terminals to the output devices (L1, L2, L3, and L4) is 100 m max. for each line.

● **How to connect multiple output devices**

Each G1 terminal of safety I/O terminal is connected in the unit. Make sure that current to flow in one G1 terminal should be within the capacity of output power supply terminal current.

Safety Output Function Types

This section describes types of safety output functions of safety I/O terminal.

The safety output functions perform diagnosis of output to safety output terminals and external device wiring based on the safety output data from safety programs.

The result of safety program execution is received and evaluated by the safety output function, and the evaluated value is outputted to a terminal.

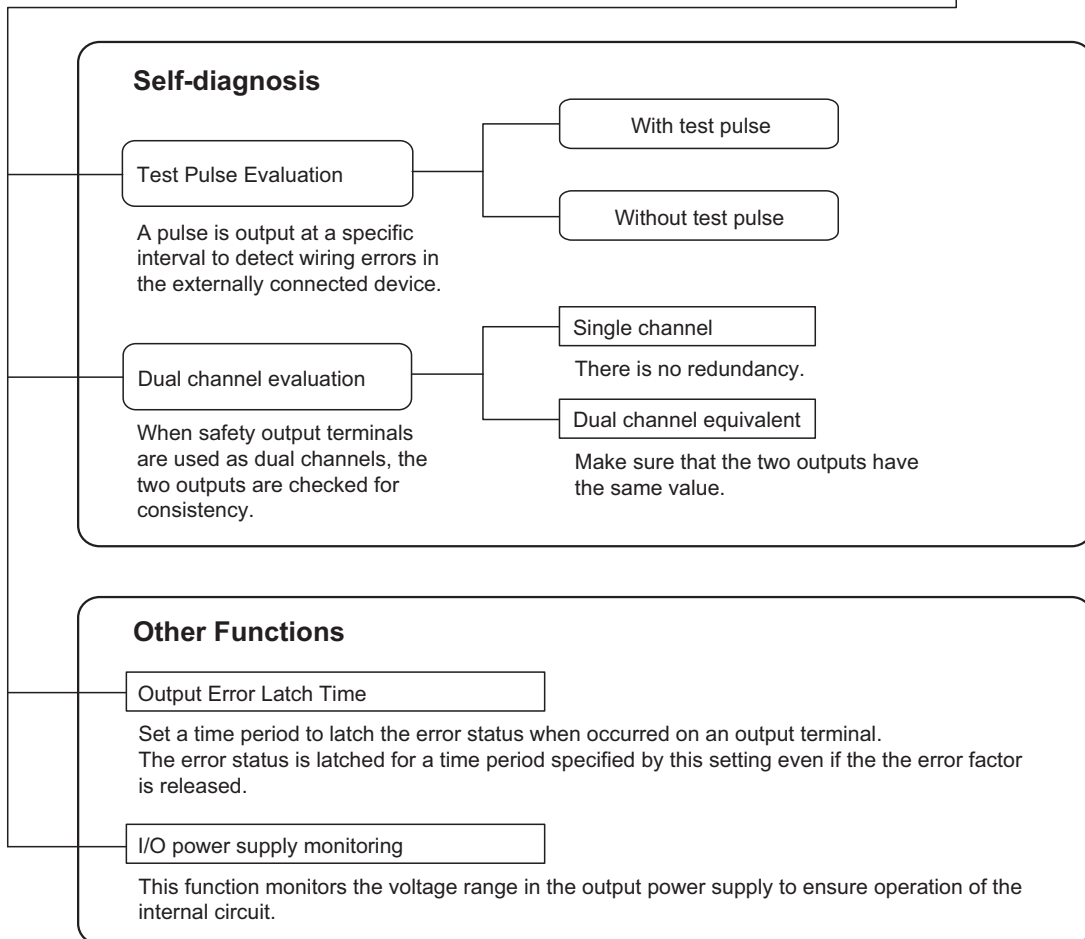
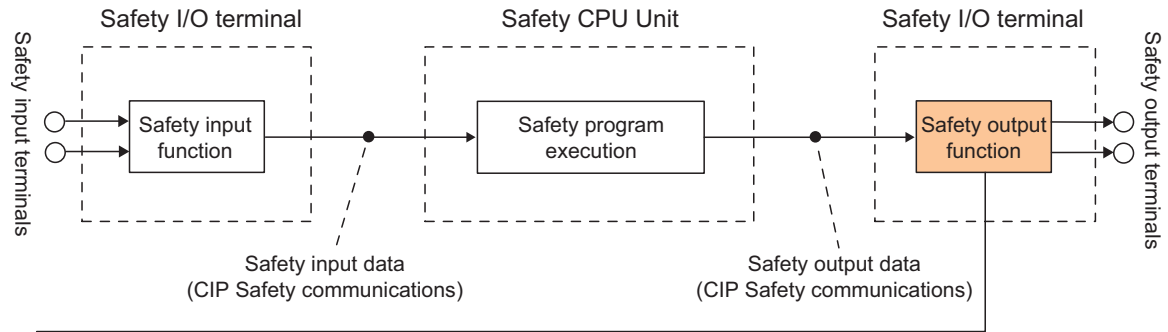

Test Pulse Evaluation

This function outputs 24 VDC signal with regular test pulse from the output terminal to detect fault of the device or bad hard wiring. For the availability of Test Pulse from the configured output device, refer to the table shown below.

Output device		Test pulse	Description
Relays with Forcibly Guided Contacts	Relays with Forcibly Guided Contacts for Dual Channel	Supported	Test pulse is output when output is ON.
	Relays with Forcibly Guided Contacts for Single Channel	Supported	
Generic Device	Dual Output with Test Pulse	Supported	Test pulse is output when output is ON.
	Dual Output without Test Pulse	Not supported	Test pulse is not output when output is ON.
	Single Channel with Test Pulse	Supported	Test pulse is output when output is ON.
	Single Channel without Test Pulse	Not supported	Test pulse is not output when output is ON.



Precautions for Correct Use

- When the Test Pulse Diagnosis parameter is set to an output device with Test Pulse, OFF pulse signals are output while the safety output is ON to diagnose the output circuit. Check the input response time of the connected control device to make sure it will not malfunction due to these OFF pulses.
- For four output terminals, output devices with test pulse and without test pulse cannot be used at the same time. Be sure to decide the output device either with test pulse or without test pulse before setting the output device to the output terminal.

Test Pulse Width/Frequency

This section provides test pulse conditions.

Item	Condition
Test pulse width	300 μ s to 10 ms, in 100- μ s increments (Initial value: 500 μ s)
Test pulse frequency	468 ms (fixed value)

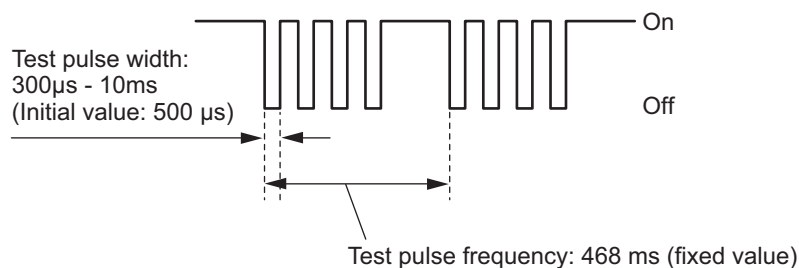

Dual Channel Evaluation

Safety output terminals can be used as dual channels (one pair). The dual channel evaluation evaluates the data for two outputs to check for discrepancy. If an error is detected either of the two output terminals, both of two outputs to external devices are blocked.

- Single channel

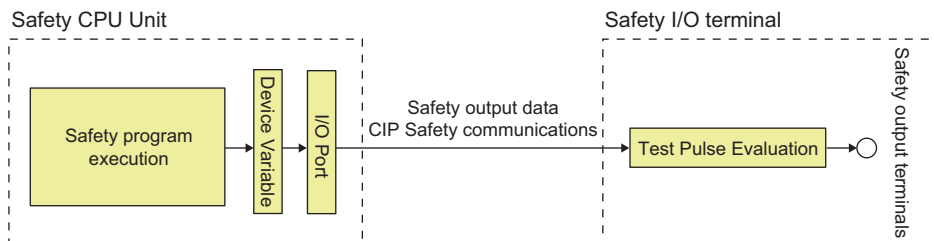

- Dual channel

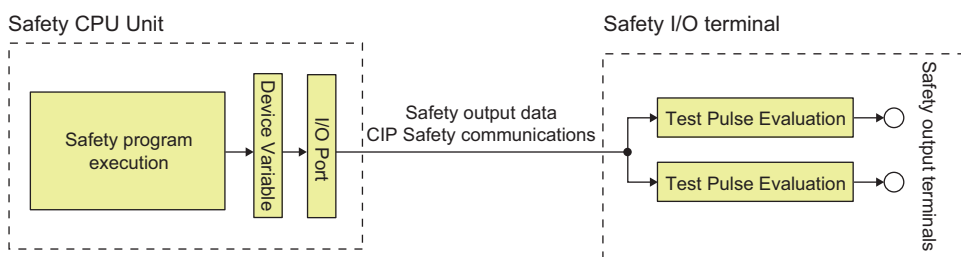

This function is materialized by the parameter [Single/Dual].

● Single/Dual

Set the evaluation method to use with the safety output terminals.

Setting	Description
Single Channel	The safety output terminals are used as independent safety output terminals. *1
Dual Channel Equivalent	The pair of safety output terminals are used as dual channel outputs. The output is ON if the paired safety output terminals are both normal.

*1. Even in single channel mode, two outputs (OUT0-OUT1 or OUT2-OUT3) are used as a pair. If an error is detected in either of the two output terminals, both of the two outputs to external devices will be blocked.

● **Relation between single/dual setting and safety output data**

Based on the single/dual setting, safety output data to be used by a safety program is reflected to safety output terminals as shown below.

● **Relation between safety output data and output signal of safety output terminal (in case of single channel setting)**

The error detection status based on output signals and test pulses is evaluated; if an error occurs, the I/O Port value will become FALSE.

Value of I/O Port *2 Safety Output Process Value	Support for error detection by test pulse	Output signal to safety output device	Value of I/O Port *2 Safety Output Status	LED indication on safety I/O terminal body		
				Color	Status	
0	Not supported	OFF	TRUE	---		Not lit
1	Not supported	ON	TRUE	Yellow		Lit
---	Supported *1	OFF	FALSE	Red		Lit *3
---	Supported *1	OFF	FALSE	Red		Flashing *3

*1 If output devices to be set to output terminals support "no test output," only the condition (2) or (3) in the table below can be detected depending on the terminal conditions of external devices connected to output terminals.

No.	Output terminal setting	Destination terminal condition	Detectable/not detectable
(1)	OFF	0V	Not detectable
(2)	OFF	24V	Detectable
(3)	ON	0V	Detectable
(4)	ON	24V	Not detectable

*2 For the value of I/O Port, refer to 6-3-4 Registering the I/O Assembly on page 6-9.

*3 It will light up in red if the output circuit detects an error.

It will flash in red if the counterpart output detects an error.

Even in single channel mode, two outputs (OUT0-OUT1 or OUT2-OUT3) are used as a pair, and the indicator light behaves as above.

● **Relation between safety output data and output signal of safety output terminal (in case of dual equivalent output setting)**

The error detection status based on output signals and test pulses is evaluated; if an error occurs or the output logic is mismatched (not equivalent), the I/O Port value will become FALSE.

(n = Even number)

Value of I/O Port *1 Safety Output Process Value		Support for error detection by test pulse		Output signal to safety output device		Value of I/O Port *1 Safety Output Status		LED indication on safety I/O terminal body					
OUT n	OUT n+1	OUT n	OUT n+1	OUT n	OUT n+1	OUT n	OUT n+1	OUT n			OUT n+1		
0	0	Not supported	Not supported	OFF	OFF	TRUE	TRUE	---		Not lit	---		Not lit
0	1	Not supported	Not supported	OFF	OFF	FALSE *2	FALSE *2	Red		Lit	Red		Lit
1	0	Not supported	Not supported	OFF	OFF	FALSE *2	FALSE *2	Red		Lit	Red		Lit
1	1	Not supported	Not supported	ON	ON	TRUE	TRUE	Yellow		Lit	Yellow		Lit
---	---	Supported	---	OFF	OFF	FALSE	FALSE	Red		Lit	Red		Flashing
---	---	---	Supported	OFF	OFF	FALSE	FALSE	Red		Flashing	Red		Lit

*1 For the status of I/O Port, refer to 6-3-4 Registering the I/O Assembly on page 6-9.

*2 It enters an error state due to input signal logic mismatch.

Errors Detectable by Self-Diagnosis Function

Detectable errors of safety output terminals depend on the parameter settings.

Shown below are detectable errors for each parameter setting.

Setting		Error detection			
Single/Dual	Test pulse	Contact with positive side of power line		Short circuits in output wiring	
		Output ON	Output OFF	Output ON	Output OFF
Single	Supported	Detectable	Detectable	---	---
	Not supported	Not detectable	Detectable	---	---
Dual	Supported	Detectable	Detectable	Detectable	Not detectable
	Not supported	Not detectable	Detectable	Not detectable	Not detectable

Output Error Latch Time

Output error latch time is a parameter applied to all output terminals.

Set a time period to latch the error status when occurred on an output terminal. The error status is latched for a time period specified by this setting even if the error factor is released.

Set a minimum latch time so that errors that occur intermittently can be detected by the safety I/O terminal.

You can specify the output error latch time from 0 to 65530ms in 10ms step.

Initial value is 1000ms.

For the error latch time, set the most suitable value for error detection, taking into account the network response time between safety I/O terminals and originator devices.

Output Power Supply Monitoring

Output power supply monitoring function monitors the voltage range of the output power supply to ensure operation of the internal circuit.

If this function detects any low voltage and overvoltage outside the specifications, the output data and the I/O data will respectively enter the safe state, and the [Output Power Error] flag will become FALSE.

For details on the safe state, [□](#) refer to *8-1-1 Safe State* on page 8-2.

For details on the I/O Port setting of [Output Power Error], [□](#) refer to *6-3-4 Registering the I/O Assembly* on page 6-9.

6

Settings

6-1	Configuration and Setup Procedures	6-2
6-2	Part Names and Functions of the Sysmac Studio Window	6-3
6-3	Connection Settings and I/O Settings	6-4
6-3-1	Creating a Project File	6-4
6-3-2	Registering a Safety Connection	6-6
6-3-3	Setting the IP Address	6-8
6-3-4	Registering the I/O Assembly	6-9
6-3-5	Configuring the Safety I/O Functions	6-14
6-3-6	Registering the Device Variables	6-20
6-3-7	Creating the Safety Programs	6-22
6-3-8	Debugging/Commissioning	6-23
6-4	Configuring and Setting Up the EtherNet/IP Network	6-24
6-4-1	Setting the IP Address	6-24
6-4-2	CIP Safety Connection Settings	6-34
6-4-3	Memory Clear	6-38
6-4-4	Restart	6-40
6-5	Exporting/Importing Settings Data	6-42
6-5-1	Exporting/Importing Safety I/O Terminal Settings	6-42

6-1 Configuration and Setup Procedures

This section describes the procedures for using the Sysmac Studio to configure and set up the safety I/O terminal.

Make the settings in the following order.

- 1 Creating a Project File
- 2 Registering a Safety Connection
- 3 Setting the IP Address
- 4 Configuring the Safety I/O Functions
- 5 Registering the Device Variables
- 6 Creating the Safety Programs
- 7 Debugging/Commissioning

6-2 Part Names and Functions of the Sysmac Studio Window

This section gives the names of the parts of the Sysmac Studio Window.

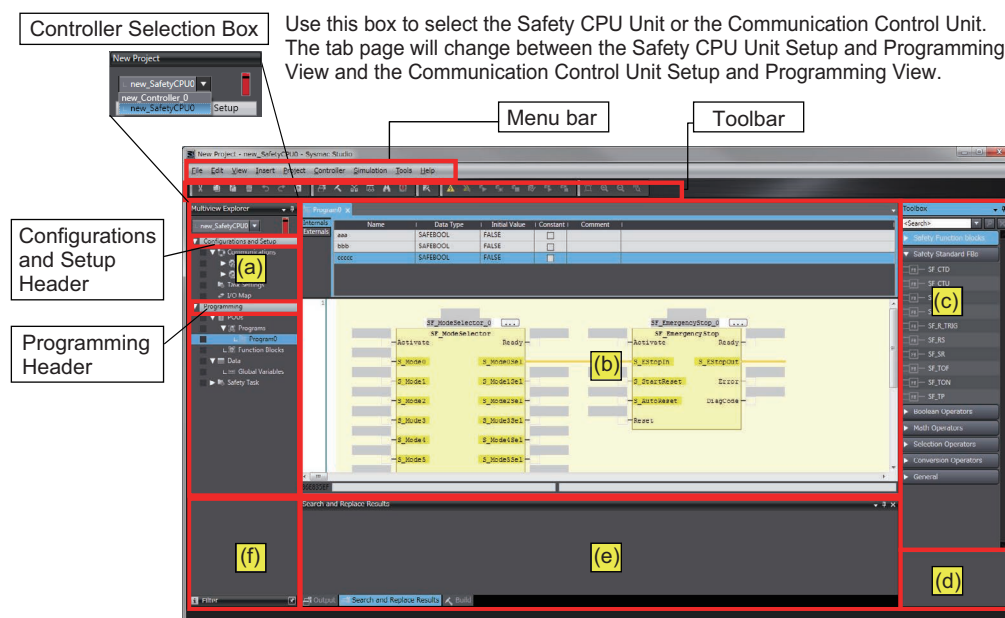

Letter	Name	Function
(a)	Multiview Explorer	This pane is your access point for all Sysmac Studio data that is related to the Safety Network Controller. It has a Controller Selection Box , and is separated into a Configurations and Setup Layer and a Programming Layer . Use the Controller Selection Box to select the Safety CPU Unit or the Communication Control Unit.
(b)	Edit Pane	The Edit Pane is used to display and edit the data for any of the items.
(c)	Toolbox	The Toolbox shows the objects that you can use to edit the data that is displayed in the Edit Pane.
	Search and Replace Pane	In this pane, you can search for and replace strings in the data under Programming Layer of the Multiview Explorer.
(d)	Controller Status Pane	This pane shows the operating status of the Safety CPU Unit or the Communication Control Unit. The Controller Status Pane is displayed only while the Sysmac Studio is online with the Safety CPU Unit or the Communication Control Unit, or when the Simulator is running.
	Simulation Pane	This pane is used to start and stop the Safety CPU Unit Simulator.
(e)	Output Tab Page	The Output Tab Page shows the results of building.
	Watch Tab Page	The Watch Tab Page shows the monitor results of the online Safety CPU Unit, the Communication Control Unit, or the Simulator.
	Build Tab Page	The Build Tab Page shows the results of program checks and building.
	Search and Replace Results Tab Page	The Search and Replace Results Tab Page shows the results when Search All or Replace All is executed.
(f)	Filter Pane	The Filter Pane allows you to search for color codes and for items with an error icon. The results are displayed in a list.

This manual describes only the functions and operations of the Sysmac Studio that are related to the safety I/O terminal.

☐ Refer to the *Sysmac Studio Version 1 Operation Manual* (Cat. No. W504) for details on Sysmac Studio operation.

6-3 Connection Settings and I/O Settings

To make the safety connection settings and safety I/O settings for the GI-S-series safety I/O terminal, use the following procedure to create a project file for a safety network controller with the Sysmac Studio.

- 1** Set up the Safety CPU Unit of the safety network controller, an originator device.
- 2** Set up the CIP Safety communications, which are the communications between the Safety CPU Unit and the GI-S-series safety I/O terminal, a target device.

This section describes the operations to perform based on the following configuration.

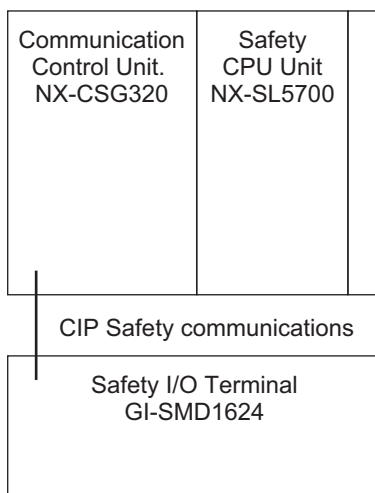

6-3-1 Creating a Project File

Use the following procedure to create a project file and set up the CPU Unit.

- 1** Start the Sysmac Studio.
- 2** Click [New Project] on the start page.

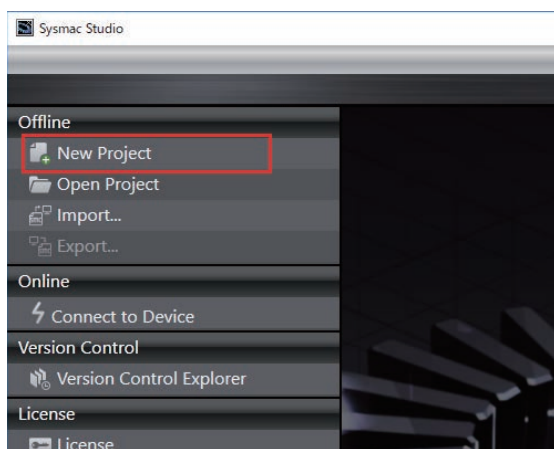

- 3** On the [Project Properties] screen, select [Safety Network Controller] for [Category] and [1.01] for [Version] in [Select Devices], and click the [Create] button.

The screenshot shows the 'Project Properties' dialog box. Under 'Project Properties', the fields are: Project name (New Project), Author (OMRON), Comment (empty), and Type (Standard Project). Under 'Select Device', the fields are: Category (Safety Network Controller), Device (NX), and Version (1.01). A 'Create' button is highlighted with a red box at the bottom right.



Additional Information

To create a project with the NX-series Controller (NX102-□□□□), on the [Project Properties] screen, select [Controller] for [Category] in [Select Devices], [NX102] from the left [Device] list, and a desired model from the right list. Select [1.31] for [Version], and click the [Create] button.

- 4** Double-click [Configurations and Setup] - [CPU/Expansion Racks] - [CPU Rack] in the [Multiview Explorer], or right-click it and choose [Edit].

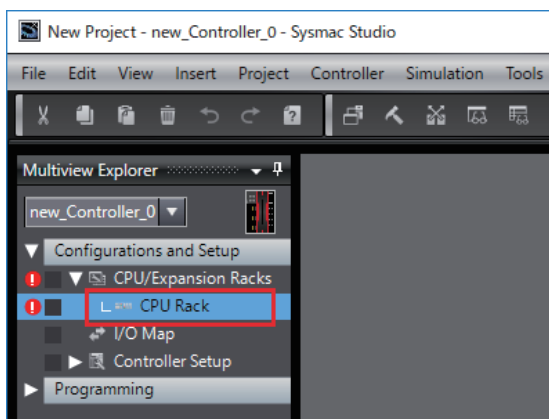

- 5** Select a [Safety CPU Device] group from [Toolbox], and choose the Safety CPU Unit [NX-SL5700].

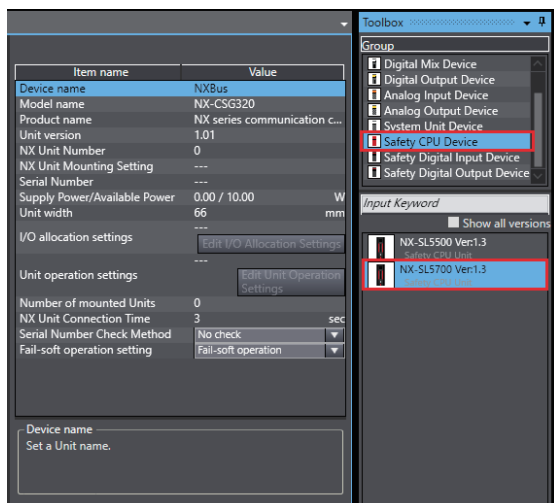

- 6** Drag and drop the NX Unit selected at [Toolbox] into the position to which to add it on the CPU and Expansion Racks Tab Page, or double-click the selected NX Unit.

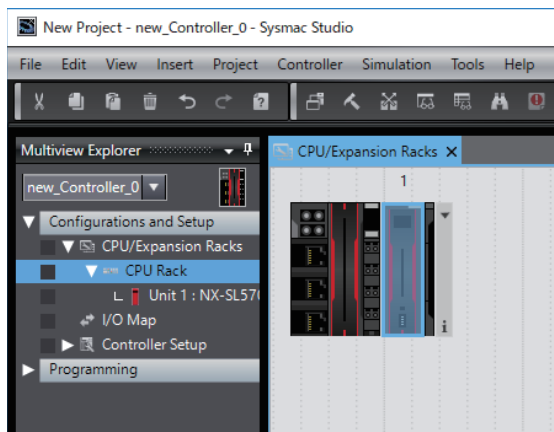

6-3-2 Registering a Safety Connection

Use the following procedure to register a safety connection for GI-S-series from the project file of the safety network controller.

- 1** On the controller selection box in the Multiview Explorer, select a target Safety CPU Unit [new_SafetyCPU0].

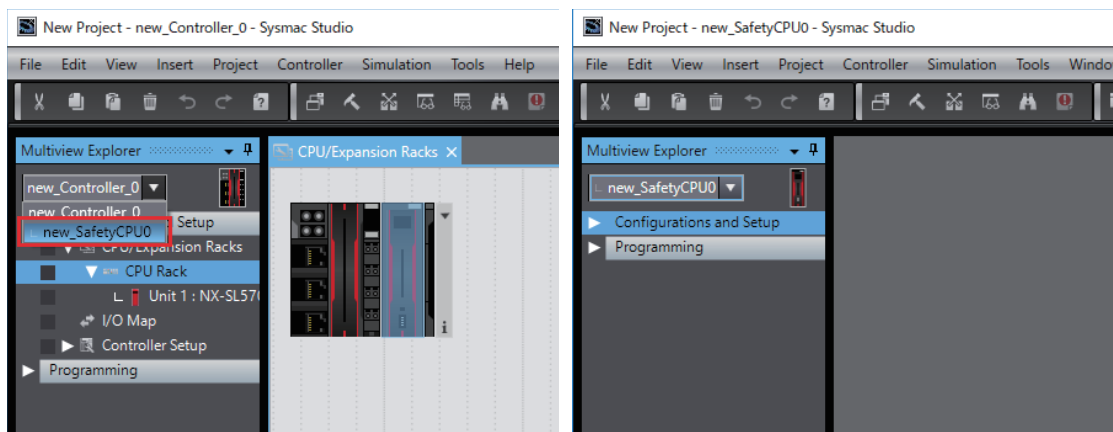

- 2 Double-click [Configurations and Setup] - [Communications] - [Safety] - [EtherNet/IP Safety Connection Settings] - [Connection Settings (Originator)] in the Multiview Explorer, or right-click it and choose [Edit].

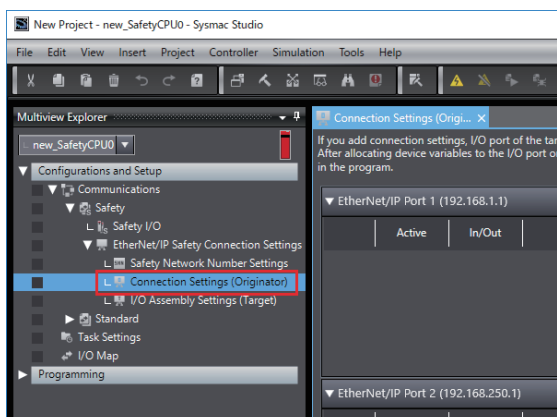

- 3 Select a [Safety Discrete I/O Device] group from [Toolbox], and choose [GI-SMD1624] or [GI-SID1224]. (This manual describes the case where [GI-SMD1624] is chosen.)

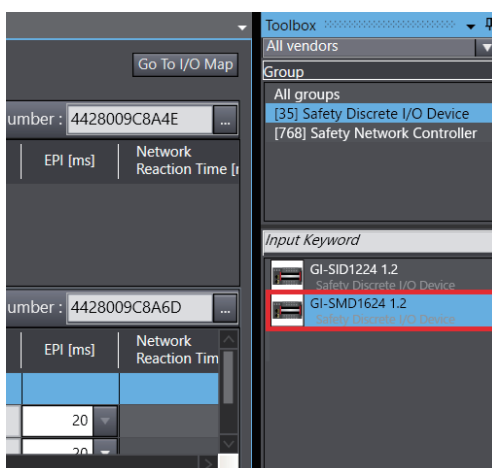

- 4 Drag and drop the device selected at [Toolbox] into the Connection Settings (Originator) Edit Pane, or double-click the selected safety I/O terminal.

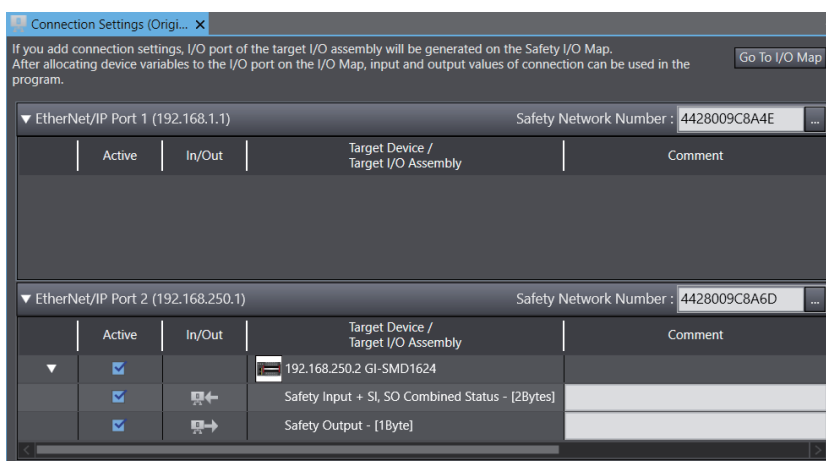

The IP address of the added connection is automatically assigned from among the IP addresses of EtherNet/IP ports set for the safety network controller. Edit the IP address according to the network configuration.

6-3-3 Setting the IP Address

Use the following procedure to set the IP address of the device registered on the Connection Settings (Originator) Edit Pane.

- 1 Select a desired device registered on the Connection Settings (Originator) Edit Pane, then right-click it and choose [Edit].

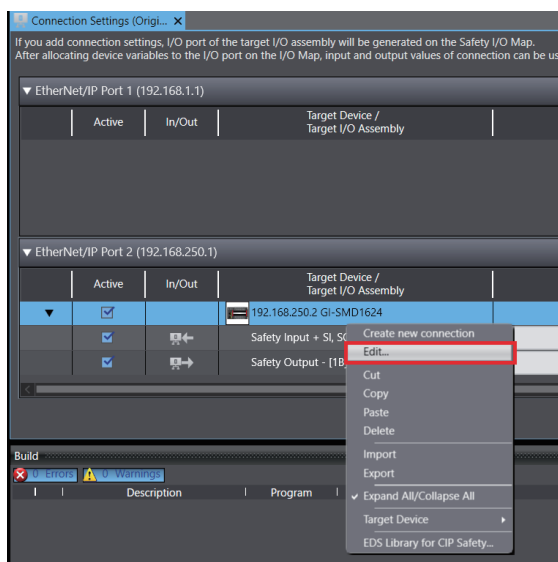

- 2 The following window opens. Enter the IP address in the IP address box, and click the OK button.

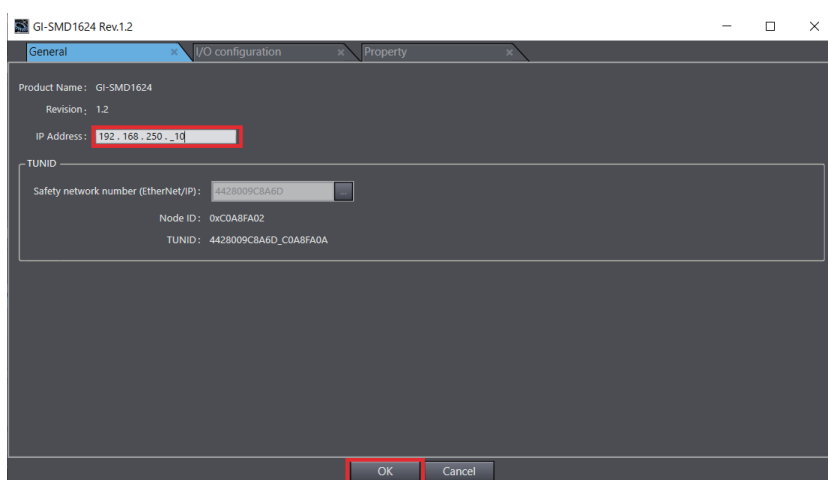

- 3 The entered IP address is reflected in the Connection Settings (Originator) Edit Pane.

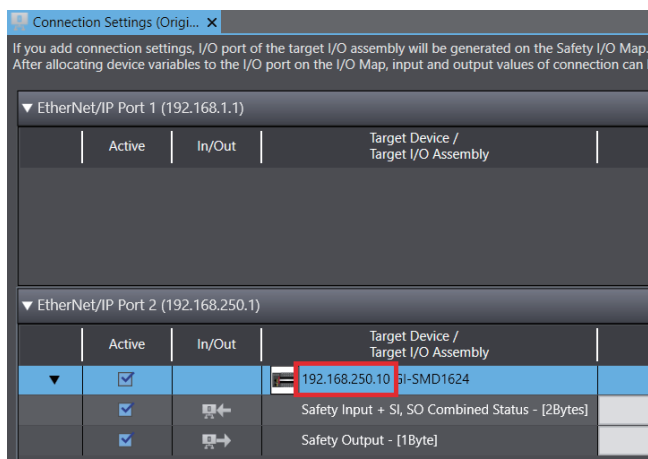

6-3-4 Registering the I/O Assembly

This section describes how to set the I/O Assembly of the safety I/O terminal.

- 1 Select a desired device registered on the Connection Settings (Originator) Edit Pane, then right-click it and choose [Create new connection].

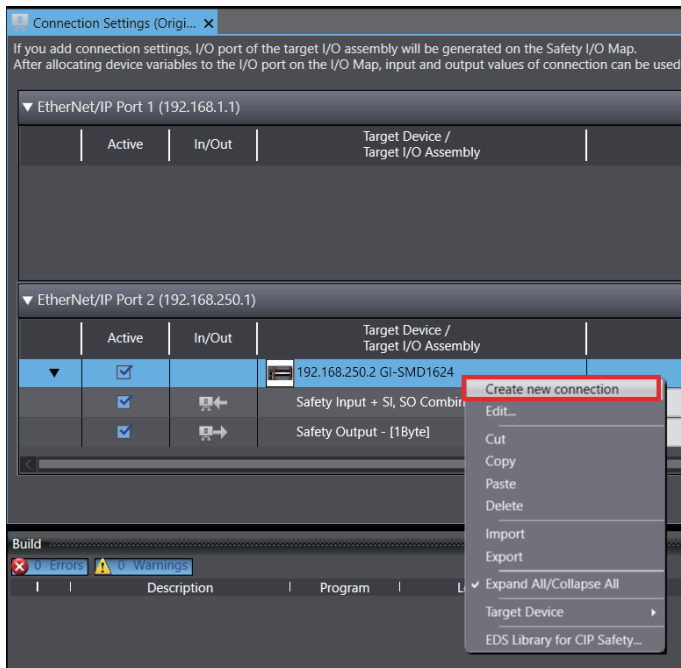

- 2 The following window opens. Select an item to add from the I/O Assembly list, and click the OK button.

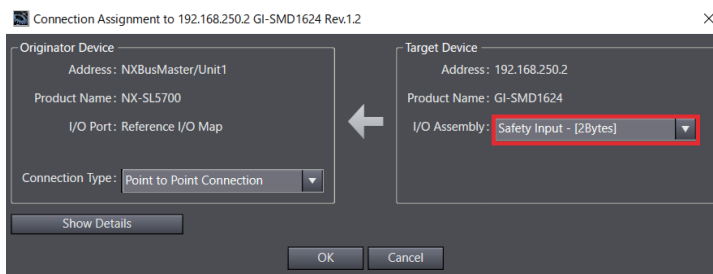

Precautions for Correct Use

You cannot use the tag data link and the I/O assembly [Safety Global Input - [13Bytes]] at the same time. To use the tag data link, select the I/O assembly other than [Safety Global Input - [13Bytes]].

- 3 The selected I/O Assembly is displayed on the Edit Pane.

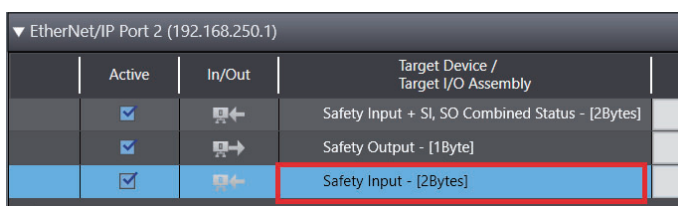

By default, [Safety Input + SI, SO Combined Status] and [Safety Output] are displayed for GI-SMD1624; [Safety Input + Combined Status] is done for GI-SID1224.

- 4** Select the I/O assembly you do not use, right-click and select [Delete].

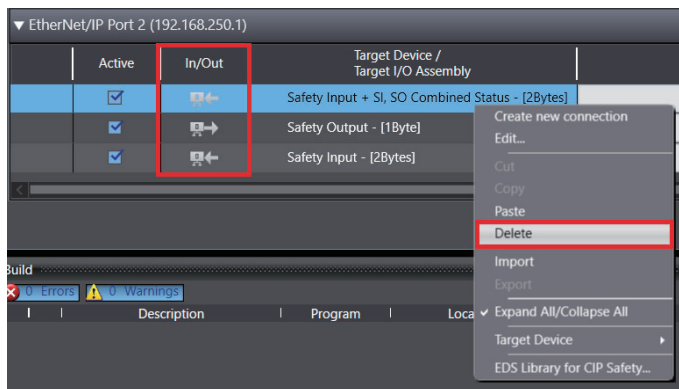

You can register one I/O assembly for In and Out each.

You can check the I/O assembly In and Out by icon.

In= Out=

- 5** The selected I/O Assembly is also reflected in the I/O map automatically.

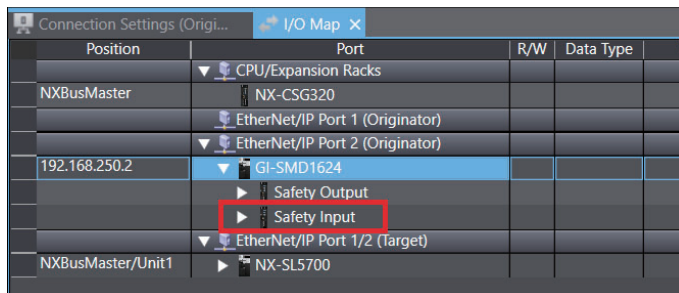

I/O Assemblies and I/O Ports for Safety I/O Terminals That Are Displayed in the I/O Map of the Safety I/O Terminal

The I/O assemblies and I/O Ports for safety I/O terminals that are displayed in the I/O Map of the safety I/O terminal are described in this section.

● Safety I/O terminal (GI-SMD1624)

I/O Assembly	I/O Port	Data type	R/W	Name	Description
Safety Input	SI□	SAFEBOOL	R	Safety Input Process Value	Gives the status of safety input terminal. 0: OFF, 1: ON
Safety Input + Combined Status	SI□	SAFEBOOL	R	Safety Input Process Value	Gives the status of safety input terminal. 0: OFF, 1: ON
	Combined Input Status	SAFEBOOL	R	Combined Safety Input Status	This flag indicates the status of the safety input terminals. 0: An error has occurred on one of the safety input terminals. 1: All of the safety input terminals are normal (no errors).
Safety Input + SI PT. Status	SI□	SAFEBOOL	R	Safety Input Process Value	Gives the status of safety input terminal. 0: OFF, 1: ON
	SIS□	SAFEBOOL	R	Safety Input Status	This flag indicates the status of the safety input terminals. 0: Error, 1: No error
SO Pt. Status	SOS□	SAFEBOOL	R	Safety Output Status	This flag indicates the status of the safety output terminals. 0: Error, 1: No error
Safety Input + SI, SO Combined Status	SI□	SAFEBOOL	R	Safety Input Process Value	Gives the status of safety input terminal. 0: OFF, 1: ON
	Combined Input Status	SAFEBOOL	R	Combined Safety Input Status	This flag indicates the status of the safety input terminals. 0: An error has occurred on one of the safety input terminals. 1: All of the safety input terminals are normal (no errors).
	Combined Output Status	SAFEBOOL	R	Combined Safety Output Status	This flag indicates the status of the safety output terminals. 0: An error has occurred on one of the safety output terminals. 1: All of the safety output terminals are normal (no errors).
Safety Input + SI Combined Status + SO Pt. Status	SI□	SAFEBOOL	R	Safety Input Process Value	Gives the status of safety input terminal. 0: OFF, 1: ON
	Combined Input Status	SAFEBOOL	R	Combined Safety Input Status	This flag indicates the status of the safety input terminals. 0: An error has occurred on one of the safety input terminals. 1: All of the safety input terminals are normal (no errors).
	SOS□	SAFEBOOL	R	Safety Output Status	This flag indicates the status of the safety output terminals. 0: Error, 1: No error

I/O Assembly	I/O Port	Data type	R/W	Name	Description
Safety Global Input	SI□	SAFEBOOL	R	Safety Input Process Value	Gives the status of safety input terminal. 0: OFF, 1: ON
	SIS□	SAFEBOOL	R	Safety Input Status	This flag indicates the status of the safety input terminals. 0: Error, 1: No error
	TO□	SAFEBOOL	R	Test Output Process Value	Gives the status of test output terminal. 0: OFF, 1: ON
	TOS□	SAFEBOOL	R	Test Output Status	This flag indicates the status of the test output terminals. 0: Error, 1: No error
	SOM□	SAFEBOOL	R	Safety Output Monitoring	Monitors the status of safety output terminal. 0: OFF, 1: ON
	SOS□	SAFEBOOL	R	Safety Output Status	This flag indicates the status of the safety output terminals. 0: Error, 1: No error
	Output Power Error	SAFEBOOL	R	Output Power Error	The voltage of output power supply (V1) is being diagnosed. 0: The power supply voltage is abnormal or the power supply is OFF. 1: The power supply voltage is normal.
	Input Power Error	SAFEBOOL	R	Input Power Error	The voltage of unit power supply (V0) is being diagnosed. 0: The power supply voltage is abnormal or the power supply is OFF. 1: The power supply voltage is normal.
	Combined Input Status	SAFEBOOL	R	Combined Safety Input Status	This flag indicates the status of the safety input terminals. 0: An error has occurred on one of the safety input terminals. 1: All of the safety input terminals are normal (no errors).
	Combined Output Status	SAFEBOOL	R	Combined Safety Output Status	This flag indicates the status of the safety output terminals. 0: An error has occurred on one of the safety output terminals. 1: All of the safety output terminals are normal (no errors).
Safety Global Input	Muting Lamp Status□	SAFEBOOL	R	Muting Lamp Status	This flag indicates the status of the muting lamp output terminals. (Only T3 and T7 are available for the purpose.) 0: The muting lamp is faulty or the wiring is disconnected. 1: No error
	Output Power Over Current Error	SAFEBOOL	R	Output Power Over Current Error	The current of output power supply (V1) is being diagnosed. 0: An overcurrent has occurred. 1: No error
	Input Power Over Current Error	SAFEBOOL	R	Input Power Over Current Error	The current of unit power supply (V0) is being diagnosed. 0: An overcurrent has occurred. 1: No error
Safety Output	SO□	SAFEBOOL	W	Safety Output Process Value	Gives the status of safety output terminal. 0: OFF, 1: ON
Safety Global Output	SO□	SAFEBOOL	W	Safety Output Process Value	Gives the status of safety output terminal. 0: OFF, 1: ON
	TO□	SAFEBOOL	W	Test Output Process Value	Gives the status of test output terminal. 0: OFF, 1: ON

● Safety I/O terminal (GI-SID1224)

I/O Assembly	I/O Port	Data type	R/W	Name	Description
Safety Input	SI□	SAFEBOOL	R	Safety Input Process Value	Gives the status of safety input terminal. 0: OFF, 1: ON
Safety Input + Combined Status	SI□	SAFEBOOL	R	Safety Input Process Value	Gives the status of safety input terminal. 0: OFF, 1: ON
	Combined Input Status	SAFEBOOL	R	Combined Safety Input Status	This flag indicates the status of the safety input terminals. 0: An error has occurred on one of the safety input terminals. 1: All of the safety input terminals are normal (no errors).
Safety Input + SI PT. Status	SI□	SAFEBOOL	R	Safety Input Process Value	Gives the status of safety input terminal. 0: OFF, 1: ON
	SIS□	SAFEBOOL	R	Safety Input Status	This flag indicates the status of the safety input terminals. 0: Error, 1: No error
Safety Global Input	SI□	SAFEBOOL	R	Safety Input Process Value	Gives the status of safety input terminal. 0: OFF, 1: ON
	SIS□	SAFEBOOL	R	Safety Input Status	This flag indicates the status of the safety input terminals. 0: Error, 1: No error
	TO□	SAFEBOOL	R	Test Output Process Value	Gives the status of test output terminal. 0: OFF, 1: ON
	TOS□	SAFEBOOL	R	Test Output Status	This flag indicates the status of the test output terminals. 0: Error, 1: No error
	Input Power Error	SAFEBOOL	R	Input Power Error	The voltage of unit power supply (V0) is being diagnosed. 0: The power supply voltage is abnormal or the power supply is OFF. 1: The power supply voltage is normal.
	Combined Input Status	SAFEBOOL	R	Combined Safety Input Status	This flag indicates the status of the safety input terminals. 0: An error has occurred on one of the safety input terminals. 1: All of the safety input terminals are normal (no errors).
	Muting Lamp Status□	SAFEBOOL	R	Muting Lamp Status	This flag indicates the status of the muting lamp output terminals. (Only T3 and T7 are available for the purpose.) 0: The muting lamp is faulty or the wiring is disconnected. 1: No error
	Input Power Over Current Error	SAFEBOOL	R	Input Power Over Current Error	The current of unit power supply (V0) is being diagnosed. 0: An overcurrent has occurred. 1: No error
Safety Global Output	TO□	SAFEBOOL	W	Test Output Process Value	Gives the status of test output terminal. 0: OFF, 1: ON

6-3-5 Configuring the Safety I/O Functions

You set the safety input functions and safety output functions of the safety I/O terminal when you assign input devices and output devices to the safety I/O terminal with the Sysmac Studio.

This section describes how to assign devices that are connected.  Refer to *5-3-1 Safety Input Function* on page 5-11 and *5-3-2 Safety Output Function* on page 5-25 for details on the safety input functions and safety output functions.

! WARNING

Required safety functions will be lost, and death due to injury may possibly occur. Make sure that the originator and target have the proper configuration if you want to set the Open type as "Open only".



Use the following procedure to make the safety I/O terminal settings for the device registered on the Connection Settings (Originator) Edit Pane.

To input the signals of the input/output devices connected to GI-S-series, you need to make the safety I/O terminal settings for each I/O terminal of the GI-S-series.

- 1** Select a desired connection registered under the device registered on the Connection Settings (Originator) Edit Pane, then right-click it and choose [Edit].

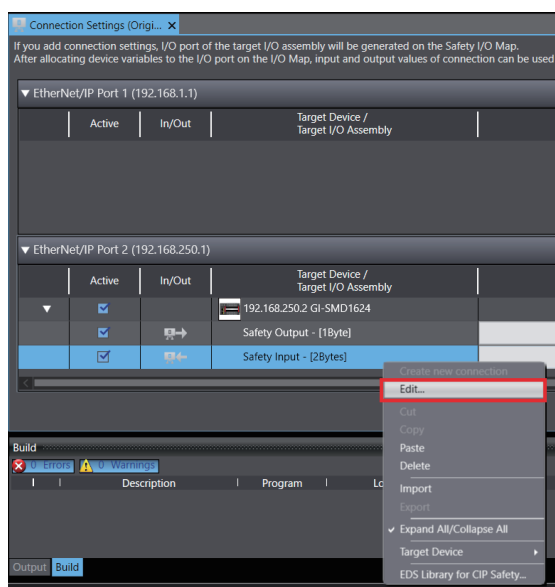

- 2** The following window opens. Choose [Show Details].

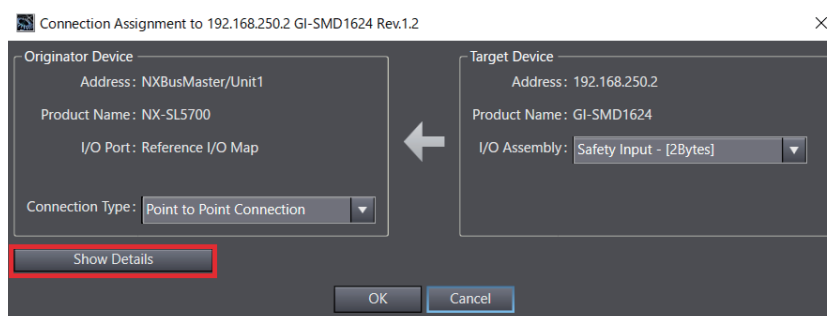

- 3 Choose [Configure Target Device (Type1)] from among the [Open Type] settings, and click the [OK] button.

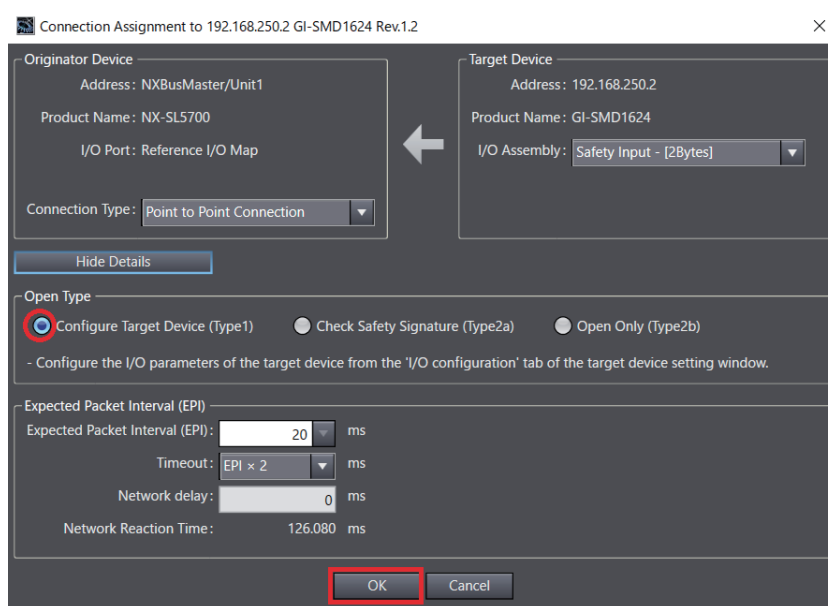

Item	Description
I/O Assembly	I/O assemblies of the target device for which a safety connection can be opened are listed.
Connection Type	For input connection (receiving from the target device), select either Point to Point Connection or Multicast Connection.
Open Type	Select a type for connection opening. Configure Target Device: Configures the target device after the connection is established. With the Sysmac Studio, set the I/O parameters of the target device from the 'I/O configuration' tab of the target device setting window. Check safety signature: Uses the safety signature to check if the target devices are properly configured when establishing the connection. The safety signature consists of the Safety Configuration CRC and the Safety Configuration Time Stamp. When the target device is the Safety CPU Unit, this item cannot be selected. Opening only: Configuration check is not executed when establishing the connection.
Expected Packet Interval (EPI)	Set an interval for communications of safety process data between the originator and the target.
Timeout	Specify a timeout time using a multiple of the EPI value, allowed for determining a communications error. The default setting is EPI x 2 [ms] (timeout is allowed just once).
Network Delay	Set the transmission delay time on the network. The default setting is 0 [ms].
Network Reaction Time	Value of the connection response performance is shown in ms. This is used in calculating safety reaction time.

- 4 Select a desired device registered on the Connection Settings (Originator) Edit Pane, then right-click it and choose [Edit].

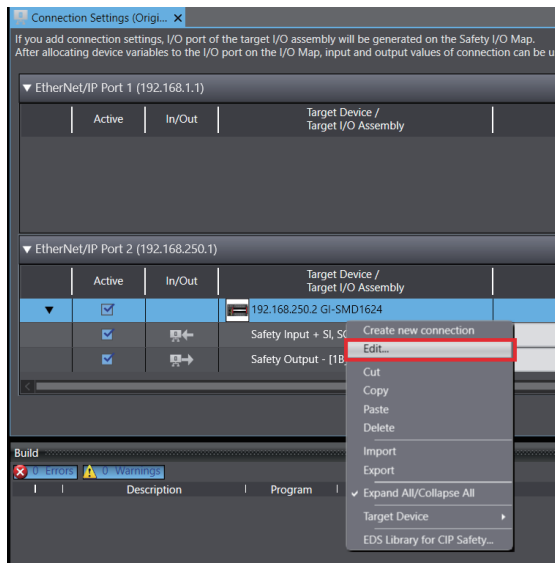

- 5 The following window opens. Choose the [I/O Configuration] Tab Page.

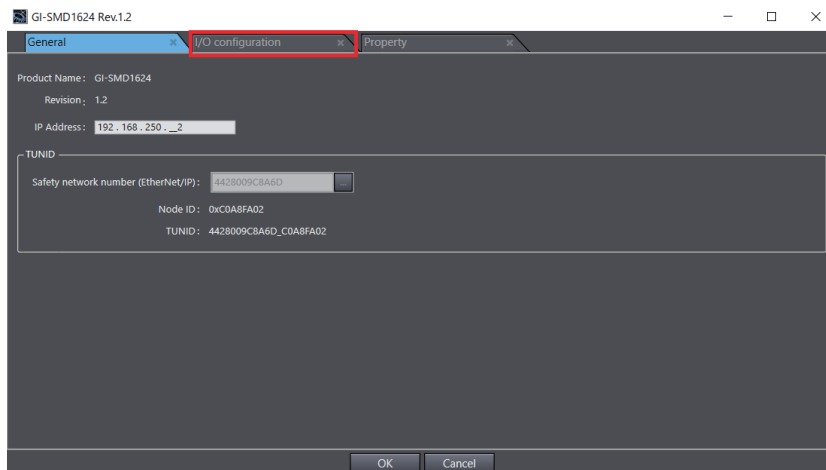

- 6 In the I/O Configuration Pane, set up input and output devices.

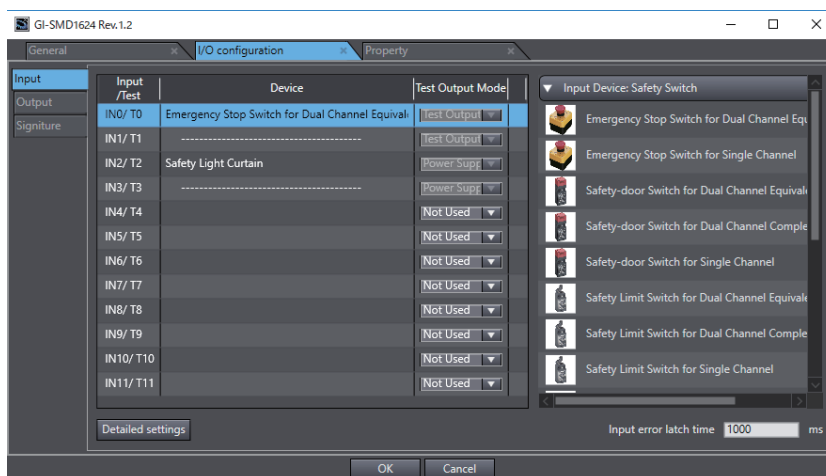

- Registering an input device

Choose the [Input] tab to the left to display the input device registration screen. Expand the toolbox to the right, and drag & drop a desired device into the specified terminal place to register the input device. □ Refer to 5-3 Safety I/O Functions on page 5-11 for applicable devices and details on them.

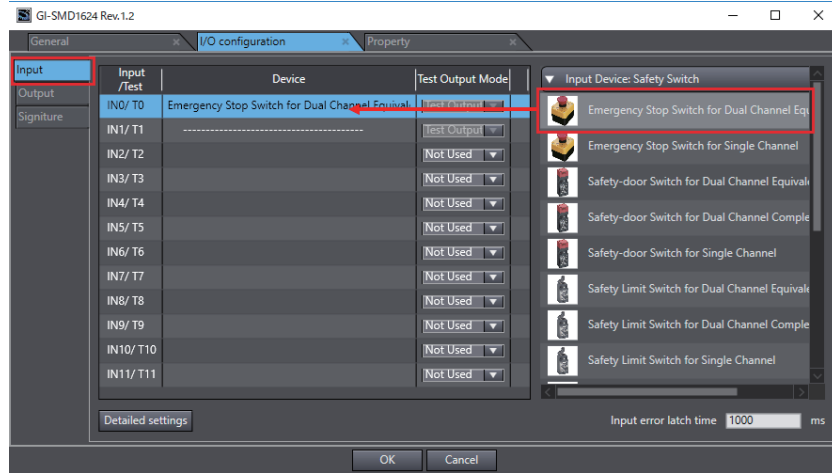

- Advanced settings of the input device

When you select the registered input device and press the [Detailed settings] button or choose [Detailed settings] from the pop-up menu of the registered input device, the Detailed settings screen for the input device will be displayed.

If necessary, set the delay time (at [ON->OFF Delay time] and [OFF->ON Delay time]) and the discrepancy time (only for the input device supporting dual channels).

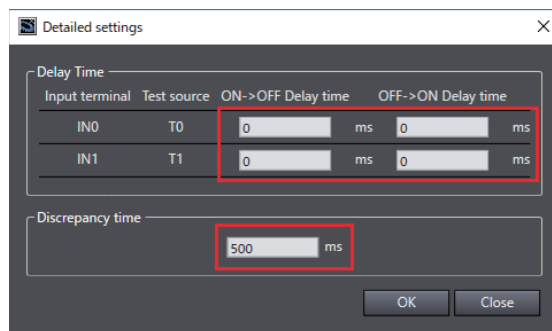
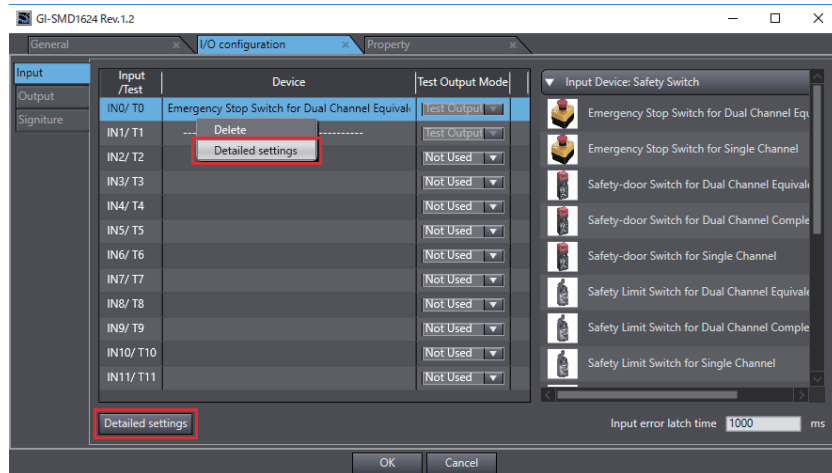



Additional Information

When [Safety Light Curtain] or [Safety Laser Scanner] is set to an input device, the initial value of ON->OFF Delay Time is 1 ms.

- Setting input error latch time

You can set input error latch time on the [Input] Tab Page in the I/O Configuration Pane.

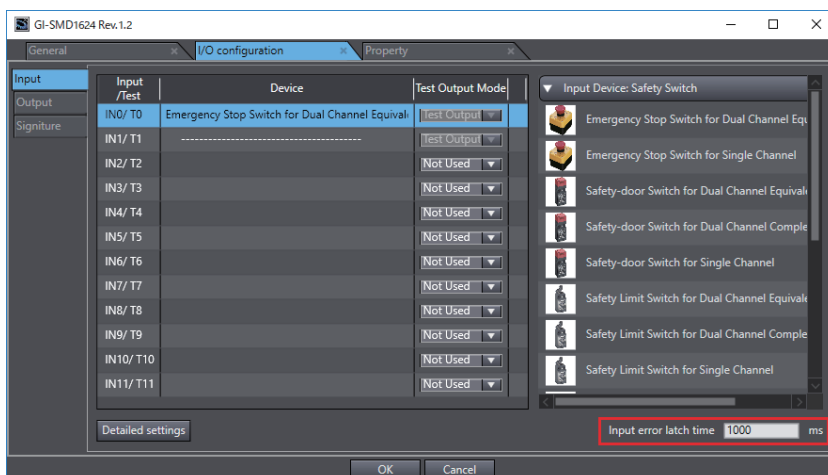

- Registering an output device

Choose the [Output] tab to the left to display the output device registration screen. Expand the toolbox to the right, and drag & drop a desired device into the specified terminal place to register the output device. Refer to 5-3 Safety I/O Functions on page 5-11 for applicable devices and details on them.

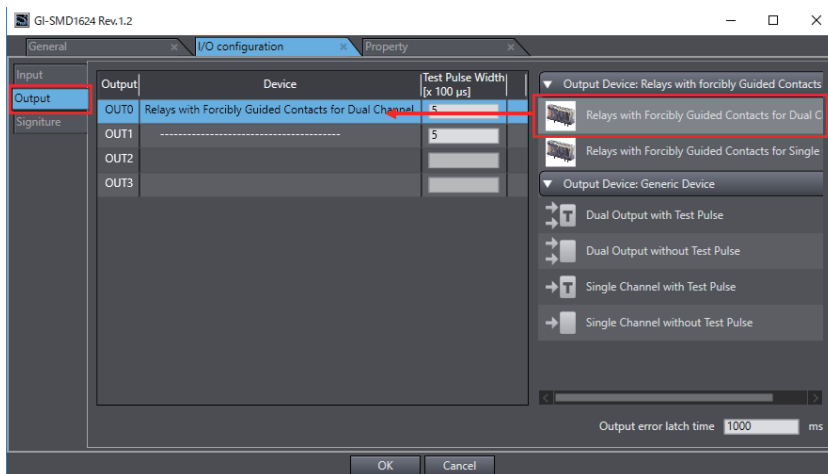

Precautions for Correct Use

For four output terminals, output devices with test pulse and without test pulse cannot be used at the same time. Be sure to decide the output device either with test pulse or without test pulse before setting the output device to the output terminal.

- Setting a test pulse width

You can set a test pulse width on the registration screen for the output device. Set it as necessary.

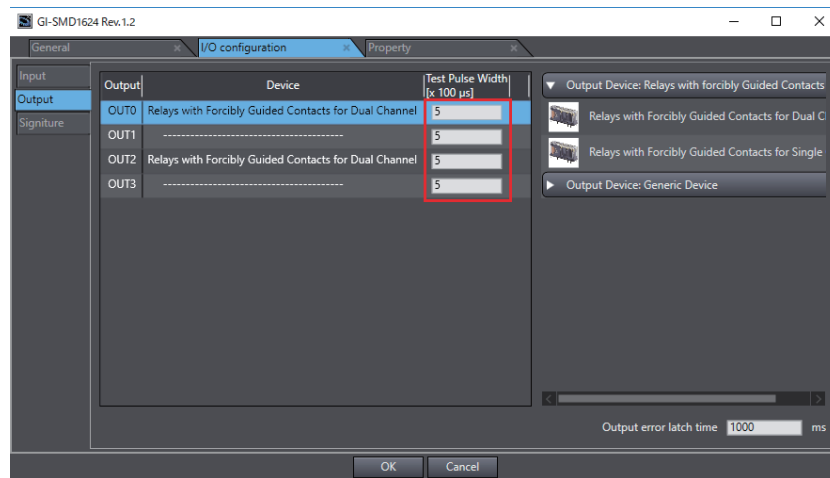

- Setting output error latch time

You can set output error latch time on the [Output] Tab Page in the I/O Configuration Pane. Set it as necessary.

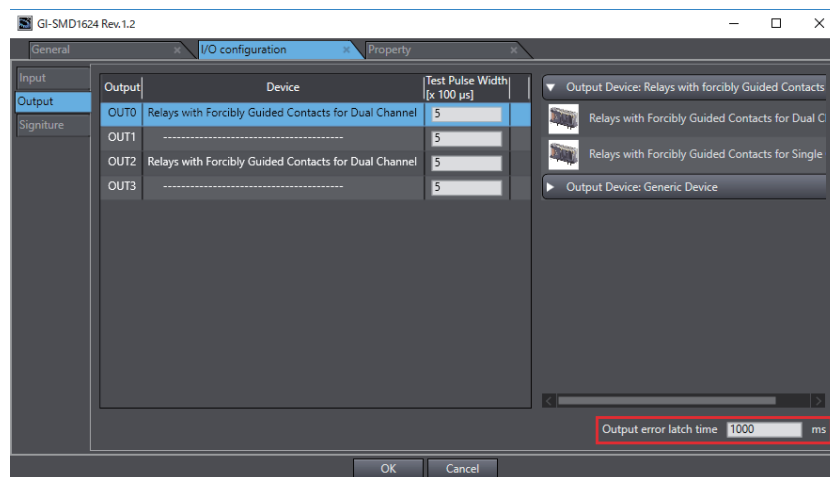

7 Click the [OK] button.



Additional Information

For example settings and wiring with the actual application used, refer to *A-4 Application Examples* on page A-17 etc.

6-3-6 Registering the Device Variables

Device variables are used to access data in slaves, Units, and safety I/O terminals.

This data is accessed through a port that acts as an interface to an external device. This logical port is called an "I/O Port."

To make the values of the I/O on the Safety I/O Units, safety I/O terminals, and other Safety I/O Units available in the safety program in the Safety CPU Unit, you must register device variables for the I/O Ports on the Safety I/O Units, safety I/O terminals, and other Safety I/O Units.

This section describes how to assign device variables to I/O Ports through the I/O Map of the safety I/O terminal.

● Registering New Variables or Creating Them Automatically

If the Controller configuration and the external devices to connect are finalized before you register the variables that are used in the program, you can create the device variable for the I/O Ports by manually entering the device variable name, or by creating them automatically.

- 1 Choose [Configurations and Setup] - [I/O Map] in the Multiview Explorer.

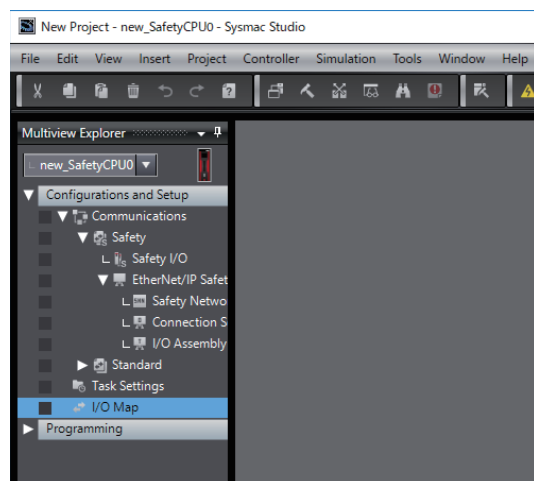

- 2 Expand [EtherNet/IP Port 1 (Originator)] - [GI-SMD1624] - [Safety Input][Safety Input Byte1] on the I/O Map Edit Pane.

Position	Port	R/W	Data Type	Variable	Var
	▼ CPU/Expansion Racks				
	NXBusM				
	▼ EtherNet/IP Port 1 (Originator)				
192.168	▼ GI-SMD1624				
	▼ Safety Input				
	▼ Safety Input Byte1				
	SI0	R	SAFEBOOL		
	SI1	R	SAFEBOOL		
	SI2	R	SAFEBOOL		
	SI3	R	SAFEBOOL		
	SI4	R	SAFEBOOL		
	SI5	R	SAFEBOOL		
	SI6	R	SAFEBOOL		
	SI7	R	SAFEBOOL		
	▶ Safety Input Byte2				
	▶ Safety Output				
	EtherNet/IP Port 2 (Originator)				
	▼ EtherNet/IP Port 1/2 (Target)				
	▶ NX-SL5700				

- 3** Select an I/O Port in the I/O Map for the safety I/O terminal, and enter a variable name directly in the [Variable] column. Or, select a safety I/O terminal name or I/O Port(s), then right-click it and choose [Generate Device Variable].

If you choose [Generate Device Variable], the device variables will automatically be named Device Name + Port Name. The device variables that you enter or automatically create are registered in the global variable table.

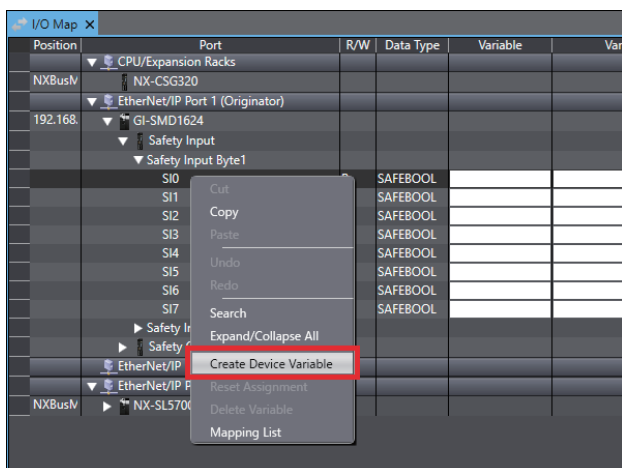

- 4** The device variable is registered as follows.

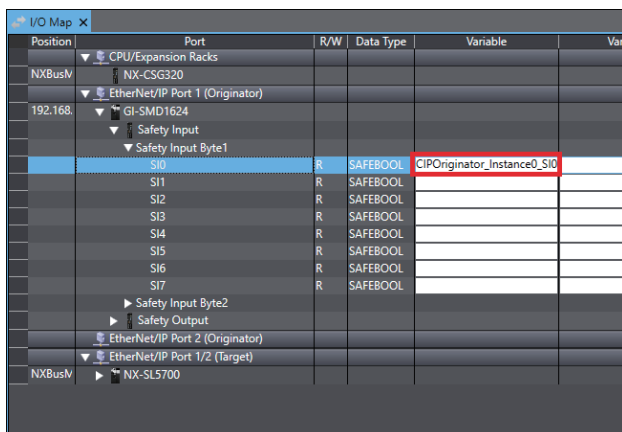

● Selecting from the Registered Variables

If the variables that are used in the program are registered before you finalize on the Controller configuration and the external devices to connect, you can select and assign variables to the I/O Ports for safety I/O terminals etc. as long as the variables are registered in the variable table.

- 1** Double-click [Configurations and Setup] - [I/O Map] on the Safety CPU Unit Setup and Programming View.
- 2** Select an I/O Port and select a user-defined variable from the list of variables that are registered in the variable table to assign the variable to that I/O Port.

6-3-7 Creating the Safety Programs

Create safety programs, using the device variables set for GI-S-series. For details on how to create safety programs, refer to *NX-series Safety Control Unit/Communication Control Unit User's Manual* (Cat. No. Z395).



Precautions for Correct Use

If the input terminals of the Safety I/O Terminals are set to Dual Channel Mode, use only the device variables assigned to even-numbered terminals as safety signals of the program.

If the output terminals are set to Dual Channel Mode, the safety signal of the program must be output to the device variables assigned to even-numbered and odd-numbered terminals.

· I/O Terminal settings example

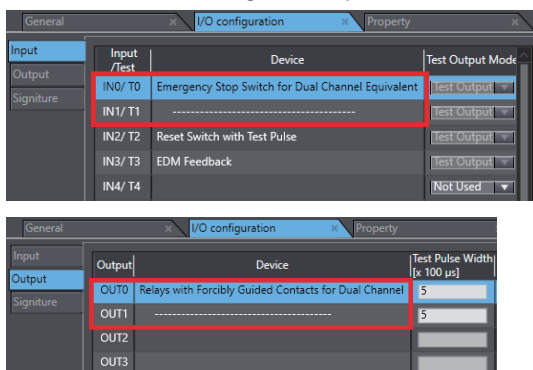

· I/O Map example

Position	Port	R/W	Data Type	Variable	Variable Comment	Variable Type
NXBusMaster						
CPU/Expansion Racks						
NX-CSG320						
EtherNet/IP Port 1 (Originator)						
EtherNet/IP Port 2 (Originator)						
192.168.250.2						
GI-SMD1624						
Safety Input						
Safety Input Byte1						
	SI0	R	SAFEROOL	EMO_NC_S1	Emergency Stop Pushbutton Switch(ZNC)	Global Variables
	SI1	R	SAFEROOL			
	SI2	R	SAFEROOL	Reset_S2	Reset Switch	Global Variables
	SI3	R	SAFEROOL	Feedback_KM1_KM2	EDM(Contact Welding Detection)	Global Variables
	SI4	R	SAFEROOL			
	SI5	R	SAFEROOL			
	SI6	R	SAFEROOL			
	SI7	R	SAFEROOL			
Safety Input Byte2						
	SI8	R	SAFEROOL			
	SI9	R	SAFEROOL			
	SI10	R	SAFEROOL			
	SI11	R	SAFEROOL			
Safety Output						
Safety Output Byte1						
	SO0	W	SAFEROOL	Contactor_KM1	Safety Relay w/ Welding Check	Global Variables
	SO1	W	SAFEROOL	Contactor_KM2	Safety Relay w/ Welding Check	Global Variables
	SO2	W	SAFEROOL			
	SO3	W	SAFEROOL			

· Program example

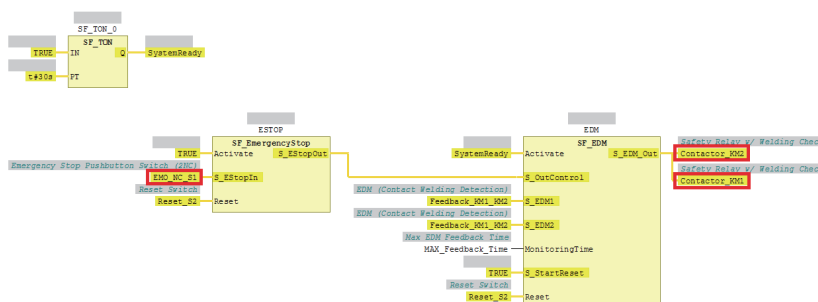

6-3-8 Debugging/Commissioning





Transfer the safety programs created with the Sysmac Studio to the safety network controller. When you debug your safety program or commission the safety network controller, the controller will establish the safety connection for GI-S Series.

The I/O settings of GI-S Series made with the Sysmac Studio will be transferred automatically from the safety network controller to the safety I/O terminal when the connection is established.

For details on how to transfer safety programs, commissioning procedure, operation check in DEBUG mode, and how to perform safety validation,  refer to *NX-series Safety Control Unit/Communication Control Unit User's Manual* (Cat. No. Z395).

When configuring the CIP Safety connection settings between GI-S-series and Safety CPU Units, you need to set TUNIDs to uniquely identify the GI-S-series arranged on a network.

For the procedure for setting TUNIDs,  refer to *6-4-2 CIP Safety Connection Settings* on page 6-34.

 WARNING	
Death due to injury may possibly occur. Before connecting a Safety I/O Terminal to the network, set a suitable IP address and communications speed.	
Required safety functions will be lost, and death due to injury may possibly occur. Make sure that the originator and target have the proper configuration if you want to set the Open type as "Open only".	
Required safety functions will be lost, and death due to injury may possibly occur. In debugging safety I/O terminals, check that the safety I/O terminals and the external devices operate properly as programmed by the CPU Unit which is an originator device.	
Death due to injury may possibly occur. Before you start the system, perform user testing to make sure that the configuration data of all devices are correct and they operate correctly.	



Precautions for Safe Use

Always confirm safety before you transfer data or setting values from the Sysmac Studio. During transfer, do not disconnect the cable or turn OFF the power supply to the Safety I/O Terminal.

6-4 Configuring and Setting Up the EtherNet/IP Network

6-4-1 Setting the IP Address

IP Addresses

● IP address configuration

The IP address is 32-bit binary data and consists of a net ID and a host ID. The net ID is an address to identify the Ethernet network, and the host ID is an address to identify the host (node).

IP addresses are divided into the three classes, Class A to Class C, so that an address architecture can be selected according to the network size (Class D and Class E cannot be used).

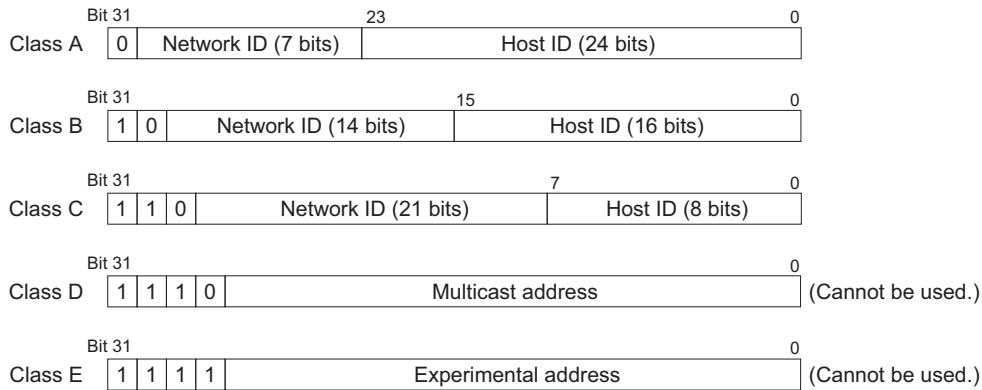

The number of networks and that of hosts which are identifiable vary with the class.

Class	Number of networks	Number of hosts
Class A	Small	224-2 max. (16,777,214 max.)
Class B	Medium	216-2 max. (65,534 max.)
Class C	Large	28-2 max. (254 max.)

The IP address is indicated as four dot-separated decimal numbers, after the 32-bit binary data is divided into four pieces of 8-bit data.

Example: 10000010 00111010 00010001 00100000 → 130.58.17.32

● IP address assignment

You must assign IP addresses nodes so that each IP address is assigned only once in the network or between multiple networks.

● **Subnet mask**

Connecting many nodes to one network will make it hard to operate and manage the network. In such a case, it is advisable to divide one network into multiple subnetworks and construct the system. It is operated as multiple networks internally, but it can be seen as one network externally.

To perform such operation, you need to divide the host ID of an IP address into the two IDs, a subnet ID and a host ID.

The information to identify this subnet ID is a subnet mask. The subnet mask comprises the net ID and subnet ID bits masked to "1" and the host ID bits masked to "0."

Example: The subnet mask, in an IP address of Class B, when 8 bits are used as a subnet ID

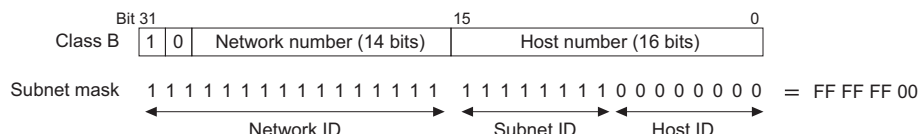

For the subnet mask, set a subnet mask value common to all the nodes on the subnetworks. Since the EtherNet/IP built-in port supports CIDR (Classless Inter-Domain Routing), the subnet mask can accept 192.0.0.0 up to 255.255.255.252.

If you use no subnetworks, set the following subnet mask values for IP addresses of Class A to Class C.

Class	Subnet mask
Class A	255.0.0.0
Class B	255.255.0.0
Class C	255.255.255.0

A network address is information derived from a subnet mask and used to identify each network. A network address enables users to determine whether multiple nodes belong to the same network. A network address is calculated by performing a logical AND operation on the IP address and subnet mask of a node.

The following are examples of network address calculation.

In this example, the IP address of node 1 is set to "192.168.250.20," the IP address of node 2 is set to "192.168.245.30," and the subnet mask is set to "255.255.240.0." The network addresses of the two nodes are calculated as follows.

- Calculating network address of node 1

Item	Decimal notation	Binary notation
IP address	192.168.245.30	11000000.10101000.11111010.00010100
Subnet Mask	255.255.240.0	11111111.11111111.11110000.00000000
Network address	192.168.240.0	11000000.10101000.11110000.00000000

- Calculating network address of node 2

Item	Decimal notation	Binary notation
IP address	192.168.250.20	11000000.10101000.11111010.00010100
Subnet Mask	255.255.240.0	11111111.11111111.11110000.00000000
Network address	192.168.240.0	11000000.10101000.11110000.00000000

As shown in the above table, node 1 and node 2 have the same network address, which means these nodes belong to the same network.

● **CIDR function**

CIDR stands for Classless Inter-Domain Routing, which is a function to assign IP addresses using no classes.

For IP addresses using some classes, the net ID and the host ID are divided on a specified block basis, preventing the efficient assignment of IP address space (the number of hosts) used.

CIDR does not use classes, so IP address space can be divided as required to more efficiently use IP address space.

For example, using a subnet mask setting with CIDR enables building a horizontally distributed network exceeding 254 nodes even if a class C address block (e.g., 192.168...) is used.

Subnet Mask Range
192.0.0.0 to 255.255.255.252

Built-in EtherNet/IP Port IP Address Settings

Use one of the following methods to set the IP address of the built-in EtherNet/ IP port. You can switch between setting methods using the IP address switch of the safety I/O terminal.

Available IP Address Settings XXX: Available setting	IP ADDRESS			IIP address setting method
	MOOD	x16	x1	
192.168.250.XXX	[0]	[01] - [FE]		Setting an IP Address with the x16/x1 IP Address Switches
XXX.XXX.XXX.XXX Any setting is available for all	[4]	[0]	[0]	IP address automatically acquired from the DHCP server
	[4]	[01] - [FE]		
	[0]	[0]	[0]	Fixed to an IP address
		[0FF] - [3FF]		
		[500] - [FFE]		
IP address cannot be set	[F]	[F]	[F]	Not available *1

*1. If the IP address switch is set to [FFF], an IP address cannot be set.
Do not set the IP address switch to [FFF].

Example of obtaining IP address from DHCP server:

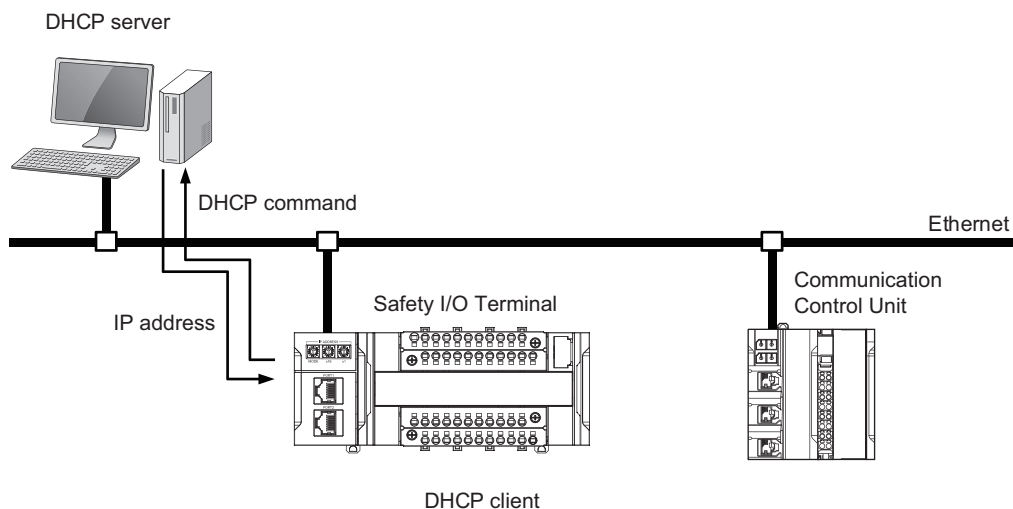

IP address set by the x16/x1 IP address switches

- 1 Set the [MODE] switch of the IP address switch to [0].
- 2 Set the [x16] and [x1] switches of the IP address switch to [01-FE].

If you use the x16/x1 IP address switches to set an IP address, the network ID (upper 24 bits) is fixed to 192.168.250 and the node ID (lower 8 bits) is set to a combined value of [x16] and [x1].

Setting example

When the IP address switches are set as MODE = [0], [x16] = A, and [x1] = 2, the IP address is 192.168.250.162.

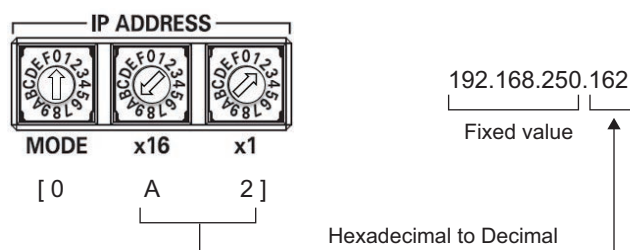

IP address automatically acquired from the DHCP server

- 1 Set the [MODE] switch of the IP address switch to [4].
- 2 Set the [x16] and [x1] switches of the IP address switch to [00-FF].

As an address management method on the DHCP server, management by MAC address or client ID is available.

- To manage on a MAC address basis, set the [x16] and [x1] IP address switches to [00].
- To manage on a client ID basis, set the [x16] and [x1] IP address switches to within a range of [01-FF].

A client ID is set by the values of IP address switches [x16] and [x1] and represented on the server as "GI-S_"+"values of IP address switches x16 and x1".

Fixed to an IP address

This setting cannot be used when a TUNID is set. If any TUNID is set, use a memory clear function to delete the TUNID from the safety I/O terminal. For details on the memory clear function,  refer to 6-4-3 *Memory Clear* on page 6-38.

- 1 Set the IP address switch of the safety I/O terminal to "000, 0FF to 3FF, 500 to FFE."
- 2 Use the MAC address indicated on the main body of the safety I/O terminal to set the IP address of the safety I/O terminal through the DHCP server.

The following products are recommended as the DHCP server configuration tool.

If you have any questions regarding the setting method, please contact our sales department.

Recommended DHCP server configuration tool

Manufacturer	Tool name
Rockwell Automation	BOOTP-DHCP server

- 3** When you start the DHCP server and turn ON the power supply to the safety I/O terminal, the IP address obtained from the DHCP server will automatically be reflected in the safety I/O terminal.
- 4** Start the Sysmac Studio.
- 5** Right-click on the module and press [Edit].

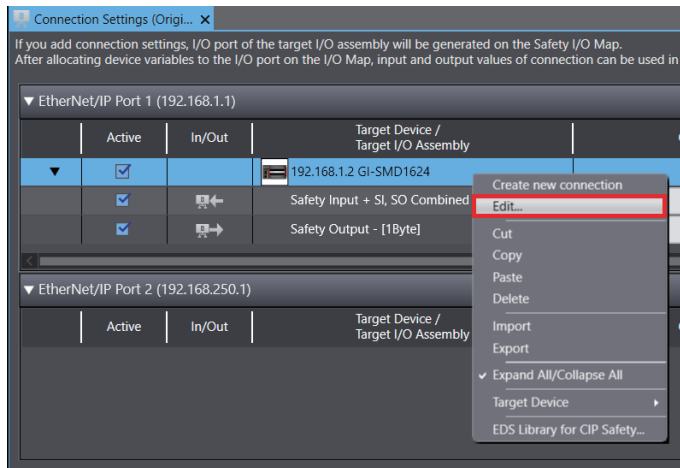

- 6** Enter any IP address in the [IP Address] box on the General Tab Page, and press the OK button. You can also enter the IP address obtained from the DHCP server configured in 2.

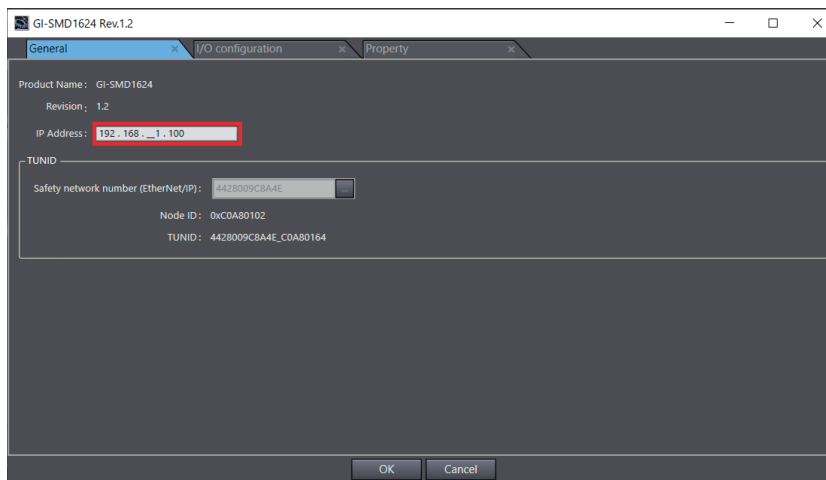

- 7** Place the Sysmac Studio online with the communication control unit. Choose [Controller] - [Online]. Or, click the Go Online button (⚠) in the toolbar.
- 8** Right-click on the device to set up, on the Connection Settings Edit Pane.

- 9 Open [Target Device] from the displayed menu, and click [TCP/IP].

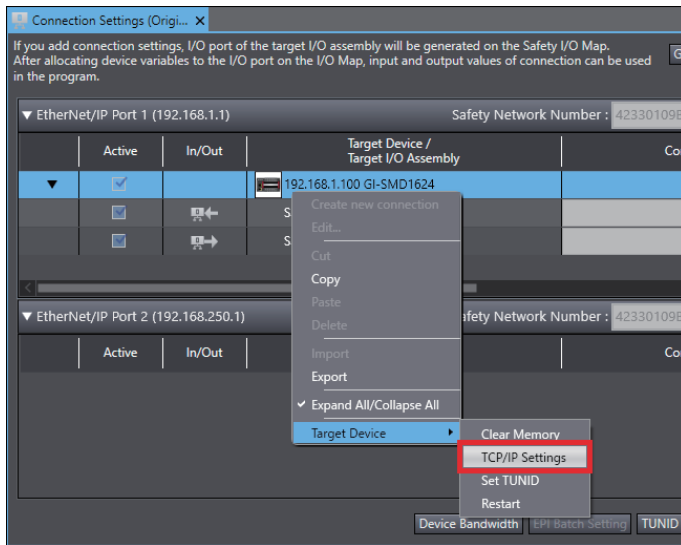

The following window opens.

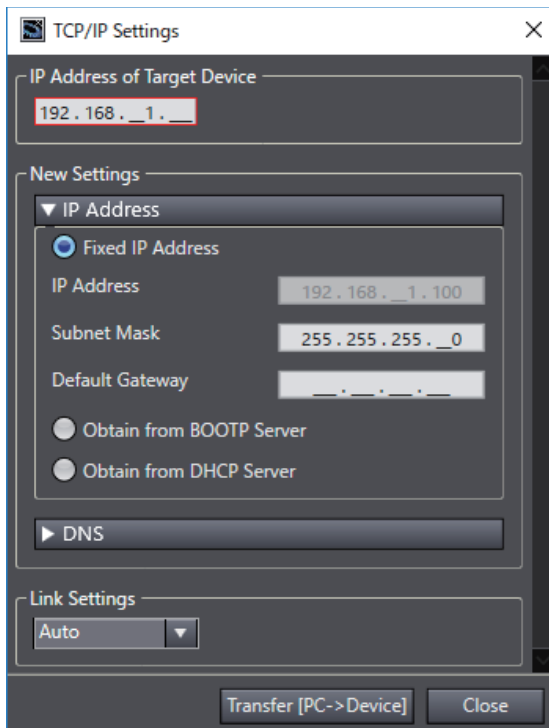

- 10 Enter the IP address obtained from the DHCP server configured in Step 2 in [IP Address of Target Device].

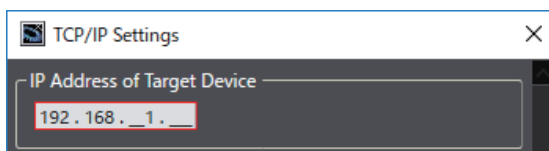

11 Check [Fixed IP Address] in [New Settings].

The [IP Address] box in [New Settings] is grayed out because the IP address, set in Step 6, is reflected there.

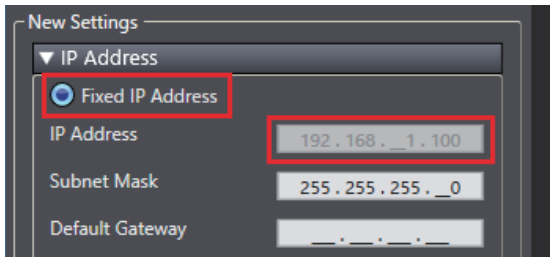
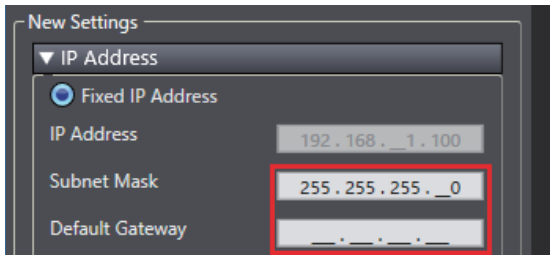
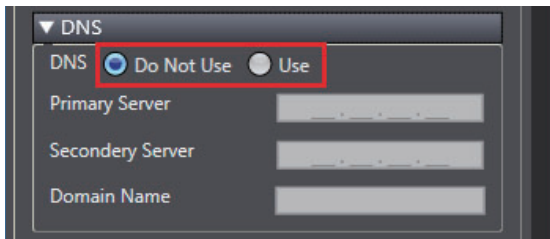
**12** Set [Subnet Mask] as desired and, if required, [Default Gateway].**13** At [DNS], check [Do Not Use]. ([Do Not Use] is checked by default.)**14** Click the [Transfer PC->Device] button.

The following screen appears. Click the [OK] button.

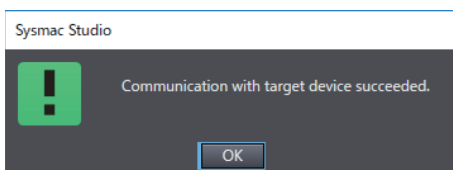

- 15** The following screen appears. Click the [OK] button to restart the safety I/O terminal.

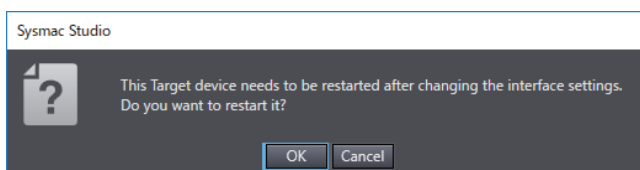

The following password input screen appears. Click the [OK] button with the Enter Password box blank. The IP address to set is saved to the built-in memory of the safety I/O terminal body.

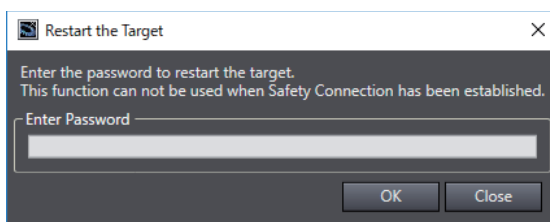

The the safety I/O terminal is restarted with the IP address reflecting the setting by Step 6. After it is restarted, the following window opens. Click the [OK] button.

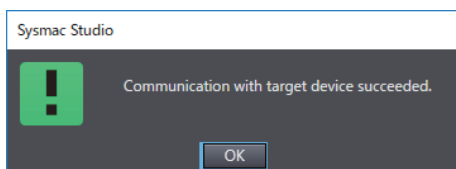

Click the [Close] button on the [TCP/IP Settings] screen to close the screen.

Now the IP address setting is complete. Do not change the IP address switch configured at Step 1.

The IP address is retained even if its power is restarted.



Additional Information

Since the safety I/O terminal does not have a password setting function, leave the Enter Password box blank.

- **To obtain the IP address from the DHCP server whenever the power is turned ON, instead of using that stored in the built-in memory**

Perform the following procedure with the IP address already stored in the built-in memory of the safety I/O terminal body. At this time, the IP address switch of the safety I/O terminal is "000, OFF to 3FF, 500 to FFE."

- **Setting with IP address switch**

- 1** When managing it on a MAC address basis, set the IP address switch of the safety I/O terminal to "400." When managing it on a client ID basis, set the IP address switch of the safety I/O terminal to "401 to 4FF."
- 2** When you turn ON the power supply to the safety I/O terminal, the IP address obtained from the DHCP server will automatically be reflected in the safety I/O terminal.

- **Setting with Sysmac Studio**

This setting cannot be used when a TUNID is set. If any TUNID is set, use a memory clear function to delete the TUNID from the safety I/O terminal. For details on the memory clear function, refer to *6-4-3 Memory Clear* on page 6-38.

- 1 Leave the IP address switch of the safety I/O terminal set at "000, OFF to 3FF, 500 to FFE."
- 2 When you turn ON the power supply to the safety I/O terminal, it will operate with the IP address stored in the built-in memory.
- 3 Start the Sysmac Studio.
- 4 Right-click on the device to set up, on the Connection Settings Edit Pane.
- 5 Open [Target Device] from the displayed menu, and click [TCP/IP].

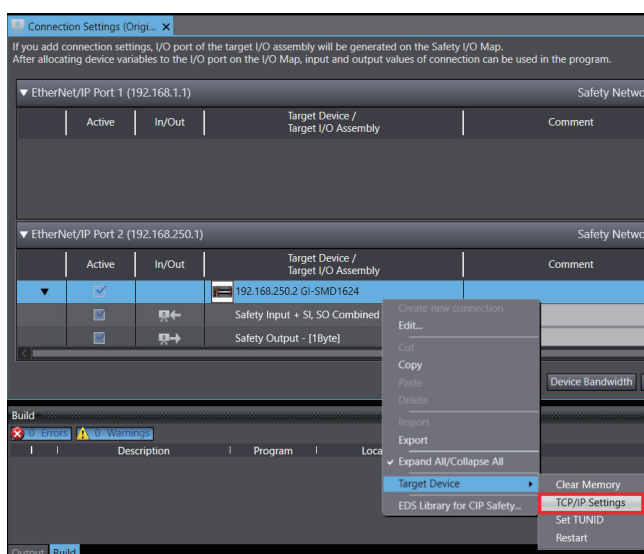

- 6 Enter the current IP address of the safety I/O terminal to set up, in [IP Address of Target Device].

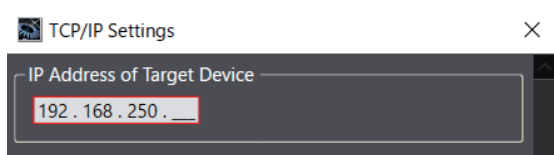

- 7 Check [Obtain from DHCP Server] in [New Settings].

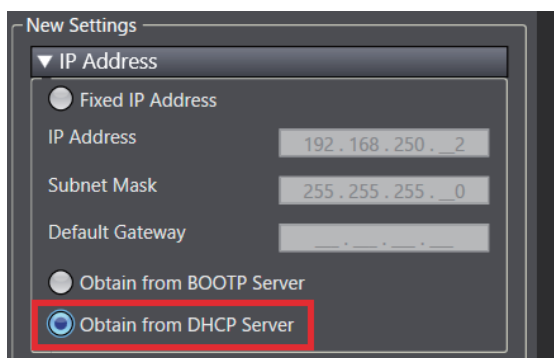

- 8** Click the [Transfer PC->Device] button.
The following screen appears. Click the [OK] button.

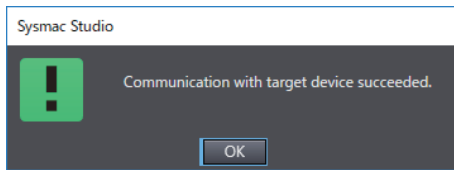

- 9** The following screen appears. Click the [OK] button.

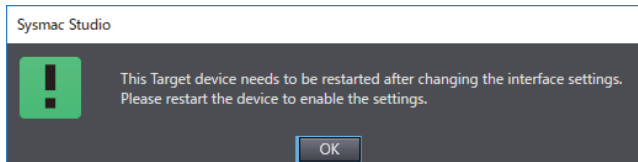

Press the [Close] button on the [TCP/IP Settings] screen to close the screen.

When you cycle the power supply to the safety I/O terminal, the IP address will come to be obtained from the DHCP server.

6-4-2 CIP Safety Connection Settings

Safety Network Number Settings

The Safety Network Number (SNN) is a unique number to set for safety networks.

For CIP Safety, it is used to uniquely identify and cross-check devices in multiple EtherNet/IP network configurations. In order to uniquely identify the devices, a 10-byte TUNID, a 6-byte safety network number plus a 4-byte node ID, is used.

There are two procedures for setting the TUNID:

- TUNID Setting (Individually)
- TUNID Batch Setting

TUNID Setting (Individually)

The procedure for setting TUNIDs individually is as follows.

- 1 Right-click on the device to set up, on the Connection Settings Edit Pane.
- 2 Open Target Device from the displayed menu, and click [Set TUNID].

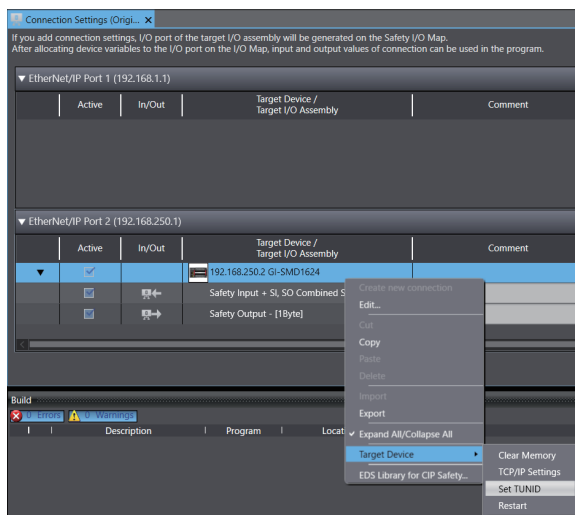

- 3 When TUNID setting has succeeded, the following message appears. Click the [OK] button to close the screen.

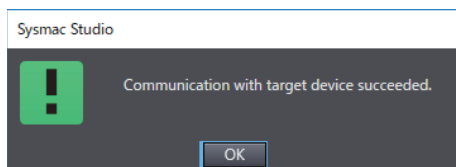

If any TUNID is already set, the following message appears. To set a new TUNID, first use a memory clear function to delete the existing TUNID from the safety I/O terminal, and then set that TUNID. For details on the memory clear function, refer to 6-4-3 *Memory Clear* on page 6-38.

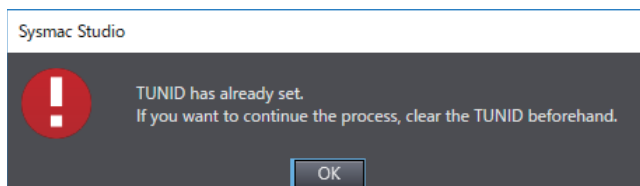

TUNID Batch Setting

You can set TUNIDs by batch to the targets registered on the Connection Settings Edit Pane.

The procedure for setting TUNIDs by batch is as follows.

- 1 Click [TUNID Batch Setting] in the lower right corner of the Connection Settings Edit Pane. The TUNID Batch Setting screen is displayed.

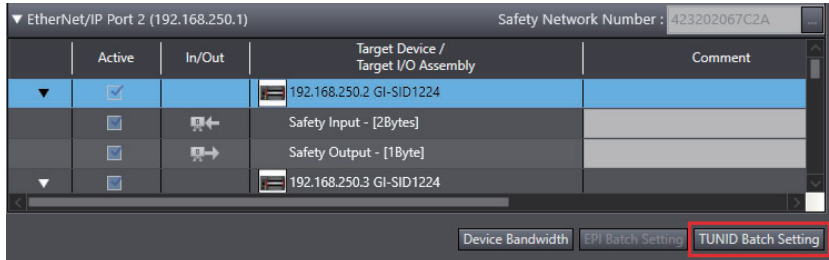

- 2 Click [Get All Targets Status].

Status is obtained from targets on the Connection Settings Edit list to judge whether TUNIDs are ready to be set for the targets.

You can also decide not to obtain the status of some targets by unchecking their check boxes.

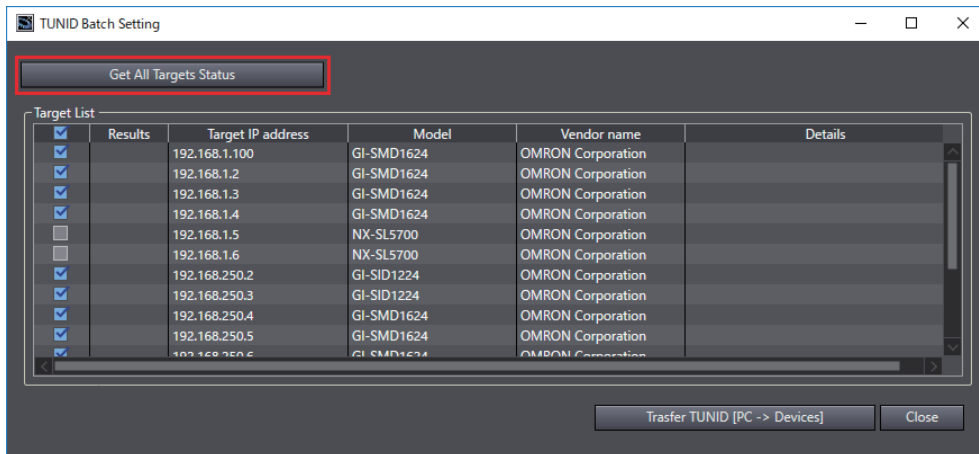

- 3 The results of obtained status appear on the window in real time.

When TUNIDs can be set, the check boxes of devices having such status are kept checked.

If TUNIDs cannot be set, the check boxes of those having such status will be unchecked.

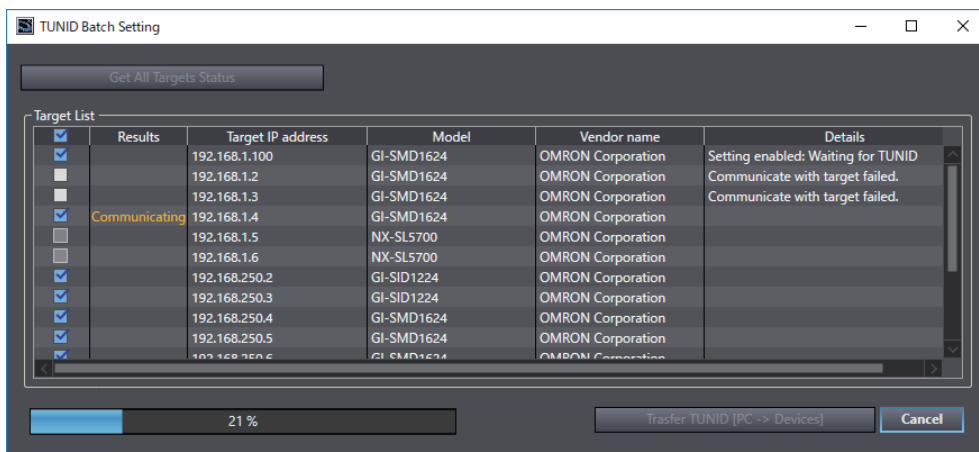

Moreover, the following results of obtained status are displayed in the Details column.

If a TUNID can be set

[Setting enabled]: Waiting for TUNID

If a TUNID cannot be set

[Setting disabled]: The status of the device is displayed. *

If communications with the device have failed

[Communicate with target failed]

* The status information is compliant with the definitions in CIP Safety specifications.

If [Communicate with target failed] is displayed, correct the connection of the communications cable, IP address setting of the target, etc.

If Setting disabled is displayed, as the case may be, use a memory clear function to change the status of the target.

- 4** After the status is obtained, the following message appears.

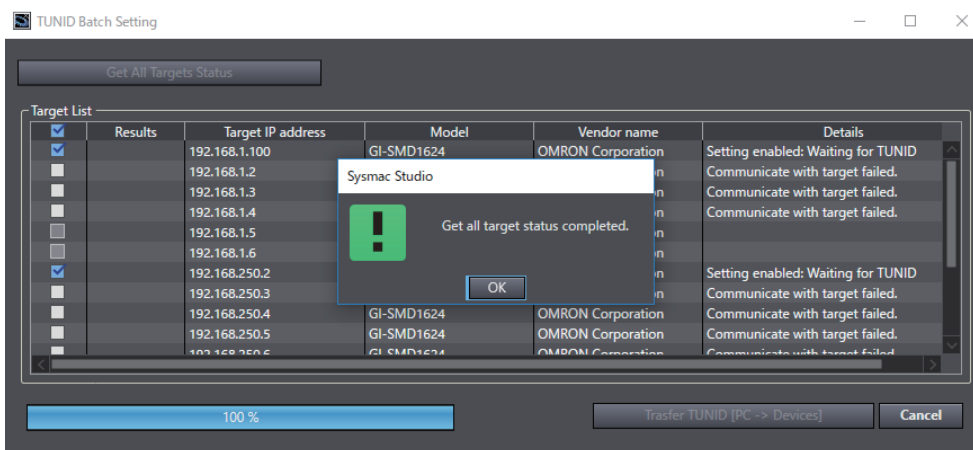

- 5** Next, click the [Transfer TUNID [PC -> Devices] button. The TUNID batch setting starts. At this time, you can also select/deselect the check boxes.

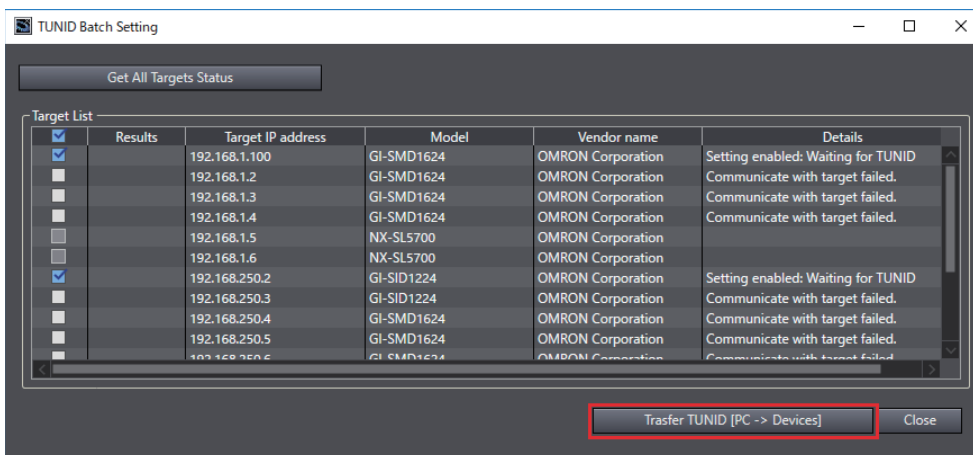

6 After the TUNID batch setting is completed, the following message appears.

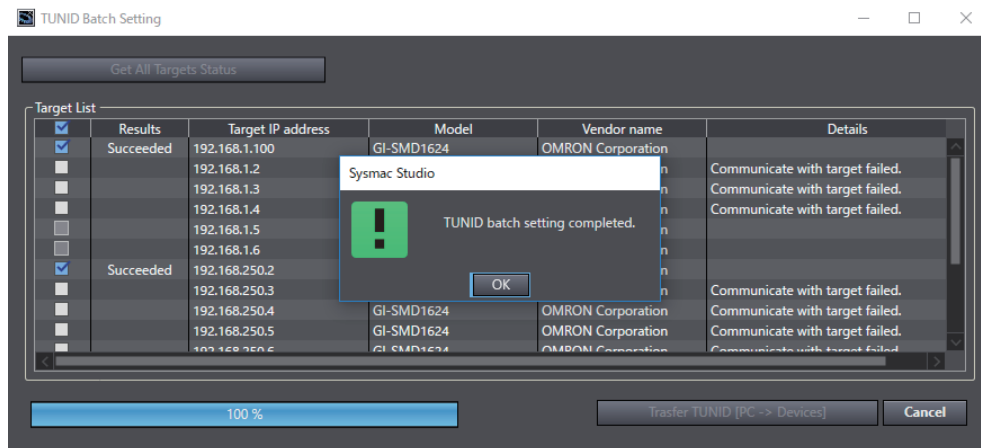

The TUNID setting result for each target is displayed in the [Results] column.

When a TUNID is set correctly, [Succeeded] appears.

If [Failed] is displayed, the TUNID is not set correctly.

Correct the communication environment or, if the TUNID is already set, clear the memory and then set the TUNID again.

6-4-3 Memory Clear

The "IP Address" and "TUNID" settings of the safety I/O terminal can be cleared by the memory clear function. Note that this function cannot be used when a safety connection is established and when a TUNID is not set. If any safety connection is established, put the Safety CPU Unit into PROGRAM mode and stop the connection. For how to enter the PROGRAM mode, refer to *NX-series Safety Control Unit/Communication Control Unit User's Manual* (Cat. No. Z395).

Use the following procedure to clear the memory.

- 1 Right-click on the device to set up, on the Connection Settings Edit Pane.
- 2 Open [Target Device] from the displayed menu, and click [Clear Memory].

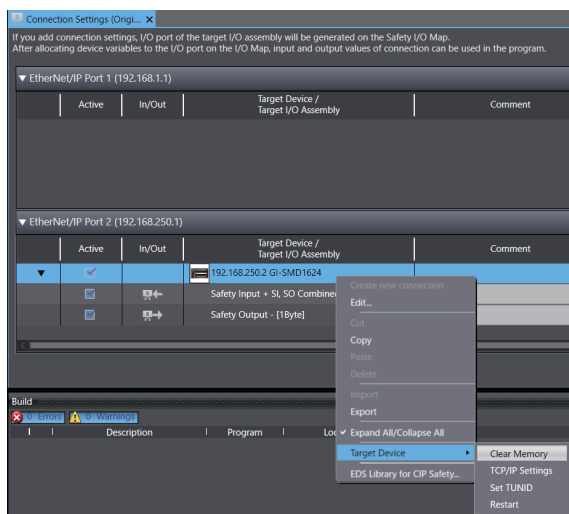

- 3 The following window opens.

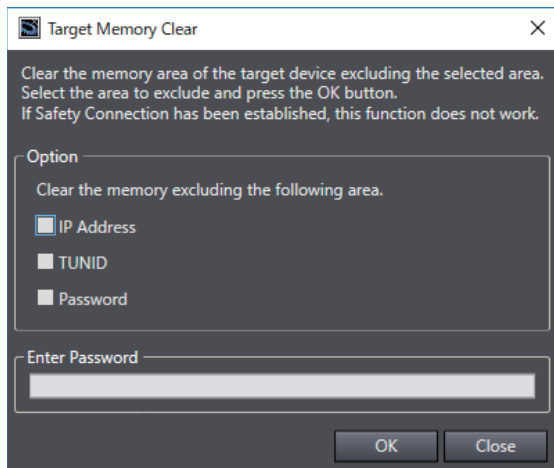

In [Option], you can select the areas which will not be subject to the memory clear function. This function always clears all the areas other than those selectable in the above Option. Check the check boxes of the areas which will not be subject to the clear function. Click the [OK] button with the [Enter Password] box blank. The memory clear function is carried out.



Additional Information

Since the safety I/O terminal does not have a password setting function, leave the Enter Password box blank.

- 4 When clearing memory has succeeded, the following message appears. Click the [OK] button to close the screen.

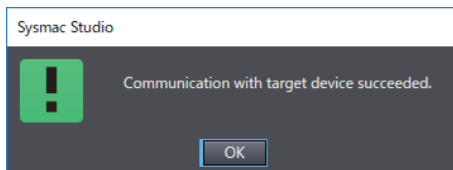

If the TUNID of the safety I/O terminal is not set, the following message appears. After clearing the memory, set the TUNID again.

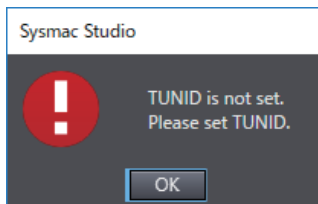

If the following screen is displayed, see the check items below.

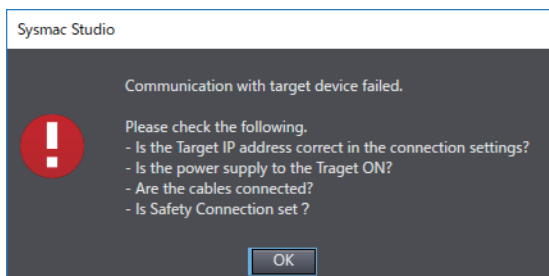

Check item	Remedy
Whether the IP address of the target device is set correctly	Check the IP address of the target device and enter it in the Sysmac Studio setting correctly.
Whether the Unit power supply is ON	Turn ON the Unit power supply.
Whether the Ethernet cable is connected	Connect the Ethernet cable.
Whether the connection has stopped	Enter the PROGRAM mode and stop the connection.

6-4-4 Restart

The restart function allows you restart the safety I/O terminal without cycling the Unit power supply to the safety I/O terminal.

This function cannot be used when a safety connection is established. If any safety connection is established, put the Safety CPU Unit into PROGRAM mode and stop the connection. For how to enter the PROGRAM mode, refer to *NX-series Safety Control Unit/Communication Control Unit User's Manual* (Cat. No. Z395).

Use the following procedure to restart the safety I/O terminal.

- 1 Right-click on the device to set up, on the Connection Settings Edit Pane.
- 2 Open Target Device from the displayed menu, and click [Restart].

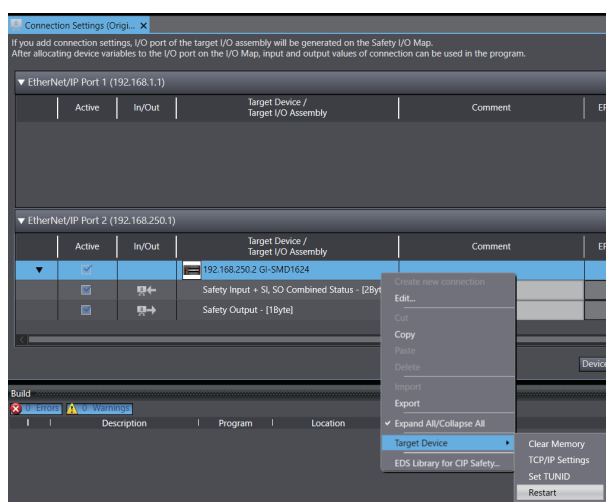

- 3 The following window opens. Click the [OK] button with the box blank. The safety I/O terminal is restarted.

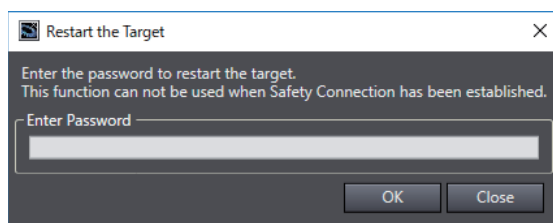

- 4 Click the [OK] button.

When restart has succeeded, the following message appears. Click the [OK] button to close the window.

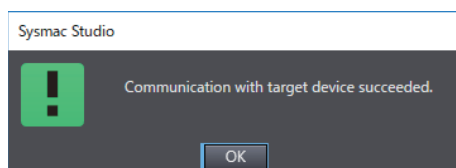

If communications failed, the following screen is displayed. If the following screen is displayed, see the check items below.

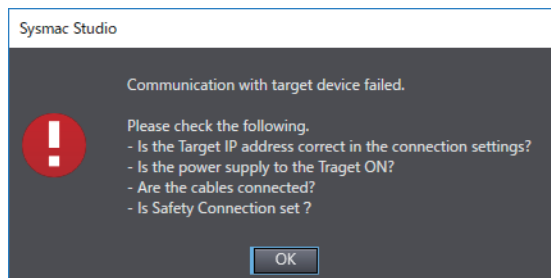

Check item	Remedy
Whether the IP address of the target device is set correctly	Check the IP address of the target device and enter it in the Sysmac Studio setting correctly.
Whether the Unit power supply is ON	Turn ON the Unit power supply.
Whether the Ethernet cable is connected	Connect the Ethernet cable.
Whether the connection has stopped	Enter the PROGRAM mode and stop the connection.

6-5 Exporting/Importing Settings Data

This section describes how to reuse the settings data for the safety I/O terminal in the Sysmac Studio. You can export and import the settings data for the safety I/O terminal as a single file.

The following data are processed:

- Connection settings with the CPU Unit
- IP address of the safety I/O terminal set with the Sysmac Studio
- Configuration of the I/O functions of the safety I/O terminal

6-5-1 Exporting/Importing Safety I/O Terminal Settings

You can export and import the settings data for the safety I/O terminal as a single file (extension .tds).

- 1 Right-click on the device to set up, on the Connection Settings Edit Pane.
- 2 Click [Export] from the displayed menu.

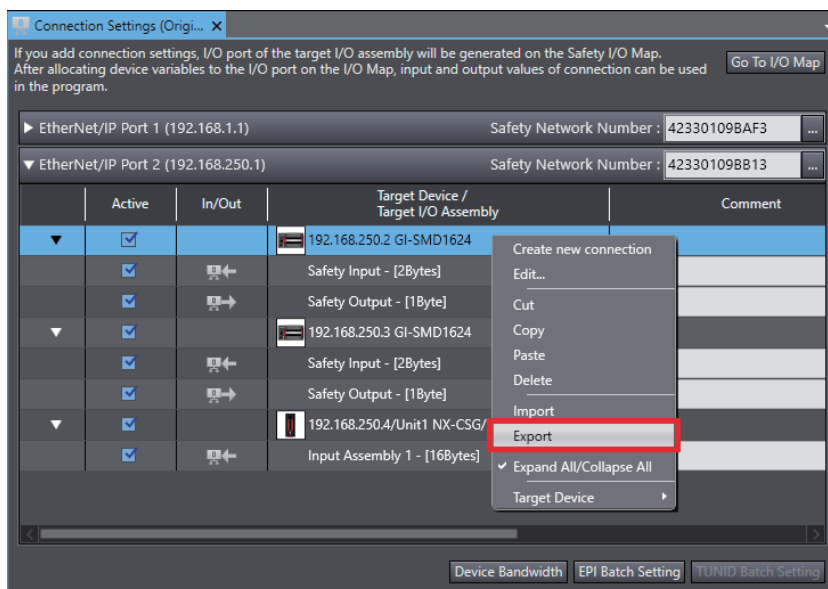

The [Export] dialog box is displayed.

Select a destination location, enter a desired file name, and click the [Save] button.

A safety I/O terminal configuration file with a .tds extension is saved to the specified destination location.

The default file name is IP address_Target device name.tds.

- 3** To import a file, right-click on the Connection Settings Edit Pane, and click [Import] from the displayed menu.

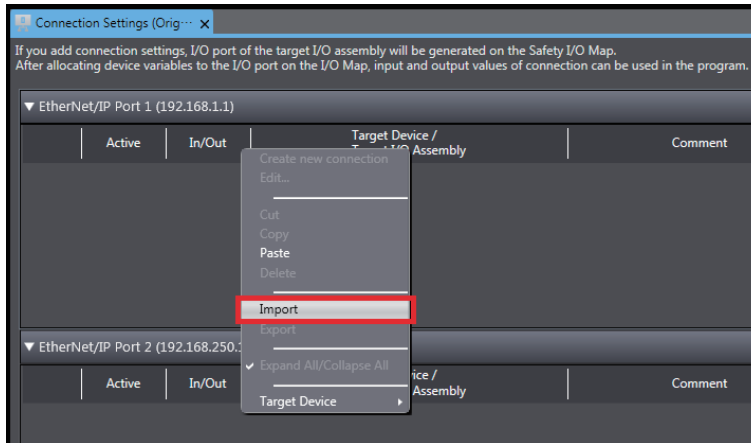

The [Import] dialog box is displayed.

Select a desired safety I/O terminal configuration file with a .tds extension, and click the [Open] button.



7

Safety Reaction Time Calculation

This chapter describes how to calculate safety reaction time of the safety I/O terminal.

7-1 Safety Reaction Time	7-2
7-1-1 How to Calculate Safety Reaction Time	7-2
7-1-2 How to Verify Safety Reaction Time	7-4
7-1-3 Safety Task	7-4
7-2 EPI (Expected Packet Interval)	7-5
7-2-1 Changing EPI	7-5
7-2-2 EPI Constraint	7-5

7-1 Safety Reaction Time

 WARNING	
Required safety functions will be lost, and death due to injury may possibly occur. Verify the calculated reaction times for all safety chains to confirm that they satisfy the required specifications.	
Death due to injury may possibly occur. Before connecting a Safety I/O Terminal to the network, set a suitable IP address and communications speed.	

This chapter provides description of safety reaction time of the safety I/O terminal.

Safety reaction time is the maximum time required for output shutdown taking into account the occurrence of failures in the safety chain*1. In safety system design, safety distance is calculated based on the safety reaction time. In all safety chains, the maximum time from the safety input to the stop of the operating device must satisfy the required specifications.

*1. Safety chain is a logical connection linking safety input devices with safety outputs via safety I/O terminals/safety control units, to materialize safety functions.

7-1-1 How to Calculate Safety Reaction Time

Safety reaction time is a sum of (a) safety sensor/switch response time, (b) Safety Input Unit/slave response time, (c) network response time, (d) Safety CPU Unit response time, (e) Safety Output Unit/slave response time, and (f) actuator response time as shown below. The numbers and times of the elements depend on the route of the safety chain.

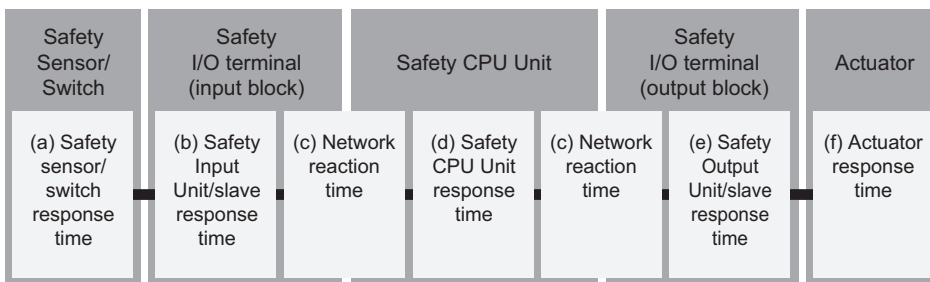

Case: Basic configuration

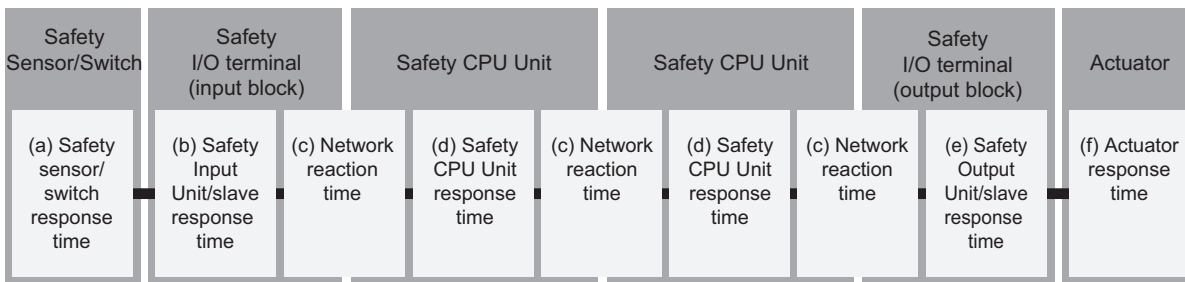

Case: Inter-controller network configuration



Shown below are details of the time elements:

Symbol	Time element	Description
(a)	Safety sensor/switch response time	Response time from ON to OFF of a safety sensor or a switch of a light curtain. Its value is defined for respective sensor or switch.
(b)	Safety I/O terminal (input block) response time	Input response time of CIP safety safety I/O terminal. Its value is defined for respective device. Response time values of safety I/O terminal (input block) are: GI-SMD1624: 11 ms + ON->OFF Delay time GI-SID1224: 11 ms + ON->OFF Delay time Add the set delay time if ON->OFF delay is configured for the safety input terminal. ON->OFF delay time: 0 to 1000 ms (Initial value: 0 ms ^{*1})
(c)	Network response time	Response time of CIP Safety connection.  Refer to <i>NX-series Safety Control Unit/Communication Control Unit User's Manual</i> (Cat. No. Z395) for how to check the network response time.
(d)	Safety CPU Unit response time	For the response time of the Safety CPU Unit,  refer to <i>NX-series Safety Control Unit/Communication Control Unit User's Manual</i> (Cat. No. Z395).
(e)	Safety Output Unit/slave response time	Output response time of CIP safety safety I/O terminal. Its value is defined for respective device. Response time values of safety I/O terminal (output block) are: GI-SMD1624: 4.5 ms + Output test pulse width When configuring a device with Test Pulse to the safety output terminal, add the output test pulse width. Test pulse width: 300 μs to 10 ms (Initial value: 500 μs)
(f)	Actuator response time	Response time from ON to OFF of an actuator such as a safety relay. Its value is defined for respective actuator.

*1. When [Safety Light Curtain] or [Safety Laser Scanner] is set to an input device, the initial value of ON->OFF Delay Time is 1 ms.



Precautions for Correct Use

- If the safety task period changes due to changes in the safety program or other reasons, recalculate the safety reaction times.
- To calculate the safety reaction times, add the "delaying influences from the input filter delay settings", the "safety program function block delay settings", and the "safety program loop-back connections".

7-1-2 How to Verify Safety Reaction Time

In all safety chains, verify that the calculated safety reaction time satisfies the requirement specifications.

If the calculated safety reaction time exceeds the requirement specifications, review either software or hardware design with either of the followings taken into account.

- Shorten the safety task period.
Example: Make the safety program smaller.
- Make EPI value of CIP Safety connection smaller.

7-1-3 Safety Task

Safety task period of Safety CPU Unit affects safety reaction time.

☐ Refer to *NX-Series Safety Control Unit/Communication Control Unit User's Manual* (Cat. No. Z395) for details of safety task.

7-2 EPI (Expected Packet Interval)

EPI stands for Expected Packet Interval indicating a transmission interval of safety data packets for CIP Safety.

EPI affects safety reaction time.

Making EPI smaller shortens the network response time thus safety reaction time, while it burdens Ethernet/IP communication ports.

7-2-1 Changing EPI

EPI is set for each connection. Use the following steps to change it.

- 1 On the controller selection box in the Multiview Explorer, select a target Safety CPU Unit.
- 2 Select [Configuration and Setup] - [Composition] - [Safety] - [Ethernet/IP Safety Connection Settings], and double-click [Connection Settings (Originator)].

The following screen of Connection Settings (Originator) appears.

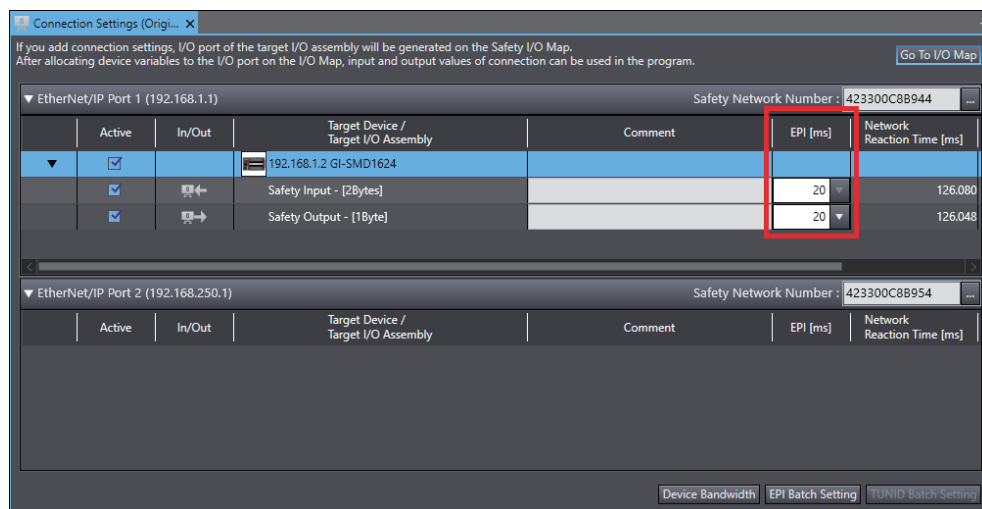

Select a connection setting of EPI to change, and set a value in the [EPI] column.

To change the EPI of Safety Input, enter a value manually.

To change the EPI of Safety Output, select a value from the list.

7-2-2 EPI Constraint

Available range for EPI is automatically calculated and displayed by Sysmac Studio.

8

Troubleshooting

This section provides the error confirmation methods and corrections for errors.

8-1	How to Check for Errors	8-2
8-1-1	Safe State	8-2
8-2	Checking for Errors with the Indicators	8-3
8-3	Checking for Errors with the Sysmac Studio	8-6
8-3-1	Checking with Troubleshooting	8-6
8-3-2	Checking with the CIP Safety Monitor function	8-6
8-3-3	Error Descriptions and Corrections	8-13
8-4	Checking Communications Status with the Network Configurator	8-15
8-5	Error Detection by User Program	8-16

8-1 How to Check for Errors

The error details of the safety I/O terminal can be checked by either of the followings.

- Checking the Indicators
 - Refer to *8-2 Checking for Errors with the Indicators* on page 8-3.
- Checking the Sysmac Studio
 - Refer to *8-3 Checking for Errors with the Sysmac Studio* on page 8-6.

8-1-1 Safe State

The Safe State of GI-S-series safety I/O terminal is in the following state.

Applicable terminal	Status
Input	Output data to network: OFF
Output	Safety output: OFF

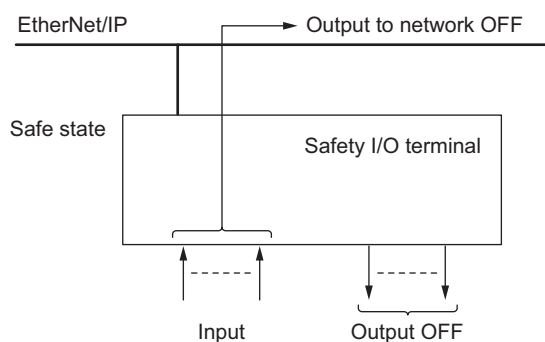

8-2 Checking for Errors with the Indicators

Checking the safety I/O terminals for Errors with the Indicators

⚠ WARNING

LEDs are NOT reliable indicators and cannot be guaranteed to provide accurate information. They should ONLY be used for general diagnostics during commissioning or troubleshooting. Do not attempt to use LEDs as operational indicators.



You can use the MS, NS, IN, and OUT indicators*1 on the safety I/O terminal to check for its I/O status and errors.



















This section describes the meanings of errors that the indicators show and the troubleshooting procedures for them.









☞ Refer to 3-1-5 *Indication Block* on page 3-11 for names and functions of the indicators.

*1. GI-SID1224 has no output terminal.

(n = Even number)

LED indication				Error	Operation	Value of I/O Port	Assumed cause	Correction	Recovery
IN n	IN n+1	OUT n	OUT n+1						
Lit yellow	Lit yellow	Lit yellow	Lit yellow	---	Status is normal.	---	---	---	---
Lit red	---	---	---	Error at Input Circuit (IN n) (In single channel mode)	I/O terminals enter the safe state.	Safety Input Status: FALSE	The positive power supply wire is in contact with the input signal line.	Check the wiring.	
							Short circuit with other wiring.		
							The external device is faulty.	Replace the external device.	
Lit red	Flashing red	---	---	Error at Input Circuit (with IN n Lit) (In dual channel mode)	I/O terminals enter the safe state.	Safety Input Status: FALSE	The positive power supply wire is in contact with the input signal line.	Check the wiring.	When safety input terminal goes inactive (OFF) and error latch time passes after cause of error is removed
							The input signal lines are shorted.		
							The external device is faulty.	Replace the external device.	
Lit red	Lit red	---	---	Discrepancy Error at Safety Input	I/O terminals enter the safe state.	Safety Input Status: FALSE	The input signal line is disconnected.	Check the wiring.	
							The external device is faulty.		
							The discrepancy time is invalid.	Re-evaluate the set time.	
---	---	Lit red	Flashing red	Error at Output Circuit (with OUT n Lit) Or Output ON Error (The same indication is used both in dual channel mode and in dual channel mode.)	Output terminals enter the safe state.	Safety Output Status: FALSE	The positive power supply wire is in contact with the output signal line.	Check the wiring.	When safety input terminal goes inactive (OFF) and error latch time passes after cause of error is removed
							The output signal lines are shorted.		
		Lit red	Lit red	Logic Inconsistent between Two Outputs (In dual channel mode)			Safety Output Status: FALSE	Setting error of output data	

LED indication				Error	Operation	Value of I/O Port	Assumed cause	Correction	Recovery
IN□	OUT□	MS	NS						
				---	Status is normal.	---	---	---	---
				Unit Power Supply Voltage Error (Less than 36 V)	I/O terminals enter the safe state.	Input Power Error : FALSE	Power is currently not supplied from the Unit power supply correctly.	Check the following and supply the rated power. Is the voltage of the Unit power supply within the specifications? Is the wiring correct and not disconnected?	After removing the cause of error, cycle the power supply.
				Unit Power Supply Over-current Error		Input Power Over Current Error : FALSE	Internal circuit failure	Replace the safety I/O terminal.	Replace the unit.
				Output Power Supply Voltage Error ^{*1} (When an over-voltage is detected)		Output Power Error : FALSE	Power is currently not supplied from the output power supply correctly.	Check the following and supply the rated power. Is the voltage of the output power supply within the specifications? Is the wiring correct and not disconnected?	After removing the cause of error, cycle the power supply.
				Output Power Supply Over-current Error		Output Power Over Current Error : FALSE	Internal circuit failure	Replace the safety I/O terminal.	Replace the unit.
				Unit Power Supply Voltage Error (When 36 V or more is applied for 2 seconds or more)	I/O terminals enter the safe state.	Input Power Error : FALSE	Power is currently not supplied from the Unit power supply correctly.	Check the following and supply the rated power. Is the voltage of the Unit power supply within the specifications? Is the wiring correct and not disconnected?	After removing the cause of error, replace the unit.
				Temperature Error		---	Being operated under an environment out of the operating temperature range	If the ambient temperature is 0°C or less or 55°C or more, install a heater or an air conditioner to adjust the temperature within the specifications.	After removing the cause of error, cycle the power supply.
				Internal Circuit Error		---	Failure of the internal circuit or other hardware	Replace the safety I/O terminal.	Replace the unit.
				Connection Timeout (A connection timeout occurred in CIP Safety Communications with the Safety Control Unit.)	Output terminals enter the safe state.		The communications cable is disconnected or broken.	Connect the communications cable securely.	Automatic recovery when cause of error is removed.
							An originator device entered a status where it could not accept the connection.	Check if the originator device is in a status where it can accept the connection.	
							The timeout value in communications setup is too small.	Increase the timeout value in communications setup, and transfer the setting.	
							There is excessive noise.	Implement noise countermeasures.	
				IP Address Switch Setting Error	I/O terminals enter the safe state.		The IP address switch was changed while power is supplied.	After restoring the original setting, restart the connection with the Safety Control Unit.	Cycle the power supply.
				Memory Cassette Error during Operation			The memory cassette became detached during operation.	Check the memory cassette for detachment.	After removing the cause of error, cycle the power supply.
							The memory cassette became faulty.	Replace the safety I/O terminal.	Replace the unit.
				Memory Internal Setting Error			The internal memory of the safety I/O terminal is different in settings from the memory cassette.	After clearing the memory, transfer the settings again. ^{*2}	When settings are transferred.

LED indication				Error	Operation	Value of I/O Port	Assumed cause	Correction	Recovery
IN□	OUT□	MS	NS						
 Not lit	 Not lit	 Flashing red	 Lit red	IP Address Duplication Error	I/O terminals enter the safe state.	---	The IP address of the built-in EtherNet/IP port is also used as the IP address of another node.	Perform either of the following: Check the IP addresses of other nodes and correct the IP address settings so that the same address will not be used by more than one node. Disconnect the node with a duplicated IP address.	After removing the cause of error, cycle the power supply.
				IP Address Error at Startup			The power was turned on with the value of an IP address switch changed from the original setting.	Put the value of an IP address switch back to the original setting.	After removing the cause of error, cycle the power supply.
				Memory Cassette Error at Startup			The memory cassette is detached at startup.	Check the memory cassette for detachment.	After removing the cause of error, cycle the power supply.
							The memory cassette is faulty.	Replace the safety I/O terminal.	Replace the unit.
 Flashing red	 Flashing red	 Flashing red / green	 Not lit	Memory Cassette Error at Startup	I/O terminals enter the safe state.	---	The internal memory of the safety I/O terminal is different in settings from the memory cassette.	After clearing the memory, transfer the settings again.	When settings are transferred.

- *1. The LED indications will remain unchanged if a low output power supply voltage is detected.
Output terminals enter the safe state, and Output Power Error becomes FALSE.
Automatic recovery is performed by removing the cause of error.
- *2. Before clearing memory to replace the safety I/O terminal, clear the memory with the target safety I/O terminal attached and with its memory cassette inserted. When the memory is cleared, both the safety I/O terminal and memory cassette are set to the factory default settings.

8-3 Checking for Errors with the Sysmac Studio

This section describes Troubleshooting procedure to identify Safety I/O Terminal in error state by Sysmac Studio.

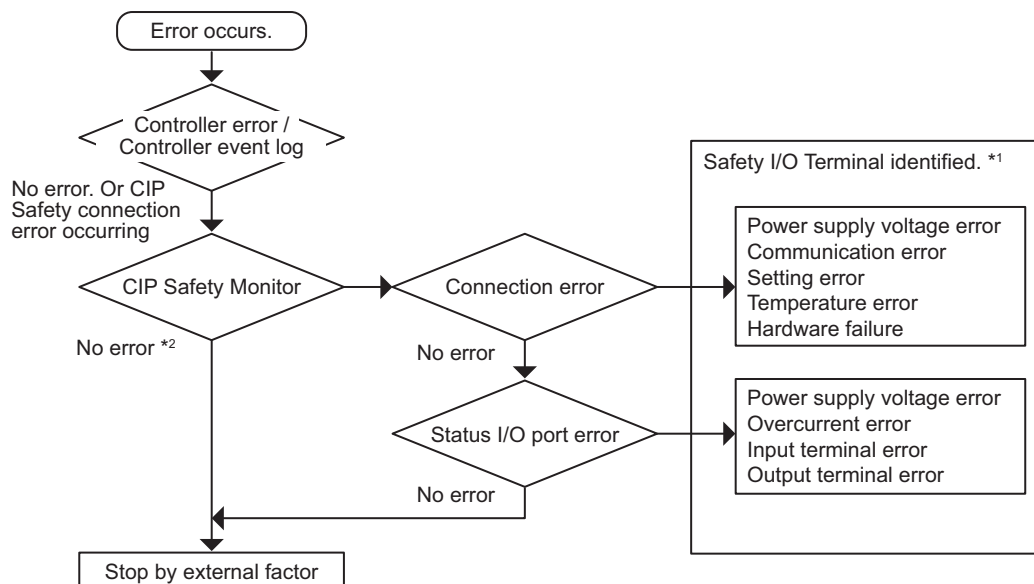

*1. Refer to 8-2 *Checking the safety I/O terminals for Errors with the Indicators* on page 8-3 for further error identification. Or, □ refer to 8-3-3 *Error Descriptions and Corrections* on page 8-13.

*2. Status I/O port error is cleared after error latch time expired in case the error cause removed.

8-3-1 Checking with Troubleshooting

Safety CPU Unit registers Controller error (event) in CIP Safety Connection category when it failed to establish safety connection with Safety I/O Terminal. Troubleshooting provides IP address information of Safety I/O Terminal caused the controller error (event). When the tag data link set between the safety I/O terminal and the standard controller cannot be established, an error (event) of the tag data link communication system is registered. The troubleshooting function can be used to determine the IP address of the safety I/O terminal that is the source of the controller error (event).

Refer to *Sysmac Studio Version 1 Operation Manual (Cat. No. W504)* for details on troubleshooting with Sysmac Studio.

8-3-2 Checking with the CIP Safety Monitor function

You can use a CIP Safety monitor function to check current safety I/O terminal errors and the log of the past errors. The target of the monitoring is safety I/O terminals registered in the safety connection settings of the Safety CPU Unit.

□ Refer to 6-3-2 *Registering a Safety Connection* on page 6-6 for how to register a safety connection.

Part Names and Functions of the CIP Safety Monitor

This section describes the names and functions of the components on the CIP Safety Monitor.

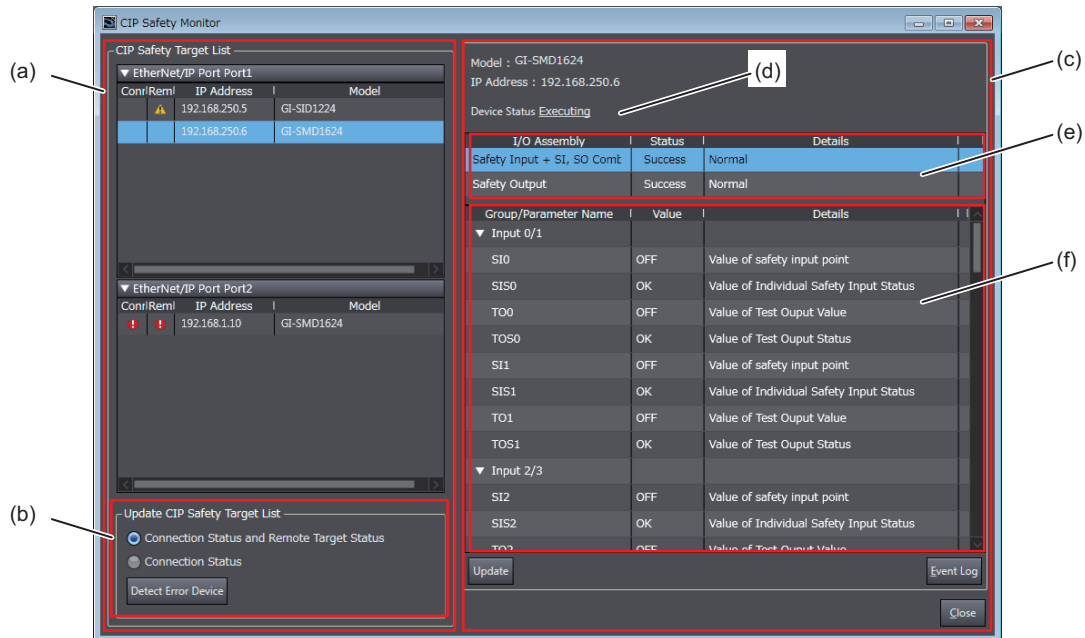

Symbol	Name	Description
(a)	CIP Safety Target List	A list of safety I/O terminals registered in the Safety CPU Unit.
(b)	Update CIP Safety Target List	Updates the status of the CIP Safety Target List.
(c)	Monitor Information	Monitor information of the safety I/O terminal selected in the CIP Safety Target List.
(d)	Device Status	Device status information of the safety I/O terminal.
(e)	Connection Status	Status information of the connections configured for the safety I/O terminal.
(f)	Parameter Monitor Value	Status information of input/output terminals of the safety I/O terminal.

Showing CIP Safety Monitor

This section describes how to display the CIP Safety Monitor.

- 1 Select **Online** from the **Controller** Menu. Or, click the Go Online button (🚩) in the toolbar.
- 2 In the Multiview Explorer, select the target Safety CPU Unit in the Controller Selection Box.

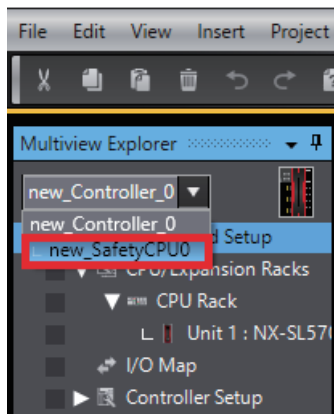

- 3 Select [Tool] - [CIP Safety Monitor]. Or, click the [CIP Safety Monitor] button (🔧) in the toolbar.
- If the information of the CIP Safety target device matches between the Safety CPU Unit and Sysmac Studio, [CIP Safety Target List] displays safety I/O terminals that are registered in the Safety CPU Unit as shown below.

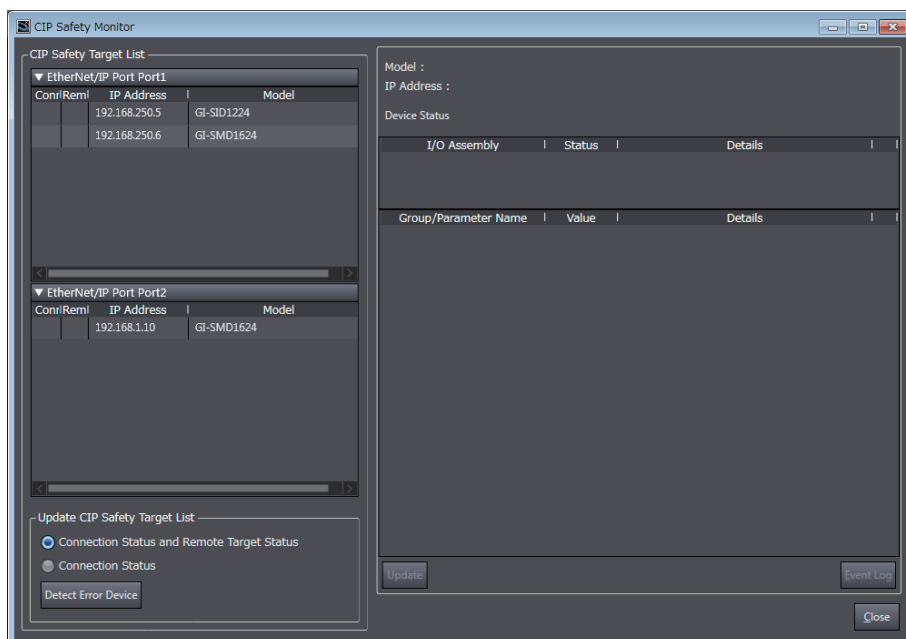

If the list of safety I/O terminals does not appear, click the [Get List from Safety CPU Unit] button. This will retrieve the connection settings from the Safety CPU Unit and display the device data in the list.

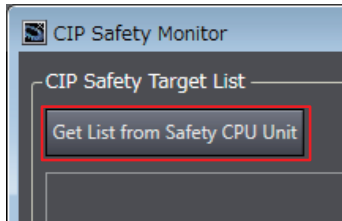

Precautions for Correct Use

The CIP Safety monitor function is available when the Safety CPU Unit is in RUN mode or DEBUG mode.

Identifying a Target Device with the Connection Error and its Cause

In the CIP Safety Target List, you can identify a safety I/O terminal with a connection error and its cause.

- 1 Go to [Update CIP Safety Target List] and select the checkbox for [Connection Status], and then click the [Detect Error Device] button.

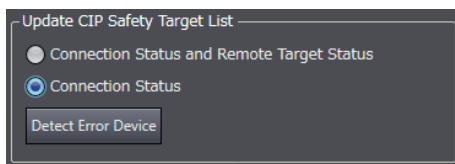

In the [CIP Safety Target List], the display of the connection status error icon is refreshed. If an error is present in the connection, an error icon is displayed.

Conn	Reml	IP Address	Model
		192.168.250.5	GI-SID1224
		192.168.250.6	GI-SMD1624

Icon	Description
	A connection between the target device cannot be established.
	No target device is found.

- 2 In the [CIP Safety Target List], click a safety I/O terminal where a connection error is present. The monitor information of the selected safety I/O terminal is updated. The connections configured to the safety I/O terminal and their statuses are displayed in the list. You will be able to identify the cause of the error by checking the details.

I/O Assembly	Status	Details
Safety Input	Success	Normal
Safety Input + SI, SO Comt	Failed	No connection resources exist for the target

Identifying the Safety I/O Terminal with Current Error and Checking the Causes

From the [CIP Safety Target List], you can identify the safety I/O terminal in which an error has occurred and check the causes.

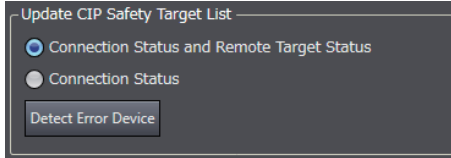

- 1 Go to [Update CIP Safety Target List] and select the checkbox for [Connection Status and Remote Target Status], and then click the [Detect Error Device] button.



The remote target status error icon is updated.

If a remote target status error is occurring, the error icon appears. If the remote target status is normal, the error icon is not displayed.

Conn	Rem	IP Address	Model
		192.168.250.5	GI-SID1224
		192.168.250.6	GI-SMD1624

Icon	Description
	An error has occurred in the target device.
	No target device is found.

- 2 Click the safety I/O terminal in which the error has occurred from the [CIP Safety Target List]. The monitor information of the selected safety I/O terminal is updated.

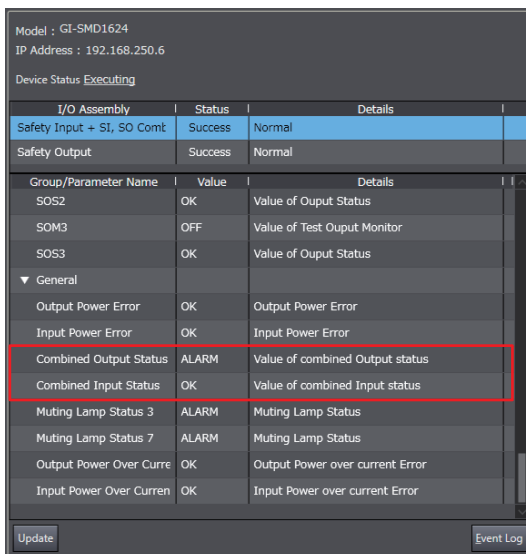

- 3** In the General group, check the values of Combined Input Status and Combined Output Status.
 ☐ Refer to 6-3-4 *Registering the I/O Assembly* on page 6-9 for details of the statuses.



Additional Information

Monitor values of Muting Lamp Status3 and Muting Lamp Status7 become ALARM if not used.

- 4** If Combined Input Status value is ALARM, check the statuses of input terminal group. If Combined Output Status value is ALARM, check the statuses of output terminal group.

Shown below is an example of errors occurring in safety output terminals OUT0 and OUT1.

Group/Parameter Name	Value	Details
▼ Output 0/1		
SOM0	OFF	Value of Test Output Monitor
SOS0	ALARM	Value of Output Status
SOM1	OFF	Value of Test Output Monitor
SOS1	ALARM	Value of Output Status
▼ Output 2/3		
SOM2	OFF	Value of Test Output Monitor
SOS2	OK	Value of Output Status
SOM3	OFF	Value of Test Output Monitor
SOS3	OK	Value of Output Status

Checking the Event Logs

You can check errors occurred in a safety I/O terminal.

- 1 Go to [CIP Safety Target List] and select a safety I/O terminal whose event logs you want to check.
- 2 From the monitor information, click the [Event Log] button.

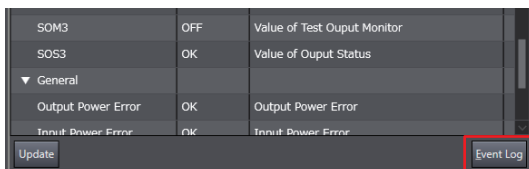

The event logs are displayed.

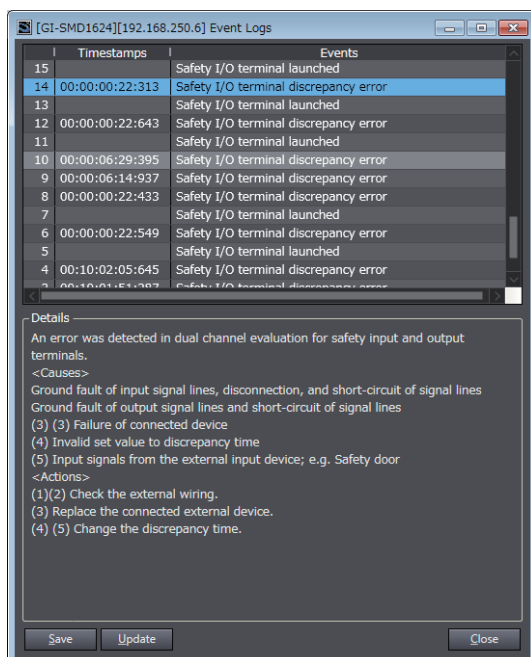

Item	Description
Timestamps	<ul style="list-style-type: none"> • Shows the elapsed time from the start of the safety I/O terminal. The format is [day:hour:minute:second:millisecond]. • The timestamp is not displayed for [Safety I/O Terminal Start] event.
Events	<ul style="list-style-type: none"> • Shows the event name occurred. • Up to 100 events can be displayed. When the number of events exceeds 100, the oldest event is deleted.
Details	Shows the cause and action for the selected event.

Selecting an event from the event list shows the cause and action for the event.



Additional Information

Clicking the [Save] button exports the event logs to an external file.

8-3-3 Error Descriptions and Corrections

This section describes errors that can occur in a safety I/O terminal. The event log of safety I/O terminal errors can be read out by the CIP Safety monitor function of Sysmac Studio.

Error event	Cause of error	Action
Unrecoverable error	An unrecoverable error occurred. <Causes> (1) Hardware failure	Replace the safety I/O terminal.
System error	A hardware error was detected by self-diagnosis function of the hardware. <Causes> (1) Hardware failure (2) Software error and memory error caused by transient factor such as noise	Cycle the power to the hardware. If the error occurs again, replace the safety I/O terminal.
Unit power supply voltage error or output power supply voltage error (Overvoltage detected)	An invalid unit power voltage or output power voltage was detected. <Causes> Power is not correctly supplied. Power supply voltage is out of the rated range.	Make sure the following and supply rated voltage. - Power supply voltage is within the rated range. - There is no wrong wiring or disconnection. If the measured voltage is normal, the unit may have failed. In that case, replace the unit.
Output power voltage error (Undervoltage detected)	Detected an output power voltage error. <Causes> Output power is not supplied correctly.	<Action> Make sure the following and supply rated voltage. - Power supply voltage is within the rated range. - There is no wrong wiring or disconnection. - 24V is not applied to the safety output terminal, or it is not in contact with the power supply (+ side). If the measured voltage is normal, the unit may have failed. In that case, replace the unit.
IP address switch setting error or IP address error at startup	Setting of the IP address switch was changed while power is supplied. <Causes> Setting of the IP address switch was changed while power is supplied.	Revert to the previous settings, and then restart connection with the Safety Control Unit.
	The unit was started while setting of the IP address switch has been changed from the original setting. <Causes> The unit was started while setting of the IP address switch has been changed from the original setting.	Please reset the IP address switch to the original setting.
Memory cassette error	Memory cassette is not mounted. <Causes> Memory cassette is not mounted.	Check the memory cassette installation status and turn ON the power again.
	There is an error in the memory cassette. <Causes> (1) Settings in internal memory of the Safety I/O terminal and the memory cassette do not match. (2) The memory cassette is broken.	(1) Mount the correct memory cassette. Or, clear the memory and then transfer the settings again. (2) Replace the memory cassette. Or, replace the safety I/O terminal.
Invalid parameter	An illegal parameter is configured.	Please check the parameter setting.

Error event	Cause of error	Action
External test signal failure at safety input or safety output terminal error	An error was detected in test pulse evaluation for safety input and output terminals. <Causes> (1) An input signal line contacts with power supply (+ side). (2) Short circuit between input signal lines (3) An output signal line contacts with power supply (+ side). (4) Ground fault of output signal lines (5) Failure of connected external device	(1) (2) (3) (4) Check the external wiring. (5) Replace the connected external device.
External test signal failure at safety input	The safety input terminal is connected with a wrong test output. <Causes> (1) An input signal line contacts with power supply (+ side). (2) Short circuit between input signal lines (3) Failure of connected external device	(1)(2) Check the external wiring. (3) Replace the connected external device.
Safety output terminal error	Stack-at-high was detected at the safety output terminal. <Causes> An output signal line contacts with power supply (+ side).	Check the external wiring.
Safety I/O terminal discrepancy error	An error was detected in dual channel evaluation for safety input and output terminals. <Causes> (1) Ground fault of input signal lines, disconnection, and short-circuit of signal lines (2) Ground fault of output signal lines and short-circuit of signal lines (3) Failure of connected device (4) Invalid set value to discrepancy time (5) Chattering occurred in the input signal from the external input device, such as a safety door.	(1)(2) Check the external wiring. (3) Replace the connected external device. (4)(5) Change the discrepancy time.
Overcurrent detected	Overcurrent is occurring in unit power supply or output power supply. <Causes> (1) Ground fault of output signal lines (2) Failure of connected external device	(1) Check the external wiring. (2) Replace the connected external device.
Safety I/O terminal launched	Safety I/O Terminal launched.	This is not a malfunction.
Safety data restoration with memory cassette	Copied the safety setting data from the memory cassette.	This is not a malfunction.

8-4 Checking Communications Status with the Network Configurator

You can use the Network Configurator to check the communications status (e.g., tag data link connection status) for each device on the EtherNet/IP network. □ Refer to *NX-series Safety Control Unit/Communication Control Unit User's Manual (Cat. No. Z395)* for details.

8-5 Error Detection by User Program

Safety CPU Unit does not register Controller error (event) when Safety I/O Terminal detects partial error like input circuit error. To detect an error using a user program, register the I/O assembly with Status I/O port to the Global Variables in Settings, and you can identify in the user program the safety I/O terminal and safety input/output terminal in an error state.

Choose I/O Assembly from the following according to the purpose. Refer to 6-3-4 *Registering the I/O Assembly* on page 6-9 for details on I/O assembly and I/O port.

- GI-SMD1624

Condition	I/O Assembly
In case monitoring error status of combined safety input / output terminal	Safety Input + Combined Status Safety Input + SI, SO Combined Status
In case monitoring error status of individual safety input / output terminal	Safety Input + SI PT. Status SO Pt. Status Safety Global Input

- GI-SID1224

Condition	I/O Assembly
In case monitoring error status of combined safety input terminal	Safety Input + Combined Status
In case monitoring error status of individual safety input terminal	Safety Input + SI PT. Status Safety Global Input



Additional Information

In case of monitoring error status of individual safety input/output terminals, the size of I/O data of each safety I/O terminal becomes larger therefore it affects possible maximum configuration of Safety CPU Unit.

9

Inspection and Maintenance

This section describes how to clean and inspect the safety I/O terminal as well as how to replace the safety I/O terminal.

9-1	Cleaning and Maintenance	9-2
9-1-1	Cleaning	9-3
9-1-2	Periodic Inspection	9-3
9-2	Maintenance	9-5
9-2-1	Replacing Safety I/O Terminal	9-6

9-1 Cleaning and Maintenance

This section describes daily maintenance and the cleaning and inspection methods.

WARNING

Required safety functions will be lost, and death due to injury may possibly occur.
In debugging safety I/O terminals, check that the safety I/O terminals and the external devices operate properly as programmed by the CPU Unit which is an originator device.



Required safety functions will be lost, and death due to injury may possibly occur.
Do not disassemble, repair, or modify the product.



CAUTION

Fire or malfunction may possibly occur if screws loosen.
Tighten terminal block fixing screws to the torques specified in this manual.



Moderate burn injury may possibly occur.
Do not touch any device when power is being supplied or immediately after the power supply is turned OFF.



Precautions for Safe Use

- Always turn OFF the power supply to the safety I/O terminal before you attempt any of the following.
 - 1) Installation
 - 2) Setting rotary switches
 - 3) Connecting cables or wiring the system
 - 4) Attaching or removing terminal blocks or connectors
 - 5) Attaching or removing the memory cassette

The Power Supply Unit may continue to supply power to the safety I/O terminal for a few seconds after the power supply turns OFF. The V0 indicator is lit during this time. Make sure that the V0 indicator is not lit before you perform any of the above operations.
- Avoid applying excessive force when you change the rotary switch settings.
- Insert the memory cassette all the way. And also, do not remove the memory cassette while the power is being supplied. Data may become corrupted, and the product will not operate correctly if it uses corrupted data.
- Always confirm safety before you transfer data or setting values from the Sysmac Studio. During transfer, do not disconnect the cable or turn OFF the power supply to the Safety I/O Terminal.

9-1-1 Cleaning

Perform the following cleaning procedures periodically to ensure the safety I/O terminal is maintained in the best operating condition.

- Use a dry, soft cloth to clean the unit every day.
- If dust or dirt remains even after wiping with a soft, dry cloth, wipe over with a cloth that has been wet with a sufficiently diluted detergent (2%) and wrung dry.
- A smudge may remain on the safety I/O terminal from gum, vinyl, or tape that was left on for a long time. Remove the smudge when cleaning.



Precautions for Correct Use

Never use volatile solvents, such as paint thinner, benzene, or chemical wipes.

9-1-2 Periodic Inspection

Although the major components in a safety I/O terminal have an extremely long life time, they can deteriorate under improper environmental conditions. Periodic inspections are thus required to ensure that the required conditions are being kept.

Inspection is recommended at least once a year, but more frequent inspections may be necessary depending on the severe environments.

Take immediate steps to correct the situation if any of the conditions in the following table are not met.

- Make sure that the safety I/O terminal is used within the specifications of the product.
- Make sure that the installation and wiring of the safety I/O terminal has been properly done.
- Perform safety function diagnosis to keep the function's reliability at a certain level.

Periodic Inspection Points

No.	Inspection item	Inspection details	Criteria	Correction
1	Unit power supply	Is the power supply voltage measured at the terminal block within standards?	20.4 to 28.8 VDC	Use a voltage tester to check the power supply at the terminals. Take necessary steps to bring the power supply within the power supply voltage range.
2	Output power supply	Is the power supply voltage measured at the output terminal block within standards?	20.4 to 28.8 VDC	Use a voltage tester to check the power voltage at the terminals. Take necessary steps to bring the output power supply within the power supply voltage range.

No.	Inspection item	Inspection details	Criteria	Correction
3	Ambient environment	Is the ambient operating temperature within standards?	0 to 55°C	Use a thermometer to check the temperature and ensure that the ambient operating temperature remains within the allowed range of 0 to 55°C.
		Is the ambient operating humidity within standards?	Relative humidity must be 10% to 95% with no condensation.	Use a hygrometer to check the humidity and ensure that the ambient operating humidity remains between 10% and 95%. Make sure that condensation does not occur due to rapid changes in temperature.
		Is it subject to direct sunlight?	Not in direct sunlight	Protect the Controller if necessary.
		Is there an accumulation of dirt, dust, salt, metal powder, etc.?	No accumulation	Clean and protect the Controller if necessary.
		Is there water, oil, or chemical sprays hitting the Controller?	No spray	Clean and protect the Controller if necessary.
		Are there corrosive or flammable gases in the area of the Controller?	No spray	Check by smell or use a sensor.
		Is the Unit subject to shock or vibration?	Vibration resistance and shock resistance must be within specifications.	Install cushioning or other vibration and shock absorbing equipment if necessary.
		Are there noise sources near the Controller?	No significant noise sources	Either separate the Controller and noise source or protect the Controller.
4	Installation and wiring	Are the cable connectors fully inserted and locked?	No looseness	Correct any improperly installed connectors.
		Are there any loose screws on the End Plates (PFP-M)?	No looseness	Tighten loose screws with a Phillips-head screwdriver.
		Are there any damaged external wiring cables?	No visible damage	Check visually and replace cables if necessary.
5	Safety validation testing (user testing)	Check to be sure that all safety functions operate correctly.	All functions must operate as intended.	Remove the cause of errors and check the operation of all safety functions again.

Tools Required for Inspections

● Required Tools

- Phillips screwdriver
- Flat-blade screwdriver
- Voltage tester or digital voltmeter
- Sufficiently diluted neutral detergent (2%) and pure cotton cloth

● Tools Required Occasionally

- Oscilloscope
- Thermometer and hygrometer

9-2 Maintenance

Remove the faulty safety I/O terminal, attach a new safety I/O terminal, and perform wiring.

☐ Refer to *Specifications of Configuration Units* on page 3-1 and *Installation and Wiring* on page 4-1 for installation, removal, and wiring of safety I/O terminal.

Described below are replacement steps of the safety I/O terminal.



Precautions for Safe Use

- Do not drop any product or subject it to abnormal vibration or shock. Doing so may result in injury, product malfunction or burning.
 - Follow the instructions in this manual to correctly perform installation and wiring.
 - Use the correct wire size, wiring parts and tools when you wire the system. Otherwise, cables may be disconnected to cause short-circuit or wire breakage.
 - Do not pull on the cables or bend the cables beyond their natural limit. Do not place any heavy objects on the cables or other wiring lines. Doing so may sever the cables.
 - Use the methods that are specified in this manual for wiring the terminal blocks.
 - When you install wiring, be sure to turn off the power beforehand. Otherwise, the external devices connected with the GI-S Series may operate unexpectedly.
 - Make sure that foreign material or metal dust should not come into the Safety I/O Terminal while wiring and/or installation. Doing so may result in product burning, electric shock, or failure.
 - Mount terminal blocks and connectors only after checking the mounting location carefully. During this time, be careful not to pinch your fingers.
 - Be sure that the terminal blocks and Ethernet communications cables with tightening screws or locking devices are properly tightened to or locked into place.
 - When you insert a flat-blade screwdriver into a release hole on the screwless clamping terminal block, press the screwdriver down with an appropriate angle and a force of 30 N or less. Applying excessive force may damage the terminal block.
 - Do not tilt or twist the flat-blade screwdriver while it is pressed into the release hole of the screwless clamping terminal block. Doing so may break the terminal block.
-

9-2-1 Replacing Safety I/O Terminal

Safety Precautions before Replacement

- A new safety I/O unit must be its factory shipment status.
If you are not sure if it is or not, perform Clear Memory on the new safety I/O terminal before replacement. ☐ Refer to 6-4-3 *Memory Clear* on page 6-38 for details.
- The replacement must be performed by workers who have proper knowledge of safety control.
- For worker's safety, turn OFF the power supply of hazards such as actuators.

WARNING

Death due to injury may possibly occur.

Clear the memory to delete the previous configuration data stored in the Safety I/O Terminal unit before installing the Safety I/O Terminal to the equipment or device, or connecting to a network.



Death due to injury may possibly occur.

Before connecting a Safety I/O Terminal to the network, set a suitable IP address and communications speed.



Death due to injury may possibly occur.

Before you start the system, perform user testing to make sure that the configuration data of all devices are correct and they operate correctly.



Required safety functions will be lost, and death due to injury may possibly occur.
Do not disassemble, repair, or modify the product.



Replacement Procedure

Remove the faulty safety I/O terminal, and attach a new safety I/O terminal.

- 1** Turn OFF the power of the safety I/O terminal.
- 2** Record the connections of wiring and terminal numbers, and remove the terminal block of the faulty safety I/O terminal.
- 3** Record the connections of EtherNet/IP communication cables and built-in EtherNet/IP port numbers, and remove the communication cable from the built-in EtherNet/IP ports.
- 4** Record rotary switch setting of the faulty safety I/O terminal.
- 5** Remove the faulty safety I/O terminal.
- 6** Remove the terminal block from the new safety I/O terminal.
- 7** Attach the new safety I/O terminal.
- 8** Set the rotary switch of the new safety I/O terminal to the recorded setting.
- 9** Attach the EtherNet/IP communication cable to the built-in EtherNet/IP port of the new safety I/O terminal.
- 10** Remove the memory cassette from the new safety I/O terminal.
- 11** Remove the memory cassette from the faulty safety I/O terminal, and attach it to the new safety I/O terminal.
- 12** Attach the terminal block removed from the faulty safety I/O terminal to the new safety I/O terminal.
- 13** Turn ON the power of the new safety I/O terminal.

Checking after Replacement

After replacement, always perform the user test to make sure that the safety function works properly. Also, make sure that the wiring and connection on the terminal block of the safety I/O terminal are correct by the user test.

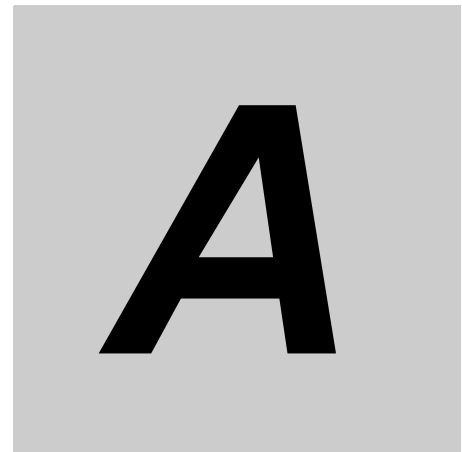

Appendices

This chapter provides dimensions, application examples, and other information of the safety I/O terminal.

A-1 External Dimensions	A-2
A-1-1 Safety I/O Terminal	A-2
A-2 Safety I/O Assembly Data	A-3
A-2-1 Safety Input Assembly	A-3
A-2-2 Safety Output Assembly	A-7
A-2-3 Configuration Data	A-8
A-3 EtherNet/IP Object Classes	A-11
A-3-1 Identity (0x01)	A-11
A-3-2 Message Router (0x02)	A-12
A-3-3 Assembly (0x04)	A-12
A-3-4 Connection Manager (0x06)	A-13
A-3-5 TCP/IP Interface (0xF5)	A-14
A-3-6 Ethernet Link (0xF6)	A-15
A-3-7 DLR (0x47)	A-15
A-3-8 QoS (0x48)	A-16
A-4 Application Examples	A-17
A-4-1 Emergency Stop Pushbutton Switch	A-17
A-4-2 Safety Doors	A-20
A-4-3 Safety Laser Scanners	A-23
A-4-4 Safety Door Switches with Magnetic Locks and Key Selector Switches	A-26
A-4-5 Enable Switches	A-30
A-4-6 Two-hand Switches	A-34
A-4-7 Safety Light Curtain	A-37
A-5 I/O Assemblies and I/O Ports for Safety I/O Terminal	A-40
A-5-1 Safety I/O Terminal (GI-SMD1624)	A-40
A-5-2 Safety I/O Terminal (GI-SID1224)	A-41
A-6 Version Information	A-42

A-1 External Dimensions

Dimensions of the CPU Units are shown as follows. The unit of dimension is millimeter.

A-1-1 Safety I/O Terminal

GI-S□□□□□□

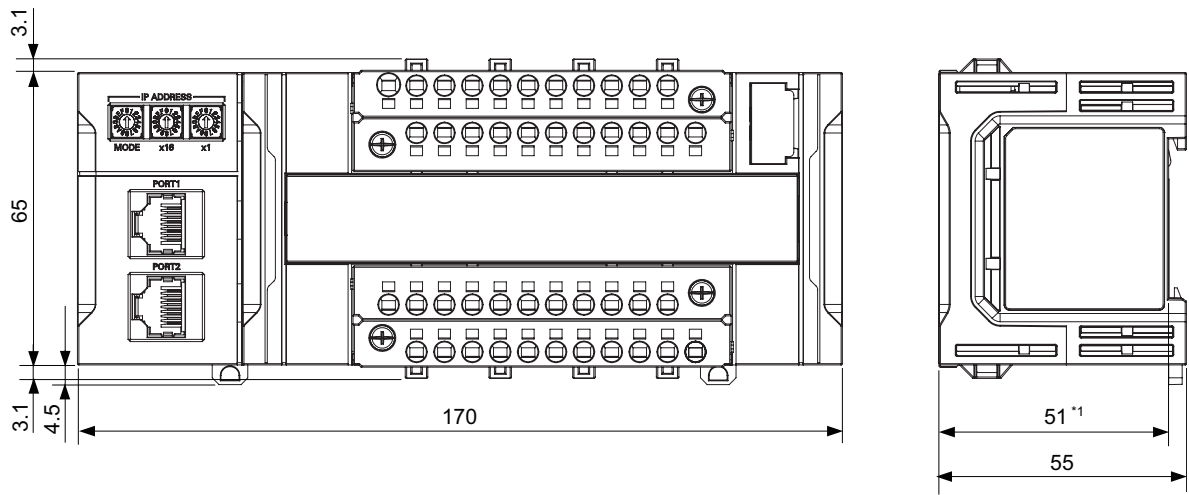

*1. DThis is a dimension from the DIN Track seat to the safety I/O terminal surface.

For dimensions when a communications cable is connected, □ refer to 4-1-6 Assembled Appearance and Dimensions on page 4-12.

A-2 Safety I/O Assembly Data

The I/O assembly data of the safety I/O terminal are as follows.

A-2-1 Safety Input Assembly

Safety Discrete Input Profiles

- **Input Data (Assembly 524 - 20C Hex), Size: 2 byte(s)**

	Byte Offset	Bit 15	Bit 14	Bit 13	Bit 12	Bit 11	Bit 10	Bit 9	Bit 8	Bit 7	Bit 6	Bit 5	Bit 4	Bit 3	Bit 2	Bit 1	Bit 0
Safety Inputs	00	n/u	n/u	n/u	n/u	Safety Input I ₁₁	Safety Input I ₁₀	Safety Input I ₉	Safety Input I ₈	Safety Input I ₇	Safety Input I ₆	Safety Input I ₅	Safety Input I ₄	Safety Input I ₃	Safety Input I ₂	Safety Input I ₁	Safety Input I ₀

n/u : Not used

Safety Input Ix: Gives the status of safety input terminal.

0: OFF, 1: ON

- **Input Data (Assembly 540 - 21C Hex), Size: 2 byte(s)**

	Byte Offset	Bit 15	Bit 14	Bit 13	Bit 12	Bit 11	Bit 10	Bit 9	Bit 8	Bit 7	Bit 6	Bit 5	Bit 4	Bit 3	Bit 2	Bit 1	Bit 0
Safety Inputs + Combined Safety Input Status	00	Global Safety Input Status CIS	n/u	n/u	n/u	Safety Input I ₁₁	Safety Input I ₁₀	Safety Input I ₉	Safety Input I ₈	Safety Input I ₇	Safety Input I ₆	Safety Input I ₅	Safety Input I ₄	Safety Input I ₃	Safety Input I ₂	Safety Input I ₁	Safety Input I ₀

n/u : Not used

Safety Input Ix: Gives the status of safety input terminal.

0: OFF, 1: ON

Combined Safety Input Status CIS: This flag indicates the status of the safety input terminals.

0: An error has occurred on one of the safety input terminals.

1: All of the safety input terminals are normal (no errors).

- **Input Data (Assembly 556 - 22C Hex), Size: 3 byte(s)**

	Byte Offset	Bit 15	Bit 14	Bit 13	Bit 12	Bit 11	Bit 10	Bit 9	Bit 8	Bit 7	Bit 6	Bit 5	Bit 4	Bit 3	Bit 2	Bit 1	Bit 0
Safety Inputs + Safety Input Status	00	Safety Input Status I ₃	Safety Input Status I ₂	Safety Input Status I ₁	Safety Input Status I ₀	Safety Input I ₁₁	Safety Input I ₁₀	Safety Input I ₉	Safety Input I ₈	Safety Input I ₇	Safety Input I ₆	Safety Input I ₅	Safety Input I ₄	Safety Input I ₃	Safety Input I ₂	Safety Input I ₁	Safety Input I ₀
	02										Safety Input Status I ₁₁	Safety Input Status I ₁₀	Safety Input Status I ₉	Safety Input Status I ₈	Safety Input Status I ₇	Safety Input Status I ₆	Safety Input Status I ₅

n/u : Not used

Safety Input Ix: Gives the status of safety input terminal.

0: OFF, 1: ON

Safety Input Status Ix: This flag indicates the status of the safety input terminals.

0: Error, 1: No error

● **Input Data (Assembly 579 - 243 Hex), Size: 1 byte(s)**

	Byte Offset	Bit 15	Bit 14	Bit 13	Bit 12	Bit 11	Bit 10	Bit 9	Bit 8	Bit 7	Bit 6	Bit 5	Bit 4	Bit 3	Bit 2	Bit 1	Bit 0		
Safety Output Status	00											n/u	n/u	n/u	n/u	Safety Output Status O ₃	Safety Output Status O ₂	Safety Output Status O ₁	Safety Output Status O ₀

n/u : Not used

Safety Output Status Ox *1: This flag indicates the status of the safety output terminals.

0: Error, 1: No error

*1. It is not used for GI-SID1224.

● **Input Data (Assembly 604 - 25C Hex), Size: 2 byte(s)**

	Byte Offset	Bit 15	Bit 14	Bit 13	Bit 12	Bit 11	Bit 10	Bit 9	Bit 8	Bit 7	Bit 6	Bit 5	Bit 4	Bit 3	Bit 2	Bit 1	Bit 0
Safety Inputs + Combined Safety Input Status + Combined Safety Output Status	00	Global Safety Input Status CIS	Global Safety Output Status COS	n/u	n/u	Safety Input I ₁₁	Safety Input I ₁₀	Safety Input I ₉	Safety Input I ₈	Safety Input I ₇	Safety Input I ₆	Safety Input I ₅	Safety Input I ₄	Safety Input I ₃	Safety Input I ₂	Safety Input I ₁	Safety Input I ₀

n/u : Not used

Safety Input Ix: Gives the status of safety input terminal.

0: OFF, 1: ON

Combined Safety Input Status CIS: This flag indicates the status of the safety input terminals.

0: An error has occurred on one of the safety input terminals.

1: All of the safety input terminals are normal (no errors).

Combined Safety Output Status COS *1: This flag indicates the status of the safety output terminals.

0: An error has occurred on one of the safety output terminals.

1: All of the safety output terminals are normal (no errors).

*1. It is not used for GI-SID1224.

● **Input Data (Assembly 636 - 27C Hex), Size: 3 byte(s)**

	Byte Offset	Bit 15	Bit 14	Bit 13	Bit 12	Bit 11	Bit 10	Bit 9	Bit 8	Bit 7	Bit 6	Bit 5	Bit 4	Bit 3	Bit 2	Bit 1	Bit 0		
Safety Inputs + Combined Safety Input Status	00	Global Safety Input Status CIS	n/u	n/u	n/u	Safety Input I ₁₁	Safety Input I ₁₀	Safety Input I ₉	Safety Input I ₈	Safety Input I ₇	Safety Input I ₆	Safety Input I ₅	Safety Input I ₄	Safety Input I ₃	Safety Input I ₂	Safety Input I ₁	Safety Input I ₀		
Safety Output Status	02											n/u	n/u	n/u	n/u	Safety Output Status O ₃	Safety Output Status O ₂	Safety Output Status O ₁	Safety Output Status O ₀

n/u : Not used

Safety Input Ix: Gives the status of safety input terminal.

0: OFF, 1: ON

Combined Safety Input Status CIS: This flag indicates the status of the safety input terminals.

0: An error has occurred on one of the safety input terminals.

1: All of the safety input terminals are normal (no errors).

Safety Output Status Ox *1: This flag indicates the status of the safety output terminals.

0: Error, 1: No error

*1. It is not used for GI-SID1224.

Vendor Specific

● Input Data (Assembly 768 - 300 Hex), Size: 13 byte(s)

	Byte Offset	Bit 15	Bit 14	Bit 13	Bit 12	Bit 11	Bit 10	Bit 9	Bit 8	Bit 7	Bit 6	Bit 5	Bit 4	Bit 3	Bit 2	Bit 1	Bit 0	
Safety Inputs	00	n/u	n/u	n/u	n/u	Safety Input I ₁₁	Safety Input I ₁₀	Safety Input I ₉	Safety Input I ₈	Safety Input I ₇	Safety Input I ₆	Safety Input I ₅	Safety Input I ₄	Safety Input I ₃	Safety Input I ₂	Safety Input I ₁	Safety Input I ₀	
Safety Input Status	02	n/u	n/u	n/u	n/u	Safety Input Status I ₁₁	Safety Input Status I ₁₀	Safety Input Status I ₉	Safety Input Status I ₈	Safety Input Status I ₇	Safety Input Status I ₆	Safety Input Status I ₅	Safety Input Status I ₄	Safety Input Status I ₃	Safety Input Status I ₂	Safety Input Status I ₁	Safety Input Status I ₀	
Test Output Value	04	n/u	n/u	n/u	n/u	Test Output TO ₁₁	Test Output TO ₁₀	Test Output TO ₉	Test Output TO ₈	Test Output TO ₇	Test Output TO ₆	Test Output TO ₅	Test Output TO ₄	Test Output TO ₃	Test Output TO ₂	Test Output TO ₁	Test Output TO ₀	
Test Output Status	06	n/u	n/u	n/u	n/u	Test Output Status TOS ₁₁	Test Output Status TOS ₁₀	Test Output Status TOS ₉	Test Output Status TOS ₈	Test Output Status TOS ₇	Test Output Status TOS ₆	Test Output Status TOS ₅	Test Output Status TOS ₄	Test Output Status TOS ₃	Test Output Status TOS ₂	Test Output Status TOS ₁	Test Output Status TOS ₀	
Safety Output Monitoring	08	n/u	n/u	n/u	n/u	n/u	n/u	n/u	n/u	n/u	n/u	n/u	n/u	Safety Output Monitoring O ₃	Safety Output Monitoring O ₂	Safety Output Monitoring O ₁	Safety Output Monitoring O ₀	
Safety Output Status	10	n/u	n/u	n/u	n/u	n/u	n/u	n/u	n/u	n/u	n/u	n/u	n/u	Safety Output Status O ₃	Safety Output Status O ₂	Safety Output Status O ₁	Safety Output Status O ₀	
Miscellaneous	12										Input Over Current Error UB	Output Over Current Error UL	Muting Lamp Status TO ₇	Muting Lamp Status TO ₃	Global Safety Input Status CIS	Global Safety Output Status COS	Input Power Error UB	Output Power Error UL

n/u : Not used

Safety Input Ix: Gives the status of safety input terminal.

0: OFF, 1: ON

Test Output TOx: Gives the status of test output terminal.

0: OFF, 1: ON

Safety Output Monitoring O^{*1}: Monitors the status of safety output terminal.

0: OFF, 1: ON

Safety Input Status Ix: This flag indicates the status of the safety input terminals.

0: Error, 1: No error

Test Output Status TOSx: This flag indicates the status of the test output terminals.

0: Error, 1: No error

Safety Output Status O^{*1}: This flag indicates the status of the safety output terminals.

0: Error, 1: No error

Combined Safety Input Status CIS: This flag indicates the status of the safety input terminals.

0: An error has occurred on one of the safety input terminals.

1: All of the safety input terminals are normal (no errors).

Combined Safety Output Status COS^{*1}: This flag indicates the status of the safety output terminals.

0: An error has occurred on one of the safety output terminals.

1: All of the safety output terminals are normal (no errors).

Muting Lamp Status TOx: This flag indicates the status of the muting lamp output terminals. (Only T3 and T7 are available for the purpose.)

- 0: The muting lamp is faulty or the wiring is disconnected.
- 1: No error

Output Power Error UL *1: The voltage of output power supply (V1) is being diagnosed.

- 0: The power supply voltage is abnormal or the power supply is OFF.
- 1: The power supply voltage is normal.

Input Power Error UL: The voltage of unit power supply (V0) is being diagnosed.

- 0: The power supply voltage is abnormal or the power supply is OFF.
- 1: The power supply voltage is normal.

Output Over Current Error UL *1: The current of output power supply (V1) is being diagnosed.

- 0: An overcurrent has occurred.
- 1: No error

Input Over Current Error UB: The current of unit power supply (V0) is being diagnosed.

- 0: An overcurrent has occurred.
- 1: No error

*1. It is not used for GI-SID1224.



Additional Information

For safety input terminals not to be used, the status showing value and the status showing flag are "0" and "1" respectively.

A-2-2 Safety Output Assembly

Safety Discrete Output Profile

- **Output Data (Assembly 563 - 233 Hex), Size: 1 byte(s) *1**

	Byte Offset	Bit 15	Bit 14	Bit 13	Bit 12	Bit 11	Bit 10	Bit 9	Bit 8	Bit 7	Bit 6	Bit 5	Bit 4	Bit 3	Bit 2	Bit 1	Bit 0
Safety Outputs	00									n/u	n/u	n/u	n/u	Safety Output O ₃	Safety Output O ₂	Safety Output O ₁	Safety Output O ₀

n/u : Not used

Safety Output Ox: Gives the status of safety output terminal.

0: OFF, 1: ON

*1. It is not used for GI-SID1224.

Vendor Specific

- **Output Data (Assembly 769 - 301 Hex), Size: 4 byte(s)**

	Byte Offset	Bit 15	Bit 14	Bit 13	Bit 12	Bit 11	Bit 10	Bit 9	Bit 8	Bit 7	Bit 6	Bit 5	Bit 4	Bit 3	Bit 2	Bit 1	Bit 0
Safety Outputs	00	n/u	n/u	n/u	n/u	n/u	n/u	n/u	n/u	n/u	n/u	n/u	n/u	Safety Output I ₃	Safety Output I ₂	Safety Output I ₁	Safety Output I ₀
Test Outputs	02	n/u	n/u	n/u	n/u	Test Output TO ₁₁	Test Output TO ₁₀	Test Output TO ₉	Test Output TO ₈	Test Output TO ₇	Test Output TO ₆	Test Output TO ₅	Test Output TO ₄	Test Output TO ₃	Test Output TO ₂	Test Output TO ₁	Test Output TO ₀

n/u : Not used

Safety Output Ox *1: Gives the status of safety output terminal.

0: OFF, 1: ON

Test Output TOx: Gives the status of test output terminal.

0: OFF, 1: ON

*1. It is not used for GI-SID1224.



Additional Information

The status of the safety input terminals not to be used will be ignored.

And the status of the test output terminals not configured as Standard will also be ignored.

A-2-3 Configuration Data



Additional Information

The data size can be set to "0" if the EtherNet/IP CIP Safety originator device does not need to send configuration data at the establishment of the connection (Safety Forward Open Request).
 The configuration data in the below table is described only for the purpose of providing information.
 The configuration data are managed and sent by Sysmac Studio.

Vendor Specific

● Configuration (Assembly 770 - 302 Hex), Size: 123 bytes

	Byte Offset	Bit 15	Bit 14	Bit 13	Bit 12	Bit 11	Bit 10	Bit 9	Bit 8	Bit 7	Bit 6	Bit 5	Bit 4	Bit 3	Bit 2	Bit 1	Bit 0	
Version	00	Minor Version						Minor Version										
Test Output Mode	02	Test Output O ₁						Test Output O ₀										
	04	Test Output O ₃						Test Output O ₂										
	06	Test Output O ₅						Test Output O ₄										
	08	Test Output O ₇						Test Output O ₆										
	10	Test Output O ₉						Test Output O ₈										
	12	Test Output O ₁₁						Test Output O ₁₀										
Output Error Latch Time	14	Output Error Latch Time																
Output Mode & Pulse test Length	16	Pulse test Length O ₀						Output Mode O ₀										
	18	Pulse test Length O ₁						Output Mode O ₁										
	20	Pulse test Length O ₂						Output Mode O ₂										
	22	Pulse test Length O ₃						Output Mode O ₃										
Dual Safe Output Mode	24	Dual Output Mode O ₃ / O ₂						Dual Output Mode O ₀ / O ₁										
Input Error Latch Time	26	Input Error Latch Time																
Parameters . Input I ₀	28	OFF → ON Delay Input I ₀																
	30	ON → OFF Delay Input I ₀																
	32	Test Source Input I ₀						Input Mode I ₀										
Parameters . Input I ₁	34	OFF → ON Delay Input I ₁																
	36	ON → OFF Delay Input I ₁																
	38	Test Source Input I ₁						Input Mode I ₁										
Parameters . Input I ₂	40	OFF → ON Delay Input I ₂																
	42	ON → OFF Delay Input I ₂																
	44	Test Source Input I ₂						Input Mode I ₂										
Parameters . Input I ₃	46	OFF → ON Delay Input I ₃																
	48	ON → OFF Delay Input I ₃																
	50	Test Source Input I ₃						Input Mode I ₃										
Parameters . Input I ₄	52	OFF → ON Delay Input I ₄																
	54	ON → OFF Delay Input I ₄																
	56	Test Source Input I ₄						Input Mode I ₄										

	Byte Offset	Bit 15	Bit 14	Bit 13	Bit 12	Bit 11	Bit 10	Bit 9	Bit 8	Bit 7	Bit 6	Bit 5	Bit 4	Bit 3	Bit 2	Bit 1	Bit 0
Parameters . Input I ₅	58	OFF → ON Delay Input I ₅															
	60	ON → OFF Delay Input I ₅															
	62	Test Source Input I ₅								Input Mode I ₅							
Parameters . Input I ₆	64	OFF → ON Delay Input I ₆															
	66	ON → OFF Delay Input I ₆															
	68	Test Source Input I ₆								Input Mode I ₆							
Parameters . Input I ₇	70	OFF → ON Delay Input I ₇															
	72	ON → OFF Delay Input I ₇															
	74	Test Source Input I ₇								Input Mode I ₇							
Parameters . Input I ₈	76	OFF → ON Delay Input I ₈															
	78	ON → OFF Delay Input I ₈															
	80	Test Source Input I ₈								Input Mode I ₈							
Parameters . Input I ₉	82	OFF → ON Delay Input I ₉															
	84	ON → OFF Delay Input I ₉															
	86	Test Source Input I ₉								Input Mode I ₉							
Parameters . Input I ₁₀	88	OFF → ON Delay Input I ₁₀															
	90	ON → OFF Delay Input I ₁₀															
	92	Test Source Input I ₁₀								Input Mode I ₁₀							
Parameters . Input I ₁₁	94	OFF → ON Delay Input I ₁₁															
	96	ON → OFF Delay Input I ₁₁															
	98	Test Source Input I ₁₁								Input Mode I ₁₁							
Dual Safe Mode	100	n/u								Dual Safe Input Mode I ₁ / I ₀							
Dual Safe Discrepancy Time	102	Discrepancy Operation Input I ₁ / I ₀															
Dual Safe Mode	104	n/u								Dual Safe Input Mode I ₃ / I ₂							
Dual Safe Discrepancy Time	106	Discrepancy Operation Input I ₃ / I ₂															
Dual Safe Mode	108	n/u								Dual Safe Input Mode I ₅ / I ₄							
Dual Safe Discrepancy Time	110	Discrepancy Operation Input I ₅ / I ₄															
Dual Safe Mode	112	n/u								Dual Safe Input Mode I ₇ / I ₆							
Dual Safe Discrepancy Time	114	Discrepancy Operation Input I ₇ / I ₆															
Dual Safe Mode	116	n/u								Dual Safe Input Mode I ₉ / I ₈							
Dual Safe Discrepancy Time	118	Discrepancy Operation Input I ₉ / I ₈															
Dual Safe Mode	120	n/u								Dual Safe Input Mode I ₁₁ / I ₁₀							
Dual Safe Discrepancy Time	122	Discrepancy Operation Input I ₁₁ / I ₁₀															

Major Version: 1

Minor Version: 1

Test Output Mode

0: Not Used

1: Standard

2: Pulse Test

3: Power Supply

4: Muting lamp (Only T3 and T7 are available for the purpose.)

Output Error Latch Time (in ms) *1

Any value from 0 to 65530 (in increments of 10)

Output Mode *1

- 0: Not Used
- 1: Without pulse test
- 2: With pulse test

Output Pulse test Length (in ms) *1

Any value from 3 to 100

Dual Safe Output Ox/Ox+1 Mode *1

- 0: Single channel
- 1: Dual channel

Input Error Latch Time (in ms)

Any value from 0 to 65530 (in increments of 10)

Input Ix Off -> On Delay (in ms)

Any value from 0 to 1000

Input Ix On -> Off Delay (in ms)

Any value from 0 to 1000

Input Ix Mode

- 0: Not Used
- 1: With test pulse diagnosis
- 2: Without test pulse diagnosis
- 3: General-purpose device input

Input Ix Test Source

- 0: Not Used
- 1: Test Output 0
- 2: Test Output 1
- 3: Test Output 2
- 4: Test Output 3
- 5: Test Output 4
- 6: Test Output 5
- 7: Test Output 6
- 8: Test Output 7
- 9: Test Output 8
- 10: Test Output 9
- 11: Test Output 10
- 12: Test Output 11

Input Ix/Ix+1 Dual Safe Mode

- 0: Single channel
- 1: Dual-channel equivalent input
- 2: Dual-channel complementary input

Dual Safe Input Ix / Ix+1 Discrepancy Time (in ms)

Any value from 10 to 30000

*1. It is not used for GI-SID1224.

A-3 EtherNet/IP Object Classes

The object classes of EtherNet/IP are as follows.

A-3-1 Identity (0x01)

This object allows reading the identity of the module.

● Class Attributes

Id	Description	Get	Set	Limits
01h	Revision	●	○	1
02h	Max Instance	●	○	1
03h	Number of instances	●	○	1

●Supported ○Not supported

● Class Services

Id	Service	Param. Options
01h	Get_Attributes_All	
0Eh	Get_Attribute_Single	

● Instance Attributes

Id	Description	Get	Set	Limits
01h	Vendor Id	●	○	8
02h	Device Type	●	○	12
03h	Product Code	●	○	Depends on the product
04h	Revision	●	○	Depends on the revision
05h	Status	●	○	
06h	Serial Number	●	○	
07h	Product Name	●	○	Depends on the product

●Supported ○Not supported

● Instance Services

Id	Service	Param. Options
01h	Get_Attributes_All	
05h	Reset	
0Eh	Get_Attribute_Single	

A-3-2 Message Router (0x02)

● **Class Attributes**

Id	Description	Get	Set	Limits
1	Revision	○	○	
4	Optional Attribute List	○	○	
5	Optional Service List	○	○	
6	Max ID of class attributes	○	○	
7	Max ID of instance attributes	○	○	

●Supported ○Not supported

● **Class Services**

Service	Param. Options
Get_Attributes_All	○
Get_Attribute_Single	○

●Supported ○Not supported

● **Instance Attributes**

Id	Description	Get	Set	Limits
1	Object List	○	○	
2	Maximum connections supported	○	○	
3	Number of active connections	○	○	
4	Active connections list	○	○	

●Supported ○Not supported

● **Instance Services**

Service	Param. Options
Get_Attributes_All	○
Get_Attribute_Single	○

●Supported ○Not supported

A-3-3 Assembly (0x04)

This object allows to access I/O process data.

● **Class Attributes**

Id	Description	Get	Set	Limits
01h	Revision	●	○	2
02h	Max Instance	●	○	199
03h	Number of instances	●	○	4

●Supported ○Not supported

● **Class Services**

Service	Param. Options
Get_Attributes_All	•

●Supported ○Not supported

● **Instance Attributes**

Id	Description	Get	Set	Limits
03h	Data	•	•	Set command is not allowed if an exclusive owner connection is open

●Supported ○Not supported

● **Instance Services**

Id	Service	Param. Options
0Eh	Get_Attributes_Single	
10h	Set_Attribute_Single	

A-3-4 Connection Manager (0x06)

● **Class Attributes**

Id	Description	Get	Set	Limits
01h	Revision	•	○	1
02h	Max Instance	•	○	1
03h	Number of instances	•	○	1

●Supported ○Not supported

● **Class Services**

Id	Service	Param. Options
01h	Get_Attributes_All	
0Eh	Get_Attribute_Single	

● **Instance Attributes**

Id	Description	Get	Set	Limits
01h	Open Requests	•	○	
02h	Open Format Rejects	•	○	
03h	Open Resource Rejects	•	○	
04h	Open Other Rejects	•	○	
05h	Close Requests	•	○	
06h	Close Format Requests	•	○	
07h	Close Other Requests	•	○	
08h	Connection Time-outs	•	○	

●Supported ○Not supported

● Instance Services

Id	Service	Param. Options
01h	Get_Attributes_All	
0Eh	Get_Attribute_Single	
4Eh	Forward_Close	
54h	Forward_Open	
5Bh	Large_Forward_Open	Class 3 only

A-3-5 TCP/IP Interface (0xF5)

● Class Attributes

Id	Description	Get	Set	Limits
01h	Revision	●	○	2
02h	Max Instance	●	○	1
03h	Number of instances	●	○	1

●Supported ○Not supported

● Class Services

Id	Service	Param. Options
01h	Get_Attributes_All	
0Eh	Get_Attribute_Single	

● Instance Attributes

Id	Description	Get	Set	Limits
1	Status	●	○	
2	Configuration Capability	●	○	
3	Configuration Control	●	●	
4	Physical Link	●	○	
5	Interface Configuration	●	●	
6	Host Name	●	●	
7	Safety Network Number	●	●	
8	TTL Value	○	○	
9	Mcast Config	○	○	
10	Select ACD	●	●	
11	LastConflictDetected	●	●	
12	EtherNet/IP Quick_Connect	●	●	

●Supported ○Not supported

● Instance Services

Id	Service	Param. Options
01h	Get_Attributes_All	
0Eh	Get_Attribute_Single	
10h	Set_Attribute_Single	

A-3-6 Ethernet Link (0xF6)

● Class Attributes

Id	Description	Get	Set	Limits
01h	Revision	●	○	3
02h	Max Instance	●	○	3
03h	Number of instances	●	○	3

●Supported ○Not supported

● Class Services

Id	Service	Param. Options
0Eh	Get_Attributes_All	
0Eh	Get_Attribute_Single	

● Instance Attributes

Id	Description	Get	Set	Limits
01h	Interface Speed	●	○	
02h	Interface Flags	●	○	
03h	Physical Address	●	○	
04h	Interface Counters	●	○	
05h	Media Counters	●	○	
06h	Interface Control	●	●	
07h	Interface Type	○	○	
08h	Interface State	○	○	
09h	Admin State	○	●	
10h	Interface Label	●	○	

●Supported ○Not supported

● Instance Services

Id	Service	Param. Options
01h	Get_Attributes_All	
0Eh	Get_Attribute_Single	
10h	Set_Attribute_Single	
4Ch	Get_and_Clear	

A-3-7 DLR (0x47)

● Class Attributes

Id	Description	Get	Set	Limits
01h	Revision	●	○	3
02h	Max Instance	●	○	1

●Supported ○Not supported

● Class Services

Id	Service	Param. Options
0Eh	Get_Attribute_Single	

● Instance Attributes

Id	Description	Get	Set	Limits
01h	Network Topology	●	○	0 indicates "Linear" 1 indicates "Ring"
02h	Network Status	●	○	0 indicates "Normal" 1 indicates "Ring Fault" 2 indicates "Unexpected Loop Detected" 3 indicates "Partial Network Fault" (not expected)
10h	Active Supervisor Address	●	○	IP and / or MAC address of the active ring supervisor
12h	Network Status	●	○	Value 0x02 Beacon-based Ring Node

●Supported ○Not supported

● Instance Services

Id	Service	Param. Options
01h	Get_Attributes_All	
0Eh	Get_Attribute_Single	

A-3-8 QoS (0x48)

● Class Attributes

Id	Description	Get	Set	Limits
01h	Revision	●	○	1
02h	Max Instance	●	○	1
03h	Number of instances	●	○	1

●Supported ○Not supported

● Class Services

Id	Service	Param. Options
0Eh	Get_Attributes_All	
0Eh	Get_Attribute_Single	

● Instance Attributes

Id	Description	Get	Set	Limits
04h	DSCP Urgent	●	●	
05h	DSCP Scheduled	●	●	
06h	DSCP High	●	●	
07h	DSCP Low	●	●	
08h	DSCP Explicit	●	●	

●Supported ○Not supported

● Instance Services

Id	Service	Param. Options
0Eh	Get_Attributes_Single	
10h	Set_Attribute_Single	

A-4 Application Examples

☐ Refer to *Safety Control Unit Instructions Reference Manual* (Cat. No. Z931) for details on the instructions that are used in each example.

A-4-1 Emergency Stop Pushbutton Switch

Application Overview

Safety category/PL	Safety device	Stop category	Reset
Equivalent to 4/PLe	Emergency stop pushbutton	0	Manual

Motor M stops when emergency stop pushbutton S1 is pressed.

Wiring

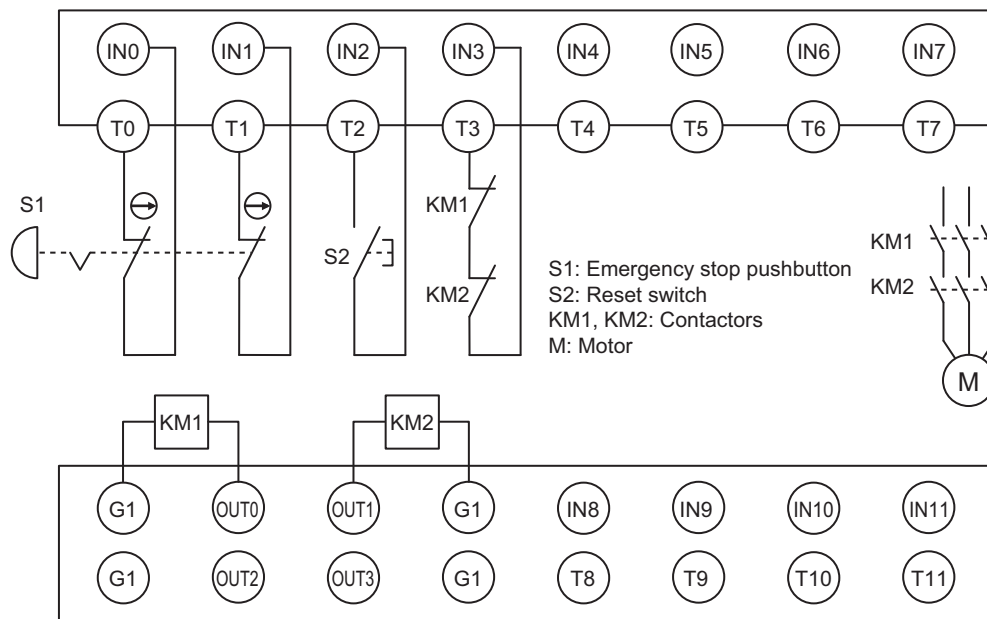

Timing Chart

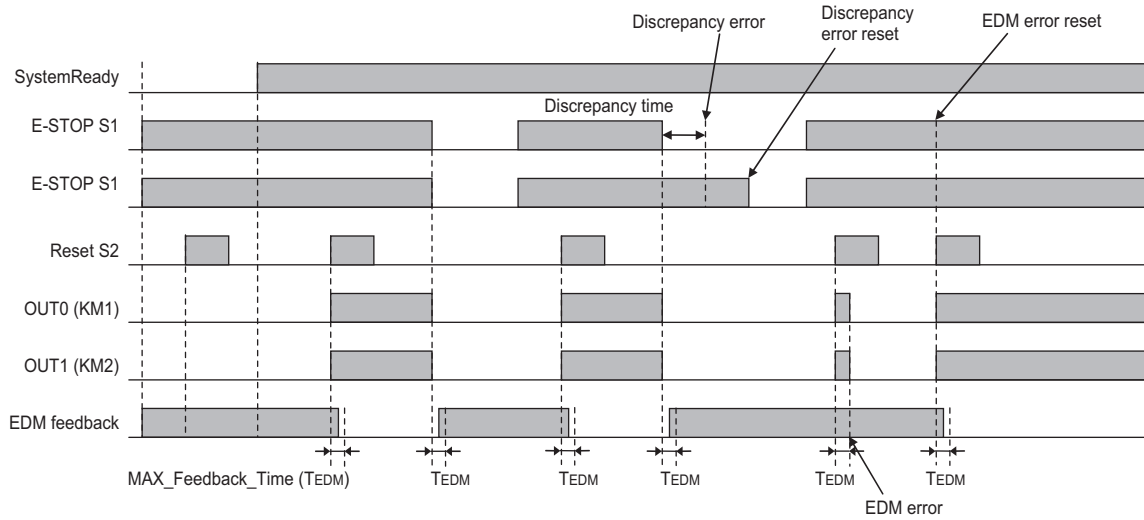

Safety I/O Terminal & I/O Map Setting

● Safety I/O Terminal Settings

GI-SMD1624 Safety Input (CIPOriginator_Instance0)

Device	Input/Test	Discrepancy	On-Off	Off-On	Test Output Mode	Comment
Emergency Stop Switch for Dual Channel Equivalent	IN0/T0	500ms	0ms	0ms	Test Output	Emergency Stop Pushbutton Switch (2NC)
-----	IN1/T1	500ms	0ms	0ms	Test Output	
Reset Switch with Test Pulse	IN2/T2	0ms	0ms	0ms	Test Output	Reset Switch
EDM Feedback	IN3/T3	0ms	0ms	0ms	Test Output	EDM (Contact Welding Detection)

GI-SMD1624 Safety Output (CIPOriginator_Instance1)

Device	Output	Test Pulse Width [$\times 100\mu\text{s}$]	Comment
Relays with Forcibly Guided Contacts for Dual Channel	OUT0	5	Safety Relay w/ Welding Check
-----	OUT1	5	Safety Relay w/ Welding Check

● I/O Map Settings

Position	Port	R/W	Data Type	Variable	Variable Comment	Variable Type
▼ CPU/Expansion Racks						
NXBusMaster	NX-CSG320					
▼ EtherNet/IP Port 1 (Originator)						
▼ EtherNet/IP Port 2 (Originator)						
192.168.250.2	GI-SMD1624					
▼ Safety Input						
▼ Safety Input Byte1						
	SI0	R	SAFEBOOL	EMO_NC_S1	Emergency Stop Pushbutton Switch(2NC)	Global Variables
	SI1	R	SAFEBOOL			
	SI2	R	SAFEBOOL	Reset_S2	Reset Switch	Global Variables
	SI3	R	SAFEBOOL	Feedback_KM1_KM2	EDM(Contact Welding Detection)	Global Variables
	SI4	R	SAFEBOOL			
	SI5	R	SAFEBOOL			
	SI6	R	SAFEBOOL			
	SI7	R	SAFEBOOL			
▼ Safety Input Byte2						
	SI8	R	SAFEBOOL			
	SI9	R	SAFEBOOL			
	SI10	R	SAFEBOOL			
	SI11	R	SAFEBOOL			
▼ Safety Output						
▼ Safety Output Byte1						
	SO0	W	SAFEBOOL	Contact_KM1	Safety Relay w/ Welding Check	Global Variables
	SO1	W	SAFEBOOL	Contact_KM2	Safety Relay w/ Welding Check	Global Variables
	SO2	W	SAFEBOOL			
	SO3	W	SAFEBOOL			

Programming Example

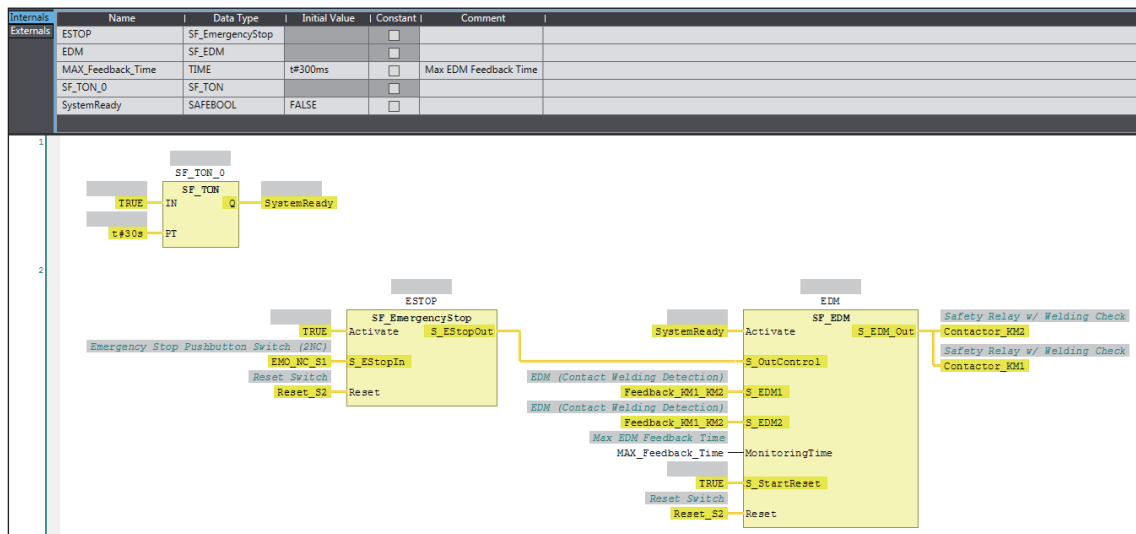

A-4-2 Safety Doors

Application Overview

Safety category/PL	Safety device	Stop category	Reset
Equivalent to 4/PLe (Safety Door)	Safety limit switches 1 and 2	0	Auto
	Emergency stop pushbutton	0	Manual

M1 stops when safety door 1 (S3, S4) is opened.
 M2 stops when safety door 2 (S5, S6) is opened.
 Both M1 and M2 stop when the emergency stop pushbutton S1 is pressed.

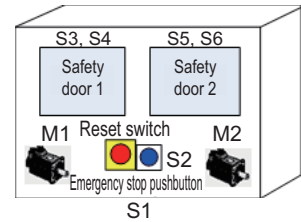

Wiring

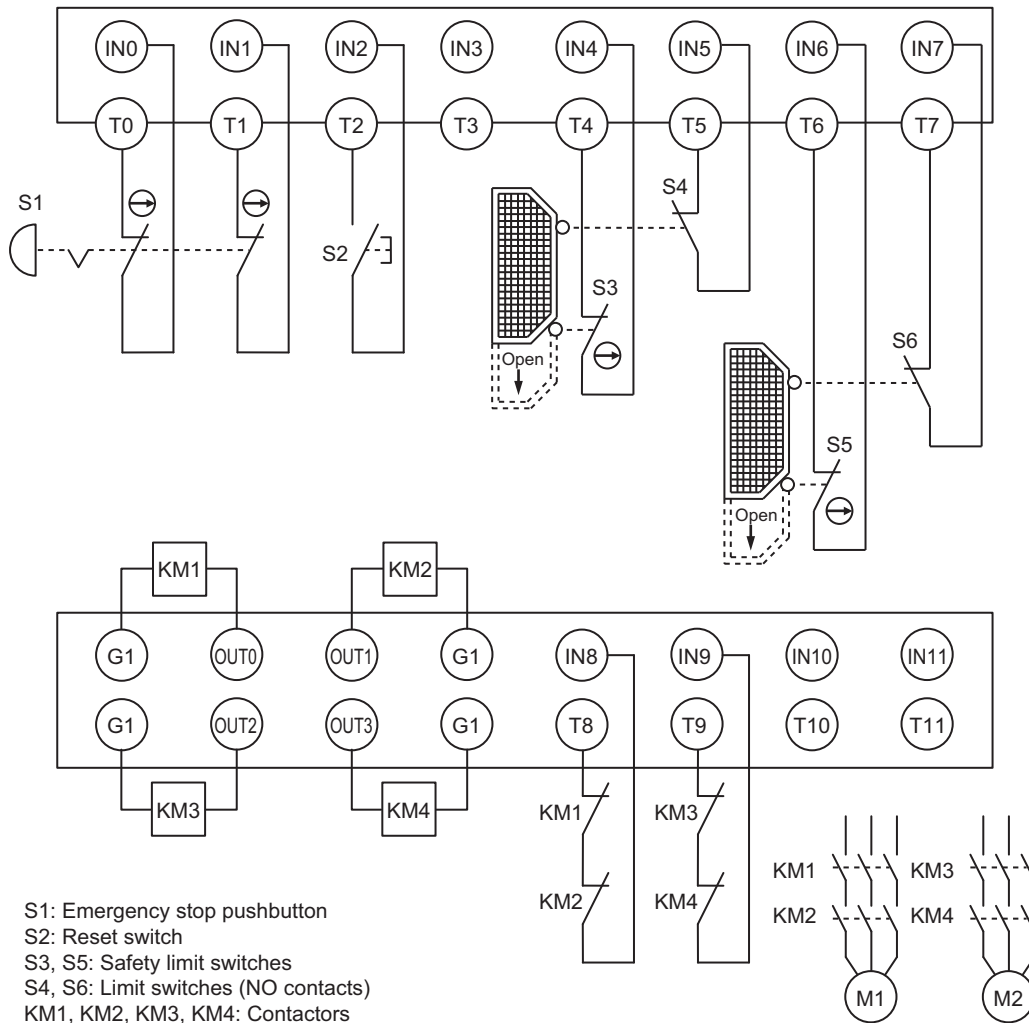

Timing Chart

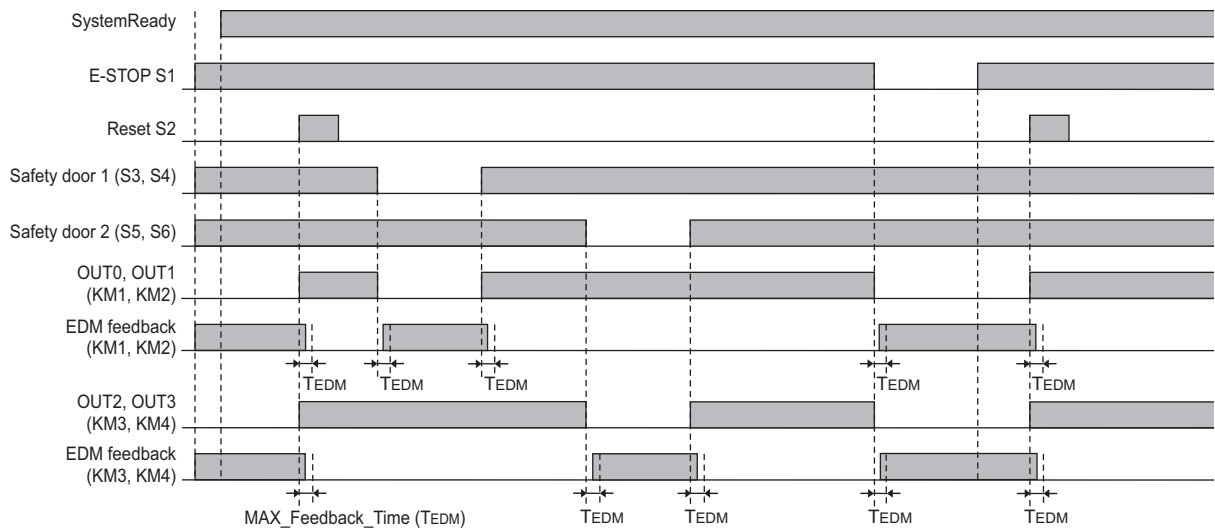

Safety I/O Terminal & I/O Map Setting

● Safety I/O Terminal Settings

GI-SMD1624 Safety Input (CIPOriginator_Instance0)

Device	Input/Test	Discrepancy	On-Off	Off-On	Test Output Mode	Comment
Emergency Stop Switch for Dual Channel Equivalent	IN0/T0	500ms	0ms	0ms	Test Output	Emergency Stop Pushbutton Switch (2NC)
-----	IN1/T1	500ms	0ms	0ms	Test Output	
Mechanical Contact for Single Channel	IN2/T2	0ms	0ms	0ms	Test Output	Reset Switch
	IN3/T3				Not Used	
Safety Limit Switch for Single Channel	IN4/T4	0ms	0ms	0ms	Test Output	Safety Limit Switch (NC)
Mechanical Contact for Single Channel	IN5/T5	0ms	0ms	0ms	Test Output	Limit Switch (NO)
Safety Limit Switch for Single Channel	IN6/T6	0ms	0ms	0ms	Test Output	Safety Limit Switch (NC)
Mechanical Contact for Single Channel	IN7/T7	0ms	0ms	0ms	Test Output	Limit Switch (NO)
EDM Feedback	IN8/T8	0ms	0ms	0ms	Test Output	EDM (Contact Welding Detection)
EDM Feedback	IN9/T9	0ms	0ms	0ms	Test Output	EDM (Contact Welding Detection)

GI-SMD1624 Safety Output (CIPOriginator_Instance1)

Device	Output	Test Pulse Width [$\times 100\mu\text{s}$]	Comment
Relays with Forcibly Guided Contacts for Dual Channel	OUT0	5	Safety Relay w/ Welding Check
-----	OUT1	5	Safety Relay w/ Welding Check
Relays with Forcibly Guided Contacts for Dual Channel	OUT2	5	Safety Relay w/ Welding Check
-----	OUT3	5	Safety Relay w/ Welding Check

● I/O Map Settings

Position	Port	R/W	Data Type	Variable	Variable Comment	Variable Type
NXBusMaster	▼ CPU/Expansion Racks					
	NX-CSG320					
192.168.250.2	▼ EtherNet/IP Port 1 (Originator)					
	▼ EtherNet/IP Port 2 (Originator)					
	▼ GI-SMD1624					
	▼ Safety Input					
	▼ Safety Input Byte1					
	SI0	R	SAFEBOOL	EMO_NC_S1	Emergency Stop Pushbutton Switch(2NC)	Global Variables
	SI1	R	SAFEBOOL			
	SI2	R	SAFEBOOL	Reset_S2	Reset Switch	Global Variables
	SI3	R	SAFEBOOL			
	SI4	R	SAFEBOOL	Safety_Limit_SW_NC_S3	Safety Limit Switch(NC)	Global Variables
	SI5	R	SAFEBOOL	Limit_SW_NO_S4	Limit Switch(NO)	Global Variables
	SI6	R	SAFEBOOL	Safety_Limit_SW_NC_S5	Safety Limit Switch(NC)	Global Variables
	SI7	R	SAFEBOOL	Limit_SW_NO_S6	Limit Switch(NO)	Global Variables
	▼ Safety Input Byte2					
	SI8	R	SAFEBOOL	Feedback_KM1_KM2	EDM(Contact Welding Detection)	Global Variables
	SI9	R	SAFEBOOL	Feedback_KM3_KM4	EDM(Contact Welding Detection)	Global Variables
	SI10	R	SAFEBOOL			
	SI11	R	SAFEBOOL			
	▼ Safety Output					
	▼ Safety Output Byte1					
SO0	W	SAFEBOOL	Contactor_KM1	Safety Relay w/ Welding Check	Global Variables	
SO1	W	SAFEBOOL	Contactor_KM2	Safety Relay w/ Welding Check	Global Variables	
SO2	W	SAFEBOOL	Contactor_KM3	Safety Relay w/ Welding Check	Global Variables	
SO3	W	SAFEBOOL	Contactor_KM4	Safety Relay w/ Welding Check	Global Variables	

Programming Example

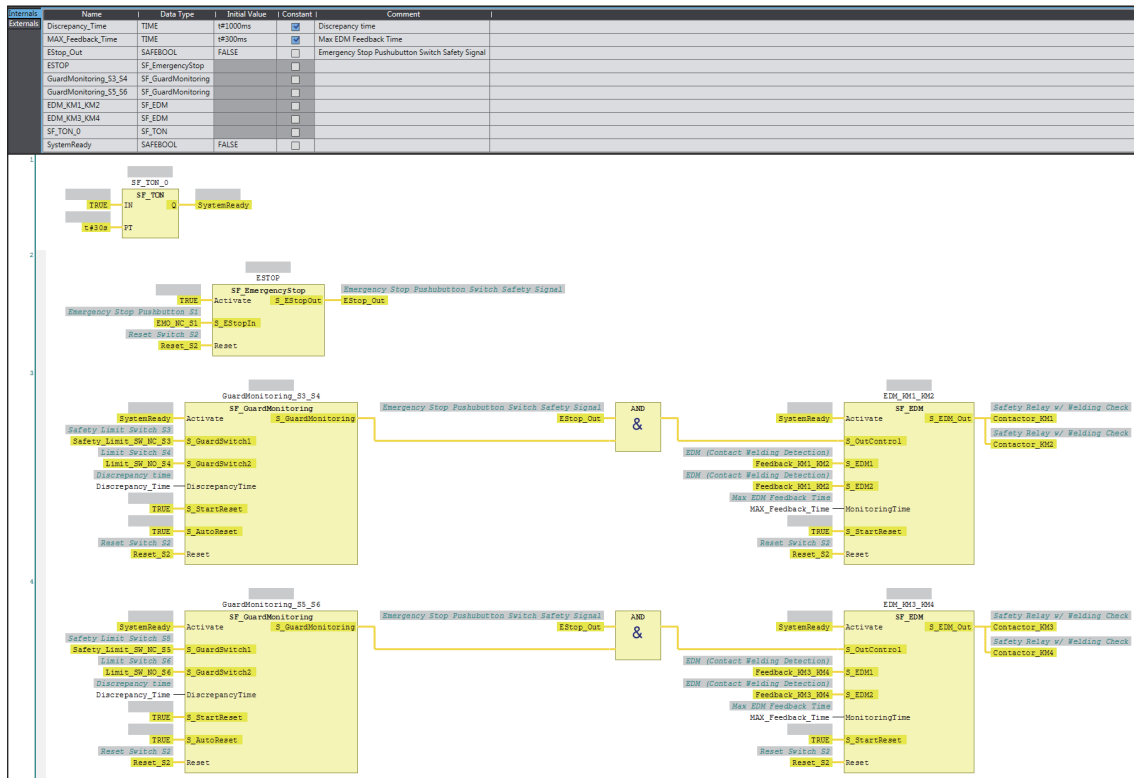

A-4-3 Safety Laser Scanners

Application Overview

Safety category/PL	Safety device	Stop category	Reset
Equivalent to 3/PLd (Laser Scanner)	Laser scanner	0	Auto
	Emergency stop pushbutton	0	Manual

AGV stops when emergency stop pushbutton S1 is pressed.

AGV stops when laser scanner S3 detects that persons or objects approach into the safety zone.

Wiring

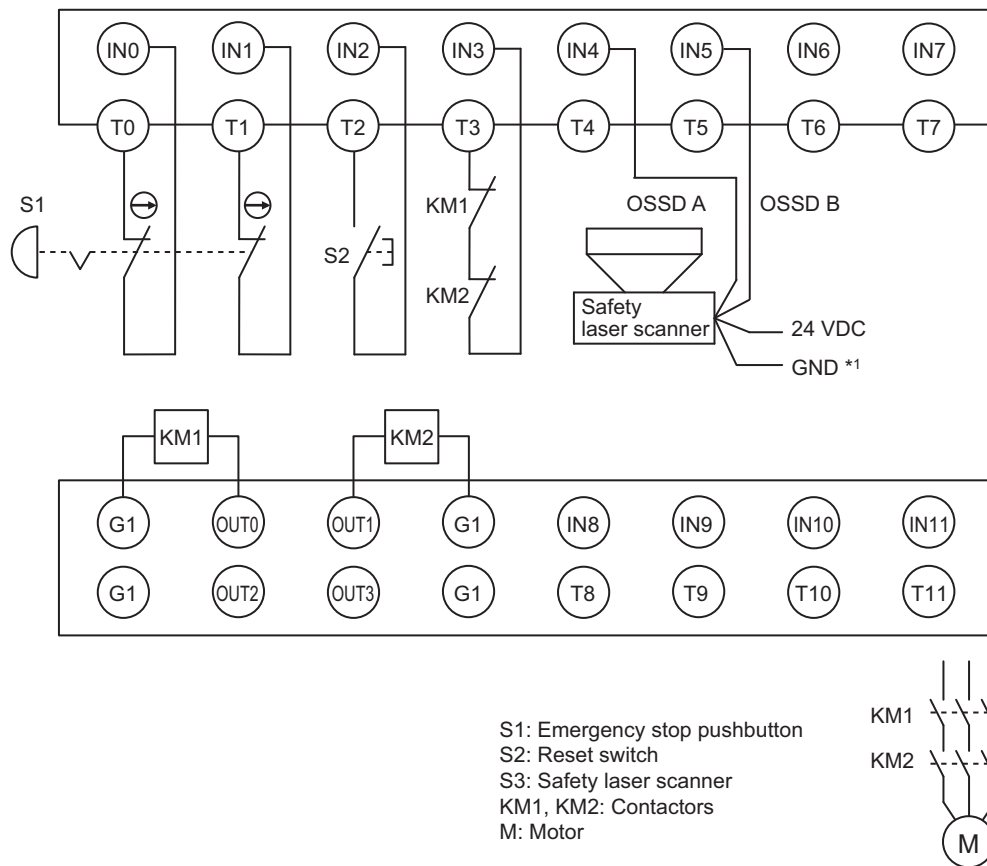

*1. GND of the safety laser scanner must be connected to the G0 terminal of the safety I/O terminal.

Timing Chart

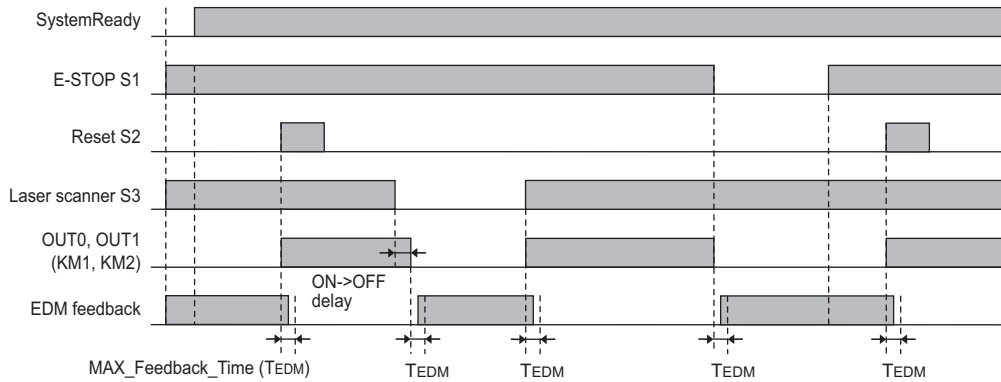

Safety I/O Terminal & I/O Map Setting

● Safety I/O Terminal Settings

GI-SMD1624 Safety Input (CIPOriginator_Instance0)

Device	Input/Test	Discrepancy	On-Off	Off-On	Test Output Mode	Comment
Emergency Stop Switch for Dual Channel Equivalent	IN0/T0	500ms	0ms	0ms	Test Output	Emergency Stop Pushbutton Switch (2NC)
-----	IN1/T1	500ms	0ms	0ms	Test Output	
Mechanical Contact for Single Channel	IN2/T2	0ms	0ms	0ms	Test Output	Reset Switch
EDM Feedback	IN3/T3	0ms	0ms	0ms	Test Output	EDM (Contact Welding Detection)
Safety Laser Scanner	IN4/T4	500ms	1ms *1	0ms	Power Supply	Dual Safety Semiconductor Output (Equivalent)
-----	IN5/T5	500ms	1ms *1	0ms	Power Supply	

GI-SMD1624 Safety Output (CIPOriginator_Instance1)

Device	Output	Test Pulse Width [$\times 100\mu\text{s}$]	Comment
Relays with Forcibly Guided Contacts for Dual Channel	OUT0	5	Safety Relay w/ Welding Check
-----	OUT1	5	Safety Relay w/ Welding Check

*1. Set the delay time to 1 ms because the OSSD output diagnosis pulse width of the safety laser scanner is 1 ms or less.

● I/O Map Settings

Position	Port	R/W	Data Type	Variable	Variable Comment	Variable Type
NXBusMaster	▼ CPU/Expansion Racks					
	NX-CSG320					
192.168.250.2	▼ EtherNet/IP Port 1 (Originator)					
	▼ EtherNet/IP Port 2 (Originator)					
	▼ GI-SMD1624					
	▼ Safety Input					
	▼ Safety Input Byte1					
	SI0	R	SAFEBOOL	EMO_NC_S1	Emergency Stop Pushbutton Switch(2NC)	Global Variables
	SI1	R	SAFEBOOL			
	SI2	R	SAFEBOOL	Reset_S2	Reset Switch	Global Variables
	SI3	R	SAFEBOOL	Feedback_KM1_KM2	EDM(Contact Welding Detection)	Global Variables
	SI4	R	SAFEBOOL	LaserScanner_S3	Dual Safety Semiconductor Output(Equivalent)	Global Variables
	SI5	R	SAFEBOOL			
	SI6	R	SAFEBOOL			
	SI7	R	SAFEBOOL			
	▼ Safety Input Byte2					
	SI8	R	SAFEBOOL			
	SI9	R	SAFEBOOL			
	SI10	R	SAFEBOOL			
	SI11	R	SAFEBOOL			
	▼ Safety Output					
	▼ Safety Output Byte1					
SO0	W	SAFEBOOL	Contact_KM1	Safety Relay w/ Welding Check	Global Variables	
SO1	W	SAFEBOOL	Contact_KM2	Safety Relay w/ Welding Check	Global Variables	
SO2	W	SAFEBOOL				
SO3	W	SAFEBOOL				

Programming Example

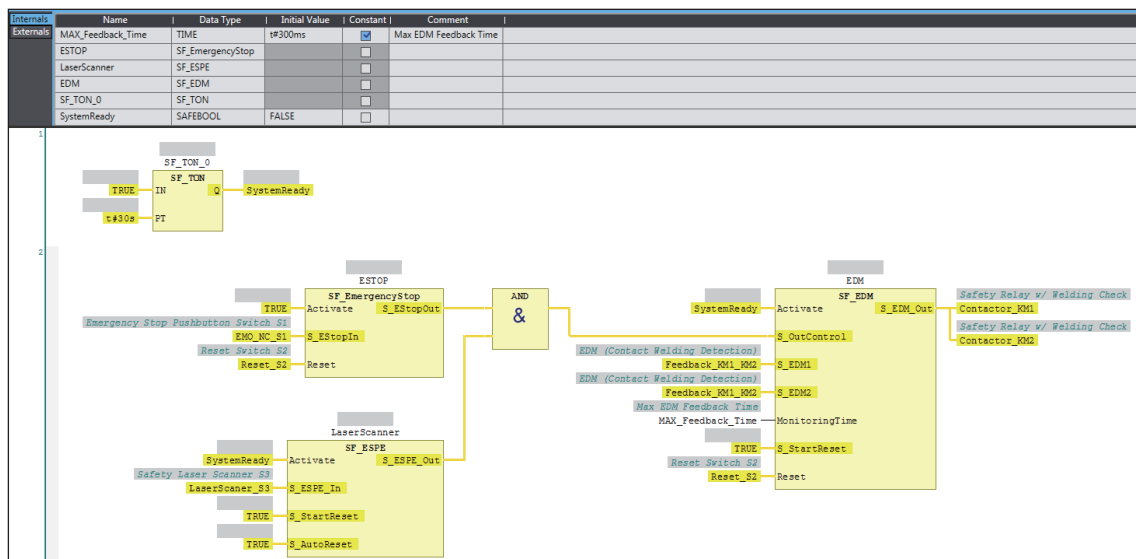

A-4 Application Examples

A

A-4-3 Safety Laser Scanners

A-4-4 Safety Door Switches with Magnetic Locks and Key Selector Switches

Application Overview

Safety category/PL	Safety device	Stop category	Reset
Equivalent to 4/PLe (Safety Door Switches with Magnetic Locks)	<ul style="list-style-type: none"> Emergency stop pushbutton Safety door switch with magnetic lock (mechanical lock type) Key selector switch 	0	Manual

Safety doors S4 and S5 cannot be opened while the user mode is set for normal operation. The outputs are turned OFF by changing to maintenance mode and the safety doors can be opened 5 seconds later. The outputs also turn OFF when emergency pushbutton S1 is pressed.

Wiring

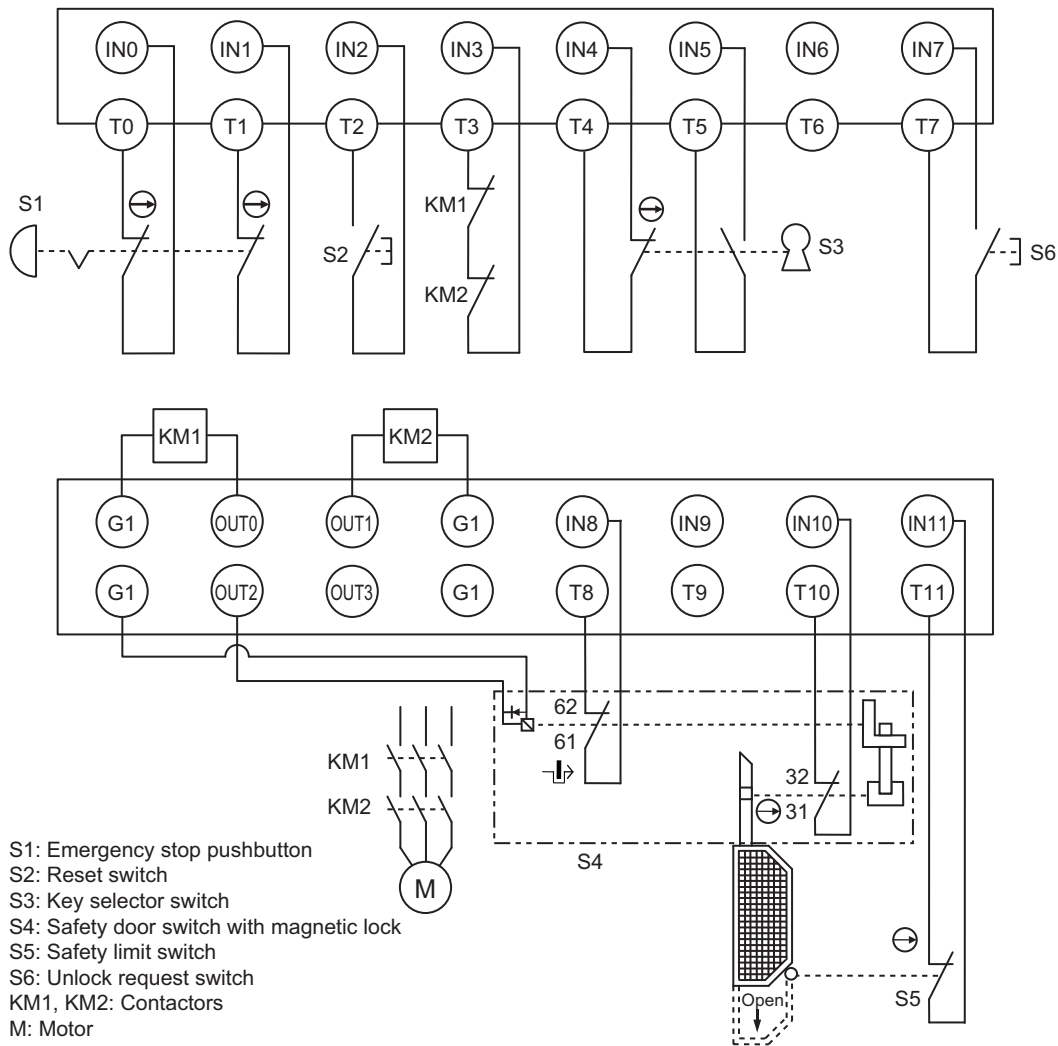

Timing Chart

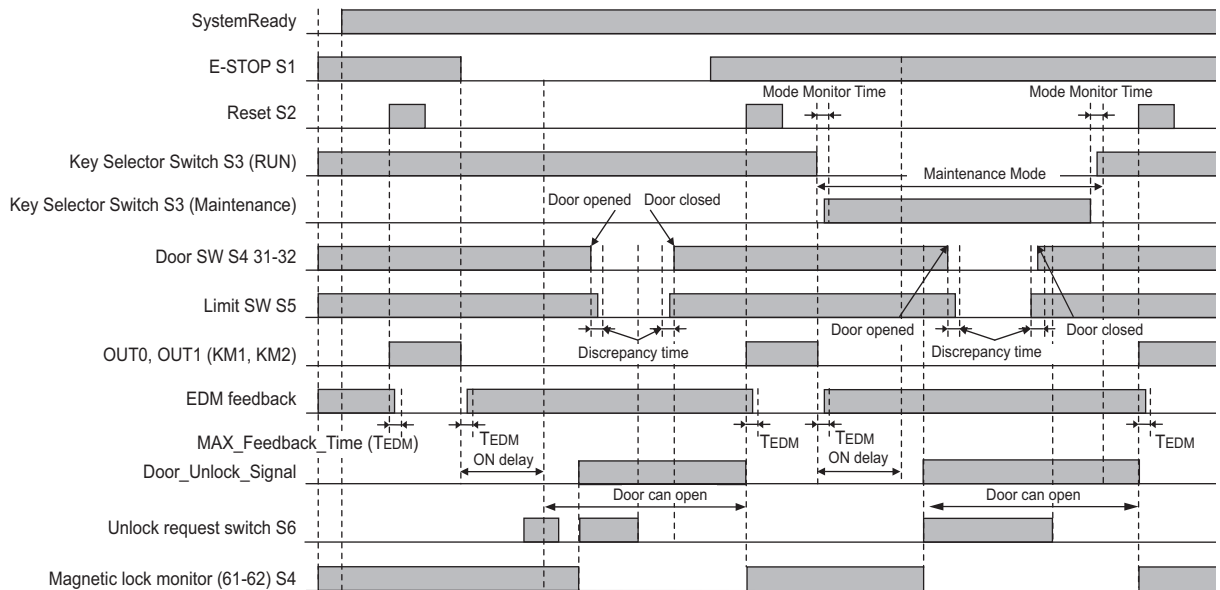

Safety I/O Terminal & I/O Map Setting

● Safety I/O Terminal Settings

GI-SMD1624 Safety Input (CIPOriginator_Instance0)

Device	Input/Test	Discrepancy	On-Off	Off-On	Test Output Mode	Comment
Emergency Stop Switch for Dual Channel Equivalent	IN0/T0	500ms	0ms	0ms	Test Output	Emergency Stop Pushbutton Switch (2NC)
-----	IN1/T1	500ms	0ms	0ms	Test Output	
Mechanical Contact for Single Channel	IN2/T2	0ms	0ms	0ms	Test Output	Reset Switch
EDM Feedback	IN3/T3	0ms	0ms	0ms	Test Output	EDM (Contact Welding Detection)
Safety Key Selector Switch for Dual Channel Complementary	IN4/T4	0ms	0ms	0ms	Test Output	Dual Contact
-----	IN5/T5	0ms	0ms	0ms	Test Output	
	IN6/T6				Not Used	
Mechanical Contact for Single Channel	IN7/T7	0ms	0ms	0ms	Test Output	Single Contact
Safety-door Switch for single Channel	IN8/T8	0ms	0ms	0ms	Test Output	Safety Switch (NC)
	IN9/T9				Not Used	
Safety-door Switch for single Channel	IN10/T10	0ms	0ms	0ms	Test Output	Safety Switch (NC)
Safety Limit Switch for Single Channel	IN11/T11	0ms	0ms	0ms	Test Output	Safety Limit Switch (NC)

GI-SMD1624 Safety Output (CIPOriginator_Instance1)

Device	Output	Test Pulse Width [$\times 100\mu\text{s}$]	Comment
Relays with Forcibly Guided Contacts for Dual Channel	OUT0	5	Safety Relay w/ Welding Check
-----	OUT1	5	Safety Relay w/ Welding Check
Single Channel with Test Pulse	OUT2	5	Door Unlock Signal

● I/O Map Settings

Position	Port	R/W	Data Type	Variable	Variable Comment	Variable Type
NXBusMaster	▼ CPU/Expansion Racks					
	NX-CSG320					
	EtherNet/IP Port 1 (Originator)					
	▼ EtherNet/IP Port 2 (Originator)					
192.168.250.2	▼ GI-SMD1624					
	▼ Safety Input					
	▼ Safety Input Byte1					
	SI0	R	SAFEBOOL	EMO_NC_S1	Emergency Stop Pushbutton Switch(2NC)	Global Variables
	SI1	R	SAFEBOOL			
	SI2	R	SAFEBOOL	Reset_S2	Reset Switch	Global Variables
	SI3	R	SAFEBOOL	Feedback_KM1_KM2	EDM(Contact Welding Detection)	Global Variables
	SI4	R	SAFEBOOL	Mode_SW_S3_RUN	Dual Contact	Global Variables
	SI5	R	SAFEBOOL	Mode_SW_S3_Maintenance		Global Variables
	SI6	R	SAFEBOOL			
	SI7	R	SAFEBOOL	Unlock_Request_SW_S6	Single Contact	Global Variables
	▼ Safety Input Byte2					
	SI8	R	SAFEBOOL	Lock_Monitor_S4	Safety Switch(NC)	Global Variables
	SI9	R	SAFEBOOL			
	SI10	R	SAFEBOOL	Door_SW_S4	Safety Switch(NC)	Global Variables
	SI11	R	SAFEBOOL	Safety_Limit_SW_S5	Safety Limit Switch(NC)	Global Variables
	▼ Safety Output					
▼ Safety Output Byte1						
SO0	W	SAFEBOOL	Contactora_KM1	Safety Relay w/ Welding Check	Global Variables	
SO1	W	SAFEBOOL	Contactora_KM2	Safety Relay w/ Welding Check	Global Variables	
SO2	W	SAFEBOOL	Door_Unlock_Signal	Door Unlock Signal	Global Variables	
SO3	W	SAFEBOOL				

Programming Example

Internal	Name	Data Type	Initial Value	Constant	Comment
	Mode_Monitor_Time	TIME	#P2s	<input checked="" type="checkbox"/>	Allowed Mode Transition Time
	MAX_Feedback_Time	TIME	#P300ms	<input checked="" type="checkbox"/>	Max EDM Feedback Time
	ON_Delay_Time	TIME	#P5s	<input checked="" type="checkbox"/>	ON Delay Time
	Discrepancy_Time	TIME	#P100ms	<input checked="" type="checkbox"/>	Discrepancy time
	RUN_Mode	SAFEBOOL	FALSE	<input type="checkbox"/>	RUN Mode
	Maintenance_Mode	SAFEBOOL	FALSE	<input type="checkbox"/>	Maintenance Mode
	SafeActive	SAFEBOOL	FALSE	<input type="checkbox"/>	Safety Status
	GuardLocked	SAFEBOOL	FALSE	<input type="checkbox"/>	Guard Safety Signal
	UnlockGuard	SAFEBOOL	FALSE	<input type="checkbox"/>	Guard Unlock Signal
	ESTOP	SF_EmergencyStop		<input type="checkbox"/>	
	GuardMonitoring	SF_GuardMonitoring		<input type="checkbox"/>	
	EDM	SF_EDM		<input type="checkbox"/>	
	ON_Delay	SF_TON		<input type="checkbox"/>	
	GuardLocking	SF_GuardLocking		<input type="checkbox"/>	
	UserModeSwitch	SF_ModeSelector		<input type="checkbox"/>	
	SF_TON_0	SF_TON		<input type="checkbox"/>	
	SystemReady	SAFEBOOL	FALSE	<input type="checkbox"/>	

The diagram illustrates the control logic for safety door switches with magnetic locks and key selector switches. It is organized into several functional blocks:

- SystemReady:** Activated by SF_TON_0 (TRUE) and deactivated by a 300ms timer (t300s).
- UserModeSwitch:** Manages transitions between RUN Mode, Maintenance Mode, and AutoSetMode based on SF_ModeSelector and various switches (S_Mode0, S_Mode1, S_Unlock).
- GuardMonitoring:** Monitors safety door switches (S_GuardSwitch1, S_GuardSwitch2) and discrepancy time. It activates SF_GuardMonitoring and SF_GuardLocked.
- GuardLocking:** Controls the magnetic lock (S_GuardLock) and provides Guard Unlock Signal and Guard Locked signals.
- ESTOP:** Emergency Stop function triggered by SF_EmergencyStop (TRUE) and S_EstopIn, leading to S_EstopOut.
- EDM:** EDM (Contact Welding Detection) function involving S_EDM1, S_EDM2, and monitoring time.
- AND &:** A logic block that combines Guard Safety Signal, Guard Locked, and RUN Mode signals.

A

A-4-5 Enable Switches

Application Overview

Safety category/PL	Safety device	Stop category	Reset
Equivalent to 4/PLe (Enable Switch)	<ul style="list-style-type: none"> Emergency stop pushbutton Safety limit switch Key selector switch Enable switch 	0	Manual

Motor M stops when safety doors S3 and S4 are opened or key Selector switch S5 is maintenance mode. However, even if key selector switch S5 is set to maintenance mode, motor M will operate if enable switch S6 is ON.

Wiring

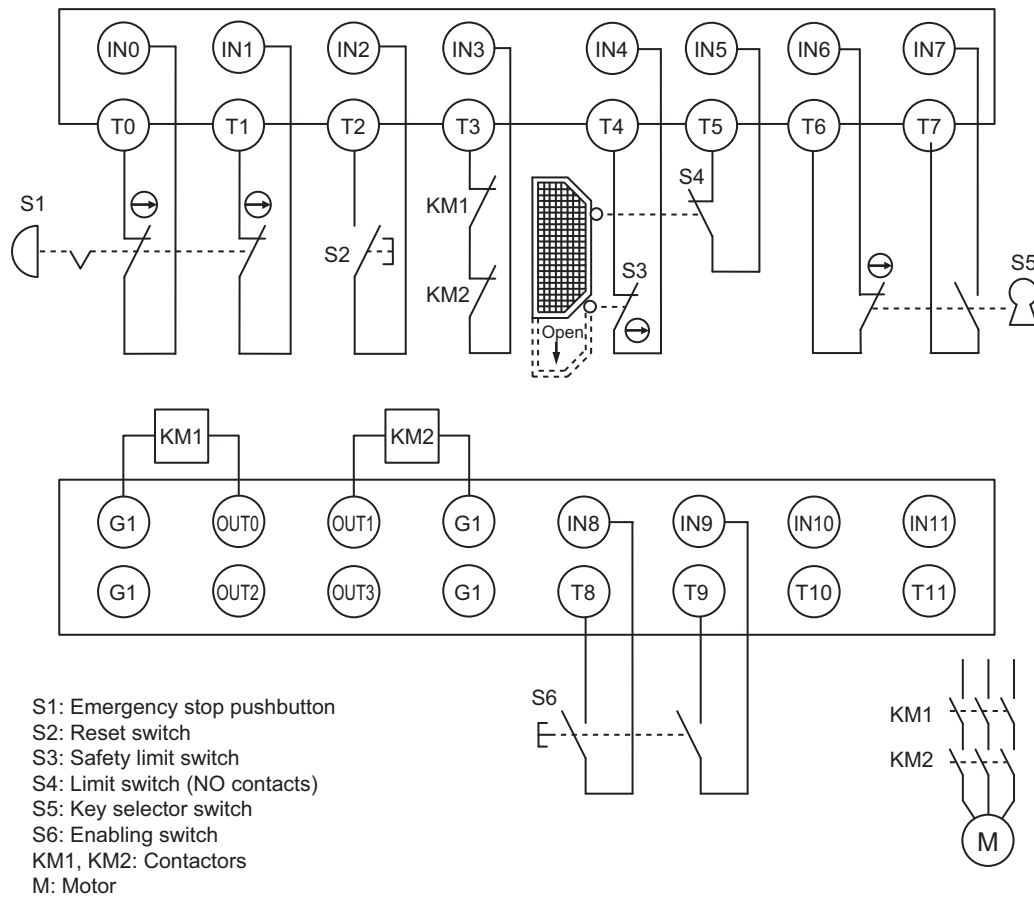

Timing Chart

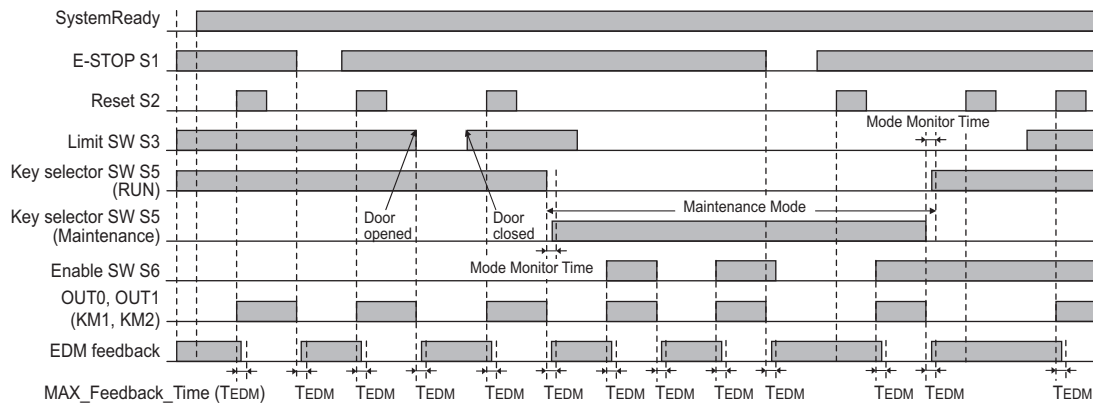

Safety I/O Terminal & I/O Map Setting

● Safety I/O Terminal Settings

GI-SMD1624 Safety Input (CIPOriginator_Instance0)

Device	Input/Test	Discrepancy	On-Off	Off-On	Test Output Mode	Comment
Emergency Stop Switch for Dual Channel Equivalent	IN0/T0	500ms	0ms	0ms	Test Output	Emergency Stop Pushbutton Switch (2NC)
-----	IN1/T1	500ms	0ms	0ms	Test Output	
Mechanical Contact for Single Channel	IN2/T2	0ms	0ms	0ms	Test Output	Reset Switch
EDM Feedback	IN3/T3	0ms	0ms	0ms	Test Output	EDM (Contact Welding Detection)
Safety Limit Switch for Single Channel	IN4/T4	0ms	0ms	0ms	Test Output	Safety Limit Switch (NC)
Mechanical Contact for Single Channel	IN5/T5	0ms	0ms	0ms	Test Output	Limit Switch (NO)
Safety Key Selector Switch for Dual Channel Complementary	IN6/T6	0ms	0ms	0ms	Test Output	Dual Contact
-----	IN7/T7	0ms	0ms	0ms	Test Output	
Enabling Switch	IN8/T8	500ms	0ms	0ms	Test Output	Enable Switch (2NO)
-----	IN9/T9	500ms	0ms	0ms	Test Output	

GI-SMD1624 Safety Output (CIPOriginator_Instance1)

Device	Output	Test Pulse Width [$\times 100\mu\text{s}$]	Comment
Relays with Forcibly Guided Contacts for Dual Channel	OUT0	5	Safety Relay w/ Welding Check
-----	OUT1	5	Safety Relay w/ Welding Check

● I/O Map Settings

Position	Port	R/W	Data Type	Variable	Variable Comment	Variable Type
NXBusMaster	▼ CPU/Expansion Racks					
	NX-CSG320					
	EtherNet/IP Port 1 (Originator)					
	▼ EtherNet/IP Port 2 (Originator)					
192.168.250.2	▼ GI-SMD1624					
	▼ Safety Input					
	▼ Safety Input Byte1					
	SI0	R	SAFEBOOL	EMO_NC_S1	Emergency Stop Pushbutton Switch(2NC)	Global Variables
	SI1	R	SAFEBOOL			
	SI2	R	SAFEBOOL	Reset_S2	Reset Switch	Global Variables
	SI3	R	SAFEBOOL	Feedback_KM1_KM2	EDM(Contact Welding Detection)	Global Variables
	SI4	R	SAFEBOOL	Door_SW_NC_S3	Safety Limit Switch(NC)	Global Variables
	SI5	R	SAFEBOOL	Door_SW_NO_S4	Limit Switch(NO)	Global Variables
	SI6	R	SAFEBOOL	Mode_SW_S5_RUN	Dual Contact	Global Variables
	SI7	R	SAFEBOOL	Mode_SW_S5_Maintenance		Global Variables
	▼ Safety Input Byte2					
	SI8	R	SAFEBOOL	Enable_SW_NO_S6	Enable Switch(2NO)	Global Variables
	SI9	R	SAFEBOOL			
	SI10	R	SAFEBOOL			
	SI11	R	SAFEBOOL			
	▼ Safety Output					
▼ Safety Output Byte1						
SO0	W	SAFEBOOL	Contactora_KM1	Safety Relay w/ Welding Check	Global Variables	
SO1	W	SAFEBOOL	Contactora_KM2	Safety Relay w/ Welding Check	Global Variables	
SO2	W	SAFEBOOL				
SO3	W	SAFEBOOL				

Programming Example

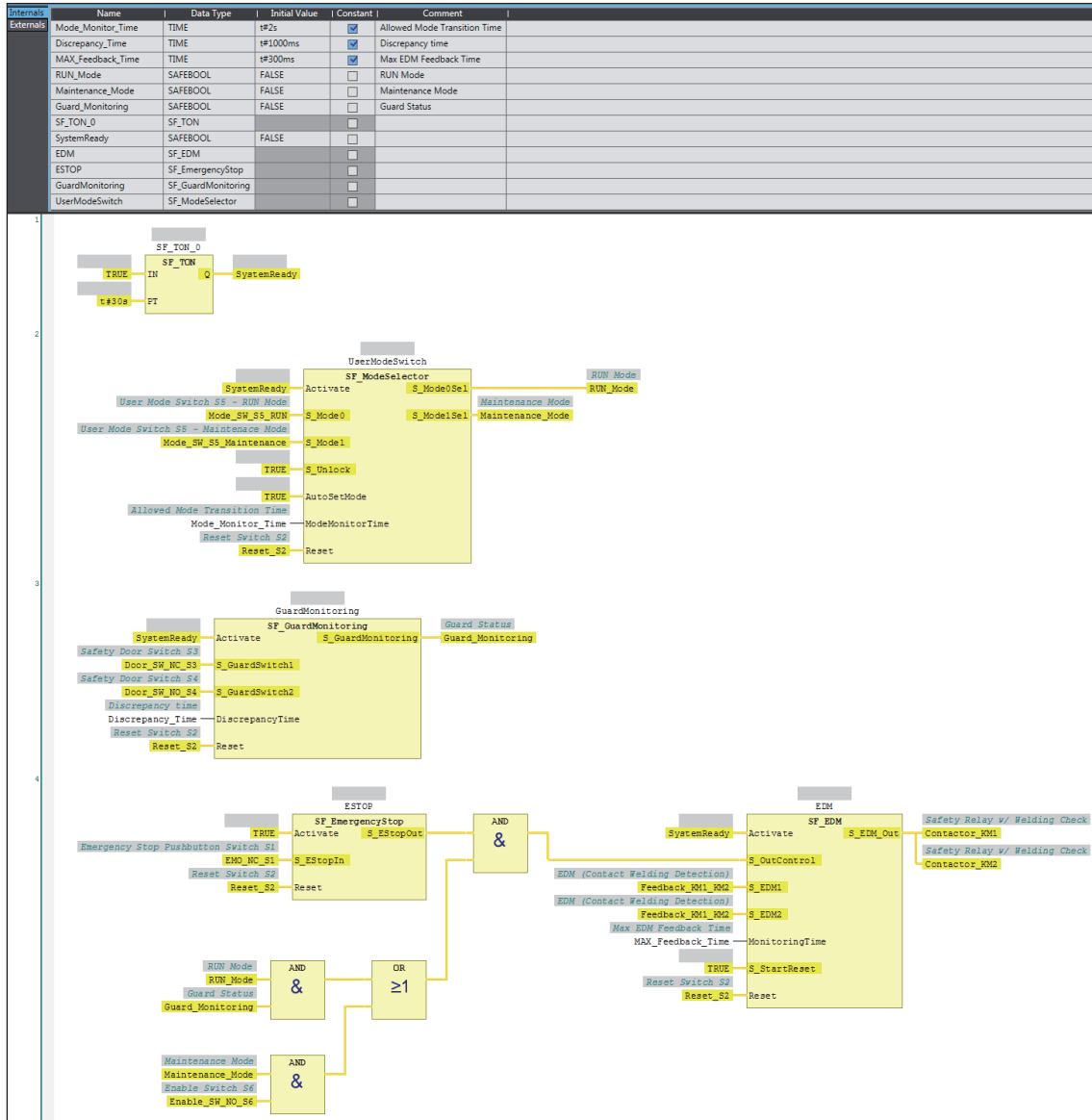

A-4-6 Two-hand Switches

Application Overview

Safety category/PL	Safety device	Stop category	Reset
Equivalent to 4/PLe	Two-hand control switch	0	Auto

Motor M operates when two-hand control switches S11 and S2 are pressed at the same time.

Wiring

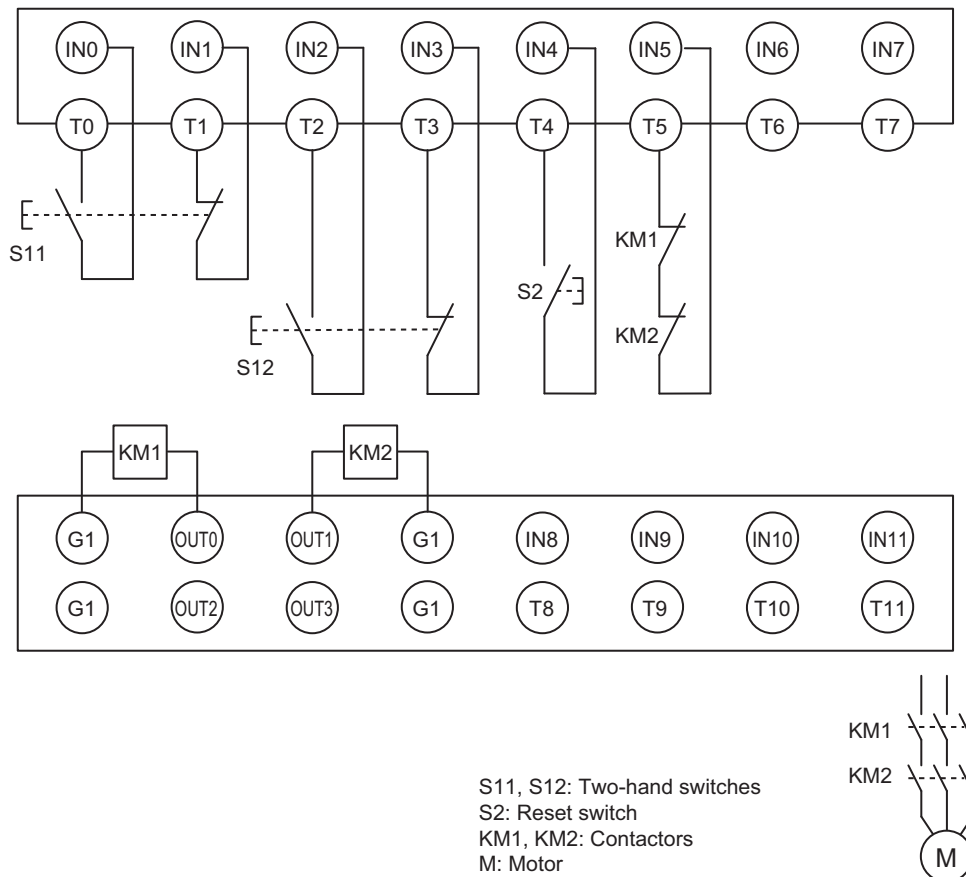

Timing Chart

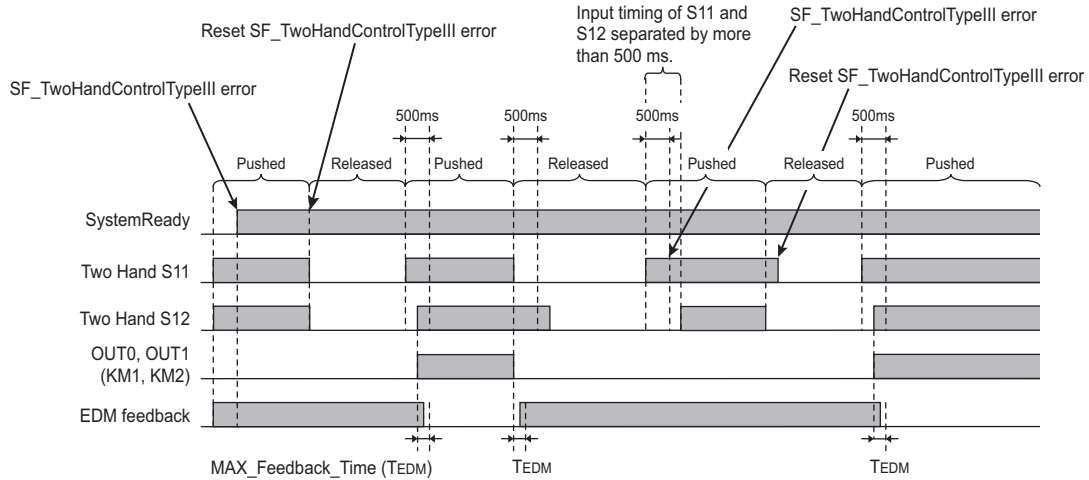

Safety I/O Terminal & I/O Map Setting

● Safety I/O Terminal Settings

GI-SMD1624 Safety Input (CIPOriginator_Instance0)

Device	Input/Test	Discrepancy	On-Off	Off-On	Test Output Mode	Comment
Mechanical Contact for Dual Channel Complementary	IN0/T0	500ms	0ms	0ms	Test Output	Two-hand Control Switch
-----	IN1/T1	500ms	0ms	0ms	Test Output	
Mechanical Contact for Dual Channel Complementary	IN2/T2	500ms	0ms	0ms	Test Output	Two-hand Control Switch
-----	IN3/T3	500ms	0ms	0ms	Test Output	
Mechanical Contact for Single Channel	IN4/T4	0ms	0ms	0ms	Test Output	Reset Switch
EDM Feedback	IN5/T5	0ms	0ms	0ms	Test Output	EDM (Contact Welding Detection)

GI-SMD1624 Safety Output (CIPOriginator_Instance1)

Device	Output	Test Pulse Width [$\times 100\mu\text{s}$]	Comment
Relays with Forcibly Guided Contacts for Dual Channel	OUT0	5	Safety Relay w/ Welding Check
-----	OUT1	5	Safety Relay w/ Welding Check

● I/O Map Settings

Position	Port	R/W	Data Type	Variable	Variable Comment	Variable Type
	▼ CPU/Expansion Racks					
NXBusMaster	NX-CSG320					
	▼ EtherNet/IP Port 1 (Originator)					
	▼ EtherNet/IP Port 2 (Originator)					
192.168.250.2	▼ GI-SMD1624					
	▼ Safety Input					
	▼ Safety Input Byte1					
	SI0	R	SAFEBOOL	Two_Hand_S11	Two-hand Control Switch	Global Variables
	SI1	R	SAFEBOOL			
	SI2	R	SAFEBOOL	Two_Hand_S12	Two-hand Control Switch	Global Variables
	SI3	R	SAFEBOOL			
	SI4	R	SAFEBOOL	Reset_S2	Reset Switch	Global Variables
	SI5	R	SAFEBOOL	Feedback_KM1_KM2	EDM(Contact Welding Detection)	Global Variables
	SI6	R	SAFEBOOL			
	SI7	R	SAFEBOOL			
	▼ Safety Input Byte2					
	SI8	R	SAFEBOOL			
	SI9	R	SAFEBOOL			
	SI10	R	SAFEBOOL			
	SI11	R	SAFEBOOL			
	▼ Safety Output					
	▼ Safety Output Byte1					
	SO0	W	SAFEBOOL	Contactora_KM1	Safety Relay w/Welding Check	Global Variables
	SO1	W	SAFEBOOL	Contactora_KM2	Safety Relay w/Welding Check	Global Variables
	SO2	W	SAFEBOOL			
	SO3	W	SAFEBOOL			

Programming Example

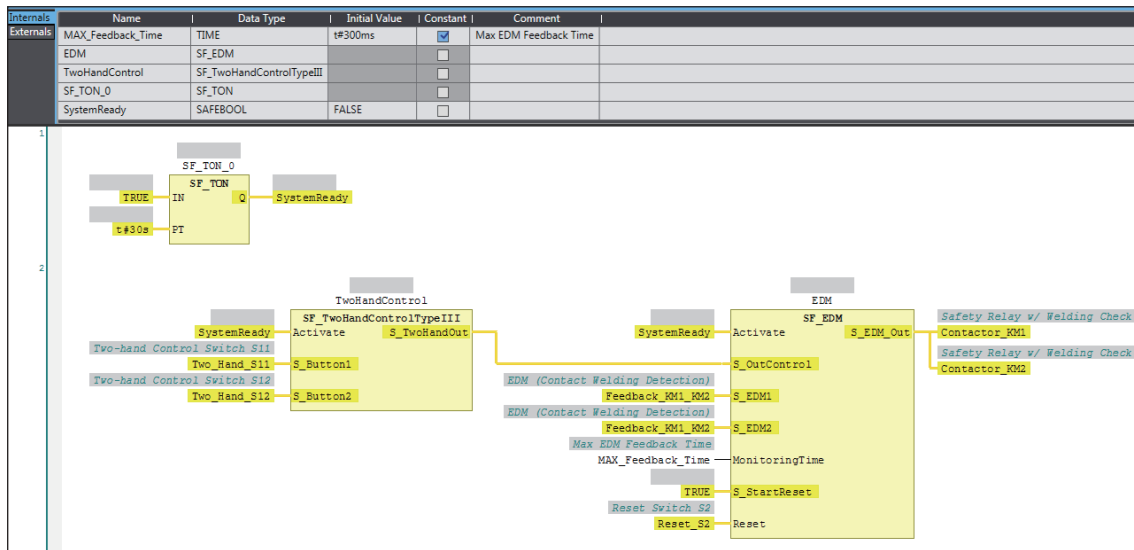

A-4-7 Safety Light Curtain

Application Overview

Safety category/PL	Safety device	Stop category	Reset
Equivalent to 4/PLe	<ul style="list-style-type: none"> Emergency stop pushbutton Safety light curtain 	0	Manual

Safety light curtain monitors aperture area of safeguarded space.

If the light in safety light curtain S3 is interrupted, motor M will stop.

Wiring

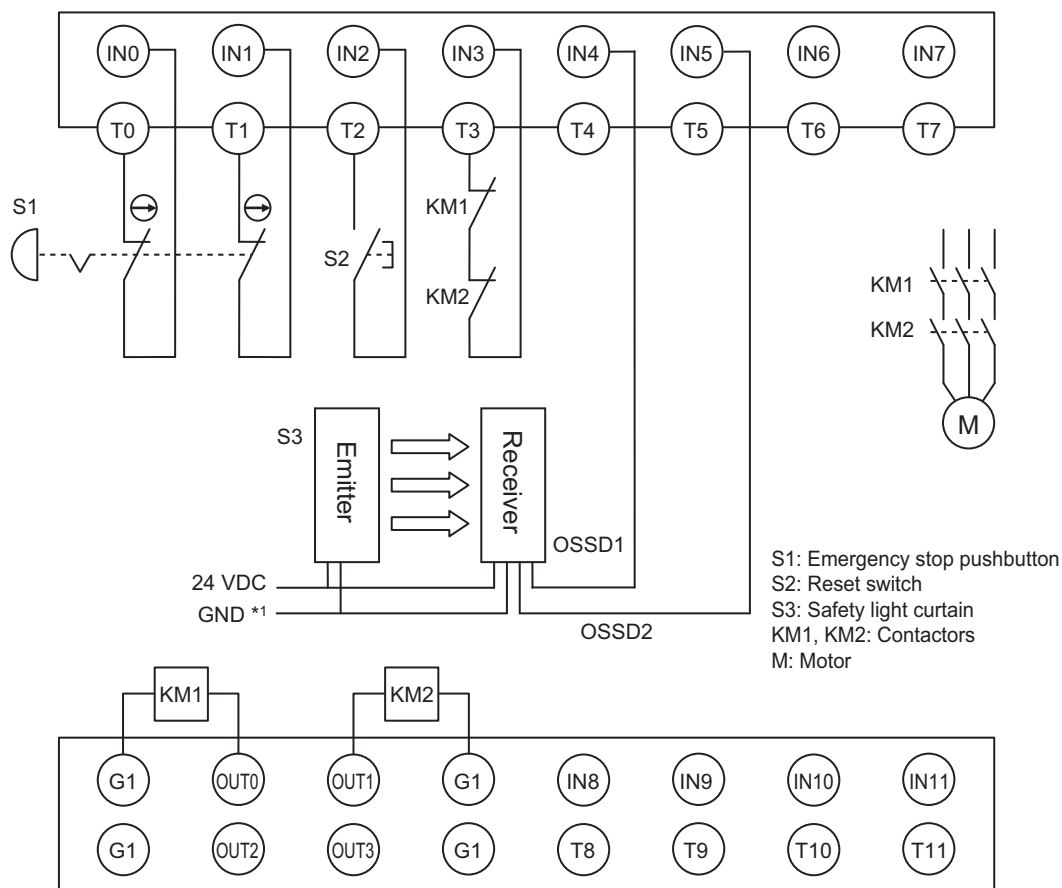

*1. GND of the safety light curtain must be connected to the G0 terminal of the safety I/O terminal.

Timing Chart

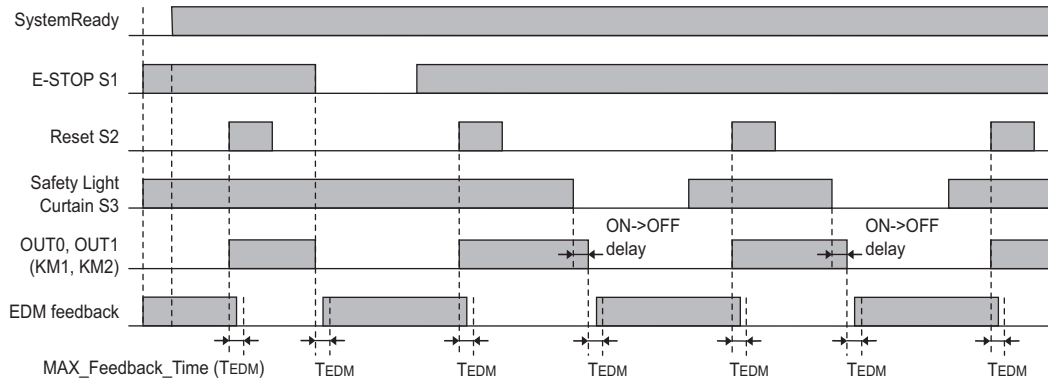

Safety I/O Terminal & I/O Map Setting

● Safety I/O Terminal Settings

GI-SMD1624 Safety Input (CIPOriginator_Instance0)

Device	Input/Test	Discrepancy	On-Off	Off-On	Test Output Mode	Comment
Emergency Stop Switch for Dual Channel Equivalent	IN0/T0	500ms	0ms	0ms	Test Output	Emergency Stop Pushbutton Switch (2NC)
-----	IN1/T1	500ms	0ms	0ms	Test Output	
Mechanical Contact for Single Channel	IN2/T2	0ms	0ms	0ms	Test Output	Reset Switch
EDM Feedback	IN3/T3	0ms	0ms	0ms	Test Output	EDM (Contact Welding Detection)
Safety Light Curtain	IN4/T4	500ms	1ms *1	0ms	Power Supply	Safety Light Curtain
-----	IN5/T5	500ms	1ms *1	0ms	Power Supply	

GI-SMD1624 Safety Output (CIPOriginator_Instance1)

Device	Output	Test Pulse Width [$\times 100\mu\text{s}$]	Comment
Relays with Forcibly Guided Contacts for Dual Channel	OUT0	5	Safety Relay w/ Welding Check
-----	OUT1	5	Safety Relay w/ Welding Check

*1. Set the delay time to 1 ms because the OSSD output diagnosis pulse width of the safety light curtain is 1 ms or less.

● I/O Map Settings

Position	Port	R/W	Data Type	Variable	Variable Comment	Variable Type
	▼ CPU/Expansion Racks					
NXBusMaster	NX-CSG320					
	▼ EtherNet/IP Port 1 (Originator)					
	▼ EtherNet/IP Port 2 (Originator)					
192.168.250.2	▼ GI-SMD1624					
	▼ Safety Input					
	▼ Safety Input Byte1					
	SI0	R	SAFEBOOL	EMO_NC_S1	Emergency Stop Pushbutton Switch(2NC)	Global Variables
	SI1	R	SAFEBOOL			
	SI2	R	SAFEBOOL	Reset_S2	Reset Switch	Global Variables
	SI3	R	SAFEBOOL	Feedback_KM1_KM2	EDM(Contact Welding Detection)	Global Variables
	SI4	R	SAFEBOOL	SLC_S3	Safety Light Curtain S3	Global Variables
	SI5	R	SAFEBOOL			
	SI6	R	SAFEBOOL			
	SI7	R	SAFEBOOL			
	▼ Safety Input Byte2					
	SI8	R	SAFEBOOL			
	SI9	R	SAFEBOOL			
	SI10	R	SAFEBOOL			
	SI11	R	SAFEBOOL			
	▼ Safety Output					
	▼ Safety Output Byte1					
	SO0	W	SAFEBOOL	Contactora_KM1	Safety Relay w/ Welding Check	Global Variables
	SO1	W	SAFEBOOL	Contactora_KM2	Safety Relay w/ Welding Check	Global Variables
	SO2	W	SAFEBOOL			
	SO3	W	SAFEBOOL			

Programming Example

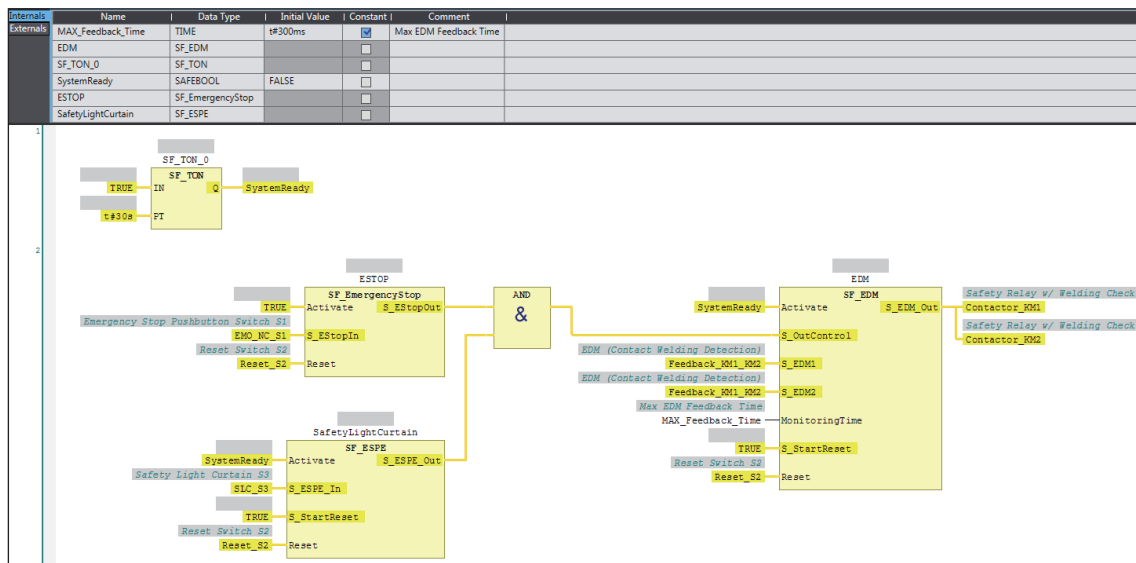

A-4 Application Examples

A

A-4-7 Safety Light Curtain

A-5 I/O Assemblies and I/O Ports for Safety I/O Terminal

The I/O assemblies and I/O Ports for the safety I/O terminal will be displayed when you add them to the Connection Settings (Originator) of the Sysmac Studio.

A-5-1 Safety I/O Terminal (GI-SMD1624)

I/O Assembly	I/O Port	Data type	R/W	Name	Description
Safety Input	SI□	SAFEBOOL	R	Safety Input Process Value	Gives the status of safety input terminal. 0: OFF, 1: ON
Safety Input + Combined Status	SI□	SAFEBOOL	R	Safety Input Process Value	Gives the status of safety input terminal. 0: OFF, 1: ON
	Combined Input Status	SAFEBOOL	R	Combined Safety Input Status	This flag indicates the status of the safety input terminals. 0: An error has occurred on one of the safety input terminals. 1: All of the safety input terminals are normal (no errors).
Safety Input + SI PT. Status	SI□	SAFEBOOL	R	Safety Input Process Value	Gives the status of safety input terminal. 0: OFF, 1: ON
	SIS□	SAFEBOOL	R	Safety Input Status	This flag indicates the status of the safety input terminals. 0: Error, 1: No error
SO Pt. Status	SOS□	SAFEBOOL	R	Safety Output Status	This flag indicates the status of the safety output terminals. 0: Error, 1: No error
Safety Input + SI, SO Combined Status	SI□	SAFEBOOL	R	Safety Input Process Value	Gives the status of safety input terminal. 0: OFF, 1: ON
	Combined Input Status	SAFEBOOL	R	Combined Safety Input Status	This flag indicates the status of the safety input terminals. 0: An error has occurred on one of the safety input terminals. 1: All of the safety input terminals are normal (no errors).
	Combined Output Status	SAFEBOOL	R	Combined Safety Output Status	This flag indicates the status of the safety output terminals. 0: An error has occurred on one of the safety output terminals. 1: All of the safety output terminals are normal (no errors).
Safety Input + SI Combined Status + SO Pt. Status	SI□	SAFEBOOL	R	Safety Input Process Value	Gives the status of safety input terminal. 0: OFF, 1: ON
	Combined Input Status	SAFEBOOL	R	Combined Safety Input Status	This flag indicates the status of the safety input terminals. 0: An error has occurred on one of the safety input terminals. 1: All of the safety input terminals are normal (no errors).
	SOS□	SAFEBOOL	R	Safety Output Status	This flag indicates the status of the safety output terminals. 0: Error, 1: No error
Safety Global Input	SI□	SAFEBOOL	R	Safety Input Process Value	Gives the status of safety input terminal. 0: OFF, 1: ON
	SIS□	SAFEBOOL	R	Safety Input Status	This flag indicates the status of the safety input terminals. 0: Error, 1: No error
	TO□	SAFEBOOL	R	Test Output Process Value	Gives the status of test output terminal. 0: OFF, 1: ON
	TOS□	SAFEBOOL	R	Test Output Status	This flag indicates the status of the test output terminals. 0: Error, 1: No error
	SOM□	SAFEBOOL	R	Safety Output Monitoring	Monitors the status of safety output terminal. 0: OFF, 1: ON
	SOS□	SAFEBOOL	R	Safety Output Status	This flag indicates the status of the safety output terminals. 0: Error, 1: No error
	Output Power Error	SAFEBOOL	R	Output Power Error	The voltage of output power supply (V1) is being diagnosed. 0: The power supply voltage is abnormal or the power supply is OFF. 1: The power supply voltage is normal.
	Input Power Error	SAFEBOOL	R	Input Power Error	The voltage of unit power supply (V0) is being diagnosed. 0: The power supply voltage is abnormal or the power supply is OFF. 1: The power supply voltage is normal.

I/O Assembly	I/O Port	Data type	R/W	Name	Description
Safety Global Input	Combined Input Status	SAFEBOOL	R	Combined Safety Input Status	This flag indicates the status of the safety input terminals. 0: An error has occurred on one of the safety input terminals. 1: All of the safety input terminals are normal (no errors).
	Combined Output Status	SAFEBOOL	R	Combined Safety Output Status	This flag indicates the status of the safety output terminals. 0: An error has occurred on one of the safety output terminals. 1: All of the safety output terminals are normal (no errors).
	Muting Lamp Status□	SAFEBOOL	R	Muting Lamp Status	This flag indicates the status of the muting lamp output terminals. (Only T3 and T7 are available for the purpose.) 0: The muting lamp is faulty or the wiring is disconnected. 1: No error
	Output Power Over Current Error	SAFEBOOL	R	Output Power Over Current Error	The current of output power supply (V1) is being diagnosed. 0: An overcurrent has occurred. 1: No error
	Input Power Over Current Error	SAFEBOOL	R	Input Power Over Current Error	The current of unit power supply (V0) is being diagnosed. 0: An overcurrent has occurred. 1: No error
Safety Output	SO□	SAFEBOOL	W	Safety Output Process Value	Gives the status of safety output terminal. 0: OFF, 1: ON
Safety Global Output	SO□	SAFEBOOL	W	Safety Output Process Value	Gives the status of safety output terminal. 0: OFF, 1: ON
	TO□	SAFEBOOL	W	Test Output Process Value	Gives the status of test output terminal. 0: OFF, 1: ON

A-5-2 Safety I/O Terminal (GI-SID1224)

I/O Assembly	I/O Port	Data type	R/W	Name	Description
Safety Input	SI□	SAFEBOOL	R	Safety Input Process Value	Gives the status of safety input terminal. 0: OFF, 1: ON
Safety Input + Combined Status	SI□	SAFEBOOL	R	Safety Input Process Value	Gives the status of safety input terminal. 0: OFF, 1: ON
	Combined Input Status	SAFEBOOL	R	Combined Safety Input Status	This flag indicates the status of the safety input terminals. 0: An error has occurred on one of the safety input terminals. 1: All of the safety input terminals are normal (no errors).
Safety Input + SI PT. Status	SI□	SAFEBOOL	R	Safety Input Process Value	Gives the status of safety input terminal. 0: OFF, 1: ON
	SIS□	SAFEBOOL	R	Safety Input Status	This flag indicates the status of the safety input terminals. 0: Error, 1: No error
Safety Global Input	SI□	SAFEBOOL	R	Safety Input Process Value	Gives the status of safety input terminal. 0: OFF, 1: ON
	SIS□	SAFEBOOL	R	Safety Input Status	This flag indicates the status of the safety input terminals. 0: Error, 1: No error
	TO□	SAFEBOOL	R	Test Output Process Value	Gives the status of test output terminal. 0: OFF, 1: ON
	TOS□	SAFEBOOL	R	Test Output Status	This flag indicates the status of the test output terminals. 0: Error, 1: No error
	Input Power Error	SAFEBOOL	R	Input Power Error	The voltage of unit power supply (V0) is being diagnosed. 0: The power supply voltage is abnormal or the power supply is OFF. 1: The power supply voltage is normal.
	Combined Input Status	SAFEBOOL	R	Combined Safety Input Status	This flag indicates the status of the safety input terminals. 0: An error has occurred on one of the safety input terminals. 1: All of the safety input terminals are normal (no errors).
	Muting Lamp Status□	SAFEBOOL	R	Muting Lamp Status	This flag indicates the status of the muting lamp output terminals. (Only T3 and T7 are available for the purpose.) 0: The muting lamp is faulty or the wiring is disconnected. 1: No error
Safety Global Output	Input Power Over Current Error	SAFEBOOL	R	Input Power Over Current Error	The current of unit power supply (V0) is being diagnosed. 0: An overcurrent has occurred. 1: No error
	TO□	SAFEBOOL	W	Test Output Process Value	Gives the status of test output terminal. 0: OFF, 1: ON

A-5 I/O Assemblies and I/O Ports for Safety I/O Terminal

A

A-5-2 Safety I/O Terminal (GI-SID1224)

A-6 Version Information

This section describes the combinations that can be used of the unit versions of the safety I/O terminals, Safety CPU Units, Communication Control Units, and Machine Automation Controllers, and the version of the Sysmac Studio.

The combinations that can be used are available in the versions or later shown in the table below.

- Safety CPU Unit: This is the unit version of the Safety CPU Unit that supports the safety I/O terminal.
- Communication Control Unit: This is the unit version of the Communication Control Unit that supports the safety I/O terminal.
- Machine Automation Controller: This is the unit version of the Machine Automation Controller that supports the safety I/O terminal.
- Sysmac Studio: This is the version of the Sysmac Studio that supports the Communication Control Unit, Machine Automation Controller, Safety CPU Unit, and safety I/O terminal.
- Network Configurator Network Configurator version that supports safety I/O terminals.

Correspondence in version between safety I/O terminals and connectable units

Safety I/O Terminal		Supported Version					
Model	Unit Version	Safety CPU Unit NX-SL5700 NX-SL5500	Communication Control Unit NX-CSG320	Machine Automation Controller NX102-□□□□	Sysmac Studio	Network Configurator	Network Configurator for DeviceNet Safety
GI-SMD1624	Ver.1.0	Ver.1.3	Ver.1.01	Ver.1.31	Ver.1.24 or later	Ver.3.67 or later	Ver.3.42 or later
GI-SID1224	Ver.1.0	Ver.1.3	Ver.1.01	Ver.1.31	Ver.1.24 or later	Ver.3.67 or later	Ver.3.42 or later

OMRON Corporation Industrial Automation Company
Kyoto, JAPAN

Contact: www.ia.omron.com

Regional Headquarters

OMRON EUROPE B.V.

Wegalaan 67-69, 2132 JD Hoofddorp
The Netherlands
Tel: (31)2356-81-300/Fax: (31)2356-81-388

OMRON ELECTRONICS LLC

2895 Greenspoint Parkway, Suite 200
Hoffman Estates, IL 60169 U.S.A.
Tel: (1) 847-843-7900/Fax: (1) 847-843-7787

OMRON ASIA PACIFIC PTE. LTD.

No. 438A Alexandra Road # 05-05/08 (Lobby 2),
Alexandra Technopark,
Singapore 119967
Tel: (65) 6835-3011/Fax: (65) 6835-2711

OMRON (CHINA) CO., LTD.

Room 2211, Bank of China Tower,
200 Yin Cheng Zhong Road,
PuDong New Area, Shanghai, 200120, China
Tel: (86) 21-5037-2222/Fax: (86) 21-5037-2200

Authorized Distributor:

© OMRON Corporation 2018-2019 All Rights Reserved.
In the interest of product improvement,
specifications are subject to change without notice.

Cat. No. Z400-E1-05

1219