

Programmable Terminal NA-series

Replace Guide From NA5 to NA5-V1

NA5-15□101□-V1

NA5-12□101□-V1

NA5-9□001□-V1

NA5-7□001□-V1



Replace
Guide

NOTE

All rights reserved. No part of this publication may be reproduced, stored in a retrieval system, or transmitted, in any form, or by any means, mechanical, electronic, photocopying, recording, or otherwise, without the prior written permission of OMRON.

No patent liability is assumed with respect to the use of the information contained herein. Moreover, because OMRON is constantly striving to improve its high-quality products, the information contained in this manual is subject to change without notice. Every precaution has been taken in the preparation of this manual. Nevertheless, OMRON assumes no responsibility for errors or omissions. Neither is any liability assumed for damages resulting from the use of the information contained in this publication.

Trademarks

- Sysmac and SYSMAC are trademarks or registered trademarks of OMRON Corporation in Japan and other countries for OMRON factory automation products.
- Microsoft, Windows, Windows Vista, Excel, and Visual Basic are either registered trademarks or trademarks of Microsoft Corporation in the United States and other countries.
- EtherCAT® is registered trademark and patented technology, licensed by Beckhoff Automation GmbH, Germany.
- ODVA, CIP, CompoNet, DeviceNet, and EtherNet/IP are trademarks of ODVA.
- The SD and SDHC logos are trademarks of SD-3C, LLC. 
- Portions of this software are copyright 2014 The FreeType Project (www.freetype.org). All rights reserved.

Other company names and product names in this document are the trademarks or registered trademarks of their respective companies.

Copyrights

Microsoft product screen shots reprinted with permission from Microsoft Corporation.

■ Introduction

This document provides information useful to replace NA5 Programmable Terminal with its successor model NA5-V1 but does not contain safety precautions.

Please prepare user's manuals for NA-series Programmable Terminal and read and understand safety precautions and necessary information before using the product.

Terms and Conditions Agreement

Warranty, Limitations of Liability

Warranties

- **Exclusive Warranty**

Omron's exclusive warranty is that the Products will be free from defects in materials and workmanship for a period of twelve months from the date of sale by Omron (or such other period expressed in writing by Omron). Omron disclaims all other warranties, express or implied.

- **Limitations**

OMRON MAKES NO WARRANTY OR REPRESENTATION, EXPRESS OR IMPLIED, ABOUT NON-INFRINGEMENT, MERCHANTABILITY OR FITNESS FOR A PARTICULAR PURPOSE OF THE PRODUCTS. BUYER ACKNOWLEDGES THAT IT ALONE HAS DETERMINED THAT THE PRODUCTS WILL SUITABLY MEET THE REQUIREMENTS OF THEIR INTENDED USE.

Omron further disclaims all warranties and responsibility of any type for claims or expenses based on infringement by the Products or otherwise of any intellectual property right.

- **Buyer Remedy**

Omron's sole obligation hereunder shall be, at Omron's election, to (i) replace (in the form originally shipped with Buyer responsible for labor charges for removal or replacement thereof) the non-complying Product, (ii) repair the non-complying Product, or (iii) repay or credit Buyer an amount equal to the purchase price of the non-complying Product; provided that in no event shall Omron be responsible for warranty, repair, indemnity or any other claims or expenses regarding the Products unless Omron's analysis confirms that the Products were properly handled, stored, installed and maintained and not subject to contamination, abuse, misuse or inappropriate modification. Return of any Products by Buyer must be approved in writing by Omron before shipment. Omron Companies shall not be liable for the suitability or unsuitability or the results from the use of Products in combination with any electrical or electronic components, circuits, system assemblies or any other materials or substances or environments. Any advice, recommendations or information given orally or in writing, are not to be construed as an amendment or addition to the above warranty.

See <http://www.omron.com/global/> or contact your Omron representative for published information.

Limitation on Liability; Etc

OMRON COMPANIES SHALL NOT BE LIABLE FOR SPECIAL, INDIRECT, INCIDENTAL, OR CONSEQUENTIAL DAMAGES, LOSS OF PROFITS OR PRODUCTION OR COMMERCIAL LOSS IN ANY WAY CONNECTED WITH THE PRODUCTS, WHETHER SUCH CLAIM IS BASED IN CONTRACT, WARRANTY, NEGLIGENCE OR STRICT LIABILITY.

Further, in no event shall liability of Omron Companies exceed the individual price of the Product on which liability is asserted.

Application Considerations

Suitability of Use

Omron Companies shall not be responsible for conformity with any standards, codes or regulations which apply to the combination of the Product in the Buyer's application or use of the Product. At Buyer's request, Omron will provide applicable third party certification documents identifying ratings and limitations of use which apply to the Product. This information by itself is not sufficient for a complete determination of the suitability of the Product in combination with the end product, machine, system, or other application or use. Buyer shall be solely responsible for determining appropriateness of the particular Product with respect to Buyer's application, product or system. Buyer shall take application responsibility in all cases.

NEVER USE THE PRODUCT FOR AN APPLICATION INVOLVING SERIOUS RISK TO LIFE OR PROPERTY OR IN LARGE QUANTITIES WITHOUT ENSURING THAT THE SYSTEM AS A WHOLE HAS BEEN DESIGNED TO ADDRESS THE RISKS, AND THAT THE OMRON PRODUCT(S) IS PROPERLY RATED AND INSTALLED FOR THE INTENDED USE WITHIN THE OVERALL EQUIPMENT OR SYSTEM.

Programmable Products

Omron Companies shall not be responsible for the user's programming of a programmable Product, or any consequence thereof.

Disclaimers

Performance Data

Data presented in Omron Company websites, catalogs and other materials is provided as a guide for the user in determining suitability and does not constitute a warranty. It may represent the result of Omron's test conditions, and the user must correlate it to actual application requirements. Actual performance is subject to the Omron's Warranty and Limitations of Liability.

Change in Specifications

Product specifications and accessories may be changed at any time based on improvements and other reasons. It is our practice to change part numbers when published ratings or features are changed, or when significant construction changes are made. However, some specifications of the Product may be changed without any notice. When in doubt, special part numbers may be assigned to fix or establish key specifications for your application. Please consult with your Omron's representative at any time to confirm actual specifications of purchased Product.

Errors and Omissions

Information presented by Omron Companies has been checked and is believed to be accurate; however, no responsibility is assumed for clerical, typographical or proofreading errors or omissions.

CONTENTS

TERMS AND CONDITIONS AGREEMENT	4
<i>Warranty, Limitations of Liability.....</i>	<i>4</i>
<i>Application Considerations.....</i>	<i>4</i>
<i>Disclaimers.....</i>	<i>5</i>
CONTENTS.....	6
1 RELATED MANUALS.....	7
2 PRECAUTIONS.....	8
<i>2-1 Wiring.....</i>	<i>8</i>
<i>2-2 Grounding.....</i>	<i>9</i>
3 APPLICABLE MODELS AND SPECIFICATIONS.....	10
<i>3-1 Applicable models.....</i>	<i>10</i>
<i>3-2 Specifications.....</i>	<i>11</i>
4 WORKFLOW.....	14
<i>4-1 Workflow.....</i>	<i>14</i>
<i>4-2 Preparation.....</i>	<i>15</i>
<i>4-3 Removing the currently installed NA5.....</i>	<i>23</i>
<i>4-4 Installing NA5-V1.....</i>	<i>24</i>
<i>4-5 Start-up.....</i>	<i>27</i>
5 APPENDIX-1 TRANSFERRING PROJECT DATA BY USING A MEDIA DEVICE ..	30
REVISION HISTORY	36

1 Related Manuals

The following manuals are related. Use these manuals for reference.

Cat. No.	Models	Manual name
V117	NA5-15□101□ NA5-12□101□ NA5-9□001□ NA5-7□001□	NA-series Programmable Terminal Hardware User's Manual
V118	NA5-15□101□(-V1) NA5-12□101□(-V1) NA5-9□001□(-V1) NA5-7□001□(-V1)	NA-series Programmable Terminal Software User's Manual
V119	NA5-15□101□(-V1) NA5-12□101□(-V1) NA5-9□001□(-V1) NA5-7□001□(-V1)	NA-series Programmable Terminal Device Connection User's Manual
V120	NA5-15□101□ NA5-12□101□ NA5-9□001□ NA5-7□001□	NA-series Programmable Terminal Startup Guide
V125	NA5-15W101□-V1 NA5-12W101□-V1 NA5-9W001□-V1 NA5-7W001□-V1	NA-series Programmable Terminal Hardware(-V1) User's Manual

2 Precautions

2-1 Wiring

Observe the following precautions when wiring the NA5-□□W□□□□-V1.
The internal power supply in the NA5-□□W□□□□-V1 is a non-isolated DC power supply. Never ground the 24-V side. If the 24 V power supply to the NA is grounded positively, a short circuit will occur as shown below and may result in damage to the device.

24 V Grounding Power Supply

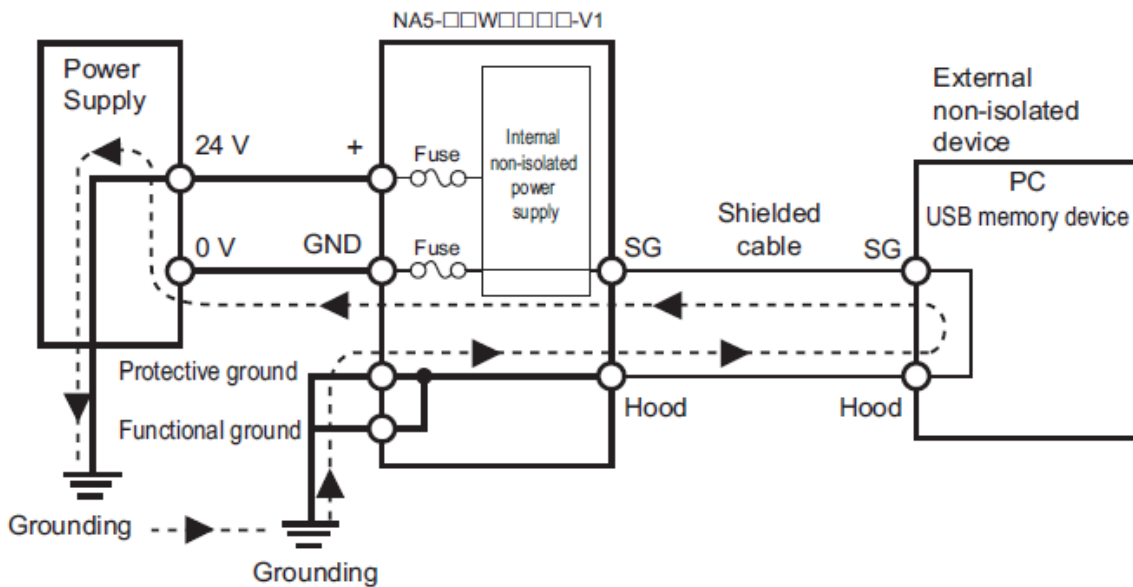

NA5-□□W□□□□-V1 grounding diagram

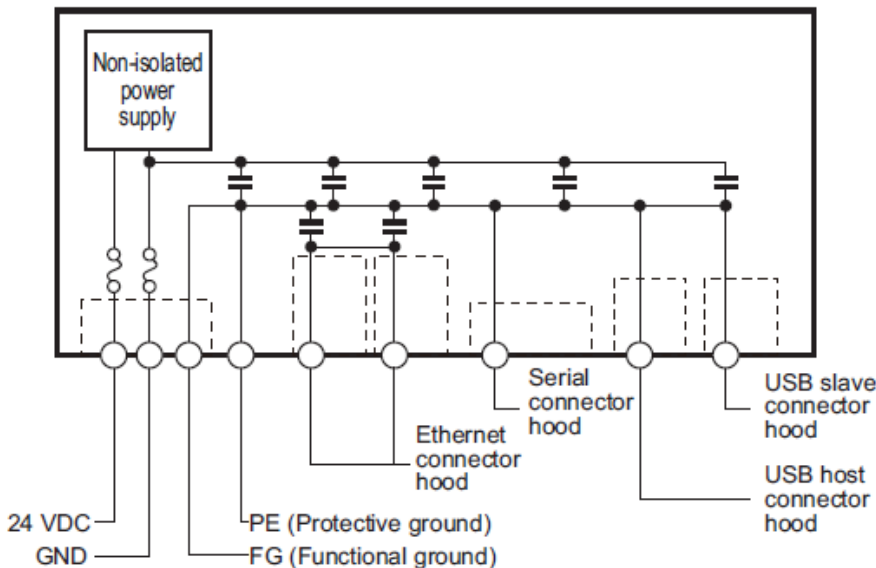

Additional Information

The internal power supply of the NA5-□□W□□□□ Product uses an isolated DC power supply, and therefore is not susceptible to the effects of grounding of the 24V side.

2-2 Grounding

The NA5-V1 has a protective ground terminal.

When using the NA5-□□W□□□□-V1, to help prevent electrical shock, ground to 100 Ω or less by using dedicated ground wires (with cross-section area of 2 mm² or larger) and tighten the terminal screw on the protective ground terminal to a torque of 1.0 to 1.2 N·m.

3 Applicable models and specifications

3-1 Applicable models

Discontinued Products

Programmable Terminal

NA5-15W101S

NA5-15W101B

NA5-12W101S

NA5-12W101B

NA5-9W001S

NA5-9W001B

NA5-7W001S

NA5-7W001B



Recommended Replacements

Programmable Terminal

NA5-15W101S-V1

NA5-15W101B-V1

NA5-12W101S-V1

NA5-12W101B-V1

NA5-9W001S-V1

NA5-9W001B-V1

NA5-7W001S-V1

NA5-7W001B-V1

3-2 Specifications

■ Body Color

Product models to be discontinued NA5-□W□□□□	Recommended replacement models NA5-□W□□□□-V1
Black: NA5-□W□□□B Silver: NA5-□W□□□S	Black: NA5-□W□□□B-V1 Silver: NA5-□W□□□S-V1

■ Terminals/ Wire connection

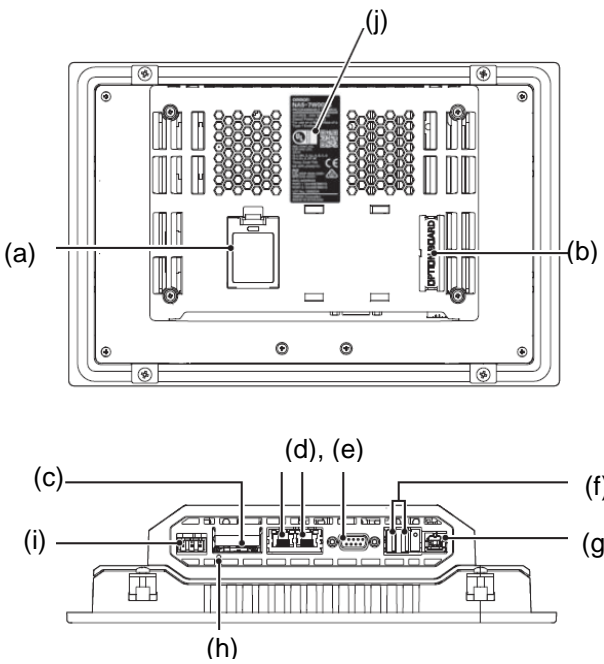
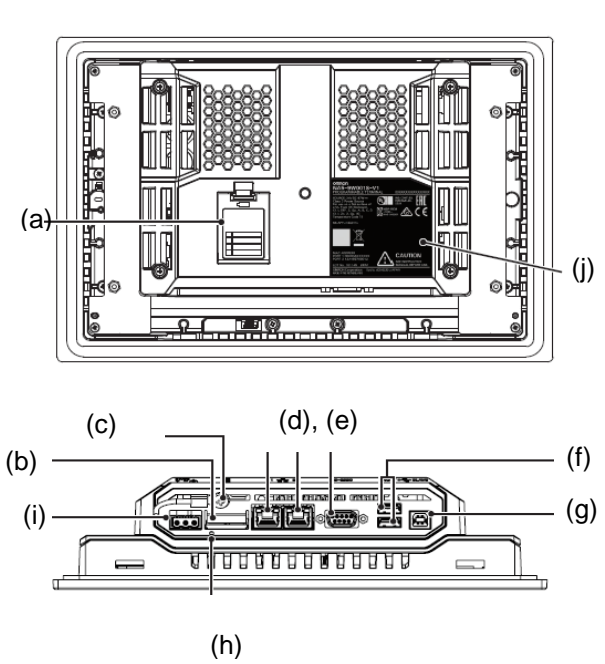
Product models to be discontinued NA5-□W□□□□	Recommended replacement models NA5-□W□□□□-V1
 <p>(a) Battery cover (b) Expansion unit connector cover*1 (c) SD memory card slot (d) Ethernet port (e) Serial port*1 (f) USB port(host) (g) USB port(slave) (h) Reset switch (i) 24VDC (j) Identification label</p>	 <p>(a) Battery cover (b) SD memory card slot (c) Protective grounding terminal (d) Ethernet port (e) Serial port*1 (f) USB port(host) (g) USB port(slave) (h) Reset switch (i) 24VDC (j) Identification label</p>

*1 For future expansion

■ Mounting dimensions

Discontinued Products NA5-□W□□□□	Recommended Replacements NA5-□W□□□□-V1
NA5-15W □□□□ Panel cutout 392+1/0(W), 268+1/0(H) Panel thickness: 1.6 to 6.0mm	NA5-15W □□□□-V1 Panel cutout 392+1/0(W), 268+1/0(H) Panel thickness: 1.6 to 6.0mm
NA5-12W □□□□ Panel cutout 310+1/0(W), 221+1/0(H) Panel thickness: 1.6 to 6.0mm	NA5-12W □□□□-V1 Panel cutout 310+1/0(W), 221+1/0(H) Panel thickness: 1.6 to 6.0mm
NA5-9W □□□□ Panel cutout 261+1/0(W), 166+1/0(H) Panel thickness: 1.6 to 6.0mm	NA5-9W □□□□-V1 Panel cutout 261+1/0(W), 166+1/0(H) Panel thickness: 1.6 to 6.0mm
NA5-7W □□□□ Panel cutout 197+1/0(W), 141+1/0(H) Panel thickness: 1.6 to 6.0mm	NA5-7W □□□□-V1 Panel cutout 197+1/0(W), 141+1/0(H) Panel thickness: 1.6 to 6.0mm

■ Dimensions

Discontinued Products NA5-□W□□□□	Recommended Replacements NA5-□W□□□□-V1
NA5-15W □□□□ 420×291×69 (mm)	NA5-15W □□□□-V1 420×291×69 (mm)
NA5-12W □□□□ 340×244×69 (mm)	NA5-12W □□□□-V1 340×244×69 (mm)
NA5-9W □□□□ 290×190×69 (mm)	NA5-9W □□□□-V1 290×190×69 (mm)
NA5-7W □□□□ 236×165×69 (mm)	NA5-7W □□□□-V1 236×165×69 (mm)

■ Characteristics

Item	Discontinued Products NA5-□W□□□□				Recommended Replacements NA5-□W□□□□-V1			
	NA5 -15	NA5 -12	NA5 -9	NA5 -7	NA5 -15	NA5 -12	NA5 -9	NA5 -7
Power consumption	47W max.	45W max.	40W max.	35 W max.	29W max.	25W max.	23W max.	19W max.
Display device	TFT LCD				TFT LCD			
Resolution	1280×800 (WXGA)		800×480 (WVGA)		1280×800 (WXGA)		800×480 (WVGA)	
Color	16,770,000 colors				16,770,000 colors			
Support software	Sysmac Studio Version 1.10 or higher				Sysmac Studio Version 1.40 or higher			
External Interfaces	Ethernet ports (2 ports), USB host ports (2 ports), USB slave port, Serial port (for future expansion), SD memory card slot				Ethernet ports (2 ports), USB host ports (2 ports), USB slave port, Serial port (for future expansion), SD memory card slot			
External storage device	SD Memory Card, USB Memory Device				SD Memory Card, USB Memory Device			
Backlight life	50,000 hours min.				50,000 hours min.			
Ambient operating temperature	0 to 50°C				0 to 50°C			
Communications method	Ethernet, CIP Ethernet, FINS Ethernet				Ethernet, CIP Ethernet, FINS Ethernet			
Runtime version	1.00 or higher				1.08 or higher			

4 Workflow

4-1 Workflow

The replacement procedure with NA5-V1 is as follows. Operations in are explained from the next page.

4-2 Preparation

4-2-1 Check for positive grounding of the existing equipment

4-2-2 Uploading the project from the existing NA5

4-2-3 Converting the project for NA5-V1

4 -3 Removing the currently installed NA5

4-3-1 Turning OFF the power to the currently installed NA5

4-3-2 Removing all cables

4-3-3 Removing the storage devices

4-3-4 Removing the currently installed NA5 from the operation panel

4-4 Installing NA5-V1

4-4-1 Installing the NA5-V1 to the operation panel

4-4-2 Ground wiring

4-4-3 Wiring the cables

4-4-4 Installing the storage devices

4-5 Start-up

4-5-1 Turning ON the power to the NA5-V1

4-5-2 Downloading the project to the NA5-V1

4-5-3 Checking the settings and communications

4-5-4 Starting operation

4-2 Preparation

4-2-1 Check for positive grounding of the existing equipment

1) Checking for positive grounding on the wiring diagram

Check that no shortcut circuit is produced between 24V-side of the NA5 and the ground side (No positive grounding). If a short-circuit is made when NA5-V1 is installed instead of NA5, the device may be damaged due to a short-circuit as shown in the following **failure example**, because the internal power supply of NA5-V1 is non-insulated DC power supply.

Failure example (A shortcircuit between +24V and 0V of power supply)

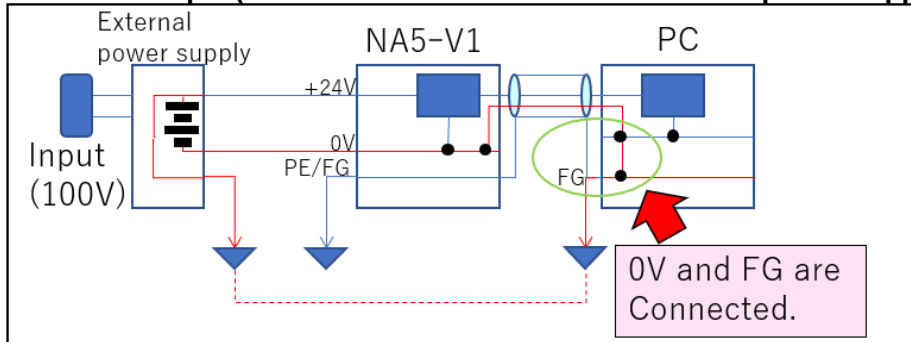

*If a shortcircuit is made between the 24V-side of the NA5-V1 and the ground terminal (Positive grounding), change the wiring (measure 1), or isolate the external power supply and NA5-V1(measure 2).

Measure 1 (No positive grounding)

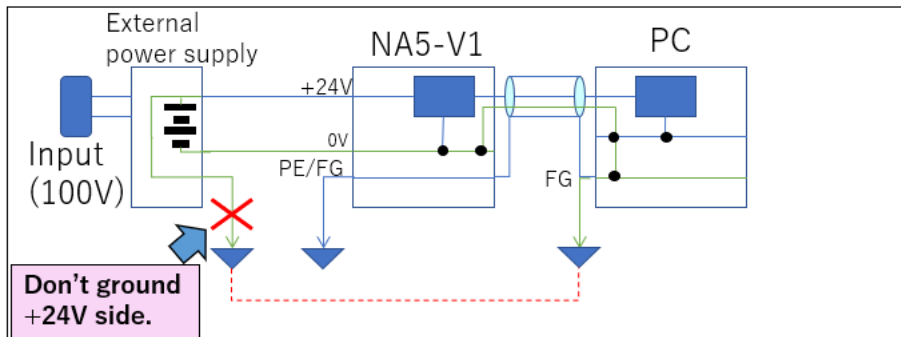

Measure 2 (Isolate the external power supply and NA5-V1)

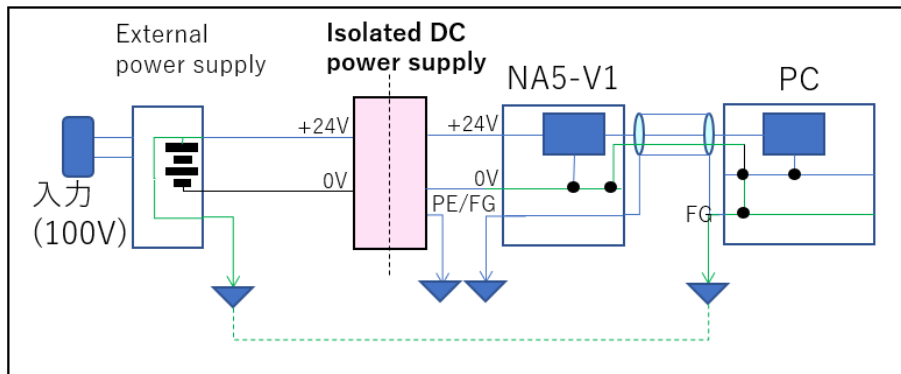

2) Check for positive grounding in the operation panel

Check wirings to confirm that the 24V-side and the ground side are not short-circuited by using a tester or other equipment.

4-2-2 Uploading the project from the existing NA5

1. Start the Sysmac Studio.
*Sysmac Studio Ver.1.40 or higher must be installed in the computer.



2. When the Sysmac Studio starts, select **New Project**.
* If you relink to the PLC, use an existing PLC project to create a new HMI project.



3. In the right dialog box, select HMI for **Category**, NA5 model type for **Device**, and runtime version for **Version**.

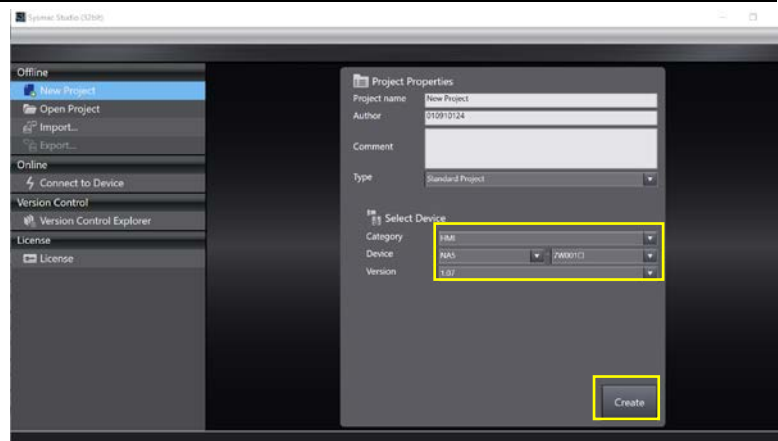

4. Select **Communications Setup** from the **HMI** Menu.

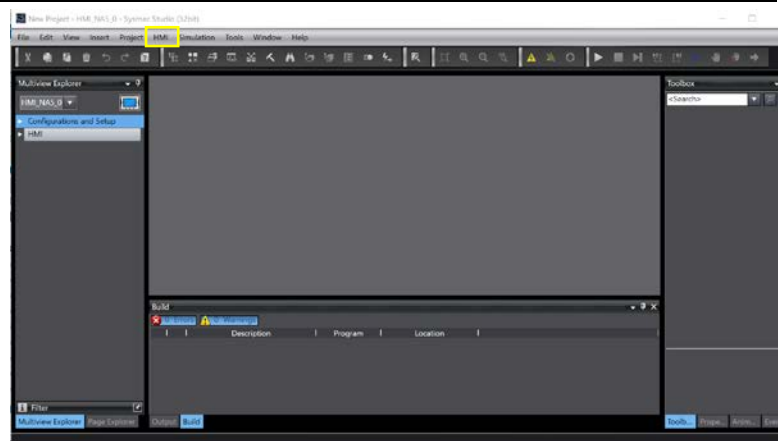

5. The Communications Setup Dialog Box is displayed.

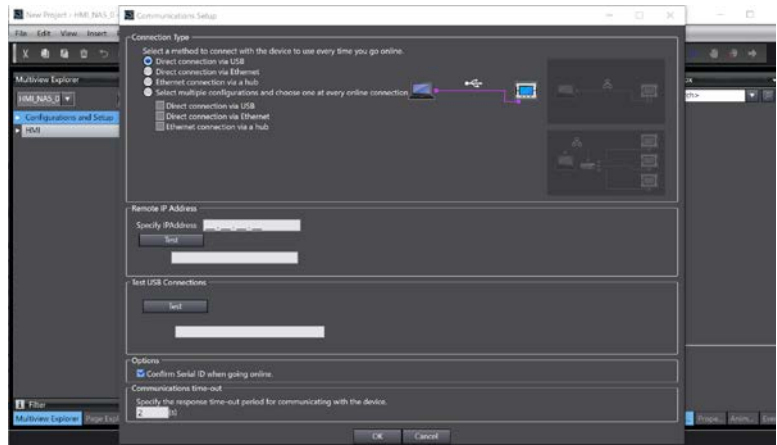

6. Select the connection method for the connection configuration in the Connection Type Field.

*For an Ethernet connection via a hub, enter the IP address of the HMI to which you need to connect in the Remote IP Address Area.

Press the **Test** Button. If “Test OK” is displayed, online connection is possible.

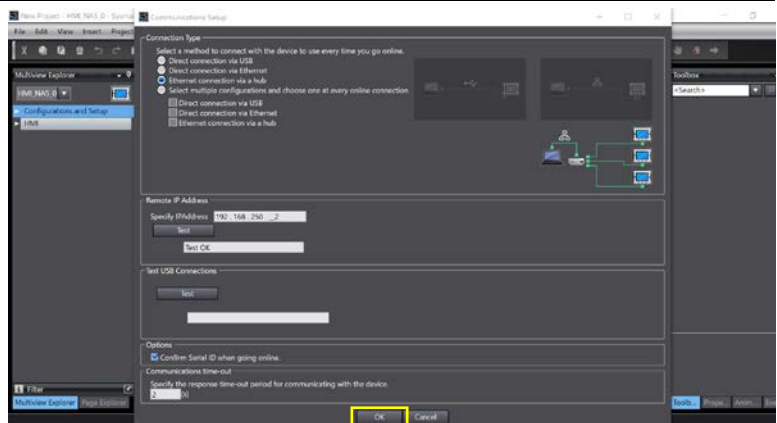

7. Click the **Online** Button in the toolbar. Or, select **Online** from the **HMI Menu**.

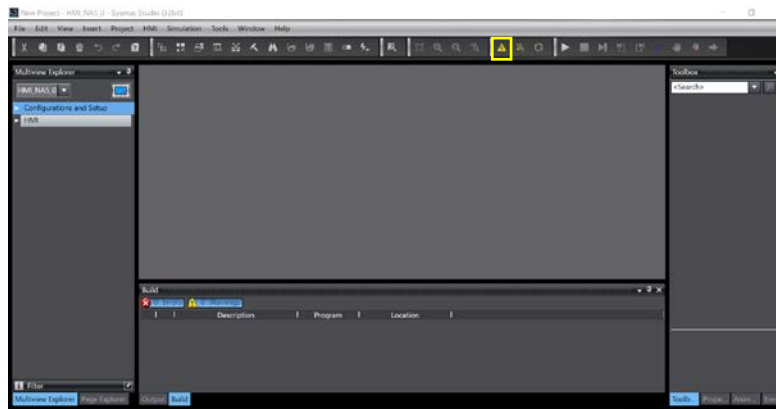

8. <Additional Information> The message **Name / Serial ID does not match** is displayed on the dialog. Click the **Yes** Button.

*The message **Operating System Version Mismatched** is displayed when the version selected in Step 3 is not correct. Check the version of the device and change the settings.

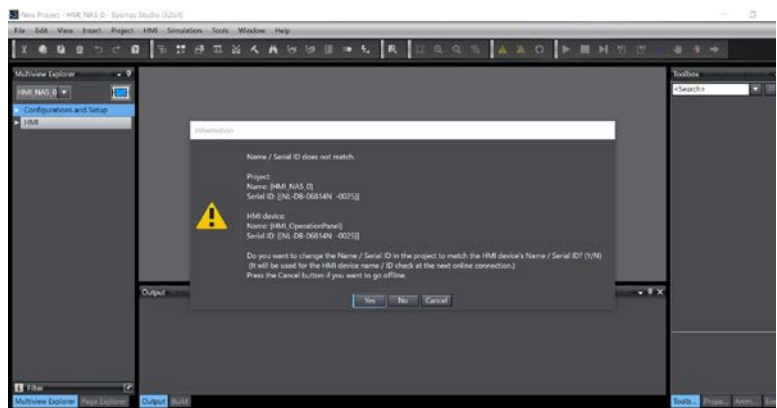

9. The Sysmac Studio goes online and the color of the bar under the toolbar changes to yellow. Then, click the **Synchronization** icon. Or, select **Synchronization – NA Device** from the **HMI Menu**.

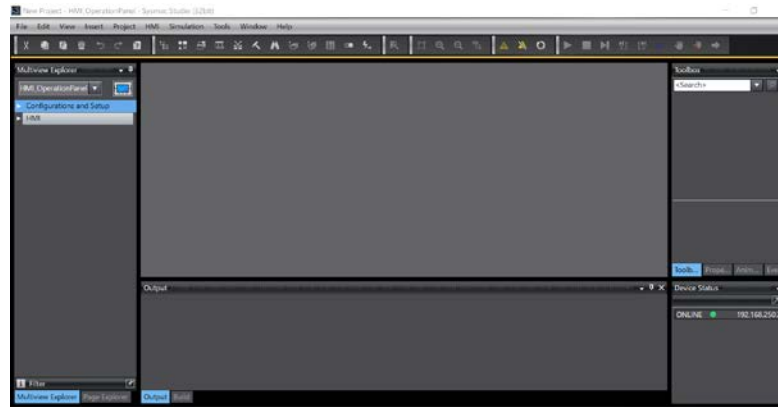

10. The project on the Sysmac Studio is compared with the project in the HMI and the Synchronization Window is displayed.

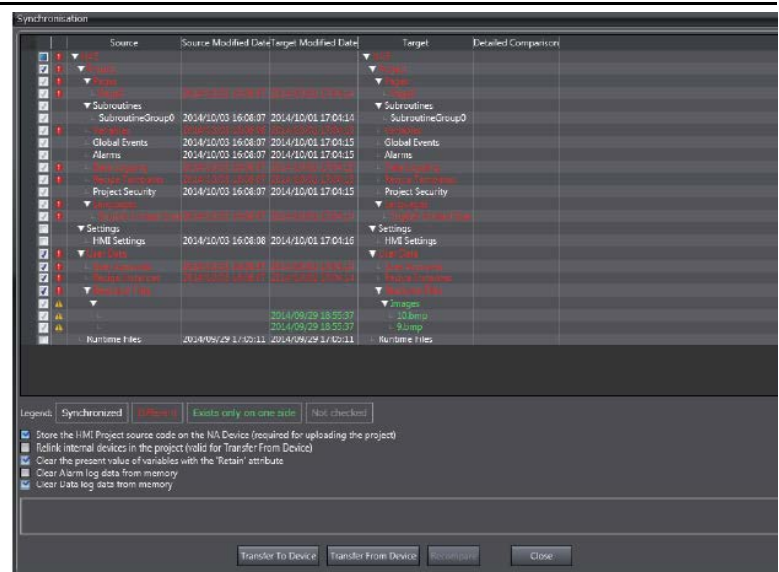

11. Select the items to upload.
 *If you want to send all files, deselect only the Runtime files.
 *Deselect the item below before uploading, otherwise uploading will fail.
 - Runtime files

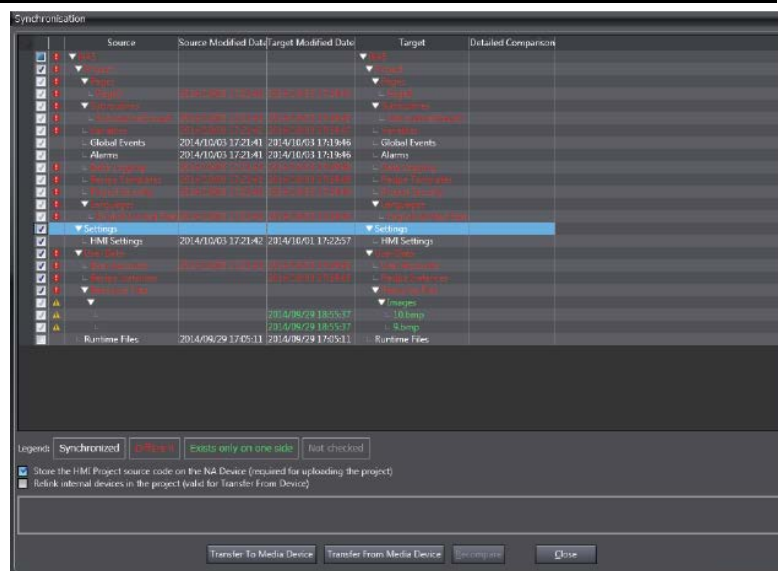

12. Click the **Transfer From Device** Button.

13. The message **The project will be overwritten. Do you want to continue?** is displayed. Click the **Yes** Button.

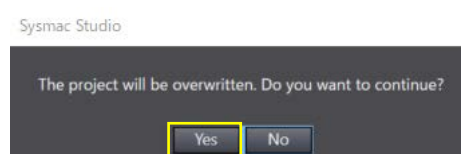

14. The message **Do you want to reflect default value to the project?** is displayed on the dialog. Click the **Yes** Button.

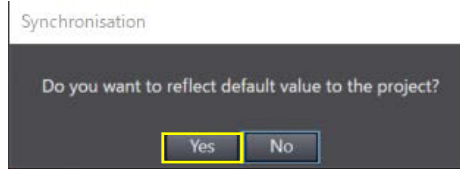

15. When synchronization completes, click the **Close** Button.

*Go to No.16, if you are exporting the NA5 project.
If you do not need to export the project, go to *4-2-3 Converting the project for NA5-V1*. Export operation is performed to save the NA5 project.

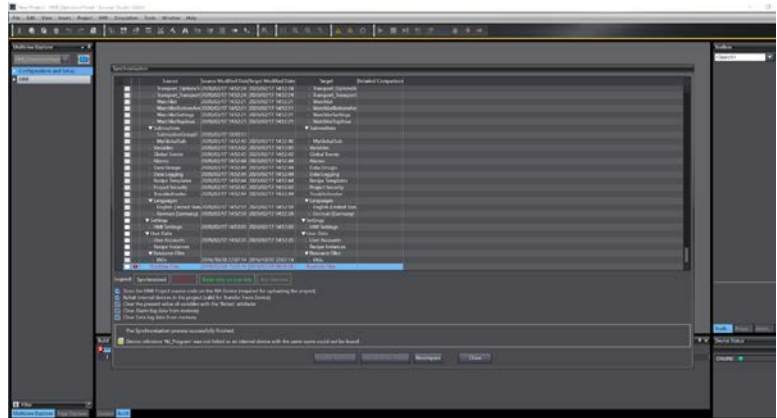

16. Click the **Offline** Button in the toolbar. Or, select **Offline** from the **HMI** Menu.

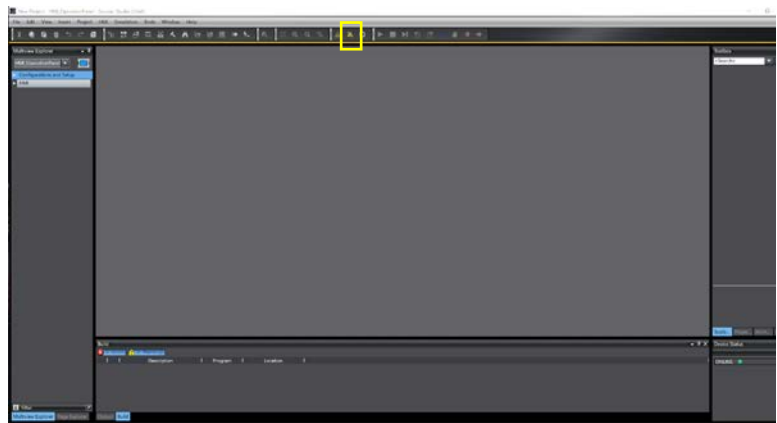

17. Select **Save As** from the **File** Menu.

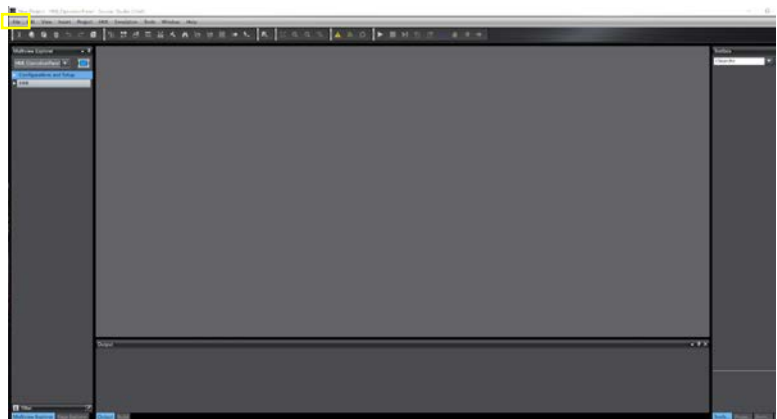

18. Input the project name, and then click the **Save** Button.

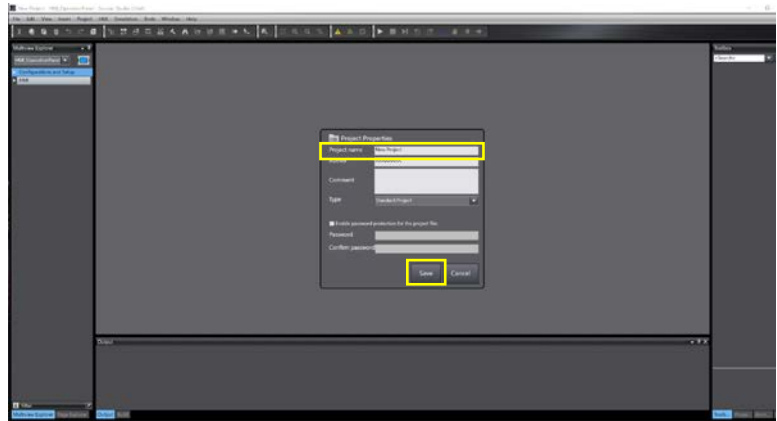

19. Select **Export** from the **File** Menu.

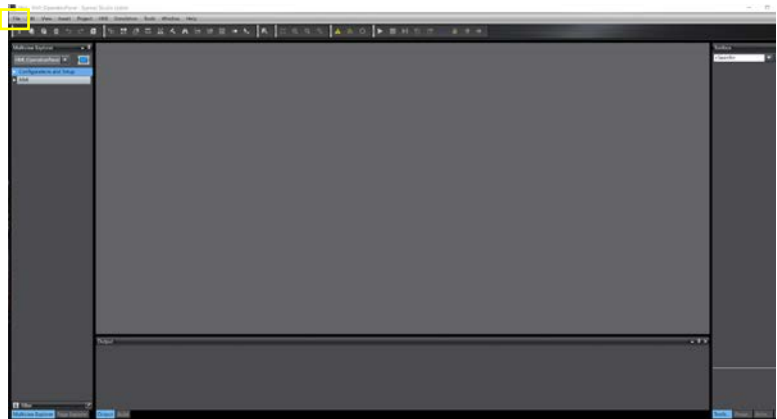

20. Specify export destination, input the file name, and then click the **Save** Button. The file is saved in the specified folder.

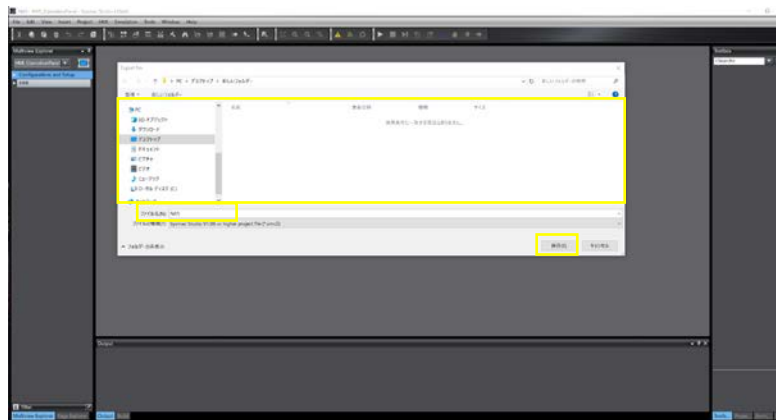

Go to 4-2-3 *Converting the project for NA5-V1.*

4-2-3 Converting the project for NA5-V1

1. While the Sysmac Studio is in offline state and the uploaded project is opened, right-click the NA5 Icon and select **Change Device** from the menu.

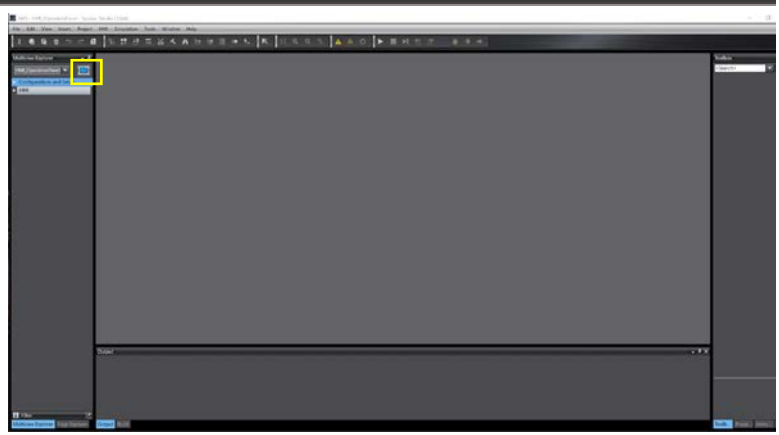

2. Select NA5-V1 device model and version, and then click the **OK** Button.
*The project data cannot be converted to lower device versions.

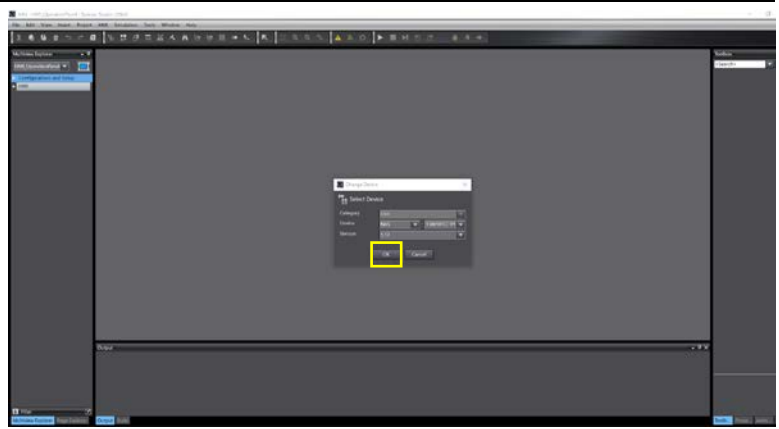

3. The warning message is displayed. Click the **OK** Button.
*This message is displayed when the device version is updated.

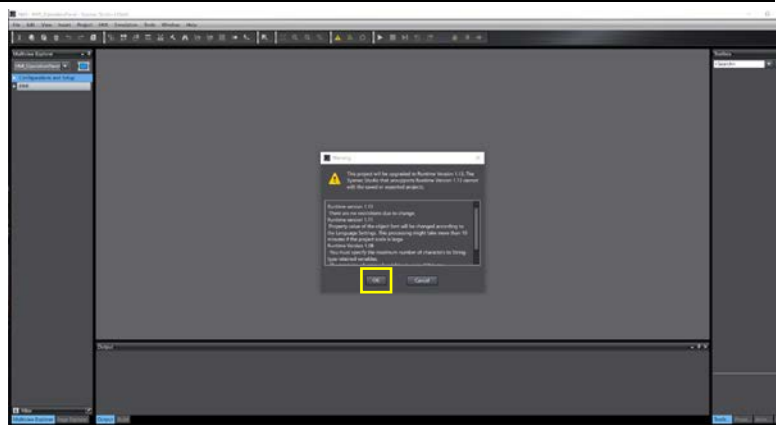

4. The warning message is displayed. Click the **OK** Button.
*This message is displayed when the device version is updated.
*Go to No.5, if you are exporting the NA5-V1 project. Go to 4-3 *Removing the currently installed NA5* if you do not have to export the project.
Export operation is performed

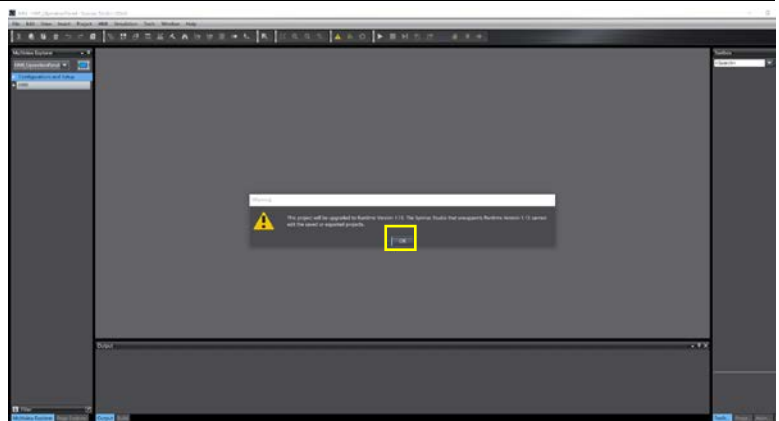

to save the NA5-V1 project.

5. Select **Save As** from the **File** Menu.

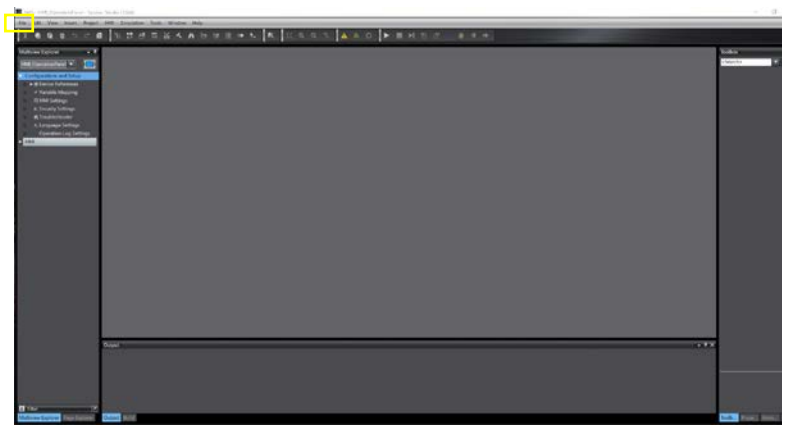

6. Input the project name, and then click the **Save** Button.

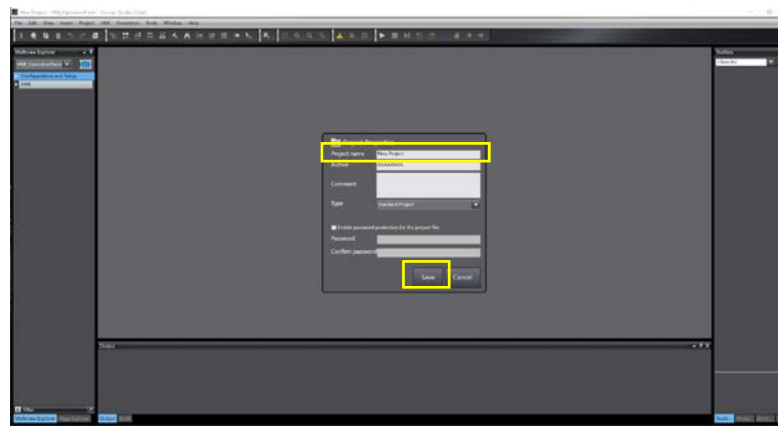

7. Select **Export** from the **File** Menu.

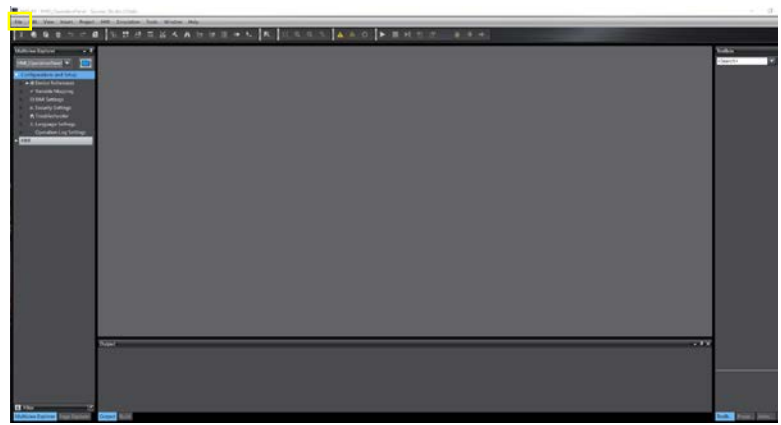

8. Specify export destination, input the file name, and then click the **Save** Button. The project file is saved in the specified folder.

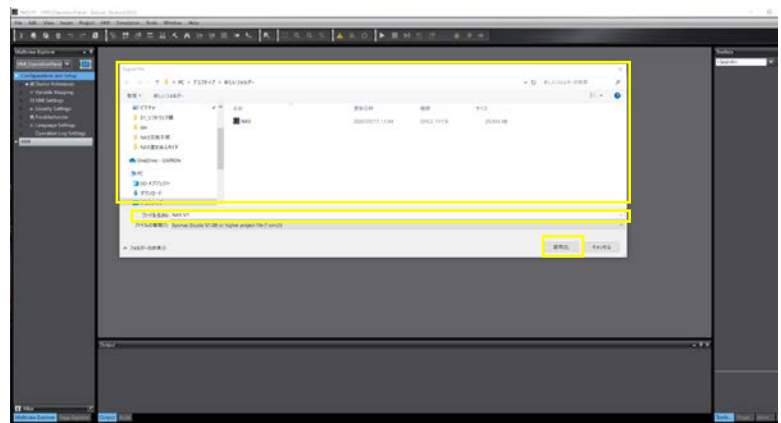

9. Go to 4-3 *Removing the currently installed NA5.*

4-3 Removing the currently installed NA5

4-3-1 Turning OFF the power to the currently installed NA5

Turn OFF the 24V DC power supply to the NA5.

4-3-2 Removing all cables

Remove all the cables connected to the NA5.

4-3-3 Removing the storage devices (if used)

Remove the USB memory and SD memory card.

4-3-4 Removing the currently installed NA5 from the operation panel

Remove the currently installed NA5 from the operation panel.

4-4 Installing NA5-V1

4-4-1 Installing the NA5-V1 to the operation panel

Mount the NA5-V1 to the operation panel using panel mounting brackets and a screwdriver.

4-4-2 Ground wiring

1) Protective ground

Protective grounding is done to ensure safety. It is intended to prevent electrical shock by holding the electrical potential at the grounding potential that is generated by factors such as leakage, induction, or failure. Be sure to ground to 100 Ω or less without mistake.

- Applicable Wire

Conductor cross-section
2.00 mm ² min.

- Screw Tightening Torque

1.0 to 1.2 N·m

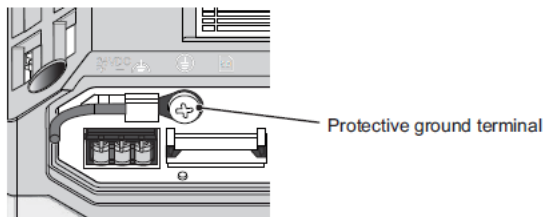

2) Functional grounding

Functional grounding is done to protect device and system functions, including prevention of noise from external sources, or prevention of noise from devices or equipment that could have harmful effects on other devices or equipment. Sufficiently check the circumstances before grounding.

- Applicable Wire

Size	Conductor cross-section
AWG #12 to 22	0.35 to 3.31 mm ²

- Screw Tightening Torque

0.5 to 0.6 N·m

- Power Supply Connector

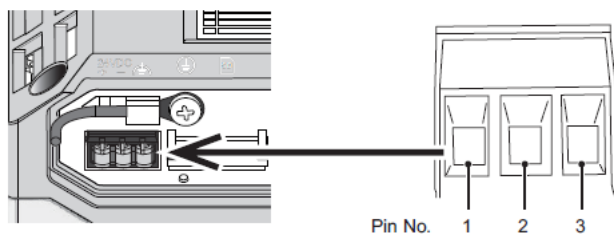

Pin No.	Signal name	Name
1	+24 V	+24-V input
2	0 V	0 V
3	FG	Functional ground

3) Ground wiring

Perform ground wiring as shown in the figure below.

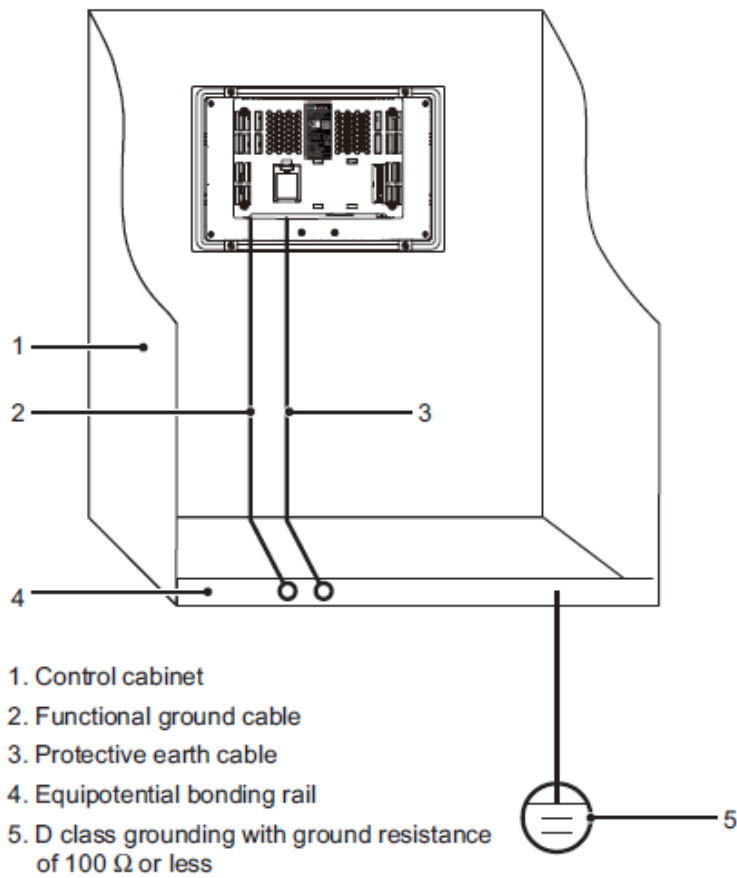

4) NA5-V1 internal grounding connection diagram

Refer to the diagram below and wire the ground terminals giving enough consideration.

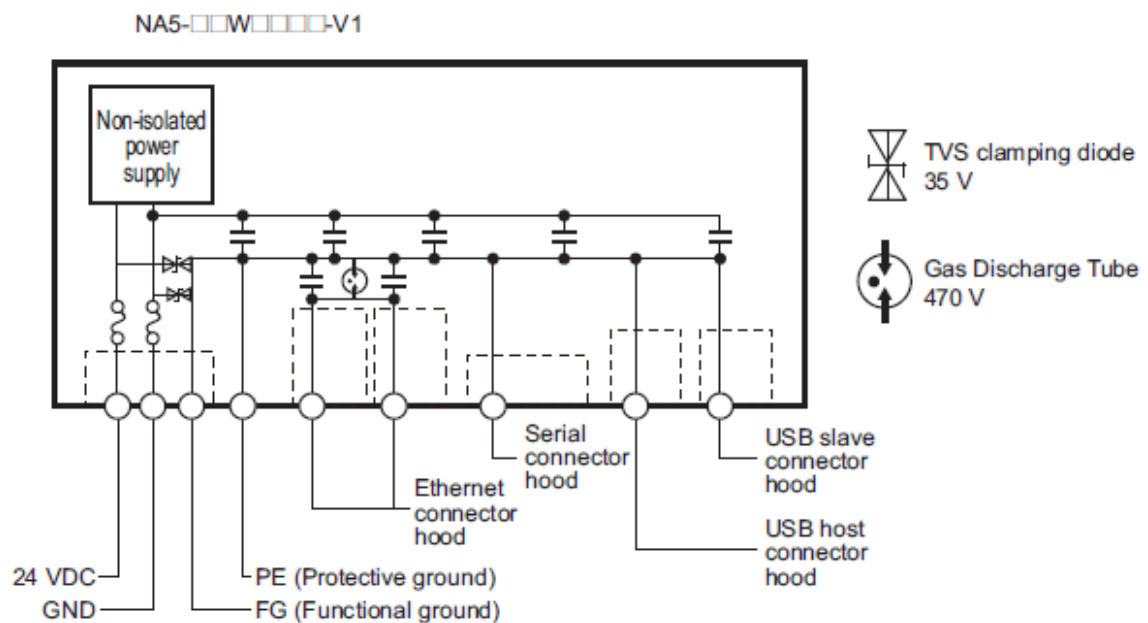

4-4-3 Wiring the cables

Connect all the cables for the NA5.

4-4-4 Installing the storage devices (if necessary)

Install the USB memory and SD memory card.

4-5 Start-up

4-5-1 Turning ON the power to the NA5-V1

Turn ON the 24V DC power supply to the NA5-1.

4-5-2 Downloading the project to the NA5-V1

1. Select **Communications Setup** from the HMI Menu, while the project converted for the NA5-V1 is opened.

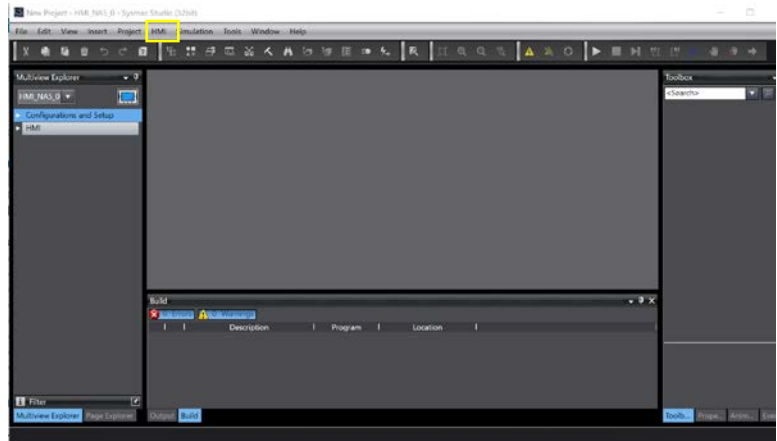

2. The Communications Setup Dialog Box is displayed.

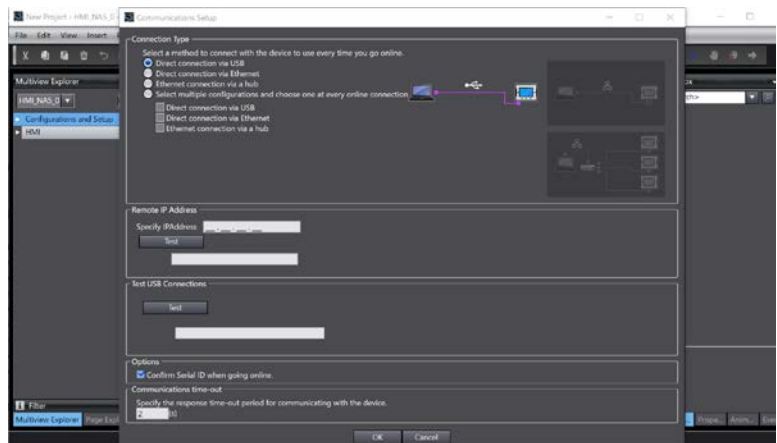

3. Select the connection method for the connection configuration in the Connection Type Field, and then click the **OK** Button.

*For an Ethernet connection via a hub, enter the IP address of the HMI to which you need to connect in the Remote IP AddressArea.
(Default;192.168.250.2)
Press the **Test** Button.
If Test OK is displayed, online connection is possible.

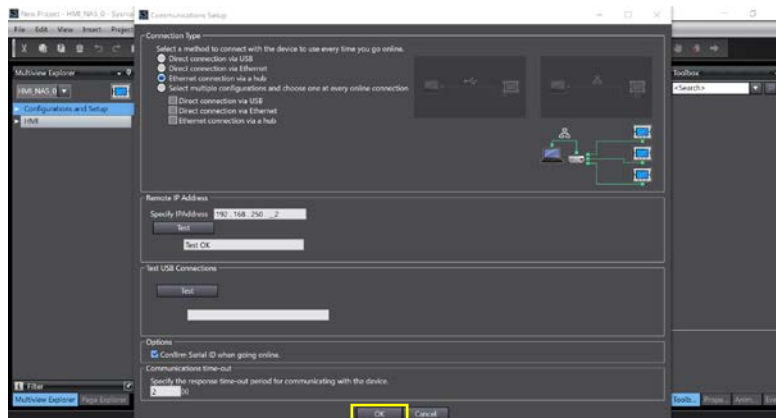

4. Click the **Online** Button in the toolbar. Or, select **Online** from the **HMI Menu**.

*If supported versions of the transfer source (Runtime) and destination (OS) do not match, update the destination version according to the instructions on the dialog box.

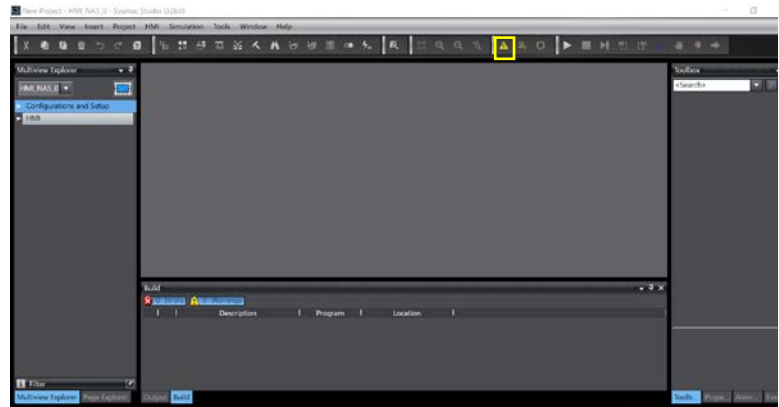

5. <Additional Information> The message **Name / Serial ID does not match** is displayed on the dialog. Click the **Yes** Button.

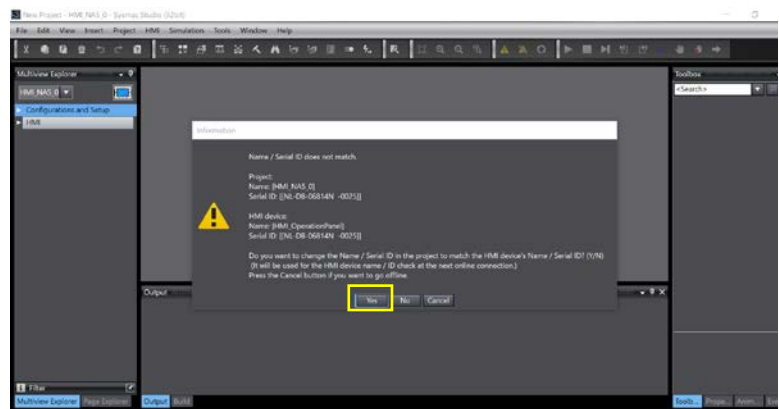

6. The Sysmac Studio goes online and the color of the bar under the toolbar changes to yellow. Then, click the **Synchronization** icon. Or, select **Synchronization – NA Device** from the **HMI Menu**.

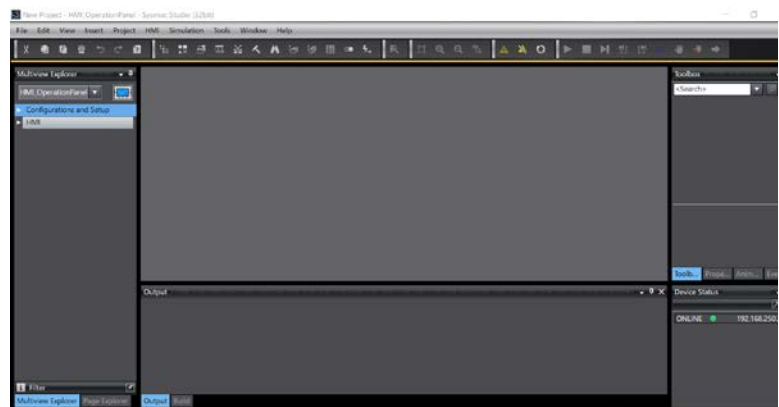

7. The project on the Sysmac Studio is compared with the project in the HMI and the Synchronization Window is displayed.

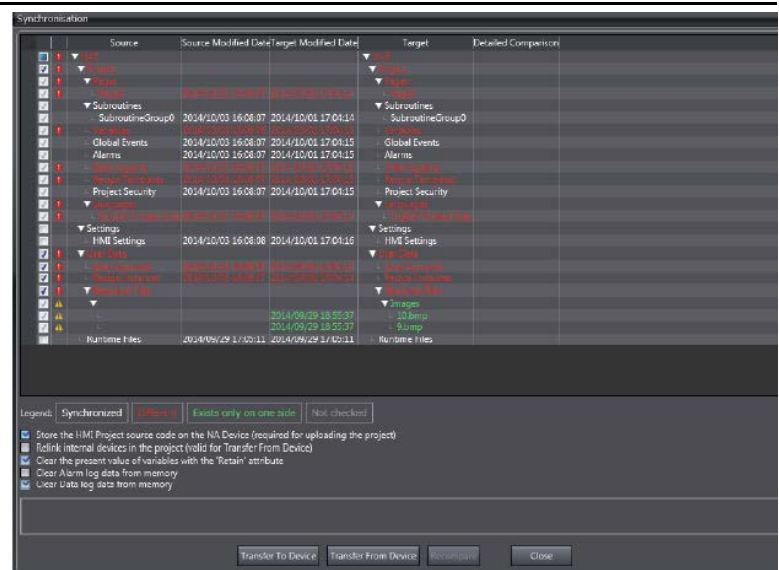

8. Click the **Transfer to Device** Button. The data is downloaded, and the HMI restarts.

4-5-3 Checking the settings and communications

Run the project on the actual system and check that correct values are written to the connected device, the pages change correctly, and values set at the connected device are updated.

4-5-4 Starting operation

Start actual operation.

5 Appendix-1 Transferring project data by using a media device

Even if Sysmac Studio is not available, project files can be transferred by using a media device.

4-2-2 Uploading the project from the existing NA5 -> Go to 5-1-1

4-5-2 Downloading the project to the NA5-V1 -> Go to 5-1-2

These functions are described in the following sections.

5-1-1 Uploading by using a storage media

1. Insert the SD Memory Card or USB memory device to use for the upload into the computer.

2. Display the Device System Menu by touching the corner of the display.
The default positions to touch are the top left and bottom right corners; though you can change the position as you like.

3. Touch the **Transfer Operations** button.

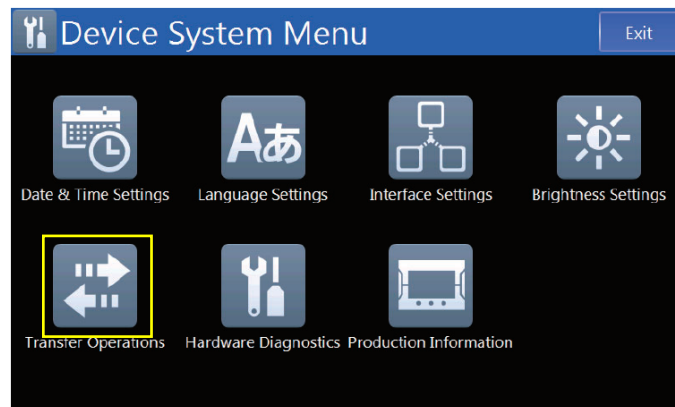

4. Touch the **Transfer User Program From HMI** Button.

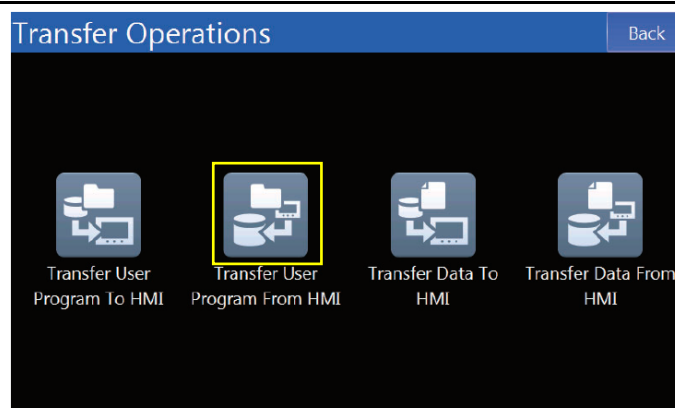

- Specify the destination media and file name and touch the **Transfer from HMI** Button. The project is uploaded to the specified media.

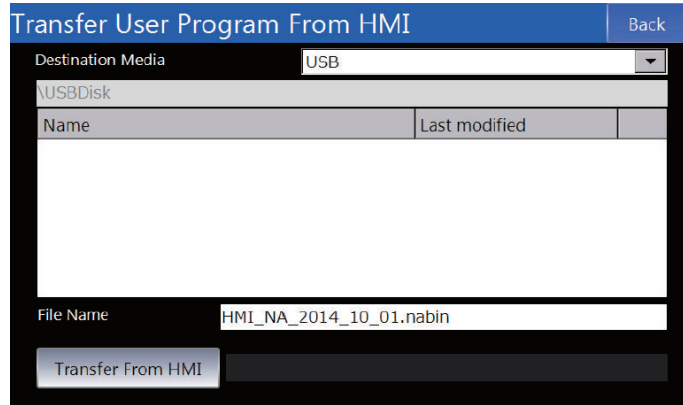

- Remove the media from the NA5.

- Insert the media device to which the project was uploaded to the computer and start the Sysmac Studio.
*Sysmac Studio Ver.1.40 or higher must be installed in the computer.



- When the Sysmac Studio starts, select **New Project**.
* If you relink to the PLC, use an existing PLC project to create a new HMI project.



- In the right dialog box, select HMI for **Category**, NA5 model type for **Device**, and runtime version for **Version**.

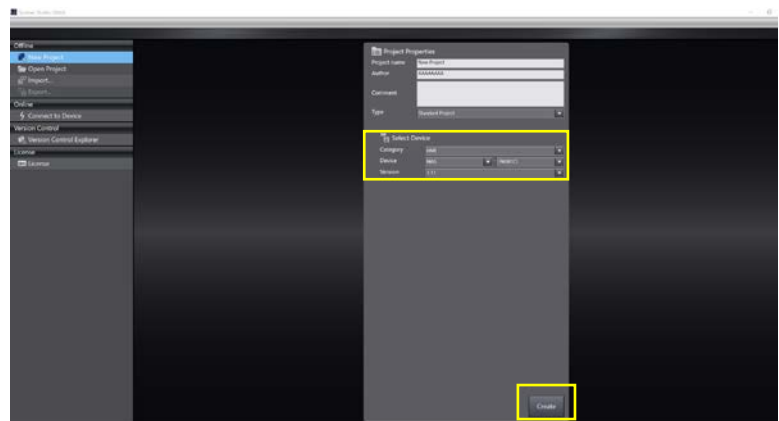

10. Select **Synchronization – Media Device** from the HMI Menu.



11. Specify the name on the media specified for the upload and click the **OK** Button.

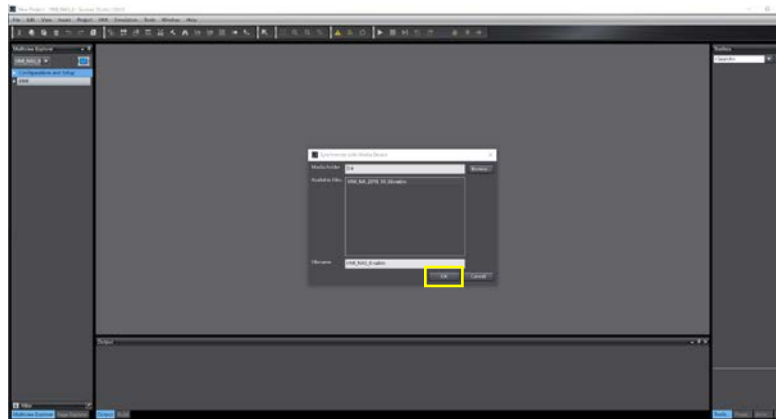

12. Select the items to upload.
 * If you want to send all files, deselect only the Runtime files.
 * Deselect the item below before uploading, otherwise uploading will fail.
 - Runtime files

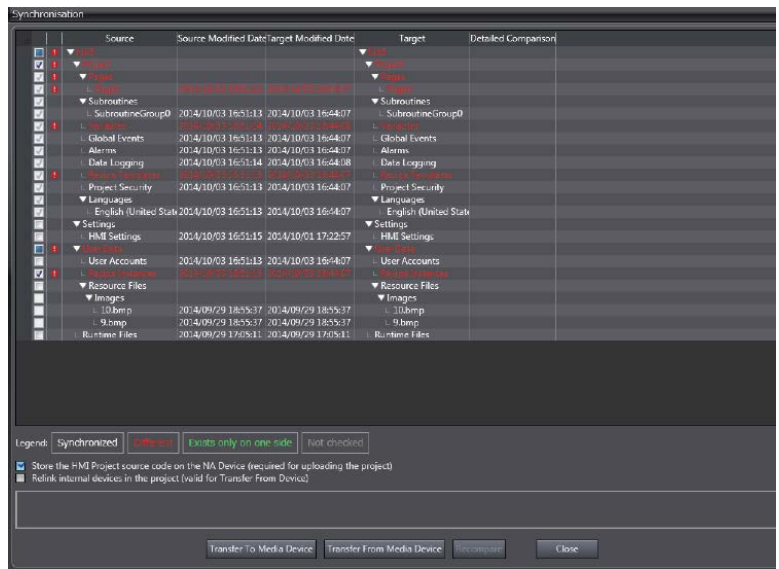

13. Click the **Transfer From Media Device** Button.

14. The message **The project will be overwritten. Do you want to continue?** is displayed. Click the **Yes** Button.

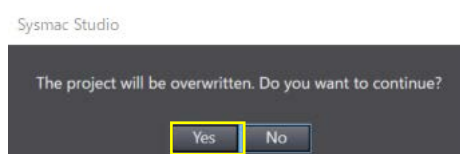

15. The message **Do you want to reflect default value to the project?** is displayed on the dialog. Click the **Yes** Button.

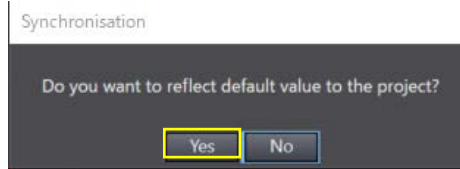

16. When synchronization completes, click the **Close** Button.
Go to 4-2-3 *Converting the project for NA5-V1*

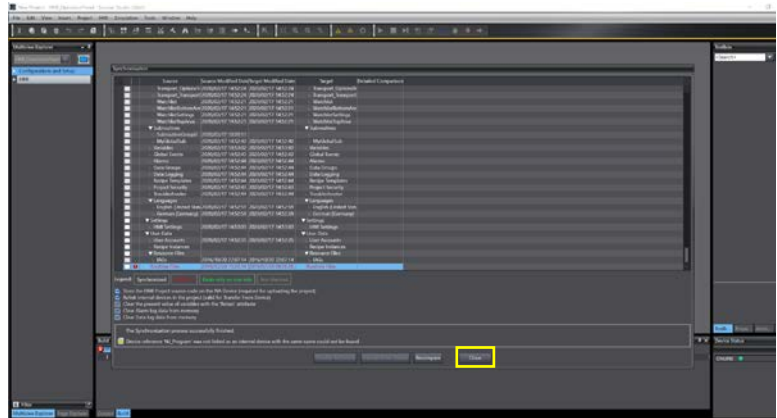

5-1-2 Downloading by using a storage media

1. Insert an SD Memory Card or USB memory device to use for the download into the computer.

2. Select **Synchronization – Media Device** from the **HMI** Menu.

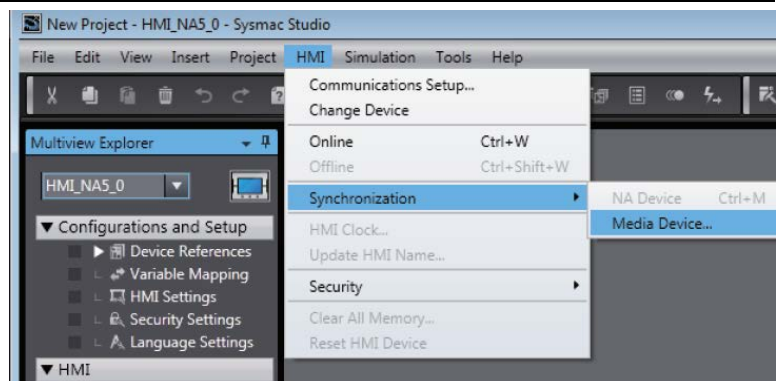

3. Select the file to download and click the **OK** button.

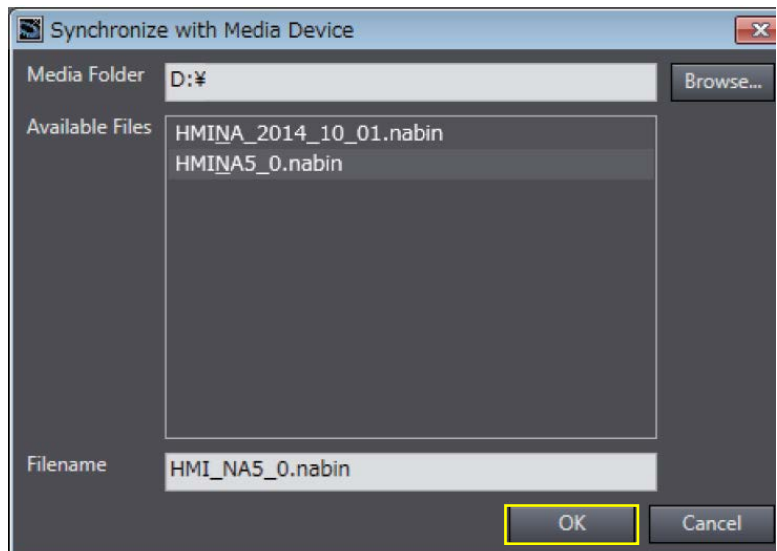

- The project on the Sysmac Studio is compared with the project in the storage media and the Synchronization Window is displayed.

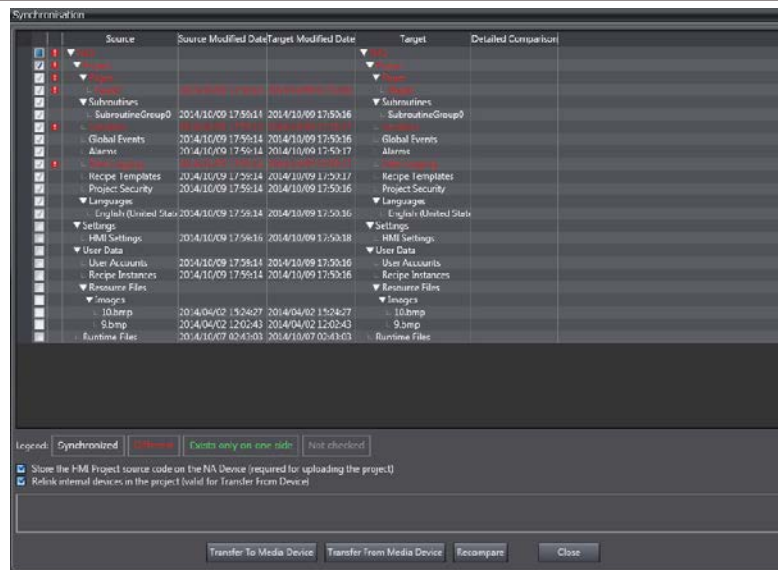

- Click the **Transfer To Media Device** button to transfer the project to the storage media.

- Insert the storage media into the HMI, display the Device System Menu, and touch the **Transfer Operations** Button.

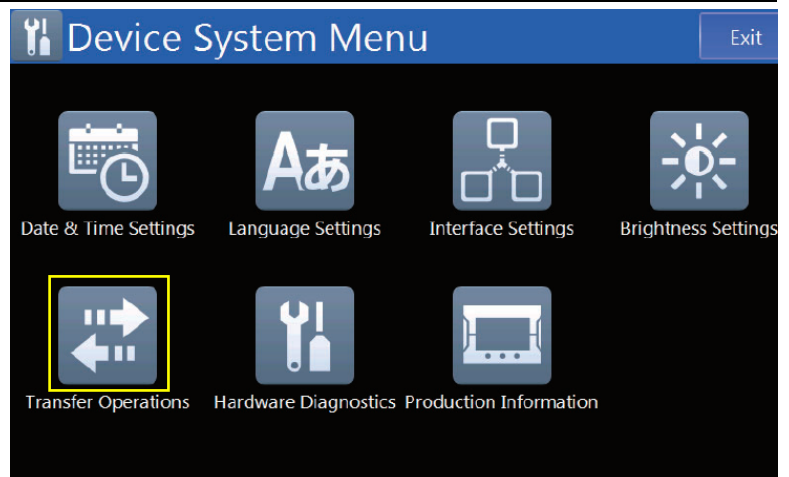

- Touch the **Transfer User Program to HMI** Button.

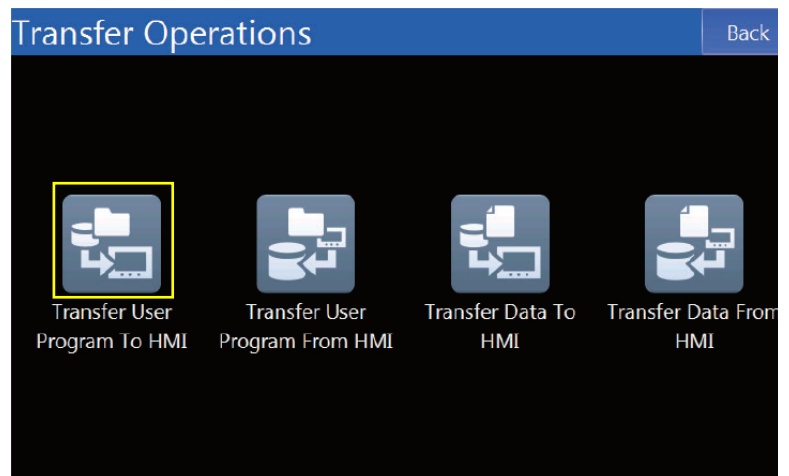

8. Select the project to transfer and touch the **Transfer to HMI** Button. The selected project is downloaded to the HMI.

Move to 4-5-3 *Checking the settings and communications.*

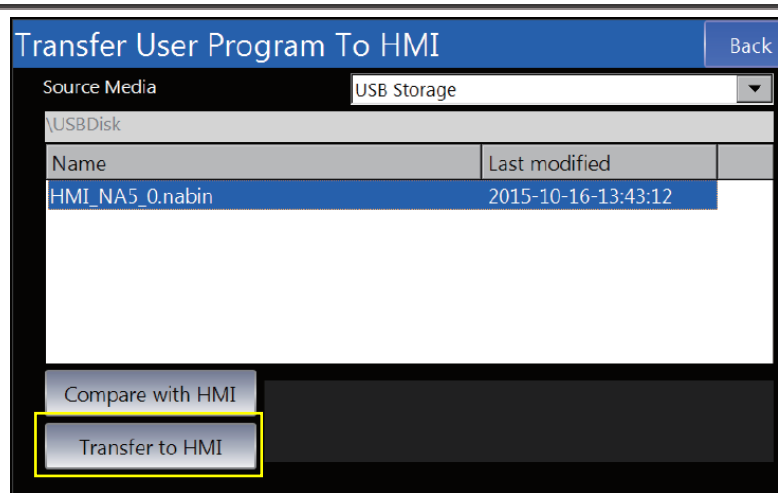

Revision History

Revision History	Date	Revised content
A	March 2020	Original production

OMRON Corporation Industrial Automation Company
Kyoto, JAPAN

Contact: www.ia.omron.com

Regional Headquarters

OMRON EUROPE B.V.

Wegalaan 67-69, 2132 JD Hoofddorp
The Netherlands
Tel: (31)2356-81-300/Fax: (31)2356-81-388

OMRON ELECTRONICS LLC

2895 Greenspoint Parkway, Suite 200
Hoffman Estates, IL 60169 U.S.A.
Tel: (1) 847-843-7900/Fax: (1) 847-843-7787

OMRON ASIA PACIFIC PTE. LTD.

No. 438A Alexandra Road # 05-05/08 (Lobby 2),
Alexandra Technopark,
Singapore 119967
Tel: (65) 6835-3011/Fax: (65) 6835-2711

OMRON (CHINA) CO., LTD.

Room 2211, Bank of China Tower,
200 Yin Cheng Zhong Road,
PuDong New Area, Shanghai, 200120, China
Tel: (86) 21-5037-2222/Fax: (86) 21-5037-2200

Authorized Distributor:

© OMRON Corporation 2020 All Rights Reserved.
In the interest of product improvement,
specifications are subject to change without notice.

Cat. No. V461-E1-01

0320 (0320)