

## **NS-Series**

**NS15-TX01[]-V2**

**NS12-TS0[](B)-V1/V2**

**NS10-TV0[](B)-V1/V2**

**NS8-TV0[](B)-V1/V2**

**NS8-TV1[](B)-V1**

**NS5-SQ0[](B)-V1/V2, NS5-SQ1[](B)-V2**

**NS5-TQ0[](B)-V2, NS5-TQ1[](B)-V2**

**NS5-MQ0[](B)-V2, NS5-MQ1[](B)-V2**

# **Programmable Terminals**

## **HOST CONNECTION MANUAL**

**OMRON**

# Notice

---

OMRON products are manufactured for use according to proper procedures by a qualified operator and only for the purposes described in this manual.

The following conventions are used to indicate and classify precautions in this manual. Always heed the information provided with them. Failure to heed precautions can result in injury to people or damage to property.

- ! DANGER** Indicates an imminently hazardous situation which, if not avoided, will result in death or serious injury.
- ! WARNING** Indicates a potentially hazardous situation which, if not avoided, could result in death or serious injury.
- ! Caution** Indicates a potentially hazardous situation which, if not avoided, may result in minor or moderate injury, or property damage.

## OMRON Product References

All OMRON products are capitalized in this manual. The word "Unit" is also capitalized when it refers to an OMRON product, regardless of whether or not it appears in the proper name of the product.

The abbreviation "Ch," which appears in some displays and on some OMRON products, often means "word" and is abbreviated "Wd" in documentation in this sense.

The abbreviation "PLC" means Programmable Controller.

The abbreviation "host" means a controller, such as an IBM PC/AT or compatible computer, that controls a PT (Programmable Terminal).

## Visual Aids

The following headings appear in the left column of the manual to help you locate different types of information.

- Note** Indicates information of particular interest for efficient and convenient operation of the product.
- Reference** Indicates supplementary information on related topics that may be of interest to the user.
- 1, 2, 3...** 1. Indicates lists of one sort or another, such as procedures, checklists, etc.
- CS1G-CPU [] []-VI** Boxes in model numbers indicate variable characters. For example, "CS1G-CPU [][]-EV1" indicates the following models: CS1G-CPU42-EV1, CS1G-CPU43-EV1, CS1G-CPU44-EV1, and CS1G-CPU45-EV1.

## © OMRON, 2008

All rights reserved. No part of this publication may be reproduced, stored in a retrieval system, or transmitted, in any form, or by any means, mechanical, electronic, photocopying, recording, or otherwise, without the prior written permission of OMRON.

No patent liability is assumed with respect to the use of the information contained herein. Moreover, because OMRON is constantly striving to improve its high-quality products, the information contained in this manual is subject to change without notice. Every precaution has been taken in the preparation of this manual. Nevertheless, OMRON assumes no responsibility for errors or omissions. Neither is any liability assumed for damages resulting from the use of the information contained in this publication.

# Contents

Notice .....	1
About this Manual .....	3
Related Manuals .....	4
Terminology .....	5
Introduction .....	6

## Section 1 Possible Combinations

- 1-1List of combinations
- 1-2CX-Designer and System Program version

## Section 2 Connection of Temperature Controller

- 2-1Outline
- 2-2Possible combinations
- 2-3Configuration
- 2-4Setting projects
- 2-5Monitor variables area in temperature controller
- 2-6Operation of temperature controller
- 2-7Functional restrictions

## Section 3 Connection via Memory Link

- 3-1How does Memory Link work
- 3-2Settings
- 3-3Communications procedures
- 3-4What has been changed since NT31/631

# About this Manual

---

---

## Section 1 Possible Combinations

This section provides information of possible combination of CX-Designer and system program when making connection with PT and host other than OMRON PLCs.

---

## Section 2 Connection of Temperature Controller

This section provides information on connection methods and communications setting in connecting NS-series PTs with a Temperature Controller by serial port. It also provides information Temperature Controller which can be connected to the PT.

---

## Section 3 Connection via Memory Link

This section describes information on connection methods and communication setting in connecting NS-series PTs with a host by Memory Link.

---

**WARNING**

Failure to read and understand the information provided in this manual may result in personal injury or death, damage to the product, or product failure. Please read each section in its entirety and be sure you understand the information provided in the section and related sections before attempting any of the procedures or operations given.

# Related Manuals

---

The following manuals are used for NS-series PTs. (The boxes at the end of the catalog numbers indicate the revision code.)

## NS Series -V1/-V2 Host Connection Manual ..... V085-E1-[]

Provides information on NS Series V1/V2 models (i.e., NS15- V2, NS12-V1/V2, NS10-V1/V2, NS8-V1/V2, and NS5-V1/V2).

Describes how to connect the PT to the host and peripheral devices, methods to setup communications and operation, and procedures for maintenance.

Refer to the *NS Series Programming Manual* (V073-E1-[]) for information on PT functions and specific operating procedures.

## NS Series -V1/-V2 Setup Manual ..... V083-E1-[]

Provides information on NS Series V1/V2 models (i.e., NS15- V2, NS12-V1/V2, NS10-V1/V2, NS8-V1/V2, and NS5-V1/V2).

Describes how to connect the PT to the host and peripheral devices, methods to setup communications and operation, and procedures for maintenance.

Refer to the *NS Series Programming Manual* (V073-E1-[]) or CX-Designer Online Help for information on PT functions and specific operating procedures.

## NS Series Setup Manual.....V072-E1-[]

Provides information on existing NS Series models (i.e., NS12, NS10, and NS7).

Describes how to connect the PT to the host and peripheral devices, methods to setup communications and operation, and procedures for maintenance.

Refer to the *NS Series Programming Manual* (V073-E1-[]) for information on PT functions and specific operating procedures.

## NS Series Programming Manual..... V073-E1-[]

Describes the screen configurations, object functions, and host communications for the PT.

# Terminology

---

The following terminology is used in this manual.

PT	In this manual, indicates an NS-series Programmable Terminal.
NS Series	Indicates products in the OMRON NS[ ][ ] Series of Programmable Terminals.
PLC	Indicates a Programmable Controller in the OMRON SYSMAC CS/CJ, C, or CVM1/CV Series of Programmable Controllers.
CS/CJ Series	Indicates Programmable Controllers in the OMRON SYSMAC CS/CJ Series of Programmable Controllers: CS1G, CS1H, CS1G-H, CS1H-H, CJ1G, CJ1M, CJ2H, CJ2M.  In this manual, "CJ1H-H" indicates the CJ1H-CPU[ ][ ]H-R and CJ1H-CPU[ ][ ]H CPU Units. "CJ1H-H-R" is used to indicate only the CJ1H-CPU [ ][ ]H-R CPU Units.
C Series	Indicates products in the OMRON SYSMAC C Series of Programmable Controllers: C200HS, C200HX(-Z), C200HG(-Z), C200HE(-Z), CQM1, CQM1H, CPM1A, CPM2A, CPM2C.
CVM1/CV Series	Indicates products in the OMRON SYSMAC CVM1/ CV Series of Programmable Controllers: CV500, CV1000, CV2000, CVM1
Serial Communications Unit	Indicates a Serial Communications Unit for an OMRON CS/CJ-series PLC.
Serial Communications Board	Indicates a Serial Communications Board for an OMRON CS-series or CQM1H PLC.
Communications Board	Indicates a Communications Board for an OMRON C200HX/HG/HE(-Z) PLC.
CPU Unit	Indicates a CPU Unit in the OMRON SYSMAC CS/CJ, C, or CVM1/CV Series of Programmable Controllers.
CX-Designer	Indicates the OMRON CX-Designer (NS-CXDC1-V[ ]).
Host	Indicates the PLC, IBM PC/AT or compatible computer, or personal computer functioning as the control device and interfaced with the NS-series PT.
Programming Manual	Indicates the <i>NS Series Programming Manual (V073-E1-[ ])</i> .

# Introduction

---

## • Intended Audience

This manual is intended for the following personnel, who must also have knowledge of electrical systems (an electrical engineer or the equivalent).

- Personnel in charge of introducing FA systems into production facilities.
- Personnel in charge of designing FA systems.
- Personnel in charge of installing and connecting FA systems.
- Personnel in charge of managing FA systems and facilities.

## • General Precautions

- The user must operate the product according to the performance specifications described in the operation manuals.
- Do not use the PT touch switch input functions for applications where danger to human life or serious property damage is possible, or for emergency switch applications.
- Before using the product under conditions which are not described in the manual or applying the product to nuclear control systems, railroad systems, aviation systems, vehicles, combustion systems, medical equipment, amusement machines, safety equipment, and other systems, machines and equipment that may have a serious influence on lives and property if used improperly, consult your OMRON representative.
- Make sure that the ratings and performance characteristics of the product are sufficient for the systems, machines, and equipment, and be sure to provide the systems, machines, and equipment with double safety mechanisms.
- This manual provides information for connecting and setting up an NS-series PT. Be sure to read this manual before attempting to use the PT and keep this manual close at hand for reference during installation and operation.

## • Safety Precautions

WARNING

Do not attempt to take the Unit apart and do not touch any internal parts while the power is being supplied. Doing either of these may result in electrical shock.



## • Operating Environment Precautions

1. Do not install the Unit in the following places:
  - Locations subject to direct sunlight
  - Locations subject to temperatures or humidity outside the range specified in the specifications
  - Locations subject to condensation as the result of severe changes in temperature
  - Locations subject to corrosive or flammable gases
  - Locations subject to dust (especially iron dust) or salts
  - Locations subject to exposure to water, oil, or chemicals
  - Locations subject to shock or vibration
2. Take appropriate and sufficient countermeasures when installing systems in the following

locations:

- Locations subject to static electricity or other forms of noise
- Locations subject to strong electromagnetic fields
- Locations subject to possible exposure to radioactivity
- Locations close to power supplies

## ● Application Precautions

1. When unpacking the Units, check carefully for any external scratches or other damage. Also, shake the Units gently and check for any abnormal sound.
2. The mounting panel must be between 1.6 and 4.8 mm thick. Tighten the Mounting Brackets evenly to a torque of between 0.5 and 0.6 N·m to maintain water and dust resistance. Make sure the panel is not dirty or warped and that it is strong enough to hold the Units.
3. Do not let metal particles enter the Units when preparing the panel.
4. If conformance to EC Directives (Low Voltage Directive) is required, use reinforced insulation for the power supplies.
5. Do not connect an AC power supply to the power terminals.
6. Use a DC power supply with minimal fluctuation voltage.  
Rated power supply voltage: 24 VDC  
(Allowable range: 20.4 to 27.6 VDC)  
Capacity: 25 W min.
7. Do not perform a dielectric voltage test.
8. Use a twisted-pair cable with a cross-sectional area of at least 2 mm<sup>2</sup> to connect to the power terminals and always use M3.5 crimp terminals. Tighten the terminal screws to a torque of 0.8 N·m. Make sure the screws are properly tightened.
9. Ground the Unit correctly to prevent operational errors caused by noise.
10. Do not touch the surface of the circuit board or the components mounted on it with your bare hands. Discharge any static electricity from your body before handling the board.
11. Confirm that the current capacity of the connected device is 250 mA or less before using the 5-V power supply from pin 6 of the serial port A, B connectors. The 5-V output of the PT is 250 mA max. at 5 V ±5%.
12. Turn OFF the power supply before connecting or disconnecting cables.
13. Always tighten the connector screws after connecting communications cables.
14. The maximum tensile load for cables is 30 N. Do not apply loads greater than this.
15. Confirm the safety of the system before turning ON or OFF the power supply or before pressing the reset button.
16. The whole system may stop depending on how the power supply is turned ON or OFF. Turn ON or OFF the power supply according to the specified procedure.
17. Start actual system application only after sufficiently checking screen data, macros, and the operation of the program in the PC (host).
18. Always reset the power supply after changing switch settings.
19. After changing the settings of the DIP switch, always turn the power supply OFF and ON or reset the PT.
20. Do not perform the following operations while the Memory Card is being accessed:
  - Turning OFF the power supply to the PT
  - Pressing the PT's reset switch
  - Removing the Memory CardAlways following the specified procedure when removing the Memory Card.
21. Do not press the touch switch with a force greater than 30 N.
22. Confirm the safety of the system before pressing touch switches.
23. Do not accidentally press touch switches when the backlight is not lit or when the display does not appear.
24. Signals from the touch switches may not be input if the switches are pressed



- consecutively at high speed. Confirm each input before proceeding to the next one.
25. Before initializing screen data, confirm that existing data is backed up at the CX-Designer.
  26. When changing the password with the system menu, do not reset or turn OFF the power supply until writing is finished (i.e., until the Write Button returns to its original condition). It may become impossible to manipulate screens if the password is not set correctly.
  27. When using the device monitor, confirm the safety of the system before performing the following operations.
    - Changing monitor data
    - Changing operation modes
    - Forced setting or resetting
    - Changing present values or set values
  28. Do not use benzene, paint thinner, or other volatile solvents, and do not use chemically treated cloths.
  29. Dispose of any battery that has been dropped on the floor or otherwise subjected to excessive shock.
  30. Do not attempt to disassemble, repair, or modify the Unit in any way.
  31. Dispose of the Units and batteries according to local ordinances as they apply.
  32. To ensure system safety, incorporate a program that periodically calls PT operation bits from the host side to check that the PT is properly operating.
  33. Do not connect an USB connector to any device that is not applicable.
  34. Before connecting an USB connector to a device, make sure that the device is free of damage.
  35. When mounting the Battery, be sure to use the correct Battery and mount it correctly.

## **Section 1**

---

### **Possible combinations**

This section explains in general how to connect hosts other than NS-V1/V2 Series Omron PLC and which models to connect.

1-1List of combinations

1-2CX-Designer and System Program version

## **1-1 List of combinations**

This explains the configuration when host is other than Omron PLCs.

### **1-1-1 Connection of temperature controller**

Communicates with Omron temperature controller via RS-485.

Connect RS-422 converter CJ1W-CIF11 to serial port A or B and set communication mode to RS-485.

For details, refer to 'Chapter 2: connection of temperature controller'.

### **1-1-2 Connection with memory link**

When host other than PLC such as board-controller and personal computer is used, connection via memory link is possible. Use serial port A or B to connect host equipment. For details, refer to 'chapter 3: connection via memory link'.

## **1-2 CX-Designer and System Program versions**

### **1-2-1 CX-Designer versions**

With CX-Designer Ver.1.0 or later version, you can create and edit projects for Temperature Controller connections and Memory Link connections.

### **1-2-2 System Program versions**

System program Ver.5.0 or later.

A copy of this version is included CX-Designer.

NS Series V1/V2 models (NS15 –V2, NS12/10/8/5 –V1/V2), and NSJ Series (NSJ12/10/8/5) are supported for those connections.

NS without –V1/V2 suffix models are not supported.

When system program version is earlier than Ver.5.0, you need to upgrade. For details on how to upgrade, refer to the manual (PDF)(How To RecoverUpdate the system) in CX-Designer.

## **Section 2**

---

### **Connection of temperature controller**

This section explains how to connect Omron temperature controllers (E5□N) and digital controllers (E5AR/ER) and which models to connect.

2-1Outline

2-2Possible combinations

2-3Configuration

2-4Setting projects

2-5Monitor variables area in temperature controller

2-6Operation of temperature controller

2-7Functional restrictions

## 2-1 Outline

This explains how to connect temperature controllers.

Connectable are temperature controllers with a RS-485 port.

Use NS serial port A or B (either one), use converter to transform to RS-485.

1 serial port can accommodate max. 31 temperature controllers.

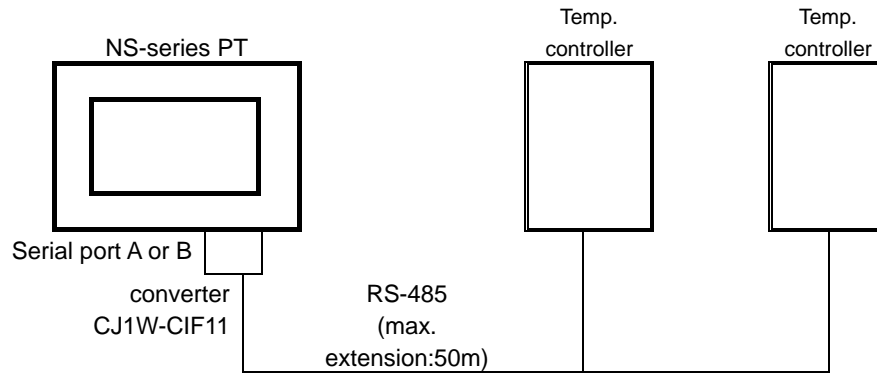

By using another communications port, you can simultaneously connect temperature controllers and a host. With one more serial port, NS can connect PLC, barcode reader, Memory Link and can communicate with CX-Designer.

If NS is equipped with Ethernet port, communications with Omron PLC via Ethernet is possible.

If equipped with Controller Link I/F, communication with Omron PLC via Controller Link is possible.

## 2-2 Possible combinations

### 2-2-1 Connectable temperature controller

Only models with RS-485 communications port that support CompoWay/F can be used.

The following models are connectable:

Name	Series	Model
Temperature controller	E5ZN	E5ZN-SCT24S (terminal unit)
	E5AN	E5AN-□□□03□-FLK
	E5EN	E5EN-□□□03□-FLK
	E5CN	E5CN-□□□03□-FLK
	E5GN	E5GN-□□□03□-FLK
Digital temperature controller	E5AR	E5AR-QC43DB-FLK
		E5AR-QQ43DW-FLK
		E5AR-CC43DWW-FLK
	E5ER	E5ER-QC43B-FLK
		E5ER-PRQ43F-FLK
		E5ER-QT3DW-FLK
		E5ER-CT3DW-FLK

### 2-2-2 Temperature controller Manuals

Manual name	Catalog No.
E5CN/CN-U User's manual	H100-E1
E5GN User's manual	H101-E1
E5□N User's manual Communications functions	H102-E1
E5EN User's manual	H111-E1
E5AN User's manual	H112-E1
E5AR/ER User's manual	Z182-E1

## 2-3 Configurations

### 2-3-1 Necessary parts

■ RS-422A Converter

CJ1W-CIF11

■ Crimp terminal

● CJ1W-CIF11 side communications path terminator

Phoenix Contact	AI Series AI-0.5-8WH-B	(serial No. 3201369)
Crimp tool	ZA3	(serial No. 1201882)

● CJ1W-CIF11 side other than communications path terminator

Phoenix Contact	AI series AI-TWIN2×0.5-8WH	(serial No. 3200933)
Crimp tool	UD6	(serial No. 1204436)

● Temperature controller side

Model	Terminal block screw size	Terminal size
E5CN	M3.5	7.2mm max.
E5GN		
E5EN		
E5AN		
E5ZN	M3	5.8mm max.
E5ER/AR		



## 2-3-2 Wiring diagram

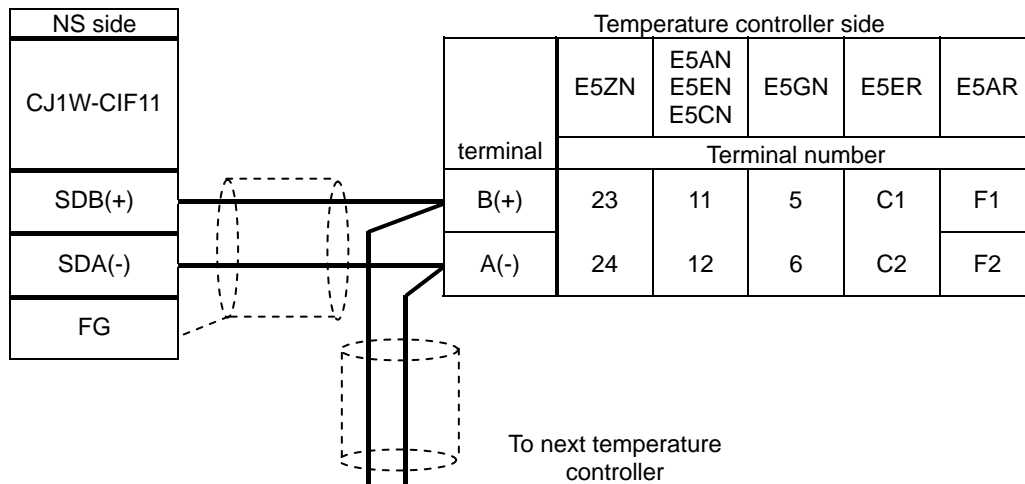

- Connection: 1:1 or 1:N. If 1:N, max. 32 units (NS and temperature controllers combined) can be connected. (in case of E5ZN, the maximum is 16 units).
- Cable length: In total max. 50 m
- Use shielded twist pair cables (min. size AWG28)
- Connect terminating resistance (100 to 125  $\Omega$  (1/2W)) to both ends of the communications path. Furthermore, combined resistance must be 54  $\Omega$  min.

### 2-3-3 Temperature controller communications settings

This summarizes temperature controller communications settings.

For more details on settings and operation procedure of setting specifications, refer to the relevant temperature controller manual.

#### ■ E5ZN

Setup Switch on E5ZN panel			
Unit number	0 to 15	When using multiple E5ZN units, be careful not to use the same number twice.	
Baud rate	0	4800 bps	
	1	9600 bps	
	2	19200 bps	
Communications setting level			
	CH	Value	
Data bits	C3 0013 or C3 0113	7	7 bits
Stop bits	C3 0014 or C3 0114	2	2 bits
Parity	C3 0015 or C3 0115	2	Even (EvEn)
Response Waiting time	C3 0016 or C3 0116	0 to 270FH (0 to 9999)	In ms

#### ■ E5GN/E5AN/E5EN/E5CN/E5ER/E5AR

Adjustment level L.Adj			
Communications writing	CoWt	on	enable
		OFF	disable
Communications setting level L.S			
Baud rate	bPS	2.4 4.8 9.6 19.2 38.4	In kbps Set all communicating temperature controllers to match parameters of NS E5ER/AR: choose between 9.6/19.2/38.4 E5□N: 38.4 cannot be selected.
Data bits	LEn	7	7 bits
Stop bits	Sbit	2	2 bits
Parity	PrtY	EvEn	Even
Response Waiting time	SdWt	0 to 270FH (0 to 9999)	In ms E5AR/ER range: 0 to 63H(0 to 99)
Communications Unit No.	U-no	0 to 31	E5AR/ER only
Protocol select	PSEL	CyF	Compoway/F (E5AR/ER only)

### 2-3-4 CJ1W-CIF11 setting

Dip switch setting

Pin No.	Function	setting	
1	Terminal resistance select ON/OFF	ON	Terminating resistance (on both ends of the communications path)
		OFF	No terminating resistance (other than both ends of the communications path)
2	Switch between 2/4 line system	ON	2 line system
3	Switch between 2/4 line system	ON	
4	Not used	-	
5	RD control by RS select ON/OFF	OFF	
6	SD control by RS Select ON/OFF	ON	RS control function ON

### 2-3-5 NS setting

Before you can connect temperature controllers, you need to store the required project in the NS. For project setting, refer to '2-4 setting project'.

With communications settings under system menu, you can set the speed of communications.

Baud rate	2400 / 4800 / 9600 / 19200 / 38400 / 57600 / 115200	bps
-----------	---	-----

Of these values, 57600 / 115200 are for future use.

Present temperature controllers cannot operate at these rates.

Set PT unit and temperature controller baud rate values to match each other.

## 2-4 Setting Project

With this function, you set projects needed to connect temperature controllers.

Select **PT - Communication Setting**. The Comm. Setting dialogue appears.

1. Select Serial Port A (or Serial Port B) in the left pane, and select Temperature Controller from the pull down menu for Serial Port.

2. Define temperature controller model to be connected from the pull down menu for Type. Selectable models are:

E5ZN, E5A/E/C/GN, or E5A/ER.

3. Select baud rate from the pull down menu for Comm. Speed.

Selectable baud rate values are:

2400 / 4800 / 9600 / 19200 / 38400 / 57600 / 115200 (in bps).

Baud rates 57600 / 115200 are for future use. Present temperature controllers cannot operate at these rates.

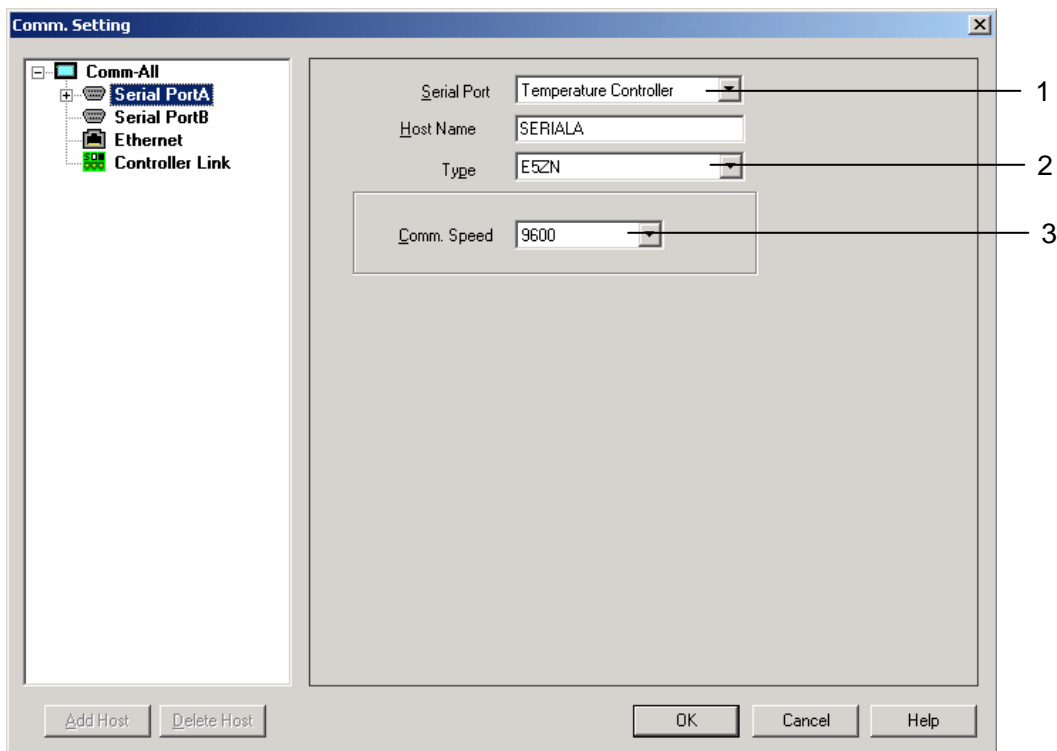

## 2-5 Monitor variables area in temperature controller

### 2-5-1 Variables area in temperature controller

Data stored in variable area of the temperature controller are: Present Value, SP, Heater burnout alarm status and such.

By reading/writing these data from PT, you can monitor temperature controller status.

Values of variables you can display on PT screen as numbers and you can create save the changes of those as log data.

Temperature controller status (variable C0, address 0001) is information on bit level. You can show status by ON/OFF lamp and you can display/save the history log that shows status changes.

Address of variable are in a Temperature Controller should be assigned to the lamps, numeral display and input object, or graphs before monitoring the variable area.

Accessible address ranges vary with temperature controller models.

For details on accessible address ranges and definitions of settable address ranges, numerical values and contact status, refer to the following manuals.

Model	Manual Number	Chapter
E5AN E5EN E5CN E5GN	H102-E1	3
E5ZN	H112-E1	5, 5.10 Variables area map
E5AR E5ER	Z182-E1	Appendix Settings list

CX-Designer shows accessible address range in accordance with the model specified in the Register Host dialog so that user can set an appropriate communication address.

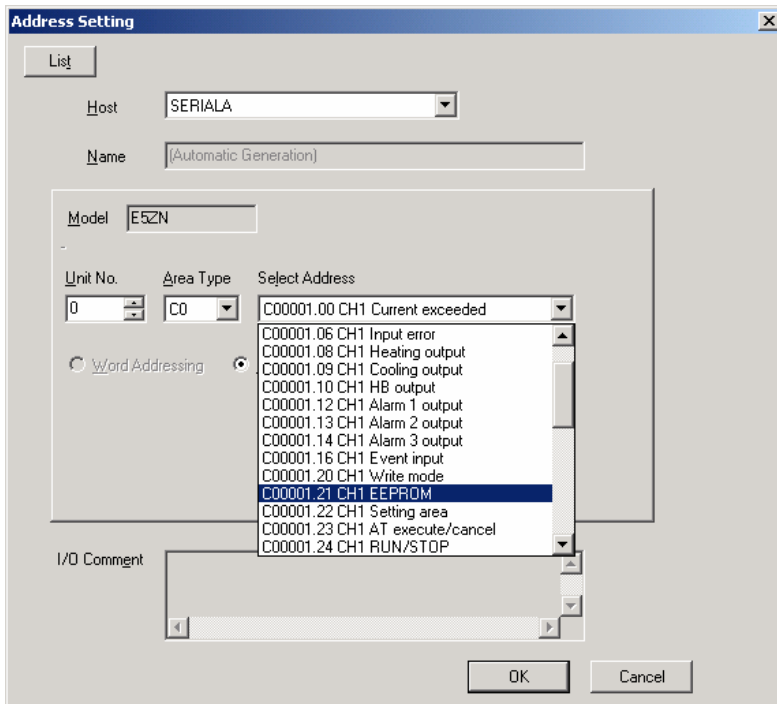

You can also manually enter a communications address, which is not listed without opening Address Setting dialog. In this case, enter the desired address directly to the field shown in the property dialog.

## 2-5-2 Address notation in CX-Designer

Address notation when accessed using word (address for word communications)				
<port>	:	<Communications unit No.>	# <Variable category>	<Channel> <Address>

Address when accessed using bit (address for bit communications)						
<port>	:	<communications unit No.>	# <Variable category>	<channel> <address>	.	<bit position>

Item	Value range & definition	
<Port>	SerialA	Connected to serial port A
	SerialB	Connected to serial port B
<communications unit No. >	00 to 31	
<Variable type>	C0 to D7	
<Channel>	00 to 03	ch1 to ch4
<Address>	variable category	Address range
	C0 to C3	00 to 3F
	C4 to CB	00 to 7F
	CC to D7	00 to 3F
<Pit position>	00 to 31	

Example:

SerialA:24#C4001C	PortA:Unit No.24/area category C4/ch1/address 1CH
SerialB:17#D1036E. 3	PortB:Unit No.17/area D1/ch4/address6EH/bit3

## 2-5-3 Use of double word numbers

Variable area in the Temperature Controller is composed of values in double-word format(32bit length). Negative values are expressed as the two's complement. Therefore, select DINT(signed 2 words) as storage type for the variable, which the decimal value will be stored. Select UDINT(unsigned 2 words) for the variable, which the hexadecimal value will be stored.

## 2-5-4 Communications writing enabled/disabled

Before you can write to variable area in temperature controller, you need to go to the adjustment level and set **Communications writing** on **Enabled: ON**. (Default setting is **Disabled: OFF**).

For monitoring only, so when no writing is carried out, the setting can be either **Disabled: OFF** or **Enabled: ON**.

Use either the panel on the Temperature Controller or Setting Tool to set "Communications Writing" parameter. It can be also set with Smart Active Parts in the PT.

## 2-6 Operation of Temperature Controller

The use of Smart Active Parts, allows you to operate PT screen to change Temperature Controller running conditions and to disable/enable communications writing.

### 2-6-1 How to create a Smart Active Parts part

In CX-Designer, you open the arrange Smart Active Parts screen.

When you select **Tools - Library**, the Library dialogue opens.

Under list of categories, tree of selectable libraries is shown.

Smart Active Parts for temperature controller you can find under **Library -> SAP -> Smart Active Parts\_E -> Temperature Controller**.

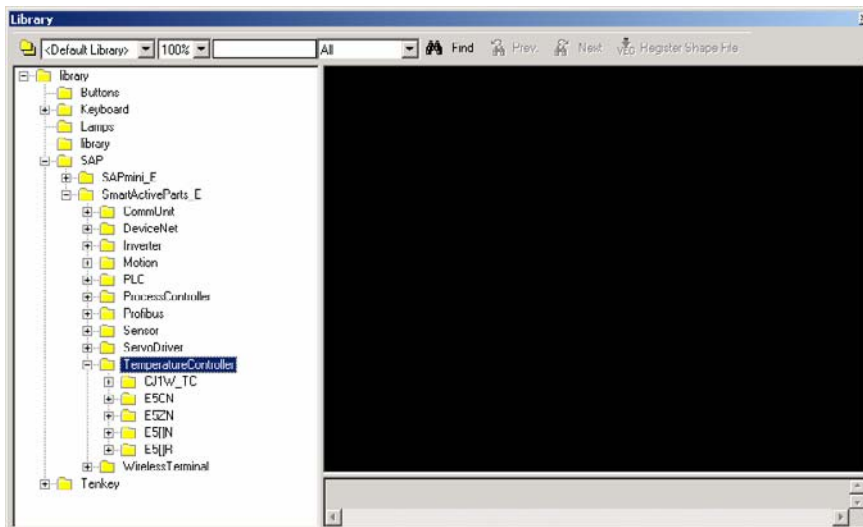

Temperature controller is grouped by model, channel and broadcast. For each operation instruction, a Smart Active Parts part is available.

There are 2 categories: Instructions to the unit itself and broadcast .

When same instruction is given to all units, no results response is sent. For that reason error judgment is omitted.



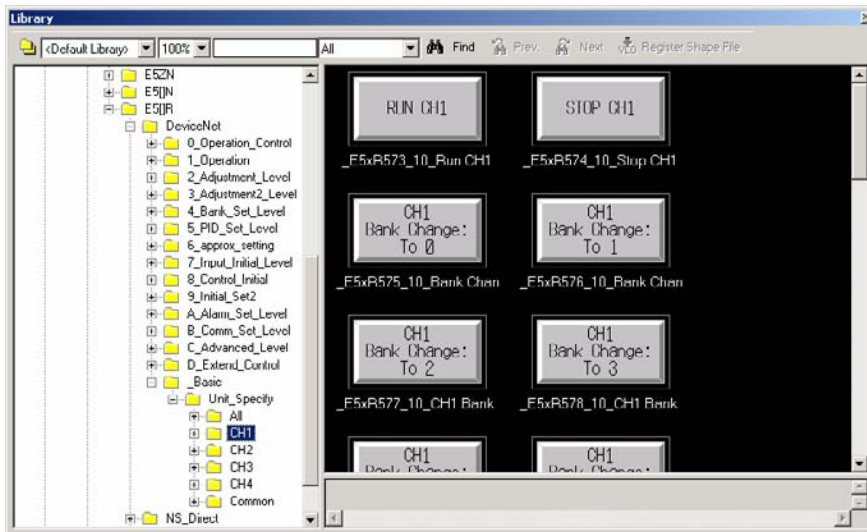

Selectable Smart Active Parts are shown in the preview box on the right. Title of the selected Smart Active Parts is shown below it.

Select appropriate Smart Active Parts and drag & drop it to the screen.

By doing so, the selected Smart Active Parts is pasted onto the screen that is being edited.

Then, double click the Smart Active Parts and set communications parameters.

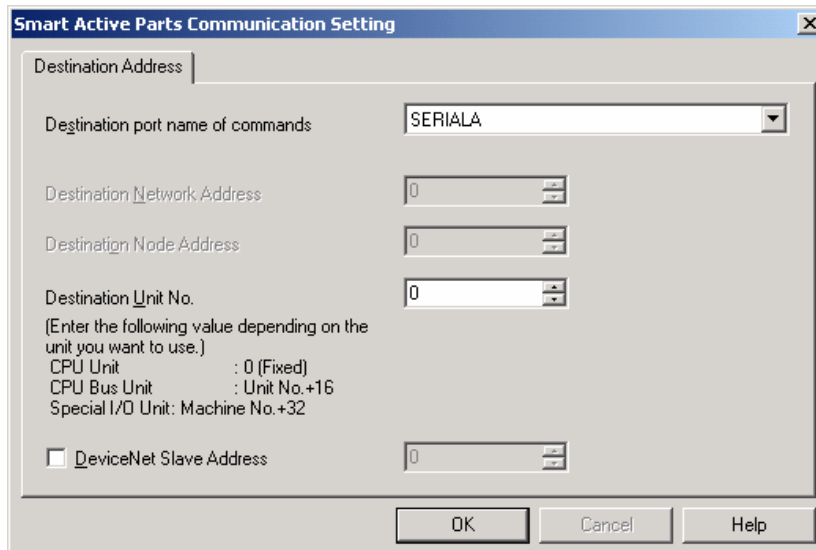

Destination port name of commands	SERIALA :when connected to serial port A
	SERIALB :when connected to serial port B
Destination Unit No.	0 to 31 :Communications unit No. of the temperature controller you want to operate.
	With broadcast to all parts, this parameter is not used. Keep default value 0.
	Use the following table for serial connection.

SCU Unit No.	Port	Destination Unit No.	SCU Unit No.	Port	Destination Unit No.
0	1	128	8	1	160
0	2	129	8	2	161
1	1	132	9	1	164
1	2	133	9	2	165
2	1	136	A	1	168
2	2	137	A	2	169
3	1	140	B	1	172
3	2	141	B	2	173
4	1	144	C	1	176
4	2	145	C	2	177
5	1	148	D	1	180
5	2	149	D	2	181
6	1	152	E	1	184
6	2	153	E	2	185
7	1	156	F	1	188
7	2	157	F	2	189

When you want to change the label and color setting of the Smart Active Parts, select and right click on a Smart Active Parts, and select **Edit Smart Active Parts**. It is now in Smart Active Parts edit mode. Double click on the desired object to open the property dialog and the settings can be changed.

Do not change the communications address when editing the settings. Once it has been changed, the Smart Active Parts will not function properly anymore.

Furthermore, when it is in Smart Active Parts edit mode, you cannot set Smart Active Parts communications settings. So when you want to modify the communications settings, click any area except the Smart Active parts to exit from the edit mode.

## 2-6-2 Smart Active Parts Operations

Smart Active Parts for Temperature Controllers are grouped by Temperature Controller model, channel, instruction to single unit/broadcast, control details.

Smart Active Parts title indicates the operating instruction to be executed.

### ■ Communications writing enabled/disabled

You can either enable or disable the writing of set values from communications.

When communications writing is disabled, the writing of set values from communications and the execution of certain instructions is prohibited.

Default setting is set as **Disable**.

By executing Smart Active Parts **Enable communications writing/Disable communications writing**, you can switch between enabled/disabled.

If communications writing is not enabled before writing set values with numeral display & input object or word button, an error occurs.

Furthermore, by disabling communications writing, you can avoid that set values are being changed by accident.

A summary of executable/non executable instructions when communications writing is disabled, is given in table '2-6-3 Smart Active Parts list'.

### ■ Setting area 0/setting area 1

Temperature controller communications has 2 operation modes: setting area 0 and setting area 1.

In setting area 0, control operations are conducted. You cannot modify any set values that negatively affect the control operations. When power supply is turned on, this mode is selected.

In Setting area 1, the control operations are stopped. You can modify the set values protected in Setting area 0.

You can switch to Setting area 1 by executing Smart Active Parts part 'Move to setting area 1'.

To change from Setting area 1 to Setting area 0, you can either turn the power off and then back ON again or you can execute Smart Active Parts part: " Software Reset".

Executable operating instructions vary depending on which mode is selected: setting area 0 or 1.

Non executable in setting Area 0	Non executable in setting Area 1
Initialize set values	AT execute/cancel Move to protect level Auto/manual PV hold

■ Confirm command results

Under certain conditions e.g. communications writing disabled, it can happen that a selected Smart Active Parts instruction cannot be executed.

But, when performing the broadcast, no response is given. In that case there is no check as to whether the action was completed successfully or not.

Therefore adopt a method that checks if the operation was carried out properly, e.g. lamp indication.

Model	Title (operating instruction)	Addresses to be monitored	
Common	Communications writing disabled	ch1	CO0001.25
	Communications writing enabled	ch 2	CO 0101.25
	run	ch1	CO 0001.24
	stop	ch 2	CO 0101.24
	AT execute	ch1	CO 0001.23
	AT cancel	ch 2	CO 0101.23
	Writing mode: back-up	ch1	CO 0001.20
	Writing mode: RAM	ch 2	CO 0101.20
	Move to setup area 1	ch1	CO 0001.22
		ch 2	CO 0101.22
	auto	ch1	CO 0001.26
manual	ch2	CO 0101.26	
E5ZN	Cancel alarm 1 latch	ch1	C00001.12 to 15
	Cancel alarm 2 latch	ch2	C00101.12 to 15
	Cancel alarm 3 latch	*1	
	Cancel all alarm latches		
E5□R	Cancel alarm latch	ch1	C00001.12 to 15
		ch 2	C00101.12 to 15
		ch 3	C00201.12 to 15
		ch 4	C00301.12 to 15
		*1	
	SP mode: local SP	ch1	C00001.27
	SP mode: remote SP	ch 2	C00101.27
	Select bank: 0 to 7	ch 1	C40408
		ch 2	C41408
		ch 3	C42408
		ch 4	C43408
AT execute (confirm executing PID group No.)	ch 1	C4040A	
	ch 2	C4140A	
	ch 3	C4240A	
	ch4	C4340A	

\*1 Confirm that alarm output has become OFF.

Attention: Under certain conditions such as PV that an alarm might be output, you cannot confirm because alarm output remains high even when the latch is cancelled

For more information on each Smart Active Parts' functions and usage, refer to Smart Active Parts Library manuals: *Temperature Controller (CJ1W-TC)*, *Temperature Controller (E5xN)*, *Temperature Controller (E5xR)*, *Temperature Controller (E5CN)*, *Temperature Controller (E5ZN)*, and *Temperature Controller (from Ver5 or earlier)*.

## 2-7 Restrictions

### 2-7-1 The behavior of 2 word number in the CX-Designer test function

In the temperature controller, a value equivalent to 2 words (32 bits) is stored for each communications address, but in the test function, the first 16 bits and the last 16 bits behave as one and the same value. For that reason, test function will not operate successfully when 2 word numbers are designated.

### 2-7-2 Address display when address error occurs

When faulty device is set to communications address set in functional object, this communications address is displayed in the device setting error dialogue.

If the communications address is allocated to the temperature controller, not the address for the temperature controller set with the CX-Designer, but the address in the PLC address format is displayed. Addresses will be converted as shown below.

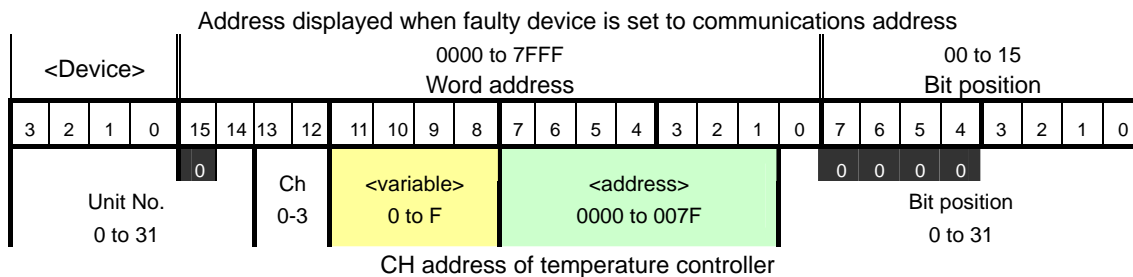

<b>&lt;Device&gt;</b>	<b>Unit No.</b>	
DM	0	1
EM	2	3
EM0_	4	5
EM1_	6	7
EM2_	8	9
EM3_	10	11
EM4_	12	13
EM5_	14	15
EM6_	16	17
EM7_	18	19
EM8_	20	21
EM9_	22	23
EMA_	24	25
EMB_	26	27
EMC_	28	29
WR	30	31

<b>&lt;Variable &gt;</b>	<b>Temp controller</b>		<b>&lt;Address&gt;</b>
	<b>Variable</b>		
0	C0	C1	0000 to 003F
1	C2	C3	0040 to 007F
2	C4		0000 to 007F
3	C5		
4	C6		
5	C7		
6	C8		
7	C9		
8	CA		
9	CB		
A	CC	CD	0040 to 007F
B	CE	CF	0000 to 003F
C	D0	D1	0040 to 007F
D	D2	D3	0000 to 003F
E	D4	D5	0040 to 007F
F	D6	D7	0000 to 003F

Device setting errors are not likely to occur. This because, setting is done using the method by which a selection is made from a list of accessible addresses for each temperature controller model.

However, in below cases in which the address is not selected from the list of accessible addresses an invalid address may have been assigned. In such a case, a device setting error may occur.

- Communications address set when functional object was copied using repeat command when index was assigned.
- Communications address set by 'Allocate Addresses Automatically' in the frame property.
- Communications address set by using the macro function.

Furthermore,

- Writing to read-only area
- Writing while communications writing was prohibited

cause device setting errors to occur.

### 2-7-3 Communications address set when functional part was copied using repeat command

In CX-Designer, you can select functional object and when you then execute 'repeat', you can copy while communications addresses are being added.

The temperature controller's address is a double word address. To increment a double word address by 1, you need to increment a single word address by 2.

Address in CX-Designer is expressed as a 1 word address. When repeat command is used to copy functional object, 1 word is added to 1 word address.

For that reason, when communications address offset width is 1 while repeat command is used, part with the same communications address is copied twice.

Actual address	Internal address	
Double word	Single word	
+0	+0	Address originally set for functional object
+0 (0.5)	+1	Omit figures below decimal 0.5->0
+1	+2	
+1 (1.5)	+3	Omit figures below decimal 0.5->0

For that reason, set always offset in multiples of 2 to specify communications address with single word access.

## Section 3

---

# Connection via Memory Link

This chapter explains the Memory Link function and how to use it to connect host computer.

3-1How does Memory Link work

3-2Settings

3-3Communications procedures

3-4What has been changed since NT31/631



## 3-1 How does Memory Link work

### 3-1-1 PT memory

With Memory Link you assign objects word and bit to PT memory. PT memory is an imaginary PLC area inside the NS. NS performs read/write operations to internal PT memory. Host reads/writes PT memory as required and so controls and monitors NS.

PT memory consists of 2 territories: Bit (\$B) and Word (\$W).

Host reads/writes internal holding memory(\$HB/\$HW) can be used in the following combination:

NS system program Ver. 6.2 and later versions

System Ver.6.2 and later projects

PT memory can be also used to store functional object display character strings or as data area for the macro function.

### 3-1-2 Command and response

With Memory Link, the following commands enable data transmission between host and PT.

- Read-out command / response

This is the command for reading out PT memory of PT.

When host gives command, PT responds the contents of the designated data.

There are 4 commands that vary with the type of PT memory.

Command	Title	Action
<i>RM</i>	Read out PT (\$W) memory	Read out \$W data in PT memory
RB	Read out PT (\$B) memory	Read out \$B data in PT memory
<i>RD</i>	Read out PT (\$HW) memory	Read out \$HW data in PT memory
RH	Read out PT (\$HB) memory	Read out \$HB data in PT memory

- Write command/response

This is the command to write designated data to PT memory area in PT.

Host gives command. PT responds whether or not the writing was completed successfully.

The successful completion response may be omitted by particular setting the Response parameter in the communications conditions menu.

The following 8 commands can be given:

Command	Title	Action
<i>WM</i>	Write to PT memory (\$W)	Write data to PT memory \$W
WB	Write to PT memory (\$B)	Write data to PT memory \$B
<i>WD</i>	Write to PT memory (\$HW)	Write data to PT memory \$HW
WH	Write to PT memory (\$HB)	Write data to PT memory \$HB
FM	FILL PT memory (\$W)	Write designated data to multiple PT memory \$W

FB	FILL PT memory (\$B)	Write designated data (0 or 1) to Multiple PT memory \$B.
FD	FILL PT memory (\$HW)	Write designated data to multiple PT memory \$HW
FH	FILL PT memory (\$HB)	Write designated data (0 or 1) to Multiple PT memory \$HB.

- Notify Command

This is the command to communicate the results of PT operations to host.

PT gives command. For that reason, there is no response.

The following 4 commands can be given.

command	Title	Action
<b>SM</b>	PT memory (\$W) change notice	Notify host of PT memory \$W changes.
SB	PT memory (\$B) change notice	Notify host of PT memory \$B changes.
<b>SD</b>	PT memory (\$HW) change notice	Notify host of PT memory \$HW changes.
SH	PT memory (\$HB) change notice	Notify host of PT memory \$HB changes.

- Error response

Response from PT when the received command is an invalid one.

Command	Title	Action
<b>ER</b>	Error response	Notify host of command error

### 3-1-3 Action when command is used

There are 3 flows of communications between host and PT, depending on the type of command and Response Settings in Communications conditions.

- Write data command while [response: OFF]

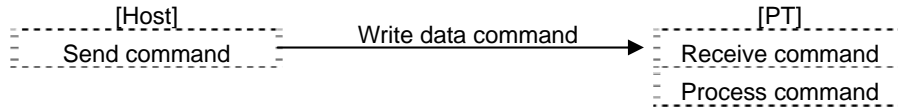

- Write Data command while [response: ON]
- Read-out data command
- Invalid command

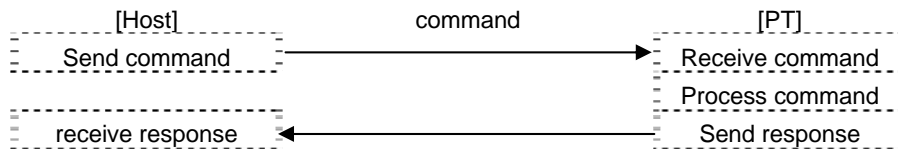

- PT to host communications

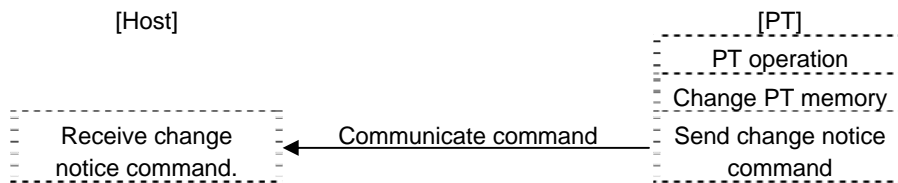

### 3-1-4 Notify Command Behavior

When anything has changed in the PT memory, by e.g. touch switch operation on PT, numerical input or character string input, PT sends change notice command to host.

In addition to Memory Link connection, PT memory serves other purposes as well. If all changes would be communicated to host, the host would be burdened more than is needed. For that reason, PT communicates only changes from a designated number and up. Changes in PT memory areas with a lower number are not communicated.

Set the number in Communications conditions -> **Notice Start \$B**, **Notice Start \$W**, **Notice Start \$HB**, and **Notice Start \$HW**.

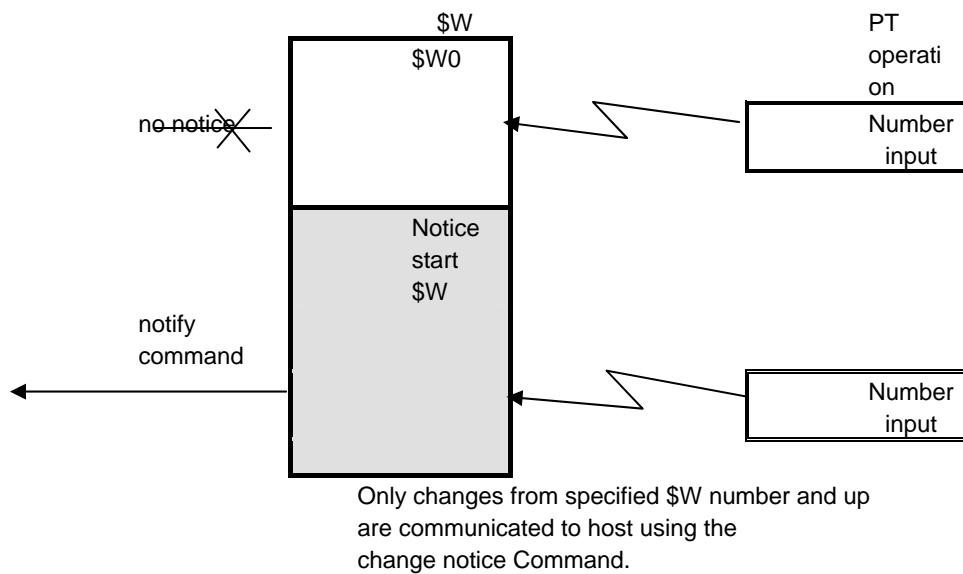

### 3-1-5 Flow control

When too many commands are sent, PT cannot process timely. Communications buffer overflows. Commands and command sequence get lost. Memory Link connection in NS Series -V1/-V2 models do not support flow control.

For that reason, set Communications conditions Response to ON when PT to host command interval frequency becomes high.

## 3-2 Settings

### 3-2-1 Making settings for the Project

The Memory Link can be used in combination with  
NS system program Ver. 5.0 and later versions  
System Ver.5.0 and later projects

With CX-Designer, you can create and edit project developed by System Ver.5.0 and later projects.  
A project created with System Ver.4.0 or earlier can be opened with CX-Designer and converted to data of Ver.5.0 and later.

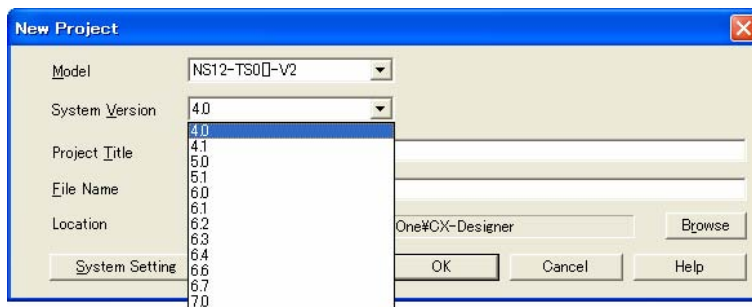

Open a project created with System Ver.5.0 using CX-Designer, and select **PT - Communication Setting**. The Comm. Setting dialogue appears. Select Serial Port A (or Serial Port B) in the left pane, and select Memory Link from the pull down menu for Serial Port.

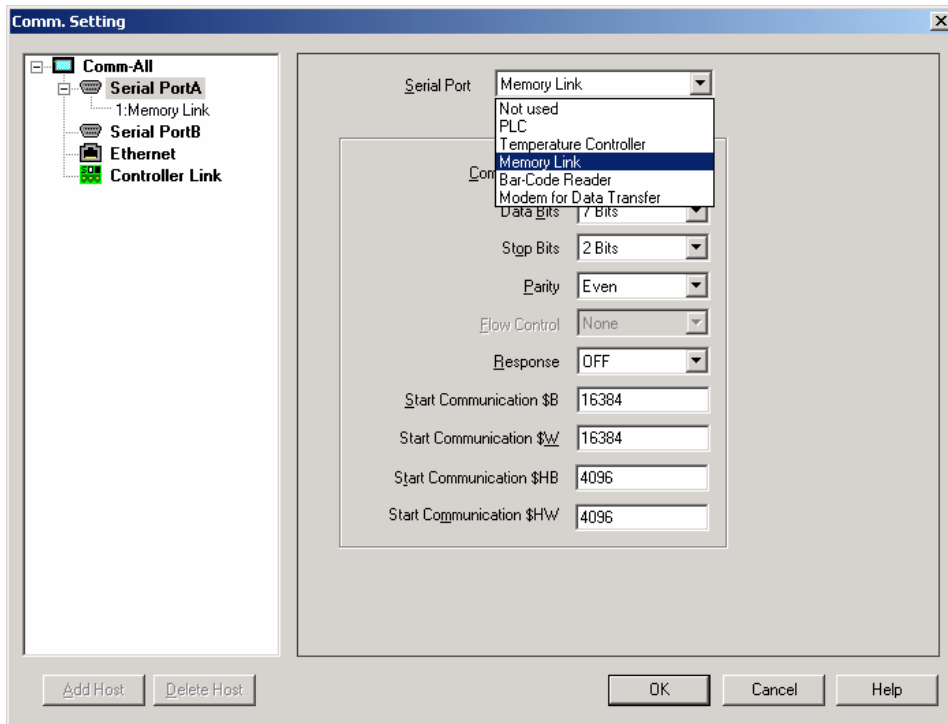

### 3-2-2 Communications conditions setting

In CX-Designer, select Serial Port A (or Serial Port B) in the Comm. Setting dialog box, and set to the following communications conditions. With System Ver.6.2 and later projects, you can set Notice start \$HB and Notice start \$HW.

Parameter	Set value	Default value
Baud rate	9600bps / 19200bps / 38400bps	9600bps
Data bits	7 / 8	7
Stop bits	1 / 2	1
Parity	None / Even / Odd	Even
response	OFF / ON	OFF
Notice start \$B	0 to 32767	16384
Notice start \$W	0 to 32767	16384
Notice start \$HB	0 to 8191	4096
Notice start \$HW	0 to 8191	4096

### 3-2-3 NS system menu operation

You can also use the NS system menu to set the communications conditions for the Memory Link connection.

Under system menu, click tab **Communications Setting**.

By pressing the key beside the Serial Port A or Serial Port B, you can switch between communications methods.

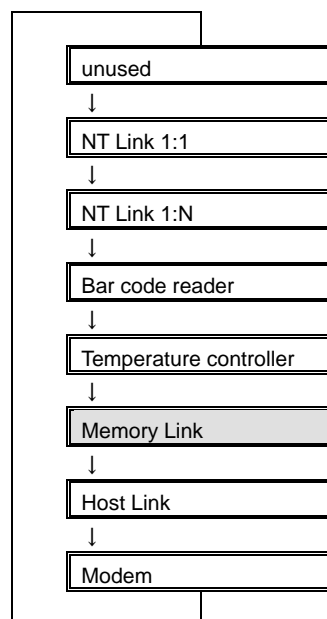

After you have thus set communications to Memory Link, use the **Details** key to set the communications conditions for the Memory Link connection (for details, refer to section 2.2). However, with system menu you cannot set the **Notice start \$B**, **Notice start \$W**, **Notice start \$HB**, and **Notice start \$HW**.

Set values are not saved until you press the **Write** key. Also, setting changes will be effective when you turn the power OFF and then ON again.

### 3-2-4 Connection Diagram

Use either NS Serial Port A or B to connect host computer via Memory Link.

You cannot simultaneously set Serial Port A and B to Memory Link.

The connecting cable varies with the specifications of the host computer communications port.

Below is a typical example, which shows the wiring diagram when DOS/V PC is connected.

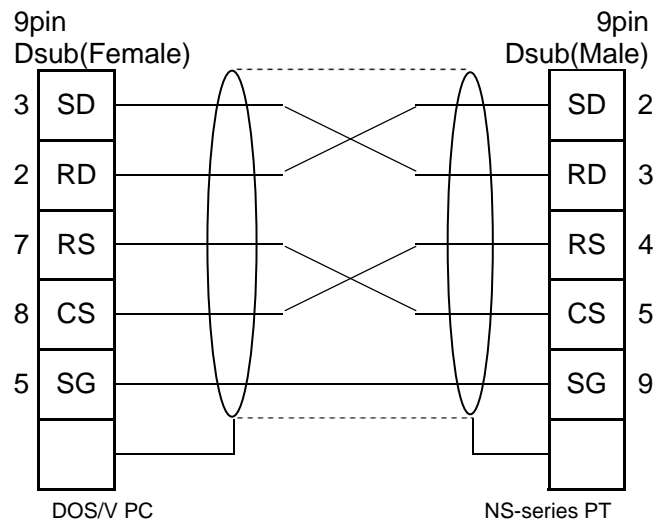

Above wiring is identical with the NS to and from CX-Designer wiring.

If the cable length is conform, you can use the following cable with connector.

XW2Z-S002	Omron product Cable length 2m, 9 pin↔9 pin
-----------	---



## 3-3 Communications procedures

### 3-3-1 Memory Link Commands

Command/response formats are as mentioned below.

- Read/write/change notify command

ESC	command	*S	*A	*L	*D	SUM	CR
-----	---------	----	----	----	----	-----	----

- Read/write command (In above-mentioned format, the \*L is regarded as 1 (fixed))

ESC	command	*S	*A	*D	SUM	CR
-----	---------	----	----	----	-----	----

- Write all (FILL) command

ESC	command	*S	*A	*B	*D	SUM	CR
-----	---------	----	----	----	----	-----	----

- Read type command normal completion response format

ESC	command	*A	*L	*D	SUM	CR
-----	---------	----	----	----	-----	----

- Other responses

ESC	command	*D	SUM	CR
-----	---------	----	-----	----

ESC	(\$1B)	Initial Command: ESC(\$1B) fixed
command	2 characters	1 English capital letters which display the type of command
*S	1 character	Designates SUM omission and *L omission. In some cases, specifies write to memory attributes as well.  SUM OFF: SUM computing by host can be omitted. SUM ON: enables judgment if command is invalid as a result of noise interference.
*A	Hexadecimal 4 digits	Initial read/write address
*B	Hexadecimal 4 digits	Last Write all (FILL) address
*L	BCD 2 digits	Number of read/write elements
*D	Variable length	Data section
SUM	2 characters (may be abbreviated)	The checksum of the command response is the 2 digit code in hexadecimal which is indicated using lower one-byte of the total sum from the ESC to the *D. It can be abbreviated by specifying *S. Be sure that it is added when PT is transmitting.
CR	(\$0D)	Command end: CR(\$0D) fixed

Memory Link commands are as follows:

<b>Command</b>	<b>Command title</b>	<b>Action</b>
RM	Read PT memory (\$W)	Read contents of \$W data
RB	Read PT memory (\$B)	Read contents of \$B data
RD	Read PT memory (\$HW)	Read contents of \$HW data
RH	Read PT memory (\$HB)	Read contents of \$HB data
WM	Write PT memory (\$W)	Write to \$W data
WB	Write PT memory (\$B)	Write to \$B data
WD	Write PT memory (\$HW)	Write to \$HW data
WH	Write PT memory (\$HB)	Write to \$HB data
FM	Fill PT memory (\$W)	Fill multiple sequential \$W with the same value
FB	Fill PT memory (\$B)	Fill multiple sequential \$B with the same value.
FD	Fill PT memory (\$HW)	Fill multiple sequential \$HW with the same value
FH	Fill PT memory (\$HB)	Fill multiple sequential \$HB with the same value.
SM	PT memory (\$W) change notice	Communicate \$W changes to host
SB	PT memory (\$B) change notice	Communicate \$B changes to host
SD	PT memory (\$HW) change notice	Communicate \$HW changes to host
SH	PT memory (\$HB) change notice	Communicate \$HB changes to host

RM	Read PT memory (\$W)
----	----------------------

Read \$W data in PT memory.

Per command, a maximum of 100 words can be read.

Response is up to 50 words per response.

When requesting command is parameter 2: number of words exceeds 51, then the response is split into two.

The first response sends 50 words, the second response sends the remaining channels.

When entries were made on NS in between the first and second response, change notice command is not sent until after the second response has been sent.

- Command format

ESC	command	*S	*A	*L	SUM	CR
\$1B	R M					\$0D

[Settings]

*S	Sum value	
0	OFF	Omit *L. Number of read-out words: 1 (fixed)
1	ON	
8	OFF	
8	ON	
*A	0000 to 7FFF	Initial address No. (hexadecimal 4 digits)
*L	00 to 99	Number of read-out words (BCD 2 digits) 00 indicates 100.

- Successful completion response format

ESC	command	*A	*L	*D	SUM	CR
\$1B	R M			Variable length		\$0D

[Settings]

*A	0000 to 7FFF	Initial address No. (hexadecimal 4 digits)
*L	01 to 50	Number of read-out words (BCD 2 digits)
*D	0 to FFFF “,”	Word data (zero suppressed hexadecimal 1 to 4 digits) From 2 <sup>nd</sup> word onward, enter comma “,” (\$2C) before the next data.

RB	Read PT memory (\$B)
----	----------------------

Read \$B data in PT memory.

Per command, a maximum of 100 bits can be read.

After reading, bit data are displayed and returned per 8 bits as 8 bit value.

- Command format

ESC	command	*A	*L	SUM	CR
\$1B	R	B			\$0D

[Settings]

*S	BCD1digit	Sum value	Number of tables: 1 (fixed). Omit Parameter2.
	0	OFF	
	1	ON	
	8	OFF	
	9	ON	
*A	0000 to 7FFF	Initial address No. (hexadecimal 4 digits)	
*L	00 to 99	Read-out bit number (BCD 2 digits) 00 indicates 100.	

- Response format

ESC	command	*A	*L	*D	SUM	CR
\$1B	R	B		Variable length		\$0D

[Settings]

*A	0000 to 7FFF	Initial address No. (hexadecimal 4 digits)
*L	00 to 99	Number of bits (BCD 2 digits) 00 indicates 100.
*D	00 to FF	Bit data (hexadecimal 2 digit value of 8 bits each) 0:OFF, 1: ON Fills addresses in ascending order starting with first digit. Turns 8 bits into a binary 8 digit value and displays this as a hexadecimal 2 digit value. The next hexadecimal 2 digit value continues with the following 8 bits. Fills any of the last 8 bits that does not actually have a valid read-out data with 0. [example] from \$B10 6 bits have read-out value \$B10 11 12 13 14 15 * * 1 0 1 0 1 1 0 0 → AC (converted to hexadecimal form)

RD	Read PT memory (\$HW)
----	-----------------------

Read \$HW data in PT memory.

Per command, a maximum of 100 words can be read.

Response is up to 50 words per response.

When requesting command is parameter 2: number of words exceeds 51, then the response is split into two.

The first response sends 50 words, the second response sends the remaining channels.

When entries were made on NS in between the first and second response, change notice command is not sent until after the second response has been sent.

- Command format

ESC	command	*S	*A	*L	SUM	CR
\$1B	R D					\$0D

[Settings]

*S		Sum value	
0		OFF	Omit *L. Number of read-out words: 1 (fixed)
1		ON	
8		OFF	
8		ON	
*A	0000 to 1FFF	Initial address No. (hexadecimal 4 digits)	
*L	00 to 99	Number of read-out words (BCD 2 digits) 00 indicates 100.	

- Successful completion response format

ESC	command	*A	*L	*D	SUM	CR
\$1B	R D			Variable length		\$0D

[Settings]

*A	0000 to 1FFF	Initial address No. (hexadecimal 4 digits)
*L	01 to 50	Number of read-out words (BCD 2 digits)
*D	0 to FFFF “,”	Word data (zero suppressed hexadecimal 1 to 4 digits) From 2 <sup>nd</sup> word onward, enter comma “,”(\$2C) before the next data.

RH	Read PT memory (\$HB)
----	-----------------------

Read \$HB data in PT memory.  
 Per command, a maximum of 100 bits can be read.  
 After reading, bit data are displayed and returned per 8 bits as 8 bit value.

- Command format

ESC	command		*A				*L		SUM		CR
\$1B	R	H									\$0D

[Settings]

*S	BCD1 digit	Sum value	Number of tables: 1 (fixed). Omit Parameter2.
	0	OFF	
	1	ON	
	8	OFF	
	9	ON	
*A	0000 to 1FFF	Initial address No. (hexadecimal 4 digits)	
*L	00 to 99	Read-out bit number (BCD 2 digits) 00 indicates 100.	

- Response format

ESC	command		*A				*L		*D	SUM	CR
\$1B	R	H						Variable length			\$0D

[Settings]

*A	0000 to 1FFF	Initial address No. (hexadecimal 4 digits)
*L	00 to 99	Number of bits (BCD 2 digits) 00 indicates 100.
*D	00 to FF	Bit data (hexadecimal 2 digit value of 8 bits each) 0:OFF, 1: ON Fills addresses in ascending order starting with first digit. Turns 8 bits into a binary 8 digit value and displays this as a hexadecimal 2 digit value. The next hexadecimal 2 digit value continues with the following 8 bits. Fills any of the last 8 bits that does not actually have a valid read-out data with 0. [example] from \$HB10 6 bits have read-out value \$HB10 11 12 13 14 15 * * 1 0 1 0 1 1 0 0 → AC (converted to hexadecimal form)

WM	Write to PT memory (\$W)
----	--------------------------

Write to \$W data in PT memory.

Per command, a maximum of 50 words can be written.

As writing attribute you can select SET, AND, OR, or XOR.

- Command format

ESC	command		*S	*A	*L	*D	SUM	CR
\$1C	W	M				Variable length		\$0D

[Settings]

*S	BCD 1 digit	SUM	Writing attribute	
	0	OFF	SET	<b><i>Writes designated value just as it is.</i></b>
	1	ON		
	2	OFF	AND	Ands present value of destination with designated value and writes outcome.
	3	ON		
	4	OFF	OR	Ors present value of destination with designated value and writes outcome
	5	ON		
	6	OFF	XOR	Xors present value of destination with designated value and writes outcome.
	7	ON		
8	OFF	SET	Omits *L . Number of destination words : 1 (fixed)	
9	ON			
*A	0000 to 7FFF	Initial address number (hexadecimal 4 digits)		
*L	01 to 50	Number of destination words (BCD 2 digits)		
*D	0000 to FFFF “,”	Word data (zero suppressed hexadecimal, 1 to 4 digits) From 2 <sup>nd</sup> word on, enter comma [,] (\$2C) before next data. Data ending with comma cause error.		

- Normal completion response format (only when response under communications conditions is ON).

ESC	command		*D	SUM	CR
\$1B	W	M	0 0		\$0D

[Settings]

*D	00 fixed. Indicates successful completion.
----	--

WB	Write PT memory (\$B)
----	-----------------------

Write to \$B data in PT memory.

Per command, a maximum of 100 bits can be written.

- Command format

ESC	command		*A				*L	*D	SUM	CR
\$1B	W	B						Variable length		\$0D

[Settings]

*S	BCD1 digit	SUM value	
	0	OFF	Bit number: 1 fixed. Parameter 2 omitted.
	1	ON	
	8	OFF	
	9	ON	
*A	0000 to 7FFF	Initial address number (hexadecimal 4 digits)	
*L	00 to 99	Entry bit number (BCD 2 digits) When 00, 100 is meant.	
*D	00 to FF	Bit data (hexadecimal 1 digit value for 4 bits each)  <b>0: OFF, 1: ON</b>  Fills data in descending order starting with first digit. Turns 4 bits into a binary 4 digit value and displays this as a hexadecimal 1 digit value. The next hexadecimal 1 digit value continues with the following 4 bits.  Fills any of the last 4 bits that does not actually have a valid read-out data with 0. [example] from \$B10, 6 bits have read-out value \$B10 11 12 13 14 15 * * 1 0 1 0 1 1 0 0 → AC (converted to hexadecimal form)	

- Normal completion response format (only when response under communications conditions is ON).

ESC	command		*D				SUM	CR
\$1B	W	B	0	0			\$0D	

[Settings]



<b>*D</b>	00 fixed. Indicates normal completion.
-----------	--

WD	Write to PT memory (\$HW)
----	---------------------------

Write to \$HW data in PT memory.

Per command, a maximum of 50 words can be written.

As writing attribute you can select SET, AND, OR, or XOR.

- Command format

ESC	command		*S	*A	*L	*D	SUM	CR
\$1C	W	D					Variable length	\$0D

[Settings]

*S	BCD 1 digit	SUM	Writing attribute	
	0	OFF	SET	Writes designated value just as it is.
	1	ON		
	2	OFF	AND	
	3	ON		
	4	OFF	OR	
	5	ON		
	6	OFF	XOR	
	7	ON		
8	OFF	SET	Omits *L . Number of destination words : 1 (fixed)	
9	ON			
*A	0000 to 1FFF	Initial address number (hexadecimal 4 digits)		
*L	01 to 50	Number of destination words (BCD 2 digits)		
*D	0000 to FFFF “,”	Word data (zero suppressed hexadecimal, 1 to 4 digits) From 2 <sup>nd</sup> word on, enter comma [,] (\$2C) before next data. Data ending with comma cause error.		

- Normal completion response format (only when response under communications conditions is ON).

ESC	command	*D	SUM	CR
\$1B	W D	0 0		\$0D

[Settings]

*D	00 fixed. Indicates successful completion.
----	--

WH	Write PT memory (\$HB)
----	------------------------

Write to \$HB data in PT memory.

Per command, a maximum of 100 bits can be written.

- Command format

ESC	command		*S				*A	*L	*D	SUM	CR
\$1B	W	H							Variable length		\$0D

[Settings]

*S	BCD1 digit	SUM value	
	0	OFF	
	1	ON	
	8	OFF	Bit number: 1 fixed. Parameter 2 omitted.
9	ON		
*A	0000 to 1FFF	Initial address number (hexadecimal 4 digits)	
*L	00 to 99	Entry bit number (BCD 2 digits) When 00, 100 is meant.	
*D	00 to FF	Bit data (hexadecimal 1 digit value for 4 bits each)  <b>0: OFF, 1: ON</b>  Fills data in descending order starting with first digit. Turns 4 bits into a binary 4 digit value and displays this as a hexadecimal 1 digit value. The next hexadecimal 1 digit value continues with the following 4 bits.  Fills any of the last 4 bits that does not actually have a valid read-out data with 0. [example] from \$HB10, 6 bits have read-out value \$HB10 11 12 13 14 15 * * 1 0 1 0 1 1 0 0 → AC (converted to hexadecimal form)	

- Normal completion response format (only when response under communications conditions is ON).

ESC	command		*D				SUM	CR
\$1B	W	H	0	0			\$0D	

[Settings]

<b>*D</b>	00 fixed. Indicates normal completion.
-----------	--

FM	Fill PT memory (\$W)
----	----------------------

Fills PT memory \$W with the same word data. Range: first to last address number.

- Command format

ESC	command		*S	*A	*B	*D	SUM	CR
\$1B	F	M						\$0D

[Settings]

*S	BCD 1 digit	SUM value	
	0	OFF	
	1	ON	
*A	0000 to 7FFF	First address number (hexadecimal 4 digits)	
*B	0000 to 7FFF	Last address number (hexadecimal 4 digits)	
*D	0 to FFFF	Word data (zero suppressed hexadecimal 1 to 4 digits)	

- Normal completion response format (only when response under communications conditions is ON).

ESC	command		*D		SUM	CR	
\$1B	F	M	0	0	0	E	\$0D

[Settings]

*D	00 fixed. Indicates normal completion.
----	--

FB	Fill PT memory (\$B)
----	----------------------

Fills PT memory \$B with the same bit data. Range: first to last address number.

- Command format

ESC	command		*A				*B				*D	SUM	CR
\$1B	F	B											\$0D

[Settings]

*S	BCD 1 digit	SUM value	
	0	OFF	
	1	ON	
*A	0000 to 7FFF	Initial address number (hexadecimal 4 digits)	
*B	0000 to 7FFF	Last address number (hexadecimal 4 digits)	
*D	0: OFF 1: ON	Bit data (hexadecimal 1 digit)	

- Normal completion response format (only when response under communications conditions is ON).

ESC	command		*D		SUM	CR
\$1B	F	B	0	0		\$0D

[Settings]

*D	00 fixed. Indicates normal completion.
----	--

FD	Fill PT memory (\$HW)
----	-----------------------

Fills PT memory \$HW with the same word data. Range: first to last address number.

- Command format

ESC	command		*S	*A	*B	*D	SUM	CR
\$1B	F	D						\$0D

[Settings]

*S	BCD 1 digit	SUM value	
	0	OFF	
	1	ON	
*A	0000 to 1FFF	First address number (hexadecimal 4 digits)	
*B	0000 to 1FFF	Last address number (hexadecimal 4 digits)	
*D	0 to FFFF	Word data (zero suppressed hexadecimal 1 to 4 digits)	

- Normal completion response format (only when response under communications conditions is ON).

ESC	command		*D	SUM	CR
\$1B	F	D	0 0	0 E	\$0D

[Settings]

*D	00 fixed. Indicates normal completion.
----	--

FH	Fill PT memory (\$HB)
----	-----------------------

Fills PT memory \$HB with the same bit data. Range: first to last address number.

- Command format

ESC	command		*A				*B				*D	SUM	CR
\$1B	F	H											\$0D

[Settings]

*S	BCD 1 digit	SUM value	
	0	OFF	
	1	ON	
*A	0000 to 1FFF	Initial address number (hexadecimal 4 digits)	
*B	0000 to 1FFF	Last address number (hexadecimal 4 digits)	
*D	0: OFF 1: ON	Bit data (hexadecimal 1 digit)	

- Normal completion response format (only when response under communications conditions is ON).

ESC	command		*D		SUM	CR
\$1B	F	H	0	0		\$0D

[Settings]

*D	00 fixed. Indicates normal completion.
----	--



SM	PT memory (\$W) change notice
----	-------------------------------

When PT memory \$W changed as a result of PT operation and when this \$W address is higher than the address designated with Notice start \$W in the communications settings menu, this command is sent from PT to host.

Response from host to PT is not needed.

When sent from host to PT, illegal command error occurs.

- Command format

ESC	command						*L	*D	SUM	CR
\$1B	S	M						Variable length		\$0D

[Settings]

*A	0000 to 7FFF	Changed address number (hexadecimal 4 digits)
*L	01 to 50	Number of changed words (BCD 2 digits)
*D	0000 to FFFF “,”	Word data (zero suppressed hexadecimal 1 to 4 digits) Divide multiple word data by comma [,] (\$2C). Data ending with comma cause error.

SB	PT memory (\$B) change notice
----	-------------------------------

When PT memory \$B changed as a result of PT operation and when this \$B address is higher than the address designated with Notice start \$B in the communications settings menu, this command is sent from PT to host.

Response from host to PT is not needed.

When sent from host to PT, illegal command error occurs.

- Command format

ESC	command						*B	*D	SUM	CR
\$1B	S	B					0 1			\$0D

[Settings]

*A	0000 to 7FFF	Changed address number (hexadecimal 4 digits)
*B	01 fixed	Number of changed bits (hexadecimal 2 digits)
*D	0: OFF 1: ON	Bit data (hexadecimal 1 digit)

SD	PT memory (\$HW) change notice
----	--------------------------------

When PT memory \$HW changed as a result of PT operation and when this \$HW address is higher than the address designated with Notice start \$HW in the communications settings menu, this command is sent from PT to host.

Response from host to PT is not needed.

When sent from host to PT, illegal command error occurs.

- Command format

ESC	command						*A	*L	*D	SUM	CR
\$1B	S	D							Variable length		\$0D

[Settings]

*A	0000 to 1FFF	Changed address number (hexadecimal 4 digits)
*L	01 to 50	Number of changed words (BCD 2 digits)
*D	0000 to FFFF “,”	Word data (zero suppressed hexadecimal 1 to 4 digits) Divide multiple word data by comma [,] (\$2C). Data ending with comma cause error.

SH	PT memory (\$HB) change notice
----	--------------------------------

When PT memory \$HB changed as a result of PT operation and when this \$HB address is higher than the address designated with Notice start \$HB in the communications settings menu, this command is sent from PT to host.

Response from host to PT is not needed.

When sent from host to PT, illegal command error occurs.

- Command format

ESC	command						*A	*B	*D	SUM	CR
\$1B	S	H					0	1			\$0D

[Settings]

*A	0000 to 1FFF	Changed address number (hexadecimal 4 digits)
*B	01 fixed	Number of changed bits (hexadecimal 2 digits)
*D	0: OFF 1: ON	Bit data (hexadecimal 1 digit)

ER	Error response
----	----------------

- Command format

ESC	command		*D	SUM	CR
\$1B	E	R			\$0D

[Settings]

*D	Error codes listed below (hexadecimal 2 digits)
----	---

Error code	Error contents	cause
01	Illegal command	Command contents lie outside the supported range
02	Command length error	Length of received command is illegal for that command.
03	Boundary value error	<ul style="list-style-type: none"> <li>• Value set to parameter lies outside the supported range.</li> <li>• Parameter in BCD format includes others than 0 to 9</li> </ul>
04	Illegal operand	Sum information Set value lies outside the effective range.
05	Command format error	\$W/\$B command; Data section includes characters other than 0 to F and “,”. \$W command; data section ends with “,”.
10	SUM value error	Command with sum value ON. Computed sum value and the one in the command do not match.
12	Reception timeout error	After the initial ESC was received, the interval in between receiving one byte after the other until command end [CR] exceeded timeout monitoring time.

These commands are sent from NS to host when the host sent an invalid command and when a communications error occurred.

## 3-4 What has been changed since NT31/631

### 3-4-1 Memory Link Commands

This summarizes the points that need to be given attention when switching over from NT31/631 series to NS series Memory Link.

Memory structure inside PT differs, so the structure of Memory Link commands has changed as well.

#### ■ Memory structure inside PT

	NT31/631 series		NS series		
<b>PT memory</b>	Contact point	common 0000 to 9999	Contact point	\$B0 to 65535	\$HB0 to 8191
	channel		channel	\$W0 to 65535	\$HW0 to 8191
Memory table	Number memory table Character string memory table bit memory table		none		
Battery backup	Is performed		Is not performed		Is performed

#### ■ Memory Link command

	NT31/631 series	NS series
RM	Read-out PT memory	Read-out PT memory (\$W)
RB	Read-out bit memory table	Read-out PT memory (\$B)
RN	Read-out number memory table	-
RS	Read-out character string memory table	-
WM	Write to PT memory	Write to PT memory (\$W)
WB	Write to bit memory table	Write to PT memory (\$B)
FR	Read-out display data comment	-
PT	Read-out system conditions	-
WN	Write to number memory table	-
WS	Write to character string memory table	-
FM	Fill PT memory	Fill PT memory (\$W)
FB	-	Fill PT memory (\$B)
CN	Clear number memory table	-
CS	Clear character string memory table	-
CB	Clear bit memory table	-
ST	Touch switch input notice	-
SN	Number input notice	-
SS	Character string input notice	-
PM	Direct area change notice	-
SM	PT memory change notice	PT memory (\$W) change notice
SB	-	PT memory (\$B) change notice
MC	Switch PT operating mode	-
RR	Request resend	-
ER	Error response	Error response
RD	-	Read-out PT memory (\$HW)

RH	-	Read-out PT memory (\$HB)
WD	-	Write to PT memory (\$HW)
WH	-	Write to PT memory (\$HB)
FD	-	Fill PT memory (\$HW)
FH	-	Fill PT memory (\$HB)
SD	-	PT memory (\$HW) change notice
SH	-	PT memory (\$HB) change notice

■ Execution of contact notice to \$W

While NT31/631 performs contact point change notice and channel change notice in the same PT memory, the NS splits it into \$B and \$W

There, the use of a macro, enables the contact point notice to \$W.

E.g. Momentary switch sending notice to 5<sup>th</sup> bit in \$W1000

- Create ON/OFF button
- Designate \$B address that is not specified for any other purpose.  
Destination address may be blank, but in that case the button does not light when it is being pressed down.
- Edit macro (touch ON)  
\$W1000 = \$W1000 | H10;
- Edit macro (touch OFF)  
\$W1000 = \$W1000 & to H10;

■ PT memory hold

Battery backup in NT31/631 ensures that PT memory and memory table values are kept as they were when the power goes off.

Because NS's battery backup holds PT memories(\$HB/\$HW), the values in these memories are kept as they were when the power goes off. Host reads/writes internal holding memory(\$HB/\$HW) is only available in the following combination:

- NS system program ver.6.2 and later versions
- System ver.6.2 and later projects

NS cannot react to an unexpected power fall out, but there is a possibility to store values before the power is turned OFF.

You can save a copy of PT memory \$W by saving the contents of this memory as a file on a compact flash card. Then removes this card.

As it is a file reading/writing operation to a compact flash card, it cannot be done frequently. In addition, you cannot save a copy of the PT memory \$B.

E.g. Manually save the PT memory \$W contents.

- Create a command button
- Set function selection to No processing

- Edit macro (touch ON)

```
WRITECF($W16384,16384,"PTMEM.DAT",0);
```

E.g. Recover PT memory \$W contents from saved file when PT is started up.

- Edit macro when project is started up

```
READCF($W16384,16384,"PTMEM.DAT",0);
```

# Revision History

---

A manual revision code appears as a suffix to the catalog number on the cover of the manual.

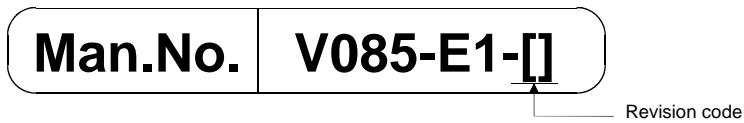

The following table outlines the changes made to the manual during each revision. Page numbers refer to the previous version.

Revision code	Date	Revised content
01	October 2003	Original production
02	July 2004	Addition of information related to NS-Designer Ver.6.0 upgrade
03	February 2005	Addition of information related to NS-Designer Ver.6.2 upgrade
04	July 2006	Addition of information related to CX-Designer release
05	July 2007	Addition of information related to CJ1H-CPU[]H-R release
06	June 2008	Addition of information related to NS5-[]1[] release
07	October 2010	Addition of information related to CX-Designer release

**OMRON Corporation Industrial Automation Company**

Tokyo, JAPAN

Contact: [www.ia.omron.com](http://www.ia.omron.com)

**Regional Headquarters**

**OMRON EUROPE B.V.**

Wegalaan 67-69-2132 JD Hoofddorp  
The Netherlands

Tel: (31)2356-81-300/Fax: (31)2356-81-388

**OMRON ELECTRONICS LLC**

One Commerce Drive Schaumburg,  
IL 60173-5302 U.S.A.

Tel: (1) 847-843-7900/Fax: (1) 847-843-7787

**OMRON ASIA PACIFIC PTE. LTD.**

No. 438A Alexandra Road # 05-05/08 (Lobby 2),  
Alexandra Technopark,  
Singapore 119967

Tel: (65) 6835-3011/Fax: (65) 6835-2711

**OMRON (CHINA) CO., LTD.**

Room 2211, Bank of China Tower,  
200 Yin Cheng Zhong Road,  
PuDong New Area, Shanghai, 200120, China

Tel: (86) 21-5037-2222/Fax: (86) 21-5037-2200

**Authorized Distributor:**

© OMRON Corporation 2009 All Rights Reserved.  
In the interest of product improvement,  
specifications are subject to change without notice.

**Cat. No. V085-E1-07**

1010