

DIN 48 x 48 mm LED Counter with IP66/NEMA 4 Protection for a Wide Variety of Applications

- Water- and dust-protected for severe environments.
- Large, high-visibility LED displays.
- Simple setting with Increment and Decrement Keys.
- Conforms to EMC standards.
- Conforms to IEC standards, and approved by UL and CSA.
- Six-language instruction manual provided.



Ordering Information

Outputs	Control power supply	Model	
		Without Shock Prevention Cover	With Shock Prevention Cover
Contact output	100 to 240 VAC	H7CL-A	---
	12 to 24 VDC	H7CL-AD	H7CL-AD-500
Transistor output (Photocoupler)	100 to 240 VAC	H7CL-AS	---
	12 to 24 VDC	H7CL-ADS	H7CL-ADS-500

■ Accessories (Order Separately)

Name	Model
Soft Cover	Y92A-48F1
Hard Cover	Y92A-48
Shock Prevention Cover (for DC models only)	Y92A-48T
Back Connecting Socket for flush mounting (for AC models only)	P3GA-11
DIN Track/Surface Mounting/Front Connecting Socket (for AC models only)	P2CF-11
Rubber Packing (see note)	Y92S-29
Flush Mounting Adaptor (see note)	Y92F-30

Note: Supplied with each Unit.

■ Model Number Legend

H7CL-A□□□□
1 2 3 4

1. Fixed
2. D: DC input
3. S: Transistor output

Specifications

Item	H7CL-A□ (AC models)	H7CL-AD□ (DC models)
Classification	1-stage preset counter	
Mounting method	DIN track, surface, and flush mounting	Flush mounting
External connections	Socket	Screw terminals
Enclosure ratings	Panel surface: IEC IP66 and NEMA Type 4 (indoors) when Y92S-29 rubber packing is used.	
EMC standards	Conforms to EN50081-2, EN50082-2.	
Approved standards	UL 508, CSA C22.2 No.14, conforms to EN61010-1/IEC61010-1	
Input modes	Up (Incrementing) and Down (decrementing) (selectable)	
Input signals	Count, gate, reset, and key protection	
Input method	No-voltage input: Via NPN transistor, or switching of contact	
Operating modes	N, F, C, K	
Control outputs	Contact output: SPDT, 3 A at 250 VAC, resistive load ($\cos\phi = 1$) Min. applicable load: 10 mA at 5 VDC, 10 mA at 24 VDC (P level, for reference value) Transistor output: NPN open collector: 100 mA max. at 30 VDC max, residual voltage: 1.5 VDC max.	
Reset system	External (min. pulse width: 1 ms, 20 ms selectable), manual, and automatic (internal according to C mode operation) resets	
External power supply	50 mA at 12 VDC ($\pm 10\%$)	---
Display	7-segment LEDs (12 mm high, red LEDs for the present value and 8 mm high, green LEDs for the set value)	
Digits	-3 digits to 4 digits (-999 to 9,999)	
Memory backup	EEPROM, which can store data for 20 years min.	

■ Ratings

Item	H7CL-A□ (AC)	H7CL-AD□ (DC)
Rated supply voltage	100 to 240 VAC, 50/60 Hz	12 to 24 VDC (contains 20% ripple max.)
Operating voltage range	85 to 264 VAC, 50/60 Hz	10.8 to 26.4 VDC
Current consumption	Approx. 10 VA	Approx. 3 W
Max. counting speeds	30 cps or 5 kcps (selectable) (ON : OFF ratio = 1 : 1)	
Gate input	Min. pulse width: 20 ms	
Key protection input	Response time: 1 s max.	
One-shot time	50 or 500 ms (selectable)	
Case	Light gray (Munsell 5Y7/1)	

Operation

■ DIP Switch Setting

Pin no.	Item	OFF	ON
1	Counting speed	30 cps	5 kcps
2	Input modes	Up (Increment)	Down (Decrement)
3, 4	Operating modes	See table below.	
5	One-shot time (see note 1)	500 ms	50 ms
6	Reset min. pulse width	20 ms	1 ms

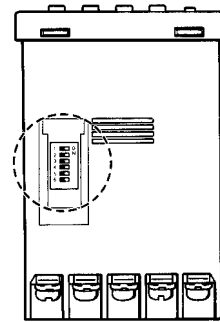

(The same DIP switch settings apply to AC and DC models)

- Note:**
1. DIP switch settings change when the power is turned on. Its setting changes become disabled while the power is on.
 2. The one-shot time is valid only when the C mode or K mode is selected.

Operating Modes

3	4	Operating modes	
OFF	OFF	N	Count Stop, Output Hold Mode The output and present value are on hold until reset input is ON.
ON	OFF	F	Over-count, Output Hold Mode The Counter continues incrementing/decrementing the present value but the output is on hold until reset.
OFF	ON	C	Auto-reset, One-shot Output Mode The Counter is automatically reset when counted up. The control output is a one-shot output type.
ON	ON	K	Over-count, One-shot Output Mode The Counter continues incrementing/decrementing the present value but the output is a one-shot output type.

Note: Switches 1 to 6 are all set to OFF before shipping.

■ Operating Modes

N Mode

Counting stop, output is on hold.

Up (Increment) Mode

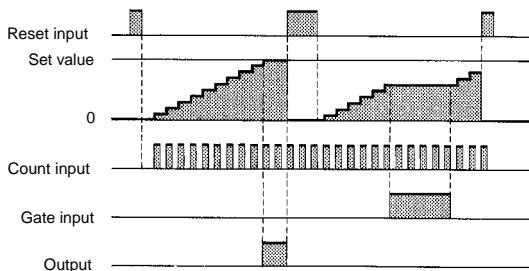

Down (Decrement) Mode

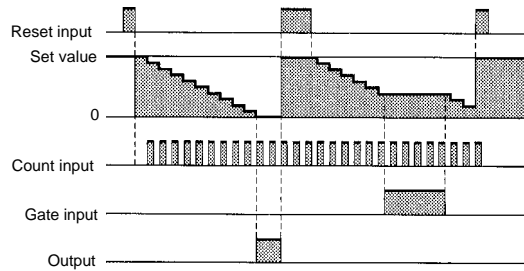

F Mode

Over-count, output is on hold.

Up (Increment) Mode

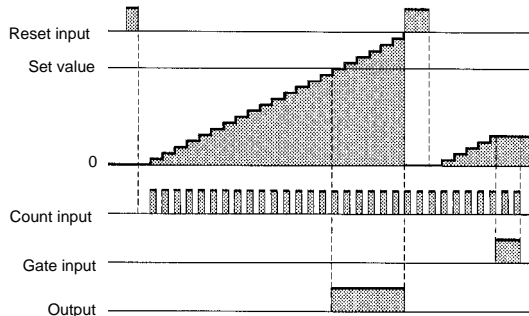

Down (Decrement) Mode

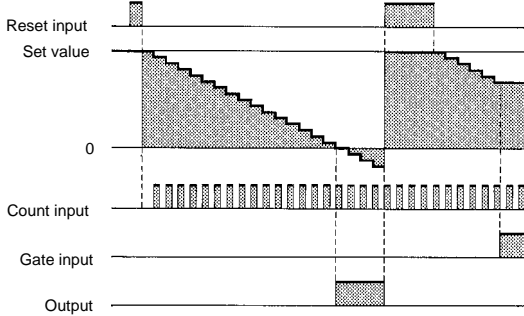

C Mode

Auto-reset, one-shot output is ON.

Up (Increment) Mode

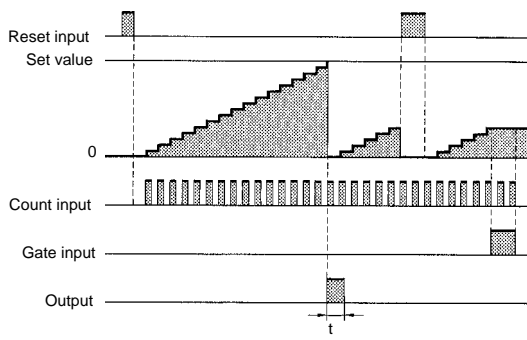

Down (Decrement) Mode

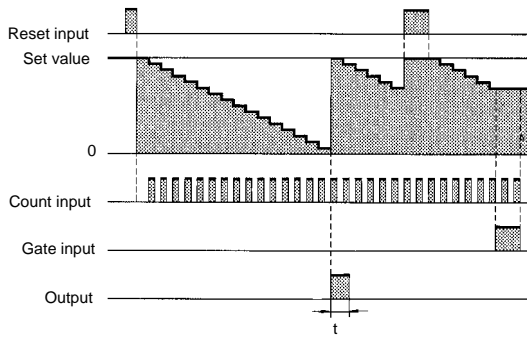

K Mode

Over-count, one-shot output is ON.

Up (Increment) Mode

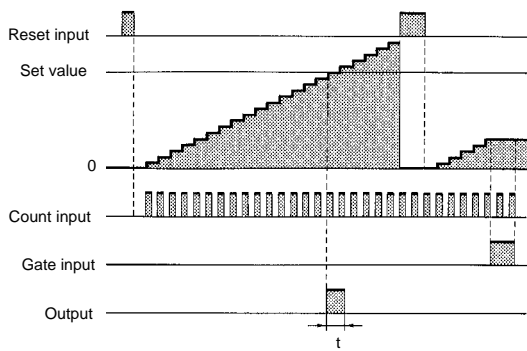

Down (Decrement) Mode

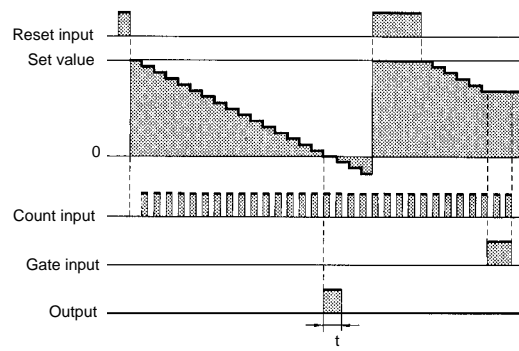

Note: t = one-shot time; 500 ms or 50 ms

Dimensions

Note: All units are in millimeters unless otherwise indicated.

H7CL-A□

DIN Track/Surface/Flush Mounting

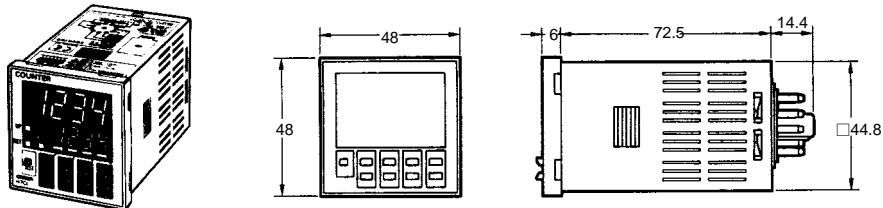

H7CL-AD□

Flush Mounting

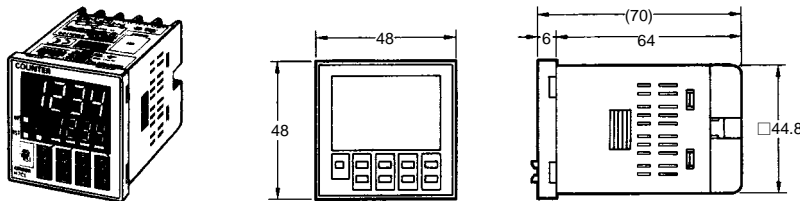

H7CL-A□

With Flush Mounting Adaptor

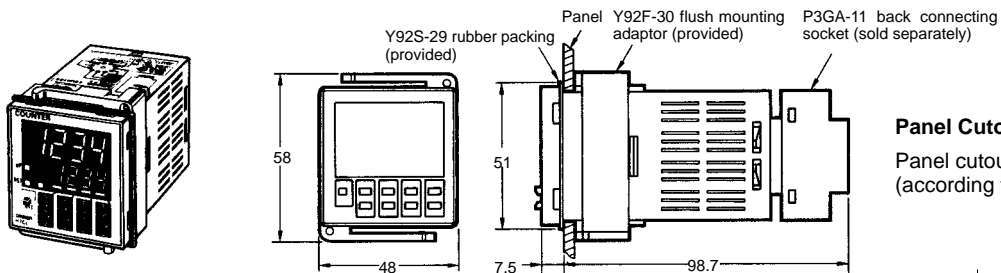

Panel Cutouts

Panel cutouts are as shown below. (according to DIN43700).

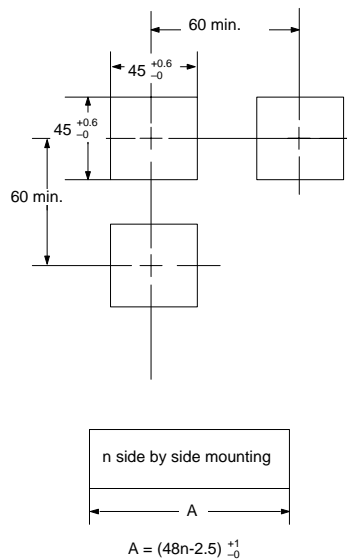

H7CL-AD□

With Flush Mounting Adaptor

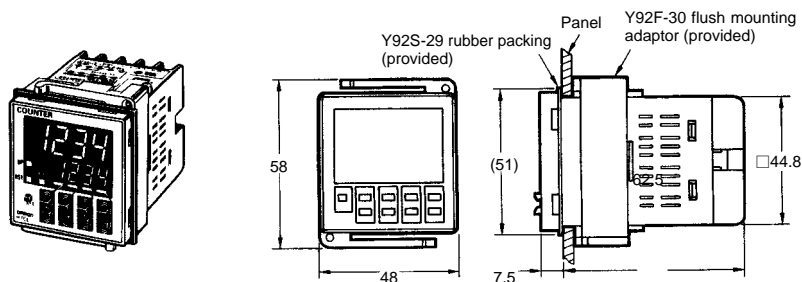

- Note 1. The mounting panel thickness should be 1 to 4 mm.
- 2. It is possible to mount Counters side by side, but only horizontally.

H7CL-AD□-500

The cover conforms to finger protection standard against electric shock. (VDE 0106/P100)

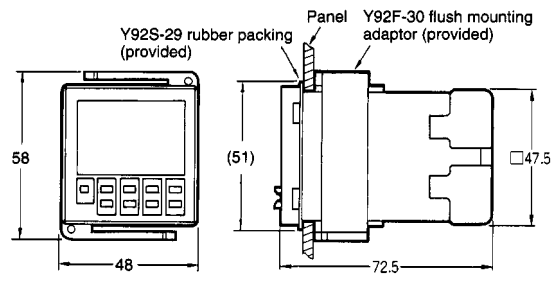

Installation

Terminal Arrangement

AC Models

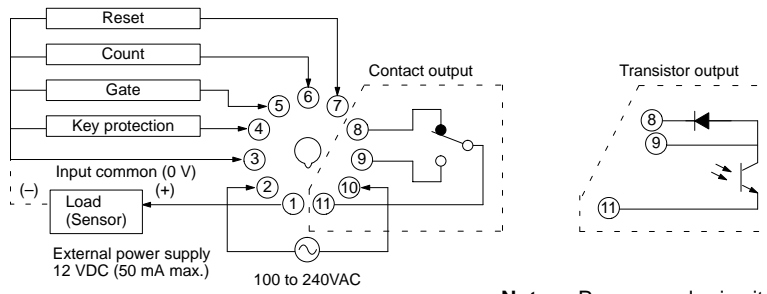

DC Models

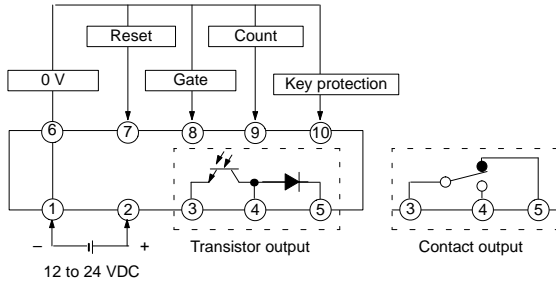

Note: Power supply circuit is insulated from the internal circuit (or I/O).

Note: 1 and 6 are connected to each other internally.

Input Circuitry

Count, Reset, and Gate Input

H7CL-A□ (AC Models)

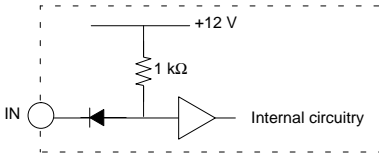

H7CL-AD□ (DC Models)

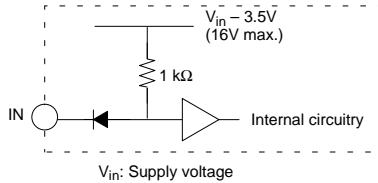

Key Protection Input

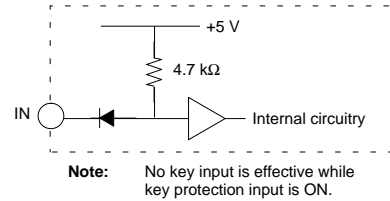

Note: No key input is effective while key protection input is ON.

Input Connections

Open Collector Output

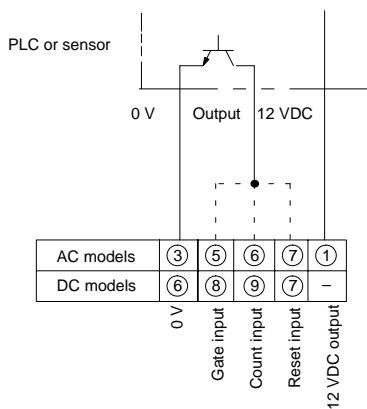

Voltage Output

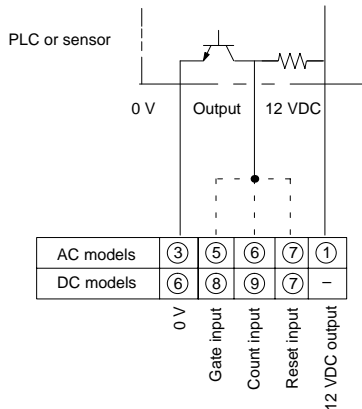

Contact input

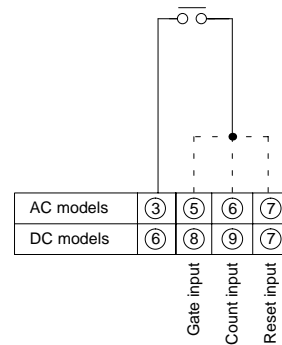

Count, Reset, and Gate Input Specification

- ON impedance: 500Ω max. (the leakage current is 5 to 20 mA when the impedance is 0Ω.)
- ON residual voltage: 2 V max.
- OFF impedance: 100kΩ min.
- Maximum applied voltage: 30 VDC max.

Two-wire Sensor

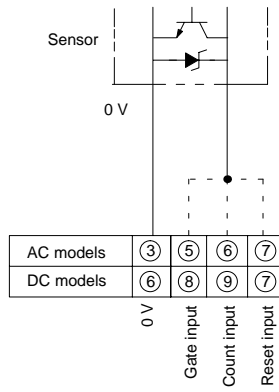

Applicable Two-wire Sensor

- Leakage current: 1.5 mA max.
- Switching capacity: 5 mA min.
- Residual voltage: 3 V max.
- Operating voltage: 10 VDC

Note: When connecting a two-wire sensor to a DC models, supply 24 VDC (21.6 to 26.4 VDC) to the Counter.

Key Protection Input

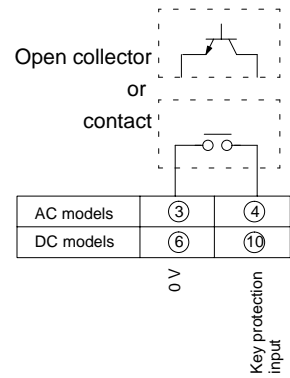

Key Protection Input

- ON impedance: 1 kΩ max.
(the leakage current is approx. 1 mA when the impedance is 0Ω.)
- ON residual voltage: 0.5 V max.
- OFF impedance: 100 kΩ min.
- Maximum applied voltage: 30 VDC max.

Note: The used contact should switch 1 mA at 5 V.

Precautions

Power Supplies

When turning the power ON and OFF, input signal reception is possible, unstable, or impossible as shown in the diagram below.

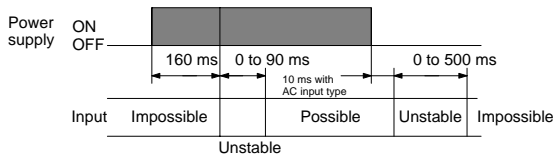

Apply the power supply voltage through a relay or switch in such a way that the voltage reaches a fixed value immediately.

Turn the power ON and OFF with relay with a rated capacity of 10 A minimum to prevent contact deterioration due to inrush current caused by turning the power ON and OFF.

Transistor Output

The transistor output of the H7CL is insulated from the internal circuitry by a photocoupler, so the transistor output can be used as both NPN and PNP output.

AC Models

NPN Output

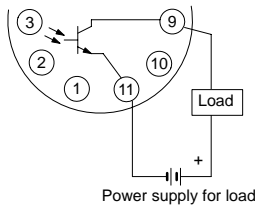

PNP Output

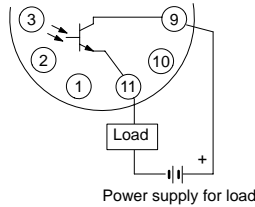

DC Models

NPN Output

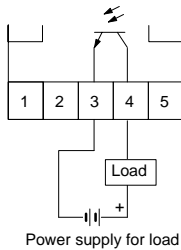

PNP Output

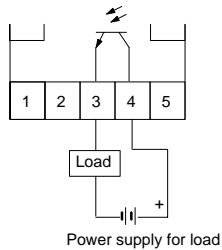

Self-diagnostic Function

The following displays will appear if an error occurs.

Display	Error	Output status	Correction	Set value after correction
0000	Present value underflow (see note)	No change	Press RST Key or reset input	No change
E1	CPU	OFF	Press RST Key or turn power off and then ON	0
E2	Memory			

Note: Given when present value falls below the minimum value (-999) in Down (decrement) Mode.

Operating Environment

When using the Counter in an area with excess electronic noise, separate the Counter, wiring, and the equipment which generates the input signals as far as possible from the noise sources. It is also recommended to shield the input signal wiring to prevent electronic interference.

Organic solvents (such as paint thinner), as well as very acidic or basic solutions can damage the outer casing of the Counter.

Set Value Change

If the user changes the set value while the Counter is operating, the user should be aware that the H7CL's output will be ON when the set value is the same as the present value.

Reset with a Set Value of 0

When the set value is 0, after the Counter is reset, the output is ON (while reset, output is OFF).

Reset Time

It takes 1 ms or 20 ms (selectable) to turn the output OFF with the following deflection ranges.

Time required for resetting	Deflection range
1 ms	0.8 to 1.2 ms (Reference value)
20 ms	15 to 25 ms (Reference value)

Output Delay

The following table shows the delay from when the present value passes the set value until the output is produced.

Actual measurements in N and K modes.

Control output	Max. counting speed	Output delay*
Contact output	30 cps	16.5 to 24.0 ms
	5 kcps	3.7 to 5.6 ms
Transistor output	30 cps	12.0 to 20.0 ms
	5 kcps	0.2 to 0.55 ms

*The variation in delays is due to different modes and conditions.

Flush Mounting

The H7CL's panel surface is water-resistant (conforming to NEMA 4 (indoors) and IP66). In order to prevent the internal circuit from water penetration through the space between the Counter and operating panel, attach a rubber packing (provided with the H7CL) between the Counter and operating panel and secure the rubber packing with the Y92F-30 flush-mounting adaptor.

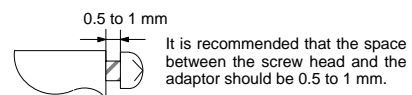

Other

In case of performing a dielectric strength test, etc., on the H7CL mounted to a control panel, disconnect the H7CL from the connecting circuitry, or short-circuit all the terminals of the H7CL. Otherwise the H7CL may be damaged.

Terminal 1 (power supply terminal) and terminal 6 (input common: 0 V for input) of DC model H7CL are internally connected to each other.

ALL DIMENSIONS SHOWN ARE IN MILLIMETERS.

To convert millimeters into inches, multiply by 0.03937. To convert grams into ounces, multiply by 0.03527.

Cat. No. L081-E1-1C **In the interest of product improvement, specifications are subject to change without notice.**

OMRON Corporation

Industrial Automation Company

Measuring and Supervisory Controls Division
28th Fl., Crystal Tower Bldg.,
1-2-27, Shiromi, Chuo-ku,
Osaka 540-6028 Japan
Phone: (81)6-6949-6035 Fax: (81)6-6949-6069

Printed in Japan
0499-0.5C (0393)